



INSTRUCTION MANUAL

VWM-800

Video Cassette Recorder

English





Only cassettes marked **VHS** can be used with this video cassette recorder.



As an ENERGY STAR® Partner, SANYO has determined that this product or product model meets the ENERGY STAR® guidelines for energy efficiency.

Please read this manual carefully before connecting your VCR and operating it for the first time. Keep the manual in a safe place for future reference.

	CAUTION RISK OF ELECTRIC SHOCK DO NOT OPEN	
CAUTION : TO REDUCE THE RISK OF ELECTRIC SHOCK, DO NOT REMOVE COVER (OR BACK); NO USER-SERVICEABLE PARTS INSIDE REFER SERVICING TO QUALIFIED SERVICE PERSONNEL.		



This lightning flash with arrowhead symbol within an equilateral triangle is intended to alert the user to the presence of uninsulated dangerous voltage within the product's enclosure that may be of sufficient magnitude to constitute a risk of electric shock to persons.



The exclamation point within an equilateral triangle is intended to alert the user to the presence of important operating and maintenance (servicing) instructions in the literature accompanying the product.

WARNING :
TO REDUCE THE RISK OF FIRE OR ELECTRIC SHOCK, DO NOT EXPOSE THIS PRODUCT TO RAIN OR MOISTURE.

CAUTION : TO PREVENT ELECTRIC SHOCK, DO NOT USE THIS PLUG WITH AN EXTENSION CORD, RECEPTACLE OR OTHER OUTLET UNLESS THE PLUG CAN BE FULLY INSERTED WITHOUT EXPOSING ANY PARTS OF THE BLADES.

WARNING : Do not drop the tying band of the power cord into the unit. Doing so might cause a fire or an electrical shock. (See page 4.)

IMPORTANT COPYRIGHT INFORMATION : Many television programs and films are copyrighted. In certain circumstances, copyright law may apply to private in-home video taping of copyrighted materials.

FCC WARNING: This equipment may generate or use radio frequency energy. Changes or modifications to this equipment may cause harmful interference unless the modifications are expressly approved in the instruction manual. The user could lose the authority to operate this equipment if an unauthorized change or modification is made.

REGULATORY INFORMATION: FCC Part 15

This product has been tested and found to comply with the limits for a Class B digital device, pursuant to Part 15 of the FCC Rules. These limits are designed to provide reasonable protection against harmful interference when the product is operated in a residential installation. This product generates, uses, and can radiate radio frequency energy and, if not installed and used in accordance with the instruction manual, may cause harmful interference to radio communications. However, there is no guarantee that interference will not occur in a particular installation. If this product does cause harmful interference to radio or television reception, which can be determined by turning the product off and on, the user is encouraged to try to correct the interference by one or more of the following measures:

- Reorient or relocate the receiving antenna.
- Increase the separation between the product and receiver.
- Connect the product into an outlet on a circuit different from that to which the receiver is connected.
- Consult the dealer or an experienced radio/TV technician for help.

Note to CATV system installer (USA only): This reminder is provided to call the CATV system installer's attention to Section 820-40 of the NEC which provides guidelines for proper grounding and, in particular, specifies that the cable ground shall be connected to the grounding system of the building, as close to the point of cable entry as practical.

MOISTURE CONDENSATION

If you pour a cold liquid into a glass, water vapor in the air will condense on the surface of the glass. This is moisture condensation. Moisture condensation on the head drum, one of the most crucial parts of the unit, will cause damage to the tape. When the VCR is exposed to a rapid temperature change from cold to warm, some condensation will occur. Under this condition, connect the power cord to the AC line, press **POWER** on and allow at least two hours for the VCR to dry out.

The serial number is found on the back of this unit. This number is unique to this unit and not available to others. You should record requested information here and retain this guide as a permanent record of your purchase.

Model No. _____ VWM-800 _____

Serial No. _____

IMPORTANT SAFETY INSTRUCTIONS

CAUTION: PLEASE READ AND OBSERVE ALL WARNINGS AND INSTRUCTIONS IN THIS OWNER'S MANUAL. AND THOSE MARKED ON THE PRODUCT. RETAIN THIS BOOKLET FOR FUTURE REFERENCE.

This product has been designed and manufactured to assure personal safety. Improper use can result in electric shock or fire hazard. The safeguards incorporated in this product will protect you if you observe the following procedures for installation, use, and servicing.

This product does not contain any parts that can be repaired by the user.

DO NOT REMOVE THE CABINET COVER, OR YOU MAY BE EXPOSED TO DANGEROUS VOLTAGE. REFER SERVICING TO QUALIFIED SERVICE PERSONNEL ONLY.

- 1. Read these instructions.** - All these safety and operating instructions should be read before the product is operated.
- 2. Keep these instructions.** - The safety, operating and use instructions should be retained for future reference.
- 3. Heed all warnings.** - All warnings on the product and in the operating instructions should be adhered to.
- 4. Follow all instructions.** - All operating and use instructions should be followed.
- 5. Do not use this product near water.** - For example: near a bath tub, wash bowl, kitchen sink, laundry tub, in a wet basement; or near a swimming pool; and other areas located near water.
- 6. Clean only with dry cloth.** - Unplug this product from the wall outlet before cleaning. Do not use liquid cleaners.
- 7. Do not block any ventilation openings. Install in accordance with the manufacturer's instructions.** - Slots and openings in the cabinet are provided for ventilation and to ensure reliable operation of the product and to protect it from over-heating. The openings should never be blocked by placing the product on a bed, sofa, rug or other similar surface. This product should not be placed in a built-in installation such as a bookcase or rack unless proper ventilation is provided or the manufacturer's instructions have been adhered to.
- 8. Do not install near any heat sources such as radiators, heat registers, stoves, or other apparatus (including amplifiers) that produce heat.**
- 9. Do not defeat the safety purpose of the polarized or grounding-type plug.** A polarized plug has two blades with one wider than the other. A grounding type plug has two blades and a third grounding prong. The wide blade or the third prong are provided for your safety. If the provided plug does not fit into your outlet, consult an electrician for replacement of the obsolete outlet.
- 10. Protect the power cord from being walked on or pinched particularly at plugs, convenience receptacles, and the point where they exit from the product.**
- 11. Only use attachments/accessories specified by the manufacturer.**



- 12. Use only with the cart, stand, tripod, bracket, or table specified by the manufacturer, or sold with apparatus. When a cart is used, use caution when moving the cart/product combination to avoid injury from tip-over.**
- 13. Unplug this product during lightning storms or when unused for long periods of time.**
- 14. Refer all servicing to qualified service personnel. Servicing is required when the product has been damaged in any way, such as power-supply cord or plug is damaged, liquid has been spilled or objects have fallen into the product, the product has been exposed to rain or moisture, does not operate normally, or has been dropped.**

CONTROL NAMES AND LOCATIONS

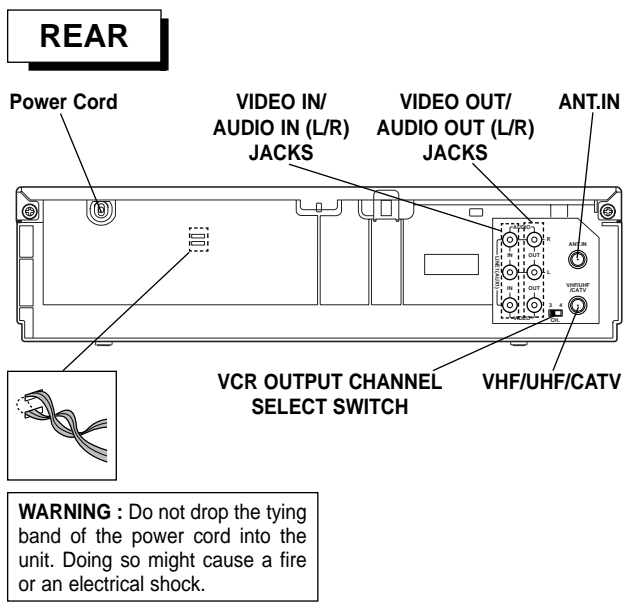
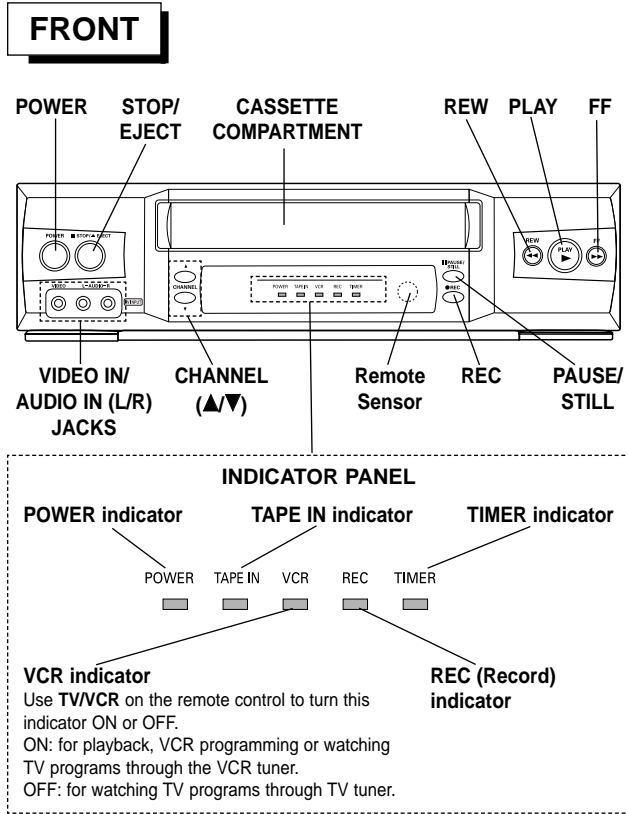

REMOTE CONTROL

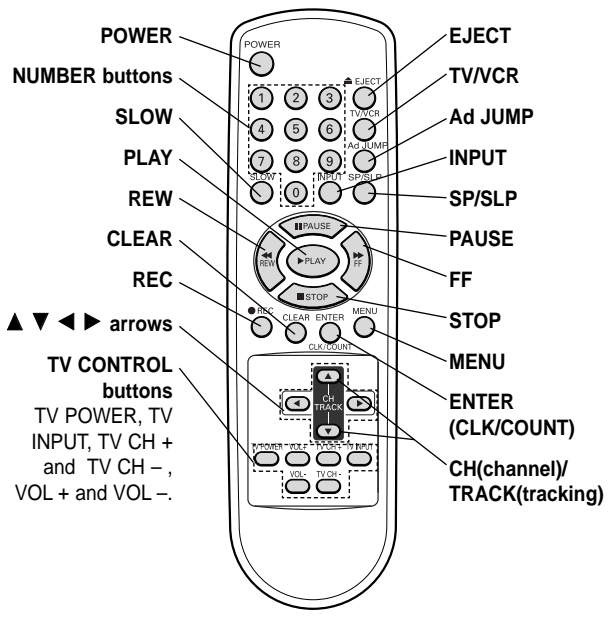

OPERATION OF REMOTE CONTROL

Aim the remote control unit at the sensor on the front panel of the VCR.

HOW TO INSTALL THE BATTERIES

- Slide the battery compartment cover in the direction of arrow.
- Insert 2 "AA"-size batteries in the correct direction.
- Replace the cover.

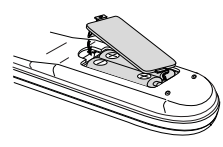

NOTES

- The remote control will not operate properly if something comes between the VCR and the remote control.
- If the range is short, try new batteries.
- An object between the VCR and remote control unit may block the invisible light beam and operation will be impossible.
- Batteries installed backwards may leak and damage your Remote Control.
- Do not mix old and new batteries or carbon types with alkaline types.
- Remove the batteries from the battery compartment if the remote control will not be used for a long time.

IMPORTANT NOTE:
SPENT OR DISCHARGED BATTERIES MUST BE RECYCLED OR DISPOSED OF IN A SAFE MANNER IN COMPLIANCE WITH ALL APPLICABLE LAWS. FOR DETAILED INFORMATION, CONTACT YOUR LOCAL COUNTY SOLID WASTE AUTHORITY.

INSTALLATION

Placing your VCR on the top of or under the TV receiver may result in interference appearing on the TV screen when the VCR is on. If this occurs, move the VCR to a position alongside the TV receiver.

VCR TO TV CONNECTION

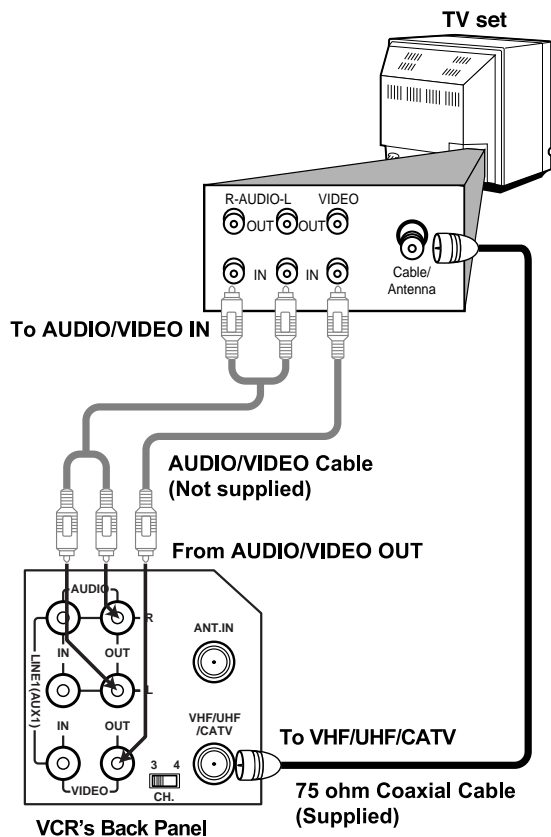

When using the RF coaxial cable (Supplied)

Connect the 75-ohm Coaxial Cable to VHF/UHF/CATV on the VCR. Connect the other end to the 75-ohm antenna input on back of the TV.

When using the Audio/Video cable (Not supplied)

If your TV has A/V input jacks, you may connect your VCR's AUDIO/VIDEO jacks on back of your TV. Direct audio/video connections usually result in a better picture and sound quality for tape playback. Please see your TV's owner's manual for details. Then set your TV to the VIDEO mode using the **TV/VIDEO** button on your TV.

VCR Output Channel Setting

During playback of a video tape, and when press **TV/VCR** to set the VCR mode, the VCR OUTPUT converter changes the video and audio signals to the same type of signals that are used for TV broadcasts. Set the VCR OUTPUT channel switch (marked CH3, CH4 and located on the rear panel) to channel 3 or 4. Select the channel that is not used for TV broadcasts in your area. This is your VCR OUTPUT channel. To play a tape, or to watch TV using the VCR's built-in tuner, always set your TV's channel selector to the same channel (3 or 4).

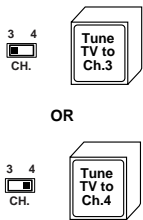

ANTENNA TO VCR CONNECTIONS

- 1 Disconnect the antenna leads from the rear of the TV receiver.
- 2 Identify the type of cable from your antenna. If it is a round cable as illustrated, it is a 75 ohm coaxial antenna cable. This cable will connect directly to the connector marked ANT.IN on your VCR.
If your antenna lead wire is a flat type antenna cable, connect it to a Antenna Adaptor (300-ohm to 75-ohm) (not supplied) and slip the Adaptor onto the ANT.IN connector. The Adaptor does not screw on to the VCR, it just slips over the connector.

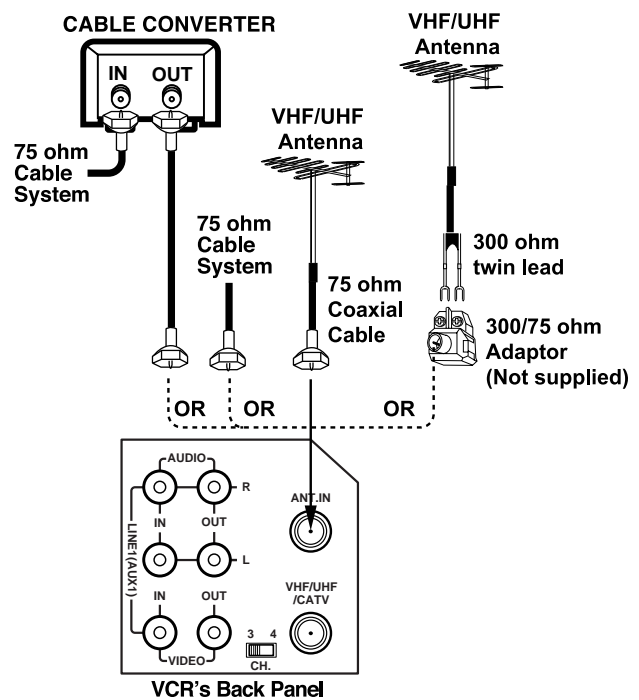

Without Cable Box

If your cable wire is connected to your TV without a converter or descrambler box, unscrew the wire from your TV and attach it to the ANT.IN connector on the VCR. Use the supplied round coaxial cable to connect between the VCR's VHF/UHF/CATV connector and the 75 ohm antenna input connector on the TV. With this connection, you can receive all midband, super band, and hyperband channels.

With Cable Box

If a converter is required in your cable system, follow the instruction below:

The cable hookup permits both TV and VCR operation.

To view or record CATV channel

- 1 Set the TV channel to the video output channel as located on the back of the VCR (CH3 or CH4).
- 2 Set the VCR channel selector to the output channel of the Cable Converter box by pressing the **CH/TRACK** (▲/▼) or number (0-9) of your VCR. (Example: CH3)
- 3 Select the channel to view at the Cable Converter Box.

NOTES

- With this connection, you CANNOT record one program while viewing another.
- Channel memory programming is not needed when using the connection.

ONSCREEN DISPLAY (OSD)

Some of these functions will be displayed every time the VCR is operated.

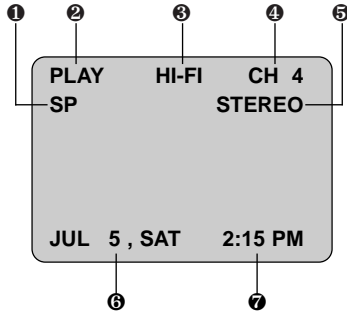

1 TAPE SPEED DISPLAY

Shows the current tape speed.

2 FUNCTION DISPLAY

Indicates the function in progress.

3 HI-FI DISPLAY

Indicates when this unit are playing back tape recorded with HI-FI.

4 CHANNEL DISPLAY

Indicates the selected channel (or LINE1, LINE2).

5 STEREO/SAP DISPLAY (MONO is not displayed)

Shows the type of audio signal received by the VCR tuner.

6 DATE DISPLAY

Shows the current date. (Month/Day/Day of the week format)

7 CLOCK/COUNT/REMAIN DISPLAY

Shows the current time, the tape counter and remaining time on the tape.

Each press of the **ENTER** changes the TV screen in the following sequence.

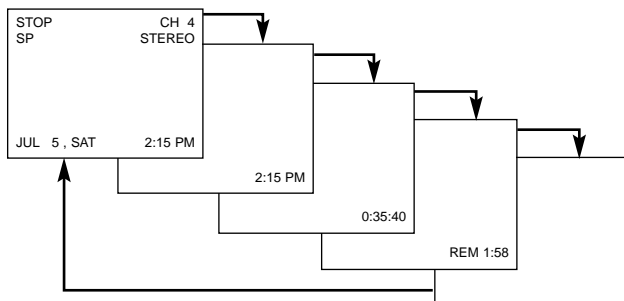

NOTES

- The function displays can be seen displayed on the TV screen for 5 seconds.
- The clock (or tape counter, tape remaining) mode will continue until you press **ENTER**.
- The tape counter and the remaining tape length indicator appear only when a cassette is inserted. Also, the remaining tape length indicator appears after any tape operation.

EASY INFORMATION

If the Extended Data Service (XDS) signals are provided along with normal TV signal in your area or during playback of a tape recorded with Extended Data Service (XDS) signals, the station ID, program title and program details are shown in the TV screen.

When viewing a channel with Extended Data Service (XDS) signals, press **ENTER** then the station ID will appear on the TV screen. Press **ENTER** again and the program details will appear on the TV screen.

When viewing a tape recorded with Extended Data Service (XDS) signals, press **ENTER** twice then the program title and program details will appear on the TV screen.

PROGRAM DETAILS

LENGTH: Indicates the run length of a program.

TIME REMAINING: Indicates the remaining time of a program.

RATING: Indicates the rating of the current program (N/A, G, PG, PG-13, R, NC-17, X and Not Rated). The rating N/A means that the motion picture ratings are not applicable to this program.

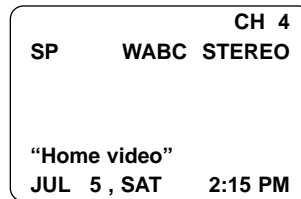

Easy Information Screen
(Station ID)

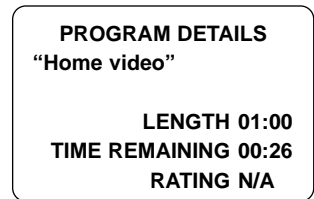

Easy Information Screen
(Program details)

SETTING THE ONSCREEN DISPLAY

The **SETUP**, clock setting, and timer recordings are accessed conveniently with Onscreen Menu Displays that lead you through each step. The following pages describe the Onscreen selections to be set.

MENU SELECTION

Your VCR allows remote control adjustment of several features.

- 1 Press **MENU** and the MAIN menu will appear.
- 2 Select the desired menu with the **▲** or **▼** button and then press **ENTER**.

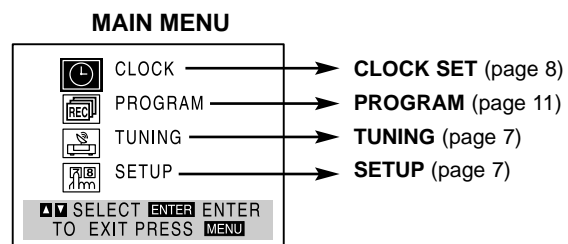

NOTE

- The onscreens can be seen displayed for 3 minutes.

SETTING THE SETUP MENU

- 1 Press **MENU** and the MAIN menu will appear.
- 2 Press **▲** or **▼** to select the SETUP menu, then press **ENTER**. The SETUP menu will appear.

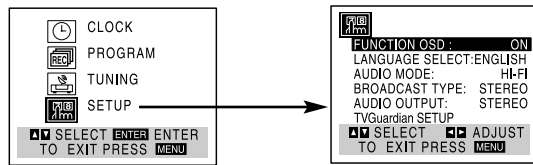

- 3 Press **▲** or **▼** to choose a desired item on the SETUP menu. Then press **◀** or **▶** to choose a desired setting.

FUNCTION OSD

The onscreen display of this VCR can be turned on or off.

- The FUNCTION OSD is switched between ON and OFF by pressing **◀** or **▶**.

LANGUAGE SELECT

The onscreen programming of this VCR can display in either English, Spanish, or French.

- The LANGUAGE SELECT is switched among ENGLISH, SPANISH and FRENCH by pressing **◀** or **▶**.

AUDIO MODE DISPLAY

The VCR has two separate audio playback systems, the high quality VHS Hi-Fi system and standard NORMAL mono system. The same audio is generally recorded on both systems. The VHS Hi-Fi system plays on separate (left and right) channels, and the NORMAL system plays monaural sound. The normal track is always played so the cassette can be played on a VCR that does not have VHS Hi-Fi.

- The AUDIO MODE is switched between HI-FI and NORMAL by pressing **◀** or **▶**.

BROADCAST TYPE DISPLAY (STEREO/SAP/MONO)

Multichannel Television Sound (MTS) carries stereo and/or Second Audio Program (SAP) bilingual signals. Set this display to the desired position when both MTS stereo and SAP signals are received. When only one of the MTS signal is received, the VCR automatically selects the corresponding receiving mode (Stereo or SAP) regardless of the selected position.

For normal operation, the display should be in the STEREO position. The VCR will then record a STEREO program when available, and record a mono program IF the program NOT IN STEREO.

For weak STEREO and/or SAP broadcasting, changing the display to mono may give clearer sound.

- The BROADCAST TYPE is switched among STEREO, SAP, and MONO by pressing **◀** or **▶**.

AUDIO OUTPUT DISPLAY (STEREO/LEFT/RIGHT)

Used during playback [when AUDIO MODE display (HI-FI/NORMAL) is in HI-FI position] for selecting the audio output signals from the AUDIO OUT terminals (L ch and R ch), and VHF/UHF/CATV. This display setting should normally be left in the stereo position, so that when a stereo tape is played, the stereo sound will be heard through the left and right channels. If a mono tape is played and the audio output is set to stereo, the same mono sound will be heard from both left and right channels.

- The AUDIO OUTPUT is switched among STEREO, LEFT, and RIGHT by pressing **◀** or **▶**.

TV GUARDIAN SETUP

Details are on the 9 page.

CHANNEL SELECTION

This VCR is equipped with a frequency synthesized tuner capable of receiving up to 181 channels. These include VHF channels 2-13, UHF channels 14-69 and CATV channels 1-125.

PREPARATION

- Connect the VCR to the desired type of antenna or cable TV system, as shown in ANTENNA TO VCR CONNECTIONS.

AUTO CHANNEL PROGRAMMING

- 1 Press **MENU** and the MAIN menu will appear.
- 2 Press **▲** or **▼** to select the TUNING menu, then press **ENTER**. The TUNING menu will appear.

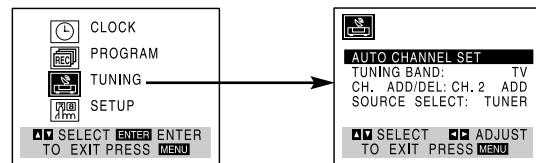

- 3 Press **▼** to choose the SOURCE SELECT item, then press **◀** or **▶** to select TUNER.
 - Press **◀** or **▶** repeatedly to switch among TUNER, LINE1 and LINE2.
- 4 Press **▲** or **▼** to choose the AUTO CHANNEL SET item, then press **◀** or **▶** to set the channel.
 - The tuner will automatically cycle through all available channels in the area and place them in the tuner's memory.
- 5 After the AUTO CHANNEL SET PROCEEDING is complete, make sure the TUNING BAND is set appropriately (TV or CATV) by pressing **▲** or **▼** and choosing the correct TUNING BAND (TV or CATV) by pressing **◀** or **▶** using the TUNING menu.
 - Remember, TV is for the air antenna reception, CATV is for cable or wireless cable connection.
- 6 Press **MENU** to return to the TV screen.

Use **CH/TRACK (▲/▼)** or **CHANNEL (▲/▼)** on the front panel to cycle the VCR through the channels in memory.

TO ADD OR ERASE CHANNELS FROM MEMORY

This feature allows you to add or erase channels from memory manually.

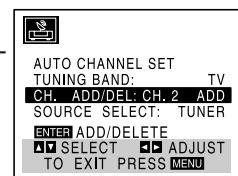

- 1 Press **▼** to choose the CH. ADD/DEL item on the TUNING menu. Press **◀** or **▶** to select a channel to add or erase.
- 2 Press **ENTER** to add or erase the channel. Repeat steps 1 and 2 to add or erase channels.
- 3 Press **MENU** to return to the TV screen.

SETTING THE CLOCK

The VCR gives you two ways to set the time and date: the Auto Clock Feature or manually. The Auto Clock Feature enables the VCR to set up the clock when the VCR is turned off.

Things to know before starting

- The clock uses the 12-hour system. (Be sure to set AM and PM correctly.)
- The initial Clock Setting is **JANUARY 1, 2003, 12:00 AM**.

AUTO CLOCK SET

- 1 Press **MENU** and the MAIN menu will appear.
- 2 Press **▲** or **▼** to choose the **CLOCK** menu. Press **ENTER** and the **CLOCK** menu will appear.

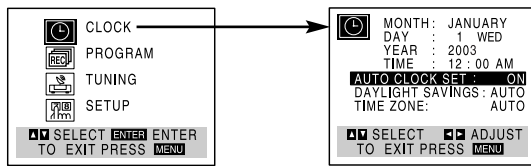

- 3 Press **▼** to choose the **AUTO CLOCK SET** item. Press **◀** or **▶** to choose **ON**.
The Auto Clock Set feature is set to ON at the factory. In the ON setting, the VCR looks for a channel carrying XDS (Extended Data Services) information. XDS updates the clock using the Coordinated Universal Time.
- 4 Press **▼** to choose the **DAYLIGHT SAVINGS** item. Press **◀** or **▶** to choose **AUTO, ON** or **OFF**.
If you choose **AUTO**, the VCR sets the clock using the DST information broadcast in the signal (channel).
If you choose **ON**, the VCR sets the clock when the Daylight Saving Time is started and ended.
- 5 Press **▼** to choose the **TIME ZONE** item. Press **◀** or **▶** to choose the correct time zone (**AUTO, EASTERN, CENTRAL, MOUNTAIN, PACIFIC, ALASKA** or **HAWAII**).
If "AUTO" is selected as the time zone, the VCR sets the clock using the first Coordinated Universal Time information it finds in a broadcast signal.
- 6 Press **MENU** when finished.
- 7 Turn off the VCR and the auto clock setting works.

NOTE

There are cases that TV station does not send or send wrong date and/or time information and VCR set the incorrect time accordingly.
In this case we recommend that you set the clock manually.

MANUAL CLOCK SET

Example: July 5, 2003 ; 2:15 AM

- 1 Press **MENU** and the MAIN menu will appear.
- 2 Press **▲** or **▼** to choose the **CLOCK** menu. Press **ENTER** and the **CLOCK** menu will appear.

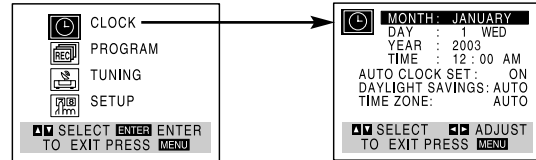

- 3 Press **◀** or **▶** to choose the month.
- 4 Press **▼** to choose the **DAY** item. Press **◀** or **▶** to choose the day.
The day of the week will display automatically.
- 5 Press **▼** to choose the **YEAR** item. Press **◀** or **▶** to choose the year.
- 6 Press **▼** to choose the **TIME** item. Press **◀** or **▶** to choose the time.
- 7 Press **▼** to choose the **DAYLIGHT SAVINGS** item. Press **◀** or **▶** to choose **AUTO, ON** or **OFF**.
If you choose **AUTO**, the VCR sets the clock using the DST information broadcast in the signal (channel).
If you choose **ON**, the VCR sets the clock when the Daylight Saving Time is started and ended.
- 8 Press **MENU** when finished.



NOTE

The "AUTO CLOCK SET" must set to "OFF".
If set to "ON", an incorrect date and/or time will be entered again when the VCR is turned off.

SETTING THE TVG® (TVGuardian®)

TVGuardian® Technology embedded into the VCR will filter foul language from pre-recorded movies which have CC (Closed Caption). Words detected by TVG® will be muted from the program audio channel, and a version of the phrase, with the foul language converted to a suitable replacement word, can be displayed on the TV screen. This is accomplished by a process which:

- reads the hidden signals for closed captions,
- detects offensive language,
- momentarily mutes the sound, and
- displays acceptable words and phrases.

- 1 Press **MENU** and the MAIN menu will appear.
- 2 Press **▲** or **▼** to select the SETUP menu, then press **ENTER**. The SETUP menu will appear.

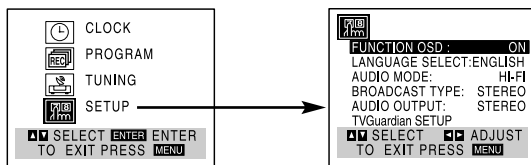

- 3 Press **▼** to choose the TV GUARDIAN SETUP item, then press **◀** or **▶** to display the TV GUARDIAN SETUP menu.



- 4 Press **▲** or **▼** to choose a desired item on the TV GUARDIAN SETUP menu. Then press **◀** or **▶** to choose a desired setting.

There are four settings which control the operation of TVG Technology.

TVG MODE

OFF: In the OFF mode, TVG will not operate. Your VCR will operate as normal.

TOLERANT: In the TOLERANT mode, only the most offensive foul language will be filtered.

MODERATE: In the MODERATE mode, more offensive words will be filtered.

STRICT: In the STRICT mode, all the foul language words known to the TVG process will be filtered.

TVG WORD SETS

In addition to the main TVG modes, three additional sets of words are available to the user to selectively turn on or off. ON means that the words belonging to the set will be filtered. OFF means that they will not be affected by the TVG processing.

NOTE

When the user changes from any TVG ON mode (TOLERANT, MODERATE or STRICT) to the OFF mode, all the word sets are turned OFF. Whenever you change from the TVG OFF mode to any TVG ON mode (TOLERANT, MODERATE or STRICT), all three of these word sets are changed to ON setting.

DAMN & HELL Word Set

This set includes variations of "Damn" and "Hell".

RELIGIOUS Word Set

This set includes numerous Religious words, such as God and Jesus. One might want to turn this Word Set to OFF if watching religious programming material.

SEXUAL REFERENCE Word Set

This set includes various sexually related words.

CC DISPLAY

When TVG MODE enables. (TOLERANT, MODERATE, STRICT)

The TVG processing allows the user the choice of three possible settings of CC Mode. By default, the TVG processing only displays captions to the user when foul language is detected. Other settings are described below.

ON MUTE (default): Whenever Foul Language is detected, captions are displayed with a suitable replacement word substituted for the foul language, and audio is muted for the foul language.

CONTINUOUS: You can see all captions, whether or not any foul language was detected. But like the ON MUTE mode, captions are displayed with a suitable replacement word substituted for the foul language, and audio is muted for the foul language.

OFF: You cannot see captions. Whenever Foul Language is detected, only audio is muted.

When TVG MODE disables. (OFF)

In case of "TVG MODE" set to "OFF", The TVG processing does not work. And allows the user the choice of only two possible settings of CC DISPLAY Mode.

OFF: The user may select to never see captions.

ON: The user may select to see captions.

NOTES

- When you use a TV with closed caption capability, set the Closed Caption to "OFF" on the TV.
- The Closed Caption does not appear while the on-screen displays.
- When playback starts, the TVG information may appear on the TV screen.

TVGuardian® and TVG® are registered trademarks of Principle Solutions, Inc.

NORMAL PLAYBACK

PREPARATION

- Turn on the TV.
- Be sure the TV is set to the VCR Output Channel (CH 3 or 4).
- If a direct VIDEO/AUDIO connection is made between the VCR and the TV, set the TV's source selector to VIDEO.

1 Insert a prerecorded video cassette.

The TAPE IN indicator will light and the VCR will power-up automatically.

- Make sure that the TIMER indicator in the VCR indicator panel is not lighted. If it is, press **POWER** once.
- If a tape without a safety tab is inserted the unit will start the playback automatically.

2 Press **PLAY** once.

The **PLAY** appears on the TV screen .

- It is not necessary to select the tape speed for playback. It will be automatically selected by the VCR.
- In playback, the **TV/VCR** selector switches to VCR mode automatically.

3 Press **STOP** to stop playback.

The **STOP** appears on the TV screen.

- If the tape reaches the end before **STOP** is pressed, the VCR will automatically stop, rewind, eject, and it will turn itself off.

TRACKING CONTROL

AUTO TRACKING

The automatic tracking function adjusts the picture to remove snow or streaks.

The AUTO TRACKING function works in the following cases:

- A tape is played back for the first time.
- Tape speed (SP, LP, SLP) changes.
- Streaks or snow appear because of scratches on the tape.

MANUAL TRACKING

If noise appears on the screen during playback, press either **CH/TRACK** (▲/▼) on the remote control or **CHANNEL** (▲/▼) on the front panel until the noise on the screen is reduced.

- In case of vertical jitter, adjust these controls very carefully.
- Tracking is automatically reset to normal when the tape is ejected or the power cord is unplugged for more than 3 seconds.

SPECIAL EFFECTS PLAYBACK

These special effects are available during playback.

VISUAL SEARCH FUNCTION

This function lets you quickly and visually search for a desired tape section in either direction: forward and reverse.

During **PLAYBACK** mode...

1 Press desired search button (**FF** or **REW**).

The VCR will be activated in the **SEARCH** mode.

- If the VCR is left in the **SEARCH** mode for more than 3 minutes, the VCR will automatically enter the **PLAYBACK** mode, to protect the tape and video heads.

2 To continue normal playback, press **PLAY**.

TO WATCH A STILL (or Frame Advance) PICTURE

During **PLAYBACK** mode...

1 Press **PAUSE** or **PAUSE/STILL** on the front panel.

Still picture will appear on the TV screen.

- If a still picture vibrates vertically, stabilize it by pressing **CH/TRACK** (▲/▼) on the remote control.

- If the VCR is left in the **STILL** mode for more than 5 minutes, the VCR will automatically enter the **STOP** mode to protect the tape and video heads.

2 Press **PAUSE** repeatedly to advance the video picture one frame at a time while viewing a still picture.

3 To continue normal playback, press **PLAY**.

USING THE SLOW MOTION FEATURE

During **PLAYBACK** mode...

1 Press **SLOW**.

The tape will be played back at a speed 1/19 times slower than the normal speed.

- During slow playback, **CH/TRACK** (▲/▼) on the Remote Control can be used to minimize noise bands.

- When the slow mode continues for more than 3 minutes, the VCR will automatically change to **PLAYBACK** mode.

2 Press **PLAY** to return to normal playback speed or press **STOP** to stop tape movement.

Ad JUMP (Advertisement Jump)

This is useful for skipping commercials or short program segments.

1 Press **Ad JUMP** during the **PLAYBACK** mode.

The tape will fast forward picture search through 30 seconds of recording.

The skipping time can be extended by pressing **Ad JUMP**. Subsequent presses result in advancing the fast forward picture search time by 30-second increments (maximum 3 minutes).

2 When the search is completed, the VCR will go into **PLAYBACK** mode automatically.

SPECIAL EFFECTS PLAYBACK NOTES:

- Horizontal lines (noise bars) will appear on the TV screen. This is normal.
- The audio is automatically muted during special effect modes, so there is no sound during search.
- During the high-speed picture search modes, a short period is needed to stabilize tape speed when re-entering the **PLAYBACK** mode. Slight interference may be observed during this period.

AUTO PLAY SYSTEM

This VCR features full automatic playback and rewind. Load a cassette (with the safety tab removed).

- The power turns on automatically and playback begins.
- At the end of the tape, the VCR stops, then rewinds.
- The cassette is ejected after rewinding and turn itself off automatically.

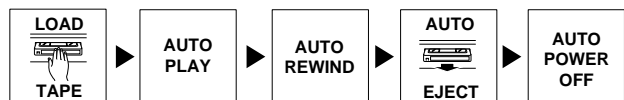

AUTO POWER SHUT-OFF FUNCTION

This feature is especially helpful when you finish watching a tape. Press **STOP**, **REW**, and **POWER**. The VCR will rewind the tape and turn itself off automatically.

1. Press **STOP** when you finish watching a tape.
2. Press **REW** to rewind the tape.
3. Press **POWER** during the REWIND mode, the VCR will enter the AUTO POWER SHUT-OFF mode.
4. The POWER indicator will flash on the VCR indicator panel.
5. After tape is rewound, VCR will turn off automatically.

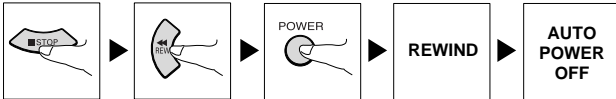

NORMAL RECORDING

PREPARATION

- Turn on the power of both the VCR and TV.
- Be sure the TV is set to the VCR Output Channel (CH 3 or 4).
- If a direct VIDEO/AUDIO connection is made between the VCR and the TV, set the TV's source selector to VIDEO.

- 1 Insert the video cassette that the safety tab is in place.
- 2 Select the desired channel by using **CH/TRACK** (▲/▼).
 - If you are recording from another source via audio/video input jacks (at the Rear or Front panel), select the LINE1 or LINE2 by pressing **INPUT**.
- 3 Set the desired speed (SP or SLP) by pressing **SP/SLP**.
 - This VCR is not designed to record in LP mode.
- 4 Set the MTS mode as desired (See page 7, 14).
- 5 Press **REC** once.
Recording will start. (The REC indicator will light on the VCR indicator panel)
 - If a cassette with no safety tab is loaded, the cassette will be ejected automatically.
- 6 Press **STOP** to stop recording.
 - If the tape reaches the end before **STOP** is pressed, the VCR will automatically stop, rewind, eject, and it will turn itself off.

To PAUSE the recording

During the RECORDING mode...

- 1 Press **PAUSE** or **PAUSE/STILL** on the front panel to pause the tape.
The REC indicator will flash on the VCR indicator panel.
- 2 When you want to continue recording, press **PAUSE** or **PAUSE/STILL** on the front panel again or press **REC**.
 - After 5 minutes in pause mode, the tape will be stopped automatically to protect the tape and the video heads.

To record one TV program while watching another

- 1 Press **TV/VCR** to select the TV mode during recording.
The VCR indicator disappears.
- 2 Using the TV, select the channel to be viewed.

Always use **PAUSE** for best results when making changes during recording.

For example: To change channels during recording, first press **PAUSE** to put the unit in pause mode. Then select the desired channel on the VCR, and press **PAUSE** again to resume recording.

TIMER RECORDING

This VCR can be programmed to record up to 8 programs within a period of 1 year. For unattended recording, the timer needs to know the channels to be recorded and the starting and ending times.

Things to know before starting

- If you try to set the program timer before setting the clock, PLEASE SET THE CLOCK appears for a moment and then CLOCK menu appears on the TV screen. Set the time and date before proceeding.
- Make sure a tape is in the VCR and the safety tab is in place or the tape will be automatically ejected.

PREPARATION

- Turn on the power of both the VCR and the TV.
- Be sure the TV is set to the VCR Output Channel (CH 3 or 4).
- Make sure the TUNING BAND in the TUNING menu is set appropriately (TV or CATV). (See "CHANNEL SELECTION", page 7.)

- 1 Press **MENU** and the MAIN menu will appear.
- 2 Press **▲** or **▼** to choose the PROGRAM menu.
- 3 Press **ENTER** to enter the PROGRAM menu.

The PROGRAM menu will appear.

- If all programs have already been entered, FULLY PROGRAMMED message will appear for a moment and then PROGRAM 1 will appear on the TV screen.

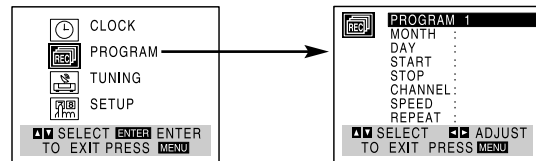

- 4 Press **◀** or **▶** to choose the PROGRAM No. (1-8).
- 5 Press **▼** to choose the MONTH item.
Press **◀** or **▶** to choose the desired month.
Example: JULY
- 6 Press **▼** to choose the DAY item.
Press **◀** or **▶** to choose the desired day.
Example: 6 SUN
- 7 Press **▼** to choose the START item.
Press **◀** or **▶** to choose the desired start time.
Example: 6:00 PM
- 8 Press **▼** to choose the STOP item.
Press **◀** or **▶** to choose the desired stop time.
Example: 7:30 PM
- 9 Press **▼** to choose the CHANNEL item.
Press **◀** or **▶** to choose the desired channel (Channel, LINE1 or LINE2).
Example: CH 4
Cable Users: If you have CABLE TV and used Cable Box in Antenna to VCR Connections (page 5), using a cable box converter, you must set the channel in this step to match the cable box output channel (usually CH 3 or 4). Change channels on the cable box instead of with the VCR.

10 Press **▼** to choose the SPEED item.

Press **◀** or **▶** to choose the desired tape speed (AUTO, SP or SLP).

Example: SP

- The AUTO mode determines how much tape is left and switches speed from SP to SLP, if necessary, to complete recording the program. There will be some picture and sound distortion at the point of the speed change.

11 Press **▼** to choose the REPEAT item.

Press **◀** or **▶** to choose the desired repeat (ONCE, WEEKLY, or DAILY).

Example: ONCE

ONCE event....for recording up to 8 programs on a single day or over the days within a period of 1 year.

WEEKLY event....for recording up to 8 programs on a certain day of every week.

DAILY event....for recording up to 8 programs at the same time(s) Monday through Friday.

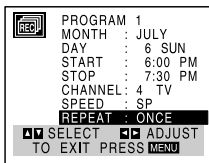

If the input data is wrong, press **▲** to select the data and correct it by pressing **◀** or **▶**.

12 Press **MENU**, the program will be memorized at the VCR.

- If the program preset time is past, the PAST TIME PROGRAMMED message will appear on the TV screen. Return to the incorrect program and program it with the correct time.
- If you had entered a past date, the timer recording will be performed on that date of the next year.
- Additional programs may be entered by repeating steps 1-12.

Cable Users: If your cable hookup is via a TV converter box, you can program multiple recordings only on the converter box output channel. This is because the converter determines what channel you view through your VCR.

If you are finished programming and you want to set the VCR to record the programs you have entered. **A) MAKE SURE YOU HAVE INSERTED A TAPE INTO THE VCR. B) YOU MUST TURN OFF THE VCR BEFORE IT WILL RECORD ANY TIMER PROGRAMS. (TIMER indicator lights).** The VCR is now set to record the preset programs.

The VCR must be off for a timer recording to take place!

You can clear the timer recording by pressing **POWER** during timer recording.

CHECKING (ERASING) THE TIMER PROGRAM

Programming can be checked whenever the VCR is turned on.

- 1 Press **MENU** and the MAIN menu will appear.
- 2 Press **▲** or **▼** to choose the PROGRAM menu. Press **ENTER** and the PROGRAM menu will appear.

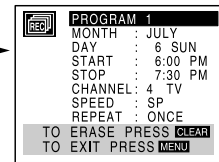
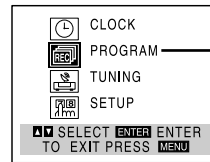

3 Press **◀** or **▶** to select a program you want to check or erase. If you want to erase the program, press **CLEAR**.

4 Press **MENU** to return to the TV screen.

PROGRAM PRIORITY

7:00 PM 8:00 PM 9:00 PM 10:00 PM

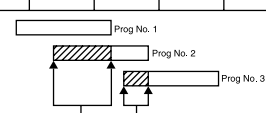

If the recording start and end times of preset programs overlap on the same day (see the example and diagram left), program number 2 will not be recorded until program number 1 is finished.

The first part of program number 2 will not be recorded. The same thing will happen to program number 3.

If the power fails or the VCR is unplugged from the AC outlet, the correct clock time and timer settings are kept in memory for approximately 3 seconds. After 3 seconds, the clock and program timer must be reset when power is restored. Reset time according to instructions.

INSTANT TIMER RECORDING

Instant Timer Recording allows you to make a recording easily of a preset length without using the program timer.

PREPARATION

- Turn on the power of both the VCR and the TV.
- Be sure the TV is set to the VCR Output Channel (CH 3 or 4).
- If a direct VIDEO/AUDIO connection is made between the VCR and the TV, set the TV's source selector to VIDEO.

1 Insert the video cassette that the safety tab is in place.
2 Select the desired channel by using **CH/TRACK (▲/▼)** or number **(0-9)**.

The channel number appears on the TV screen.

- If you are recording from another source via audio/video input jacks (at the Rear or Front panel), select the LINE1 or LINE2.

3 Set the TAPE SPEED item to desired speed (SP or SLP) by pressing **SP/SLP**. The tape speed will appear on the TV screen.

4 Press **REC** twice.

The menu as illustrated, will appear on the TV screen. Recording will start. (The TIMER indicator will light)

5 Press **REC** repeatedly to select the recording time length. At the end of the recording, the VCR will stop recording and shut off.

- During Instant Timer Recording, changing the channel on the VCR will not be possible.
- You can stop the recording by pressing **STOP**.

INSTANT TIMER RECORD MENU

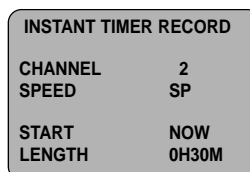

0H30M 9H00M → 0H00M

↑
Length Display
 (each pressing REC increases recording by 30 minutes)

CHECKING THE RECORDING TIME

Press **REC** once to check the recording time. The recalled setting will automatically return to the TV screen after 6 seconds.

TO EXTEND THE RECORDING TIME

The recording time can be extended anytime by pressing **REC**.

Subsequent presses result in advancing the recording time by 30-minute increments.

NOTES

- If you press **PAUSE** during instant timer recording, the VCR will enter the recording pause mode. Instant timer recording is cancelled.
- If the VCR is set to "0H00M", the VCR goes to normal recording mode.

DUBBING AND EDITING

If you wish to edit or dub your camcorder (or another VCR) recordings to this VCR, the rear (or Front) panel mounted Audio and Video (A/V) input jacks make the connections quick and easy. The direct A/V jacks will also provide better picture results than using the RF jack on the rear panel.

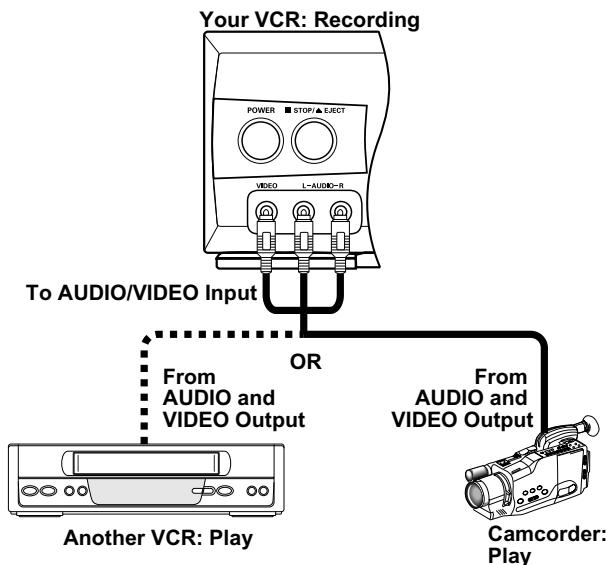

- 1 Connect the camcorder's (or another VCR's) A/V outputs to your VCR as illustrated above.
- 2 Set the input channel "LINE2". (press **INPUT** to select LINE2.)
 - If you have connected your VCR to the A/V input jacks on the rear of VCR, you should select the input channel LINE1 by pressing **INPUT** twice.
- 3 Play the tape in the camcorder (or another VCR). If you have a TV attached to your VCR, you can see the video playing.
- 4 When you desire recording to begin, press VCR's **REC** once to start.

NOTE

Before recording, please confirm the recording start position.

VHS Hi-Fi STEREO SYSTEM/ MTS BROADCAST

This VCR is equipped with the VHS Hi-Fi audio sound system for recording and playback. The information below gives a brief description of Hi-Fi audio and how to record and play a tape in the Hi-Fi audio mode.

To enjoy the Hi-Fi stereo system, you connect your VCR's AUDIO(R/L)/VIDEO OUT jacks to the AUDIO (R/L)/VIDEO INPUT jacks on back your TV (or another A/V system) using the A/V cable.

PLAYBACK WITH Hi-Fi STEREO AUDIO SOUND

A stereo TV with AUDIO/VIDEO input jacks or a stereo audio system is required for true stereo playback. To experience the full and rich stereo sound available with Hi-Fi recorded tapes, we recommend the connection of this unit to a home stereo audio system.

- 1 Set the AUDIO MODE item to HI-FI on the SETUP menu .



- 2 Set the AUDIO OUTPUT item to STEREO position.
 - (**STEREO**) POSITION: The left channel sound (L) is heard from the left speaker and the right channel sound (R) is heard from the right speaker.
 - (**LEFT**) POSITION: The left channel sound (L) is heard from both speakers.
 - (**RIGHT**) POSITION: The right channel sound (R) is heard from both speakers.



- 3 Press **MENU** when finished.
- 4 Insert a cassette and press **PLAY**.
Adjust volume at your stereo system.

MTS (Multi-Channel TV Sound)

This VCR will decode MTS stereo and bilingual (SAP) off-the-air broadcast sound signals. It also decodes stereo TV sound from local cable companies, as long as they operate on assigned cable frequencies and use the EIA-recommended MTS stereo/bilingual TV sound system.

MULTICHANNEL TV SOUND INDICATOR (MTS)

Shows Onscreen as illustrated below when **ENTER** is pressed.

- One or both of the indicators will light, depending on the MTS broadcast.

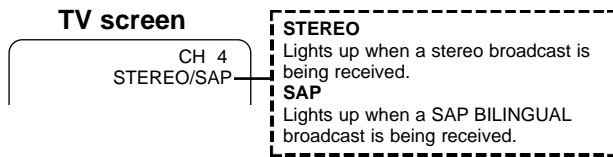

If only the STEREO appears on the TV screen.

The VCR can record in stereo onto the VHS Hi-Fi audio tracks when the BROADCAST TYPE item is in the STEREO position. The VCR will also record mono audio onto the mono audio track.

If only the SAP appears on the TV screen.

Select the BROADCAST TYPE item to SAP.

If both the STEREO/SAP appears on the TV screen

Use the BROADCAST TYPE item to select the desired recording mode (STEREO or SAP).

SAP (Second Audio Program) RECORDING

Some stations transmit a Second Audio Program, which is used for a second language or additional information. When the station broadcasts a Second Audio Program, follow the procedure below to record the SAP.

- 1 Insert a video cassette that the safety tab is in place.
- 2 Set the BROADCAST TYPE item to SAP (SETUP menu).
Do this if only the SAP appears on the TV screen or you know the program will use the SAP.

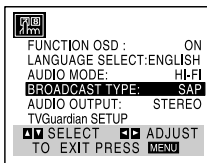

- 3 Press **MENU** when finished.
- 4 Set the desired speed (SP or SLP) by pressing **SP/SLP**.
- 5 Select the desired channel. The SAP should appear on the TV screen.
- 6 Press **REC** once.
You are now recording the program you see and hear on the TV.
- 7 Press **STOP** to stop recording.

TAPE COUNTER MEMORY FEATURE

REAL-TIME COUNTER

Shows length of tape run in hours, minutes, and seconds as illustrated below. Press **CLK/COUNT** to select the real-time counter display.

Every press of **CLK/COUNT** changes the TV screen as illustrated below.



- Counter changes to **0:00:00** when the cassette is ejected.
- The real-time counter does not operate when nothing is recorded on the tape.
- The real-time counter will not work when the tape is not inserted.

COUNTER MEMORY FUNCTION

This is useful if there is a section of tape you want to view immediately after recording or if you want to return to the same point several times.

- 1 Begin recording or playing a tape.
- 2 Press **CLK/COUNT** repeatedly to display the real-time counter appears on the TV screen.
- 3 At the point that you want locate later, reset the real-time counter to **0:00:00** by pressing **CLEAR**.
- 4 Continue to play or record.
- 5 Press **STOP** when recording or playback finishes.
- 6 Press **REW**.
The tape automatically stops when the tape counter returns to about "0:00:00".

TAPE REMAINING

This function allows the time of the remaining tape to be displayed during recording or playback. Press **CLK/COUNT** until the REM indicator displays on the TV screen during recording or playback.

NOTE

The remaining tape length indicator may not be displayed correctly depending on the condition of the tape and the kind of the tape (T-140, T-160, or T-210 etc)

EDITING A RECORDING

- 1 Press **PLAY** and watch the program until you reach the exact point where you want the new recording to start.
- 2 Press **PAUSE**.
- 3 Press **REC** once.
The program material to be recorded will appear on the television.
- 4 When you wish to start recording, press **PAUSE** again.
The new program material will directly follow the previously recorded material. This feature is especially helpful during camcorder-to-VCR dubbing use so each segment of the recording becomes a continuous program.

OPERATING HINTS

- In manual recording, Timer recording, Instant Timer Recording, playback, or fast forward modes, the VCR automatically starts rewinding the tape at the end of the tape. The cassette will stop at the beginning of the tape and be ejected, and the VCR will turn itself off.
- After you have finished using the VCR, rewind, eject, and remove the cassette. Place the cassette in its protective sleeve to protect it from dust. It is not necessary to rewind the cassette before removing it, but if you do, it will be ready to play or record the next time you use it.
- Be sure the VCR Channel Selector is on the correct channel you wish to record. The channel that is being recorded can always be checked by setting the television on the VCR channel (3 or 4) and pressing the **TV/VCR** selector to turn the VCR's VCR indicator on.
- Do not attempt to hook up more than one television set to the VCR for either recording or playback.

TROUBLESHOOTING

Cassette cannot be inserted.

- Load cassette in direction indicated by arrow on cassette.
- A cassette is already in the VCR.
- Check if POWER indicator is lit on the VCR indicator panel. If not, make sure power cord is plugged in.
- If the TAPE IN indicator flashes, press **POWER** again.

No picture appears on TV screen.

- Press **TV/VCR** to select the VCR mode.
- Set the television to the same channel selected on the VCR OUTPUT CHANNEL SELECT SWITCH. (CH3 or CH4).

A picture appears on TV screen but is not clear.

- Adjust the Tuning Control on the television to obtain the best picture.

The VCR will not go into the recording mode, even when REC is pressed.

- The cassette has had the safety tab removed. Stick a piece of cellophane tape over the safety tab hole or select a different cassette.

No picture appears on television screen when PLAY is pressed.

- Set the television to the VCR channel (3 or 4) depending upon the selected channel on the back of the VCR. (Output Channel).
- Try a different cassette tape.

No picture, but audio is clear.

- The heads may require cleaning.
- Take VCR to a qualified Service Center for service.

Interference on playback picture.

- Adjust fine tuning knob on television set to obtain best picture.
- Adjust the tracking control.
- Take VCR to Service Center for service.

The VCR cannot be remotely controlled or the remote control has short range.

- Weak or dead batteries.
- Do not block sensor.

"--:-- --" appears on the TV screen.

- Reset time according to instructions. Power has been interrupted.

VCR does not start at preset record starting time.

- Setup recording time according to instructions.
- Be sure the AM-PM display is correct.

The tape is ejected in the timer mode.

- The cassette has had the safety tab removed. Stick a piece of cellophane tape over the safety tab hole or select a different cassette.

TAPE IN indicator flashes.

- Insert a cassette.

The Auto Clock Setup procedure enters the wrong date and/or time.

- The TV station sent the wrong XDS information. Use the Manual Clock Set procedure on page 8.

SPECIFICATIONS

GENERAL

Head System

Four head helical scan azimuth system

Power Source

AC 120V, 60Hz

Power Consumption

Approx. 12 Watts

Dimensions (WxHxD)

360 x 94 x 242 mm (14.3" x 3.7" x 9.5")

Operating Temperature

5 °C - 35 °C (41 °F - 95 °F)

Operating Humidity

Less than 80% RH

Timer

12-hour display type with AM, PM

Weight

Approx. 2.7 kg (5.95 lbs)

Tape Speed

33.35 mm/sec (SP), 16.67 mm/sec (LP), 11.12 mm/sec (SLP)

Tape Width

12.7 mm

Maximum Recording Time

2 HOURS (T-120, SP), 6 HOURS (T-120, SLP)

8 HOURS (T-160, SLP)

Rewind Time

About 3 minutes (T-120)

TUNER

Antenna

75 ohms (VHF/UHF)

VHF Output Signal

Channel 3 or 4 (Switchable)

Channel Coverage

2-13 (VHF), 14-69 (UHF),

1-125 (4A, A-W, W+1 - W+84, A-5 - A-1) (CATV)

VIDEO

Video Signal System

EIA Standard (525 lines, 60 fields), NTSC type color signal

Input

1.0 Vp-p 75 ohms unbalanced

Output

1.0 Vp-p 75 ohms unbalanced

Signal to Noise Ratio

More than 43 dB (SP mode)

AUDIO

FM audio

Frequency Range

20 Hz to 20 kHz

Dynamic Range

More than 83 dB

Channel Separation

More than 55 dB

Conventional audio

Input

-6.0 dBm more than 47 kohms (LINE)

Output

-6.0 dBm less than 1.0 kohms (LINE)

S/N Ratio

More than 43 dB (SP mode)

Frequency Range

200 Hz to 10kHz (SP mode)

* Designs and specifications are subject to change without notice.

* Weight and dimensions shown are approximate.

For assistance in obtaining repairs and operational or technical information, please contact the following Toll Free Number:

DIAL TOLL FREE: 1-800-813-3435

Weekdays 7:30AM ~ 4:00PM Central Time

Also, you may write to SANYO Manufacturing Corporation, 3333 Sanyo Road Forrest City Arkansas 72335

LIMITED WARRANTY

LABOR 90 DAYS

PARTS 1 YEAR

CARRY-IN ONLY

THIS WARRANTY IS VALID ONLY ON SANYO PRODUCTS PURCHASED FROM A WAL-MART STORE AND USED IN THE UNITED STATES OF AMERICA, EXCLUDING HAWAII AND ALL U.S. TERRITORIES AND PROTECTORATES. THIS WARRANTY APPLIES ONLY TO THE ORIGINAL RETAIL PURCHASER AND DOES NOT APPLY TO PRODUCTS USED FOR ANY INDUSTRIAL, PROFESSIONAL OR COMMERCIAL PURPOSE.

Subject to the OBLIGATIONS and EXCLUSIONS below, SANYO Manufacturing Corporation ("SANYO") warrants this SANYO product against defects in materials and workmanship for the periods of LABOR and PARTS specified above. SANYO will repair or replace (at its option) the product and any of its parts which fail to conform to this warranty with new or refurbished products or parts. The warranty period commences on the date the product was first purchased at retail from a Wal-Mart Store.

OBLIGATIONS

In order to obtain warranty service, the product must be delivered to and picked up from a Wal-Mart Store at the original retail purchaser's expense. The original dated bill of sale, or sales slip from a Wal-Mart Store must be submitted to a Wal-Mart Store at the time warranty service is requested.

EXCLUSIONS

1. This warranty does not cover (A) the adjustment of customer-operated controls as explained in the appropriate model's instruction manual, or (B) the repair of any product whose serial number has been altered, defaced or removed.
2. This warranty shall not apply to the cabinet or cosmetic parts, broken or damaged video heads, batteries or routine maintenance.
3. This warranty does not apply to uncrating, setup, installation, removal of the product for repair or reinstallation of the product after repair.
4. This warranty does not apply to repairs or replacements necessitated by any cause beyond the control of SANYO including, but not limited to, any malfunction, defect or failure caused by or resulting from unauthorized service or parts, improper maintenance, operation contrary to furnished instructions, shipping or transit accidents, modification or repair by user or any third party, abuse, misuse, neglect, accident, incorrect line voltage, fire, flood or other Acts of God, or normal wear and tear.

The foregoing is in lieu of all other express warranties and SANYO does not assume or authorize any party to assume for it any other obligation or liability.

THE DURATION OF ANY WARRANTIES WHICH MAY BE IMPLIED BY LAW (INCLUDING THE WARRANTIES OF MERCHANTABILITY AND FITNESS) IS LIMITED TO THE TERM OF THIS WARRANTY. IN NO EVENT SHALL SANYO OR THE MANUFACTURER OF THE PRODUCT BE LIABLE FOR SPECIAL, INCIDENTAL OR CONSEQUENTIAL DAMAGES ARISING FROM OWNERSHIP OR USE OF THIS PRODUCT, OR FOR ANY DELAY IN THE PERFORMANCE OF ITS OBLIGATIONS UNDER THIS WARRANTY DUE TO CAUSES BEYOND ITS CONTROL.

SOME STATES DO NOT ALLOW LIMITATIONS ON HOW LONG AN IMPLIED WARRANTY LASTS AND/OR DO NOT ALLOW THE EXCLUSION OR LIMITATION OF CONSEQUENTIAL DAMAGES, SO THE ABOVE LIMITATIONS AND EXCLUSIONS MAY NOT APPLY TO YOU.

THIS WARRANTY GIVES YOU SPECIAL LEGAL RIGHTS. YOU MAY HAVE OTHER RIGHTS, WHICH VARY FROM STATE TO STATE.

For your protection in the event of theft or loss of this product, please keep the following information with a sales receipt in a safe place.

Model No. _____ **Serial No.** _____

Date of Purchase _____ **Purchase Price** _____

Where Purchased _____



SANYO Manufacturing Corporation



SANYO Electric Co., Ltd.

P/N: 3834RM0050Q

KA4HW/U3

(1E12/02) Issue No.1

Copyright SANYO, 2003 All rights reserved.

Printed in Indonesia