



LG
Life's Good

LCD TV | MEDIA BOX OWNER'S MANUAL

LCD TV MODELS

47LH85
55LH85

MEDIA BOX MODEL

ASW1000

Please read this manual carefully before operating your set and retain it for future reference.

The model and serial number of the **product** is located on the back and one side of the **product**.

Record it below should you ever need service.

Model:

Serial:



This product qualifies for ENERGY STAR in the "factory default (Home Use)" setting.

Changing the factory default settings or enabling other features may increase power consumption that could exceed the limits necessary to qualify for ENERGY STAR.

1-800-243-0000 USA, Consumer User
1-888-865-3026 USA, Commercial User
1-888-542-2623 CANADA

LG Customer Information Center

Media Box is not qualified for ENERGY STAR.

P/NO : SAC33601902 (0904-REV01)

www.lgusa.com / www.lg.ca

WARNING / CAUTION



TO REDUCE THE RISK OF ELECTRIC SHOCK DO NOT REMOVE COVER (OR BACK). NO USER SERVICEABLE PARTS INSIDE. REFER TO QUALIFIED SERVICE PERSONNEL.

 The lightning flash with arrowhead symbol, within an equilateral triangle, is intended to alert the user to the presence of uninsulated “dangerous voltage” within the product’s enclosure that may be of sufficient magnitude to constitute a risk of electric shock to persons.

 The exclamation point within an equilateral triangle is intended to alert the user to the presence of important operating and maintenance (servicing) instructions in the literature accompanying the appliance.

WARNING/CAUTION

TO REDUCE THE RISK OF FIRE AND ELECTRIC SHOCK, DO NOT EXPOSE THIS PRODUCT TO RAIN OR MOISTURE.

NOTE TO CABLE/TV INSTALLER

This reminder is provided to call the CATV system installer’s attention to Article 820-40 of the National Electric Code (U.S.A.). The code provides guidelines for proper grounding and, in particular, specifies that the cable ground shall be connected to the grounding system of the building, as close to the point of the cable entry as practical.

WARNING / CAUTION

To prevent fire or shock hazards, do not expose this product to rain or moisture.

FCC NOTICE

Class B digital device

This equipment has been tested and found to comply with the limits for a Class B digital device, pursuant to Part 15 of the FCC Rules. These limits are designed to provide reasonable protection against harmful interference in a residential installation. This equipment generates, uses and can radiate radio frequency energy and, if not installed and used in accordance with the instructions, may cause harmful interference to radio communications. However, there is no guarantee that interference will not occur in a particular installation. If this equipment does cause harmful interference to radio or television reception, which can be determined by turning the equipment off and on, the user is encouraged to try to correct the interference by one or more of the following measures:

- Reorient or relocate the receiving antenna.
- Increase the separation between the equipment and receiver.
- Connect the equipment to an outlet on a circuit different from that to which the receiver is connected.
- Consult the dealer or an experienced radio/TV technician for help.

This device complies with part 15 of the FCC Rules. Operation is subject to the following two conditions: (1) This device may not cause (harmful) interference, and (2) this device must accept any interference received, including interference that may cause undesired operation (of the device).

Any changes or modifications in construction of this device which are not expressly approved by the party responsible for compliance could void the user’s authority to operate the equipment.

CAUTION

Do not attempt to modify this product in any way without written authorization from LG Electronics. Unauthorized modification could void the user’s authority to operate this product.

SAFETY INSTRUCTIONS

IMPORTANT SAFETY INSTRUCTIONS

Read these instructions.
Keep these instructions.
Heed all warnings.
Follow all instructions.



- 1** Do not use this apparatus near water.

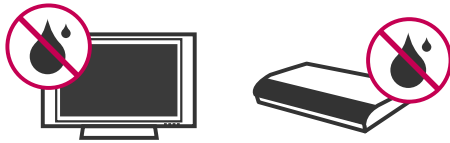

- 2** Clean only with dry cloth.



- 3** Do not block any ventilation openings. Install in accordance with the manufacturer's instructions.

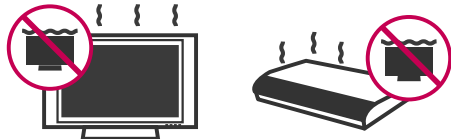

- 4** Do not install near any heat sources such as radiators, heat registers, stoves, or other apparatus (including amplifiers) that produce heat.



- 5** Do not defeat the safety purpose of the polarized or grounding-type plug. A polarized plug has two blades with one wider than the other. A grounding type plug has two blades and a third grounding prong. The wide blade or the third prong are provided for your safety. If the provided plug does not fit into your outlet, consult an electrician for replacement of the obsolete outlet.

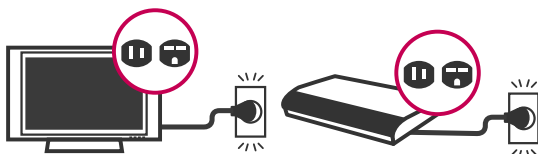

- 6** Protect the power cord from being walked on or pinched particularly at plugs, convenience receptacles, and the point where they exit from the apparatus.

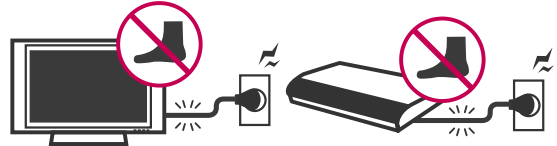

- 7** Only use attachments/accessories specified by the manufacturer.



- 8** Use only with the cart, stand, tripod, bracket, or table specified by the manufacturer, or sold with the apparatus. When a cart is used, use caution when moving the cart/apparatus combination to avoid injury from tip-over.



- 9** Unplug this apparatus during lightning storms or when unused for long periods of time.

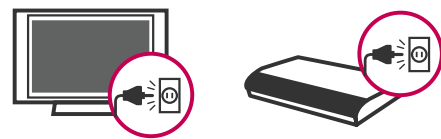

- 10** Refer all servicing to qualified service personnel. Servicing is required when the apparatus has been damaged in any way, such as power-supply cord or plug is damaged, liquid has been spilled or objects have fallen into the apparatus, the apparatus has been exposed to rain or moisture, does not operate normally, or has been dropped.

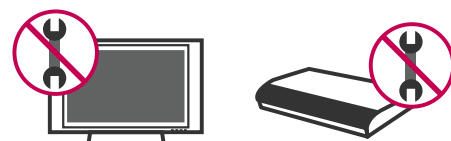

SAFETY INSTRUCTIONS

11 Never touch this apparatus or antenna during a thunder or lightning storm.

12 When mounting a TV on the wall, make sure not to install the TV by the hanging power and signal cables on the back of the TV.

13 Do not allow an impact shock or any objects to fall into the product, and do not drop onto the screen with something.

14 CAUTION concerning the Power Cord:
It is recommend that appliances be placed upon a dedicated circuit; that is, a single outlet circuit which powers only that appliance and has no additional outlets or branch circuits. Check the specification page of this owner's manual to be certain.

Do not connect too many appliances to the same AC power outlet as this could result in fire or electric shock.

Do not overload wall outlets. Overloaded wall outlets, loose or damaged wall outlets, extension cords, frayed power cords, or damaged or cracked wire insulation are dangerous. Any of these conditions could result in electric shock or fire. Periodically examine the cord of your appliance, and if its appearance indicates damage or deterioration, unplug it, discontinue use of the appliance, and have the cord replaced with an exact replacement part by an authorized servicer. Protect the power cord from physical or mechanical abuse, such as being twisted, kinked, pinched, closed in a door, or walked upon. Pay particular attention to plugs, wall outlets, and the point where the cord exits the appliance.

Do not make the **apparatus** with the power cord plugged in. Do not use a damaged or loose power cord. Be sure do grasp the plug when unplugging the power cord. Do not pull on the power cord to unplug the **apparatus**.



15 WARNING - To reduce the risk of fire or electrical shock, do not expose this **apparatus** to rain, moisture or other liquids. Do not touch the **apparatus** with wet hands. Do not install this **apparatus** near flammable objects such as gasoline or candles or expose the **apparatus** to direct air conditioning.

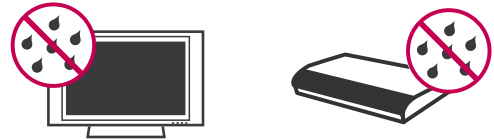

16 Do not expose to dripping or splashing and do not place objects filled with liquids, such as vases, cups, etc. on or over the apparatus (e.g. on shelves above the unit).



17 GROUNDING

Ensure that you connect the earth ground wire to prevent possible electric shock (i.e. **this apparatus** with a three-prong grounded AC plug must be connected to a three-prong grounded AC outlet). If grounding methods are not possible, have a qualified electrician install a separate circuit breaker.

Do not try to ground the **apparatus** by connecting it to telephone wires, lightning rods, or gas pipes.

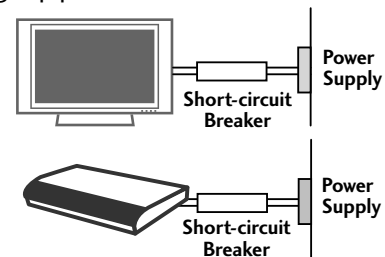

18 DISCONNECTING DEVICE FROM MAINS
Mains plug is the disconnecting device. The plug must remain readily operable.

19 As long as this unit is connected to the AC wall outlet, it is not disconnected from the AC power source even if you turn off this unit by SWITCH.

20 ANTENNAS

Outdoor antenna grounding

If an outdoor antenna is installed, follow the precautions below. An outdoor antenna system should not be located in the vicinity of overhead power lines or other electric light or power circuits, or where it can come in contact with such power lines or circuits as death or serious injury can occur.

Be sure the antenna system is grounded so as to provide some protection against voltage surges and built-up static charges.

Section 810 of the National Electrical Code (NEC) in the U.S.A. provides information with respect to proper grounding of the mast and supporting structure, grounding of the lead-in wire to an antenna discharge unit, size of grounding conductors, location of antenna discharge unit, connection to grounding electrodes and requirements for the grounding electrode.

Antenna grounding according to the National Electrical Code, ANSI/NFPA 70

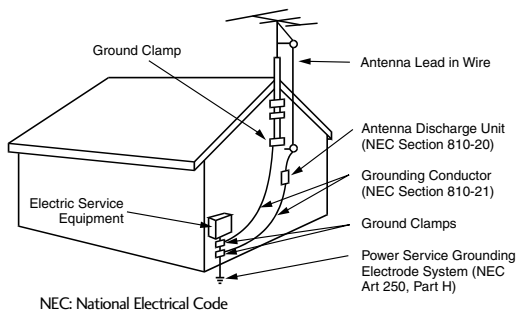

NEC: National Electrical Code

21 Cleaning

When cleaning, unplug the power cord and scrub gently with a soft cloth to prevent scratching. Do not spray water or other liquids directly on the apparatus as electric shock may occur. Do not clean with chemicals such as alcohol, thinners or benzene.

22 Moving

Make sure the product is turned off, unplugged and all cables have been removed. It may take 2 or more people to carry larger TVs. Do not press against or put stress on the front panel of the TV.

23 Ventilation

Install this apparatus where there is proper ventilation. Do not install in a confined space such as a bookcase. Do not cover the product with cloth or other materials (e.g.) plastic while plugged in. Do not install in excessively dusty places.

24 If you smell smoke or other odors coming from this apparatus or hear strange sounds, unplug the power cord contact an authorized service center.

25 Do not press strongly upon the panel with hand or sharp object such as nail, pencil or pen, or make a scratch on it.

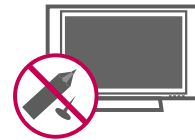

26 Keep the product away from direct sunlight.

27 For LCD TV

If the TV feels cold to the touch, there may be a small “flicker” when it is turned on. This is normal, there is nothing wrong with TV.

Some minute dot defects may be visible on the screen, appearing as tiny red, green, or blue spots. However, they have no adverse effect on the monitor’s performance.

Avoid touching the LCD screen or holding your finger(s) against it for long periods of time. Doing so may produce some temporary distortion effects on the screen.

28 FCC Radiation Exposure

In order to meet FCC RF Exposure requirements, this device must be installed in such a way that a distance of 20cm is always maintained between the device antenna and nearby persons.

ON DISPOSAL

(Only Hg lamp used LCD TV)

The fluorescent lamp used in this product contains a small amount of mercury. Do not dispose of this product with general household waste. Disposal of this product must be carried out in accordance to the regulations of your local authority.

CONTENTS

WARNING / CAUTION	2
SAFETY INSTRUCTIONS	3
FEATURE OF THIS TV	8

PREPARATION

Accessories	9
Front Panel Information	10
Back Panel Information	12
Important Things to Know Before Installing the Media Box	14
Installation method for Media Box	15
Stand Instructions	16
VESA Wall Mounting	18
Cable Management	19
Desktop Pedestal Installation	20
Swivel Stand	20
Kensington Security System	20
Securing the TV to the wall to prevent falling when the TV is used on a stand	21
Antenna or Cable Connection	22

EXTERNAL EQUIPMENT SETUP

HD Receiver Setup	23
DVD Setup	26
VCR Setup	28
Other A/V Source Setup	29
USB Connection	30
Audio out Connection	31
PC Setup	32

WATCHING TV / CHANNEL CONTROL

Remote Control Functions	38
Turning On the TV	40
Channel Selection	42
Volume Adjustment	42
Initial Setting	43
On-Screen Menus Selection	44

Quick Menu	45
Channel Setup	
- Auto Scan (Auto Tuning)	46
- Add / Delete Channel (Manual Tuning)	47
- Channel Editing	48
Channel List	49
Favorite Channel Setup / Favorite Channel List ..	50
Brief Information	51
Input List	52
Input Label	53
AV Mode	54
Simple Manual	54
Key Lock	55
SIMPLINK	56

USB

Entry Modes	58
Photo List	59
Music List	63
Movie List	65
Divx Registration Code	70
Deactivation	71

PICTURE CONTROL

Picture Size (Aspect Ratio) Control	72
Picture Wizard	74
Preset Picture Settings (Picture Mode)	76
Manual Picture Adjustment - User Mode	77
Picture Improvement Technology	78
Expert Picture Control	79
Energy Saving	82
Picture Reset	83
Power Indicator	84
Demo Mode	85

SOUND & LANGUAGE CONTROL

Auto Volume Leveler (Auto Volume)	86
Clear Voice II	87
Preset Sound Setting (Sound Mode)	88
Sound Setting Adjustment - User Mode	89
SRS Trusurround XT	90
Balance	91
TV Speakers On/Off Setup	92
Audio Reset	93
Stereo/SAP Broadcasts Setup	94
On-Screen Menus Language Selection	95
Audio Language	96
Caption Mode	
- Analog Broadcasting System Captions	97
- Digital Broadcasting System Captions	98
- Caption Option	99

TIME SETTING

Clock Setting	
- Auto Clock Setup	100
- Manual Clock Setup	101
Auto On/Off Time Setting	102
Sleep Timer Setting	103

PARENTAL CONTROL / RATINGS

Set Password & Lock System	104
Channel Blocking	107
Movie & TV Rating	108
Downloadable Rating	113
External Input Blocking	114

APPENDIX

Troubleshooting	115
Maintenance	118
Product Specifications	119
IR Code	120
Open Source Software Notice	121
Open Source License	122

FEATURE OF THIS TV



High-definition television. High-resolution digital television broadcast and playback system composed of roughly a million or more pixels, 16:9 aspect-ratio screens, and AC3 digital audio. A subset of digital television, HDTV formats include 1080i and 720p resolutions.



This TV contains the detailed calibrations necessary for professional certification by the Imaging Science Foundation. The resulting ISF “day” and “night” modes will then be accessible by the user to experience the best their LG HDTV has to offer. Sophisticated and detailed calibrations can be made through the ISFccc mode. Detailed calibration requires a licensed technician. Please contact your local dealer to inquire about an ISF certified technician.



AV Mode is three preset picture and audio settings. It allows the viewer to quickly switch between common settings. It includes Cinema, Sports, and Game Modes.



A unique invisible speaker system tuned by renowned audio expert, Mr. Mark Levinson. Speakers are embedded in strategic spots behind the front cabinet and use minute vibrations to turn the entire front bezel into the speaker system. The result is a clean, polished look, and enhanced audio by increasing the “sweet spot”, giving a wider and richer sound field.



Advance 120Hz panel provides clearer, smoother images, even during fast action scenes creating a more stable structure for a crisper picture.



In addition to adhering to the new Energy Star 3.0 specification, LG HDTVs have energy-saving options like the ability to choose a content-specific setting, “video mute” or engaging exclusive Intelligent Sensor technology.



Manufactured under license from Dolby Laboratories. “Dolby” and the double-D symbol are trademarks of Dolby Laboratories.



SRS is a trademark of SRS Labs, Inc. TruSurround XT technology is incorporated under license from SRS Labs, Inc.



Automatically enhances and amplifies the sound of human voice frequency range to help keep dialogue audible when background noise swells.



HDMI, the HDMI logo and High-Definition Multimedia Interface are trademarks or registered trademarks of HDMI Licensing LLC.”



Displays HDTV programs in full 1920 x 1080p resolution for a more detailed picture.



Uncompressed 1080p signal transmission without the hassle of messy wires.



Unlike other sensors which can only sense brightness of ambient light, LG’s “Intelligent Sensor” uses 4,096 sensing steps to evaluate its surroundings. Using a sophisticated algorithm, the LG processes picture quality elements including brightness, contrast, color, sharpness and white balance. The result is a picture optimized for its surroundings, more pleasing to watch and which can also save up to 50% in power consumption.



“DivX Certified to play DivX video up to HD 1080p, including premium content”
ABOUT DIVX VIDEO: DivX® is a digital video format created by DivX, Inc. This is an official DivX Certified device that plays DivX video. Visit www.divx.com for more information and software tools to convert your files into DivX video.
ABOUT DIVX VIDEO-ON-DEMAND: This DivX Certified® device must be registered in order to play DivX Video-on-Demand (VOD) content. To generate the registration code, locate the DivX VOD section in the device setup menu. Go to vod.divx.com with this code to complete the registration process and learn more about DivX VOD.



IMPORTANT INFORMATION TO PREVENT “IMAGE BURN / BURN-IN” ON YOUR TV SCREEN

- When a fixed image (e.g. logos, screen menus, video game, and computer display) is displayed on the TV for an extended period, it can become permanently imprinted on the screen. This phenomenon is known as “image burn” or “burn-in.” Image burn is not covered under the manufacturer’s warranty.
- In order to prevent image burn, avoid displaying a fixed image on your TV screen for a prolonged period (2 or more hours for LCD, 1 or more hours for Plasma).
- Image burn can also occur on the letterboxed areas of your TV if you use the 4:3 aspect ratio setting for an extended period.

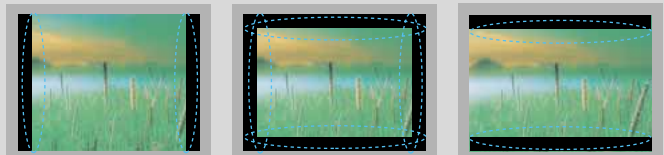

PREPARATION

ACCESSORIES

Ensure that the following accessories are included with your TV. If an accessory is missing, please contact the dealer where you purchased the TV.

The accessories included may differ from the images below.

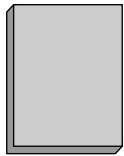

Owner's Manual



CD Manual

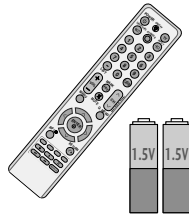

Remote Control,
Batteries

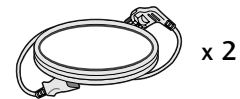

Power Cord x 2

(For 47LH85)



x 4

Screws for stand assembly
(Refer to P.16)

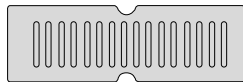

Protection Cover

Not included with all models

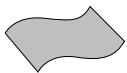

Polishing Cloth

- * Wipe spots on the exterior only with the polishing cloth.
- * Do not wipe roughly when removing stain. Excessive pressure may cause scratch or discoloration.

Option Extras

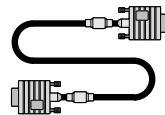

D-sub 15 pin Cable

When using the VGA (D-sub 15 pin cable) PC connection, the user must use shielded signal interface cables with ferrite cores to maintain standards compliance.

PREPARATION

FRONT PANEL INFORMATION

■ Image shown may differ from your product.

PREPARATION

LCD TV

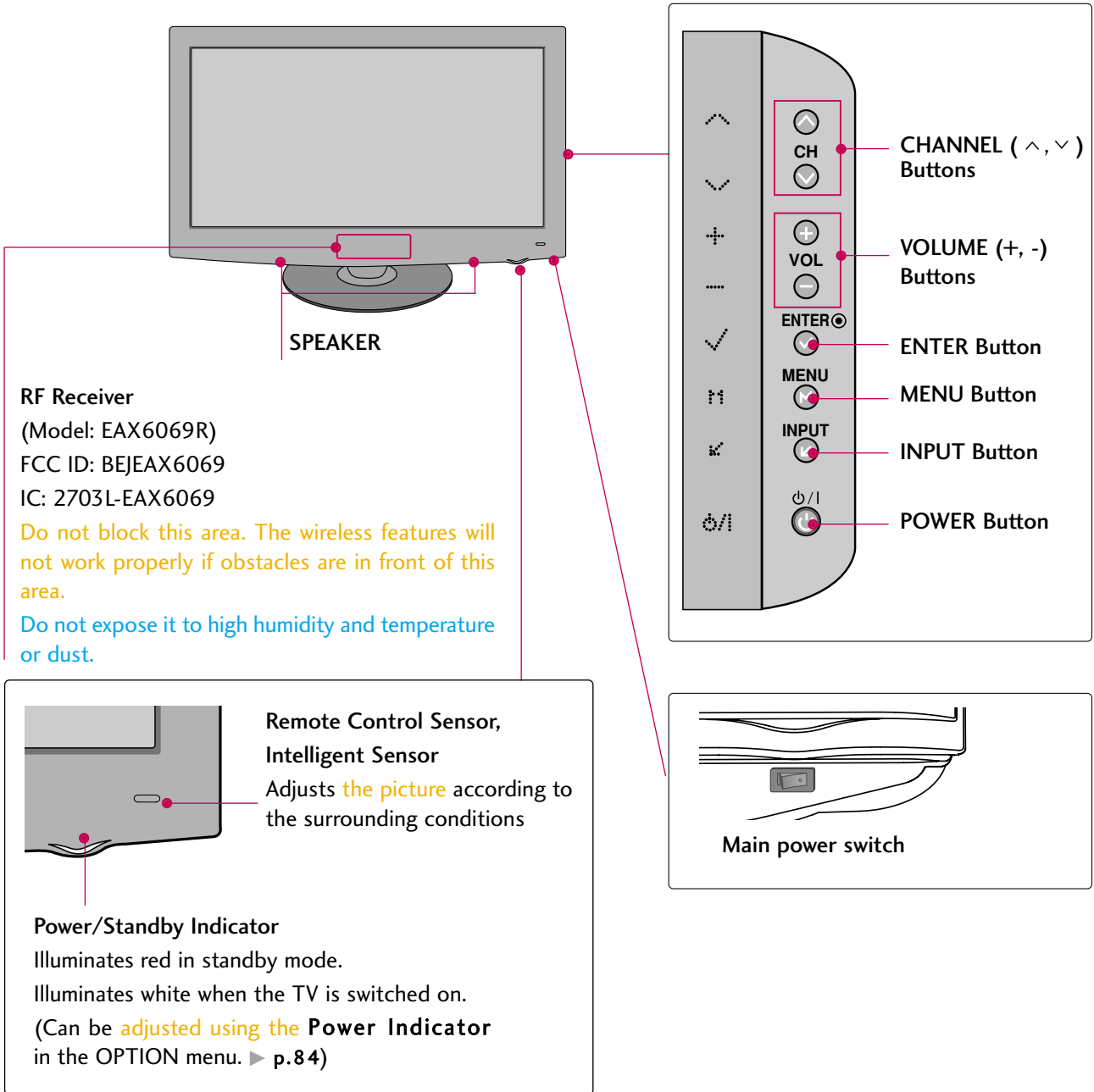

MEDIA BOX

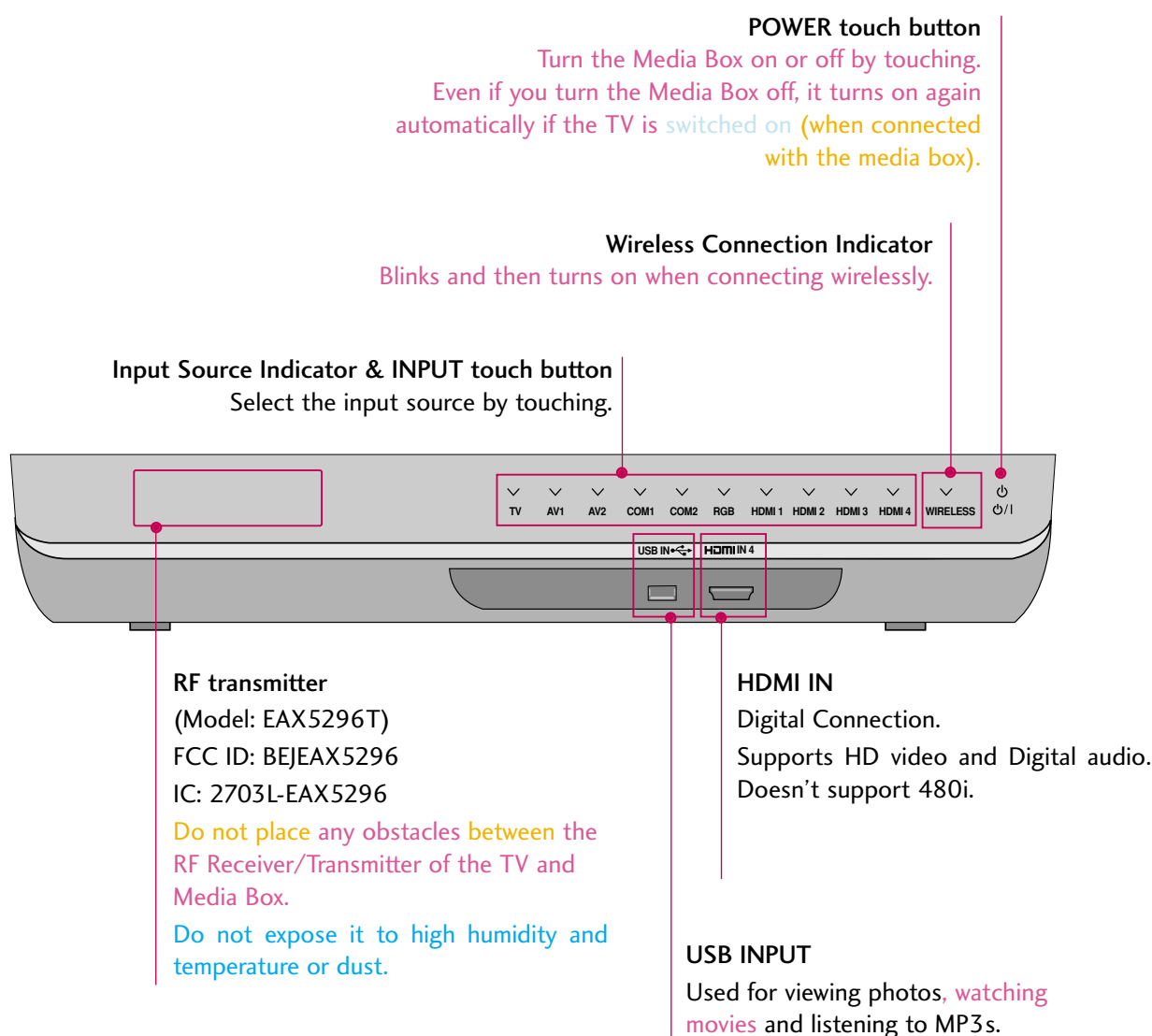

* ID Label of Media Box is located at the bottom of Media Box.

PREPARATION

BACK PANEL INFORMATION

- Image shown may differ from your product.

LCD TV

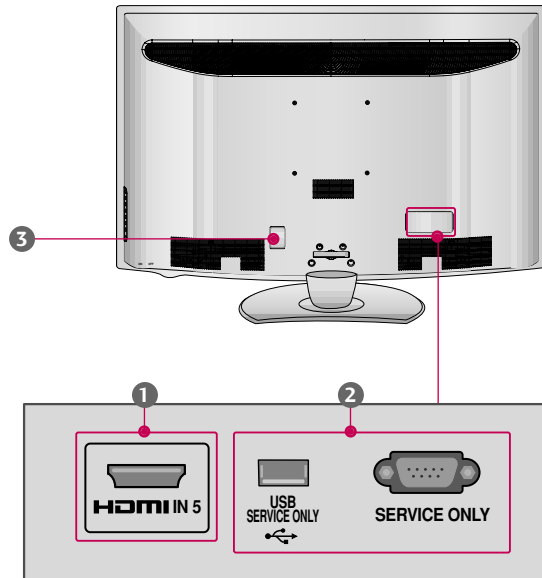

- 1 HDMI IN**
Digital Connection.
Supports HD video and Digital audio.
Doesn't support 480i and SIMPLINK (HDMI-CEC).
- 2 USB SERVICE ONLY, SERVICE ONLY**
Used for software updates.
- 3 Power Cord Socket**
For operation with AC power.
Caution: Never attempt to operate the TV on DC power.

MEDIA BOX

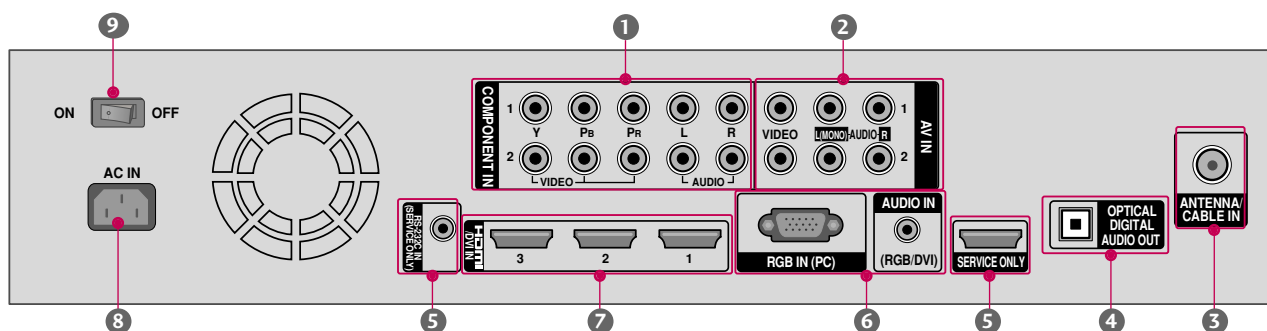

1 COMPONENT IN

Analog Connection.

Supports HD.

Uses a red, green, and blue cable for video & red and white for audio.

2 AV (Audio/Video) IN

Analog composite connection. Supports standard definition video only (480i).

3 ANTENNA/CABLE IN

Connect over-the air/Cable signals to this jack.

4 OPTICAL DIGITAL AUDIO OUT

Digital optical audio output for use with amps and home theater systems.

Note: In standby mode, this port doesn't work.

5 SERVICE ONLY, RS-232C IN (SERVICE ONLY)

Used for software updates.

6 RGB IN (PC)

Analog PC Connection. Uses a D-sub 15 pin cable (VGA cable, not included).

AUDIO IN (RGB/DVI)

1/8" (0.32 cm) headphone jack for analog PC audio input.

7 HDMI/DVI IN

Digital Connection.

Supports HD video and Digital audio. Doesn't support 480i.

Accepts DVI video using an adapter or HDMI to DVI cable (not included).

8 Power Cord Socket

For operation with AC power.

Caution: Never attempt to operate the TV on DC power.

9 Main power switch

This cuts power to the TV. When turned on, the TV is in standby mode.

If you cannot turn the Media Box on with the remote control, turn the power on using the **Main power switch** and then switch the TV on with **POWER** button on the remote control.

If you turned the Media Box off using the **Main power switch**, you cannot turn it on with the remote control.

PREPARATION

IMPORTANT THINGS TO KNOW BEFORE INSTALLING THE MEDIA BOX

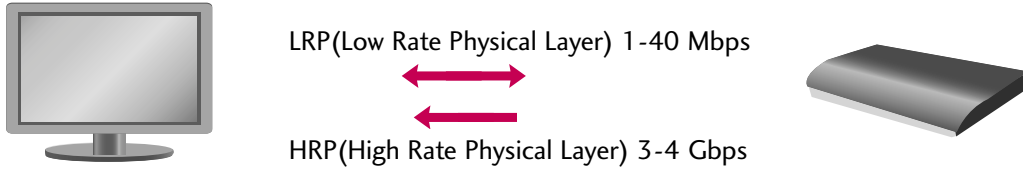

- The Media Box transmits 1080p HD videos wirelessly using the 60 GHz frequency.
- It transmits uncompressed 1080p HD video to the TV up to 32 feet (10 m) in LOS (Line Of Sight).
- It also features beam direction based on the 60 GHz frequency. If there are any obstacles in the way of transmission, the receiver uses an indoor wall or other reflective material and finds an alternative transmission path immediately to avoid the obstacle and maintain the connection.

CAUTIONS IN INSTALLATION

- The performance of radio-signal reception and video quality may differ depending on where the TV and Media Box are located. To get better video quality, make sure to keep the distance between the TV and Media Box within LOS (Line Of Sight) 32 feet (10 m) and have them face each other.
- The RF Receiver/Transmitter is located on the front panels of the TV and Media Box. Do not place any obstacle around the RF Receiver/Transmitter. And Do not expose it to high humidity and temperature or dust.
- The performance of radio-signal reception may be degraded if the Media Box is installed beside the TV. Press the INFO button on the remote control to check the status of radio-signal reception and install the Media Box where radio-signal reception is GOOD (▶ p.51).

NOTE

- This product is only for home use.
- Do not use this product in medical institutions or near medical devices. It may cause some medical devices to malfunction.
- Video quality may be degraded or reception distance may be shortened depending on the surrounding circumstances.
- If there are any obstacles between the TV and Media Box, the performance of radio-signal reception may be degraded.
- If there are any moving objects between the TV and Media Box, the screen may flicker briefly but will return to normal immediately, and no problem will occur in operation.
- If you install the Media Box out of the maximum range of reception/transmission, connection may fail or video quality may be degraded.
- If you install the Media Box to the left or right side of the TV, video quality may be degraded.
- If you install the Media Box inside a metal cabinet, connection may fail.
- If you install the Media Box on the middle of a table, connection may fail or video quality may be degraded. Install the Media Box close to the edge of a table.
- If there are two wireless TV sets or Media Boxes within LOS (Line Of Sight) 32 feet (10 m), they may interfere with each other and wireless connection may fail.

INSTALLATION METHOD FOR MEDIA BOX

- This is a recommended installation type for good wireless connection.

When the Media Box and TV are kept apart and facing each other

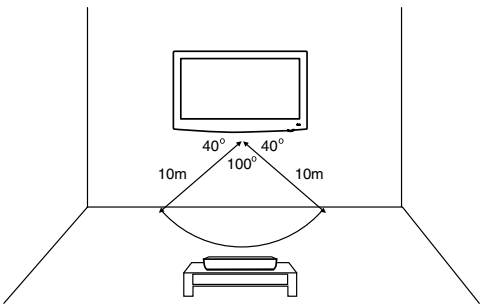

- Have the RF Receiver/Transmitter of the Media Box and TV face each other. Keep the distance between them to within **32.8 feet (10 m)** and maintain the face angle of the TV within 100 degrees.

When installing the Media Box and TV on the same wall

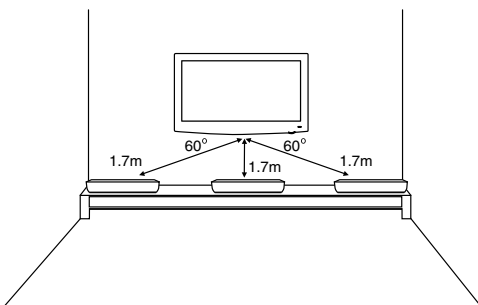

- Have the Media Box and TV face the front. Keep the distance between them within **5 1/2 feet (1.7) m** and maintain the face angle of the TV within 120 degrees.

When installing the Media Box and TV side by side

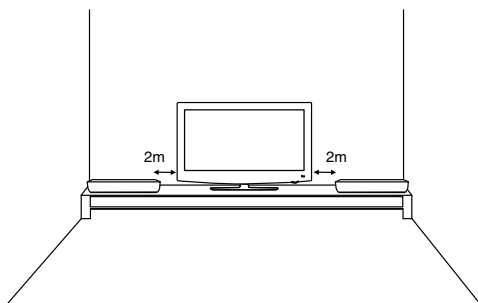

- Have the Media Box and TV face the front. Keep the distance between them within **6 1/2 feet (2 m)**.

PREPARATION

STAND INSTRUCTIONS

- Image shown may differ from your TV.

INSTALLATION (For 47LH85)

- 1 Carefully place the TV screen side down on a cushioned surface to protect the screen from damage.

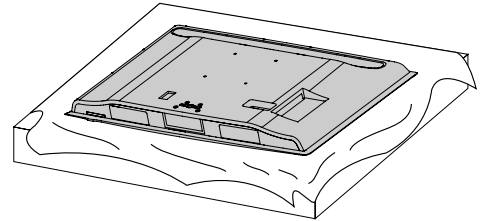

- 2 Assemble the TV as shown.

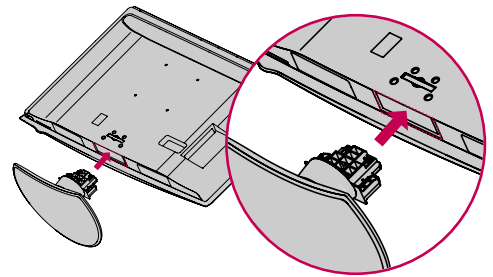

- 3 Fix the 4 screws securely using the holes in the back of the TV.

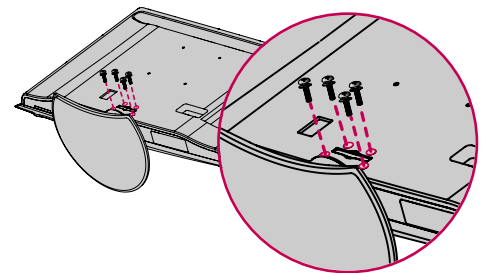

! NOTE

- ▶ When assembling the desk type stand, make sure the screws are fully tightened (If not tightened fully, the TV can tilt forward after the product installation). Do not over tighten.

DETACHMENT

- 1 Carefully place the TV screen side down on a cushioned surface to protect the screen from damage.

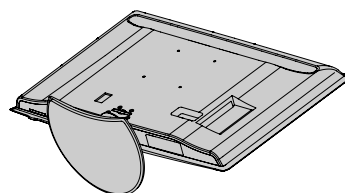

- 2 Remove the screws from the TV.

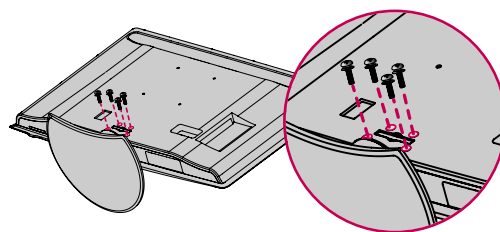

- 3 Detach the stand from TV.

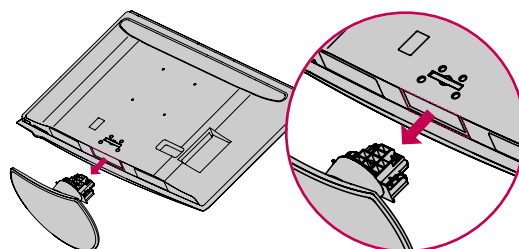

PROTECTION COVER

- 4 After removing the protection paper from the **PROTECTION COVER**, adhere it to the TV as shown.

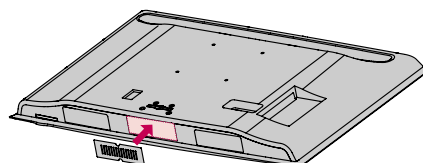

PREPARATION

VESA WALL MOUNTING

Install your wall mount on a solid wall perpendicular to the floor. When attaching to other building materials, please contact your nearest installer.

If installed on a ceiling or slanted wall, it may fall and result in severe personal injury.

We recommend that you use an LG brand wall mount when mounting the TV to a wall.

LG recommends that wall mounting be performed by a qualified professional installer.

PREPARATION

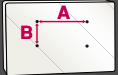
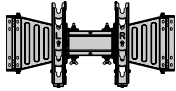
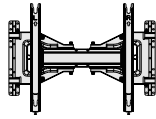
Model	VESA (A * B) 	Standard Screw	Quantity	Wall Mounting Bracket (sold separately)
47LH85	200 * 200	M6	4	 AW-47LG30M
55LH85	400 * 400	M6	4	 AW-55LH40M

NOTE

- ▶ Screw length needed depends on the wall mount used. For further information, refer to the instructions included with the mount.
- ▶ Standard dimensions for wall mount kits are shown in the table.
- ▶ When purchasing our wall mount kit, a detailed installation manual and all parts necessary for assembly are provided.
- ▶ Do not use screws longer than the standard dimension, as they may cause damage to the inside to the TV.
- ▶ For wall mounts that do not comply with the VESA standard screw specifications, the length of the screws may differ depending on their specifications.
- ▶ Do not use screws that do not comply with the VESA standard screw specifications.
- ▶ Do not use fasten the screws too strongly, this may damage the TV or cause the TV to a fall, leading to personal injury. LG is not liable for these kinds of accidents.
- ▶ LG is not liable for TV damage or personal injury when a non-VESA or non specified wall mount is used or the consumer fails to follow the TV installation instructions.

CAUTION

- ▶ Do not install your wall mount kit while your TV is turned on. It may result in personal injury due to electric shock.

CABLE MANAGEMENT

■ Image shown may differ from your TV.

- 1 Connect the cables as necessary.
To connect additional equipment, see the **EXTERNAL EQUIPMENT SETUP** section.

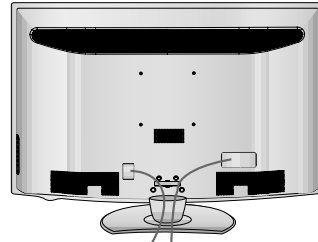

- 2 Open the **CABLE MANAGEMENT CLIP** as shown.

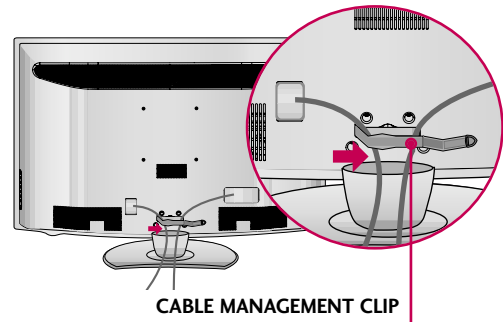

- 3 Put the cables inside the **CABLE MANAGEMENT CLIP** and snap it closed.

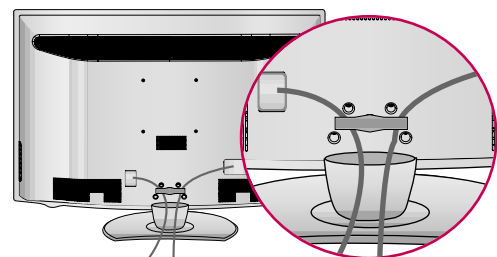

PREPARATION

DESKTOP PEDESTAL INSTALLATION

- Image shown may differ from your TV.

For proper ventilation, allow a clearance of 4 inches on all four sides from the wall.

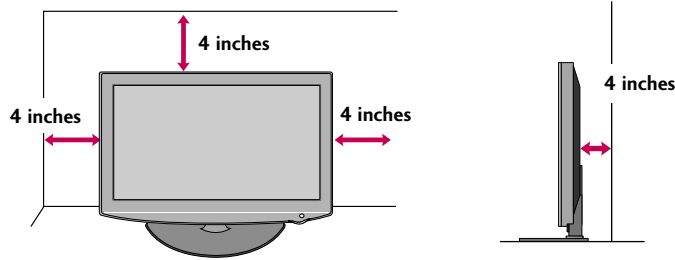

- CAUTION**
- ▶ Ensure adequate ventilation by following the clearance recommendations.
 - ▶ Do not mount near or above any type of heat source.

SWIVEL STAND

After installing the TV, you can adjust the TV set manually to the left or right direction by 20 degrees to suit your viewing position.

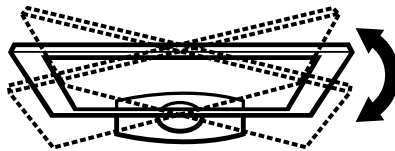

KENSINGTON SECURITY SYSTEM

- This feature is not available for all models.

- The TV is equipped with a Kensington Security System connector on the back panel. Connect the Kensington Security System cable as shown below.
- For the detailed installation and use of the Kensington Security System, refer to the user's guide provided with the Kensington Security System.

For further information, contact <http://www.kensington.com>, the internet homepage of the Kensington company. Kensington sells security systems for expensive electronic equipment such as notebook PCs and LCD projectors.

NOTE: The Kensington Security System is an optional accessory.

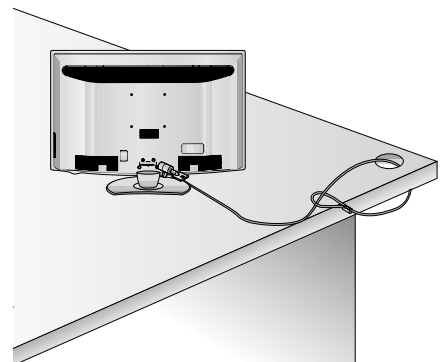

SECURING THE TV TO THE WALL TO PREVENT FALLING WHEN THE TV IS USED ON A STAND

- You should purchase necessary components to prevent the TV from tipping over (when not using a wall mount).
- Image shown may differ from your TV.

We recommend that you set up the TV close to a wall so it cannot fall over if pushed backwards. Additionally, we recommend that the TV be attached to a wall so it cannot be pulled in a forward direction, potentially causing injury or damaging the product.

Caution: Please make sure that children don't climb on or hang from the TV.

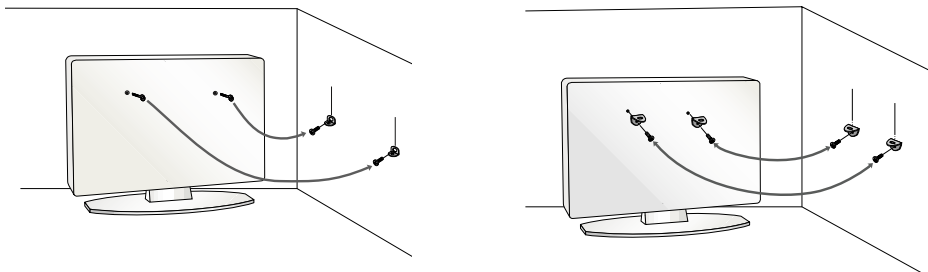

- Insert the eye-bolts (or TV brackets and bolts) to tighten the product to the wall as shown in the picture.

* If your product has the bolts in the eye-bolts position before inserting the eye-bolts, loosen the bolts.

* Insert the eye-bolts or TV brackets/bolts and tighten them securely in the upper holes.

Secure the wall brackets with the bolts (sold separately) to the wall. Match the height of the bracket that is mounted on the wall to the holes in the product.

Ensure the eye-bolts or brackets are tightened securely.

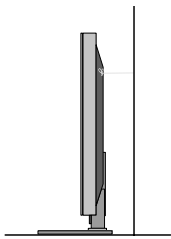

- Use a sturdy rope (sold separately) to tie the product. It is safer to tie the rope so it becomes horizontal between the wall and the product.

! NOTE

- ▶ Use a platform or cabinet strong enough and large enough to support the size and weight of the TV.
- ▶ To use the TV safely make sure that the height of the bracket on the wall and the one on the TV are the same.

PREPARATION

- To prevent damage do not connect to the power outlet until all connections are made between the devices.
- Image shown may differ from your product.

ANTENNA OR CABLE CONNECTION

PREPARATION

1. Antenna (Analog or Digital)

Wall Antenna Socket or Outdoor Antenna without a Cable Box Connections.

For optimum picture quality, adjust antenna direction if needed.

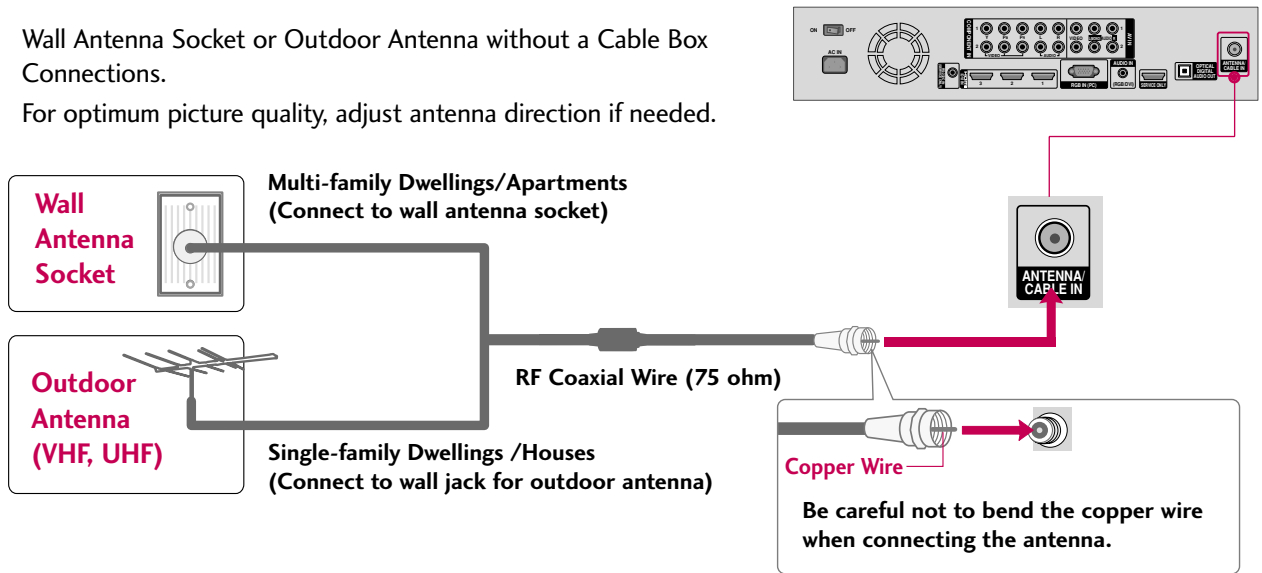

2. Cable

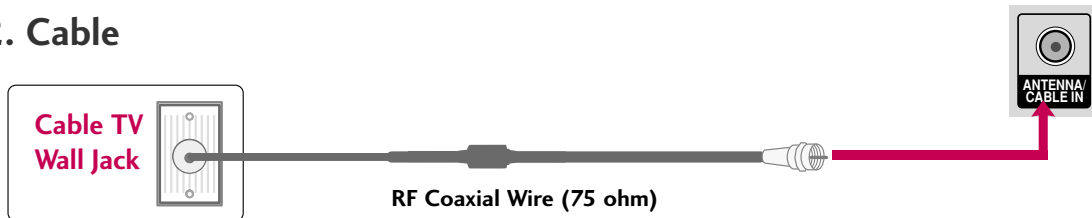

- To improve the picture quality in a poor signal area, please purchase a signal amplifier and install properly.
- If the antenna needs to be split for two TV's, install a 2-Way Signal Splitter.
- If the antenna is not installed properly, contact your dealer for assistance.
- Refer to <http://AntennaWeb.org> for more information about antennas and Digital TV.

EXTERNAL EQUIPMENT SETUP

- To prevent the equipment damage, never plug in any power cords until you have finished connecting all equipment.
- Image shown may differ from your product.

HD RECEIVER SETUP

This Media Box can receive digital over-the-air/digital cable signals without an external digital set-top box. However, if you do receive digital signals from a digital set-top box or other digital external device.

Component Connection

1. How to connect

- 1 Connect the video outputs (Y, PB, PR) of the digital set-top box to the **COMPONENT IN VIDEO 1** or **2** jacks on the Media Box. Match the jack colors (Y = green, PB = blue, and PR = red).
- 2 Connect the audio output of the digital set-top box to the **COMPONENT IN AUDIO 1** or **2** jacks on the Media Box.

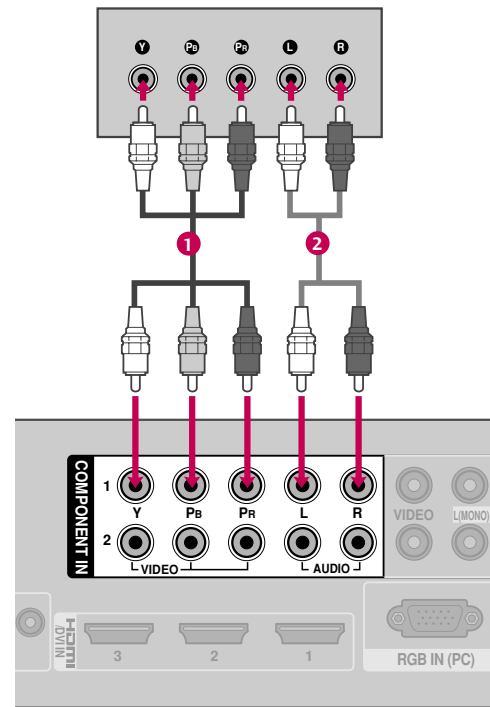

2. How to use

- Turn on the digital set-top box.
(Refer to the owner's manual for the digital set-top box operation.)
- Select the **Component1** or **Component2** input source using the **INPUT** button on the remote control.

Supported Resolutions

Signal	Component	HDMI
480i	Yes	No
480p	Yes	Yes
720p	Yes	Yes
1080i	Yes	Yes
1080p	Yes	Yes

Y, CB/PB, CR/PR

Resolution	Horizontal Frequency(KHz)	Vertical Frequency(Hz)
720x480i	15.73	59.94
	15.73	60.00
720x480p	31.47	59.94
	31.50	60.00
1280x720p	44.96	59.94
	45.00	60.00
1920x1080i	33.72	59.94
	33.75	60.00
1920x1080p	26.97	23.97
	27.00	24.00
	33.71	29.97
	33.75	30.00
	67.43	59.94
	67.50	60.00

EXTERNAL EQUIPMENT SETUP

HDMI Connection

1. How to connect

- 1 Connect the digital set-top box to **HDMI/DVI IN 1, 2, 3,** or **HDMI IN 4** jack on the Media Box or **HDMI IN 5** on the TV.
- 2 No separate audio connection is necessary. HDMI supports both audio and video.

2. How to use

- Turn on the digital set-top box.
(Refer to the owner's manual for the digital set-top box.)
- Select the **HDMI1, HDMI2, HDMI3, HDMI4,** or **HDMI5** input source using the **INPUT** button on the remote control.

! NOTE

- ▶ Check HDMI cable over version 1.3.
If the HDMI cables don't support HDMI version 1.3, it can cause flickers or no screen display. In this case use the latest cables that support HDMI version 1.3.
- ▶ [HDMI Audio Format: PCM, Dolby Digital](#)

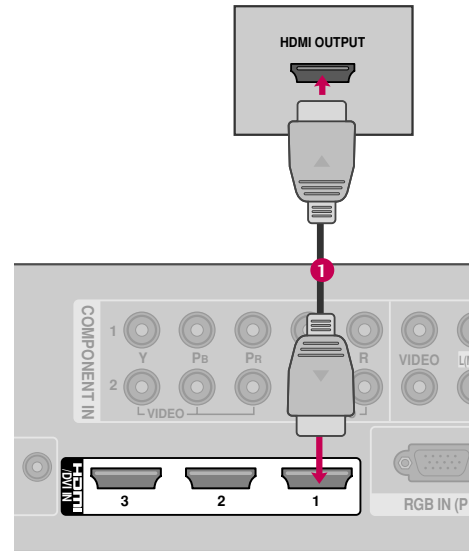

HDMI-DTV

Resolution	Horizontal Frequency(KHz)	Vertical Frequency(Hz)
720x480p	31.47	59.94
	31.50	60.00
1280x720p	44.96	59.94
	45.00	60.00
1920x1080i	33.72	59.94
	33.75	60.00
1920x1080p	26.97	23.97
	27.00	24.00
	33.71	29.97
	33.75	30.00
	67.43	59.94
	67.50	60.00

DVI to HDMI Connection

1. How to connect

- 1 Connect the DVI output of the digital set-top box to the **HDMI/DVI IN 1, 2, or 3** jack on the Media Box.
- 2 Connect the digital set-top box audio output to the **AUDIO IN (RGB/DVI)** jack on the Media Box.

2. How to use

- Turn on the digital set-top box.
(Refer to the owner's manual for the digital set-top box.)
- Select the **HDMI1**, **HDMI2**, or **HDMI3** input source using the **INPUT** button on the remote control.

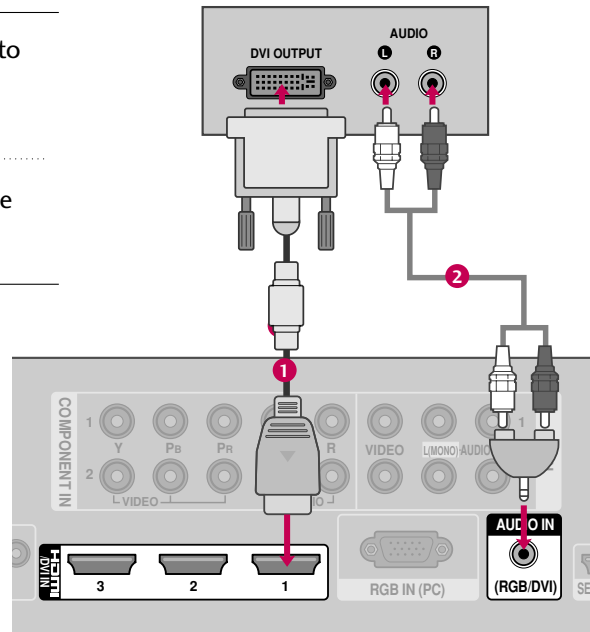

EXTERNAL EQUIPMENT SETUP

DVD SETUP

Component Connection

1. How to connect

- 1 Connect the video outputs (Y, PB, PR) of the DVD to the **COMPONENT IN VIDEO 1 or 2** jacks on the Media Box. Match the jack colors (Y = green, PB = blue, and PR = red).
- 2 Connect the audio outputs of the DVD to the **COMPONENT IN AUDIO 1 or 2** jacks on the Media Box.

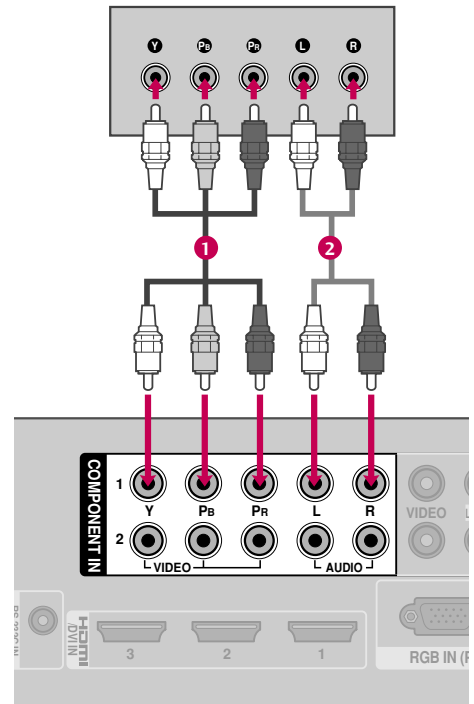

2. How to use

- Turn on the DVD player, insert a DVD.
- Select the **Component1** or **Component2** input source using the **INPUT** button on the remote control.
- Refer to the DVD player's manual for operating instructions.

Composite (RCA) Connection

1. How to connect

- 1 Connect the **AUDIO/VIDEO** jacks between Media Box and DVD. Match the jack colors (Video = yellow, Audio Left = white, and Audio Right = red)

2. How to use

- Turn on the DVD player, insert a DVD.
- Select the **AV1** or **AV2** input source using the **INPUT** button on the remote control.
- Refer to the DVD player's manual for operating instructions.

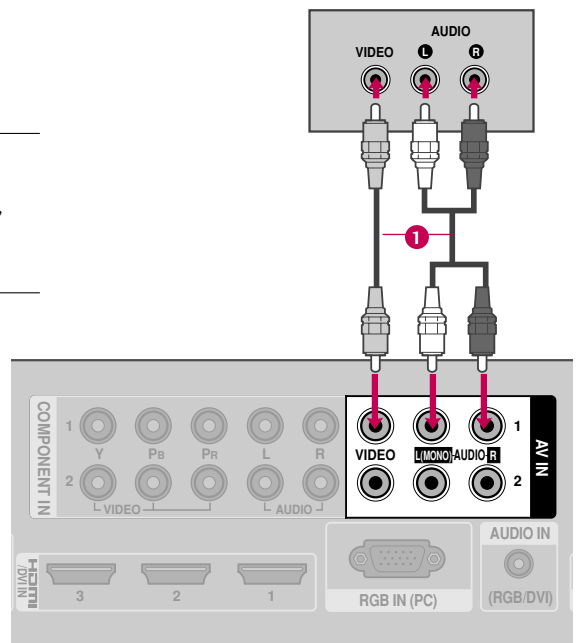

HDMI Connection

1. How to connect

- 1 Connect the HDMI output of the DVD to the **HDMI/DVI IN 1, 2, 3,** or **HDMI IN 4** jack on the Media Box or **HDMI IN 5** on the TV.
- 2 No separate audio connection is necessary. HDMI supports both audio and video.

2. How to use

- Select the **HDMI1, HDMI2, HDMI3, HDMI4,** or **HDMI5** input source using the **INPUT** button on the remote control.
- Refer to the DVD player's manual for operating instructions.

! NOTE

- ▶ Check HDMI cable over version 1.3. If the HDMI cables don't support HDMI version 1.3, it can cause flickers or no screen display. In this case use the latest cables that support HDMI version 1.3.

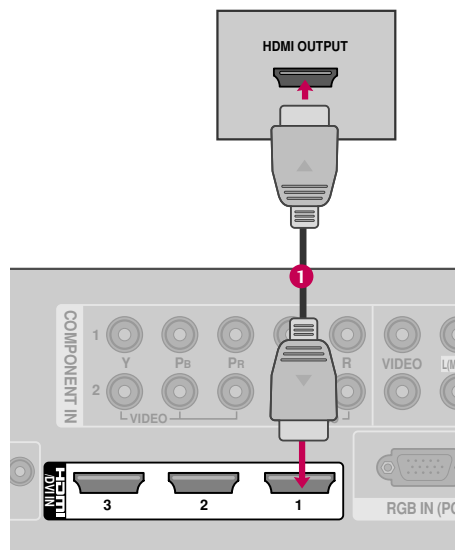

EXTERNAL EQUIPMENT SETUP

VCR SETUP

Antenna Connection

1. How to connect

- 1 Connect the RF antenna out socket of the VCR to the **ANTENNA/CABLE IN** socket on the Media Box.
- 2 Connect the antenna cable to the RF antenna in socket of the VCR.

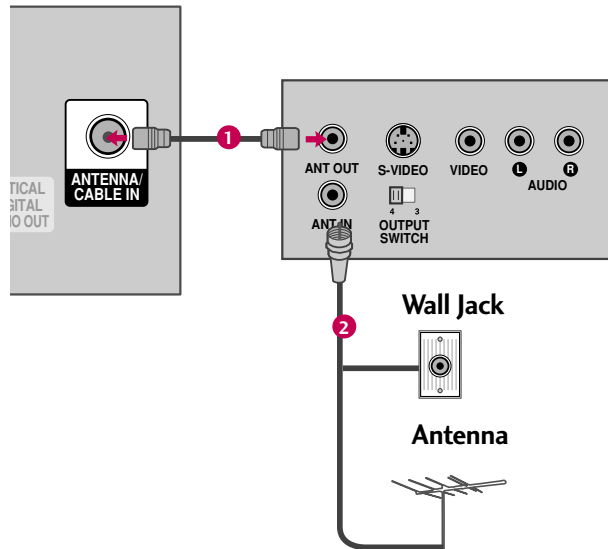

2. How to use

- Set VCR output switch to 3 or 4 and then tune Media Box to the same channel number.
- Insert a video tape into the VCR and press PLAY on the VCR. (Refer to the VCR owner's manual.)

Composite (RCA) Connection

1. How to connect

- 1 Connect the **AUDIO/VIDEO** jacks between Media Box and VCR. Match the jack colors (Video = yellow, Audio Left = white, and Audio Right = red)

2. How to use

- Insert a video tape into the VCR and press PLAY on the VCR. (Refer to the VCR owner's manual.)
- Select the **AV1** or **AV2** input source using the **INPUT** button on the remote control.

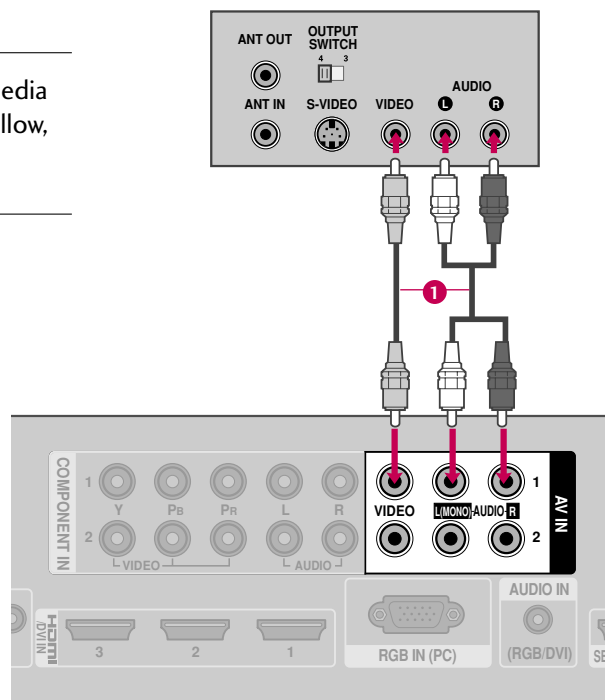

OTHER A/V SOURCE SETUP

1. How to connect

- 1 Connect the **AUDIO/VIDEO** jacks between Media Box and external equipment. Match the jack colors. (Video = yellow, Audio Left = white, and Audio Right = red)

2. How to use

- Select the **AV1** or **AV2** input source using the **INPUT** button on the remote control.
- Operate the corresponding external equipment.

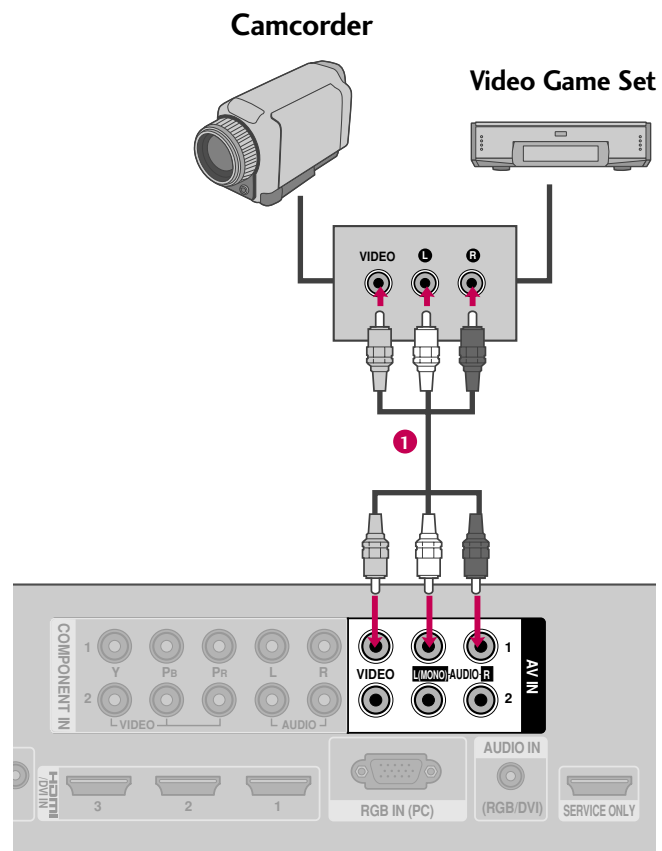

EXTERNAL EQUIPMENT SETUP

USB CONNECTION

1. How to connect

- 1 Connect the USB device to the **USB IN** jack on the Media Box.

2. How to use

- After connecting the **USB IN** jack, you use the USB function. (▶ p.58)

! NOTE

- ▶ Check USB cable over version 2.0.

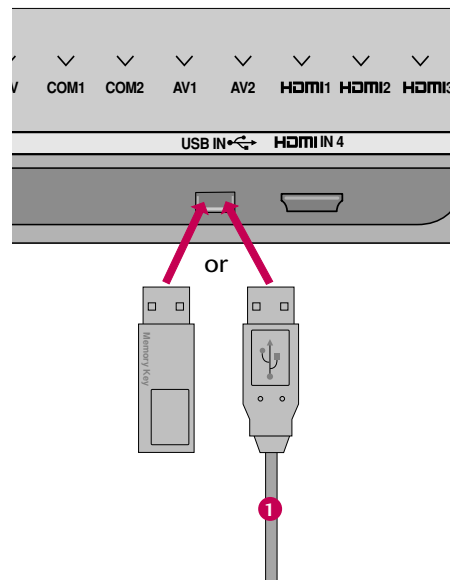

AUDIO OUT CONNECTION

Send the TV's audio to external audio equipment via the Audio Output port.

If you want to enjoy digital broadcasting through 5.1-channel speakers, connect the OPTICAL DIGITAL AUDIO OUT terminal on the back of **Media Box** to a Home Theater (or amp).

1. How to connect

- 1 Connect one end of the optical cable to the Media Box port of **OPTICAL DIGITAL AUDIO OUT**.
- 2 Connect the other end of the optical cable to the digital audio input on the audio equipment.
- 3 Set the "TV Speaker - Off" in the AUDIO menu. (▶ p.92). See the external audio equipment instruction manual for operation.

! NOTE

- ▶ When connecting with external audio equipment, such as amplifiers or speakers, you can turn the TV speakers off in the menu. (▶ p.92)
- ▶ HDMI5 input source cannot be used for AUDIO OUT.

! CAUTION

- ▶ Do not look into the optical output port. Looking at the laser beam may damage your vision.
- ▶ Audio with ACP (Audio Copy Protection) function may block digital audio output.

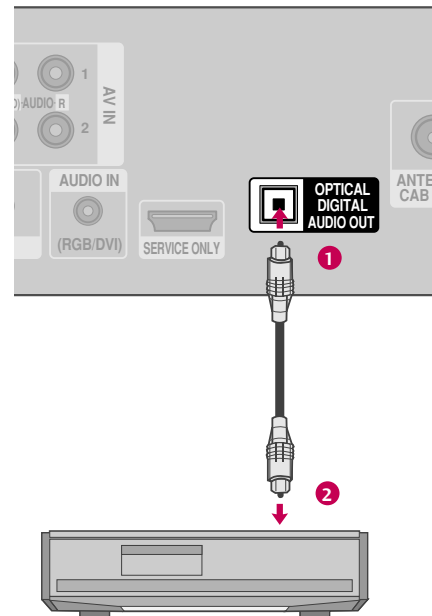

EXTERNAL EQUIPMENT SETUP

PC SETUP

This TV provides Plug and Play capability, meaning that the PC adjusts automatically to the TV's settings.

VGA (D-Sub 15 pin) Connection

1. How to connect

- 1 Connect the VGA output of the PC to the **RGB IN (PC)** jack on the Media Box.
- 2 Connect the PC audio output to the **AUDIO IN (RGB/DVI)** jack on the Media Box.

2. How to use

- Turn on the PC and the Media Box.
- Select the **RGB-PC** input source using the **INPUT** button on the remote control.

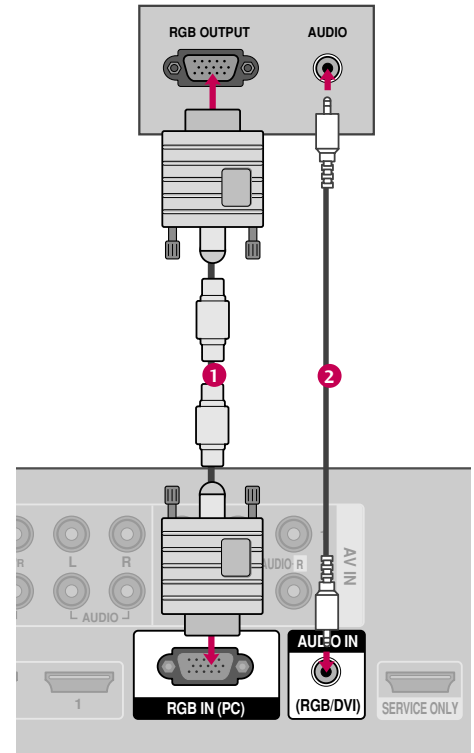

DVI to HDMI Connection

1. How to connect

- 1 Connect the DVI output of the PC to the **HDMI/DVI IN 1, 2, or 3** jack on the Media Box.
- 2 Connect the PC audio output to the **AUDIO IN (RGB/DVI)** jack on the Media Box.

2. How to use

- Turn on the PC and the Media Box.
- Select the **HDMI1, HDMI2, or HDMI3** input source using the **INPUT** button on the remote control.

NOTE

- ▶ Check HDMI cable over version 1.3. If the HDMI cables don't support HDMI version 1.3, it can cause flickers or no screen display. In this case use the latest cables that support HDMI version 1.3.

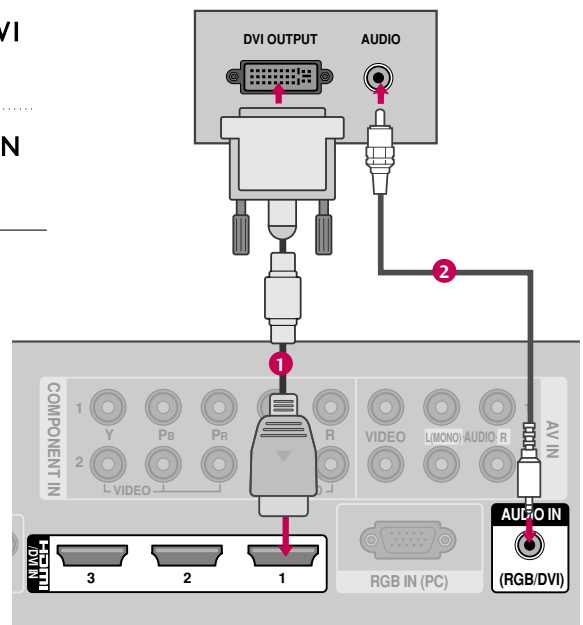

! NOTES

- ▶ To get the the best picture quality, adjust the PC graphics card to **1920x1080**.
- ▶ Depending on the graphics card, DOS mode may not work if a HDMI to DVI Cable is in use.
- ▶ In PC mode, there may be noise associated with the resolution, vertical pattern, contrast or brightness. If noise is present, change the PC output to another resolution, change the refresh rate to another rate or adjust the brightness and contrast on the PICTURE menu until the picture is clear.
- ▶ Avoid keeping a fixed image on the screen for a long period of time. The fixed image may become permanently imprinted on the screen.
- ▶ The synchronization input form for Horizontal and Vertical frequencies is separate.
- ▶ Depending on the graphics card, some resolution settings may not allow the image to be positioned on the screen properly.
- ▶ If there are overscan in HDMI-PC 1920x1080, change aspect ratio to **Just scan**.
- ▶ When selecting HDMI-PC, set the “Input Label - PC” in the OPTION menu.
- ▶ **A driver for the TV is not needed. The TV sends the required info to the graphics card.**

Supported Display Specifications (RGB-PC, HDMI-PC)

Resolution	Horizontal Frequency(KHz)	Vertical Frequency(Hz)
640x350	31.468	70.09
720x400	31.469	70.08
640x480	31.469	59.94
800x600	37.879	60.31
1024x768	48.363	60.00
1280x768	47.776	59.87
1360x768	47.712	60.015
1280x1024	63.981	60.02
1600x1200	75.00	60.00
1920x1080 RGB-PC	66.587	59.934
1920x1080 HDMI-PC	67.5	60.00

EXTERNAL EQUIPMENT SETUP

Screen Setup for PC mode





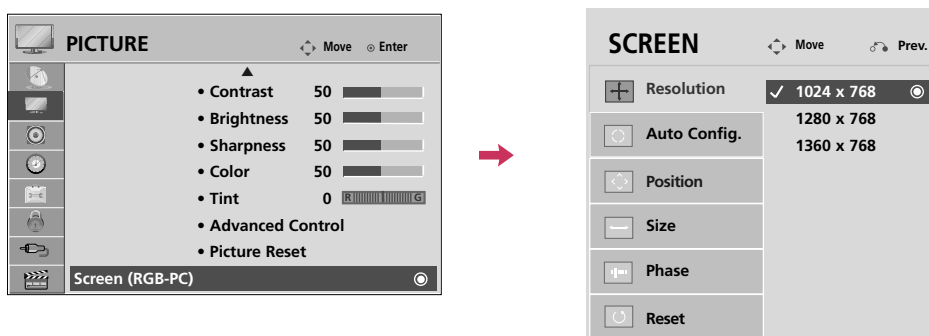

Selecting Resolution

You can choose the resolution in RGB-PC mode.

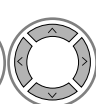
The **Position**, **Phase**, and **Size** can also be adjusted.

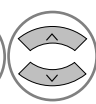
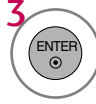
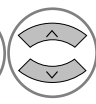
You can choose this option only when the PC resolution is set to 1024X768, 1280X768 or 1360X768.

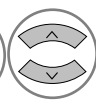







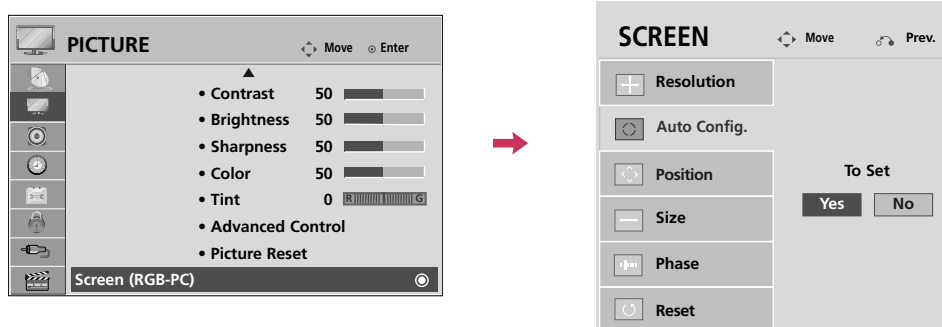

-   Select **PICTURE**.
-   Select **Screen (RGB-PC)**.
-   Select **Resolution**.
-   Select the desired resolution.
- 

Auto Configure

Automatically adjusts picture position and minimizes image instability. After adjustment, if the image is still not correct, try using the manual settings or a different resolution or refresh rate on the PC.



- 1   Select **PICTURE**.
- 2   Select **Screen (RGB-PC)**.
- 3   Select **Auto Config..**
- 4   Select **Yes**.
- 5  Start Auto Configuration.

- If the position of the image is still not correct, try Auto adjustment again.
- If picture needs to be adjusted again after Auto adjustment in RGB-PC, you can adjust the **Position**, **Size** or **Phase**.







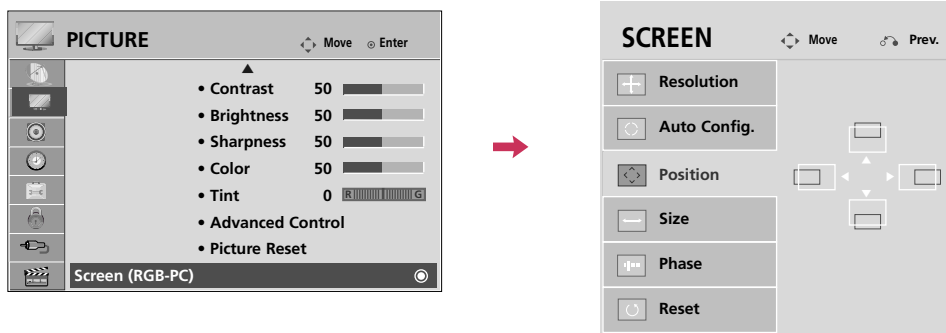

EXTERNAL EQUIPMENT SETUP

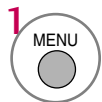
Adjustment for screen Position, Size, and Phase

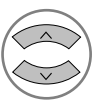
If the picture is not clear after auto adjustment and especially if characters are still trembling, adjust the picture phase manually.

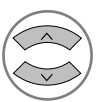
This feature operates only in RGB-PC mode.











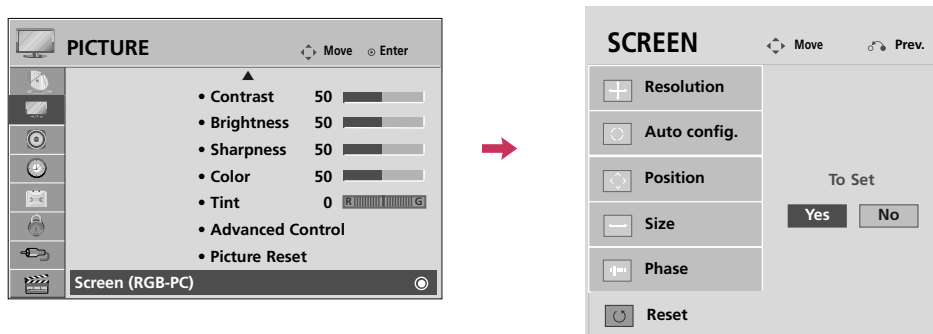

-   Select **PICTURE**.
-   Select **Screen (RGB-PC)**.
-   Select **Position, Size, or Phase**.
-   Make appropriate adjustments.
- 

- **Position:** This function is to adjust picture to left/right and up/down as you prefer.
- **Size:** This function is to minimize any vertical bars or stripes visible on the screen background. And the horizontal screen size will also change.
- **Phase:** This function allows you to remove any horizontal noise and clear or sharpen the image of characters.

Screen Reset (Reset to original factory values)

Returns **Position**, **Size**, and **Phase** to the default factory settings.
This feature operates only in RGB-PC mode.



- 1   Select **PICTURE**.
- 2   Select **Screen (RGB-PC)**.
- 3   Select **Reset**.
- 4   Select **Yes**.
- 5 

WATCHING TV / CHANNEL CONTROL

REMOTE CONTROL FUNCTIONS

When using the remote control, aim it at the remote control sensor on the TV.

- POWER**
 - When the TV and Media Box are connected, the power of both the TV and Media Box will be turned on/off.
 - When the TV and Media Box are not connected, only the power of the TV will be turned on/off.
- ON/OFF**  Illuminates the remote control buttons.
- TV** Returns to the last TV channel.
- ENERGY SAVING** Adjusts the Energy Saving setting. ▶ p.82
- AV MODE** Toggles through preset Video and Audio modes. ▶ p.54
- INPUT** Rotates through inputs. Also switches the TV on from standby. ▶ p.52
- THUMBSTICK (Up/Down/Left Right/ENTER)** Navigates the on-screen menus and adjusts the system settings to your preference.
- INFO** Displays channel information and wireless signal strength at the top of the screen. ▶ p.51
- RETURN** Allows the user to move return one step in an interactive application or other user interaction function.
- COLOR KEYS** Uses for Optional functions.
- USB, SIMPLINK Control buttons**
 - Controls USB menu (Photo List, Music List, Movie List.)
 - Controls the SIMPLINK compatible devices.
- SIMPLINK** See a list of AV devices connected to the Media Box. When you toggle this button, the SIMPLINK menu appears at the screen. ▶ p.56-57

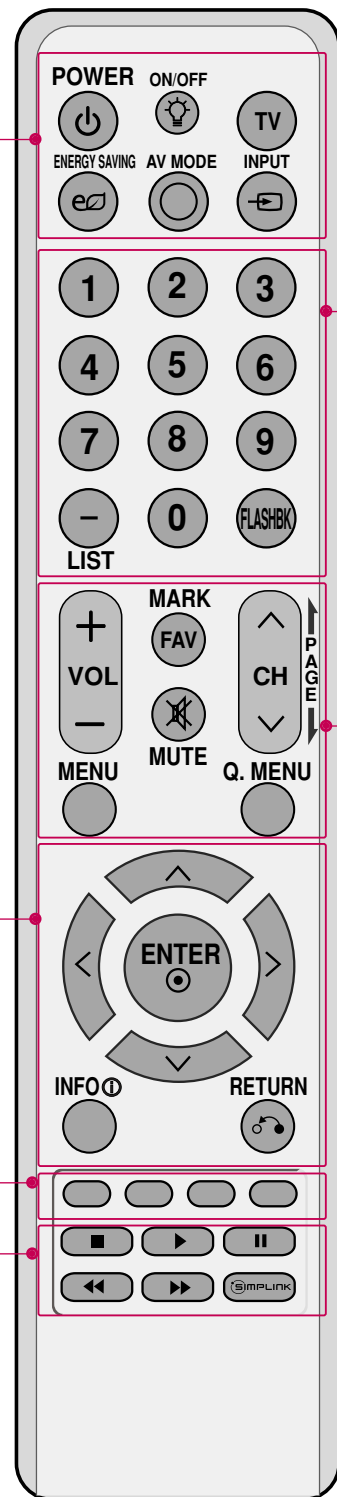

NUMBER button

- (DASH) Used to enter a program number for multiple program channels such as 2-1, 2-2, etc.
- LIST Displays the channel table. ▶ p.49
- FLASHBK Tunes to the last channel viewed.

VOLUME UP /DOWN Adjusts the volume.

- FAV Scroll through the programmed Favorite channels. ▶ p.50
- MARK Select the input to apply the Picture Wizard settings. ▶ p.75
Use to mark or unmark a photo/music/movie. ▶ p.60, 64, 68
- MUTE Switches the sound on or off. ▶ p.42
- CHANNEL UP/DOWN Changes the channel.
- PAGE UP/DOWN Moves from one full set of screen information to the next one.
- MENU Displays the main menu or clears all on-screen displays and return to TV viewing.
- Q.MENU Opens the list of Quick Menu options. ▶ p.45

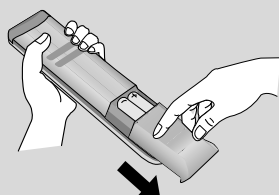
Installing Batteries

- Open the battery compartment cover on the back side and install the batteries matching correct polarity.
- Install two 1.5V AAA batteries. Don't mix old or used batteries with new ones.
- Close cover.

WATCHING TV / CHANNEL CONTROL

TURNING ON THE TV

- 1 First, connect power cord correctly and switch the **main power switch** to the on position (ON) on the TV and Media Box.

At this moment, the TV and Media Box switch to standby mode.

- In standby mode to turn TV on, press the $\phi/|$, **INPUT, CH** (\wedge or \vee) button on the TV or press the **POWER, INPUT, CH** (\wedge or \vee), **Number (0~9)** button on the remote control.

Turning on or off the TV will turn on or off the Media Box also. If the Media Box doesn't turn on automatically, adjust the Media box location. (▶ p.14-15)

- 2 This connection screen between TV and Media Box will appear.

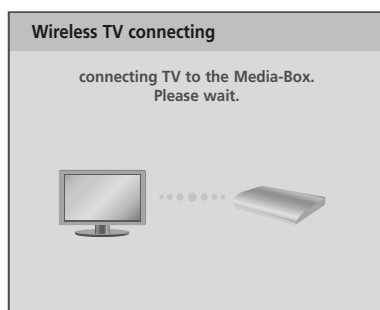

- The TV finds the Media Box using wireless connection.
- If failed wireless connection within 40 seconds, adjust the Media Box location (▶ p.14-15)

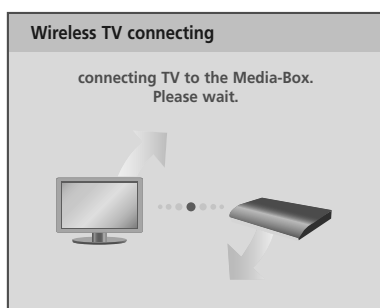

- The TV try to wireless connection.
- If failed wireless connection within 5 seconds, adjust the Media Box location (▶ p.14-15)

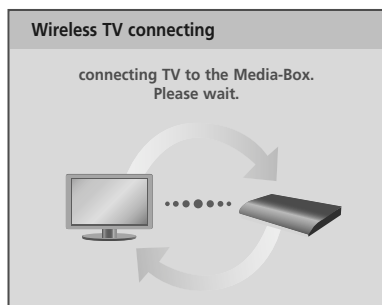

- The wireless connection is completed.

- This screen appears whenever you turn the TV.
- Connecting the TV and Media Box will **take** about 30-40 seconds.
- The screen becomes dark briefly right before the connection process is complete.