



Please read this manual carefully before operating your set.

Retain it for future reference.

Record model number and serial number of the set.

See the label attached on the bottom of the set and quote this information to your dealer when you require service.

Model number :

Serial number :

## LG DLP PROJECTOR

## BN315-JD OWNER'S MANUAL

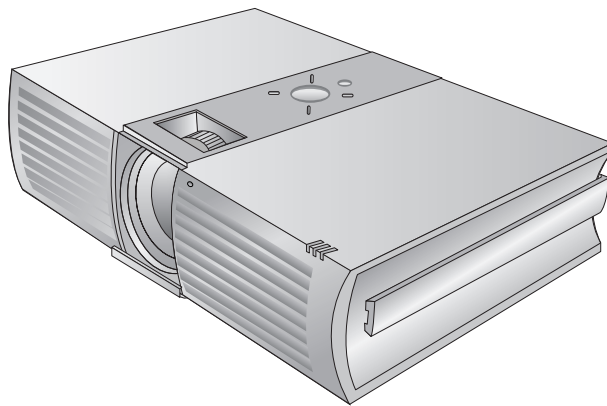

# DLP PROJECTOR

## FCC NOTICE

- **A Class A digital device**

This equipment has been tested and found to comply with the limits for a Class A digital device, pursuant to Part 15 of the FCC Rules. These limits are designed to provide reasonable protection against harmful interference when the equipment is operated in a commercial environment. This equipment generates, uses, and can radiate radio frequency energy and, if not installed and used in accordance with the instruction manual, may cause harmful interference to radio communications. Operation of this equipment in a residential area is likely to cause harmful interference in which case the user will be required to correct the interference at his own expense.

### **Warning**

This is a class A product. In a domestic environment this product may cause radio interference, in which case the user may be required to take adequate measures.

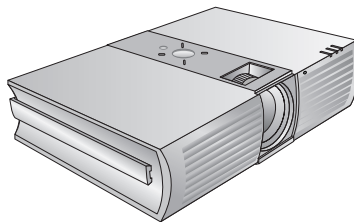

# Contents

## Introduction

Safety Instructions .....	4
---------------------------	---

## Names of parts

Main Body .....	7
Connecting Part .....	7
Control Panel .....	8
Remote Control .....	9
Installing Batteries .....	9
Projector Status Indicators .....	10
Accessories .....	11
Optional Extras .....	11

## Installing and Composition

Installation Instructions .....	12
Basic Operation of the Projector .....	13
Using Kensington Security System .....	14
Turning on the Projector .....	15
Turning off the Projector .....	15
Focus and Position of the Screen Image .....	16
Selecting source mode .....	16

## Connection

Connecting to a Desktop PC .....	17
Connecting to a Notebook PC .....	17
Connecting to a Video Source .....	17
Connecting to a DVD .....	18
Connecting to a D-TV Set-Top Box .....	18

## Function

### Video Menu Options

Adjusting Video .....	19
APC (Auto Picture Control) .....	19
Auto Color Temperature Control .....	20
Gamma Function .....	20
White Peaking Function .....	21
Color Temperature Control .....	21
Color enhancement Control .....	21

### Special Menu Options

Selecting language .....	22
Using ARC Function .....	22
Flip Horizontal Function .....	23
Flip Vertical Function .....	23
Auto Sleep Function .....	23
Using Keystone function .....	24
Using Blank function .....	24
Selecting Blank Image color .....	24
Lamp Mode Function .....	25
Checking lamp time .....	25
Using Still function .....	25

### Screen Menu Options

Auto configure Function .....	26
Manual configure .....	26
Using ZOOM function .....	27
Screen Position .....	27

### Information

Supported Monitor Display .....	28
Maintenance .....	29
Memo .....	30
Specifications .....	31

### Disposal of your old appliance



1. When this crossed-out wheeled bin symbol is attached to a product it means the product is covered by the European Directive 2002/96/EC.
2. All electrical and electronic products should be disposed of separately from the municipal waste stream via designated collection facilities appointed by the government or the local authorities.
3. The correct disposal of your old appliance will help prevent potential negative consequences for the environment and human health.
4. For more detailed information about disposal of your old appliance, please contact your city office, waste disposal service or the shop where you purchased the product.

# Safety Instructions

Please take note of the safety instructions to prevent any potential accident or misuse of the projector.

→ Safety Instructions are given in two forms as detailed below.

 **WARNING** : The violation of this instruction may cause serious injuries and even death.

 **NOTES** : The violation of this instruction may cause light injuries or damage to the projector.

→ After reading this manual, keep it in the place that the user always can contact easily.

## Indoor Installation

### WARNING

Do not place the Projector in direct sunlight or near heat sources such as radiators, fires and stove etc.

This may cause a fire hazard !

Do not place inflammable materials beside the projector

This may cause a fire hazard !

Do not allow children to hang on the installed projector.

It may cause the projector to fall, causing injury or death.

## Indoor Installation

### NOTES

Disconnect from the mains and remove all connections before moving.

Do not place the projector close to sources of steam or oil such as a humidifier.

This may create a fire hazard or an electric shock hazard !

Do not place the projector where it might be exposed to dust.

This may cause a fire hazard !

When installing the projector on a table, be careful not to place it near the edge.

This may cause the projector to fall causing serious injury to a child or adult and serious damage to the projector.

**Only use a suitable stand.**

Only use the projector on a level and stable surface.

It may become unstable and affect operation.

Ensure good ventilation around the projector. The distance between the projector and the wall should be more than 20cm/8 inches.

An excessive increase in its internal temperature may cause a fire hazard!

Do not block the vents of the projector or restrict air-flow in any way.

This would cause the internal temperature to increase and could cause a fire hazard!

Do not place the projector directly on a carpet, rug or place where ventilation is restricted.

This would cause its internal temperature to increase and might create a fire hazard !

## Outdoor Installation

### WARNING

Do not use the projector in a damp place such as a bathroom where it is likely to get wet.

This may cause a fire or an electric shock hazard !

## Power

### WARNING

Earth wire should be connected.

If the earth wire is not connected, there is a possible danger of electric shock caused by the current leakage.  
If grounding methods are not possible, a separate circuit breaker should be employed and installed by a qualified electrician.  
Do not connect ground to telephone wires, lightning rods or gas pipe.

The mains plug should be inserted fully into the power outlet to avoid a fire hazard !

This may cause a fire hazard !

Do not place heavy objects on the power cord

This may cause a fire or an electric shock hazard !

**Power**



**WARNING**

Do not use too many plugs on the Mains multi-outlet.  
It may result in overheating of the outlet and causes a fire hazard !

**Power**

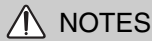

**NOTES**

Never touch the power plug with a wet hand  
This may cause an electric shock hazard !

Hold the plug firmly when unplugging. If you pull the cord the cord may be damaged.  
This may cause a fire hazard !

Prevent dust collecting on the power plug pins or outlet.  
This may cause a fire hazard !

Do not plug when the power cord or the plug is damaged or the connecting part of the power outlet is loose.  
This may cause a fire or an electric shock hazard !

Ensure the power cord does not come into contact with sharp or hot objects such as a heater.  
This may cause a fire or an electric shock hazard !

Place the projector where people will not trip or tread on the power lead.  
This may cause a fire or an electric shock hazard !

Do not turn the projector On/Off by plugging-in or unplugging the power plug to the wall outlet.  
(Do not use the power plug for switch.)  
It may cause mechanical failure or could give an electric shock.

**Using**



**WARNING**

Do not place anything containing liquid on top of the projector such as flowerpot, cup, cosmetics or candle.  
This may cause a fire hazard !

In case of impact shock or damage to the projector switch it off and unplug it from the mains outlet and contact your service center.  
This may cause a fire or an electric shock hazard !

Do not allow any objects to fall into the projector.  
This may cause an electric shock hazard !

If water is spilt into the projector unplug it from the mains supply outlet immediately and consult your Service Agent.  
This may cause an electric shock hazard !

Dispose of used batteries carefully and safely.  
In the case of a battery being swallowed by a child please consult a doctor immediately.

In the event that an image does not appear on the screen please switch it off and unplug it from the mains supply and contact your Service Agent.  
This may cause a fire or an electric shock hazard !

Do not remove any covers (except lens cover). High risk of Electric Shock!

Don't look directly onto the lens when the projector is in use. Eye damage may occur!

Do not touch metal parts during or soon after operation since the vents and lamp cover will remain very hot!

**CAUTION concerning the Power Cord**

Most appliances recommend they be placed upon a dedicated circuit; that is, a single outlet circuit which powers only that appliance and has no additional outlets or branch circuits. Check the specification page of this owner's manual to be certain.

Do not overload wall outlets. Overloaded wall outlets, loose or damaged wall outlets, extension cords, frayed power cords, or damaged or cracked wire insulation are dangerous. Any of these conditions could result in electric shock or fire. Periodically examine the cord of your appliance, and if its appearance indicates damage or deterioration, unplug it, discontinue use of the appliance, and have the cord replaced with an exact replacement part by an authorized servicer.

Protect the power cord from physical or mechanical abuse, such as being twisted, kinked, pinched, closed in a door, or walked upon. Pay particular attention to plugs, wall outlets, and the point where the cord exits the appliance.

**Using**

 **WARNING**

Never touch the wall outlet when there is leakage of gas, open the windows and ventilate.

It can cause a fire or a burn by a spark.

Do not drop the projector or allow impact shock.

This may cause mechanical failure or personal injury !

Don't look at laser beam directly as it can cause eye damage!

**Using**

 **NOTES**

Do not place heavy objects on top of projector.

This may cause mechanical failure or personal injury!

Take care not to cause impact to the lens particularly when moving the projector.

Do not touch the lens of the projector. It is delicate and easily damaged.

Do not use any sharp tools on the projector as this will damage the casing.

**Cleaning**

 **WARNING**

Do not use water while cleaning the projector

This may cause damage to the projector or an electric shock hazard.

In the unlikely event of smoke or a strange smell from the projector, switch it off , unplug it from the wall outlet and contact your dealer or service centre.

This may cause a fire or an electric shock hazard !

Use an air spray or soft cloth that is moist with a neutral detergent and water for removing dust or stains on the projection lens.

**Cleaning**

 **NOTES**

Contact the Service Center once a year to clean the internal parts of the projector.

Accumulated dust can cause mechanical failure.

Unplug this product from the wall outlet before cleaning. Do not use liquid cleaners or aerosol cleaners.

This may cause damage to the Projector or cause an electric shock hazard !

**Others**

 **WARNING**

Do not attempt to service the projector yourself. Contact your dealer or service centre.

This may cause damage to the projector and could give an electric Shock as well as invalidating the warranty !

**Others**

 **NOTES**

Be sure to unplug if the projector is not to be used for a long period.

Accumulated dust may cause a fire hazard!

Refer lamp servicing to qualified service personnel.

Do not mix new batteries with old batteries.

This may cause the batteries to over-heat and leak.

Only use the specified type of battery.

This could cause damage to the remote control.

# Names of parts

## Main Body

- \* The projector is manufactured using high-precision technology. You may, however, see on the Projector screen tiny black points and/or bright points (red, blue, or green). This can be a normal result of the manufacturing process and does not always indicate a malfunction.

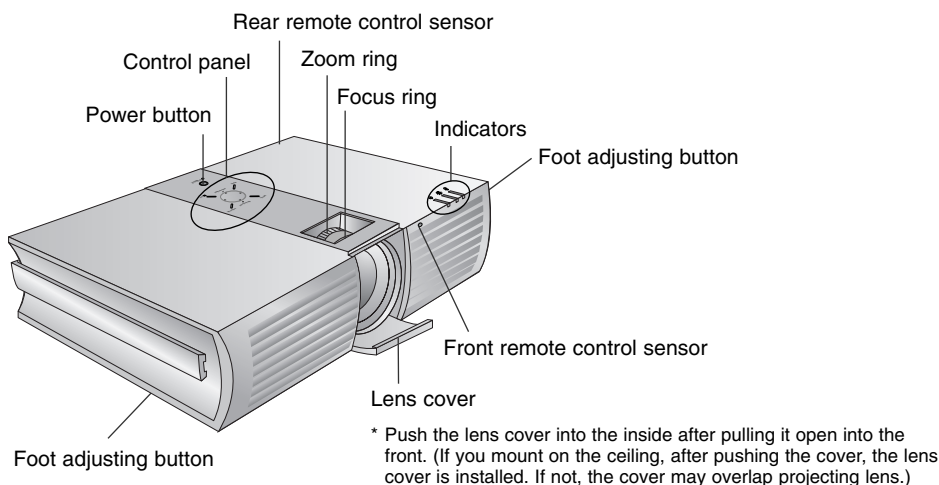

## Connecting Part

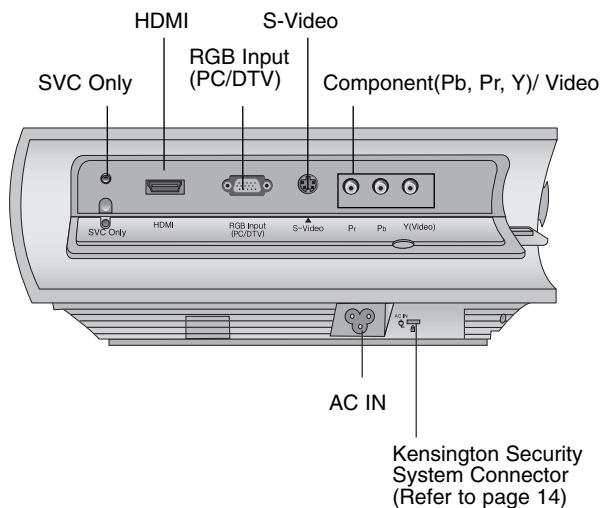

Control Panel

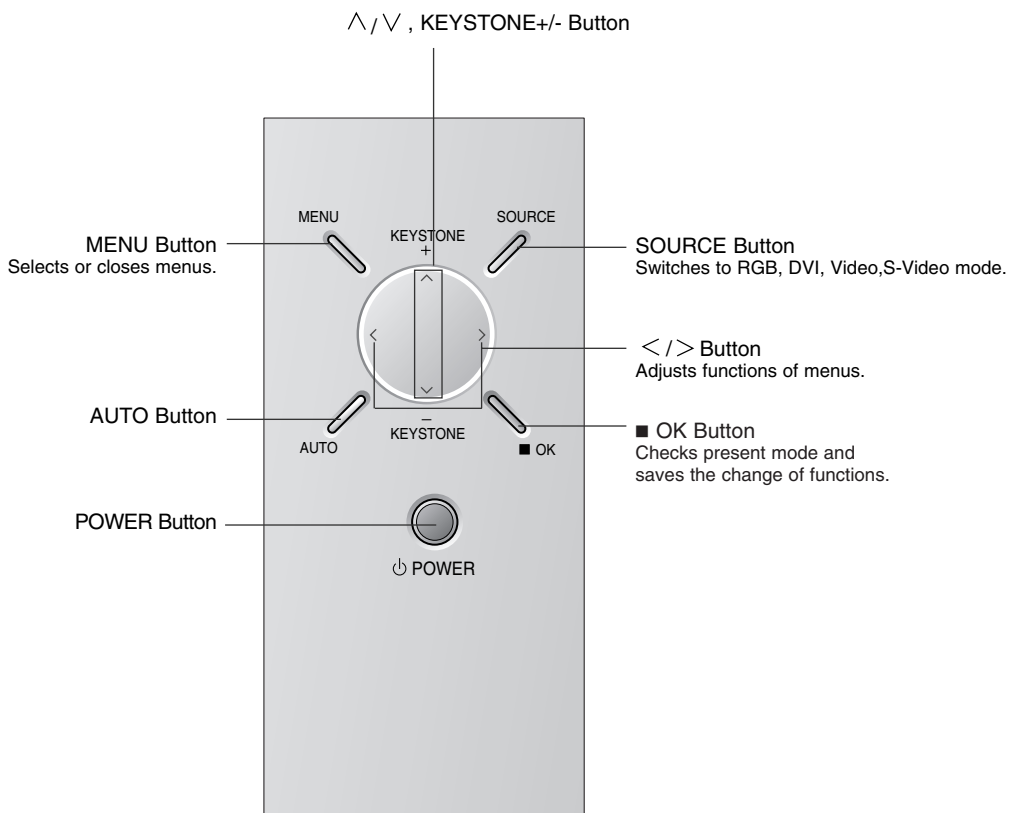



## Remote Control

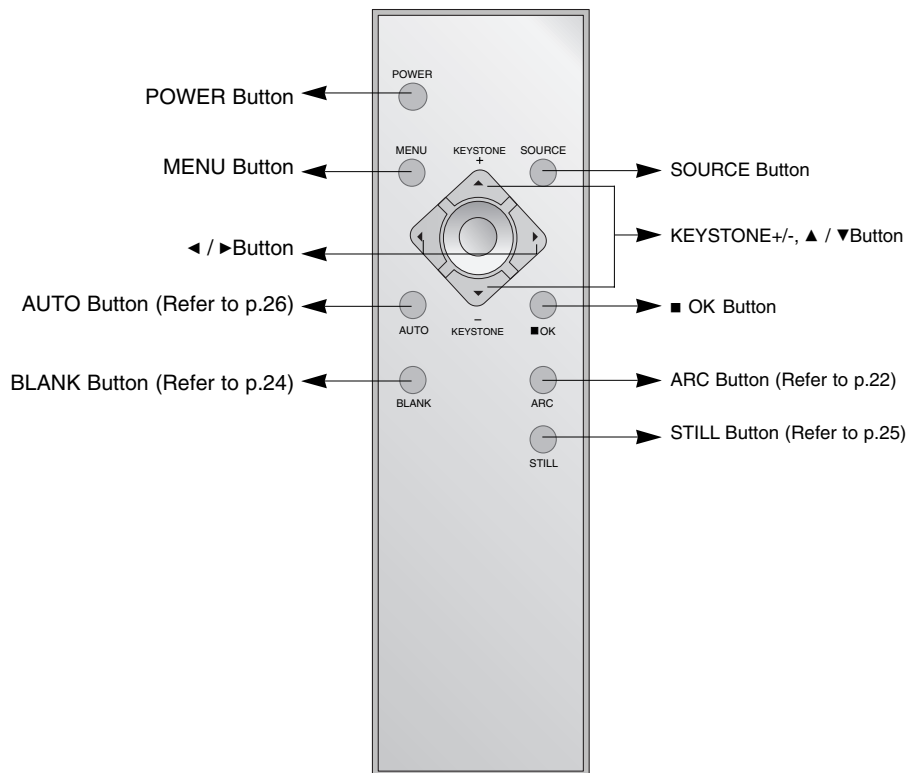

## Installing Batteries

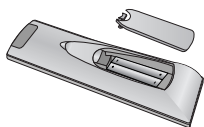

- Open the battery compartment cover on the back of the remote control and insert the batteries with correct polarity, match “+” with “+”, and match “-” with “-”.
- Install two 1.5V “AAA” batteries.  
Don't mix used batteries with new batteries.

## Projector Status Indicators

\* Lamp Indicator, operation indicator and temperature indicator at the top of the projector show the user the operating status of the projector.

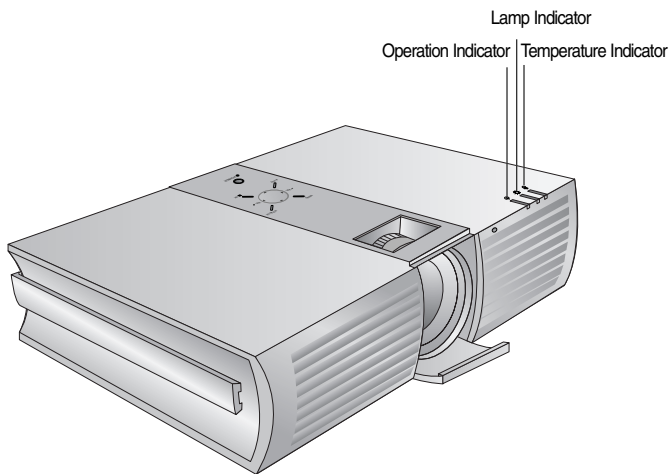

Operation Indicator	Orange	Standby.
	Green(flashing)	Lamp cooling until the lamp turn on.
	Green	On operation. (Turn on the lamp)
	Orange(flashing)	Projector lamp is cooling as power out (2 minutes)
	Off	Power off.
Lamp Indicator	Red	Projector lamp is reaching the end of its life and needs to be replaced with a new lamp. (over 2000 hours)
	Red(flashing)	The projector has trouble in the lamp or around it at power-on. Retry Power On again later. If lamp indicator is red (flashing) again, contact the service center.
	Green(flashing)	The lamp cover is not closed.
Temperature Indicator	Orange	This projector is in high temperature. Turn the power of projector off and check the ventilator.
	Red	The projector is turned off as its high temperature.
	Red (flashing)	Power has turned off due to problem with the internal cooling fan. Contact your service center.

**Accessories**



Remote Control

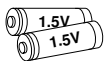

2 Batteries (size AAA)



Operating guide



Power Cord



Video Cable

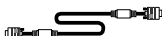

Computer Cable

**Optional Extras**

- \* Contact your dealer to purchase these items.
- \* When applying a ceiling installer, use only the ceiling installer for projector.
- \* Contact your service personnel for replacing a new lamp.
- \* Projector lamp is reaching the end of its life and needs to be replaced with a new lamp.

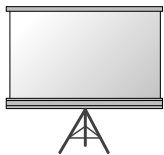

Projection Screen



Lamp



SCART to RCA jack (option)



Audio Cable



RCA to PC Audio Cable



Portable Bag

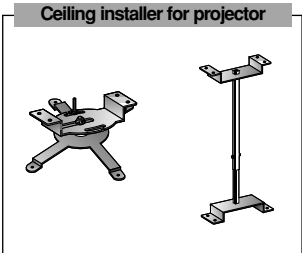

S-Video Cable



DVI-D Cable



RS-232C Cable

# Installation and Composition

## Installation Instructions

\* Don't place the projector in the following conditions. It may cause malfunction or product damage.

### ● Provide proper ventilation for this projector.

●The projector is equipped with ventilation holes(intake) on the bottom and ventilation holes(exhaust) on the front. do not block or place anything near these holes, or internal heat build-up may occur, causing picture degradation or damage to the projector.

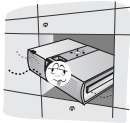

●Do not place the projector on a carpet, rug or other similar surface. It may prevent a adequate ventilation of the projector bottom. This product should be mounted to a wall or ceiling only.



●Never push projector or spill liquid of any kind into the projector.



●Leave an adequate distance(30cm/12 inches or more) around the projector.



### ● Place this projector in adequate temperature and humidity conditions.

● Install this projector only in a location where adequate temperature and humidity is available. (refer p.31)

### ● Don't place the projector where it can be covered with dust.

● This may cause overheating of the projector.

### ● Do not obstruct the slots and openings of the projector. This may cause overheating and create a fire hazard.

● The projector is manufactured using high-precision technology. You may, however, see tiny black points and/or bright points (red, blue, or green) that continuously appear on the projector Screen. This is a normal result of the manufacturing process and does not indicate a malfunction.

● To display DTV programs, it is necessary to connect a DTV receiver (Set-top Box) and connect it to the projector.

● If there is no input signal, the Menu will not be displayed on screen.

## Basic Operation of the Projector

1. Place the projector on a sturdy and horizontal surface with the PC or AV source.
2. Place the projector the correct distance from the screen. The distance between the projector and the screen determines the actual size of the image.
3. Position the projector so that the lens is set at a right angle to the screen. If the projector is not set at a right angle, the screen image will be crooked. If this is so then the keystone adjustment may correct this (Refer to page 24.)
4. Connect the cables of the projector to a wall power socket and other connected sources.

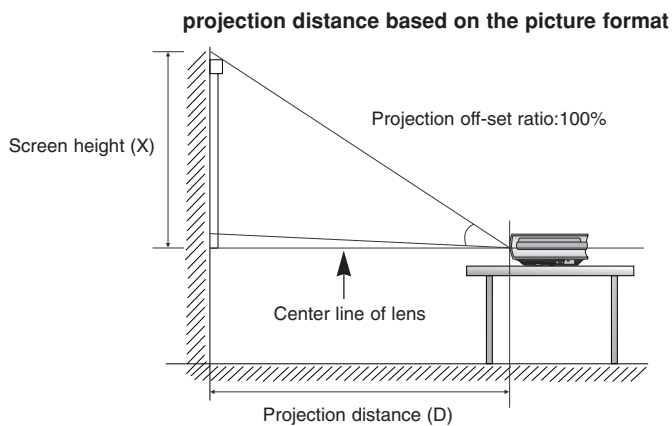

4:3 picture format								mm/ inches	
screen size	40"	60"	80"	90"	100"	110"	120"	150"	200"
screen height (X)	610/24.0	914/36.0	1219/48.0	1372/54.0	1524/60.0	1676/66.0	1829/72.0	2286/90.0	3048/120.0
The shortest distance (D)	1265/50	1908/75	2552/100	2873/113	3195/126	3517/138	3839/151	4804/189	6412/252
The longest distance (D)	1518/60	2290/90	3062/121	3448/136	3834/151	4220/166	4606/181	5765/227	7695/303

\* The longest/shortest distance show status when adjusted by the zoom function.

### Using Kensington Security System

- The projector has a 'Kensington' Security System Connector on the back panel. Connect the 'Kensington' Security system cable as below.
- For the detailed installation and use of the Kensington Security System, refer to the user's guide attached to the Kensington Security System set.  
And for further information, contact <http://www.kensington.com>, the internet homepage of the Kensington company that deals with expensive electronic equipments such as notebook PCs or projectors.
- Kensington Security System is an optional item.

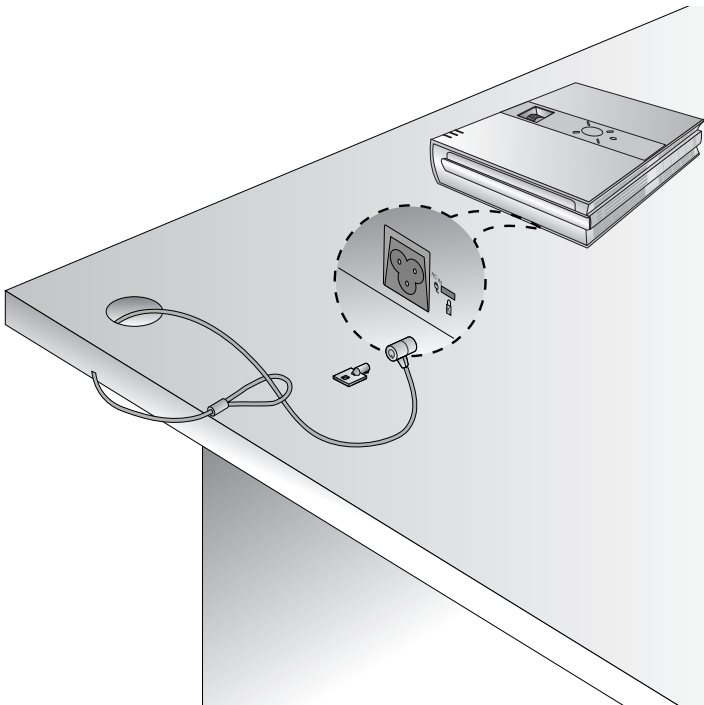

## Turning on the Projector

1. Connect power cord correctly.
2. Remove the lens cover of the projector.
3. Press the **POWER** button on the remote control or top cover.  
(Green operation indicator flashes during cooling of the lamp.)
  - It will take about 12 second to display the picture after power on because the projector lamp has to warm up.
  - An image will appear after the operation indicator light turns (Green).
  - Select the source mode with the SOURCE button.
  - Leave the projector plugged in for at least 2 minutes after switching off the projector, as this will allow the lamp cooling to continue which will help to preserve the lamp life.

### Note!

\* Don't unplug the power cord while the ventilation fan (inlet/outlet) is working. If so, you take longer time by lamp on.

## Turning off the Projector

1. Press the **POWER** button on the top cover or remote control.
2. Press the **POWER** button on the top cover or remote control again to cut off the power.
3. If the operation indicator LED is orange and blinking, do not disconnect the mains supply until the operation indicator LED is lit up constantly (orange).
  - If the operation indicator LED is orange and blinking, the power button on the top cover or on the remote control will not operate.

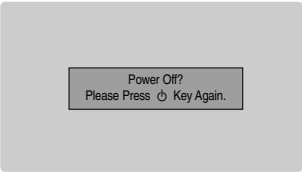

Power Off?  
Please Press  Key Again.

## Focus and Position of the Screen Image

When an image appears on the screen, check if it is in focus and fits well to the screen.

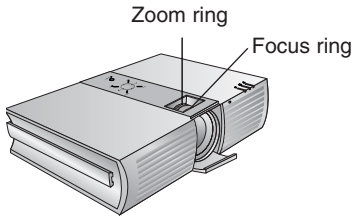

- To adjust the focus of the image, rotate the focus ring which is the outer ring on the lens.
- To adjust the size of the image, rotate the zoom ring which is the inner ring on the lens.

To raise or lower the image on the screen, extend or retract the foot at the bottom of the projector by pushing foot adjuster button as below.

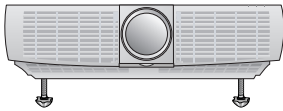

1. While pressing the foot adjuster button, raise or lower the projector to place the screen image in the proper position.
2. Release the button to lock the foot in its new position.
3. To fine-tune the height of the projector, rotate the front foot to raise or lower it.  
After raising the front foot, do not press down on the projector.

## Selecting source mode

1. Press the **SOURCE** button.



2. Each press of the ◀, ▶ button changes the display as below.

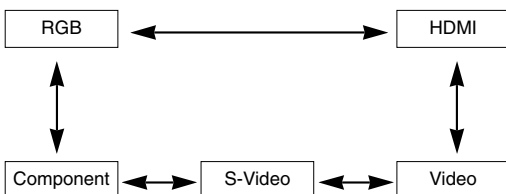



# Connection

## Connecting to a Desktop PC

- \* You can connect the projector to a computer of VGA, SVGA, XGA and SXGA output.
- \* You can use ARC function for the RGB signals of the Aspect Ration 4:3. (For HD wide input signals, you cannot use ARC function.)
- \* Fundamentally, HD wide input signal is not included in the Spec, so the set may not support HD signal perfectly.
- \* Refer to page 28 for the supported pc graphic card displays of the projector.

### < How to connect >

Connect computer cable to **RGB Input (PC/DTV)** of the projector.

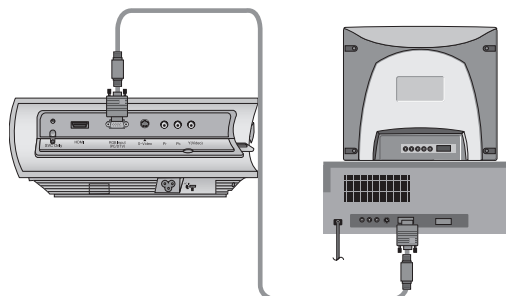

## Connecting to a Notebook PC

### < How to connect >

Connect computer cable to **RGB Input (PC/DTV)** of the projector.

- \* If you set your computer, such as a notebook type IBM PC/AT compatible, to output the signal to both the display of your computer and the external monitor, the picture of the external monitor may not appear properly. In such cases, set the output mode of your computer to output the signal only to the external monitor. For details, refer to the operating instructions supplied with your computer.

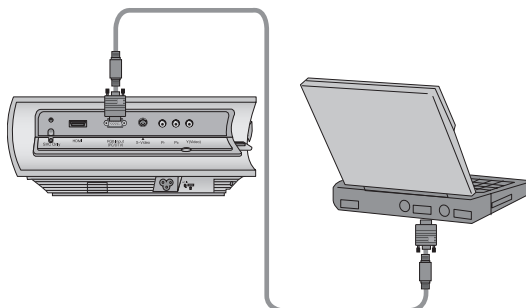

## Connecting to a Video Source

- \* You can connect a VTR, a camcorder, a LDP or any other compatible video image source to the projector.

### < How to connect 1 >

- a. Connect the Video input jacks of the projector to the output jacks of the A/V source with Video cable.

### < How to connect 2 >

- b. Connect the S-Video input jack of the projector to the S-Video output jack of an A/V source with an S-Video cable.
  - \* You can get better picture quality when connecting S-Video source to the projector.

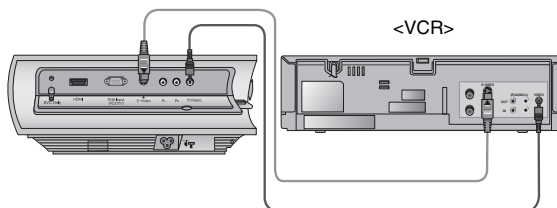

## Connecting to a DVD

\* The output jacks (Y, Pb, Pr) of the DVD might be labelled as Y, Pb, Pr / Y, B-Y, R-Y / Y, Cb, Cr according to the equipment.

### < How to connect >

a. Connect the DVD Component cable to **Component Pb, Pr, Y** of the projector.

\* When connecting the component cable, match the jack colors with the component cable. (Y=green, Pb=blue, Pr=red)

b. Use a DVD with Component 480i(576i)/480p(576p) mode.

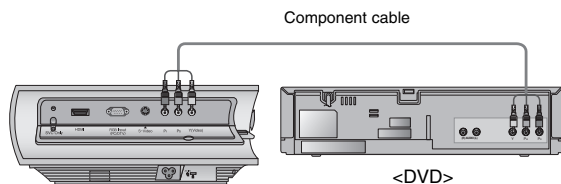

## Connecting to a D-TV Set-Top Box

\* To receive D-TV programmes, it is necessary to purchase a D-TV receiver (Set-Top Box) and connect it to the projector.

\* Please refer to the owner's manual of the D-TV Set-Top Box for the connection between projector and D-TV Set-Top Box.

### < How to connect an RGB source >

a. Connect computer cable to **RGB Input (PC/DTV)** of the projector.

b. Use a DTV receiver with DTV 480p(576p)/720p/1080i mode.

\* It can be supported the DVI/HDCP.

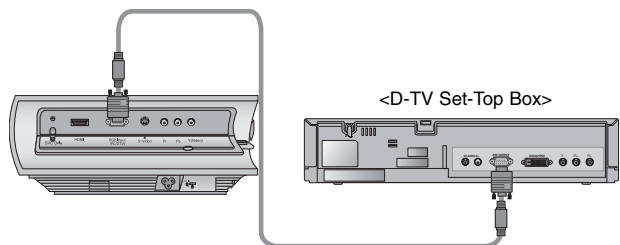

### < How to connect a Component source >

a. Connect the D-TV Set-Top Box Component cable to **Component Pb, Pr, Y** of the projector.

\* When connecting the component cable, match the jack colors with the component cable. (Y=green, Pb=blue, Pr=red)

b. Use a DTV receiver with DTV 480p(576p)/720p/1080i mode.

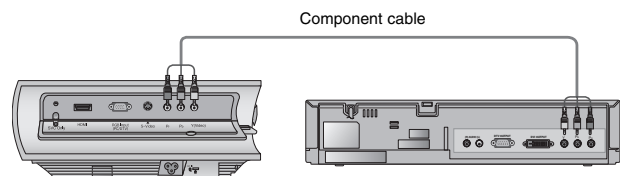

# Function



\* In this manual, the OSD(On Screen Display) may be different from your Projector's because it is just example to help with the Projector operation.

\* If there is no input signal present, the Menu will not be displayed on the screen.

\* This operating guide explains operation of RGB(PC) mode mainly.

## Video Menu Options

### Adjusting Video

1. Press the **MENU** button and then use ▲, ▼ button to select the  menu.
2. Press the ► button and then use ▲, ▼ button to select a video item you want to adjust.
3. Press the ◀, ▶ button to adjust the screen condition as you want.
4. Press the **OK** button to save.
  - Each adjustment of  menu options will not affect other input source. As required, re-adjust  menu options for the following input source : Video/S-Video/Component (480i(576i)), Component (480p(576p), 720p, 1080i)
  - To restore the original image condition after changing it, press **OK** button after selecting [**Reset**] item.
  - In the broadcasting system NTSC, the picture item **Tint** is displayed and can be adjusted.
  - To exit the menu display, repeatedly, press the **MENU** button.

< RGB mode >

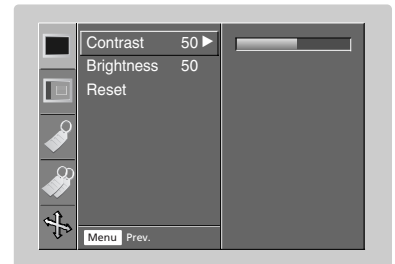

< Video mode >

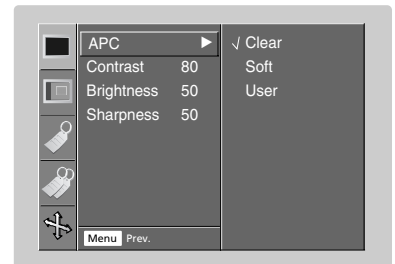

### APC (Auto Picture Control)

\* Use APC to set the projector for the best picture appearance.

\* This function will not work in RGB mode.

1. Press the **MENU** button and then use ▲, ▼ button to select the  menu.
2. Press the ► button and then use ▲, ▼ button to select **APC** item.
3. Press the ► button and then use ▲, ▼ button to adjust the screen condition as you want.
4. Press the **OK** button to save.

- Each press of the ▲, ▼ button changes the screen as shown below.

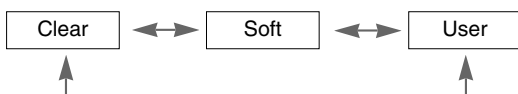

- To exit the menu display, repeatedly, press the **MENU** button.

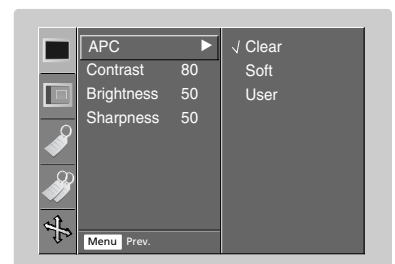

### Auto Color Temperature Control

- To initialize values (reset to default settings), select the **Normal** option.

1. Press the **MENU** button and then use ▲, ▼ button to select the  menu.
2. Press the ► button and then use ▲, ▼ button to select **ACC** item.
3. Press the ► button and then use ▲, ▼ button to make appropriate adjustments.
4. Press the **OK** button to save.

- Each press of the ▲, ▼ button changes the screen as shown below.

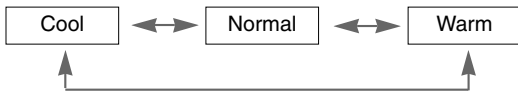

- To exit the menu display, repeatedly, press the **MENU** button.

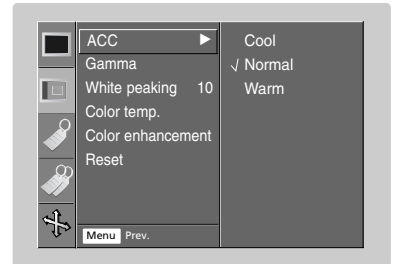

### Gamma Function

1. Press the **MENU** button and then use ▲, ▼ button to select the  menu.
2. Press the ► button and then use ▲, ▼ button to select **Gamma** item.
3. Press the ► button and then use ▲, ▼ button to adjust the screen condition as you want.
4. Press the **OK** button to save.

- Each press of the ▲, ▼ button changes the screen as shown below.



- To exit the menu display, repeatedly, press the **MENU** button.

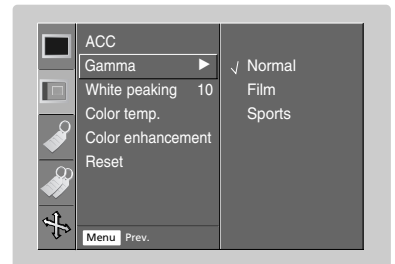

## White peaking Function

1. Press the **MENU** button and then use ▲, ▼ button to select the  menu.
2. Press the ► button and then use ▲, ▼ button to select **White peaking** item.
3. Press the ◀, ▶ button to adjust the screen condition as you want.
4. Press the **OK** button to save.
  - It's available to adjust [White peaking] in RGB(PC) and HDMI(DVI) mode only.
  - The default value may changed based on input mode.
  - Adjust to higher value to see the bright picture and adjust to lower value to see the quality picture.
  - To exit the menu display, repeatedly, press the **MENU** button.

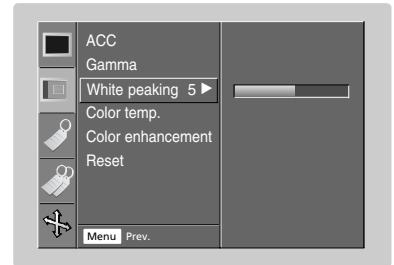

## Color Temperature Control

\* You can adjust color to any color temperature you prefer.

1. Press the **MENU** button and then use ▲, ▼ button to select the  menu.
2. Press the ► button and then use ▲, ▼ button to select **Color temp.** item.
3. Press the ► button and then use ▲, ▼ button to select **Gain R, Gain G, Gain B** or **Offset R, Offset G, Offset B**.
4. Use the ◀, ▶ button to make appropriate adjustments.
  - The **Gain R, Gain G, Gain B** adjustment range is 0 ~ 100.
  - The **Offset R, Offset G, Offset B** adjustment range is -50 ~ +50.
5. Press the **OK** button to save.
  - To exit the menu display, repeatedly, press the **MENU** button.

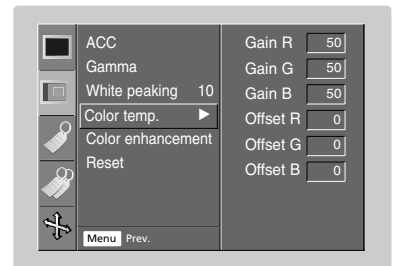

## Color enhancement Control

\* You can adjust color to any color enhancement you prefer.

1. Press the **MENU** button and then use ▲, ▼ button to select the  menu.
2. Press the ► button and then use ▲, ▼ button to select **Color enhancement** item.
3. Press the ► button and then use ▲, ▼ button to select **Color, Red, Green** or **Blue, Yellow, Cyan, Magenta**.
4. Use the ◀, ▶ button to adjust the screen condition as you want.
  - The adjustment range of **Color, Red, Green** and **Blue, Yellow, Cyan, Magenta** is 0- 100.
5. Press the **OK** button to save.
  - To exit the menu display, repeatedly, press the **MENU** button.

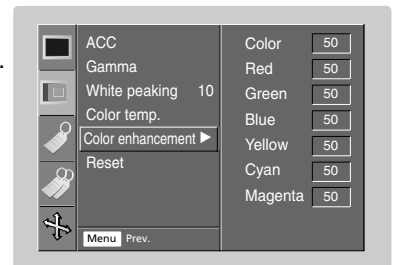

## Reset (Reset to original factory value)

- To restore the original image condition after changing it, press **OK** button after selecting [**Reset**] item.

## Special Menu Options

### Selecting Language

1. Press the **MENU** button and then use ▲, ▼ button to select the  menu.
2. Press the ► button and then use ▲, ▼ button to select **Language** item.
3. Press the ► button and then use ▲, ▼ button to select the language you want to use.
4. Press the **OK** button to save.
  - On-Screen-Display (OSD) is marked in the selected language from this point.
  - To exit the menu display, repeatedly, press the **MENU** button.



### Using ARC Function

1. Press the **ARC** button.  
Each press of the button changes the display as below.

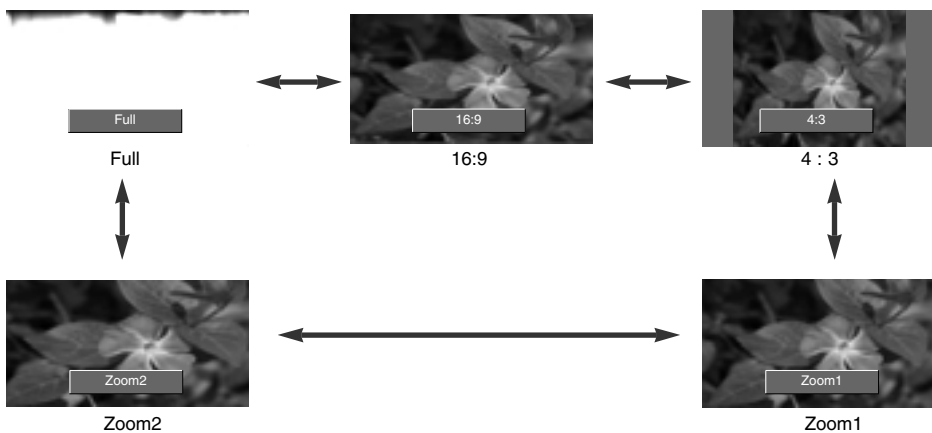

#### Note!

You can also use this function by using the **MENU** button.

### Flip horizontal Function

\* This function reverses the projected image horizontally.  
Use this function when rear projecting an image.

1. Press the **MENU** button and then use ▲, ▼ button to select the  menu.
2. Press the ► button and then use ▲, ▼ button to select **Flip horizontal** item.
3. Press the ► button to see reversed image.

- Each time you press the ► button, the image will be reversed.
- To exit the menu display, repeatedly, press the **MENU** button.

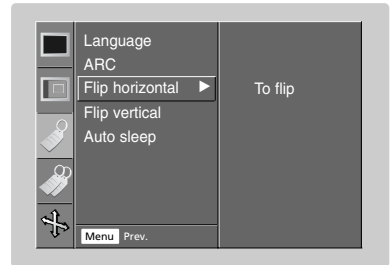

### Flip Vertical Function

\* This function reverses the projected image vertically.  
\* When you hang the projector upside down from the ceiling, you will need to reverse the image vertically and horizontally.

1. Press the **MENU** button and then use ▲, ▼ button to select the  menu.
2. Press the ► button and then use ▲, ▼ button to select **Flip Vertical** item.
3. Press the ► button to see reversed image.

- Each time you press the ► button, the image will be reversed.
- To exit the menu display, repeatedly, press the **MENU** button.



### Auto sleep Function

\* The sleep timer turns the projector off at the preset time.

1. Press the **MENU** button and then use ▲, ▼ button to select the  menu.
2. Press the ► button and then use ▲, ▼ button to select **Auto sleep** item.
3. Press the ► button and then use ▲, ▼ button to select the wanted preset time.
4. Press the **OK** button to save.

- To exit the menu display, repeatedly, press the **MENU** button.

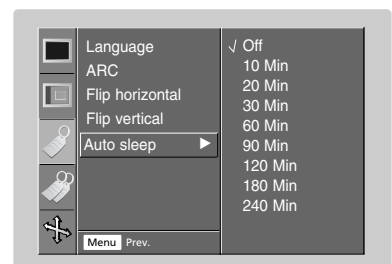

## Special Menu Options

### Using Keystone function

- \* Use this function when the screen is not at a right angle to the projector and the image is a trapezoid shape.
- \* Only use the **Keystone** function when you can't get the best angle of projection, because it may cause a blazing fire of the screen.

1. Press the **KEYSTONE +** or **KEYSTONE -** button.
2. Press the **KEYSTONE +** or **KEYSTONE -** button to adjust the screen condition as you want.
  - **Keystone** are adjusted from -20 to +20.
  - You can also use this function by using the **MENU** button.

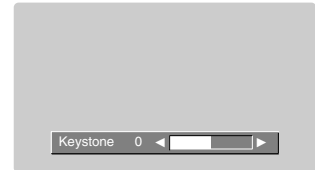

### Using Blank function

- \* This function may be effective if you need to get attention of the audience during presentations, meetings or briefings.

1. Press the **BLANK** button.
  - The screen turns off to a background color.
  - You can choose the background color.  
(Refer to 'Selecting blank image color')
2. Press any button to cancel the blank function.

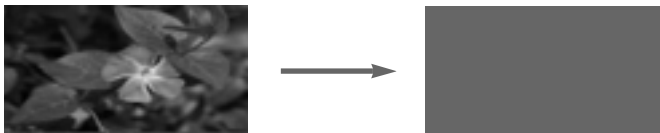

### Selecting Blank image color

1. Press the **MENU** button and then use **▲**, **▼** button to select the  menu.
2. Press the **▶** button and then use **▲**, **▼** button to select **Blank image** item.
3. Press the **▶** button and then use **▲**, **▼** button to select the color you want to use.
4. Press the **■OK** button to save.
  - Background color will be changed to the selected Blank function color from this point.
  - To exit the menu display, repeatedly, press the **MENU** button.

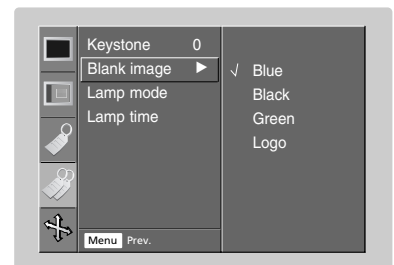



## Lamp mode Function

1. Press the **MENU** button and then use ▲, ▼ button to select the  menu.
2. Press the ► button and then use ▲, ▼ button to select **Lamp mode** item.
3. Press the ► button and then use ▲, ▼ button to select **Normal mode** or **Silent mode**.
4. Press the **OK** button to save.
  - To exit the menu display, repeatedly, press the **MENU** button.

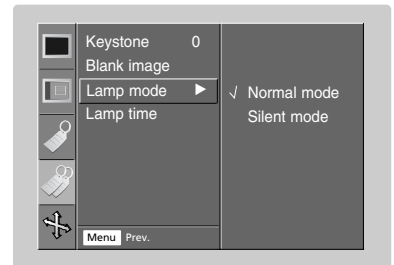

## Checking Lamp time

1. Press the **MENU** button and then use ▲, ▼ button to select the  menu.
  2. Press the ► button and then use ▲, ▼ button to select **Lamp time** item.
    - The used lamp time is displayed.
    - When projector lamp is reaching the end of its life (over 4000 hours), the lamp indicator will be turned red.
    - The lamp warning LED illuminates red continuously in the case of excessive lamp time.
- To exit the menu display, repeatedly, press the **MENU** button.

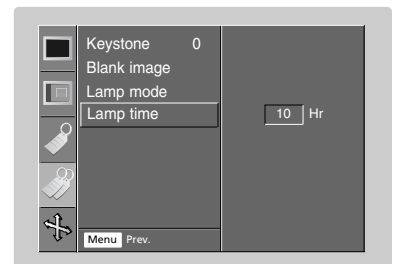

## Using Still function

1. Press the **STILL** button.
  - \* You can freeze the input image.

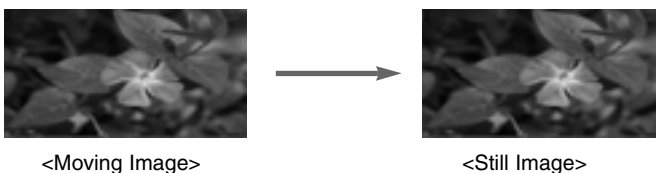

2. To exit Pause, press any button .
  - \* The STILL function would release automatically after about 10 minutes.

## Screen Menu Options

### Auto configure Function

- \* This function assures you of getting the best video quality by automatically adjusting the difference of horizontal size and synchronization of the image.
- \* Auto Tracking function works in RGB input only.

1. Press the **AUTO** button.
  - Image positioning and synchronization are automatically adjusted.
2. Adjust **Manual configure** in  menu after operation of **Auto configure** if you want to get better picture quality in accordance with diverse PC input modes. In certain circumstances, you can't get the best picture quality only with auto-correction.

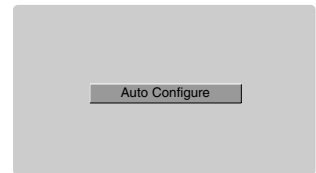

### Note!

You can also use this function by using the MENU button. (Only in RGB mode)  
For best results, perform this function while displaying a still image.

### Manual configure

- \* It's available to adjust [Manual Configure] in RGB mode only.
- \* **Phase Function**  
This function is for the detailed adjustment of the clock function.
- \* **Clock Function**  
This function adjusts the horizontal width of the projected image to get the image to fit on the screen size.

1. Press the **MENU** button and then use **▲**, **▼** button to select the  menu.
2. Press the **▶** button and then use **▲**, **▼** button to select **Manual configure** item.
3. Press the **▶** button and then use **▲**, **▼** button to select **Phase**, **Clock**, **H Position** or **V Position**.
4. Press the **◀**, **▶** button to adjust the screen condition.
  - The **Phase** adjustment range is 0 ~ 63.
  - The **Clock** adjustment range is -50 ~ +50.
  - Based on the input mode, the adjustment range may be changed.
5. Press the **■OK** button to save.
  - To exit the menu display, repeatedly, press the **MENU** button.

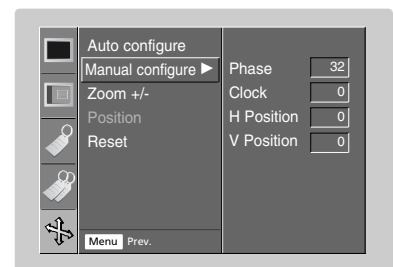

## Using ZOOM function

1. Press the **MENU** button and then use ▲, ▼ button to select the  menu.
2. Press the ► button and then use ▲, ▼ button to select **Zoom +/-** item.
3. Press the ► button and then use ◀, ▶ button to zoom in or out the picture size condition as you want.
  - **Zoom +/-** - adjustment range is 100% ~ 250%.
  - To exit the menu display, repeatedly, press the **MENU** button.

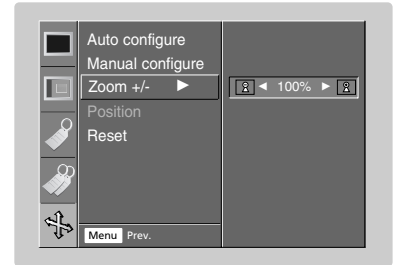

## Screen Position

\* You are available o this function after adjusting Zoom +/-.

1. Press the **MENU** button and then use ▲, ▼ button to select the  menu.
2. Press the ► button and then use ▲, ▼ button to select **Position** item.
3. Press the ► button and then use ▲, ▼, ◀, ▶ button to adjust the position.
4. Press the **OK** button to save.
  - To exit the menu display, repeatedly, press the **MENU** button.

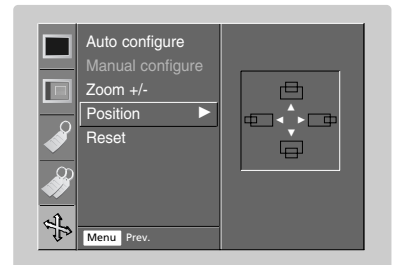

## Reset (Reset to original factory value)

- To restore the original image condition after changing it, press **OK** button after selecting [**Reset**] item.
- You can initialize Manual configure, Zoom +/-, Position.

## Supported Monitor Display

\* The following table lists the display formats supported by the projector.

Sources	Format	Vertical Freq.(Hz)	Horizontal Freq. (kHz)
VGAEGA	640X350	70.090Hz	31.468kHz
	640X350	85.080Hz	37.861kHz
PC98 / VGA text	640X400	70.090Hz	31.468kHz
	640X400	85.080Hz	37.861kHz
	720X400	70.082Hz	31.469kHz
	720X400	85.039Hz	37.927kHz
VGA	640X480	59.940Hz	31.469kHz
	640X480	72.800Hz	37.861kHz
	640X480	75.00Hz	37.500kHz
	640X480	85.008Hz	43.269kHz
SVGA	800X600	56.250Hz	35.156kHz
	800X600	60.317Hz	37.879kHz
	800X600	72.188Hz	48.077kHz
	800X600	75.00Hz	46.875kHz
	800X600	85.061Hz	53.674kHz
XGA	1024X768	60.004Hz	48.363kHz
	1024X768	70.069Hz	56.476kHz
	1024X768	75.029Hz	60.023kHz
	1024X768	84.99Hz	68.677kHz
SXGA	1152X864	60.053Hz	54.348kHz
	1152X864	70.01Hz	63.995kHz
	1152X864	75.00Hz	67.500kHz
	1280X960	60.00Hz	60.00kHz
	1280X1024	60.020Hz	63.981kHz

\* If the projector does not support the input signal, "Out of Range" message appears on the screen.

\* The projector supports DDC1/2B type as Plug & Play function. (Auto recognition of PC monitor)

\* The Synchronization input form for horizontal and vertical frequencies are Separate, Composite and SOG.

\* According to PC, the optimum vertical frequency may not be displayed up to the optimum frequency of set in 'Registration information (Display registration information)'. (ex. The optimum vertical frequency may be displayed up to 75Hz or under in the resolution of 640X480 or 800X600.)

### <DVD/DTV Input>

Signal	Component-*1	RGB(DTV)-*2
NTSC(60Hz)	480i	X
	480p	O
	720p	O
	1080i	O
PAL(50Hz)	576i	X
	576p	O
	1080i	O

\* Cable type

1- RCA to D-Sub Adaptor

2- Computer Cable

# Maintenance

\* The projector needs little maintenance. You should keep the lens clean because any dirt or stains may appear on the screen. If any parts need to be replaced, contact your dealer. When cleaning any part of the projector, always turn the power off and unplug the projector first.

## Cleaning the lens

Clean the lens whenever you notice dirt or dust on the surface of it. Wipe the lens surface gently with an air spray or a soft, dry lint-free cloth.

To remove dirt or stains on the lens, moisten a soft cloth with water and a neutral detergent and wipe the lens surface gently.

## Cleaning the Projector Case

To clean the projector case, first unplug the power cable. To remove dirt or dust, wipe the casing with a soft, dry, lint-free cloth. To remove stubborn dirt or stains, moisten a soft cloth with water and a neutral detergent and then wipe the casing.

Do not use alcohol, benzene, thinners or other chemical detergents as these can cause the casing to be warped or discolored.

# Memo

# Specifications

MODEL	BN315-JD
resolution	1024(Horizontal) x 768(Vertical)pixel
horizontal / vertical ratio	4:3(horizontal:vertical)
DLP panel size	0.7 inches
screen size	1.01~5.08m(40~200 inches)
remote control distance	12m
speaker system	1W(mono)
zoom ratio	1:1.2
Video compatibility	NTSC/PAL/SECAM/NTSC4.43/PAL-M/PAL-N
Power	AC 100 - 240V~50/60Hz, 3A-1A, 260W
height(mm/inches)	100.7/3.9
breadth(mm/inches)	330/12.9
length(mm/inches)	220.1/8.7

### Operating Condition

#### temperature

In operation : 32~95°F(0°C~35°C)  
 In storage and transit : -4~140°F(-20°C~60°C)

#### humidity

In operation : 0~ 80% relative humidity by dry hygrometer  
 Not in operation : 0 ~ 90% relative humidity by dry hygrometer

### Projector Lamp

#### lamp model

AJ-LT91

#### lamp power consumption

200W

### LAMP Replacement

**⚠ WARNING :** Lamp is no user replaceable part. Do not touch and open the lamp replace cover of bottom enclosure. It could cause injury and electric shock due to high temperature and voltage. Only service personnel can replace lamp after minimum 3 min. from disconnect mains plug to avoid injury cause by high temperature of lamp.  
 \* Applicable Lamp: Manufactured by USHIO Inc., type NSH200LG

P/NO : 38289U0027A

