



# Colour Monitor

USER GUIDE  
BENUTZERHANDBUCH  
MANUEL D'UTILISATION  
GUIDA UTENTE  
GUIA DEL USUARIO

StudioWorks  
450N



**LG Electronics Inc.**

<http://www.lge.co.kr>

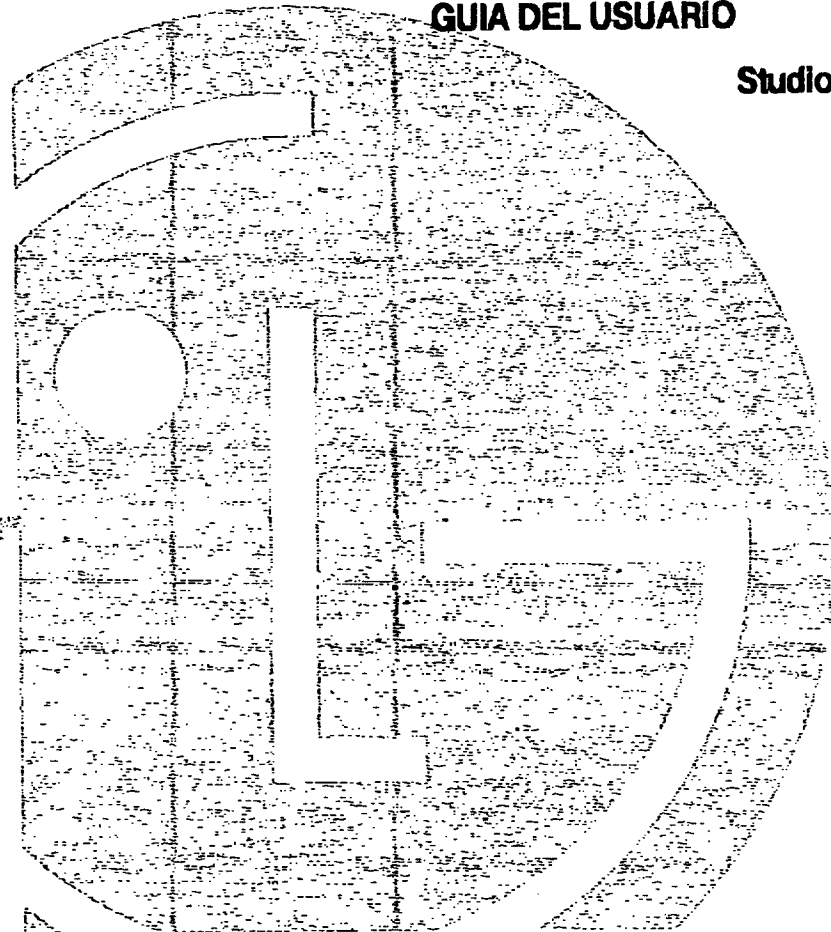

Printed in CHINA

## AGENCY REGULATORY NOTICE

### FCC Compliance Statement

This equipment has been tested and found to comply with the limits for a Class B digital device pursuant to Part 15 of the FCC Rules. These limits are designed to provide reasonable protection against harmful interference in a residential installation.

This equipment generates, uses, and can radiate radio frequency energy and if not installed and used in accordance with the instructions, may cause harmful interference to radio communications. However, there is no guarantee that interference will not occur in a particular installation.

If this equipment does cause harmful interference to radio or television reception (which can be determined by turning the equipment off and on), the user is encouraged to try to correct the interference by using one or more of the following measures:

- Reorient or relocate the receiving antenna.
- Increase the separation between the equipment and the receiver.
- Connect the equipment into an outlet on a circuit different from that to which the receiver is connected.
- Consult the dealer or an experienced radio/TV technician for help.

**Caution:** Changes or modifications not expressly approved by LG Electronics Inc. for compliance could void the user's (or your) authority to operate the equipment. Only peripherals (digital input/output devices, terminals, printers, etc.) certified to comply with the Class B limits may be attached to this monitor. Operation with non-certified peripherals is likely to result in interference to radio and TV reception.

Only shielded Signal Cables may be used with this System.

**Canadian  
D. O. C.  
Notice**

This Class B digital apparatus meets all requirements of the Canadian Interference-Causing Equipment Regulations.

Cet appareil numérique de la classe B respecte toutes les exigences du Règlement sur le matériel brouilleur du Canada.

**CE  
Conformity  
Notice**



Products with the "CE" Marking comply with the EMC Directive(89/336/EEC) and LOW VOLTAGE Directive (73/23/EEC) issued by the Commission of the European Community.

Compliance with these directives implies conformity to the following European Norms :

- EN 55022 ; Radio Frequency Interference
- EN 50082-1:1992 ; Electromagnetic Immunity
- EN 60555-2 ; Power Line Harmonics
- EN 60555-3 ; Voltage Fluctuations
- EN 60950 ; Product Safety

## Table of Contents

<b>Monitor Registration</b>	
Notice.....	A1
Trademark Acknowledgments.....	A1
<b>Important Precautions</b>	
On safety.....	A2
On installation .....	A3
On cleaning.....	A3
On repacking.....	A3
<b>Tilt/Swivel Base</b>	
Installation.....	A4
<b>Installation</b>	
Connections.....	A5
<b>Location and Function of Controls</b>	
Front View.....	A6
Rear View .....	A6
<b>Image Control Panel</b> .....	A7
<b>Power Management System, MPR II and DDC</b>	
Power Management System.....	A9
Low Radiation Compliance (MPR II).....	A9
DDC (Display Data Channel) .....	A9
<b>General Operation</b>	
Video Memory Modes .....	A10
<b>Troubleshooting and Service</b>	
Troubleshooting.....	A11
Service.....	A12
<b>Specifications</b> .....	A13

## Monitor Registration

The model and serial numbers are found on the rear of this unit. These numbers are unique to this unit and not available to others. You should record requested information here and retain this guide as a permanent record of your purchase. Staple your receipt here.

Date of Purchase : \_\_\_\_\_  
Dealer Purchased From : \_\_\_\_\_  
Dealer Address : \_\_\_\_\_  
Dealer Phone No. : \_\_\_\_\_  
Model No. : \_\_\_\_\_  
Serial No. : \_\_\_\_\_

### Notice

All rights reserved. Reproduction in any manner, in whole or in part, is strictly prohibited without the written permission of LG Electronics Inc.

### Trademark Acknowledgments

**LG** is a trademark of **LG Electronics Inc.**

**IBM** is a registered trademark and **VGA** is a trademark of International Business Machines Corporation.

---

**WARNING** : To reduce the risk of fire or electric shock, do not expose this appliance to rain or moisture.

**AVERTISSEMENT** : Ne pas placer cet appareil dans un endroit humide. Cela peut entraîner un incendie ou une décharge électrique.

## Important Precautions

This unit has been engineered and manufactured to assure your personal safety, but improper use can result in potential electrical shock or fire hazard. In order not to defeat the safeguards incorporated in this monitor, observe the following basic rules for its installation, use, and servicing. Also follow all warnings and instructions marked directly on your monitor.

### On safety

---

1. Use only the power cord supplied with the unit. In case you use another power cord, make sure that it is certified by the applicable national standards if not being provided by the supplier.
2. If the power cable is faulty in any way, please contact the manufacturer or the nearest authorized repair service provider for a replacement.
3. Operate the monitor only from a power source indicated in the specifications of this manual or listed on the monitor. If you are not sure what type of power supply you have in your home, consult with your dealer.
4. Overloaded AC outlets and extension cords are dangerous. So are frayed power cords and broken plugs. They may result in a shock or fire hazard. Call your service technician for replacement.
5. **DO NOT OPEN THE MONITOR.** There are no user serviceable components inside. There are Dangerous High Voltages inside, even when the power is OFF. Contact your dealer if the monitor is not operating properly.
6. To avoid personal injury :
  - Do not place the monitor on a sloping shelf unless properly secured.
  - Use only a stand recommended by the manufacturer.
  - Do not try to roll a stand with small casters across thresholds or deep pile carpets.
7. To prevent Fire or Hazards:
  - Always turn the monitor OFF if you leave the room for more than a short period of time. Never leave the monitor ON when leaving the house.

### **Important Precautions**

---

- Keep children from dropping or pushing objects into the monitor's cabinet openings. Some internal parts carry hazardous voltages.
- Do not add accessories that have not been designed for this monitor.
- During a lightning storm or when the monitor is to be left unattended for an extended period of time, unplug it from the wall outlet.
- Do not bring magnetic devices such as magnets or motors near the picture tube.

### **On installation**

---

1. Do not allow anything to rest upon or roll over the power cord, and do not place the monitor where the power cord is subject to damage.
2. Do not use this monitor near water such as near a bathtub, washbowl, kitchen sink, laundry tub, in a wet basement, or near a swimming pool.
3. Monitors are provided with ventilation openings in the cabinet to allow the release of heat generated during operation. If these openings are blocked, built-up heat can cause failures which may result in a fire hazard. Therefore, NEVER:
  - Block the bottom ventilation slots by placing the monitor on a bed, sofa, rug, etc.
  - Place the monitor in a built-in enclosure unless proper ventilation is provided.
  - Cover the openings with cloth or other material.
  - Place the monitor near or over a radiator or heat source.

### **On cleaning**

---

- Unplug the monitor before cleaning the face of the picture tube.
- Use a slightly damp (not wet) cloth. Do not use an aerosol directly on the picture tube because overspray may cause electrical shock.

### **On repacking**

---

- Do not throw away the carton and packing materials. They make an ideal container in which to transport the unit. When shipping the unit to another location, repack it in its original material.

## Tilt/Swivel Base

- Turn Off the equipment and all attached options.
- Carefully set the monitor face-down with the underside facing you.

### Installation

---

1. Align the hooks on the tilt/swivel stand with the matching slots in the base of the monitor.
2. Insert the hooks into slots.
3. Slide the tilt/swivel stand toward the front of the monitor until the latches click into the locked position.

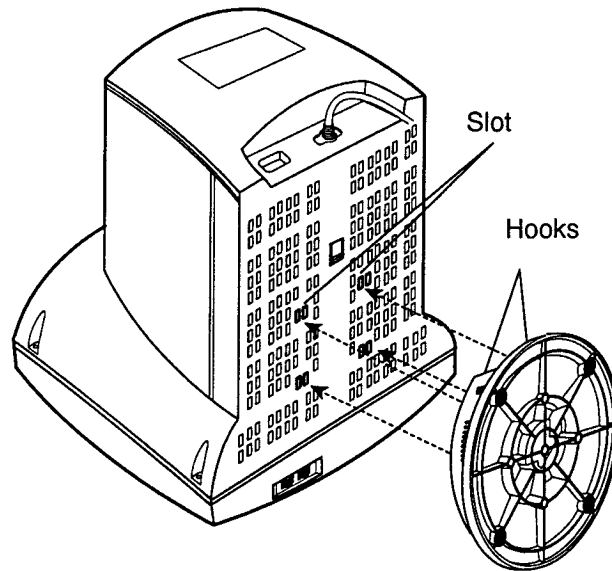



## Installation

The supply voltage is marked on the ID label located on the rear panel of the monitor. If your local voltage is different, do not use the monitor and contact your supplier before using the display.

### Connections

To connect your monitor after the video adapter is properly installed:

1. Turn OFF the power to your computer and all its attached options.
2. Position the monitor and the computer so that you can easily get to the back panel of each.
3. Connect the signal cable with D-sub connector to the graphics board on your PC as described in your PC Owner's Manual.
4. Tighten the screws on the video cable connectors to keep them from coming loose and to prevent radio and TV interference.
5. Connect the power cord to the AC receptacle on the back of the monitor. Plug the other end of the power cord into a properly grounded electrical outlet.
6. The socket-outlet should be installed near the equipment and should be easily accessible.

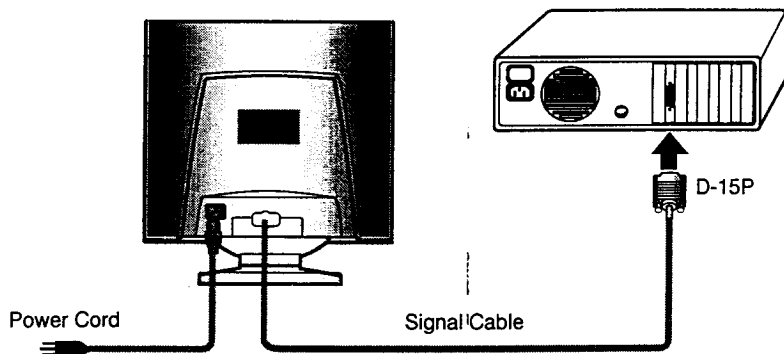

## Location and Function of Controls

Front View

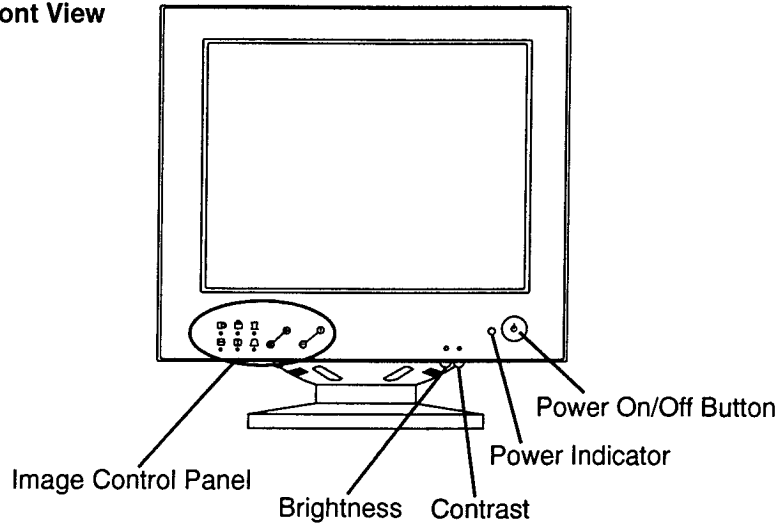

Rear View

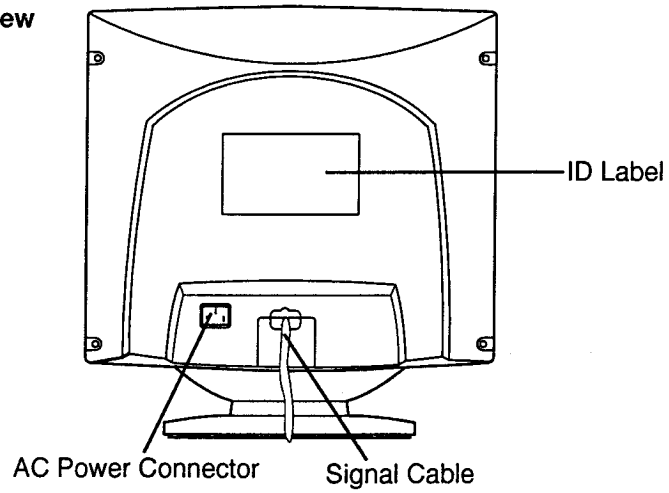

## Location and Function of Controls

---



### Power On/Off Button

This Button is used to turn the power On or Off.

### Power Indicator

The power indicator lights when the power is On, and indicates the operating status of the display.



### Contrast

Adjust the display to the contrast desired. Move the thumbwheel located beneath this indicator to increase or decrease the display contrast.



### Brightness

Used to adjust the brightness of the screen. Move the thumbwheel located beneath this indicator to increase or decrease the display brightness.

## Image Control Panel

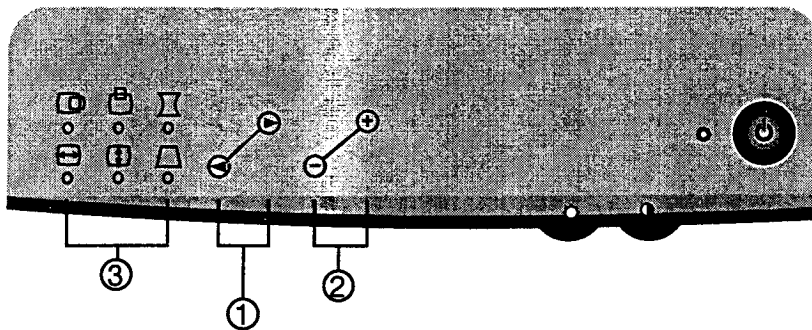

### ① Image Selection and Adjustment buttons







Use either the ◀ or ▶ button to select the icons which you wish to adjust and display.

### ② -/+ buttons

Used to set digital values for each of the select on screen control item by pressing + button for increment or - button for decrement.

### ③ Image Control Icons

Listed below are the icons, icon names, and icon descriptions of the items.

Icon	Description
 <b>Horizontal Position</b>	To move picture image left and right. <ul style="list-style-type: none"> <li>- Moves the screen image left.</li> <li>+ Moves the screen image right.</li> </ul>
 <b>Horizontal Size</b>	To adjust image width. <ul style="list-style-type: none"> <li>- Decreases the size of the screen image.</li> <li>+ Increases the size of the screen image.</li> </ul>
 <b>Vertical Position</b>	To move image up and down. <ul style="list-style-type: none"> <li>- Moves the screen image down.</li> <li>+ Moves the screen image up.</li> </ul>
 <b>Vertical Size</b>	To adjust image height. <ul style="list-style-type: none"> <li>- Decreases the size of the screen image.</li> <li>+ Increases the size of the screen image.</li> </ul>
 <b>Side Pincushion</b>	To correct the bowing in and out of the image. <ul style="list-style-type: none"> <li>- Curves the image's edges inwards.</li> <li>+ Curves the image's edges outwards.</li> </ul>
 <b>Trapezoid</b>	To correct geometric distortion. <ul style="list-style-type: none"> <li>- Makes the screen image narrower at the top.</li> <li>+ Moves the screen image wider at the top.</li> </ul>

#### \* Recall Function

When the user wants to recall one of the 6 factory fixed image modes, push the - and + buttons simultaneously. To recall the next image mode, press both the - and + buttons again.

### **Power Management System**

When used in conjunction with a PC having power saving circuitry, or a PC running screen blanking software this monitor automatically reduces its power consumption when the computer is not in use. The monitor has power-saving states, indicated by the light-emitting diode (LED) on the front panel. These power-saving states exceed the Environmental Protection Agency (EPA) Energy Star requirements using the methodology for Display Power Management Signals (DPMS). Developed by the Video Electronics Standards Association (VESA).

### **Low Radiation Compliance (MPR II)**

This monitor meets one of the strictest guidelines available today for low radiation emissions, offering the user extra shielding and an anti-static screen coating. These guidelines, set forth by a government agency in Sweden, limits the amount of emission allowed in the Extremely Low Frequency (ELF) and Very Low Frequency (VLF) electromagnetic range.

### **DDC (Display Data Channel)**

DDC is a communication channel over which the monitor automatically informs the host system (PC) about its capabilities. This monitor has DDC2B function; DDC2B carry out uni-directional communication between PC and monitor. Under these situations, the PC sends display data to the monitor but not commands to control the monitor servings.

- NOTE :**
- PC must support DDC functions to do this.
  - Some older computer systems are not compatible with the DDC standard. If your monitor is displaying a monochrome image or the wrong resolution, need to change with a DDC compatible VGA card.

## General Operation

After following the installation instructions and getting familiar with the controls, you are ready to operate the monitor.

1. Turn on the monitor, PC and other peripherals you plan to use.
2. After the PC has booted (powered up and finished self-testing), enter a software application that uses the full screen display.
3. While looking at the image on the screen, adjust the controls for the image size, centering, brightness and contrast levels you prefer.
4. This monitor is an auto scanning monitor, capable of synchronizing with a variety of video standards automatically. The Scanning Mode Table below indicates the resolution, as well as the horizontal and vertical refresh rates, of some of the modes that this monitor can match to the output of your PC's graphics card.  
Other resolutions and standards can also be synchronized and displays on this monitor as long as they are within the horizontal and vertical frequency range of this monitor. See the specifications for this information.

### Video Memory Modes

Mode	Display Mode	Horizontal Frequency	Vertical Frequency	Polarity	
				Horiz Sinc	Vert Sinc
1	640 x 480	31.47 kHz	60 Hz	-	-
2	640 x 480	43.27 kHz	85 Hz	-	-
3	720 x 400	31.47 kHz	70 Hz	-	+
4	800 x 600	37.88 kHz	60 Hz	+	+
5	800 x 600	53.67 kHz	85 Hz	+	+
6	1024 x 768	48.36 kHz	60 Hz	-	-

## Troubleshooting

**Symptom:** The power LED is amber.

**Possible causes:**

- Display power management mode.
- There is no sync signal.
- The signal cable is not fastened securely.
- Check the computer power and graphics adapters configuration.
- The frequency of the sync input is outside the operating range of the monitor.

HORZ: 30kHz-54kHz

VERT: 50Hz-120Hz

**Symptom:** The image on the SCREEN is not centered, or too small or not a rectangle shape.

**Possible Causes:** Image adjustment not been done yet in the current operating mode. Use the SELECT and +/- buttons to set the image to your liking.

**Symptom:**The monitor doesn't enter the power saving off mode (Amber led).

**Possible Causes:**Computer video signal is not VESA DPMS standard. Enter the PC or the video controller card is not using the VESA DPMS power management function.

## **Service**

1. Unplug the monitor from the wall outlet and refer servicing to allied service personnel when :
  - The power cord or plug is damaged or frayed.
  - Liquid has been spilled into the monitor.
  - The monitor has been exposed to rain or water.
  - The monitor does not operate normally following the operating instructions. Adjust only those controls that are covered in the operating instructions. An improper adjustment of other controls may result in damage and often requires extensive work by a qualified technician to restore the monitor to normal operation.
  - The monitor has been dropped or the cabinet has been damaged.
  - The monitor exhibits a distinct change in performance.
  - Snapping or popping from the monitor is continuous or frequent while the monitor is operating. It is normal for some monitors to make occasional sounds when being turned on or off, or switching video modes.
  
2. Do not attempt to service the monitor yourself, as opening or removing covers may expose you to dangerous voltage or other hazards. Refer all servicing to qualified service personnel.



## Specifications

### Sync Signal type

Type	H. Sync	V. Sync
Separate sync	H. Sync	V. Sync

### Signal Connector Pin Assignment

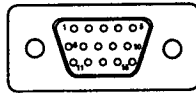

Pin	Separate Sync
1	Red
2	Green
3	Blue
4	Ground
5	Self-Test
6	Red Ground
7	Green Ground
8	Blue Ground
9	NC
10	Ground
11	Ground
12	SDA
13	Horiz.Sync
14	Vert.Sync
15	SCL

## Specifications

**Picture tube** : 14 inch (13.2 inches viewable), Tinted,  
 90 degree deflection  
 0.28 mm, Non-Glare screen  
**Horizontal Frequency** : 30 ~ 54 kHz  
**Vertical Frequency** : 50 ~ 120 Hz  
**Video Bandwidth** : 65 MHz  
**Resolution** : 1024 x 768 Non Interlace, 60Hz Refresh Rate  
**Signal connector** : 15 pin D-Sub type  
**Power input** : AC100-240V, 50/60Hz, 1.5A

### Power Consumption Table

MODE	H.sync	V.sync	Video	Power Consumption	LED Color
Normal	On	On	On	≤ 85W	Green
Stand-by	Off	On	Off	≤ 15W	Amber
Suspend	On	Off	Off	≤ 15W	Amber
Off	Off	Off	Off	≤ 5W	Amber

**Dimensions** : 352 x 397.1 x 307.5 mm (With Tilt/Swivel Stand)  
 (WXDXH) : 13.9 x 15.6 x 12.1 inch  
**Weight (net)** : 10.5 kg (23.15 lbs)

Information in this document is subject to change without notice and does not represent a commitment on the part of LG Electronics Inc.