



LG

Life's Good

ENGLISH

User Guide

LG-D855P

This model is not intended for sale in the USA.

MFLO00000000 (1.0)

www.lg.com



ENGLISH

User Guide

Do you know* introduces you to the new key features of G2. This is available on the phone:

- 1 From the Home screen, swipe left until you see Do you know screen.
- 2 Tap the Do you know screen and tap each feature to get to know.

* Requires data connection.

** To hide the Do you know screen, tap  >  > Home screen setting > uncheck Do you know?.

- Screen displays and illustrations may differ from those you see on actual phone.
- Some of the contents of this guide may not apply to your phone, depending on the software and your service provider. All information in this document is subject to change without notice.
- This handset is not suitable for people who have a visual impairment due to the tap screen keyboard.
- Copyright ©2014 LG Electronics, Inc. All rights reserved. LG and the LG logo are registered trademarks of LG Group and its related entities. All other trademarks are the property of their respective owners.
- Google™, Google Maps™, Gmail™, YouTube™, Hangouts™ and Play Store™ are trademarks of Google, Inc.

Table of contents

For your safety	5
Safety instructions	12
Important notice	20
Getting to know your phone	26
Phone overview	26
Installing the micro-USIM card.....	28
Charging your phone	29
Locking and unlocking the screen.....	30
KnockON.....	30
Stereo headset with microphone.....	31
Plug & Pop.....	32
Your Home screen	33
Touch screen tips	33
Home screen	34
Extended home screen	34
Customizing the Home screen	35
Returning to recently-used applications.	36
Notifications panel.....	36
Opening the notifications panel.....	37
Indicator icons on the Status Bar	37
On-screen keyboard	39
Entering accented letters.....	39
Google account setup	40
Connecting to Networks and Devices	41
Wi-Fi	41
Connecting to Wi-Fi networks	41
Turning Wi-Fi on and connecting to a Wi-Fi network.....	41
Bluetooth.....	42
Sharing your phone's data connection ...	43
Wi-Fi Direct	45
Using SmartShare.....	45
PC connections with a USB cable.....	47
Calls	48
Making a call.....	48
Calling your contacts	48
Answering and rejecting a call	48
Adjusting the in-call volume.....	49
Making a second call.....	49
Viewing your call logs	49
Call settings.....	50
Contacts	51
Searching for a contact.....	51
Adding a new contact	51
Favourites contacts.....	51
Creating a group.....	52
Messaging	53
Sending a message	53
Threaded box	54
Changing your message settings	54
E-mail	55
Managing an email account.....	55
Working with account folders.....	55
Composing and sending email	56

Camera	57	Register VuTalk Before Use	75
Getting to know the viewfinder	57	VuTalk Settings	75
Using the advanced settings	58	Communicate Visually with VuTalk	76
Taking a quick photo	59	Voice Mate	76
Using Shot & Clear mode	59	Use Voice Mate	77
Using Dual camera mode.....	60	Voice Mate Settings	77
Using Time catch shot mode.....	60	LG SmartWorld	77
Once you've taken a photo.....	61	How to Get to LG SmartWorld from Your Phone	77
From your Gallery	62	How to use LG SmartWorld.....	78
Video camera	63	On-Screen Phone	78
Getting to know the viewfinder	63	On-Screen Phone icons.....	78
Using the advanced settings	64	On-Screen Phone features	79
Recording a quick video.....	65	How to install On-Screen Phone on your PC	79
After recording a video.....	65	Multimedia	80
From your Gallery	66	Gallery	80
Adjusting the volume when viewing a video	66	Viewing pictures	80
Using Audio Zoom.....	66	Playing videos	81
Using Dual recording mode.....	67	Editing photos.....	81
Using Tracking zoom mode	67	Deleting photos/videos	81
Function	68	Setting as wallpaper	81
QuickMemo	68	Videos	81
Using the QuickMemo options	69	Playing a video	82
Viewing the saved QuickMemo	69	Video Editor	83
QuickTranslator	70	Music	84
QSlide	71	Add music files to your phone.....	84
QuickRemote	72	Transfer music using Media sync (MTP)	85
Zoom to Track	73	Playing a song.....	85
Live Zooming	74		
VuTalk	75		

Table of contents

Utilities	87	Settings	95
Slide Aside (Quick task-switching with THREE fingers)	87	Networks	95
Guest Mode	87	Sound	98
Setting your alarm	87	Display	99
Using your calculator	88	General.....	101
Adding an event to your calendar	88	PC software (LG PC Suite)	107
Voice Recorder	89	Phone software update	110
Recording a sound or voice	89	Phone software update	110
Sending the voice recording	89	About this user guide	112
Task Manager.....	89	About this user guide.....	112
Tasks.....	90	Trademarks	112
POLARIS Viewer 5.....	90	DivX HD	113
Google+	91	Dolby Digital Plus.....	113
Voice Search.....	91	Accessories	114
Downloads	91	Troubleshooting	115
The Web	92	FAQ	119
Internet.....	92		
Using the Web toolbar	92		
Viewing webpages	92		
Opening a page	93		
Searching the web by voice	93		
Bookmarks	93		
History	93		
Using Popup Browser.....	93		
Chrome	94		
Viewing webpages	94		
Opening a page	94		
Syncing with other devices	94		

Guidelines for safe and efficient use

Please read these simple guidelines. Not following these guidelines may be dangerous or illegal. Should a fault occur, a software tool is built into your device that will gather a fault log. This tool gathers only data specific to the fault, such as signal strength, cell ID position in sudden call drop and applications loaded. The log is used only to help determine the cause of the fault. These logs are encrypted and can only be accessed by an authorized LG Repair centre should you need to return your device for repair.

Exposure to radio frequency energy

THIS DEVICE MEETS INTERNATIONAL GUIDELINES FOR EXPOSURE TO RADIO WAVES
Your mobile device is a radio transmitter and receiver. It is designed and manufactured not to exceed the limits for exposure to radio frequency (RF) recommended by international guidelines (ICNIRP). These limits are part of comprehensive guidelines and establish permitted levels of RF energy for the general population.

The guidelines were developed by independent scientific organisations through periodic and thorough evaluation of scientific studies. The guidelines include a substantial safety margin designed to assure the safety of all persons, regardless of age or health.

The exposure standard for mobile devices employs a unit of measurement known as the Specific Absorption Rate, or SAR. The SAR limit stated in the international guidelines is 2.0 W/kg*. Tests for SAR are conducted using standard operating positions with the device transmitting at its highest certified power level in all tested frequency bands. Although the SAR is determined at the highest certified power level, the actual SAR of the device while operating can be well below the maximum value. This is because the device is designed to operate at multiple power levels so as to use only the power required to reach the network. In general, the closer you are to a base station, the lower the power output of the device.

Before a phone model is available for sale to the public, compliance with the European R&TTE directive must be shown. This directive includes as one essential requirement the protection of the health and the safety for the user and any other person.

Guidelines for safe and efficient use

Bodily Contact During Operation

This device was tested for typical use with the back of the phone kept 0.39 inches (1 cm) from the body. To comply with FCC RF exposure requirements, a minimum separation distance of 0.39 inches (1 cm) must be maintained between the user's body and the back of the phone. Third-party belt-clips, holsters, and similar accessories containing metallic components may not be used. Avoid the use of accessories that cannot maintain 0.39 inches (1 cm) distance between the user's body and the back of the phone and have not been tested for compliance with FCC RF exposure limits.

Wi-Fi Caution

This device is capable of operating in 802.11a/n/ac mode.

For 802.11a/n/ac devices operating in the frequency range of 5.15 - 5.25 GHz, they are restricted for indoor operations to reduce any potential harmful interference for Mobile Satellite Services (MSS) in the US.

Wi-Fi Access Points that are capable of allowing your device to operate in 802.11a/n/ac mode (5.15 - 5.25 GHz band) are optimized for indoor use only.

If your Wi-Fi network is capable of operating in this mode, please restrict your Wi-Fi use indoors to not violate federal regulations to protect Mobile Satellite Services.

Part 15.105 statement

This equipment has been tested and found to comply with the limits for a class B digital device, pursuant to Part 15 of the FCC Rules. These limits are designed to provide reasonable protection against harmful interference in a residential installation. This equipment generates uses and can radiate radio frequency energy and, if not installed and used in accordance with the instructions, may cause harmful interference to radio communications. However, there is no guarantee that interference will not occur in a particular installation. If this equipment does cause harmful interference or television reception, which can be determined by turning the equipment off and on, the user is encouraged to try to correct the interference by one or more of the following measures:

- Reorient or relocate the receiving antenna.
- Increase the separation between the equipment and receiver.
- Connect the equipment into an outlet on a circuit different from that to which the receiver is connected.
- Consult the dealer or an experienced radio/TV technician for help.

* FCC Part 15.19 statement

This device complies with part 15 of the FCC Rules. Operation is subject to the following two conditions:

- (1) This device may not cause harmful interference, and
- (2) this device must accept any interference received, including interference that may cause undesired operation.

Caution! Change or Modifications that are not specifically approved by the manufacturer could void the user's authority to operate the equipment.

Product care and maintenance

WARNING

Only use batteries, chargers and accessories approved for use with this particular phone model. The use of any other types may invalidate any approval or warranty applying to the phone and may be dangerous.

- Do not disassemble this unit. Take it to a qualified service technician when repair work is required.
- Repairs under warranty, at LG's discretion, may include replacement parts or boards that are either new or reconditioned, provided that they have functionality equal to that of the parts being replaced.
- Keep away from electrical appliances such as TVs, radios and personal computers.
- The unit should be kept away from heat sources such as radiators or cookers.
- Do not drop.
- Do not subject this unit to mechanical vibration or shock.
- Switch off the phone in any area where you are required to by special regulations. For example, do not use your phone in hospitals as it may affect sensitive medical equipment.

Guidelines for safe and efficient use

- Do not handle the phone with wet hands while it is being charged. It may cause an electric shock and can seriously damage your phone.
- Do not charge a handset near flammable material as the handset can become hot and create a fire hazard.
- Use a dry cloth to clean the exterior of the unit (do not use solvents such as benzene, thinner or alcohol).
- Do not charge the phone when it is on soft furnishings.
- The phone should be charged in a well ventilated area.
- Do not subject this unit to excessive smoke or dust.
- Do not keep the phone next to credit cards or transport tickets; it can affect the information on the magnetic strips.
- Do not tap the screen with a sharp object as it may damage the phone.
- Do not expose the phone to liquid or moisture.
- Use accessories like earphones cautiously. Do not touch the antenna unnecessarily.
- Do not use, touch or attempt to remove or fix broken, chipped or cracked glass. Damage to the glass display due to abuse or misuse is not covered under the warranty.
- Your phone is an electronic device that generates heat during normal operation. Extremely prolonged, direct skin contact in the absence of adequate ventilation may result in discomfort or minor burns. Therefore, use care when handling your phone during or immediately after operation.
- If your phone gets wet, immediately unplug it to dry off completely. Do not attempt to accelerate the drying process with an external heating source, such as an oven, microwave or hair dryer.
- The liquid in your wet phone, changes the color of the product label inside your phone. Damage to your device as a result of exposure to liquid is not covered under your warranty.

Efficient phone operation

Electronics devices

All mobile phones may receive interference, which could affect performance.

- Do not use your mobile phone near medical equipment without requesting permission. Avoid placing the phone over pacemakers, for example, in your breast pocket.
- Some hearing aids might be disturbed by mobile phones.
- Minor interference may affect TVs, radios, PCs etc.
- Use your phone in temperatures between 0°C and 40°C, if possible. Exposing your phone to extremely low or high temperatures may result in damage, malfunction, or even explosion.

Pacemakers

Pacemaker manufacturers recommend that a minimum separation of 15cm be maintained between a mobile phone and a pacemaker to avoid potential interference with the pacemaker. To achieve this use the phone on the opposite ear to your pacemaker and do not carry it in a breast pocket.

Hospitals

Switch off your wireless device when requested to do so in hospitals, clinics or health care facilities. These requests are designed to prevent possible interference with sensitive medical equipment.

Guidelines for safe and efficient use

Road safety

Check the laws and regulations on the use of mobile phones in the area when you drive.

- Do not use a hand-held phone while driving.
- Give full attention to driving.
- Pull off the road and park before making or answering a call if driving conditions so require.
- RF energy may affect some electronic systems in your vehicle such as car stereos and safety equipment.
- When your vehicle is equipped with an air bag, do not obstruct with installed or portable wireless equipment. It can cause the air bag to fail or cause serious injury due to improper performance.
- If you are listening to music whilst out and about, please ensure that the volume is at a reasonable level so that you are aware of your surroundings. This is of particular importance when near roads.

Avoid damage to your hearing



To prevent possible hearing damage, do not listen at high volume levels for long periods.

Damage to your hearing can occur if you are exposed to loud sound for long periods of time. We therefore recommend that you do not turn on or off the handset close to your ear. We also recommend that music and call volumes are set to a reasonable level.

- When using headphones, turn the volume down if you cannot hear the people speaking near you, or if the person sitting next to you can hear what you are listening to.

NOTE: Excessive sound pressure from earphones and headphones can cause hearing loss

Glass Parts

Some parts of your mobile device are made of glass. This glass could break if your mobile device is dropped on a hard surface or receives a substantial impact. If the glass breaks, do not touch or attempt to remove it. Stop using your mobile device until the glass is replaced by an authorised service provider.

Blasting area

Do not use the phone where blasting is in progress. Observe restrictions and follow any regulations or rules.

Potentially explosive atmospheres

- Do not use your phone at a refueling point.
- Do not use near fuel or chemicals.
- Do not transport or store flammable gas, liquid or explosives in the same compartment of your vehicle as your mobile phone or accessories.

In aircraft

Wireless devices can cause interference in aircraft.

- Turn your mobile phone off before boarding any aircraft.
- Do not use it on the ground without permission from the crew.

Guidelines for safe and efficient use

Children

Keep the phone in a safe place out of the reach of small children. It includes small parts which may cause a choking hazard if detached.

Emergency calls

Emergency calls may not be available on all mobile networks. Therefore you should never depend solely on your phone for emergency calls. Check with your local service provider.

Battery information and care

- You do not need to completely discharge the battery before recharging. Unlike other battery systems, there is no memory effect that could compromise the battery's performance.
- Use only LG batteries and chargers. LG chargers are designed to maximise the battery life.
- Do not disassemble or short-circuit the battery.
- Replace the battery when it no longer provides acceptable performance. The battery pack may be recharged hundreds of times before it needs replacing.
- Recharge the battery if it has not been used for a long time to maximise usability.
- Do not expose the battery charger to direct sunlight or use it in high humidity, such as in the bathroom.
- Do not leave the battery in hot or cold places, as this may deteriorate battery performance.
- There is risk of explosion if the battery is replaced with an incorrect type.
- Dispose of used batteries according to the manufacturer's instructions. Please recycle when possible. Do not dispose as household waste.

- If you need to replace the battery, take it to the nearest authorised LG Electronics service point or dealer for assistance.
- Always unplug the charger from the wall socket after the phone is fully charged to save unnecessary power consumption of the charger.
- Actual battery life will depend on network configuration, product settings, usage patterns, battery and environmental conditions.
- Make sure that no sharp-edged items such as animal's teeth or nails, come into contact with the battery. This could cause a fire.

Important notice



Please read this before you start using your phone!

Please check to see whether any problems you encountered with your phone are described in this section before taking the phone in for service or calling a service representative.

1. Phone memory

When there is less than 10% of space available in your phone memory, your phone cannot receive new messages. You need to check your phone memory and delete some data, such as applications or messages, to make more memory available.

To uninstall applications:

- 1 Tap  >  > **Apps** tab >  **Settings** > **General** tab > **Apps**.
- 2 Once all applications appear, scroll to and select the application you want to uninstall.
- 3 Tap **Uninstall**.

2. Optimizing battery life



Extend your battery's power by turning off features that you don't have to run constantly in the background. You can monitor how applications and system resources consume battery power.

Extending your phone's battery life:

- Turn off radio communications when you are not using. If you are not using Wi-Fi, Bluetooth or GPS, turn them off.
- Reduce screen brightness and set a shorter screen timeout.
- Turn off automatic syncing for Gmail, Calendar, Contacts and other applications.
- Some applications you have downloaded may reduce battery power.
- While using downloaded applications, check the battery charge level.



NOTE: If you accidentally press the Power/Lock Key while the device is in your pocket, the screen will turn off automatically in order to save battery power.

To check the battery power level:

- Tap  >  > **Apps** tab >  **Settings** > **General** tab > **About phone** > **Battery**.

The battery status (charging or discharging) and battery level (percentage charged) is displayed at the top of the screen.

To monitor and control how battery power is being used:

- Tap  >  > **Apps** tab >  **Settings** > **General** tab > **About phone** > **Battery** > **Battery use**.

Battery usage time is displayed on the screen. It tells you how long it has been since you last connected your phone to a power source or, if currently connected, how long the phone was last running on battery power. The screen shows the applications or services using battery power, listed in order from the greatest to smallest amount used.

3. Before installing an open source application and OS

WARNING



If you install and use an OS other than the one provided by the manufacturer it may cause your phone to malfunction. In addition, your phone will no longer be covered by the warranty.

WARNING

To protect your phone and personal data, only download applications from trusted sources, such as Play Store™. If there are improperly installed applications on your phone, the phone may not work normally or a serious error may occur. You must uninstall those applications and all associated data and settings from the phone.

Important notice

4. Using an unlock pattern

Set an unlock pattern to secure your phone. Tap  >  > **Apps** tab >  **Settings** > **Display** tab > **Lock screen** > **Select screen lock** > **Pattern**. This opens a screen that will guide you through how to draw a screen unlock pattern. You have to create a Backup PIN as a safety measure in case you forget your unlock pattern.

Caution: Create a Google account before setting an unlock pattern and remember the Backup PIN you created when creating your pattern lock.

WARNING

Precautions to take when using pattern lock.

It is very important to remember the unlock pattern you set. You will not be able to access your phone if you use an incorrect pattern 5 times. You have 5 opportunities to enter your unlock pattern, PIN or password. If you have used all 5 opportunities, you can try again after 30 seconds.

When you can't recall your unlock Pattern, PIN or Password:

< If you have forgotten your pattern >

If you logged in to your Google account on the phone but failed to enter the correct pattern 5 times, tap the **Forgot pattern?** button at the bottom of the screen. You are then required to log in with your Google Account or you have to enter the Backup PIN which you entered when creating your Pattern Lock.

If you have not created a Google account on the phone or you forgot Backup PIN, you have to perform a hard reset.

< If you have forgotten your PIN or Password >

If you forget your PIN or Password, you will need to perform a hard reset.

Caution: If you perform a hard reset, all user applications and user data will be deleted.

NOTE: If you have not logged into your Google Account and have forgotten your Unlock Pattern, you will need to enter your Backup PIN.

5. Using the Hard Reset (Factory Reset)

If your phone does not restore to its original condition, use a Hard Reset (Factory Reset) to initialize it.

- 1 Turn the power off.
- 2 Press and hold the **Power/Lock key + Volume Down key** on the back of the phone.
- 3 Release the **Power/Lock Key** only when the LG logo is displayed, then immediately press and hold the **Power/Lock Key** again.
- 4 Release all keys when the Factory hard reset screen is displayed.
- 5 Press the **Power/Lock Key** to continue or either of the **Volume Keys** to cancel.
- 6 Press the **Power/Lock Key** once more to confirm or either of the **Volume Keys** to cancel.



WARNING

If you perform a Hard Reset, all user applications, user data and DRM licenses will be deleted. Please remember to backup any important data before performing a Hard Reset.



6. Opening and switching applications

Multi-tasking is easy with Android, you can keep more than one application running at the same time. There is no need to quit an application before opening another one. Use and switch between several open applications. Android manages each application, stopping and starting them as needed to ensure that idle applications don't consume resources unnecessarily.

Important notice

- 1 Touch and hold the **Home Key** . A list of recently used applications will be displayed.
- 2 Tap the application you want to access. This does not stop the previous app running in the background on the phone. Make sure to tap **Back Key**  to exit an app after using it.
 - To stop applications, tap **Task Manager** from the recent apps list, then tap **Stop** or **Stop all**.
 - To remove an app from the recent apps list, swipe the app preview to the left or right. To clear all apps, tap **Clear all**.

7. Transferring music, photos and videos using Media sync (MTP)

- 1 Tap  >  > **Apps** tab >  **Settings** > **General** tab > **Storage** to check out the storage media.
- 2 Connect the phone to your PC using the USB cable.
- 3 **Select USB connection method** will appear on your phone screen, Select the **Media sync (MTP)** option.
- 4 Open the memory folder on your PC. You can view the mass storage content on your PC and transfer the files from PC to Device memory folder or vice versa.
- 5 After transferring files, slide down the status bar and tap **USB connected** and select **Charge phone** from USB connection type list.

8. Hold your phone upright

Hold your cell phone vertically, as you would a regular phone. Your phone has an internal antenna. Be careful not to scratch or damage the back of the phone, as this may affect performance.

When making/receiving calls or sending/receiving data, avoid holding the lower part of the phone where the antenna is located. Doing so may affect call quality.

9. When the screen freezes

If the screen freezes or the phone does not respond when you try to operate it:

Press and hold the **Power/Lock** key for 10 seconds to turn your phone off. If it still does not work, please contact the service center.

10. Do not connect your phone when you power on/off your PC

Make sure to disconnect your phone from the PC when powering your PC on or off as it might result in PC errors.

11. Hardware key control mode

If your phone display is damaged or broken, you can answer an incoming call, end a call, or turn off an alarm using the hardware keys.

- 1 Turn your phone off.
- 2 Press and hold the **Power/Lock Key** and the **Volume Keys** at the same time for more than 6 seconds to enter the Hardware key control mode.
- 3 Press the **Volume Keys** to scroll to the desired option, then press the **Power/Lock Key** to confirm.
 - **Answer a call:** Press the **Volume Keys** at the same time.
 - **End a call:** Press the **Power/Lock Key** during a call.
 - **Stop an alarm:** When an alarm rings, press and hold the **Volume Up Key** or **Volume Down Key** to stop the alarm.

NOTE: If you use your phone with a broken display glass, your phone can break even more or you can be injured. Make sure to visit the LG authorized service center to get your phone repaired.

Getting to know your phone

Phone overview

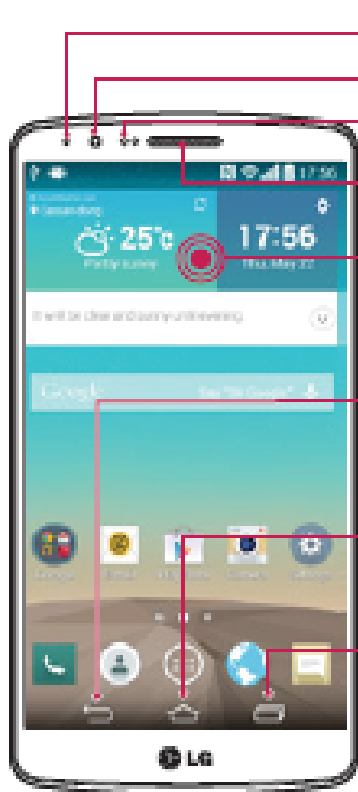

Notification LED
Front Camera Lens
Proximity Sensor
Earpiece

Touch Screen

Back Key

- Returns to the previous screen. Also closes pop-up items such as menus, dialog boxes, and the on-screen keyboard. Touch and hold it to access Dual window.

Home Key

- Return to the Home screen from any screen.

Recent Key

- Displays recently used applications. You can perform the Menu Key by long touching this.

NOTE: Proximity sensor

When receiving and making calls, the proximity sensor automatically turns the backlight off and locks the touch screen by sensing when the phone is near your ear. This extends battery life and prevents you from unintentionally activating the touch screen during calls.

!WARNING

Placing a heavy object on the phone or sitting on it can damage the LCD and touch screen functions. Do not cover the LCD proximity sensor with protective film. This could cause the sensor to malfunction.

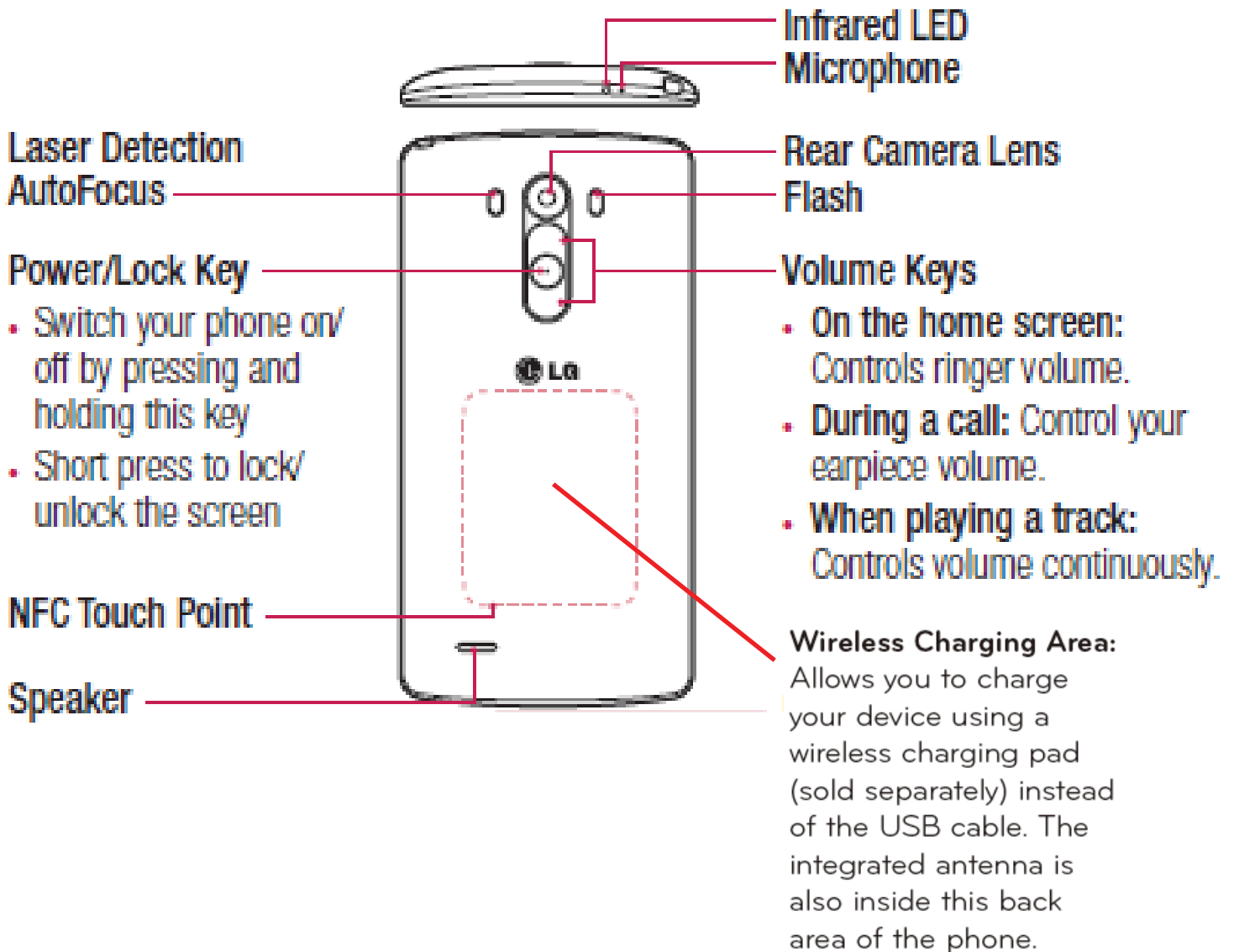

⚠ WARNING

- This part encloses the battery compartment. Please do not open the back cover.
- Be careful not to damage the NFC touch point on the phone, which is part of the NFC antenna.

Getting to know your phone

Installing the SIM card and battery

Before you can start exploring your new phone, you'll need to set it up.

- 1 To remove the back cover, hold the phone firmly in one hand. With your other hand, lift off the back cover with your thumbnail as shown in figure below.

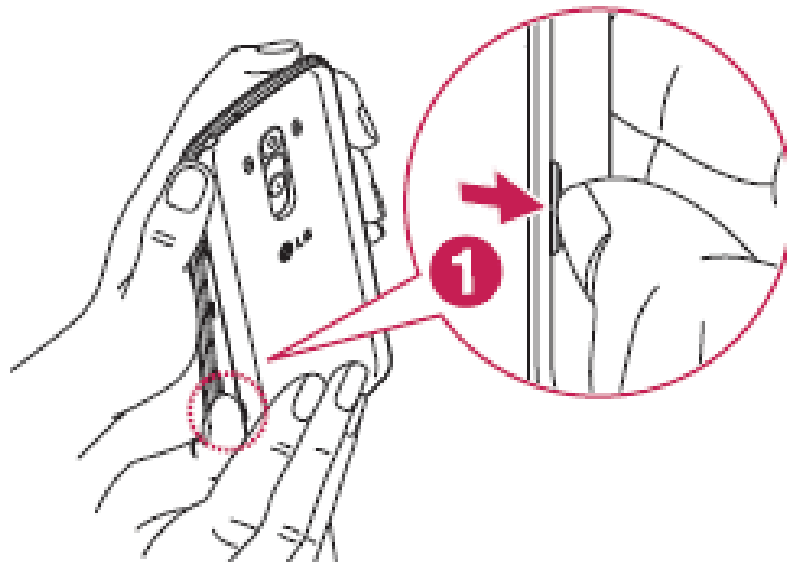

- 2 Slide the SIM card into the lower slot for the SIM card as shown in the figure. Make sure the gold contact area on the card is facing downwards.

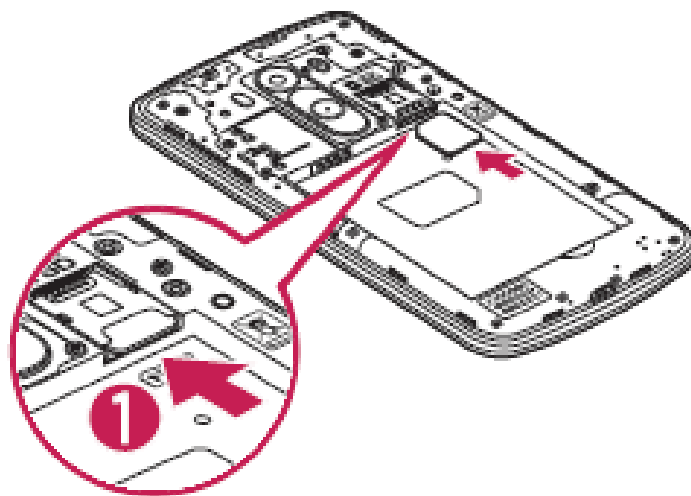

- 3** Insert the battery into place by aligning the gold contacts on the phone and the battery (1) and pressing it down until it clicks into place (2).

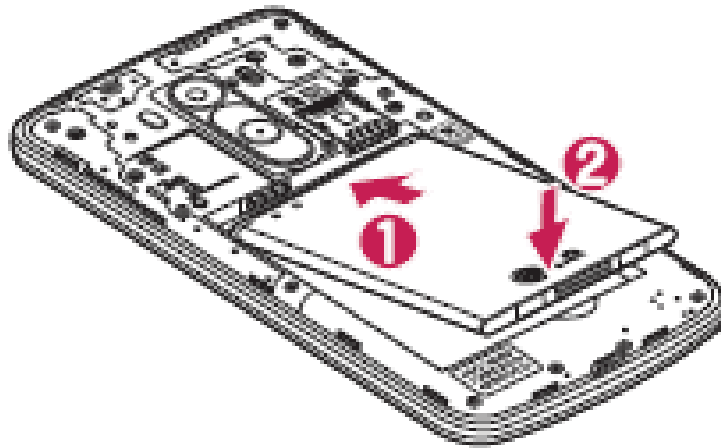

- 4** Align the back cover over the battery compartment (1) and press it down until it clicks into place (2).

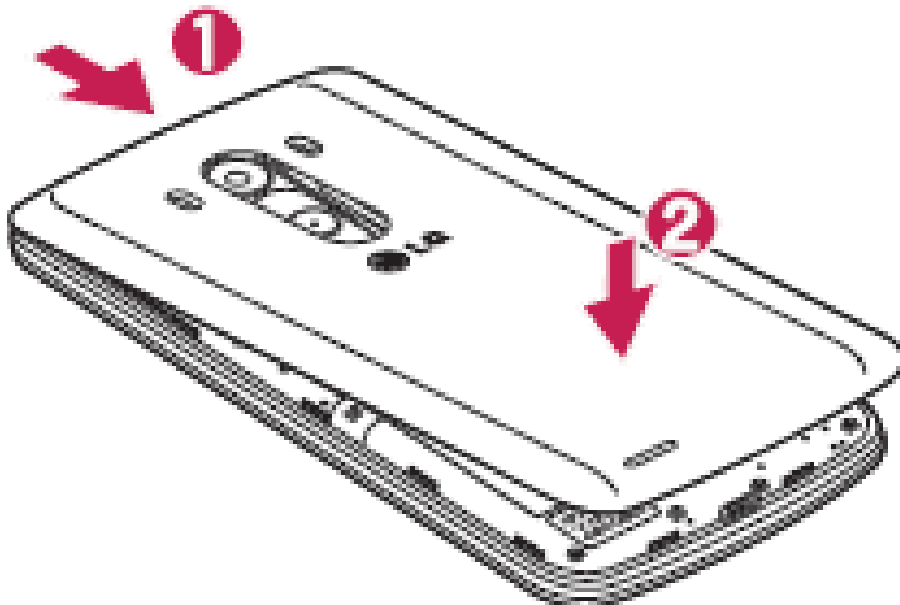

Getting to know your phone

Charging your phone

Charge the battery before using it for the first time. Use the charger to charge the battery. A computer can be also used to charge the device by connecting them via the USB cable.

WARNING

Use only LG-approved chargers, batteries and cables. If you use unapproved chargers, batteries or cables, it may cause battery charging delay or pop up message regarding slow charging, Or this can cause the battery to explode or damage the device, which are not covered by the warranty.

The charger connector is at the bottom of the phone. Insert the charger and plug it into an electrical outlet.

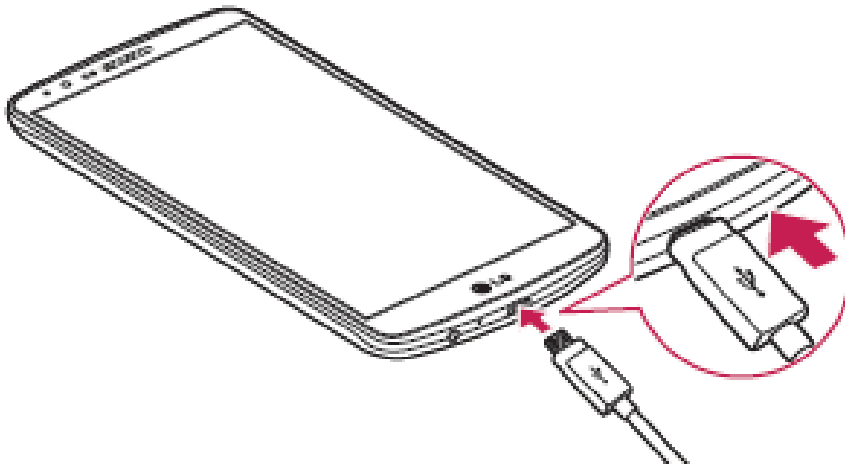

NOTE:

- The battery must be fully charged initially to improve battery lifetime.
- Do not open the back cover while your phone is charging.

Using the memory card

Your phone supports the use of microSD™ or microSDHC™ memory cards of up to 64GB capacity. These memory cards are specifically designed for mobile phones and other ultra-small devices and are ideal for storing media-rich files such as music, programs, videos, and photographs for use with your phone.

To insert a memory card:

Insert the memory card into the upper slot for the memory card. Make sure the gold contact area of Memory card is facing downwards.

To safely remove the memory card:

Touch  > **Apps** tab >  **Settings** > **General** tab > **Storage** > **Unmount SD card**.

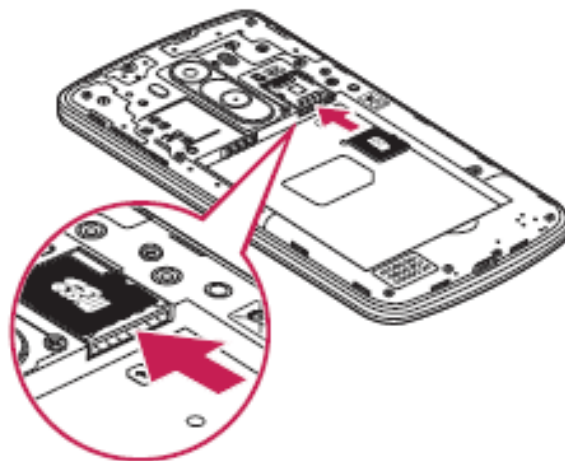

NOTE:



- Use only compatible memory cards with your phone. Using incompatible memory cards may damage the card and data stored on the card, as well as the phone.
- It's important to unmount the memory card prior to removing it from the phone to avoid damage to it or the data saved on the card.

Getting to know your phone

To format the memory card:

Your memory card may already be formatted. If it isn't, you must format it before you can use it.

NOTE: All files on your memory card are deleted when it is formatted.

- 1 Touch  to open the application list.
- 2 Scroll and touch  **Settings** > **General** tab > **Storage**.
- 3 Touch **Unmount SD card**.
- 4 Touch **Erase SD card** > **Erase SD card** > **Erase everything**.
- 5 If you have set a pattern lock, input the pattern lock then select **Erase everything**.

NOTE: If there is content on your memory card, the folder structure may be different after formatting, as all the files will have been deleted.

Locking and unlocking the screen

If you do not use the phone for a while, the screen will be automatically turned off and locked. This helps to prevent accidental taps and saves battery power.

When you are not using the phone, press the **Power/Lock key**  to lock your phone. If there are any programs running when you lock your screen, they may be still running in Lock mode. It is recommended that you exit all programs before entering Lock mode to avoid unnecessary charges (e.g. phone calls, web access and data communications).

To wake up your phone, press the **Power/Lock key** . The Lock screen will appear. Touch and slide the Lock screen in any direction to unlock your Home screen. The last screen you viewed will open.

KnockON

You can lock or unlock the screen by just double-tap.

To activate KnockON feature

- 1 Tap  >  > **Apps** tab >  **Settings** > **General** tab > **Gestures**.

2 Place a checkmark on **Screen on/off**.

Double-tap the center screen quickly to unlock the screen. To lock the screen, double-tap the status bar in any screen (except on the camera viewfinder) or empty area on the Home screen.

NOTE: When turning the screen on, make sure you do not cover the proximity sensor. Doing so will turn the screen off immediately after turning it on in order to prevent abnormal turning on in your pocket or bag.

Stereo headset with microphone

With the headset connected, you can enjoy music or video with stereo sound, and easily switch from your music/video to take and end calls.

< Front >

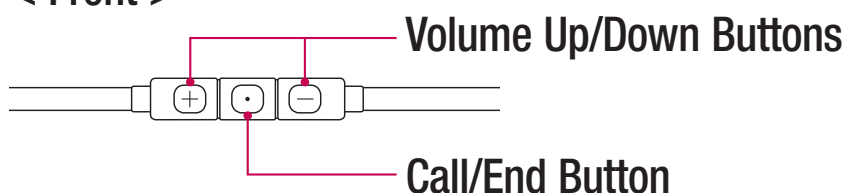

- For an incoming call, press to receive or end a call.
- When you listen to music, press to stop playback or resume. Press twice to play the next track.

< Back >

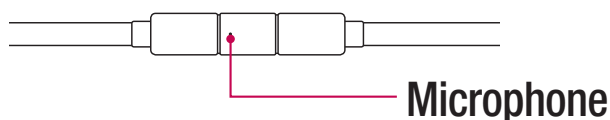

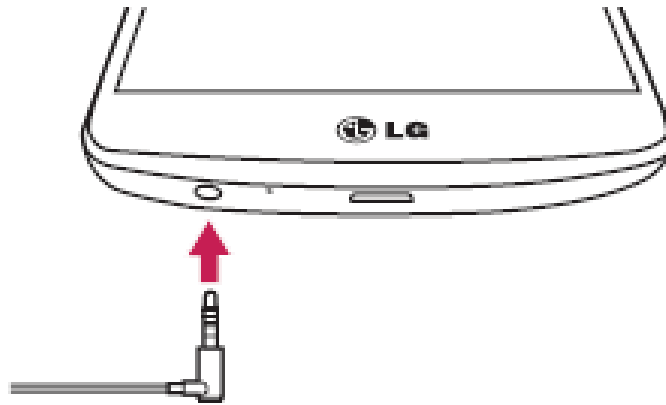

1 Plug in the headset as shown below.

Getting to know your phone



- 2 The applications panel displays and you can select an app to run.

NOTE: You can edit the applications to display on the panel and set not to show the applications panel. Please see < **Accessory** >.

- 3 If a call is coming when the headset is connected to the phone, press the  to take the call.
- 4 To end the call, press the  again.

Plug & Pop

Plug & Pop allows you to quickly choose apps to use when plugging in an earphone or On-the-Go device, such as a mouse or keyboard.

- 1 Plug in earphone or OTG (On-the-Go) device (i.e., mouse, keyboard, etc.).
- 2 The applications panel will display and you can select an app to run.

NOTE: You can edit the applications to display on the panel and set not to show the applications panel.

- ▶ Tap  >  > **Apps tab** >  **Settings** > **General tab** > **Accessory** > **USB storage** or **Earphone**.

Your Home screen

Touch screen tips

Here are some tips on how to navigate on your phone.

Tap or touch – A single finger tap selects items, links, shortcuts and letters on the on-screen keyboard.

Touch and hold – Touch and hold an item on the screen by tapping it and not lifting your finger until an action occurs. For example, to open a contact's available options, touch and hold the contact in the Contacts list until the context menu opens.

Drag – Touch and hold an item for a moment and then, without lifting your finger, move your finger on the screen until you reach the target position. You can drag items on the Home screen to reposition them.

Swipe or slide – To swipe or slide, quickly move your finger across the surface of the screen, without pausing when you first tap it (so you don't drag an item instead). For example, you can slide the screen up or down to scroll through a list, or browse through the different Home screens by swiping from left to right (and vice versa).

Double-tap – Double-tap to zoom on a webpage or a map. For example, quickly double-tap a section of a webpage to adjust that section to fit the width of the screen. You can also double-tap to zoom in and out while viewing the picture.

Pinch-to-Zoom – Use your index finger and thumb in a pinching or spreading motion to zoom in or out when using the browser or Maps, or when browsing pictures.

Rotate the screen – From many applications and menus, the orientation of the screen adjusts to the device's physical orientation.

NOTE:

- To select an item, tap the center of the icon.
- Do not press too hard; the tap screen is sensitive enough to pick up a light, yet firm tap.
- Use the tip of your finger to tap the option you want. Be careful not to tap any other keys.

Your Home screen

Home screen

The Home screen is the starting point for many applications and functions, and it allows you to add items like application shortcuts, or Google widgets to give you instant access to information and applications. This is the default canvas and accessible from any menu by tapping .

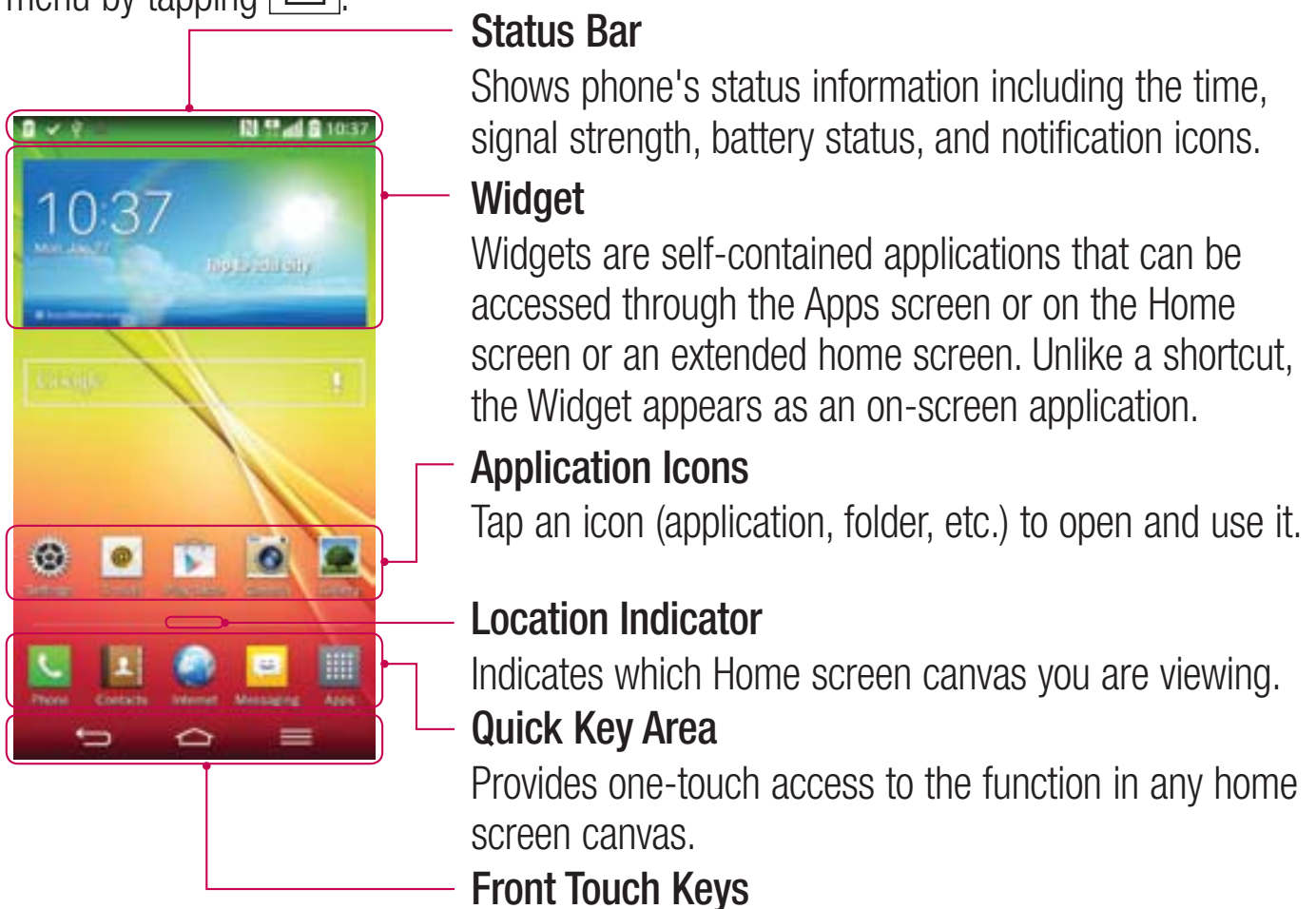

Extended home screen

The operating system provides multiple Home screen canvases to provide more space for adding icons, widgets, and more.

- ▶ Slide your finger left or right across the Home screen.

Customizing the Home screen

You can customize your Home screen by adding apps, widgets or changing wallpapers.

To add items on your Home screen

- 1 Touch and hold the empty part of the Home screen.
- 2 In the Add Mode menu, select the item you wish to add. You will then see this added item on the Home screen.
- 3 Drag it to the desired location and lift your finger.

TIP! To add an application icon to the Home screen from the Apps menu, touch and hold the application you want to add.

To remove an item from the Home screen

- ▶ **Home screen** > touch and hold the icon you want to remove > drag it to .

To add an app as a Quick key

- ▶ From the Apps menu or on the Home screen, touch and hold an application icon and drag it to the Quick key area. Up to 7 apps can be added.

To remove an app from the Quick key area

- ▶ Touch and hold the desired quick key and drag it to .

NOTE:  **Apps** key cannot be removed.

To customize apps icons on the Home screen

- 1 Touch and hold an application icon until it is unlocked from its current position. Then drop it on the screen. The editing icon  will appear in the upper right corner of the application.
- 2 Tap the application icon again and select the desired icon design and size.
- 3 Tap **OK** to save the change.

Your Home screen

Returning to recently-used applications

- 1 Touch and hold . The screen displays a pop-up containing the icons of applications you used recently.
- 2 Tap an icon to open the application. Or tap  to return to your previous screen.

Notifications panel

Notifications alert you the arrival of new messages, calendar events, and alarms, as well as to ongoing events, such as when you are on a call.

When a notification arrives, its icon appears at the top of the screen. Icons for pending notifications appear on the left, and system icons such as Wi-Fi or battery strength shown on the right.

NOTE: The available options may vary depending on the region or service provider.

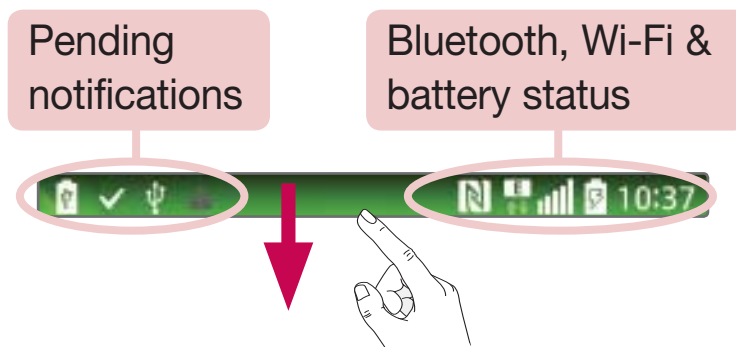

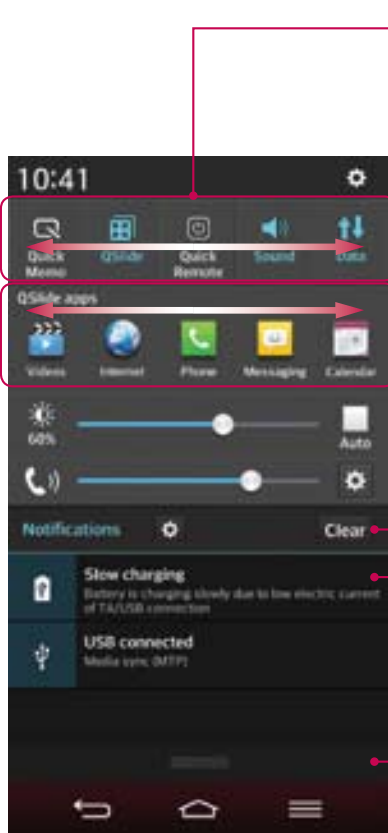

Opening the notifications panel

Swipe down from the status bar to open the notifications panel.



The screenshot shows the notifications panel pulled down from the top of the screen. At the top is the 'Quick Toggle Area' with icons for Quick Memo, QSlide, Quick Remote, Sound, and Voice. Below that is the 'QSlide apps' section with icons for Videos, Internet, Phone, Messaging, and Calendar. The 'Notifications' section contains a 'Clear' button and two notification cards: 'Slow charging' and 'USB connected'. At the bottom of the panel is a 'Dismiss' button. Red lines connect text labels to these specific elements in the image.

Quick Toggle Area
Tap each quick toggle key to turn it on/off. Touch and hold the key to access the settings menu of the function. To see more toggle keys, swipe left or right. Tap  to remove, add, or rearrange toggle keys.

QSlide Apps
Tap a QSlide app to open as a small window on your screen. Tap  to remove, add, or rearrange QSlide apps.

Tap to clear all the notifications.

Notifications
The current notifications are listed, each with a brief description. Tap a notification to view it.

To close the notifications panel, touch and drag the tab toward the top of the screen.



























Indicator icons on the Status Bar



Indicator icons appear on the status bar at the top of the screen to report missed calls, new messages, calendar events, device status and more.



Your Home screen

The icons displayed at the top of the screen provide information about the status of the device. The icons listed in the table below are some of the most common ones.

Icon	Description	Icon	Description
	No SIM card inserted		Ringer is silenced
	No network signal available		Vibrate mode is on
	Airplane mode is on		Battery fully charged
	Connected to a Wi-Fi network		Battery is charging
	Wired headset connected		Phone is connected to PC via USB cable
	Call in progress		Downloading data
	Missed call		Uploading data
	Bluetooth is on		GPS is on
	NFC is on		Data is synchronizing
	System warning		New Gmail message available
	An alarm is set		New Hangouts message available
	New voicemail available		Choose input method
	New text or multimedia message		DLNA content share

	A song is currently playing		DLNA music playing
	Mobile hotspot is active		

NOTE: The icons location in the status bar may differ according to the function or service.

On-screen keyboard

You can enter text using the on-screen keyboard. The on-screen keyboard appears automatically on the screen when you need to enter text. To manually display the keyboard, simply tap a text field where you want to enter text.

Using the keypad & entering text

 Tap once to capitalize the next letter you type. Double-tap for all caps.

  Tap to switch to the numbers and symbols keyboard.

 Tap to switch to handwriting mode.

 Tap to enter a space.

 Tap to create a new line.

 Tap to delete the previous character.

Entering accented letters

When you select French or Spanish as the text entry language, you can enter special French or Spanish characters (e.g. "á").

For example, to input "á", touch and hold the "a" key until the zoom-in key grows bigger and displays characters from different languages.

Then select the special character you want.

Google account setup

When you first turn on your phone, you have the opportunity to activate the network, to sign into your Google Account and select how you want to use certain Google services.

To set up your Google account:

- Sign into a Google Account from the prompted set-up screen.

OR

- Tap  >  > **Apps** tab > select a Google application, such as **Gmail** > select **New** to create a new account.

If you have a Google account, tap **Existing**, enter your email address and password, then tap .

Once you have set up your Google account on your phone, your phone automatically synchronizes with your Google account on the Web.

Your contacts, Gmail messages, Calendar events and other information from these applications and services on the Web are synchronized with your phone. (This will depend on your synchronization settings.)

After signing in, you can use Gmail™ and take advantage of Google services on your phone.

Connecting to Networks and Devices

Wi-Fi



With Wi-Fi, you can use high-speed Internet access within the coverage of the wireless access point (AP). Enjoy wireless Internet using Wi-Fi, without extra charges.

Connecting to Wi-Fi networks

To use Wi-Fi on your phone, you need to access a wireless access point or 'hotspot'. Some access points are open and you can simply connect to them. Others are hidden or use security features; you must configure your phone to be able to connect to them. Turn off Wi-Fi when you're not using it to extend the life of your battery.

NOTE: If you are out of the Wi-Fi zone or have set Wi-Fi to **OFF**, additional charges may be applied by your mobile operator for mobile data use.

Turning Wi-Fi on and connecting to a Wi-Fi network

- 1 Tap  >  > **Apps** tab >  **Settings** > **Networks** tab > **Wi-Fi**.
- 2 Set **Wi-Fi** to **ON** to turn it on and start scanning for available Wi-Fi networks.
- 3 Tap the Wi-Fi menu again to see a list of active and in-range Wi-Fi networks.
 - Secured networks are indicated by a lock icon.
- 4 Tap a network to connect to it.
 - If the network is secured, you are prompted to enter a password or other credentials. (Ask your network administrator for details)
- 5 The status bar displays icons that indicate Wi-Fi status.

Connecting to Networks and Devices

Bluetooth



You can use Bluetooth to send data by running a corresponding application, but not from the Bluetooth menu as on most other mobile phones.

NOTE:

- LG is not responsible for the loss, interception or misuse of data sent or received via the Bluetooth wireless feature.
- Always ensure that you share and receive data with devices that are trusted and properly secured. If there are obstacles between the devices, the operating distance may be reduced.
- Some devices, especially those that are not tested or approved by Bluetooth SIG, may be incompatible with your device.

Turning on Bluetooth and pairing up your phone with a Bluetooth device

You must pair your device with another device before you connect to it.

- 1 Tap  >  > **Apps** tab >  **Settings** > **Networks** tab > set **Bluetooth** to **ON**.
 - 2 Tap the **Bluetooth** menu again. You will see the option to make your phone visible and option to search devices. Now tap **Search for devices** to view the devices in the Bluetooth Range.
 - 3 Choose the device you want to pair with from the list.
- Once the pairing is successful, your device will connect to the other device.

NOTE: Some devices, especially headsets or hands-free car kits, may have a fixed Bluetooth PIN, such as 0000. If the other device has a PIN, you will be asked to enter it.



Send data using the Bluetooth wireless feature

- 1 Select a file or item, such as a contact, calendar event or media file, from an appropriate application or from **Downloads**.
- 2 Select the option for sending data via Bluetooth.

NOTE: The method for selecting an option may vary by data type.

- 3 Search for and pair with a Bluetooth-enabled device.

Receive data using the Bluetooth wireless feature

- 1 Tap  >  > **Apps** tab >  **Settings** > **Networks** tab > set **Bluetooth** to **ON**.
- 2 Tap the **Bluetooth** menu again and mark the checkbox at the top of the screen to visible on other devices.

NOTE: To select the length of time that your device will be visible, tap  > **Visibility timeout**.

- 3 Select **Accept** to confirm that you are willing to receive data from the device.

Sharing your phone's data connection



USB tethering and portable Wi-Fi hotspot are great features when there are no wireless connections available. You can share your phone's mobile data connection with a single computer via a USB cable (USB tethering). You can also share your phone's data connection with more than one device at a time by turning your phone into a portable Wi-Fi hotspot.

When your phone is sharing its data connection, an icon appears in the status bar and as an ongoing notification in the notifications drawer.

For the latest information about tethering and portable hotspots, including supported operating systems and other details, visit <http://www.android.com/tether>.

Connecting to Networks and Devices



To share your phone's data connection as a portable Wi-Fi hotspot

- 1 Tap  >  > **Apps** tab >  **Settings** > **Networks** tab > **Tethering & networks** > **Wi-Fi hotspot** switch to activate.
- 2 Enter a password and tap **Save**.

TIP! If your computer is running Windows 7 or a recent distribution of some flavours of Linux (such as Ubuntu), you will not usually need to prepare your computer for tethering. But, if you are running an earlier version of Windows or another operating system, you may need to prepare your computer to establish a network connection via USB. For the most current information about which operating systems support USB tethering and how to configure them, visit <http://www.android.com/tether>.

To rename or secure your portable hotspot

You can change the name of your phone's Wi-Fi network name (SSID) and secure its Wi-Fi network.

- 1 Tap  >  > **Apps** tab >  **Settings** > **Networks** tab > **Tethering & networks** > **Wi-Fi hotspot**.
- 2 Tap **Set up Wi-Fi hotspot**.
 - The **Set up Wi-Fi hotspot** dialogue box will open.
 - You can change the **Network SSID** (name) that other devices see when scanning for Wi-Fi networks.
 - You can also tap the **Security** menu to configure the network with Wi-Fi Protected Access 2 (WPA2) security using a pre-shared key (PSK).
 - If you touch the **WPA2 PSK** security option, a password field is added to the **Set up Wi-Fi hotspot** dialogue box. If you enter a password, you will need to enter that password when you connect to the phone's hotspot with a computer or other device. You can set **Open** in the **Security** menu to remove security from your Wi-Fi network.
- 3 Tap **Save**.

ATTENTION! If you set the security option as Open, you cannot prevent unauthorised usage of online services by other people and additional charges may be incurred. To avoid unauthorized usage, you are advised to keep the security option active.

Wi-Fi Direct

Wi-Fi Direct supports a direct connection between Wi-Fi enabled devices without an access point. Due to the high battery usage of Wi-Fi direct, it is recommended that you plug your phone into a power outlet while using the Wi-Fi Direct feature. Check your Wi-Fi & Wi-Fi Directed network in advance and make sure the users are connected to the same network.

To turn on Wi-Fi Direct:

- 1 Tap the **Menu Key**  > **System settings** > **Networks** tab > **Wi-Fi**.
- 2 Tap the **Menu Key**  > **Wi-Fi Direct**.
- 3 Select a device to connect with from the scanned device list.

Using SmartShare

SmartShare uses DLNA (Digital Living Network Alliance) technology to share digital content through a wireless network. Both devices must be DLNA certified to support this feature. You can enjoy SmartShare feature on Gallery, Music, Video, and POLARIS Viewer 5.

- 1 On the content you want to play or beam, tap .
- 2 Tap **Play** or **Beam** in the dialog box.
 - **Play:** You can stream your content via TV, Bluetooth speaker, etc.
 - **Beam:** You can send your content to Bluetooth devices or SmartShare Beam*-supported LG phones or tablets.
*SmartShare Beam quickly transfers multimedia contents through Wi-Fi Direct.
- 3 Tap the device to play or receive on the list.

Connecting to Networks and Devices

- If the device is not on the list, make sure on the device that Wi-Fi, Wi-Fi Direct, or Bluetooth connection is turned on. And tap **Rescan**.

4 Tap **Send**.

To enjoy content from nearby devices such as a computer or mobile device on your phone

- 1 To connect the nearby devices to your phone, tap **Nearby devices** on **Gallery**, **Music**, or **Videos** application as below.

<Gallery>

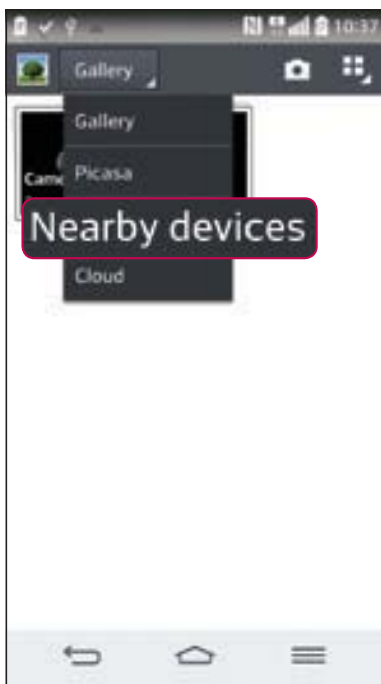

<Music>



<Videos>

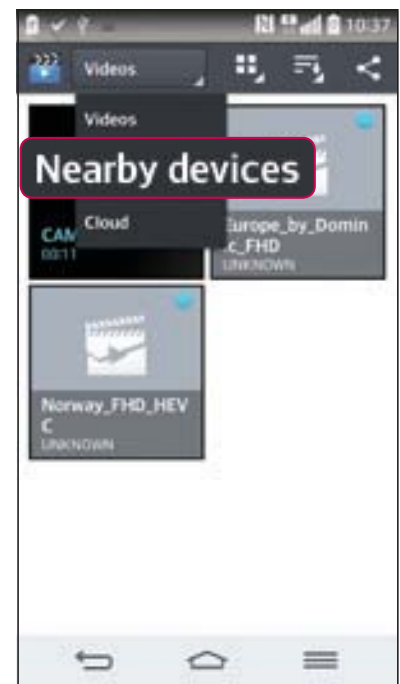

- Ensure that your phone and nearby devices are connected to the same Wi-Fi network.
- Make sure DLNA feature on the nearby device is turned on.

2 Tap the device to connect.

If the device is not on the list, tap **Search nearby devices**.

After connection, you can enjoy the contents from the nearby device on your phone.

PC connections with a USB cable

Learn to connect your device to a PC with a USB cable in USB connection modes.

Transferring music, photos and videos using the USB mass storage mode

- 1 Connect your phone to a PC using a USB cable.
- 2 If you haven't installed the LG Android Platform Driver on your PC, you will need to manually change the settings. Choose **System settings > General tab > PC connection > Select USB connection method**, then select **Media sync (MTP)**.
- 3 You can now view the mass storage content on your PC and transfer the files.

Synchronize with Windows Media Player

Ensure that Windows Media Player is installed on your PC.





- 1 Use the USB cable to connect the phone to a PC on which Windows Media Player has been installed.
 - 2 Select the **Media sync (MTP)** option. When connected, a pop-up window will appear on the PC.
 - 3 Open Windows Media Player to synchronize music files.
 - 4 Edit or enter your device's name in the pop-up window (if necessary).
 - 5 Select and drag the music files you want to the sync list.
 - 6 Start synchronization.
- The following requirements must be satisfied to synchronize with Windows Media Player.

Items	Requirement
OS	Microsoft Windows XP SP2, Vista or higher
Window Media Player version	Windows Media Player 10 or higher

- If the Windows Media Player version is lower than 10, install version 10 or higher.



Calls

Making a call

- 1 Tap  to open the keypad.
- 2 Enter the number using the keypad. To delete a digit, tap the .
- 3 Tap  to make a call.
- 4 To end a call, tap the **End** icon .

TIP! To enter "+" to make international calls, touch and hold .

Calling your contacts

- 1 Tap  to open your contacts.
- 2 Scroll through the contact list or enter the first few letters of the contact you want to call by tapping **Search contacts**.
- 3 In the list, tap  you want to call.

Answering and rejecting a call

When you receive a call in Lock state, swipe the  in any direction to Answer the incoming call.

Swipe the  in any direction to Decline an incoming call.

Swipe the **Decline with message** icon from the bottom if you want to send a message.







TIP! Decline with message

You can send a message quickly using this function. This is useful if you need to reject a call with message during a meeting.

Adjusting the in-call volume



To adjust the in-call volume during a call, use the Volume up and down keys on the back side of the phone.

Making a second call

- 1 During your first call, tap **Menu key**  > **Add call** and dial the number. You can also go to the recently dialled numbers list by tapping  or can search contacts by tapping  and selecting the contact you want to call.
- 2 Tap  to make the call.
- 3 Both calls are displayed on the call screen. Your initial call is locked and put on hold.
- 4 Tap the displayed number to toggle between calls. Or tap  **Merge calls** to start a conference call.
- 5 To end active calls, tap **End** or tap  and slide the notification bar down and select the **End call** icon .

NOTE: You are charged for each call you make.

Viewing your call logs

On the Home screen, tap  and choose the **Call logs** tab . View a complete list of all dialled, received and missed calls.



TIP!

- Tap any call log entry to view the date, time and duration of the call.
- Tap the **Menu key** , then tap **Delete all** to delete all the recorded items.

Calls

Call settings

You can configure phone call settings such as call forwarding, as well as other special features offered by your carrier.

- 1 On the Home screen, tap .
- 2 Tap .
- 3 Tap **Call settings** and choose the options that you wish to adjust.

Contacts



Add contacts to your phone and synchronize them with the contacts in your Google account or other accounts that support contact syncing.

Searching for a contact

On the Home screen

- 1 Tap  to open your contacts.
- 2 Tap **Search contacts** and enter the contact name using the keyboard.

Adding a new contact

- 1 Tap , enter the new contact's number, then tap the **Menu key** . Tap **Add to Contacts > New contact**.
- 2 If you want to add a picture to the new contact, tap the image area. Choose from **Take photo** or **Select from Gallery**.
- 3 Select the contact type by tapping .
- 4 Tap a category of contact information and enter the details about your contact.
- 5 Tap **Save**.

Favourites contacts



You can classify frequently called contacts as favourites.

Adding a contact to your favourites



- 1 Tap  to open your contacts.
- 2 Tap a contact to view its details.
- 3 Tap the star to the right corner of the contact's name. The star will turn yellow color.

Contacts

Removing a contact from your favourites list

- 1 Tap  to open your contacts.
- 2 Tap the  tab, and choose a contact to view its details.
- 3 Tap the yellow color star to the right corner of the contact's name. The star turns grey color and the contact is removed from your favourites.

Creating a group



- 1 Tap  to open your contacts.
- 2 Tap **Groups** and tap the **Menu key** . Select **New group**.
- 3 Enter a name for the new group. You can also set a ringtone for the newly created group.
- 4 Tap **Save** to save the group.

NOTE: If you delete a group, the contacts assigned to that group will not be lost. They will remain in your contacts.

Messaging

Your phone combines SMS and MMS into one intuitive, easy-to-use menu.

Sending a message

- 1 Tap  on the Home screen and tap  to open a blank message.
- 2 Enter a contact name or contact number in the **To** field. As you enter the contact name, matching contacts will appear. You can tap a suggested recipient. You can add more than one contact.

NOTE: You will be charged for a text message for every person to whom you send the message.

- 3 Tap the **Enter message** field and begin composing your message.
- 4 Tap  to open the Options menu. Choose from **Quick message**, **Insert smiley**, **Schedule sending**, **Add subject** and **Discard**.

TIP! You can tap the  icon to attach the file, that you want to share with message.

- 5 Tap **Send** to send your message.
- 6 Responses will appear on the screen. As you view and send additional messages, a message thread is created.

WARNING:

- The 160-character limit may vary from country to country, depending on the language and how the SMS is coded.
- If an image, video or audio file is added to an SMS message, it is automatically converted into an MMS message and you are charged accordingly.

Messaging

Threaded box

Messages (SMS, MMS) exchanged with another party can be displayed in chronological order so that you can conveniently see an overview of your conversation.

Changing your message settings

Your phone message settings are pre-defined, so you can send messages immediately. You can change the settings according to your preferences.

- Tap the **Messaging** icon on the Home screen, tap  and then tap **Settings**.

E-mail

You can use the E-mail application to read emails from services like Gmail. The E-mail application supports the following account types: POP3, IMAP and Exchange.

Your service provider or system administrator can provide you with the account settings you need.

Managing an email account

The first time you open the **E-mail** application, a set-up wizard opens to help you to set up an email account.

After the initial set-up, E-mail displays the contents of your inbox.

To add another email account:

- Tap  >  > **Apps** tab > **E-mail** > tap  > **Settings** >  **Add account**.

To change an email account's settings:

- Tap  >  > **Apps** tab > **E-mail** > tap  > **Settings** > **General settings**.

To delete an email account:

- Tap  >  > **Apps** tab > **E-mail** > tap  > **Settings** > tap  > **Remove account** > Select the account to delete > **Remove** > select **Yes**.





Working with account folders

Tap  >  > **Apps** tab > **E-mail** > tap  and select **Folders**.

Each account has an Inbox, Outbox, Sent and Drafts folder. Depending on the features supported by your account's service provider, you may have additional folders.

Composing and sending email

To compose and send a message

- 1 While in the **E-mail** application, tap the .
- 2 Enter an address for the message's intended recipient. As you enter text, matching addresses will be proposed from your Contacts. Separate multiple addresses using semicolons.
- 3 Tap the  to add a Cc/Bcc and tap  to attach files, if required.
- 4 Enter the text of the message.
- 5 Tap .

TIP! When a new email arrives in your Inbox, you will be notified by a sound or vibration.



Camera

With the OIS (Optical Image Stabilizer) camera on the phone, you can take a clearer picture by removing physical shaking. The Multi Point AF (Autofocus) feature enables you to get a clearer and natural picture even if the objects are not in the center.

To open the Camera application, tap **Camera**  on the Home screen.

Getting to know the viewfinder















- 1 Flash** – Choose from **Off** , **On** , **Auto** .
- 2 Swap camera** – Switch between the rear-facing camera lens and the front-facing camera lens.
- 3 Shot mode** – Choose from **Normal**, **Shot & Clear**, **Dynamic tone (HDR)**, **Panorama**, **VR panorama**, **Burst shot**, **Beauty shot**, **Dual camera**, **Time catch shot**, **Intelligent auto**, **Sports** or **Night**.
- 4 Settings** – Tap this icon to open the settings menu.
- 5 Video mode** – Tap and slide down this icon to switch to video mode.
- 6 Capture button**
- 7 Gallery** – Tap to view the last photo you captured. This enables you to access your gallery and view saved photos while in camera mode.

NOTE: Please ensure the camera lens is clean before taking pictures.

Camera

Using the advanced settings

In the viewfinder, tap  to open the advanced options. You can change the camera settings by scrolling through the list. After selecting the option, tap .

	To take a photo, say one of the following words: Cheese, Smile, Whisky, Kimchi or LG.
	Defines and controls the amount of sunlight entering the photo.
	Tap to select the focus mode.
	Selects photo resolution. If you choose high resolution, file size will increase, which means you will be able to store fewer photos in the memory.
	The ISO rating determines the sensitivity of the camera's light sensor. The higher the ISO, the more sensitive the camera. This is useful in darker conditions when you cannot use the flash.
	Improves color quality in various lighting conditions.
	Applies artistic effects to your pictures.
	Sets a delay after the capture button is pressed. This is ideal if you want to be in the photo.
	Activate this to use your phone's location-based services. Take pictures wherever you are and tag them with the location. If you upload tagged pictures to a blog that supports Geotagging, you can see the pictures displayed on a map. NOTE: This function is only available when the GPS function is active.
	Selects a shutter sound.
	Set the Volume Key whether to use for the capture or zoom.
	Opens the help guide to know how a function operates.



Restores all camera default settings.

TIP!



- When you exit the camera, some settings return to their defaults, such as white balance, color effect, timer and shot mode. Check these before you take your next photo.
- The setting menu is superimposed over the viewfinder, so when you change photo color or quality elements, you will see a preview of the changed image behind the Settings menu.

Taking a quick photo

- 1 Open the **Camera** application and point the lens toward the subject you want to photograph.
- 2 Focus boxes will appear in the center of the viewfinder screen. You can also tap anywhere on the screen to focus on that spot.
- 3 When the focus box turns green, the camera has focused on your subject.
- 4 Tap  to capture the photo.

Using Shot & Clear mode

This feature allows the camera to identify objects you may not want in your photo. After taking the photo, tap an outlined object* to remove it, then save the photo.

- 1 Open the **Camera** application.
- 2 Tap  >  **Shot & Clear**.
- 3 Tap  to take a picture.

Camera

4 Tap any of the outlined objects to remove them from the photo, then tap .



* When taking a picture, moving objects are shown as dashed lines.

NOTES

- Take a picture after fixing the camera in one place.
- If the color of a subject is similar to the background, only a part may be detected or it may be difficult to erase.
- If a moving subject is too small or too large, it may be difficult to erase.
- If the subject is moving insignificantly, it may not be detected.



Using Dual camera mode

Allows you to take a picture with the front and rear cameras at the same time, combined into one picture.

- 1 Open the **Camera** application.
- 2 Tap  >  **Dual camera**.
- 3 A small viewfinder box appears on the main viewfinder screen. Set up your shot.
 - Drag the small viewfinder to move it where you want it in the shot.
 - Touch and hold the small viewfinder to resize it, if necessary.
 - Tap the small viewfinder to swap the lens between the main viewfinder and the small viewfinder.
- 4 Tap  to take the combined picture.

Using Time catch shot mode





Sets the camera to capture missing moments by taking five sequential pictures before  is tapped.

- 1 Open the **Camera** application.
- 2 Tap  >  **Time catch shot**.
- 3 Tap  to take a picture.

- 4 To view the moments just before the picture was taken, tap the image thumbnail at the bottom of the Camera screen.
- 5 Select the pictures that you want to keep, then tap  at the top of the screen.

Once you've taken a photo

Tap the image thumbnail at the bottom of the Camera screen to view the last photo you took.

	Tap to share your photo using the SmartShare function.
	Tap to take another photo immediately.
	Tap to send your photo to others or share it via social network services.
	Tap to delete the photo.

TIP! If you have an SNS account and set it up on your phone, you can share your photo with your SNS community.

NOTE: Additional charges may apply when MMS messages are downloaded while roaming.

Tap the **Menu key**  to open all advanced options.

Set image as – Tap to use the photo as a **Contact photo**, **Home screen wallpaper**, **Lock screen wallpaper** or **Wallpaper**.

Move – Tap to move the photo to another place.

Copy – Tap to copy the selected photo and save it to another album.

Copy to Clip Tray – Tap to copy the photo and store in the Clip Tray.

Rename – Tap to edit the name of the selected photo.

Rotate left/right – To rotate left or right.

Camera

Crop – Crop your photo. Move your finger across the screen to select the area to be cropped.

Edit – View and edit the photo.

Slideshow – Automatically shows you the images in the current folder one after the other.

Add location – To add the location information.

Details – Find out more information about the file.

From your Gallery



Tap  **Gallery** and select **Camera**.

- To view more photos, scroll left or right.
- To zoom in or out, double-tap the screen or place two fingers and spread them apart (move your fingers closer together to zoom out).

Video camera

Getting to know the viewfinder



- 1 Flash** – Choose from **Off** , **On** , **Auto** .
- 2 Swap camera** – Switch between the rear-facing camera lens and the front-facing camera lens.
- 3 Recording mode** – Choose from **Normal**, **Live effect**, **Dual recording**, or **Tracking zoom**.
- 4 Settings** – Tap this icon to open the settings menu.
- 5 Camera mode** – Tap and slide up this icon to switch to camera mode.
- 6 Start recording**
- 7 Gallery** – Tap to view the last video you recorded. This enables you to access your gallery and view your saved videos while in video mode.









TIP!

When recording a video, place two fingers on the screen and pinch to use the Zoom function.



Video camera

Using the advanced settings

Using the viewfinder, tap  to open all the advanced options.

	<p>Tap to turn on Audio zoom feature. You can record only the sound you want clearly and loudly. After turning this on, focus the subject you want to zoom, on inside the blue circle. To zoom in on sounds as well as sight, pinch in.</p> <p>NOTES</p> <ul style="list-style-type: none">• Only available in landscape view.• Do not cover the microphones on both sides.
	<p>Tap to set the size (in pixels) of the video you are recording.</p>
	<p>Defines and controls of the amount of sunlight entering the lens. Slide the brightness indicator along the bar towards “-” for a lower brightness video or towards “+” for a higher brightness video.</p>
	<p>Improves color quality in various lighting conditions.</p>
	<p>Choose a colour tone to use for your new view.</p>
	<p>Activate this to use your phone's location-based services.</p>
	<p>Set the Volume Key whether to use for the record or zoom.</p>
	<p>Opens the help guide to know how a function operates.</p>
	<p>Restores all camera default settings.</p>

Recording a quick video

- 1 Open the **Camera** application and slide the **Video mode** button.
- 2 The video camera viewfinder appears on the screen.
- 3 Holding the phone, point the lens towards the subject you wish to capture in your video.
- 4 Tap  once to start recording.
- 5 A red light will appear at the top left corner of the viewfinder with a timer showing the length of the video.
- 6 Tap  on the screen to stop recording.





TIP!

 – Tap to capture image during recording a video.

 – Tap to pause during recording a video.

After recording a video

In the viewfinder, tap the video thumbnail at the bottom of the screen to view the last video you took.

	Tap to share your video using the SmartShare function.
	Tap to record another video immediately.
	Tap to send your video to others or share it via social network services.
	Tap to delete the video.

NOTE: Additional charges may apply when MMS messages are downloaded while roaming.

Video camera

From your Gallery





Tap  **Gallery** and select **Camera**. Tap on video play icon  to play the video.

Adjusting the volume when viewing a video

To adjust the volume of a video while it is playing, use the volume keys on the back side of the phone.

Using Audio Zoom

Focuses the audio recording on a particular area of your choosing; this will increase microphone sensitivity and reduce background noise.





- 1 Open the **Camera** application and change to video mode
- 2 Tap  >  **Audio zoom** and select **On**.
- 3 Tap an empty space on viewfinder to close the Setting pop-up window.
- 4 Hold the phone horizontally and tap  to start recording.
- 5 Focus the subject you want to zoom in on inside the blue circle. Then, pinch to zoom in to increase sound sensitivity and decrease noise.
- 6 Tap  to stop recording.

NOTES

- Do not cover the side microphones while using this feature.
- You must record in landscape orientation to use this function.





Using Dual recording mode

Allows you to record videos with the front and rear cameras at the same time, combined into one recording.

- 1 Open the **Camera** application and change to video mode
- 2 Tap  >  **Dual recording**.
- 3 A small viewfinder box appears on the main viewfinder screen. Set up your shot.
 - Drag the small viewfinder to move it where you want it in the shot.
 - Touch and hold the small viewfinder to resize it, if necessary.
 - Tap the small viewfinder to swap the lens between the main viewfinder and the small viewfinder.
- 4 Tap  to start dual recording.
- 5 Tap  to stop dual recording.

Using Tracking zoom mode

Allows you to define an area of the recording to focus on and enlarge. You can set the area before recording, then move it as necessary during the recording.

- 1 Open the **Camera** application and change to video mode
- 2 Tap  >  **Tracking zoom**.
- 3 Drag the magnifying glass to the area to enlarge. The small screen shows the defined focus in large view.
- 4 Tap  to start recording.
 - While recording, you can move the small screen. Touch and drag it to the desired location.
- 5 Tap  to stop recording.

Function

QuickMemo

The **QuickMemo** allows you to create memos and capture screen shots. Capture screens, draw on them and share them with family and friends with QuickMemo.

- 1 (While screen is switched off) Press and hold the Volume Up key.



OR

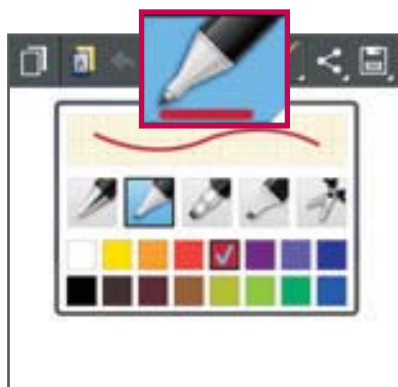
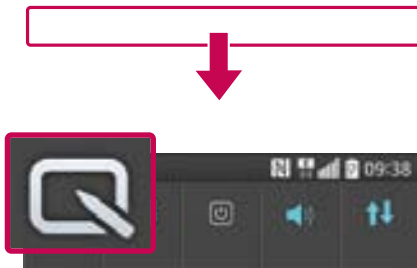

OR

Touch and slide the status bar downward and tap .

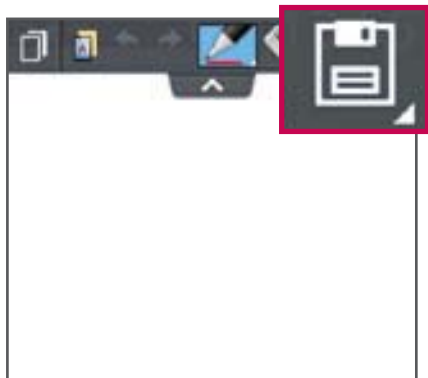

- 2 Select the desired menu option from **Pen type**, **Colour**, **Eraser** and create a memo.









- 3 Tap  in the Edit menu to save the memo with the current screen. To exit QuickMemo at any time, tap .

NOTE: Please use a fingertip while using the QuickMemo. Do not use your fingernail.

Using the QuickMemo options

You can easily use the QuickMenu options when using the QuickMemo.

	Tap to keep the current QuickMemo as a text overlay on the screen and continue to use the phone.
	Selects whether to use the background screen or not.
	Undo or Redo.
	Selects the pen type and the colour.
	Erases the memo that you created.
	Tap to share the memo with others via any of the available applications.
	Saves the memo with the current screen in the Gallery or Notebook .

Viewing the saved QuickMemo

Tap **Notebook/Gallery** and select the QuickMemo album.

QuickTranslator

Simply aim the camera of your smart phone at the foreign sentence you want to

Function

understand. You can get the real-time translation anywhere and anytime. You can buy additional dictionaries for offline translation from the Google Play Store.

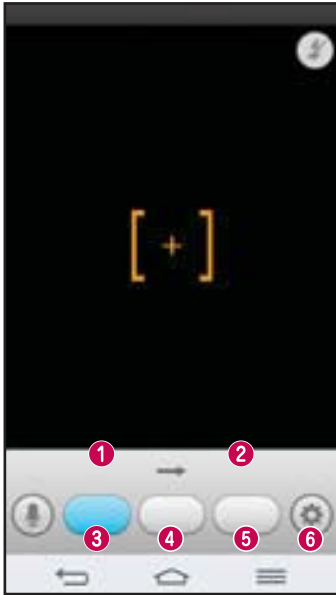

- 1 Home language.
- 2 Destination language.
- 3 Translation of word.
- 4 Translation of sentence.
- 5 Translation of block.
- 6 Settings.

- 1 Tap > > **Apps** tab > **QuickTranslator**.
- 2 Tap **Word**, **Line** or **Block**.
- 3 Tap and select the desired language.
- 4 Hold the phone toward the subject you want to translate for a few seconds.

NOTE: Only one dictionary is provided free of charge. Additional dictionaries must be purchased. Please select from the list below the dictionary you would like to install as your complimentary dictionary.

NOTE: There may be a difference in the rate of recognition depending on the size, font, color, brightness and angle of the letters that need to be translated.

QSlide

From any screen, bring up a notepad, calendar, and more as a window inside your

screen.

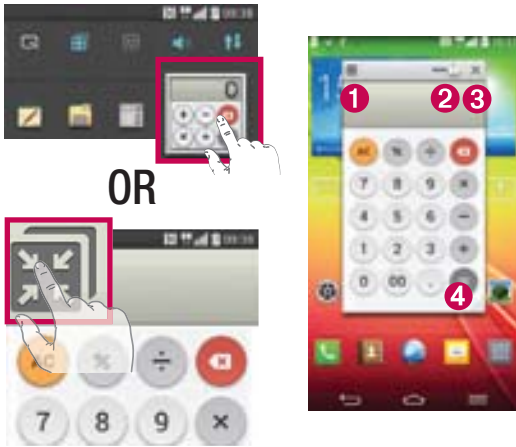

1		Tap to exit the QSlide and return to full window.
2		Tap to adjust transparency.
3		Tap to end the QSlide.
4		Tap to adjust the size.

- 1 Touch and slide the status bar downwards > tap QSlide apps or while using applications that support QSlide, tap . The function will be continuously displayed as a small window on your screen.
- 2 You can make a call, browse the Web, or choose other phone options. You can also use and tap the screen under the small windows when the transparency bar is not full

NOTE: The QSlide can support up to two windows at the same time.

Function

QuickRemote

QuickRemote turns your phone into a Universal Remote for your home TV, Set top box, audio system, DVD/Blu-ray players, air conditioner and projector.

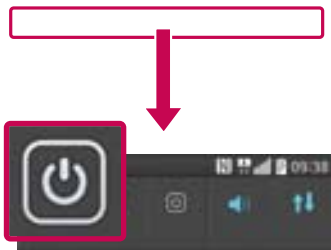

- 1 Touch and slide the status bar downwards and tap  > **ADD REMOTE**.

OR

Tap  >  > **Apps** tab >  > tap .

- 2 Select the type and brand of device, then follow the on-screen instructions to configure the device(s).

- 3 Touch and slide the status bar downwards and use QuickRemote functions.

Tap the **Menu key**  to select **Magic Remote setting, Edit remote name, Learn remote, Move remote, Delete remote, Edit room, Settings** and **Help**.

NOTE: The QuickRemote operates the same way as an ordinary remote control infrared (IR) signals. Be careful not to cover the infrared sensor at the top of the phone when you use the QuickRemote function. This function may not be supported depending on the model, the manufacturer or service company.

Zoom to Track

When you play a video, you can enlarge an object while tracking it.

- 1 When you play a video, tap .
- 2 Touch the magnifying glass and drag it to the object to track.



NOTE: Zoom to Track may not be available if the object moves too fast or off from the screen.

Function

Live Zooming

Live Zooming allows you to zoom in or zoom out on a portion of a video that is being played to make the desired section appear larger or smaller.

When viewing a video, use your index finger and thumb in a pinching or spreading motion to zoom in or out.

NOTE:

- While a video is playing, slide left side on the screen up or down to adjust the screen brightness.
- While a video is playing, slide right side of the screen up or down to adjust the screen volume.
- While playing a video, slide the screen left or right to rewind or fast-forward.
- Do not press too hard; the touch screen is sensitive enough to pick up a light, but firm tap.

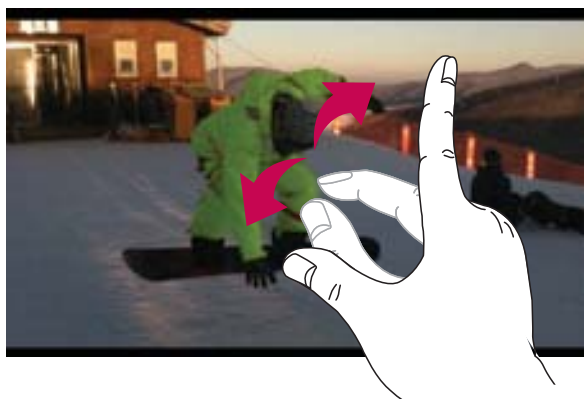



VuTalk

With the VuTalk feature, you can make an interactive and more creative notes with the other party. Visual communication is possible while sharing a photo, a map or camera preview.

NOTE:

- Only available with a phone that supports this feature as well.
- You can also use the VuTalk feature during a call.
- The screen will lock if there is no input.
- Requires data connection. Data charge will apply to both phones.

Register VuTalk Before Use

1 Tap  >  **Contacts** > .

You can also register VuTalk service while you are in a call.

2 Read the LG apps terms and conditions and privacy policy. If you agree, tap the check boxes, then tap **Accept**.

VuTalk Settings









1 Tap  >  **Contacts** >  > **VuTalk settings** .

2 Set the following options as your preferences.

- **Notification sound:** Select the desired notification sound.
- **Vibrate:** Select the desired vibrate type.
- **Show request:** Checkmark this option to display a pop-up when a VuTalk request is received.
- **Contact sync:** Checkmark this option to sync contacts.

Function

Communicate Visually with VuTalk

- 1 Tap  >  **Contacts** > .
- Only the contacts who use the VuTalk feature will be displayed.
- 2 Tap a contact to start VuTalk with.
- 3 In the contact's details screen, tap . After the other party accepts your VuTalk request, you can start VuTalk with him/her.
- 4 Use the VuTalk screen to chat and visually communicate with your friend.
 - Tap  to attach a photo, take a new photo, map view, or a sticker.
 - Tap the Pen icon  and Eraser  icon to write on the images you attached.
- 5 When you finish VuTalk, tap  or to exit the VuTalk feature.
The created VuTalk screen is stored in the **Notebook** app.

NOTE: If you tap  and go back to the Home screen, the VuTalk feature still runs in the background.

Voice Mate

Voice Mate allows you hands-free interaction with your devices. You can ask Voice Mate to perform phone functions using your voice, such as calling a contact, setting alarms or searching the web. When you access this feature for the first time, it displays help information to assist you in learning how to use this function.

NOTE:

- You can use Voice Mate after agreeing the End User License Agreement and Privacy policy.
- You can view examples of various commands by swiping the Voice Mate main screen to the left.
- You can also launch Voice Mate using the Quick Access feature.

Use Voice Mate

- 1 Tap  >  >  **Voice Mate**.
- 2 Tap  to turn it on. Say what you want it to do for you.

TIP! Use Voice Mate in a quiet environment so it can accurately recognize your commands.

Voice Mate Settings

- 1 Tap  >  >  **Voice Mate**.
- 2 Tap  > **Settings** to configure the environment settings.

LG SmartWorld

LG SmartWorld offers an assortment of exciting content - games, applications, wallpaper and ringtones - giving LG phone users the chance to enjoy richer "Mobile Life" experiences.

How to Get to LG SmartWorld from Your Phone

- 1 Tap  >  > **Apps** tab > tap the  icon to access **LG SmartWorld**.
- 2 Tap Sign in and enter ID/PW for LG SmartWorld. If you have not signed up yet, tap Register to receive your LG SmartWorld membership.
- 3 Download the content you want.

NOTE: What if there is no icon?

- 1 Using a mobile Web browser, access LG SmartWorld (www.lgworld.com) and select your country.
- 2 Download the LG SmartWorld App.
- 3 Run and install the downloaded file.
- 4 Access LG SmartWorld by tapping the  icon.

Function

How to use LG SmartWorld

- Participate in monthly LG SmartWorld promotions.



Search content.



Find content by category (e.g. Games, Education, Entertainment etc).

- Try the easy "Menu" buttons to find what you're looking for fast.

Settings – Set Profile and Display.

Sign in – Set your ID and Password.

- Try other useful functions as well. (Content Detail screen)

NOTE: LG SmartWorld may not be available from all carriers or in all countries.

On-Screen Phone

On-Screen Phone allows you to view your mobile phone screen from a PC via a USB or Wi-Fi connection. You can also control your mobile phone from your PC, using the mouse or keyboard.

On-Screen Phone icons



Connects your mobile phone to your PC, or disconnects it.



Changes the On-Screen Phone preferences.



Exits the On-Screen Phone programme.



Maximises the On-Screen Phone window.



Minimize the On-Screen Phone window.

On-Screen Phone features

- Real-time transfer and control: displays and controls your mobile phone screen when connected to your PC.
- Mouse control: allows you to control your mobile phone by using the mouse to click and drag on your PC screen.
- Text input with keyboard: allows you to compose a text message or note using your computer keyboard.
- File transfer (mobile phone to PC): sends files from your mobile phone (e.g. photos, videos, music and POLARIS Viewer 5 files) to your PC. Simply right-click on the file which you want to send to PC and click on "Save to PC".
- File transfer (PC to mobile phone): sends files from your PC to your mobile phone. Just select the files you wish to transfer and drag and drop them into the On-Screen Phone window. The files sent are stored in internal SD card.
- Real-time event notifications: prompts a pop-up to inform you of any incoming calls or text/multimedia messages.

How to install On-Screen Phone on your PC

- 1 Visit LG Home (www.lg.com) and select a country of your choice.
- 2 Go to **Support** > **Mobile Phone Support** > Select the Model (LG-D855P) > Click **OSP** (On-Screen Phone) to download. You can install the On-Screen Phone on your PC.

Multimedia

Gallery

Open the **Gallery** application to view albums of your pictures and videos.

1 Tap  >  > **Apps** tab >  **Gallery**.

You can manage and share all your image and video files with Gallery.

NOTE:

- Some file formats are not supported, depending on the software installed on the device.
- Some files may not play properly, depending on how they are encoded.

Viewing pictures

Launching Gallery displays your available folders. When another application, such as Email, saves a picture, the download folder is automatically created to contain the picture. Likewise, capturing a screenshot automatically creates the Screenshots folder. Select a folder to open it.

Pictures are displayed by creation date in a folder. Select a picture to view it full screen. Scroll left or right to view the next or previous image.

Zooming in and out

Use one of the following methods to zoom in on an image:

- Double-tap anywhere to zoom in.
- Spread two fingers apart on any place to zoom in. Pinch to zoom out, or double-tap to return.

Playing videos

Video files show the  icon in the preview. Select a video to watch it and tap . The Videos application will launch.

Editing photos

When viewing an photo, tap the **Menu key**  > **Edit**.

Deleting photos/videos

Use one of the following methods:

- In a folder, tap  and select photos/videos by ticking, and then tap on **Delete**.
- When viewing a photo/Video, tap .

Setting as wallpaper

When viewing a photo, tap the **Menu key**  > **Set image as** to set the image as wallpaper or assign to a contact.

NOTE:



- Some file formats are not supported, depending on the device software.
- If the file size exceeds the available memory, an error can occur when you open files.













Videos

Your phone has a built-in video player that lets you play all of your favorite videos. To access the video player, tap  >  > **Apps** tab >  **Videos**.

Multimedia

Playing a video

- 1 Tap  >  > **Apps** tab >  **Videos**.
- 2 Select the video you want to play.

	Tap the desired direction for audio zoom.
	Tap to use Zoom to Track feature.
	Tap to enter into Qslide mode.
	Tap to share your video via the SmartShare function.
	Tap to lock a video screen.
	Tap to view the video list.
	Tap to capture the screen shot.
	Tap to pause video playback.
	Tap to resume video playback.
	Tap to go 10 seconds forward.
	Tap to go 10 seconds backward.
	Tap to manage the video volume.
	Tap to change the ratio of the video screen.

To change the volume while watching a video, press the up and down volume keys on the rear side of the phone.

Touch and hold a video in the list. The **Share**, **Delete**, **Trim** and **Details** options will be displayed.

Video Editor

You can edit the photos or videos stored on the phone.

▶ Tap  >  > **Apps tab** >  **Video Editor**.

NOTE: Video Editing function is supported only for photos or videos which recorded with this phone.

< Project list screen >







Project List Area

Tap a project to edit it.

Project Title

Tap here to edit the title.







Buttons Area

	Create a new project.
	Share the video project with other applications, such as YouTube.
	Export the finished project to play in other applications.
	Delete the video project.
	View the help information.

Multimedia

< Project edit screen >



	Tap to view the Project list screen.
	Tap to play the current clip.
	Tap to remove the last the selected clip.
	Tap to add additional video, images, or audio clips.
	Tap to choose to video style.
	Tap to add text in video clip.
	Tap to split video clip.

Music

Your phone has a built-in music player that lets you play all your favorite tracks. To access the music player, tap  >  > **Apps** tab >  **Music**.

Add music files to your phone

Start by transferring music files to your phone:



- Transfer music using Media sync (MTP).
- Download from the wireless Web.
- Synchronize your phone to a computer.









- Receive files via Bluetooth.

Transfer music using Media sync (MTP)



- 1 Connect the phone to your PC using the USB cable.
- 2 Select the **Media sync (MTP)** option. Your phone will appear as another hard drive on your computer. Click on the drive to view it. Copy the files from your PC to the drive folder.
- 3 When you're finished transferring files, swipe down on the Status Bar and tap **USB connected** > **Charge phone**. You may now safely unplug your device.

Playing a song

- 1 Tap  >  > **Apps** tab >  **Music**.
- 2 Tap **Songs**.
- 3 Select the song you want to play.

	Tap to pause playback.
	Tap to resume playback.
	Tap to skip to the next track in the album, playlist, or shuffle. Touch and hold to fast forward.
	Tap to restart the current track or skip to the previous track in the album, playlist, or shuffle. Touch and hold to rewind.
	Tap to display the Volume slider bar, then adjust the playback volume on the slider bar.
	Tap to set audio effects.
	Tap to find the files with YouTube.
	Tap to open the current playlist.
	Tap to add the song to your favourites.

Multimedia

	Tap to play the current playlist in shuffle mode (tracks are played in random order).
	Tap to toggle through the repeat modes to repeat all songs, repeat current song, or repeat off.
	Tap to share your music via the SmartShare function.

To change the volume while listening to music, press the up and down volume keys on the back side of the phone.

Touch and hold any song in the list. The **Play**, **Add to playlist**, **Share**, **Set as ringtone**, **Delete**, **Details** and **Search** options will be displayed.

NOTE:

- Some file formats are not supported, depending on the device software.
- If the file size exceeds the available memory, an error can occur when you open files.

NOTE: Music file copyrights may be protected by international treaties and national copyright laws.

Therefore, it may be necessary to obtain permission or a licence to reproduce or copy music.

In some countries, national laws prohibit private copying of copyrighted material. Before downloading or copying the file, check the national laws of the relevant country concerning the use of such material.

Utilities

Slide Aside (Quick task-switching with THREE fingers)

You can quickly switch to another task using three fingers.

- 1 Place three fingers on the screen which you are currently working on and slide the screen to the left. The current screen is saved and you can do another task.
 - You can save up 3 (three) apps in the left side of the screen.
- 2 To reopen the saved screen and continue to use the app, place three fingers on a screen and slide it to the right.



NOTE: Please be careful not to place another fingers or palm on the screen.

Guest Mode



To protect your privacy or limit some applications to your children, you can use the Guest mode.

When you lend your phone to others, you can limit the applications to be displayed. In advance, set the Guest mode and customize the options.

NOTE: To use the Guest mode, the pattern lock should be set in advance.

- 1 Tap  >  > **Apps** tab >  **Settings** > **General** tab > **Guest mode**.
- 2 Tap Use Guest mode to place a checkmark.





Setting your alarm

- 1 Tap  >  > **Apps** tab >  **Alarm/Clock** > .
- 2 After you set the alarm, your phone lets you know how much time is left before the alarm will go off.
- 3 Set **Repeat**, **Snooze duration**, **Vibration**, **Alarm sound**, **Alarm volume**, **Auto app starter**, **Puzzle lock** and **Memo**. Tap **Save**.





Utilities

NOTE: To change alarm settings in the alarm list screen, tap the **Menu key**  and select **Settings**.

Using your calculator

- 1 Tap  >  > **Apps** tab >  **Calculator**.
- 2 Tap the number keys to enter numbers.
- 3 For simple calculations, tap the function you want to perform (+, −, x or ÷) followed by =.
- 4 For more complex calculations, slide the left then choose sin, cos, tan, log etc.
- 5 To check the history, tap the icon .





Adding an event to your calendar

- 1 Tap  >  > **Apps** tab >  **Calendar**.
- 2 On the screen, you can find the different view types for the Calendar (Day, Week, Month, Year, Agenda, Life Square).
- 3 Tap on the date for which you wish to add an event and tap .
- 4 Tap **Event name** and enter the event name.
- 5 Tap **Location** and enter the location. Check the date and enter the time you wish your event to start and finish.
- 6 If you wish to add a note to your event, tap **Link note** to select the saved notebook image. (Only available on the Phone calendar)
- 7 If you wish to repeat the alarm, set **REPEAT** and set **REMINDERS**, if necessary.
- 8 Tap **Save** to save the event in the calendar.

Voice Recorder

Use the voice recorder to record voice memos or other audio files.

Recording a sound or voice

- 1 Tap  >  >  **Voice Recorder**.
- 2 Tap  to begin recording.
- 3 Tap  to end the recording.
- 4 Tap  to listen to the recording.

NOTE: Tap  to access your album. You can listen to the saved recording. The available recording time may differ from actual recording time.

Sending the voice recording

- 1 Once you have finished recording, you can send the audio clip by tapping .
- 2 Choose from **Bluetooth, Drive, E-mail, Gmail, Memo, Messaging** or **SmartShare Beam**. When you select **Bluetooth, Drive, E-mail, Gmail, Memo, Messaging** or **SmartShare Beam** the voice recording is added to the message. You may then write and send the message as you usually would.

Task Manager



You can manage your applications using Task Manager. You can easily check the number of applications that are currently running and shut down certain applications.

Utilities

Tasks

This task can be synchronized with MS Exchange account. You can create task, revise it and delete it in MS outlook or MS Office Outlook Web Access.



To Synchronize MS Exchange

- 1 From the Home Screen, Tap  >  > **Apps** tab >  **Settings**.
- 2 Tap **General** tab > **Accounts & sync** > **Add account**.
- 3 Tap **Microsoft Exchange** to create Email address and Password.
- 4 Make sure if you checkmark Sync task.

NOTE: MS Exchange may not be supported depending on email server.

POLARIS Viewer 5

POLARIS Viewer 5 is a professional mobile office solution that lets users conveniently view various types of office documents, including Word, Excel and PowerPoint files, anywhere or anytime, using their mobile devices.

Tap  >  > **Apps** tab >  **POLARIS Viewer 5**.

Viewing files

Mobile users can now easily view a wide variety of file types, including Microsoft Office documents and Adobe PDF, right on their mobile devices. When viewing documents using POLARIS Viewer 5, the objects and layout remain the same as in the original documents.

Google+



Use this application to stay connected with people via Google's social network service.

- Tap  >  > **Apps** tab >  **Google+**.

NOTE: This application may not be available depending on the region or service provider.

Voice Search

Use this application to search webpages using voice.

- 1 Tap  >  > **Apps** tab >  **Voice Search**.
- 2 Say a keyword or phrase when **Speak now** appears on the screen. Select one of the suggested keywords that appear.

NOTE: This application may not be available depending on the region or service provider.

Downloads

Use this application to see what files have been downloaded through the applications.

- Tap  >  > **Apps** tab >  **Downloads**.

NOTE: This application may not be available depending on the region or service provider.

The Web

Internet







Use this application to browse the Internet. Browser gives you a fast, full-color world of games, music, news, sports, entertainment and much more, right on your mobile phone wherever you are and whatever you enjoy.

NOTE: Additional charges apply when connecting to these services and downloading content. Check data charges with your network provider.

1 Tap  >  > **Apps** tab >  **Internet**.

Using the Web toolbar

Tap slide it upwards with your finger to open.

	Tap to go back one page.
	Tap to go forward one page, to the page you connected to after the current one. This is the opposite of what happens when you tap  , which takes you to the previous page.
	Tap to go to the Home page.
	Tap to add a new window.
	Tap to access bookmarks.

Viewing webpages

Tap the address field, enter the web address and tap **Go**.

Opening a page

To go to new page, tap  → .

To go to another webpage, tap , scroll up or down, and tap the page to select it.

Searching the web by voice

Tap the address field, tap , speak a keyword, and then select one of the suggested keywords that appear.

NOTE: This feature may not be available depending on the region or service provider.

Bookmarks

To bookmark the current webpage, tap  > **Add to bookmarks** > **OK**.

To open a bookmarked webpage, tap  and select one.

History

Tap  > **History** to open a webpage from the list of recently-visited webpages. To clear the history, tap **Menu key**  → **Clear all history**.

Using Popup Browser

Use this feature to access the Internet without closing the current application.

While viewing content, such as contacts or notes that include web addresses, select a web address and then tap Popup Browser to open the pop-up browser. Touch and drag the browser to move it to another location.

To view the browser in full screen, tap .

To close the browser, tap .

The Web

Chrome

Use Chrome to search for information and browse webpages.

1 Tap  >  > **Apps** tab >  **Chrome**.

NOTE: This application may not be available, depending on your region and service provider.

Viewing webpages

Tap the Address field, and then enter a web address or search criteria.

Opening a page

To go to a new page, tap  → **+ New tab**.

To go to another webpage, tap , scroll up or down and tap the page to select it.

Syncing with other devices

Sync open tabs and bookmarks to use with Chrome on another device when you are logged in with the same Google account.

To view open tabs on other devices, tap **Menu key**  → **Other devices**.

Select a webpage to open.

To add bookmarks, tap .

Settings

This section provides an overview of items you can change using your phone's System settings menus.

To access the Settings menu:

Tap  >  > **System settings.**

- or -

Tap  >  > **Apps tab** >  **Settings.**





Networks

< **Wi-Fi** >

Wi-Fi – Turns on Wi-Fi to connect to available Wi-Fi networks.

TIP! How to obtain the MAC address

To set up a connection in some wireless networks with MAC filters, you may need to enter the MAC address of your phone in the router.

You can find the MAC address in the following user interface: tap  >  > **Apps tab** >  **Settings** > **Networks tab** > **Wi-Fi** >  > **Advanced Wi-Fi** > **MAC address.**

< **Bluetooth** >

Turn the Bluetooth wireless feature on or off to use Bluetooth.

< **Mobile data** >

Displays the data usage and set mobile data usage limit.

< **Call** >

Configure phone call settings such as call forwarding and other special features offered by your carrier.

Voicemail – Allows you to select your carrier's voicemail service.

Fixed dialing numbers – Turn on and compile a list of numbers that can be called from your phone. You'll need your PIN2, which is available from your operator. Only numbers within the fixed dial list can be called from your phone.

Settings

Incoming call pop-up – Display incoming call popup when using camera and videos.

Call reject – Allows you to set the call reject function. Choose from **Call reject mode** or **Reject calls from**.

Decline with message – When you want to reject a call, you can send a quick message using this function. This is useful if you need to reject a call during a meeting.

Privacy keeper – Hides the caller name and number for an incoming call.

Call forwarding – Choose whether to divert all calls when the line is busy, when there is no answer or when you have no signal.

Auto answer – Set the time before a connected hands-free device automatically answers an incoming call. Choose from Disable, 1 second, 3 seconds, and 5 seconds.

Connection vibration – Vibrates your phone when the other party answers the call.

Voice enhancement – Enhances voice quality in noisy environments so you can hear more clearly.

Save unknown numbers – Add unknown numbers to contacts after a call.

Power button ends call – Allows you to select your end call.

Call barring – Lock incoming, outgoing or international calls.

Call duration – View the duration of calls including Last call, Outgoing calls, Incoming calls and All calls.

Additional call settings – Allows you to change the following settings:

Caller ID: Choose whether to display your number in an outgoing call.

Call waiting: If call waiting is activated, the handset will notify you of an incoming call while you are on a call (depending on your network provider).

< Share & connect >

NFC – Your phone is an NFC-enabled mobile phone. NFC (Near Field Communication) is a wireless connectivity technology that enables two-way communication between electronic devices. It operates over a distance of a few centimeters. You can share your content with an NFC tag or another NFC support device by simply tapping it with your device. If you tap an NFC tag with your device, it will display the tag content on your device.

To switch NFC on or off: From the Home screen, touch and slide the notification panel down with your finger, then select the NFC icon to turn it on.

NOTE: When airplane mode is activated, the NFC application can be used.

Using NFC: To use NFC, make sure your device is switched on, and activate NFC if disabled.

Android Beam – When this feature is turned on, you can beam app content to another NFC-capable device by holding the devices close together.

Just bring the device together (typically back to back) and then tap your screen. The app determines what gets beamed.

SmartShare Beam – Enable to receive files from LG phones.

Miracast – Mirror phone screen and sound onto Miracast dongle or TV Wirelessly.

Wireless storage – You can manage files on your phone in the computer or copy files to the phone from the computer without a USB connection. After switching on Wireless storage, make sure that the phone and computer are connected to the same network. Then, enter the web addresses shown on your phone in the address bar of the browser on your computer.

< Tethering & networks >

Wi-Fi hotspot – You can also use your phone to provide a mobile broadband connection. Create a hotspot and share your connection. Please "**Sharing your phone's data connection**" for more information.

Bluetooth tethering – Allows you to set your phone whether you are sharing the Internet connection or not.

Help – Tap to view help information on the Wi-Fi hotspot and Bluetooth tethering functions.

Airplane mode – After switching to Airplane mode, all wireless connections are disabled.

Settings

NOTE: You must set a lock screen PIN or password before you can use credential storage.

Mobile networks – Set options for data roaming, network mode & operators, access point names (APNs) etc.

Default SMS app – Allows you to set the default SMS app.

VPN – Displays the list of Virtual Private Networks (VPNs) that you've previously configured. Allows you to add different types of VPNs.

Sound

Sound profile – Choose the Sound, either Vibrate only or Silent.

Volumes – Adjust the phone's volume settings to suit your needs and your environment.

Vibrate strength – Allows you to set the vibrate strength for calls, notifications, and touch feedback.

Quiet mode – Set up your Quiet mode. Tap the **Turn quiet mode on now** switch to toggle it On or Off. You can schedule Quiet mode to activate automatically and designate exceptions to your Quiet mode.

Set quiet time: Tap the switch to toggle it On or Off. You can also set the days and times to automatically turn Quiet mode on.

Incoming call settings

Block incoming calls: Checkmark to block all incoming calls.

Allow repeated calls: Checkmark to allow a call that is repeated within 3 minutes.

Allowed contact lists: Designate which Contacts calls will be allowed.

Auto reply to blocked calls: Set how to you want to automatically reply to silenced calls.

Phone ringtone – Set the ringtone for calls. You can also add a ringtone by tapping  at the top right corner of the screen.

Smart ringtone – Checkmark to increase phone ringtone volume automatically in noisy environments.

Incoming call vibration – Sets the incoming call vibration Options.

Gentle vibration – Checkmark to gradually increasing vibration up to current strength set.

Ringtone with vibration – Checkmark to set the phone to vibrate in addition to the ringtone when you receive calls.

Voice notifications – Tap the **Voice notifications** switch to toggle it On or Off. On allows your device to incoming call and message events automatically.

Notification sound – Allows you to set the sound for notifications. You can also add a sound by tapping  at the top right corner of the screen.

Touch feedback & system – Allows you to set the feedback (tones and/or vibration) while using your device.

Display

< Home screen >

Set the **Theme**, **Wallpaper**, **Screen swipe effect**, **Allow Home screen looping**, or **Portrait view only**.

Home backup & restore – You can backup and restore app/widget layouts and themes.

Do you know? – Select whether to include an additional Home screen for Do you know, which is a video guide for the new features of G2.

Help – Tap to view help information on Home screen.

< Lock screen >

Select screen lock – Set a screen lock type to secure your phone. Opens a set of screens that guide you through drawing a screen unlock pattern. Set **None**, **Swipe**, **Face Unlock**, **Pattern**, **PIN** or **Password**.

Settings

If you have enabled a Pattern lock type when you turn on your phone or wake up the screen, you will be asked to draw your unlock pattern to unlock the screen.

Screen swipe effect – Sets the screen swipe effect options. Choose from Ripple, Dewdrop, White hole, Particle, and Crystal.

NOTE: This setting name may be Pattern effect if the Screen lock is set to Pattern.

Weather animation – Checkmark to show weather animation for current location or primary city set in Weather based on auto data updates.

Wallpaper – Sets your Lock screen wallpaper. Select it from **Gallery** or **Wallpaper gallery**.

Shortcuts – Allows you to change the shortcuts on the **Swipe** Lock screen.

Owner info – Checkmark to set the device owner's name to be displayed on the Lock screen. Tap  to enter the text to be displayed as the Owner info.

Lock timer – Sets the amount of time before the screen automatically locks after the screen has timed-out.

Power button instantly locks – Checkmark to instantly lock the screen when the Power/Lock Key is pressed. This setting overrides the Security lock timer setting.

< Front touch buttons >

Set the Front Touch Keys displayed at the bottom of all of the screens. Set which ones are displayed, their position on the bar, and what they look like. Select the keys and order, the theme, and the background.

< SCREEN >

Brightness – Adjusts the brightness of the screen. For best battery performance, use the dimmest comfortable brightness.

Screen timeout – Sets the amount of time before the screen times out.

Screen-off effect – Sets the screen-off effect. Choose from Fade out, Black hole, and Retro TV.

Auto-rotate screen – Checkmark to set the phone to automatically rotate the screen based on the phone orientation (portrait or landscape).

Daydream – Tap the Daydream switch to toggle it On or Off. On allows the set screensaver to be displayed when the phone is sleeping while docked and/or charging. Choose from Clock, Colors, Photo Frame, and Photo Table.

< FONT >

Font type – Sets the type of font used for the phone and menus.

Font size – Sets the size of the font displayed in the phone and menus.

< SMART ON >

Smart screen – Checkmark to keep the screen from timing-out when the device detects your eyes looking at the screen.

Smart video – Checkmark to pause the video when it doesn't detect your eyes looking at the screen.

< ADVANCED SETTINGS >

Notification LED – Tap the switch to toggle it On or Off. On will activate the LED light for the notifications you select, in the color you set for each one.

General

< Gestures >

Screen on/off – Checkmark to enable KnockON to turn the screen on and off. Quickly double-tap center screen to turn it on. Double-tap the Status Bar, an empty area on the Home screen, or the Lock screen to turn the screen off. For the best results, do not move the phone while using the KnockON feature.

Answer an incoming call – Checkmark to enable you to bring the phone to your ear to automatically answer the incoming call.

Fade out ringtone – Checkmark to enable you to pick up the phone from the flat surface to fade out the incoming call ringtone.

Settings

Silence incoming calls – Checkmark to enable you to flip the phone to silence incoming calls.

Snooze or turn off alarm – Checkmark to enable you to simply flip the device to snooze or stop the alarm.

Pause video – Checkmark to enable you to simply flip the device to pause the currently playing video.

Help – Opens a help guide on how to use the Gestures features of your device.

Motion sensor calibration – Allows you to improve the accuracy of the tilt and speed of the sensor.

< One-handed operation >

Dial keypad – Checkmark to enable you move the dial keypad to the right or left side of the device. Simply tap the arrow to move it to one side or the other.

LG keyboard – Checkmark to enable you move the keyboard to the right or left side of the device. Simply tap the arrow to move it to one side or the other.

Lock screen – Checkmark to enable you move the PIN Lock screen keypad to the right or left side of the device. Simply tap the arrow to move it to one side or the other.

Help – Displays information regarding one-handed operation.

< Storage >

INTERNAL STORAGE – View the internal storage usage.

< Battery >

BATTERY INFORMATION

The Battery charge information is displayed on a battery graphic along with the percentage of the remaining charge and its status.

Touch the Battery charge icon to display the Battery use screen to see battery usage level and battery use details. It displays which components and applications are using the most battery power. Tap one of the entries to see more detailed information.

Battery percentage on status bar – Checkmark to display the battery level percentage on the Status Bar next to the battery icon.

BATTERY SAVER

Tap the Battery saver switch to toggle it On or Off. Tap Battery saver to access the following settings:

Turn Battery saver on – Sets the battery charge percent level that will automatically turn on Battery saver. Choose from Immediately, 10% battery, 20% battery, 30% battery, and 50% battery.

BATTERY SAVING ITEMS

Auto-sync – Checkmark to turn off Auto-sync when Battery saver is activated.

Wi-Fi – Checkmark to turn Wi-Fi off when data is not being used while Battery saver is activated.

Bluetooth – Checkmark to turn Bluetooth off when not connected while Battery saver is activated.

Vibrate on touch – Checkmark to turn off touch feedback when Battery saver is activated.

Brightness – Checkmark to set the screen brightness when Battery saver is activated. Tap  to change the setting.

Screen timeout – Checkmark to set the screen timeout when Battery saver is activated. Tap the Settings icon to change the setting.

Notification LED – Checkmark to turn off the LED light for notifications when Battery saver is activated.

< Apps >

View and manage your applications.

< Slide Aside >

Tap the **Slide Aside** switch to toggle it on to use Slide Aside feature. (Please see **Slide Aside**.)

Settings

< **Accounts & sync** >

Permits applications to synchronize data in the background, whether or not you are actively working in them. Deselecting this setting can save battery power and lower (but not eliminate) data usage.

< **Cloud** >

Add a cloud account to quickly and easily use cloud service on LG apps.

< **Guest mode** >

To protect your privacy or limit some applications to your children, you can use the Guest mode.

When you lend your phone to others, you can limit the applications to be displayed. In advance, set the Guest mode and customize the options.

< **Location** >

Turn on location service, your phone determines your approximate location using GPS, Wi-Fi and mobile networks.

Mode – Set the location mode from **High accuracy**, **Battery saving** and **Device sensors only**.

Google Location Reporting – Select whether to turn on or off **Google Location Reporting** options. For further information, tap  > **Help**.

< **Security** >

Encrypt phone – Allows you to encrypt data on the phone for security. You will be required to enter a PIN or password to decrypt your phone each time you power it on.

Set up SIM card lock – Set up Micro-USIM card lock or change the Micro-USIM card PIN.

Password typing visible – Show the last character of the hidden password as you type.

Phone administrators – View or deactivate phone administrators.

Unknown source – Default setting to install non-Play store applications.

Verify apps – Disallow or warn before installation of apps that may cause harm.

Storage type – Software only

Trusted credentials – Display trusted CA certificates.

Install from storage – Choose to install encrypted certificates.

Clear credentials – Remove all certificates.

< Language & input >

Use the Language & input settings to select the language for the text on your phone and to configure the on-screen keyboard, including words you've added to its dictionary.

< Backup & reset >

Change the settings for managing your settings and data.

Backup my data – Set to backup your settings and application data to the Google server.

Backup account – Set to backup your account.

Automatic restore – Set to restore your settings and application data when the applications are reinstalled on your device.

LG Backup service – Backs up all information on the device and restores it in the event of data loss or replacement.

Factory data reset – Reset your settings to the factory default values and delete all your data. If you reset the phone this way, you are prompted to re-enter the same information as when you first started Android.

< Date & time >

Use **Date & time** settings to set how dates will be displayed. You can also use these settings to set your own time and time zone rather than obtaining the current time from the mobile network.

< Accessibility >

Use the **Accessibility** settings to configure accessibility plug-ins you have installed on your phone.

NOTE: Requires additional plug-ins to become selectable.

Settings

< PC connection >

Select USB connection method – Set the desired mode: **Charge phone**, **Media sync (MTP)**, **Tethering**, **LG software** or **Send images (PTP)**.

Ask upon connecting – Ask in USB connection mode when connecting to a computer.

Help – Help for USB connection.

PC Suite – Check this to use LG PC Suite with your Wi-Fi connection.

Please note that Wi-Fi network should be connected to LG PC Suite via a Wi-Fi connection.

Help – Help for LG software.

< Accessory >

QuickWindow case – Activate to make features, such as music, weather, and clock, available in small view when using the QuickWindow case.

USB storage – Sets the Plug & Pop feature for USB storage. Checkmark the **App panel** option to automatically display the app panel when connecting an OTG (On-the-Go) USB cable. Tap **Edit app panel** to change the applications you want to make available.

Earphone – Sets the Plug & Pop feature for earphones. Checkmark the **App panel** option to automatically display the app panel when connecting an earphone. Tap **Edit app panel** to change the applications you want to make available.

< About phone >

View legal information and check your phone status and software version.

< Regulatory and Safety Information >

To view regulatory and safety information, tap  **Settings** > **General** tab > **About phone** > **Regulatory and Safety**.

PC software (LG PC Suite)

"LG PC Suite" PC software is a program that helps you connect your device to a PC via a USB cable and Wi-Fi. Once connected, you can use the functions of your device from your PC.

With your "LG PC Suite" PC Software, You Can...

- Manage and play your media contents (music, movie, picture) on your PC.
- Send multimedia contents to your device.
- Synchronizes data (schedules, contacts, bookmarks) in your device and PC.
- Backup the applications in your device.
- Update the softwares in your device.
- Backup and restore the device data.
- Play multimedia contents of your PC from your device.
- Backup and create and edit the memos in your device

NOTE: You can use the Help menu from the application to find out how to use your "LG PC Suite" PC software.

Installing "LG PC Suite" PC Software

"LG PC Suite" PC software can be downloaded from the webpage of LG.

- 1 Go to www.lg.com and select a country of your choice.
- 2 Go to **Support > MOBILE SUPPORT > LG Mobile Phones > Select the Model**
or
Go to **Support > Mobile > Select the Model**.
- 3 Click **PC SYNC** from **MANUALS & DOWNLOAD** and click **DOWNLOAD** to download "LG PC Suite" PC software.

PC software (LG PC Suite)

System Requirements for "LG PC Suite" PC software

- OS: Windows XP (Service pack 3) 32bit, Windows Vista, Windows 7, Windows 8
- CPU: 1 GHz or higher processors
- Memory: 512 MB or higher RAMs
- Graphic card: 1024 x 768 resolution, 32 bit color or higher
- HDD: 500 MB or more free hard disk space (More free hard disk space may be needed depending on the volume of data stored.)
- Required software: LG integrated drivers, Windows Media Player 10 or later

NOTE: LG Integrated USB Driver

LG integrated USB driver is required to connect an LG device and PC and installed automatically when you install "LG PC Suite" PC software application.

Synchronizing your Device to a PC

Data from your device and PC can be synchronized easily with "LG PC Suite" PC software for your convenience. Contacts, schedules and bookmarks can be synchronized.

The procedure is as follows:

- 1 Connect your device to PC. (Use a USB cable or Wi-Fi connection.)
- 2 The **Select USB connection method** will appear, then select **LG software**.
- 3 After connection, run the program and select the device section from the category on the left side of the screen.
- 4 Click **Personal information** to select.
- 5 Select the checkbox of contents to synchronize and click the **Sync** button.

NOTE: To synchronize your phone with your PC, you need to install LG PC Suite onto your PC. Please refer to previous pages to install LG PC Suite.

Moving contacts from your Old Device to your New Device

- 1 Export your contacts as a CSV file from your old device to your PC using a PC sync program.
- 2 Install "LG PC Suite" on the PC first. Run the program and connect your Android mobile phone to the PC using a USB cable.
- 3 On the top menu, select **Device > Import to device > Import contacts**.
- 4 A popup window to select the file type and a file to import will appear.
- 5 On the popup, click the **Select a file** and Windows Explorer will appear.
- 6 Select the contacts file to import in Windows Explorer and click the **Open**.
- 7 Click **OK**.
- 8 A **Field mapping** popup to link the contacts in your device and new contacts data will appear.
- 9 If there is a conflict between the data in your PC contacts and device contacts, make the necessary selections or modifications in LG PC Suite.
- 10 Click **OK**.

Phone software update

Phone software update

LG Mobile phone software update from the Internet

For more information about using this function, please visit <http://www.lg.com/common/index.jsp> → select your country and language.

This feature allows you to conveniently update the firmware on your phone to a newer version from the Internet without needing to visit a service center. This feature will only be available if and when LG makes a newer firmware version available for your device. Because the mobile phone firmware update requires the user's full attention for the duration of the update process, please make sure you check all instructions and notes that appear at each step before proceeding. Please note that removing the USB data cable during the upgrade may seriously damage your mobile phone.

NOTE: LG reserves the right to make firmware updates available only for selected models at its own discretion and does not guarantee the availability of the newer version of the firmware for all handset models.

LG Mobile Phone software update via Over-the-Air (OTA)

This feature allows you to conveniently update your phone's software to a newer version via OTA, without connecting using a USB data cable. This feature will only be available if and when LG makes a newer firmware version available for your device.

You should first check the software version on your mobile phone: **Settings > General tab > About phone > Update Center > Software Update > Check now for update.**

NOTE: Your personal data from internal phone storage—including information about your Google account and any other accounts, your system/application data and settings, any downloaded applications and your DRM licence—might be lost in the process of updating your phone's software. Therefore, LG recommends that you backup your personal data before updating your phone's software. LG does not take responsibility for any loss of personal data.

NOTE: This feature depends on your network service provider, region and country.

About this user guide

About this user guide

- Before using your device, please carefully read this manual. This will ensure that you use your phone safely and correctly.
- Some of the images and screenshots provided in this guide may appear differently on your phone.
- Your content may differ from the final product, or from software supplied by service providers or carriers. This content may be subject to change without prior notice. For the latest version of this manual, please visit the LG website at www.lg.com.
- Your phone's applications and their functions may vary by country, region, or hardware specifications. LG cannot be held liable for any performance issues resulting from the use of applications developed by providers other than LG.
- LG cannot be held liable for performance or incompatibility issues resulting from edited registry settings being edited or operating system software being modified. Any attempt to customize your operating system may cause the device or its applications to not work as they should.
- Software, audio, wallpaper, images, and other media supplied with your device are licensed for limited use. If you extract and use these materials for commercial or other purposes is, you may be infringing copyright laws. As a user, you are fully and entirely responsible for the illegal use of media.
- Additional charges may be applied for data services, such as messaging, uploading and downloading, auto-syncing, or using location services. To avoid additional charges, select a data plan that is suitable for your needs. Contact your service provider to obtain additional details.

Trademarks

- LG and the LG logo are registered trademarks of LG Electronics.
- All other trademarks and copyrights are the property of their respective owners.



ABOUT DIVX VIDEO: DivX[®] is a digital video format created by DivX, LLC, a subsidiary of Rovi Corporation. This is an official DivX Certified[®] device that has passed rigorous testing to verify that it plays DivX video. Visit divx.com for more information and software tools to convert your files into DivX videos.

ABOUT DIVX VIDEO-ON-DEMAND: This DivX Certified[®] device must be registered in order to play purchased DivX Video-on-Demand (VOD) movies. To obtain your registration code, locate the DivX VOD section in your device setup menu. Go to vod.divx.com for more information on how to complete your registration.

DivX Certified[®] to play DivX[®] video up to HD 720p, including premium content. DivX[®], DivX Certified[®] and associated logos are trademarks of Rovi Corporation or its subsidiaries and are used under license.



Manufactured under license from Dolby Laboratories. Dolby, Dolby Digital Plus, and the double-D symbol are trademarks of Dolby Laboratories.

Notice: Open Source Software

To obtain the corresponding source code under GPL, LGPL, MPL and other open source licences, please visit <http://opensource.lge.com/>

All referred licence terms, disclaimers and notices are available for download with the source code.

Accessories

These accessories are available for use with the your phone. **(Items described below may be optional.)**

Travel adaptor

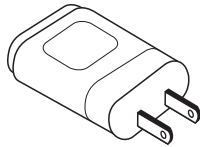

Stereo headset

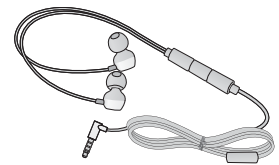

Quick Start Guide



Data cable

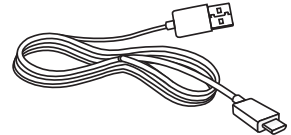

NOTE:

- Always use genuine LG accessories.
- Failure to do this may void your warranty.
- Accessories may vary in different regions.

Troubleshooting

This chapter lists some problems you might encounter when using your phone. Some problems require you to call your service provider, but most are easy to fix yourself.

Message	Possible causes	Possible corrective measures
Micro-USIM card error	There is no Micro-USIM card in the phone or it is inserted incorrectly.	Make sure that the Micro-USIM card is correctly inserted.
No network connection/ Dropped network	Signal is weak or you are outside the carrier network.	Move toward a window or into an open area. Check the network operator coverage map.
	Operator applied new services.	Check whether the Micro-USIM card is more than 6~12 months old. If so, change your Micro-USIM card at your network provider's nearest branch. Contact your service provider.
Codes do not match	To change a security code, you will need to confirm the new code by re-entering it.	If you forget the code, contact your service provider.
	The two codes you have entered do not match.	

Troubleshooting

Message	Possible causes	Possible corrective measures
No applications can be set	Not supported by service provider or registration required.	Contact your service provider.
Calls not available	Dialling error	New network not authorized.
	New Micro-USIM card inserted.	Check for new restrictions.
	Pre-paid charge limit reached.	Contact service provider or reset limit with PIN2.
Phone cannot be switched on	On/Off key pressed too briefly.	Press the On/Off key for at least two seconds.
	Battery is not charged.	Charge battery. Check the charging indicator on the display.

Message	Possible causes	Possible corrective measures
Charging error	Battery is not charged.	Charge battery.
	Outside temperature is too hot or cold.	Make sure phone is charging at a normal temperature.
	Contact problem	Check the charger and its connection to the phone.
	No voltage	Plug the charger into a different socket.
	Charger defective	Replace the charger.
	Wrong charger	Use only original LG accessories.
Number not allowed	The Fixed dialling number function is on.	Check the Settings menu and turn the function off.
Impossible to receive / send SMS & photos	Memory full	Delete some messages from your phone.
Files do not open	Unsupported file format	Check the supported file formats.

Troubleshooting



Message	Possible causes	Possible corrective measures
The screen does not turn on when I receive a call.	Proximity sensor problem	If you use a protection tape or case, make sure it has not covered the area around the proximity sensor. Make sure that the area around the proximity sensor is clean.
No sound	Vibration mode	Check the settings status in the sound menu to make sure you are not in vibration or silent mode.
Hangs up or freezes	Intermittent software problem	Try to perform a software update via the website.

FAQ

Category Sub- Category	Question	Answer
BT Bluetooth Devices	What are the functions available via Bluetooth	You can connect a Bluetooth audio device such as a Stereo/Mono headset or Car Kit. Also, when the FTP server is connected to a compatible device, you can share content stored on the storage media.
BT Bluetooth Headset	If my Bluetooth headset is connected, can I listen to my music through my 3.5 mm wired headphones?	When a Bluetooth headset is connected, all system sounds are played over the headset. As a result, you will not be able to listen to music through your wired headphones.
Data Contacts Backup	How can I backup Contacts?	The Contacts data can be synchronized between your phone and Gmail™.
Data Synchronization	Is it possible to set up one-way sync with Gmail?	Only two-way synchronization is available.
Data Synchronization	Is it possible to synchronize all email folders?	The Inbox is automatically synchronized. You can view other folders by tapping the Menu Key  and select Folders to choose a folder.
Google™ Service Gmail Log-In	Do I have to log into Gmail whenever I want to access Gmail?	Once you have logged into Gmail, no need to log into Gmail again.

FAQ

Category Sub- Category	Question	Answer
Google™ Service Google Account	Is it possible to filter emails?	No, email filtering is not supported via the phone.
Phone Function Email	What happens when I execute another application while writing an email?	Your email will automatically be saved as a draft.
Phone Function Ringtone	Is there a file size limitation for when I want to use MP3 file as ring tone?	There is no file size limitation.
Phone Function Message Time	My phone does not display the time of receipt for messages older than 24 hrs. How can I change this?	You will only be able to see the times for messages received the same day.
Phone Function Navigation	Is it possible to install another navigation application on my phone?	Any application that is available at Play Store™ and is compatible with the hardware can be installed and used.
Phone Function Synchronisation	Is it possible to synchronize my contacts from all my email accounts?	Only Gmail and MS Exchange server (company email server) contacts can be synchronized.

Category Sub- Category	Question	Answer
Phone Function Wait and Pause	Is it possible to save a contact with Wait and Pause in the numbers?	<p>If you transferred a contact with the W & P functions saved into the number, you will not be able to use those features. You will need to re-save each number.</p> <p>How to save with Wait and Pause:</p> <ol style="list-style-type: none"> 1. From the Home screen, tap the Phone icon . 2. Dial the number, then tap the Menu Key . 3. Tap Add 2-sec pause or Add wait.
Phone Function Security	What are the phone's security functions?	<p>You are able to set the phone to require that an Unlock Pattern be entered before the phone can be accessed or used.</p>

FAQ

Category Sub- Category	Question	Answer
Phone Function Unlock Pattern	How do I create the Unlock Pattern?	<ol style="list-style-type: none">1. From the Home screen, tap the Menu Key .2. Tap System settings > Display tab > Lock screen.3. Tap Select screen lock > Pattern. The first time you do this, a short tutorial about creating an Unlock Pattern will appear.4. Set up by drawing your pattern once, and once again for confirmation. <p>Precautions to take when using the pattern lock.</p> <p>It is very important to remember the unlock pattern you set. You will not be able to access your phone if you use an incorrect pattern five times. You have five chances to enter your unlock pattern, PIN or password. If you have used all 5 opportunities, you can try again after 30 seconds. (Or, if you preset the backup PIN, you can use the backup PIN code to unlock the pattern.)</p>

Category Sub- Category	Question	Answer
Phone Function Unlock Pattern	<p>What should I do if I forget the unlock pattern and I didn't create my Google account on the phone?</p>	<p>If you have forgotten your pattern: If you logged into your Google account on the phone but failed to enter the correct pattern 5 times, tap the forgot pattern button. You are then required to log in with your Google account to unlock your phone. If you have not created a Google account on the phone or you have forgotten it, you will have to perform a hard reset. Caution: If you perform a factory reset, all user applications and user data will be deleted. Please remember to backup any important data before performing a factory reset.</p>
Phone Function Memory	<p>Will I know when my memory is full?</p>	<p>Yes, you will receive a notification.</p>
Phone Function Language Support	<p>Is it possible to change my phone's language?</p>	<p>The phone has multilingual capabilities. To change the language:</p> <ol style="list-style-type: none"> 1. From the Home screen, tap the Menu Key  and tap System settings. 2. Tap General tab > Language & input > Language. 3. Tap the desired language.

FAQ

Category Sub- Category	Question	Answer
Phone Function VPN	How do I set up a VPN?	VPN access configuration is different for each company. To configure VPN access from your phone, you must obtain the details from your company's network administrator.
Phone Function Screen time out	My screen turns off after only 15 seconds. How can I change the amount of time for the backlight to turn off?	<ol style="list-style-type: none">1. From the Home screen, tap the Menu Key .2. Tap System settings > Display tab.3. Tap Screen timeout.4. Tap the preferred screen backlight timeout time.
Phone Function Wi-Fi & mobile network	When Wi-Fi and mobile network are both available, which service will my phone use?	<p>When using data, your phone may default to the Wi-Fi connection (if Wi-Fi connectivity on your phone is set to On). However, there will be no notification when your phone switches from one to the other.</p> <p>To know which data connection is being used, view the mobile network or Wi-Fi icon at the top of your screen.</p>
Phone Function Home screen	Is it possible to remove an application from the Home screen?	Yes. Just touch and hold the icon until the dustbin icon appears at the top and center of the screen. Then, without lifting your finger, drag the icon to the trash can.

Category Sub- Category	Question	Answer
Phone Function Application	I downloaded an application and it causes a lot of errors. How do I remove it?	<ol style="list-style-type: none"> 1. From the Home screen, tap the Menu Key . 2. Tap System settings > General tab > Apps > DOWNLOADED. 3. Tap the application, then tap Uninstall.
Phone Function Charger	Is it possible to charge my phone using a USB data cable without installing the necessary USB driver?	Yes, the phone will be charged by the USB cable regardless of whether the necessary drivers are installed or not.
Phone Function Alarm	Can I use music files for my alarm?	<p>Yes. After saving a music file as a ringtone, you can use it as your alarm.</p> <ol style="list-style-type: none"> 1. Touch and hold a song in a library list. In the menu that opens, tap Set as ringtone > Phone ringtone or Contact ringtone. 2. In the alarm clock setting screen, select the song as a ringtone.
Phone Function Alarm	Will my alarm be audible or will it go off if the phone is turned off?	No, this is not supported.
Phone Function Alarm	If my ringer volume is set to Off or Vibrate, will I hear my alarm?	Your alarm is programmed to be audible even in these scenarios.

FAQ

Category Sub- Category	Question	Answer
Recovery Solution Hard Reset (Factory Reset)	How can I perform a factory reset if I can't access the phone's setting menu?	If your phone does not restore to its original condition, use a hard reset (factory reset) to initialize it.



