



APPENDIX G
: USER'S MANUAL



LG

Life's Good

ENGLISH

OWNER'S MANUAL

LED LCD TV/ CINEMA 3D TV

Please read this manual carefully before operating the your set and retain it for future reference.

LED LCD TV MODEL 

M1950D
M2450D

CINEMA 3D TV MODEL 

DM2350D

CONTENTS

4 ASSEMBLING AND PREPARING

- 4 Unpacking
- 6 Parts and buttons
- 7 Lifting and moving the TV
- 7 Setting up the TV
 - Attaching the Stand Base
- 8 - Detaching the Stand Base and Body
- 8 - Mounting on a table
- 10 - Tidying cables
- 10 - Mounting on a wall

12 REMOTE CONTROL

15 WATCHING TV

- 15 Connecting an antenna or cable
 - Connecting an antenna or basic cable
 - Connecting with a cable box
- 16 Accessing the TV for the first time
- 17 Watching TV
- 17 Managing channels
 - Setting up channels
 - Using favorite channels
 - Checking current program info
- 20 Using additional options
 - Adjusting aspect ratio
 - Using the input list
 - Locking the buttons on the TV (Child Lock)
- 22 Using the Quick menu

23 CONNECTING TO A PC

- 23 HDMI connection
- 24 DVI to HDMI connection
- 24 DVI connection
- 25 RGB connection
- 25 Adjusting the screen
 - Selecting an image mode

- 26 - Customizing image options
- 26 - Customizing PC display options
- 27 Adjusting the sound
 - Selecting an sound mode
 - Customizing sound options

28 ENTERTAINMENT

- 28 Using integrated media features
 - Connecting USB storage devices
- 30 - Browsing files
- 31 - Viewing Photos
- 32 - Listening to Music
- 33 - Viewing Movies
- 36 - DivX registration code
- 36 - Deactivating the DivX feature

37 3D IMAGING(ONLY 3D MODEL)

- 37 3D Technology
- 37 Precautions to take when viewing 3D images
- 38 When using 3D Glasses
- 38 3D Imaging Viewing Range
- 39 Viewing 3D Imaging
- 40 3D Mode Setting Option

41 CUSTOMIZING SETTINGS

- 41 Accessing main menus
- 42 Customizing settings
 - CHANNEL settings
 - PICTURE settings
 - AUDIO settings
 - TIME settings
 - OPTION settings
 - LOCK settings
 - INPUT settings
 - USB settings

53 MAKING CONNECTIONS

- 53 Connection overview
- 55 Connecting to a Camcorder, Camera, HD receiver, DVD, VCR player or Gaming device
 - 55 - HDMI connection
 - 55 - DVI to HDMI connection
 - 56 - DVI connection
 - 56 - Component connection
- 56 Connecting to an audio system
 - 56 - Digital optical audio connection
 - 57 - Headphone connection
- 57 Connecting to a USB

58 MAINTENANCE

- 58 Screen and frame
- 58 Cabinet and stand
- 58 Power cord

59 TROUBLESHOOTING

- 59 General
- 60 PC mode

62 TROUBLESHOOTING WHEN USING 3D MODE

63 SPECIFICATIONS

69 IR CODES

70 EXTERNAL CONTROL DEVICE SETUP

- 70 RS-232C Setup
 - 70 Type of connector; D-Sub 9-Pin Male
 - 70 Communication Parameters
 - 71 RS-232C configurations
 - 72 Command reference list
 - 73 Transmission / Receiving protocol

79 LICENSES

80 CHILD SAFETY

ASSEMBLING AND PREPARING

Unpacking

Check your product box for the following items. If there are any missing accessories, contact the local dealer where you purchased your product. The illustrations in this manual may differ from the actual product and accessories.



NOTE

-  : LED LCD TV
-  : Cinema 3D TV

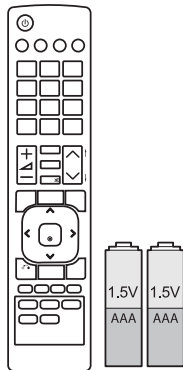

Remote control and Batteries

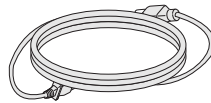

Power Cord

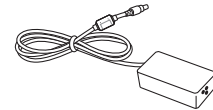

AC-DC Adapter



Audio Cable

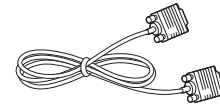

RGB Cable



Cable Tie

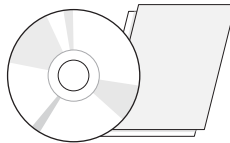

CD (Owner's Manual) /
Card

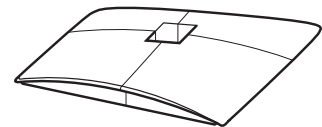

Stand Base

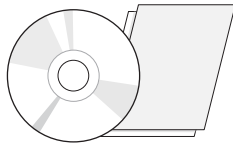

TriDef 3D Game Software CD /
Quick Installation Guide



3D Glasses
(Normal type)



3D Glasses
(Clip type)



CAUTION

- Do not use any pirated items to ensure the safety and product life span.
- Any damages or injuries by using pirated items are not covered by the warranty.



NOTE

- The accessories supplied with your product may vary depending on the model.
- Product specifications or contents in this manual may be changed without prior notice due to upgrade of product functions.

Parts and buttons

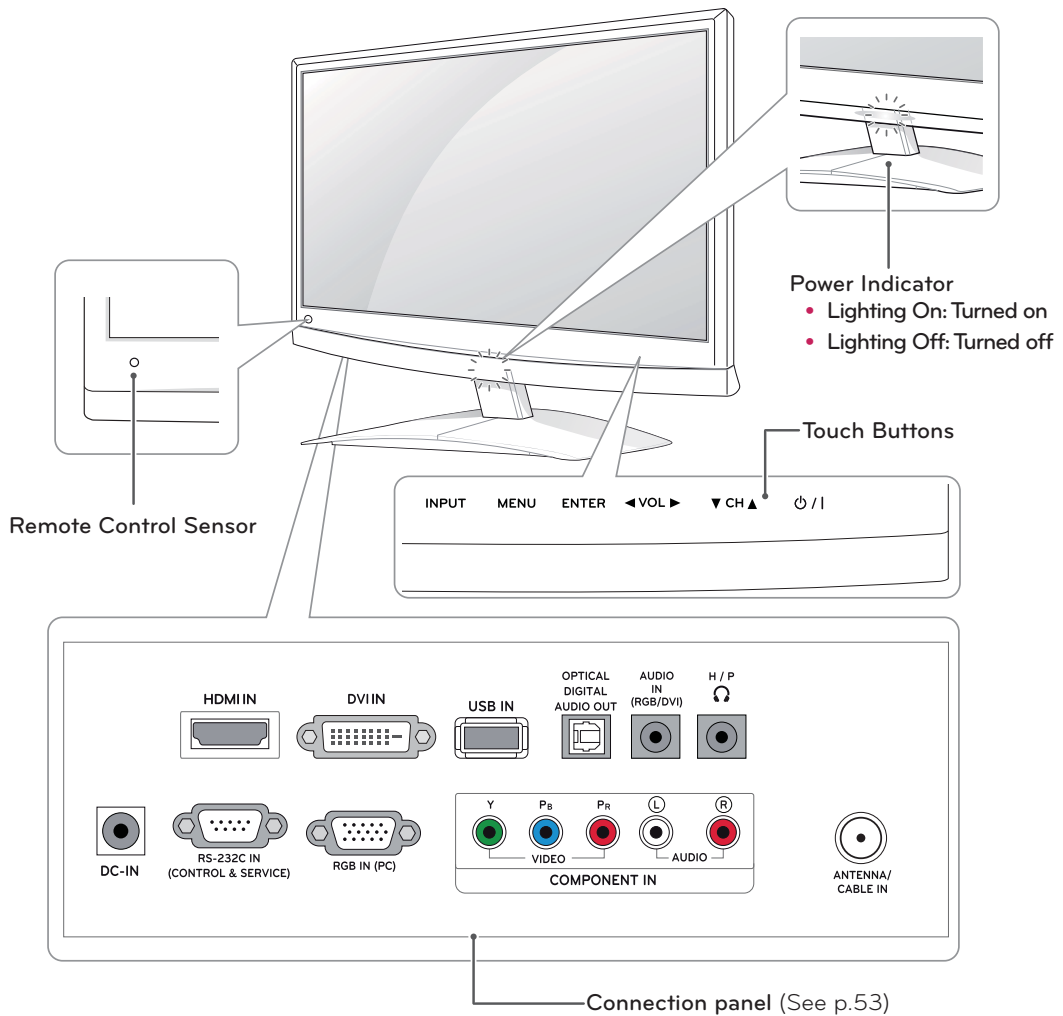

Touch button	Description
INPUT	Changes the input source.
MENU	Accesses the main menus, or saves your input and exits the menus.
ENTER	Selects the highlighted menu option or confirms an input.
<VOL>	Adjusts the volume level.
<CH>	Scrolls through the saved channels
<P>/I	Turns the power on or off.

All of the buttons are touch sensitive and can be operated through simple touch with your finger.

**NOTE**

- You can set the Power indicator to on or off by selecting **OPTION** in the main menus.

Lifting and moving the TV

When moving or lifting the TV, read the following to prevent the TV from being scratched or damaged and for safe transportation regardless of its type and size.



CAUTION

Avoid touching the screen at all times, as this may result in damage to the screen or some of the pixels used to create images.

- It is recommended to move the TV in the box or packing material that the TV originally came in.
- Before moving or lifting the TV, disconnect the power cord and all cables.
- Hold the top and bottom of the TV frame firmly. Make sure not to hold the transparent part, speaker, or speaker grill area.

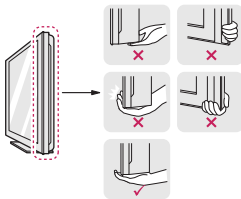

- When holding the TV, the screen should face away from you to prevent the screen from scratches.



- When transporting the TV, do not expose the TV to jolts or excessive vibration.
- When transporting the TV, keep the TV upright, never turn the TV on its side, or tilt towards the left or right.

Setting up the TV

Attaching the Stand Base

- 1 Place the TV with the screen side down on a flat and cushioned surface.



CAUTION

Lay a foam mat or soft protective cloth on the surface to protect the screen from damage.

- 2 Attach the **Stand Base** from the set by turning the screw to the right with a **Coin**.

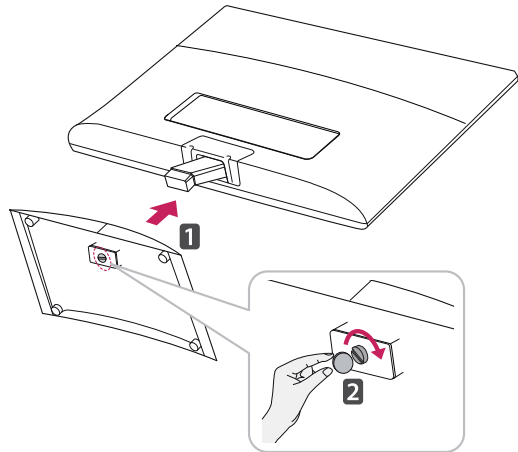

Detaching the Stand Base and Body

- 1 Place the TV with the screen side down on a flat and cushioned surface.
- 2 Turn the screw to the left, and then pull out the **Stand Base** from the **Stand Body**.

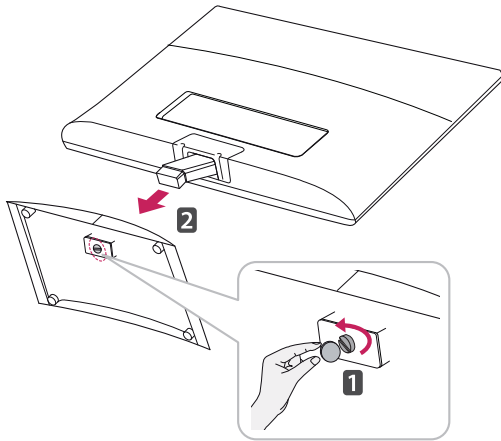

- 3 Remove 2 screws and pull out the **Stand Body** from the TV.

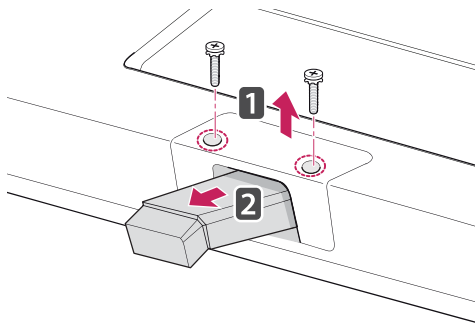

Mounting on a table

- 1 Lift and tilt the TV into its upright position on a table.

Leave a 10 cm (minimum) space from the wall for proper ventilation.

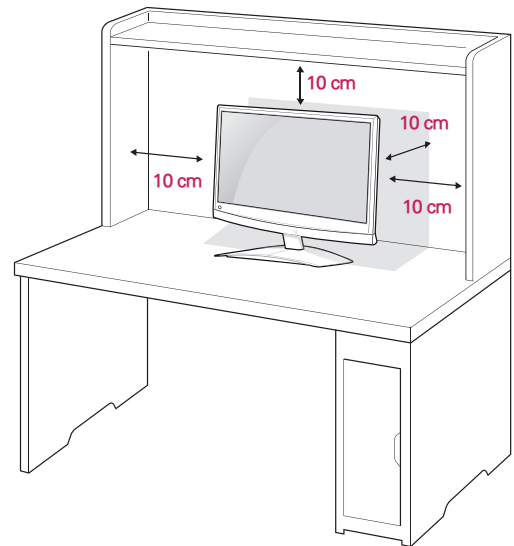

- 2 Connect the **AC-DC Adapter** and **Power Cord** to a wall outlet.

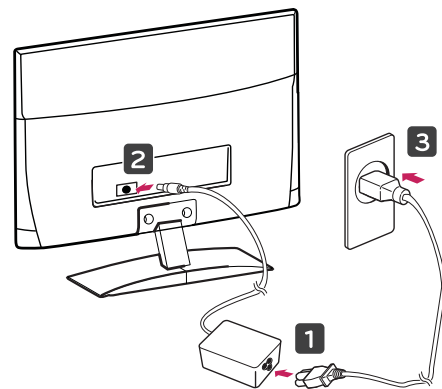

! WARNING

When you adjust the angle, do not hold the bottom of the TV frame as shown on the following illustration, as may injure your fingers.

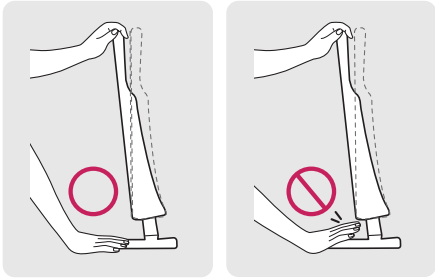

! CAUTION

Disconnect the power cord first, and then move or install the TV. Otherwise electric shock may occur.

! NOTE

Tilt from +10 or +18 to -5 degrees up or down to adjust the angle of the TV to suit your view

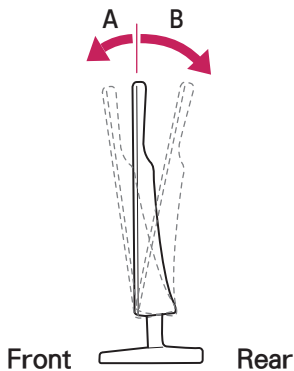

Model		M1950D	DM2350D
		M2450D	
Tilt Range	Front (A)	- 5 °	
	Rear (B)	10°	18°

Using the Kensington security system

The Kensington security system connector is located at the back of the TV. For more information of installation and using, refer to the manual supplied with the Kensington security system or visit <http://www.kensington.com>.

Connect the Kensington security system cable between the TV and a table.

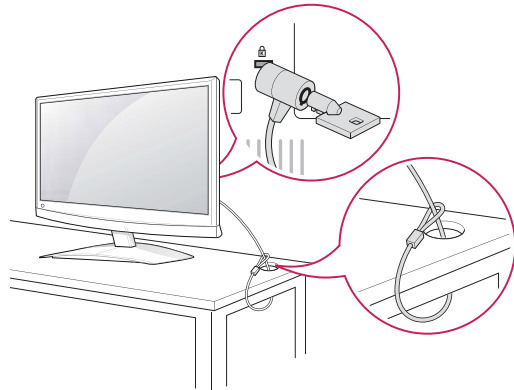

! NOTE

The Kensington security system is optional. You can obtain additional accessories from most electronics stores.

Tidying cables

Gather and bind the cables with the supplied cable tie.

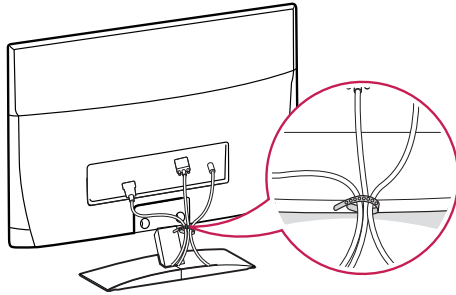

Mounting on a wall

For proper ventilation, allow a clearance of 10 cm on each side and from the wall. Detailed installation instructions are available from your dealer, see the optional Tilt Wall Mounting Bracket Installation and Setup Guide.

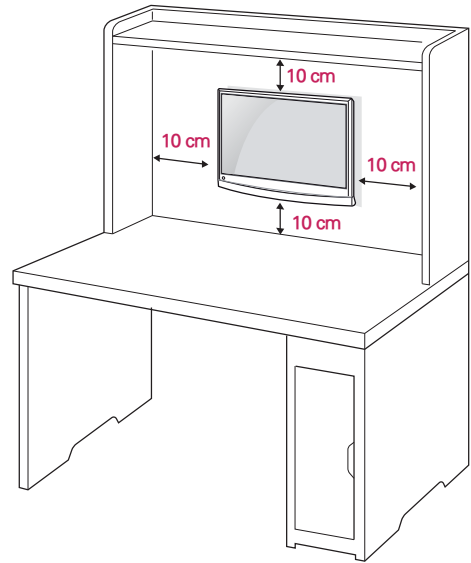

If you intend to mount the TV to a wall, attach Wall mounting interface (optional parts) to the back of the set.

When you install the TV using the wall mounting interface (optional parts), attach it carefully so it will not drop.

- 1 Please, Use the screw and wall mount interface in accordance with VESA Standards.
- 2 If you use screw longer than standard, the TV might be damaged internally.
- 3 If you use improper screw, the product might be damaged and drop from mounted position. In this case, LG Electronics is not responsible for it.
- 4 VESA compatible only with respect to screw mounting interface dimensions and mounting screw specifications.

- 5 Please use VESA standard as below.
- 784.8 mm (30.9 inch) and under
 - * Wall Mount Pad Thickness : 2.6 mm
 - * Screw : Φ 4.0 mm x Pitch 0.7 mm x Length 10 mm
 - 787.4 mm (31.0 inch) and above
 - * Please use VESA standard wall mount pad and screws.

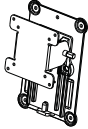
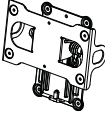
Model	M1950D DM2350D	M2450D
VESA (A x B)	75 x 75	200 x 100
Standard screw	M4	M4
Number of screws	4	4
Wall mount bracket (optional)	RW120 	RW240 

- VESA (A x B)

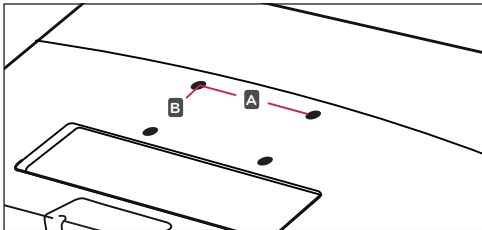

CAUTION

- Disconnect the power cord first, and then move or install the TV. Otherwise electric shock may occur.
- If you install the TV on a ceiling or slanted wall, it may fall and result in severe injury.
- Use an authorized LG wall mount and contact the local dealer or qualified personnel.
- Do not over tighten the screws as this may cause damage to the TV and void your warranty.
- Use the screws and wall mounts that meet the VESA standard. Any damages or injuries by misuse or using an improper accessory are not covered by the warranty.

NOTE

- Use the screws that are listed on the VESA standard screw specifications.
- The wall mount kit includes an installation manual and necessary parts.
- The wall mount bracket is optional. You can obtain additional accessories from your local dealer.
- The length of screws may differ depending on the wall mount. Be sure to use the proper length.
- For more information, refer to the instructions supplied with the wall mount.

WATCHING TV

Connecting an antenna or cable

Connect an antenna, cable, or cable box to watch TV referring to the following. The illustrations may differ from the actual accessories and an RF cable is optional.

Connecting an antenna or basic cable

Connect the TV to a wall antenna socket with an RF cable (75 ohm).

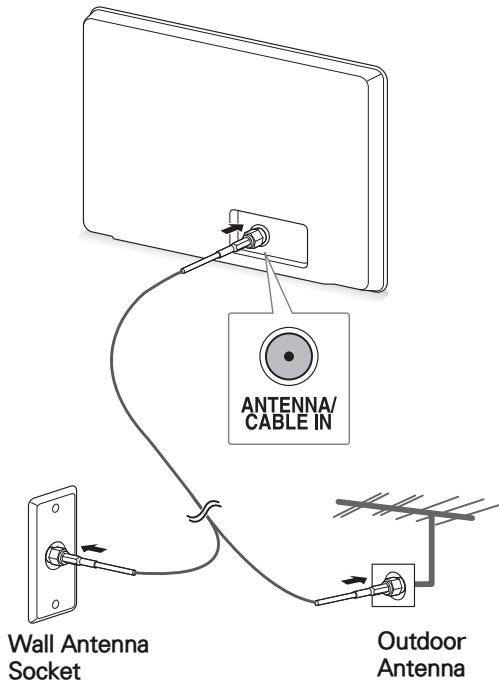

NOTE

- Use a signal splitter to use more than 2 TVs.
- If the image quality is poor, install a signal amplifier properly to improve the image quality.
- If the image quality is poor with an antenna connected, aim the antenna to the proper direction.
- Visit <http://AntennaWeb.org> for more information about the antenna and cable connection.

Connecting with a cable box

Connect the TV to a cable box and the cable box to a wall antenna socket with 2 RF cables (75 ohm).

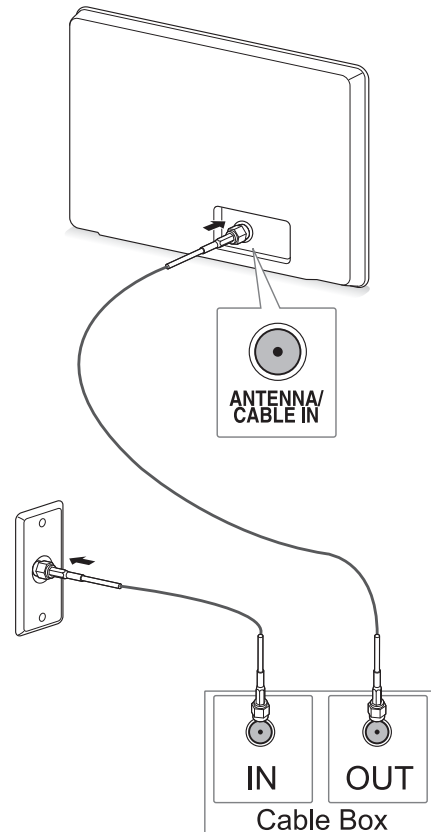

CAUTION

- Make sure not to bend the copper wire of the RF cable.

Copper wire

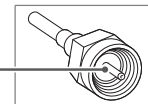

- Complete all connections instructions between devices, and then connect the power cord to the power outlet to prevent damages to your TV.

Accessing the TV for the first time

When you access the TV for the first time, the initial setting screen appears. Select a language and customize the basic settings.

- 1 Connect the power cord to a power outlet.
- 2 Press **⏻/I** on the TV to turn the TV on. The Power indicator lighting is turned on.

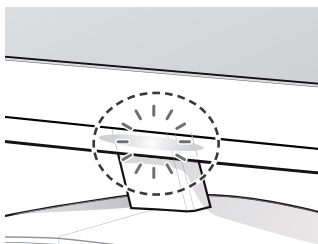

NOTE

When the TV is in Power saving mode, the Power indicator lighting blinks.

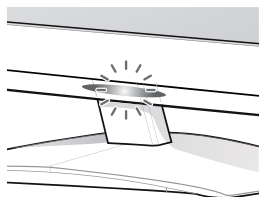

- 3 The initial setting screen appears if you access the TV for the first time.

NOTE

- You can also switch the TV from PC mode to TV mode, press **TV/PC**.
- You can also access **Initial Setting** by accessing **OPTION** in the main menus.
- If you do not operate the TV within 40 seconds when the setting menu screen appears, the setting menus will disappear.

- 4 Follow the on-screen instructions to customize your TV according to your preferences.

Language	Selects a language for the display.
↓	
Mode Setting	Selects Home Use for the home environment.
↓	
Time Setting	Selects the time zone and daylight saving.
↓	
Auto Tuning	Scans and saves available channels automatically.

NOTE

- To display images in the best quality for your home environment, select **Home Use** mode.
- **Store Demo** mode is suitable for the retail environment.
- If you select **Store Demo** mode, the previously customized settings will switch to the default settings of **Store Demo** mode in 2 minutes.

- 5 When the basic settings are complete, press **ENTER**.

NOTE

If you do not complete the initial setting, it will appear whenever you access the TV.

- 6 To turn the TV off, press **⏻/I** on the TV. The Power Indicator turns off.

CAUTION

Disconnect the power cord from the power outlet when you do not use the TV for a long period of time.

Watching TV

- 1 Press **⏻** on the Remote control or **⏻/I** on the TV to turn the TV on.
- 2 Press **INPUT** and select **TV**.
- 3 Control the TV using the following buttons and menus while you are watching TV.

Button / Menu	Description
CH (^ , v) or CH (▲ , ▼)	Scrolls through the saved channels
Numbers	Selects a channel by entering numbers
VOL (+ , -) or VOL (◀ , ▶)	Adjusts the volume level
MUTE	Mutes all sounds
PICTURE	Selects one of the preset image modes (See p.43)
AUDIO	Selects one of the preset audio modes. (See p.46)
RATIO (Except 3D Model)	Resizes an image (See p.20)

- 4 To turn the TV off, Press **⏻** on the Remote control or **⏻/I** on the TV.

Managing channels

Setting up channels

Storing channels

To store channels Automatically,

- 1 Press **MENU** to access the main menus.
- 2 Press the Navigation buttons to scroll to **CHANNEL** and press **ENTER**.
- 3 Press the Navigation buttons to scroll to **Auto Tuning** and press **ENTER**.
- 4 Select **Yes** to start automatic tuning.
The TV scans and saves available channels automatically.
- 5 When you are finished, press **EXIT**.
When you return to the previous menu, press **BACK**.

To store channels Manually,

- 1 Press **MENU** to access the main menus.
- 2 Press the Navigation buttons to scroll to **CHANNEL** and press **ENTER**.
- 3 Press the Navigation buttons to scroll to **Manual Tuning** and press **ENTER**.
- 4 Scroll through the channel types, and then add or delete channels.
- 5 When you are finished, press **EXIT**.
When you return to the previous menu, press **BACK**.

! NOTE

- The TV will ask for a password if parental control has been activated (LOCK Menu). Use the password you set up in the LOCK Menu to allow a channel search.
- When setting the Auto tuning or Manual tuning, the number of maximum channel you can store is 1,000. This number is subject to change depending on the broadcasting signal environment.

Editing your channel list

- 1 Press **MENU** to access the main menus.
- 2 Press the Navigation buttons to scroll to **CHANNEL** and press **ENTER**.
- 3 Press the Navigation buttons to scroll to **Channel Edit** and press **ENTER**.
- 4 Edit programs using the following buttons.

Button	Description
^	Highlights the program type
Navigation	Scrolls through program types or programs
ENTER	Selects a program to view
CH (∧, ∨)	Moves to the previous or next page
●.MENU	Adds or deletes a channel. The deleted channel displays in gray.

- 5 When you are finished, press **EXIT**.
When you return to the previous menu, press **BACK**.

Selecting a channel on the channel list

- 1 Press **LIST** to access the channel list.

Button	Description
Navigation	Scrolls through channel.
ENTER	Selects a program to view
CH (∧, ∨)	Moves to the previous or next page

Using favorite channels

Add the channels that you watch frequently to the favorite list.

To set up your favorite list,

- 1 Select a channel to add to the favorite list.
- 2 Press **●.MENU**.
- 3 Press Navigation buttons to scroll to **Del/Add/Fav**.
- 4 Press Navigation buttons to scroll to **Favorite**.
- 5 Press **ENTER** to add the selected channel to the favorite list.

To select a favorite channel, press **FAV** repeatedly until the channel you want displays.

Checking current program info

Press **INFO** ⓘ to view the information of the currently program while you are watching. The following information appears at the bottom of the screen.

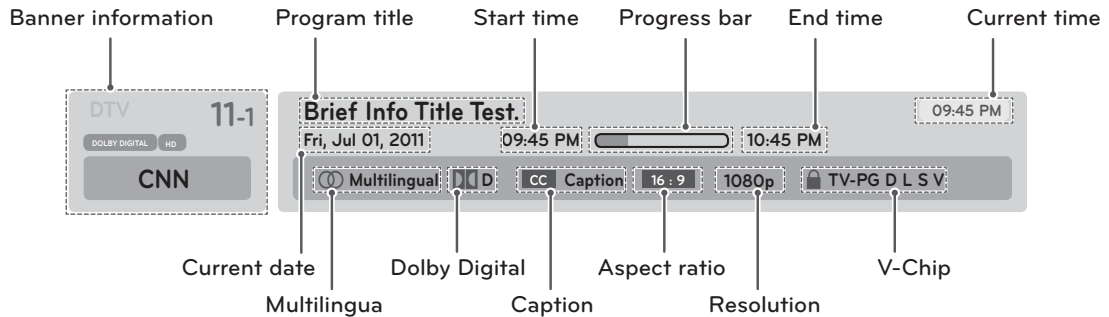

Menu	Description
Multilingual	The program contains two or more audio language services. You can select an audio language you want by using the quick menu.
Dolby Digital	The program contains a Dolby Digital audio signal in TV and HDMI input sources.
Caption	The program contains one or more language caption services. You can select a closed caption you want by using the quick menu.
Aspect ratio	<ul style="list-style-type: none"> The original aspect ratio of the video is 4:3. The original aspect ratio of the video is 16:9 (wide).
Resolution	<ul style="list-style-type: none"> 480 i : The video resolution is 720 x 480i. 480 p : The video resolution is 720 x 480p. 720 p : The video resolution is 1280 x 720p. 1080 i : The video resolution is 1920 x 1080i. 1080 p : The video resolution is 1920 x 1080p.
V-Chip	The program contains V-Chip information. "TV Rating" See p.50

Using additional options

Adjusting aspect ratio

Resize the image to view the image at its optimal size by pressing **RATIO(Except 3D Model)** or **.MENU** while you are watching TV.



CAUTION

- If a fixed image displays on the screen for a long period of time, it will be imprinted and become a permanent disfigurement on the screen. This is "image burn" or "burn-in" and not covered by the warranty.
- If the aspect ratio is set to 4:3 for a long period of time, image burn may occur on the letterboxed area of the screen.



NOTE

You can also change the image size by pressing **. MENU** or accessing **Aspect Ratio** in the **PICTURE** menu.

- **16:9**: Resizes images to fit the screen width.

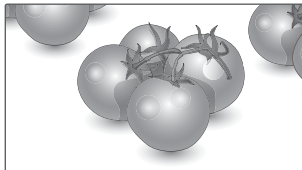

- **Just Scan**: Displays the most accurately reproduced images in high resolution without image distortion.



- **Set By Program**: Displays images in the same aspect ratio with the original image.

- **4:3**: Resizes images at the standard 4:3 without distortion.

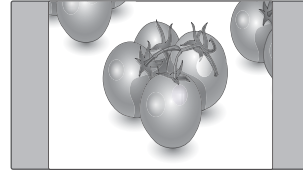

- **Zoom**: Enlarges an image to fit the screen width. The top and bottom of the image may not appear.

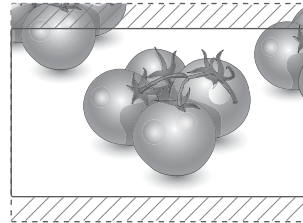

- **< or >** button: Adjust enlarge proportion of Zoom.
- **^ or v** button: Move the screen.

- **Cinema Zoom**: Choose Cinema Zoom when you want to enlarge the picture in correct proportion. Note: When enlarging or reducing the picture, the image may become distorted.

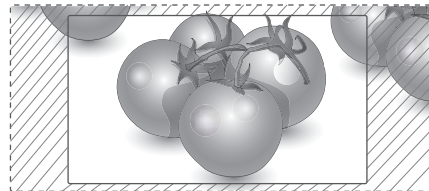

- **< or >** button: Adjust enlarge proportion of Cinema Zoom. The adjustment range is 1 to 16.
- **^ or v** button: Move the screen.



NOTE

- If an original image has noise, you may find the noise at the edge of the image.
- The input sources: **DTV, CADTV, Component, HDMI-DTV, and DVI-DTV (720p/1080i/1080p)**, support **Just Scan**.

Using the input list

Selecting an input source

- 1 Press **INPUT** to access the input source list.
 - The connected device displays on each input source.
- 2 Press the Navigation buttons to scroll to one of the input sources and press **ENTER**.

Input source	Description
TV	Watch TV over the air, cable, and digital cable broadcast
RGB-PC	View a PC display on the screen
Component	Watch the contents in a DVD or other external devices, or through a digital set-top box
HDMI	Watch contents in a PC, DVD or Digital settop box other high definition devices
DVI	View a PC display on the screen

The connected input sources display in black and the disconnected input sources in grey.

- If you add an input label to each input sources, you can easily identify a device connected to each input source.

Adding an Input label

- 1 Press **MENU** to access the main menus.
- 2 Press the Navigation buttons to scroll to **OPTION** and press **ENTER**.
- 3 Press the Navigation buttons to scroll to **Input Label** and press **ENTER**.
- 4 Press the Navigation buttons to scroll to one of the input sources.
- 5 Press the Navigation buttons to scroll to one of the input label and press **ENTER**.
- 6 When you are finished, press **EXIT**.
When you return to the previous menu, press **BACK**.



NOTE

- If you want to use HDMI-PC mode, you must set the input label to PC mode.

Locking the buttons on the TV (Child Lock)

Lock the buttons on the TV to prevent any unwanted operations or accidents by children.

- 1 Press **MENU** to access the main menus.
- 2 Press the Navigation buttons to scroll to **OPTION** and press **ENTER**.
- 3 Press the Navigation buttons to scroll to **Key Lock** and press **ENTER**.
- 4 Press the Navigation buttons to scroll to **On** and press **ENTER** to activate the Key lock feature.
 - To deactivate the Key lock feature, select **Off**.
- 5 When you are finished, press **EXIT**. When you return to the previous menu, press **BACK**.

NOTE

- The TV is programmed to remember the last setting after you turn the TV off.
- If you turn the TV off with the Key lock feature activated, press **POWER**, **INPUT**, **CH** (**▲**, **▼**) on the TV or **POWER**, **INPUT**, **CH** (**+**, **-**) or Number buttons on the remote control.
- If you press any button on the TV with the Key lock feature activated, **Key Lock On** appears on the screen.

Using the Quick menu

Customize the frequently using menus.

- 1 Press **●.MENU** to access the quick menu.
- 2 Press the Navigation buttons to scroll through the following menus.

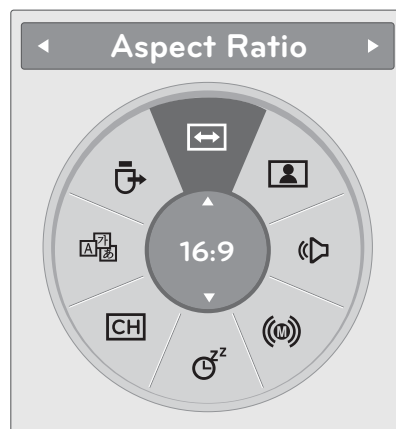

Menu	Description
Aspect Ratio	Resizes an image.
Picture Mode	Selects one of the preset image modes.
Sound Mode	Selects one of the sound modes
Audio	Selects the sound output.
Sleep Timer	Sets the length of time until the TV to turns off
Favourite	Selects the favourite channels.
Caption	Activates or deactivate the subtitles
USB Device	Selects "Eject" in order to eject USB device.

NOTE

The available menus and options may differ from the input source that you are using.

- 3 Press the Navigation buttons to scroll to an option you want and press **ENTER**.
- 4 When you are finished, press **●.MENU**.

CONNECTING TO A PC

Your TV supports the Plug & Play* feature and has the built-in speakers with Surround X that reproduces sound clearly with a rich bass.

* Plug & Play: The function when a PC recognizes a connected device that users connect to a PC and turn on, without device configuration or user intervention.

NOTE

- It is recommended to use the TV with the HDMI connection for the best image quality.
- If you want to use an optional external speaker instead of the built-in speaker, set the TV speaker feature to off (See p.46).

HDMI connection

Transmits the digital video and audio signals from your PC to the TV. Connect the PC and the TV with the HDMI cable as shown in the following illustrations. You should set PC as an input label to connect the PC to the TV with an HDMI connection. To add an input label, see Adding an Input label on See p.21.

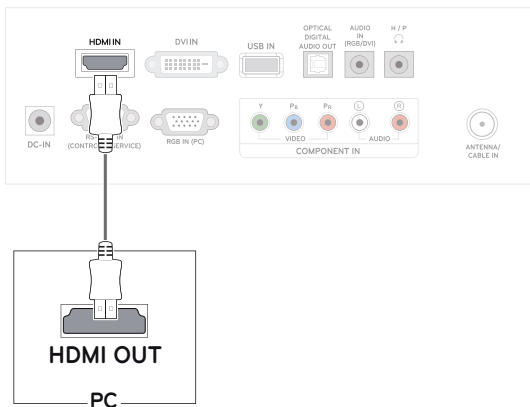

NOTE

- The **OSD (On Screen Display)** is displayed on the screen as shown below.
 - » When turning the product on in **HDMI** input.
 - » When switching to **HDMI** input.
 - » When connecting an **HDMI** cable with no signal.

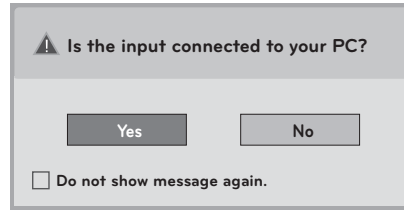

- If you select **"Yes"** the size and image quality are optimised for your PC.
- If you select **"No"** the size and image quality are optimised for the **AV device (DVD player, set-top box, gaming device)**.
- If you select **"Do not show message again"** this message does not appear until the Monitor SET is reset. You can change the set value in **Menu ► OPTION ► Input Label**.
- The values set for HDMI1/HDMI2 are saved independently.

NOTE

- Use a High Speed HDMI™ Cable.
- Please check the PC environment if you cannot hear the sound in HDMI mode.
- If you want to use HDMI-PC mode, you must set the input label to PC mode.

DVI to HDMI connection

Transmits the digital video signal from your PC to the TV. Connect the PC and the Monitor set with the DVI to HDMI cable as shown the following illustrations. To transmit an audio signal, connect an optional audio cable.

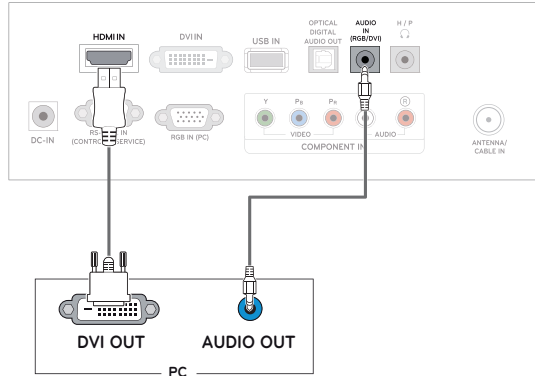

DVI connection

Transmits the digital video signal from your PC to the TV. Connect the PC and the TV with the DVI cable as shown the following illustrations. To transmit an audio signal, connect an optional audio cable in TV.

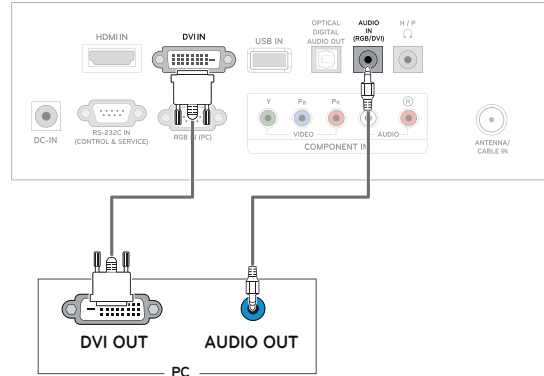

NOTE

- If you want to use HDMI-PC mode, you must set the input label to PC mode.
- If you do not use an optional external speaker, connect the PC to the TV with the optional audio cable.
- If you turn the TV on when the set becomes cold, the screen may flicker. This is normal.
- Use a shielded signal interface cable, such as D-sub 15 pin signal cable and DVI to HDMI cable, with a ferrite core to maintain standard compliance for the product.
- Some red, green, or blue spots may appear on the screen. This is normal.

RGB connection

Transmits the analog video signal from your PC to the TV. Connect the PC and the Monitor set with the D-sub 15 pin cable as shown the following illustrations. To transmit an audio signal, connect an optional audio cable.

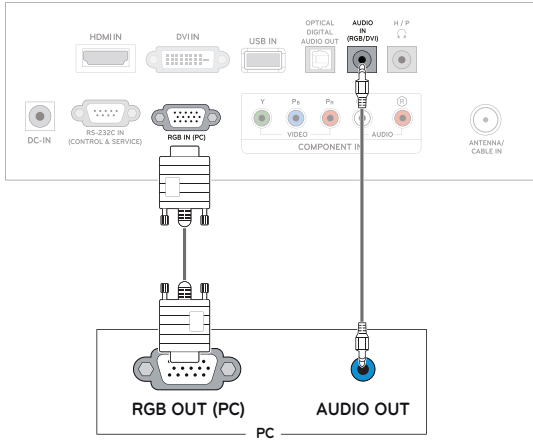

CAUTION

- Connect the signal input cable and tighten it by turning the screws clockwise.
- Do not press the screen with your finger for a long time as this may result in temporary distortion on the screen.
- Avoid displaying a fixed image on the screen for a long period of time to prevent image burn. Use a screensaver if possible.

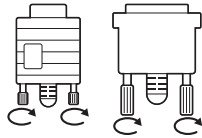

Adjusting the screen

Selecting an image mode

Display images in its optimized settings by selecting one of the preset image modes.

- 1 Press **MENU** to access the main menus.
- 2 Press the Navigation buttons to scroll to **PICTURE** and press **ENTER**.
- 3 Press the Navigation buttons to scroll to **Picture Mode** and press **ENTER**.
- 4 Press the Navigation buttons to scroll to an image mode you want and press **ENTER**.

Mode	Description
Vivid	Adjusts the video image for the retail environment by enhancing the Contrast, Brightness, Color, and Sharpness .
Standard	Adjusts the image for the normal environment.
Natural	Adjusts the image for the natural screen status.
Cinema	Optimizes the video image for the cinematic look and enjoy movies as if you are in a movie theater.
Sport	Optimizes the video image for high and dynamic actions by emphasizing primary Colors such as white, grass, or sky blue.
Game	Optimizes the video image for a fast gaming screen such as PCs or games.
Expert1/2	Adjusts the detailed video image settings for video experts as well as general viewers.

- 5 When you are finished, press **EXIT**.
When you return to the previous menu, press **BACK**.

Customizing image options

Customize basic and advanced options of each image mode for the best screen performance.

- 1 Press **MENU** to access the main menus.
- 2 Press the Navigation buttons to scroll to **PICTURE** and press **ENTER**.
- 3 Press the Navigation buttons to scroll to **Picture Mode** and press **ENTER**.
- 4 Press the Navigation buttons to scroll to an image mode you want and press **ENTER**.
- 5 Select and adjust following options, and then press **ENTER**.

Option	Description
Backlight	Adjusts the brightness of the screen by controlling the LCD backlight. If you decrease the brightness level, the screen becomes darker and the power consumption will be reduced without any video signal loss.
Contrast	Increases or decreases the gradient of the video signal. You may use Contrast when the bright part of the image is saturated.
Brightness	Adjusts the base level of the signal in the image. You may use Brightness when the dark part of the image is saturated.
Sharpness	Adjusts the level of crispness in the edges between the light and dark areas of the picture. The lower the level, the softer the image.
Color	Adjusts intensity of all Colors .
Tint	Adjusts the balance between Red and Green levels.
Advanced Control	Customizes the advanced options. See more information about advanced options See p.45.
Picture Reset	Restores the options to the default setting.

- 6 When you are finished, press **EXIT**.
When you return to the previous menu, press **BACK**.

Customizing PC display options

Customize options of each image mode for the best image quality.

- This function works in the following mode: RGB[PC] mode.

- 1 Press **MENU** to access the main menus.
- 2 Press the Navigation buttons to scroll to **PICTURE** and press **ENTER**.
- 3 Press the Navigation buttons to scroll to **Screen** and press **ENTER**.
- 4 Select and adjust following options, and then press **ENTER**.

Option	Description
Resolution	Match the resolution of RGB mode. (Resolution menu is Enabled only for the following resolution with 60Hz.)
	Vertical resolution : 768
	M1950D 1024 x 768 1280 x 768 1360 x 768(Default)
	DM2350D 1024 x 768(Default) M2450D 1280 x 768 1360 x 768
	Vertical resolution : 1050
	DM2350D 1400 x 1050 M2450D 1680 x 1050(Default)
Vertical resolution : 900	DM2350D 1280 x 960 M2450D 1440 x 900 1600 x 900(Default)
	Auto Configure
	Sets to adjust the screen Position , Size and Phase automatically. The displayed image may be unstable for a few seconds while the configuration is in progress.
Position/Size/Phase	Adjusts the options when the image is not clear, especially when characters are shaky, after the auto configuration.
Reset	Restores the options to the default setting.

- 5 When you are finished, press **EXIT**.
When you return to the previous menu, press **BACK**.

Adjusting the sound

Selecting an sound mode

Play the sound in its optimized settings by selecting one of the preset sound modes.

- 1 Press **MENU** to access the main menus.
- 2 Press the Navigation buttons to scroll to **AUDIO** and press **ENTER**.
- 3 Press the Navigation buttons to scroll to **Sound Mode** and press **ENTER**.
- 4 Press the Navigation buttons to scroll to a sound mode you want and press **ENTER**.

Mode	Description
Standard	Selects when you want standard-quality sound.
Music	Selects when you listen to music.
Cinema	Selects when you watch movies.
Sport	Selects when you watch sports events.
Game	Selects when you play games.

- 5 When you are finished, press **EXIT**.
When you return to the previous menu, press **BACK**.

Customizing sound options

Customize options of each sound mode for the best sound quality.

- 1 Press **MENU** to access the main menus.
- 2 Press the Navigation buttons to scroll to **AUDIO** and press **ENTER**.
- 3 Press the Navigation buttons to scroll to **Sound Mode** and press **ENTER**.
- 4 Press the Navigation buttons to scroll to a sound mode you want and press **ENTER**.
- 5 Select and adjust following options, and then press **ENTER**.

Option	Description
Surround X	This option enhances sound depth and clarity by maximizing the Surround effect.
Treble	Controls the dominant sounds in the output. When you turn up the treble, it will increase the output to the higher frequency range.
Bass	Controls the softer sounds in the output. When you turn up the bass, it will increase the output to the lower frequency range.
Reset	Resets the sound mode to the default setting.

- 6 When you are finished, press **EXIT**.
When you return to the previous menu, press **BACK**.

ENTERTAINMENT

Using integrated media features

Connecting USB storage devices

Connect USB storage devices such as a USB flash memory, external hard drive, or MP3 player to the TV and use multimedia features ("Browsing files" See p.30).

Connect a USB flash memory or USB memory card reader to the TV as shown on the following illustration. The USB screen appears.

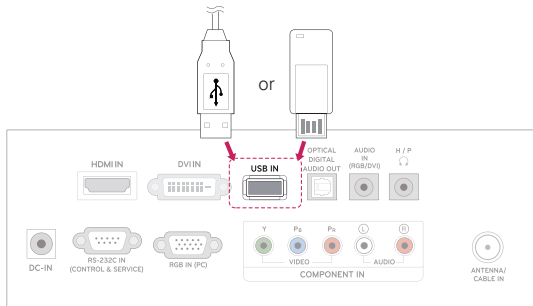

To disconnect a USB storage device, make sure to end the connection properly to prevent damages to the TV or files.

- 1 Press **●.MENU** to access the quick menus.
- 2 Press the Navigation buttons to scroll to **USB Device** and press **ENTER**.
- 3 Disconnect the USB storage device only when the message says that it is safe to remove.



CAUTION

- Do not turn the TV off or remove a USB storage device while the USB storage device is connected to the TV, as this could result in loss of files or damage to the USB storage device.
- Back up your files saved on a USB storage device frequently, as you may lose or damage the files and this may be not covered by the warranty.

Tips for using USB storage devices

- Only a USB storage device is recognizable.
- If the USB storage device is connected through a USB hub, the device is not recognizable.
- A USB storage device using an automatic recognition program may not be recognized.
- A USB storage device that uses its own driver may not be recognized.
- The recognition speed of a USB storage device may depend on each device.
- Please do not turn off the TV or unplug the USB device when the connected USB storage device is working. When such device is suddenly separated or unplugged, the stored files or the USB storage device may be damaged.
- Do not connect a USB storage device that has been artificially written to on the PC. The device may cause the TV to malfunction or fail to be played. Never forget to use only a USB storage device that has normal music files or image files.
- Please use only a USB storage device that was formatted as a FAT16, FAT32, NTFS file system provided with the Windows operating system. If a storage device has been formatted as a different utility program that is not supported by Windows, it may not be recognized. Data on a USB storage device cannot be deleted in the NTFS file system.
- Please connect power to a USB storage device that requires an external power supply. If not, the device may not be recognized.
- Please connect a USB storage device with the cable provided by the USB maker. If connected with an aftermarket cable or an excessively long cable, the device may not be recognized.
- Some USB storage devices may not be supported or operate smoothly.
- A maximum of 999 files and folders can be recognized.
- Data on a USB storage device cannot be aligned. Up to 128 English characters can be recognized as a file name.
- Please back up important files because data on the USB device may be damaged. Data management is solely the consumer's responsibility and the manufacturer does not cover the product bearing data damage.
- If the USB is connected in Standby Mode, the device will automatically be loaded when the TV is turned on.
- The recommended capacity is 1TB or less for an external USB hard disk and 32GB or less for USB memory.
- Any device with more than the recommended capacity may not work properly.
- If an external USB hard disk with a "Power Saving" function does not work, turn the hard disk off and on again to make it work properly.
- USB storage devices below USB 2.0 are supported, but they may not work properly in the movie list.
- When using a USB HDD via a USB extension cable, connect it to a supported power source.

Browsing files

Access the **Photo**, **Music** or **Movie** lists and browse files.

- 1 Connect a **USB** storage device.
- 2 Press the Navigation buttons to scroll to **PHOTO LIST**, **MUSIC LIST** or **MOVIE LIST** and press **ENTER**.



- 3 Select **Drive1** to access the connected USB storage device

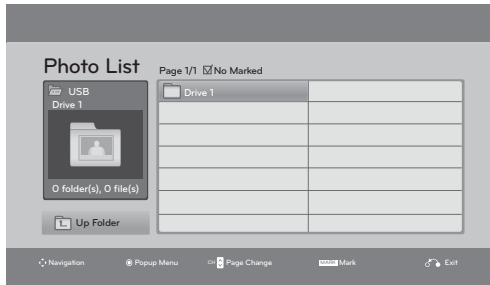

- 4 Select a folder you want.
- To return to the previous level, select **Up Folder**.

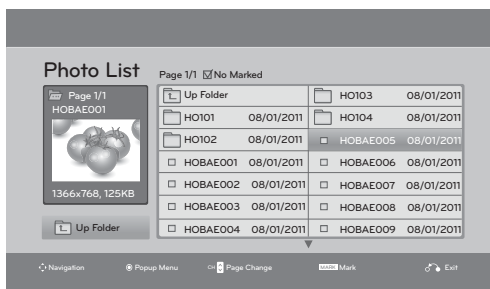

- 5 Press the Navigation buttons to browse files. The highlighted file will display in the preview window.

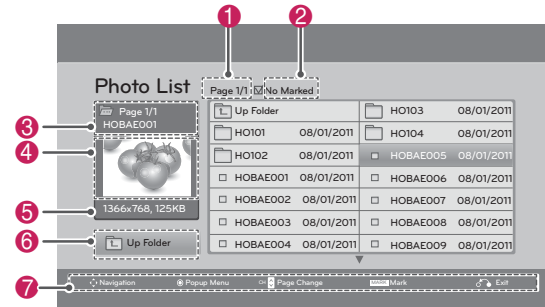

No.	Description
1	Current page number/total number of pages
2	The number of selected files
3	File and Folder name
4	Preview window
5	File size, information.
6	Return to the previous level
7	Available buttons on the remote control

Supported file format

Type	Supported file format
Photo	<ul style="list-style-type: none"> JPG Available size Baseline: 64 pixel (W) x 64 pixel (H) - 15360 pixel (W) x 8640 pixel (H) Progressive: 64 pixel (W) x 64 pixel (H) - 1920 pixel (W) x 1440 pixel (H)
Music	<ul style="list-style-type: none"> MP3 Bit rate range 32 Kbps - 320 Kbps Sampling rate (Sampling Frequency) MPEG1 layer 3: 32 kHz, 44.1 kHz, 48 kHz MPEG2 layer 3: 16 kHz, 22.05 kHz, 24 kHz MPEG2.5 layer 3: 8 kHz, 11.025 kHz, 12 kHz * A copy-protected file will not play.
Video	<ul style="list-style-type: none"> dat, mpg, mpeg, ts, trp, tp, vob, mp4, mkv, avi, divx Max bit rate of playable movie file: 20Mbps (Mega bit per second) Bit rate of audio format: within 32 - 320kbps (MP3) Supported subtitle format: *.smi, *.srt, *.sub (MicroDVD, SubViewer1.0/2.0), *.ass, *.ssa, *.txt (TMPlayer), *.psb(PowerDivx)

Viewing Photos

View image files saved in a USB storage device. The displays on the screen may differ from the model.

- 1 Press the Navigation buttons to scroll to **USB** and press **ENTER**.
- 2 Press the Navigation buttons to scroll to **Photo List** and press **ENTER**.
- 3 Press the Navigation buttons to select **Drive1** to access the connected USB storage device.
- 4 Press the Navigation buttons to scroll to a folder you want and press **ENTER**.
- 5 Press the Navigation buttons to scroll to a file you want and press **ENTER**.

A pop-up window will appear.

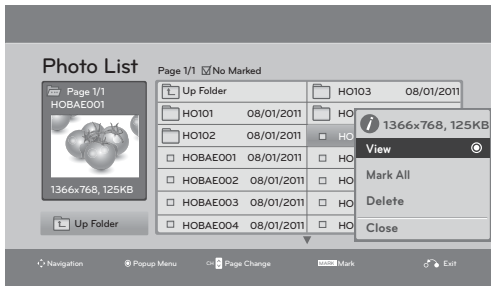

- 6 View photos by using the following menus.

Menu	Description
View	Displays the selected photo in a full-screen view. <ul style="list-style-type: none"> • Drive: Views photos saved in a USB storage drive.
Mark All or Unmark All	Selects all files or clears all of your selections
Delete	Deletes a file saved in a USB storage device. <div style="border: 1px solid black; padding: 5px; margin-top: 10px;"> <p>NOTE</p> <p>You cannot delete the files saved in a shared folder of a PC.</p> </div>
Close	Closes the pop-up menu.

Using photo options

Use the following options while viewing photos.

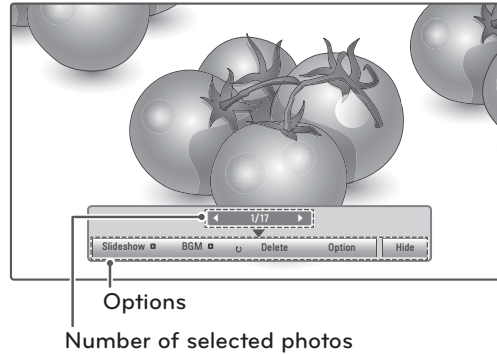

Option	Description
Slideshow	Starts or stops a slideshow with selected photos. If there are no selected photos, all photos saved in the current folder display during a slideshow. To set a slideshow speed, select Option .
BGM	Turns the background music on or off. To set the background music folder, select Option .
⤵ (Rotate)	Rotates photos clockwise (90°, 180°, 270°, 360°). <div style="border: 1px solid black; padding: 5px; margin-top: 10px;"> <p>NOTE</p> <p>The supported photo size is limited. You cannot rotate a photo if the resolution of the rotated width is larger than the supported resolution size.</p> </div>
Delete	Deletes a photo.
Option	<ul style="list-style-type: none"> • Slideshow Speed: Selects a slideshow speed (Fast, Medium, Slow). • Music Album: Selects a music folder for the background music. <div style="border: 1px solid black; padding: 5px; margin-top: 10px;"> <p>NOTE</p> <p>You cannot change the music folder while the background music is playing.</p> </div>
Hide	Hides the option window. To display the options, press ENTER .

Listening to Music

- 1 Press the Navigation buttons to scroll to **USB** and press **ENTER**.
- 2 Press the Navigation buttons to scroll to **Music List** and press **ENTER**.
- 3 Select **Drive1** to access the connected USB storage device.
- 4 Press the Navigation buttons to scroll to a folder you want and press **ENTER**.
- 5 Press the Navigation buttons to scroll to a file you want and press **ENTER**.
A pop-up window will appear.

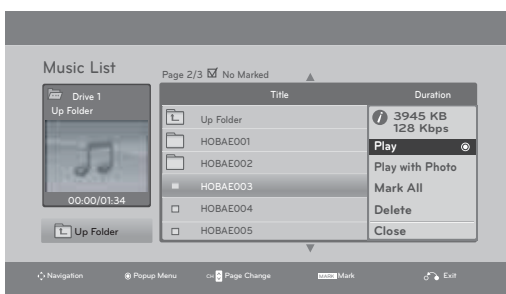

- 6 Play music by using the following menus.

Menu	Description
Play, Stop Play, or Play Marked	Plays music, stops playback, or plays the selected music file. If you play music without selecting music files, all of the music files saved in the current folder will play. The ♪ icon will appear in front of the duration on the currently playing file. <ul style="list-style-type: none"> • Drive: Listen to music files saved in a USB storage drive.
Play with Photo	Displays photos during playback.
Mark All or Unmark All	Selects all files or clears all of your selections
Delete	Deletes a file saved in a USB storage device.
Close	Closes the pop-up menu.

- 7 Control playback by using the following buttons.

Button	Description
■	Stops playback
▶	Plays a music file
	Pauses or resumes playback
▶▶	Skips to the next file
◀◀	Skips to the previous file

NOTE

- A damaged or corrupted file will not play and the duration of the file display as 00:00.
- A copy-protected file will not play.
- If the TV is not in use for some time during playback, the information box as a screensaver will appear to prevent image burn.

To return to the Music list screen, press **ENTER** or **BACK**.

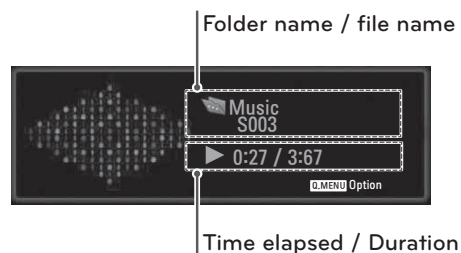

Viewing Movies

Play video files on the TV. Your TV displays all of the video files saved in a USB storage device.

- 1 Press the Navigation buttons to scroll to **USB** and press **ENTER**.
- 2 Press the Navigation buttons to scroll to **Movie List** and press **ENTER**.
- 3 Select **Drive1** to access the connected USB storage device.
- 4 Press the Navigation buttons to scroll to a folder you want and press **ENTER**.
- 5 Press the Navigation buttons to scroll to a file you want and press **ENTER**.
A pop-up window will appear.

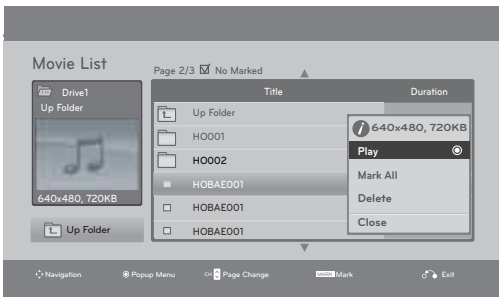

- 6 Play video by using the following menus.

Menu	Description
Play or Play Marked	Plays a movie or plays the selected movie. • Drive : Views videos saved in a USB storage drive.
Mark All or Unmark All	Selects all files or clears all of your selections.
Delete or Delete marked	Deletes a file formatted on the FAT32 file system and saved in a USB storage device.
Close	Closes the pop-up menu.



NOTE

The  image under the preview window will appear if you select a non-supported file.

- 7 Control playback by using the following buttons.

Button	Description
INFO ⓘ	Views the information of the currently playing video
■	Stops the playback
▶	Plays a video
	Pauses or resumes the playback
◀◀	Scans backward in a file
▶▶	Scans forward in a file
< or >	Skips to specific points in a file during playback. The time of a specific point will appear on the status bar. In some files, this function may not work properly.
◀◀ or ▶▶	Plays videos in slow motion
ENERGY SAVING 	Press the ENERGY SAVING button repeatedly to increase the brightness of your screen.

Video options

- 1 Press **ENTER** during playback.
- 2 Press **RED** button to access the **Pop-Up** menus.
- 3 Press the Navigation buttons to scroll to one of the following options and press **ENTER**.

Option	Description
Picture Size	<ul style="list-style-type: none"> • Full: Displays the video image to fit the screen. • Original: Displays the video image in the original size.
Audio Language	Changes the audio language. If a file has only one audio language, you cannot change the language.
Subtitle Language	<p>Activates or deactivates the subtitle. If there are two or more subtitles, select one of the subtitles.</p> <ul style="list-style-type: none"> » Latin1 includes English, Spanish, and French. » Korean includes English and Korean. <ul style="list-style-type: none"> • Sync: Synchronizes the subtitle with a video. Adjust the subtitle by 0.5 seconds forward or backward. • Position: Moves the subtitle position.

Using the remote control.

Button	Description
◀▶	When playing, repeatedly, press the REW(◀) button to speed up ◀(x2) ◀◀(x4) ◀◀◀(x8) ◀◀◀◀(x16) ◀◀◀◀◀(x32) . repeatedly, press the FF(▶) button to speed up ▶(x2) ▶▶(x4) ▶▶▶(x8) ▶▶▶▶(x16) ▶▶▶▶▶(x32). <ul style="list-style-type: none"> Pressing these buttons repeatedly increases the fast forward/reverse speed.
⏸ (II)	During playback, press the Pause (II) button. <ul style="list-style-type: none"> Still screen is displayed. If no buttons are pressed on the remote control for 10 minutes after pausing, the TV returns to the playback state. Press the Pause (II) button and then use the FF (▶▶) button for slow motion.
< or >	When using the < or > button during playback a cursor indicating the position can be viewed on the screen.
▶ (▶)	Press the Play (▶) button to return to normal playback.
ENERGY e2 SAVING	Press the ENERGY SAVING button repeatedly to increase the brightness of your screen.(See p.43)

Movie Playing Precautions

- Some user-created subtitles may not work properly.
- Some special characters are not supported in subtitles.
- HTML tags are not supported in subtitles.
- Subtitles in languages other than the supported languages are not available.
- Time information in an external subtitle file should be arranged in ascending order to be played.
- The screen may suffer temporary interruptions (image stoppage, faster playback, etc.) when the audio language is changed.
- A damaged video file may not play correctly, or some player functions may not be usable.
- Video files produced with some encoders may not play correctly.
- If the video and audio structure of a recorded file is not interleaved, either the video or audio is output.
- HD videos with a maximum of 1920x1080 @ 25/30P or 1280x720 @ 50/60P are supported, depending on the frame rate.
- Videos with resolutions higher than 1920x1080 @ 25/30P or 1280x720 @ 50/60P may not work properly depending on the frame rate.
- Video files other than the specified types and formats may not work properly.
- Video files encoded with the GMC (Global Motion Compensation) are not supported.
- Only files saved in ASCII CODE are supported in subtitles.
- Only 250 Korean characters, 500 letters and 500 numbers are supported for each line of the subtitles.
- Only 10,000 sync blocks can be supported within the subtitle file.
- The max bitrate of playable movie files is 20Mbps.
- We do not guarantee smooth playback of profiles encoded level 4.1 or higher in H.264/AVC.
- DTS Audio codec is not supported.
- A video file more than 30GB in file size is not supported for playback.
- Playing a video via a USB connection that doesn't support high speed may not work properly.

- USB storage devices below USB 2.0 are supported, but they may not work properly in the movie list.
- The video file and the subtitle file must be located in the same folder.
- The name of the video file and the subtitle file must be the same to view the subtitles normally.

Video Format

- DivX3.11, DivX4.12, DivX5.x, DivX6, Xvid1.00, Xvid1.01, Xvid1.02, Xvid1.03, Xvid 1.10-beta-1/beta-2, Mpeg-1, Mpeg-2, Mpeg-4, H.264/AVC Xvid 1.01, Xvid 1.02, Xvid 1.03, Xvid 1.10-beta 1, Xvid 1.10-beta 2, H.264 / AVC

Audio Format

- Dolby Digital, AAC, Mpeg, MP3, LPCM, HE-AAC

Subtitle format

- *.smi/*.srt/*.sub(MicroDVD,SubViewer1.0/2.0)/*.ass/*.ssa/*.txt(TMPlayer)/*.psb(PowerDivX)

Video Decoder

- **mpg, mpeg, vob:** MPEG1, MPEG2
- **dat:** MPEG1
- **ts, trp, tp:** MPEG2, H.264 / AVC
- **mp4:** MPEG4 SP, MPEG4 ASP, Divx 3.11, Divx 4.12, Divx 5.x, Divx 6, Xvid 1.00, Xvid 1.01, Xvid 1.02, Xvid 1.03, Xvid 1.10-beta 1, Xvid 1.10-beta 2, H.264/AVC
- **avi:** MPEG 2, MPEG 4 SP, MPEG4 ASP, Divx 3.11, Divx 4, Divx 5, Divx 6, Xvid 1.00, Xvid 1.01, Xvid 1.02, Xvid 1.03, Xvid 1.10-beta 1, Xvid 1.10-beta 2, H.264/AVC
- **mkv:** H.264 / AVC, MPEG 1, MPEG 2, MPEG 4 SP, MPEG4 ASP
- **divx:** MPEG 2, MPEG 4 SP, MPEG4 ASP, Divx 3.11, Divx 4, Divx 5, Divx 6, Xvid 1.00, Xvid 1.01, Xvid 1.02, Xvid 1.03, Xvid 1.10-beta 1, Xvid 1.10-beta 2, H.264 / AVC

Audio Codec

- **mpeg, vob:** Dolby Digital, MPEG, MP3, LPCM
- **dat:** Dolby Digital, MPEG, MP3, LPCM
- **ts, trp, tp:** Dolby Digital, AAC, MPEG
- **mp4:** Dolby Digital, HE-AAC, AAC, MPEG,

MP3, LPCM

- **avi:** Dolby Digital, HE-AAC, AAC, MPEG, MP3, LPCM
- **mkv:** Dolby Digital, HE-AAC, AAC, MPEG, MP3, LPCM
- **divx:** Dolby Digital, HE-AAC, AAC, MPEG, MP3, LPCM

Max Resolution

- 1920 x 1080P @ 25 / 30P
- 1280 x 720P @ 50 / 60P

DivX registration code

Check and register the DivX registration code of your TV so that you can rent or purchase the latest movies at www.divx.com/vod. To play a rented or purchased DivX file, the file's registration code should be same with your TV's DivX registration code.

- 1 Press **MENU** to access the **USB** menus.
- 2 Press the Navigation button to scroll to **DivX Reg. Code** and press **ENTER**.
- 3 View the registration code of your TV.

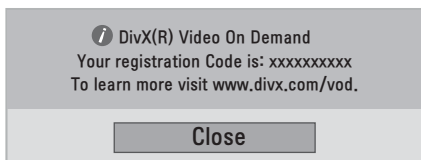

NOTE

- While you are checking the registration code, some buttons may not work.
- If you use the DivX registration code of another device, you cannot play the rented or purchased DivX file. Make sure to use the DivX registration code assigned to your TV.
- The video or audio files that are not converted by the standard DivX codec may be corrupted or not be played.
- The DivX VOD code allows you to activate up to 6 devices under one account.

Deactivating the DivX feature

Deactivate all of the devices through the web server and block devices from activating. Delete the existing authentication information to receive a new DivX user authentication for the TV. Once this function is executed, a DivX user authentication is required again to see DivX DRM files.

- 1 Press **MENU** to access the **USB** menus.
- 2 Press the Navigation button to scroll to **Deactivation** and press **ENTER**.
- 3 Select **Yes** to confirm.

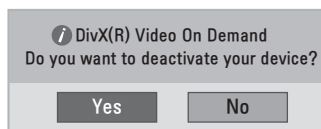

- 4 Select **Close**.



- 5 When you are finished, press **EXIT**. When you return to the previous menu, press **BACK**.

3D IMAGING(ONLY 3D MODEL)

3D Technology

This TV can display in 3D via 3D broadcasting or when the TV is connected to a compatible device, such as a Blu-ray 3D Player. The viewer must wear compatible 3D glasses in order to see these images in 3D format.

NOTE

- After powering on the TV, a few seconds may be needed for your TV to calibrate.

Precautions to take when viewing 3D images

WARNING

- If you view 3D images from too close a distance, your eyesight may deteriorate.
- If you view images in 3D for a long period of time, you may feel dizzy or experience blurred vision.
- If you are pregnant, elderly, have heart problems, experience severe nausea or if you are under the influence of alcohol, we recommend that you do not view 3D images.
- This is because the 3D images can cause disorientation and confusion.
- Put fragile or breakable objects away when viewing 3D images.
- Such objects may break, or cause personal injuries when you are startled by the realistic 3D images.
- Parents should prevent children who are 5 years or younger from watching 3D images because viewing 3D images can be harmful to vision development.
- Warning about photosensitivity seizures. Some users may have a seizure or other abnormal reactions when they are exposed to a flashing light or a particular pattern in a video game or film. If anyone in your family has a history of epilepsy or has ever experienced any kind of seizure, please consult your doctor before viewing 3D images. If you exhibit any of the symptoms listed below when viewing 3D images, stop viewing immediately and have a break.
 - » Dizziness, blurred vision or facial tics, involuntary movements, twitching, blackouts, confusion and disorientation. Please consult your doctor if such symptoms persist.
- To prevent a photosensitivity seizure, please take the following precautions.
 - » Have a 5- to 15-minute break every hour.
 - » If your left and right eye sight is significantly different, correct the sight difference first.
 - » You should be able to see all of the screen at eye level.
 - » If you experience headaches, fatigue or dizziness, stop viewing and have a rest.
 - » Do not view 3D images when you are tired or ill.

CAUTION

- Parents/guardians should TVchildren's viewing of 3D images because they may not be used to the 3D viewing experience and lack knowledge on how to handle potential risks.

When using 3D Glasses



CAUTION

- Do not use the 3D glasses to replace your corrective glasses, sunglasses or protective goggles.
- Do not store the 3D glasses in hot or cold locations.
- Do not drop objects onto the 3D glasses. Do not drop or bend the glasses.
- Since the lenses of the 3D glasses are easily scratched, make sure to clean only with a soft cloth. Shake off any dust before using the cloth
- Do not scratch the surface of the lens (Polarized film) of 3D glasses with a sharp tool or wipe the lens with chemicals.
- The lens of the 3D glasses is different from those of general glasses, and is very thin. Therefore be careful with the glasses as the lens can be popped out easily.

3D Imaging Viewing Range

TV size, viewing angle & other circumstances may change the viewing distance and the angle of view.

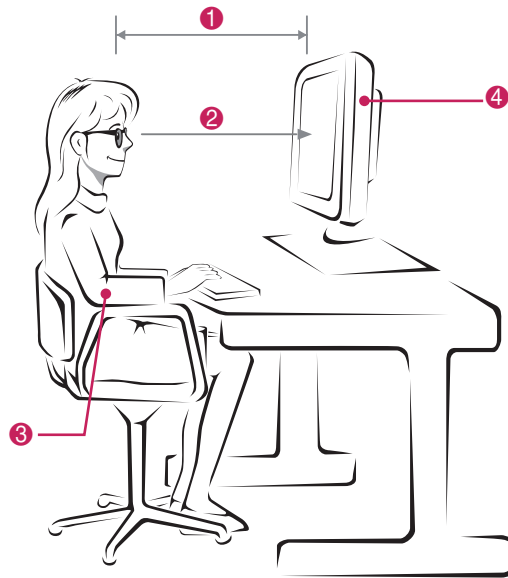



No.	Description
①	Adjust your distance from the TV to allow you to view images from the optimal distance (L).
②	Adjust the TV and your posture to allow you to view images at the optimal viewing angle (D).
③	Place your hands gently on the keyboard, keeping your arms bent at the elbows and horizontally outright.
④	Adjust the location of the TV to avoid it reflecting light.

Mode	When viewing 3D images
Size(Inch)	584.2 mm
Optimal viewing distance (L)	70 cm
Up/Down Optimal viewing angle (D)	12°

Viewing 3D Imaging

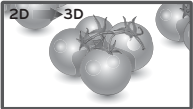
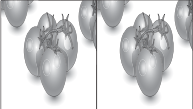
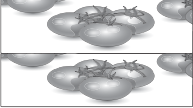
- 1 Play the video produced in 3D.
- 2 Press **3D**.
- 3 Wear the 3D glasses.
- 4 Press the Navigation buttons to scroll the **OK** and press **ENTER**.
- 5 Press the Navigation buttons to scroll the shape and press **ENTER**.

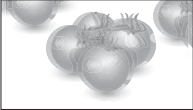
Mode	Description
2D → 3D	Changed from 2D imaging to 3D imaging. 
Side by Side	
Top & Bottom	
Checker Board	
Frame Sequential	

- 6 Press **3D** button to to **2D Off** or **3D Off**.

Mode	Description
3D → 2D	Displays images in 2D without any 3D effects.
2D → 3D	Displays images in 3D.
3D Off	Displays images in original format.
Cancel	Close the pop-up window.

3D Mode Setting Option

- 1 Press **3D SETTING** to access the **Pop-Up** menus.
- 2 Press the Navigation buttons to scroll to one of the following options and press **ENTER**

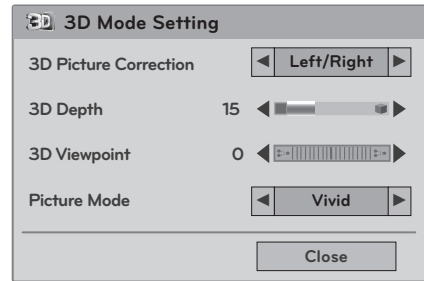

The available 3D Mode Settings are described in the following:

Option	Description	
3D Picture Correction	Select Left/Right or Right/Left. Select the screen with 3D video with better visibility.	
3D Depth	Adjusts the stereoscopic effect of the 3D image converted from a 2D image.	
3D Viewpoint	Moves the 3D image to the front and back to adjust the 3D perspective view.	
Picture Mode	Selects one of the preset image or customizes options in each mode for the best TV screen performance. You are also able to customize advanced options of each mode. The available preset picture modes vary depending on the TV.	
	Mode	
	Vivid	Adjusts the video image for the retail environment by enhancing the contrast, brightness, Color, and sharpness.
	Standard	Adjusts the image for the normal environment.
	Natural	Adjusts the image for the natural screen status.
	Cinema	Optimizes the video image for a cinematic look to enjoy movies as if you are in a movie theater.
	Sport	Optimizes the video image for high and dynamic actions by emphasizing primary Colors such as white, grass, or sky blue.
	Game	Optimizes the video image for a fast gaming screen such as PCs or games.
Expert 1/2	Adjusts the detailed video image settings for video experts as well as general viewers.	

NOTE

- The 3D Depth option is enabled when 2D images are converted into 3D.
- You cannot enter the Main menu while watching 3D files.

CAUTION

- Some menus may not work while viewing 3D imaging.
- The 3D imaging is disabled automatically when switching DTV channels or input source.
- The screen may not be displayed properly if you view 2D images in 3D imaging mode.
- 3D effect can be seen when 3D Mode is selected appropriately for the 3D input signal supplied to the TV.

CUSTOMIZING SETTINGS

Accessing main menus

- 1 Press **MENU** to access the main menus.
- 2 Press the Navigation buttons to scroll to one of the following menus and press **ENTER**.
- 3 Press the Navigation buttons to scroll to the setting or option you want and press **ENTER**.
- 4 When you are finished, press **EXIT**.
When you return to the previous menu, press **BACK**.

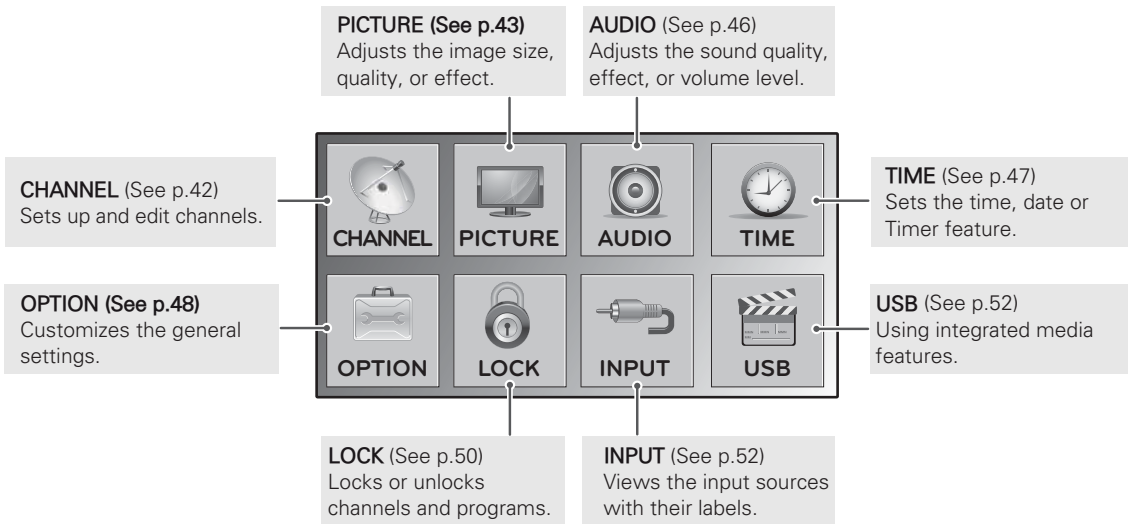
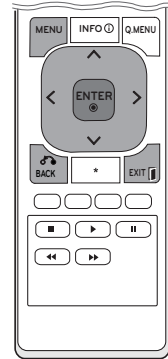

Connect various external devices to the ports on the TV's back panel.

- 1 Find an external device you want to connect to your TV shown on the following illustration.
- 2 Check the connection type of the external device.
- 3 Go to the appropriate illustration and check the connection details.

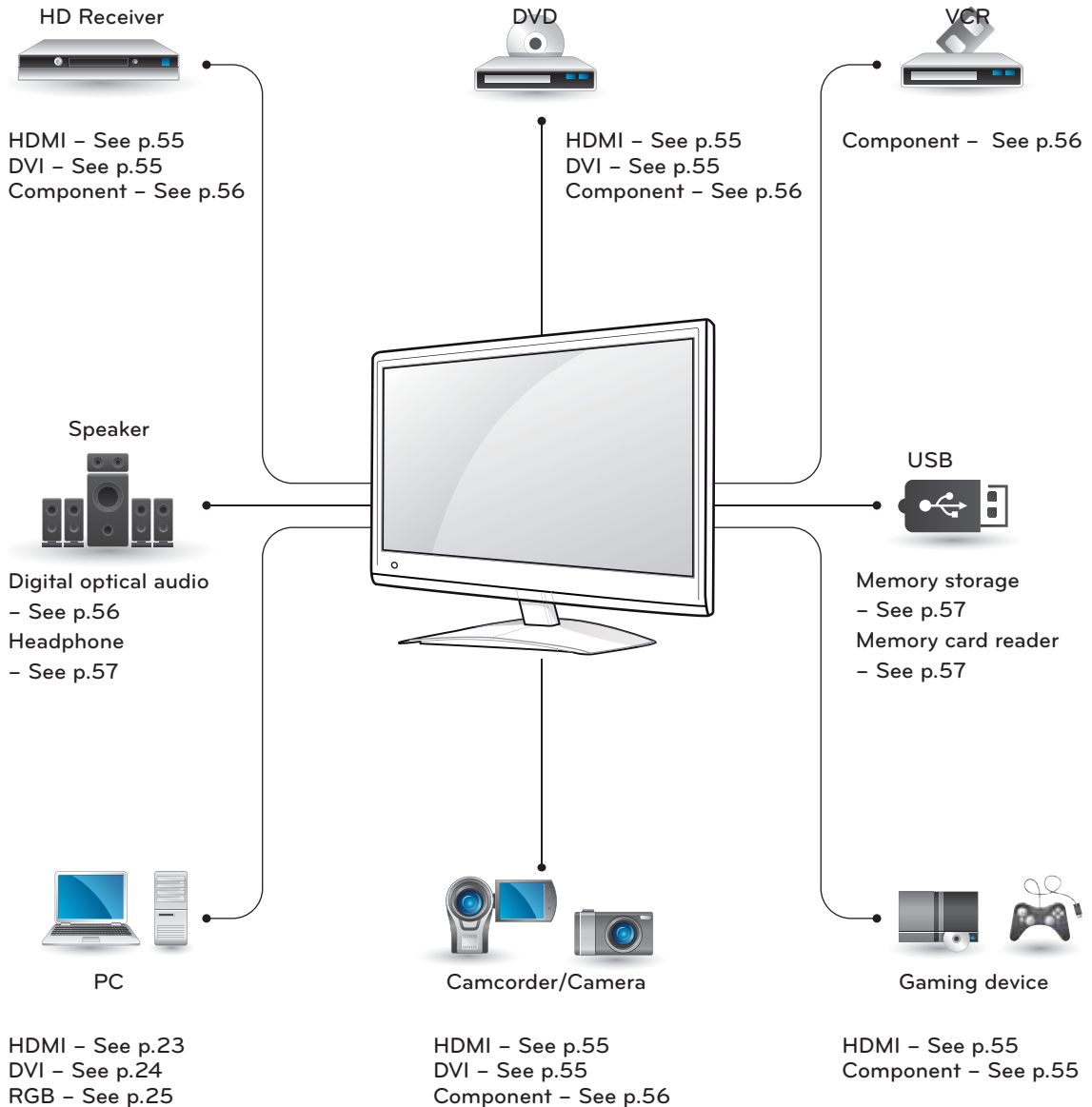

NOTE

If you connect a gaming device to the TV, use the cable supplied with the gaming device.

Connecting to a Camcorder, Camera, HD receiver, DVD, VCR player or Gaming device

Connect a Camcorder, Camera, HD receiver, DVD, VCR player or Gaming device to the TV and select an appropriate input mode.

HDMI connection

Transmits the digital video and audio signals from an external device to the TV. Connect the external device and the TV with the HDMI cable as shown on the following illustration.

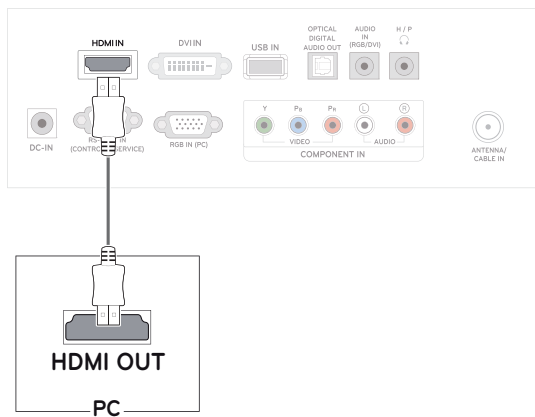

DVI to HDMI connection

Transmits the digital video signal from an external device to the TV. Connect the external device and the TV with the DVI-HDMI cable as shown in the following illustration. To transmit an audio signal, connect an optional audio cable.

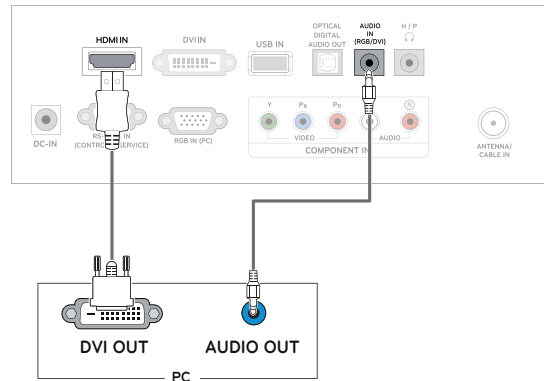

NOTE

- Use a High Speed HDMI™ Cable.
- High Speed HDMI™ Cables are tested to carry an HD signal up to 1080p and higher.

DVI connection

Transmits the digital video signal from an external device to the Monitor set. Connect the external device and the Monitor set with the DVI cable as shown in the following illustration. To transmit an audio signal, connect an optional audio cable.

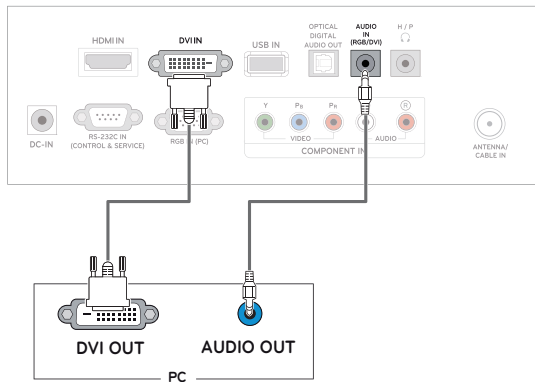

Component connection

Transmits the analog video and audio signals from an external device to the TV. Connect the external device and the TV with the component cable as shown on the following illustration. To display images by using progressive scan, make sure to use the component cable.

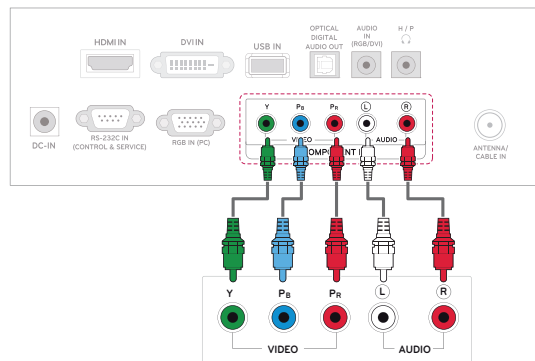

Connecting to an audio system

Use an optional external audio system instead of the built-in speaker.

! NOTE

- If you use an external audio device instead of the built-in speaker, set the TV speaker feature to off (See p.46).

Digital optical audio connection

Transmits the digital audio signal from the TV to an external device. Connect the external device and the TV with the optical audio cable as shown on the following illustration

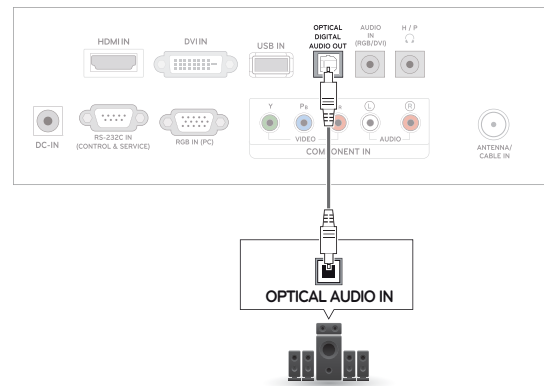

Headphone connection

Transmits the headphone signal from the TV to an external device. Connect the external device and the TV with the headphone as shown on the following illustration.

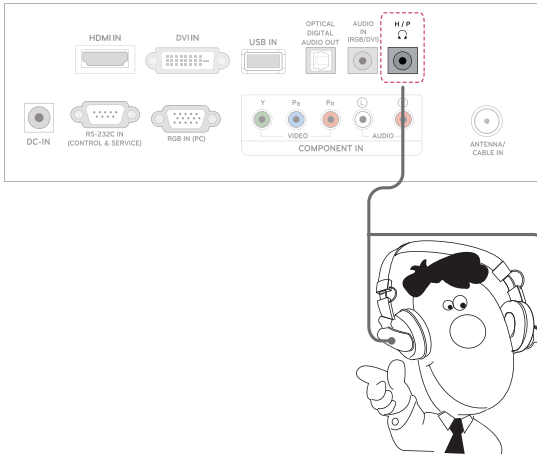

Connecting to a USB

Connect a USB storage device such as a USB flash memory, external hard drive, MP3 player or a USB memory card reader to the TV and access the USB menu to use various multimedia files. "Connecting USB storage devices" on See p.28 and "Browsing files" on See p.30

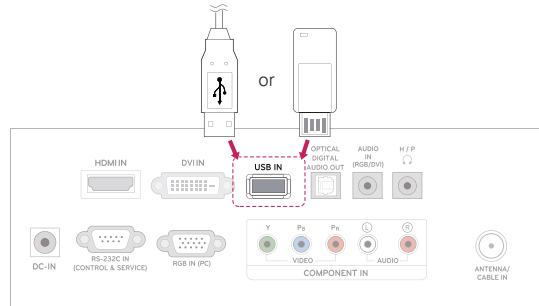

MAINTENANCE

Clean your TV regularly to keep the best performance and to extend the product lifespan.



CAUTION

- Make sure to turn the power off and disconnect the power cord and all other cables first.
- When the TV is left unattended and unused for a long time, disconnect the power cord from the wall outlet to prevent possible damage from lightning or power surges.

Screen and frame

To remove dust, wipe the surface with a dry and soft cloth.

To remove major dirt, wipe the surface with a soft cloth dampened in clean water or a diluted mild detergent. Then wipe immediately with a clean and dry cloth.



CAUTION

- Do not push, rub, or hit the surface with your fingernail or a sharp object, as this may result in scratches on the screen and image distortions.
- Do not use any chemicals, such as waxes, benzene, alcohol, thinners, insecticides, air fresheners, lubricants, as these may damage the screen's finish and cause discolorations.

Cabinet and stand

To remove dust, wipe the cabinet with a dry and soft cloth.

To remove major dirt, wipe the cabinet with a soft cloth dampened in a clean water or water containing a small amount of mild detergent.



CAUTION

- Do not spray liquid onto the surface. If water enters the TV, it may result in fire, electric shock, or malfunction.
- Do not use any chemicals as this may deteriorate the surface.

Power cord

Remove the accumulated dust or dirt on the power cord regularly.

TROUBLESHOOTING

General

The operation does not work normally.

Problem	Resolution
The remote control doesn't work	<ul style="list-style-type: none"> • Check to see if there is any object between the product and the remote control causing obstruction. Ensure you are pointing the remote control • Ensure that the batteries are installed with correct polarity (⊕ to ⊕, ⊖ to ⊖). • Ensure that the correct remote operating mode is set: TV, VCR, etc. • Install new batteries.
Power is suddenly turned off	<ul style="list-style-type: none"> • Is the sleep timer set? • Check the power control settings. Power interrupted. • If the TV is switched on and there is no input signal, it will switch off automatically after 15 minutes to save the power consumption. • When a broken file was played in the USB mode, the TV may turn off. Please check the file in your usb storage. • Except the screen off mode of the energy saving menu.

The video function does not work.

Problem	Resolution
No picture & No sound	<ul style="list-style-type: none"> • Check whether the product is turned on. • Try another channel. The problem may be with the broadcast. • Is the power cord inserted into wall power outlet? • Check your antenna direction and/or location. • Test the wall power outlet, plug another product's power cord into the outlet where the product's power cord was plugged in.
Picture appears slowly after switching on	<ul style="list-style-type: none"> • This is normal, the image is muted during the product startup process. Please contact your service centre, if the picture has not appeared after five minutes.
No Color, poor color, or poor picture	<ul style="list-style-type: none"> • Adjust Color in menu option. • Keep a sufficient distance between the product and the VCR. • Try another channel. The problem may be with the broadcast. • Are the video cables installed properly? • Activate any function to restore the brightness of the picture.
Horizontal / vertical bars or picture shaking	<ul style="list-style-type: none"> • Check for local interference such as an electrical appliance or power tool.
Poor reception on some channels	<ul style="list-style-type: none"> • Station or cable product experiencing problems, tune to another station. • Station signal is weak, reorient antenna to receive weaker station. • Check for sources of possible interference.
Lines or streaks in pictures	<ul style="list-style-type: none"> • Check antenna (Change the direction of the antenna).

Problem	Resolution
No picture when connecting HDMI	<ul style="list-style-type: none"> Check that your HDMI cable is High Speed HDMI Cable. If the HDMI cables are not High Speed HDMI Cable, flickering or no screen display can result. Please use the High Speed HDMI Cable.

The audio function does not work.

Problem	Resolution
Picture OK & No sound	<ul style="list-style-type: none"> Press the VOL(+, -) button or VOL(◀, ▶) button. Sound muted? Press MUTE button. Try another channel. The problem may be with the broadcast. Are the audio cables installed properly?
No output from one of the speakers	<ul style="list-style-type: none"> Adjust Balance in menu option.
Unusual sound from inside the product	<ul style="list-style-type: none"> A change in ambient humidity or temperature may result in an unusual noise when the product is turned on or off and does not indicate a problem with the product.
No sound when connecting HDMI or USB	<ul style="list-style-type: none"> Check HDMI cable is High Speed HDMI Cable. Check USB cable over version 2.0. Use a normal MP3 file

There is a problem with PICTURE settings.

Problem	Resolution
When the user changes the picture settings, the TV automatically converts back to the initial settings after a certain period of time.	<ul style="list-style-type: none"> It means that the TV is currently set to Store Demo mode. To switch to Home use mode you should do the followings: From the TV Menu, choose OPTION ▶ Choose Initial Setting ▶ Choose Home use. Now, you have completed switching to the Home use mode.

PC mode

No image is displayed.

Problem	Resolution
Power is on, power indicator is blue but the screen appears extremely dark.	<ul style="list-style-type: none"> Adjust brightness and contrast again.
Does the 'Invalid format' message appear?	<ul style="list-style-type: none"> The signal from the PC (Video card) is out of the vertical or horizontal frequency range of the product. Adjust the frequency range by referring to the Specifications in this user's guide.
Does the 'Check signal cable' message appear?	<ul style="list-style-type: none"> The signal cable between PC and product is not connected. Check the signal cable. Press the 'INPUT' button in the remote control to check the input signal.

'Unknown Product' message appears when the product is connected.

Problem	Resolution
Did you install the driver?	<ul style="list-style-type: none"> • Install the product driver, which is provided with the product, or download it from the web site. (http://www.lg.com) • See if the plug & play function is supported by referring to the video card user's guide.

After-image appears on the product.

Problem	Resolution
After-image appears when the product is turned off.	<ul style="list-style-type: none"> • If you use a fixed image for a long time, the pixels may be damaged quickly. Use the screen saver function.

Screen Color is abnormal.

Problem	Resolution
Screen has poor Color resolution (16_Colors).	<ul style="list-style-type: none"> • Set screen Color resolution to more than 24 bits (true Color) Select control Pane ► Display ► Settings ► Color Table menu in Windows.
Screen Color is unstable or mono Color.	<ul style="list-style-type: none"> • Check the connection status of the signal cable.
Do back spots appear on the screen?	<ul style="list-style-type: none"> • Several pixels (red, green, white or black Color) may appear on the screen, which can be attributable to the unique characteristics of the LCD panel. It is not a malfunction of the LCD.

The screen image looks abnormal.

Problem	Resolution
Is the screen position wrong?	<ul style="list-style-type: none"> • Adjust the Position menu in OSD. From the TV Menu, Choose PICTURE ► Choose Screen ► Adjusts Position. • A See if the video card resolution and frequency are supported by the product. If the frequency is out of range, set to the recommended resolution in the Control Panel ► Display ► Setting menu.
Do thin lines appear on the background screen?	<ul style="list-style-type: none"> • Adjust the Size menu in OSD. From the TV Menu, Choose PICTURE ► Choose Screen ► Adjusts Size.
Horizontal noise appears or the characters look blurred.	<ul style="list-style-type: none"> • Adjust the Phase menu in OSD. From the TV Menu, Choose PICTURE ► Choose Screen ► Adjusts Phase.

TROUBLESHOOTING WHEN USING 3D MODE

I can see a swirling oil-like pattern on the TV when the TV is turned off.

This is caused by the interference of external light in the air layer between the LCD surface and 3D filter. The pattern becomes almost invisible when you turn on the power again.

I cannot see 3D image properly

Problem	Resolution
If you are not using the glasses provided with the TV.	When you view 3D images with this monitor, it is very important that you use the glasses provided with the TV. The glasses are designed to compensate optically for the 3D filter attached to the surface of the monitor. If you wear third-party glasses, you may not see 3D images properly on the TV.
If you view 3D images outside the optimal viewing angle or distance.	The optimal viewing angle of this TV is between 14° degrees; the optimal viewing distance is between 50 cm to 90 cm from the TV. When you view 3D images outside the optimal viewing angle or viewing distance, the images may look overlapped or not be displayed properly in 3D.

Notes for Viewing 3D Image with 3D Digital Brodcatng

***In Analogue Brodcatng, 3D Imaging does not work.**

Problem	Resolution
When switching the 2D image display to the 3D image display with the 3D button on the remote control, the overlapped image may be displayed.	<ul style="list-style-type: none"> • Disable the 3D imaging mode with the 3D button. • The 3D imaging mode is disabled automatically if you change the channel.
If the screen is divided into left/right or top/bottom when you change the channel 	This channel supports the 3D imaging mode. Select the 3D imaging type displayed on the screen by pressing the 3D button on the remote control.
If your eyes are sore or the screen looks blurry while viewing 3D images.	Select Left/Right or Right/Left option, which you find better for viewing 3D images.

DM2350D

LCD Panel	Screen Type	584.2 mm Wide (23 inch) TFT (Thin Film Transistor) LCD (Liquid Crystal Display) Panel. Visible diagonal size : 584.2 mm
	Pixel Pitch	0.265 mm (H) x 0.265 mm (V)
Video Signal	Max. Resolution	1920 × 1080 @ 60 Hz
	Recommended Resolution	1920 × 1080 @ 60 Hz
	Horizontal Frequency	30 kHz to 83 kHz
	Vertical Frequency	56 Hz to 75 Hz
	Synchronization Type	Separate Sync, Digital
Input Connector		TV, D-Sub Analog, PC Audio In, Component, HDMI,DVI-D
Power	Rated Voltage	
	Power Consumption	On Mode : 48 W (typ.) Off Mode ≤ 0.5 W
AC/DC Adapter		Manufacturer: LITE-ON, Model PA-1650-68 INPUT: AC 100-240 V 50/60 Hz 2.0 A OUTPUT: DC 19 V / 3.42 A
Tilt	Tilt Range	-5 to 18°
Dimensions (Width x Height x Depth) Weight		546.7 mm x 423.8 mm x 180 mm 3.9 kg
Environmental conditions	Operating Temperature	10 °C to 35 °C
	Operating Humidity	20 % to 80 %
	Storage Temperature	-10 °C to 60 °C
	Storage Humidity	5 % to 90 %

Product specifications shown above may be changed without prior notice due to upgrade of product functions.

RGB(PC)/DVI-D(PC) supported mode

M1950D

Resolution	Horizontal Frequency(kHz)	Vertical Frequency(Hz)
640 x 480	31.469	59.940
640 x 480	37.500	75.000
800 x 600	37.879	60.317
800 x 600	46.875	75.000
1024 x 768	48.363	60.004
1024 x 768	60.023	75.029
1280 x 768	47.776	59.870
1280 x 800	49.306	59.910
1360 x 768	47.712	60.015

M2450D DM2350D

Resolution	Horizontal Frequency(kHz)	Vertical Frequency(Hz)
720 x 400	31.468	70.080
640 x 480	31.469	59.940
640 x 480	37.500	75.000
800 x 600	37.879	60.317
800 x 600	46.875	75.000
1024 x 768	48.363	60.000
1024 x 768	60.023	75.029
1152 x 864	67.500	75.000
1280 x 720	45.000	60.000
1280 x 800	49.702	59.810
1280 x 1024	63.981	60.020
1280 x 1024	79.976	75.025
1400 x 1050	65.317	59.978
1440 x 900	55.935	59.887
1600 x 900	60.000	60.000
1680 x 1050	64.674	59.883
1680 x 1050	65.290	59.954
1920 x 1080	67.500	60.000

HDMI (PC) supported mode

M1950D

Resolution	Horizontal Frequency(kHz)	Vertical Frequency(Hz)
720 x 400	31.468	70.080
640 x 480	31.469	59.940
640 x 480	37.500	75.000
800 x 600	37.879	60.317
800 x 600	46.875	75.000
1024 x 768	48.363	60.004
1024 x 768	60.023	75.029
1152 x 864	67.500	75.000
1280 x 960	60.000	60.000
1280 x 1024	63.981	60.020
1280 x 1024	79.976	75.025
1440 x 900	55.935	59.887
1680 x 1050	64.674	59.883
1680 x 1050	65.290	59.954
1920 x 1080	67.500	60.000

M2450D DM2350D

Resolution	Horizontal Frequency(kHz)	Vertical Frequency(Hz)
720 x 400	31.468	70.080
640 x 480	31.469	59.940
640 x 480	37.500	75.000
800 x 600	37.879	60.317
800 x 600	46.875	75.000
1024 x 768	48.363	60.004
1024 x 768	60.023	75.029
1152 x 864	67.500	75.000
1280 x 720	45.000	60.000
1280 x 800	49.702	59.810
1280 x 1024	63.981	60.020
1280 x 1024	79.976	75.025
1400 x 1050	65.317	59.978
1440 x 900	55.935	59.887
1600 x 900	60.000	60.000
1680 x 1050	64.674	59.883
1680 x 1050	65.290	59.954
1920 x 1080	67.500	60.000

HDMI (DTV) supported mode

Resolution	Horizontal Frequency(kHz)	Vertical Frequency(Hz)
720 x 480	31.469 31.500	59.940 60.000
720 x 576	31.250	50.000
1280 x 720	37.500	50.000
1280 x 720	44.960 45.000	59.940 60.000
1920 x 1080	33.720 33.750	59.940 60.000
1920 x 1080	28.125	50.000
1920 x 1080	27.000	24.000
1920 x 1080	33.750	30.000
1920 x 1080	56.250	50.000
1920 x 1080	67.430 67.500	59.940 60.000

Component supported mode

Resolution	Horizontal Frequency(kHz)	Vertical Frequency(Hz)
720 x 480	15.730	59.940
720 x 480	15.750	60.000
720 x 576	15.625	50.000
720 x 480	31.470	59.940
720 x 480	31.500	60.000
720 x 576	31.250	50.000
1280 x 720	44.960	59.940
1280 x 720	45.000	60.000
1280 x 720	37.500	50.000
1920 x 1080	33.720	59.940
1920 x 1080	33.750	60.000
1920 x 1080	28.125	50.000
1920 x 1080	56.250	50.000
1920 x 1080	67.432	59.940
1920 x 1080	67.500	60.000

Component port connecting informatio

Component ports on the Monitor set	Y	P _B	P _R
Video output ports on DVD player	Y	P _B	P _R
	Y	B-Y	R-Y
	Y	Cb	Cr
	Y	Pb	Pr

NOTE

- Avoid keeping a fixed image on the set's screen for prolonged periods of time. The fixed image may become permanently imprinted on the screen. Use a screen saver when possible.
- There may be interference relating to resolution, vertical pattern, contrast or brightness in PC mode. Change the PC mode to another resolution or change the refresh rate to another rate or adjust the brightness and contrast on the menu until the picture is clear. If the refresh rate of the PC graphic card can not be changed, change the PC graphic card or consult the manufacturer of the PC graphic card.
- The synchronization input waveform for Horizontal and Vertical frequencies are separate.
- Connect the signal cable from the TV output port of the PC to the RGB (PC) port of the TV or the signal cable from the HDMI output port of the PC to the HDMI/DVI IN port on the TV.
- Connect the audio cable from the PC to the Audio input on the TV. (Audio cables are not included with the TV).
- If using a sound card, adjust PC sound as required.
- If the graphic card on the PC does not output analogue and digital RGB simultaneously, connect only one of either RGB or HDMI/DVI IN to display the PC output on the TV.
- If the graphic card on the PC does output analogue and digital RGB simultaneously, TV the TV to either RGB or HDMI. (The other mode is set to Plug and Play automatically by the TV.)
- DOS mode may not work depending on the video card if you use an HDMI to DVI cable.
- If you use too long an RGB-PC cable that is too long, there may be interference on the screen. We recommend using under 5 m of cable. This provides the best picture quality.

3D video input format supported. (Only 3D Model)

	Signal	Resolution	Horizontal Frequency (kHz)	Vertical Frequency (Hz)	Playable 3D video format
HDMI	720p	1280 x 720	45	60	Top & Bottom, Side by Side
			89.9 90	59.94 60	HDMI Frame Packing
			37.5	50	Top & Bottom, Side by Side
			75		HDMI Frame Packing
	1080i	1920 x 1080	33.75	60	Top & Bottom, Side by Side
			28.125	50	
	1080p	1920 x 1080	67.50	60	Top & Bottom, Side by Side, Checker Board, Single Frame Sequential
			56.250	50	Top & Bottom, Side by Side, Checker Board, Single Frame Sequential
			27	24	Top & Bottom, Side by Side, Checker Board
			53.95 54	23.98 24	HDMI Frame Packing
33.75			30	Top & Bottom, Side by Side, Checker Board	
USB	1080p	1920 x 1080	33.75	30	Top & Bottom, Side by Side, Checker Board
RGB/DVI	1080p	1920 x 1080	66.587	59.93	Top & Bottom, Side by Side
	Signal				Playable 3D video format
DTV	720p, 1080i				Top & Bottom, Side by Side

**NOTE**

- If HDMI input is received in HDMI 3D format, images are automatically converted into 3D.
- **2D → 3D** mode is available to watch for all signals.
- If you change **2D → 3D** mode, the left and right edges of the screen are clipped.
- If you select HDMI 3D, 3D mode is automatically enabled, which may cause the delay of screen turning on.
- For some 3D content files, if a 3D file is converted into 2D, the left and right edges of the screen may appear truncated.

IR CODES

- This feature is not available for all models.

Code (Hexa)	Function	Note
95	Energy Saving (eS)	R/C BUTTON
08	⏻ (POWER)	R/C BUTTON (POWER ON/OFF)
50	TV / PC	R/C BUTTON
0B	INPUT	R/C BUTTON
79	RATIO	R/C BUTTON
99	Auto Config	R/C BUTTON
45	Q.MENU	R/C BUTTON
43	MENU	R/C BUTTON
AA	INFO ⓘ	R/C BUTTON
40	Up (▲)	R/C BUTTON
41	Down (▼)	R/C BUTTON
07	Left (←)	R/C BUTTON
06	Right (→)	R/C BUTTON
44	Enter(Ⓞ)	R/C BUTTON
28	BACK	R/C BUTTON
5B	EXIT	R/C BUTTON
02	Vol (+)	R/C BUTTON
03	Vol (-)	R/C BUTTON
1E	FAV (MARK)	R/C BUTTON
09	MUTE	R/C BUTTON
00	CH (▲)	R/C BUTTON
01	CH (▼)	R/C BUTTON
10 to 19	Number Key	R/C BUTTON
53	LIST	R/C BUTTON
1A	FLASHBK	R/C BUTTON
72	RED Key	R/C BUTTON
71	GREEN Key	R/C BUTTON
63	YELLOW Key	R/C BUTTON
61	BLUE Key	R/C BUTTON
B1	■	R/C BUTTON
B0	▶	R/C BUTTON
BA		R/C BUTTON
8F	◀	R/C BUTTON
8E	▶	R/C BUTTON

Only 3D Model

Code (Hexa)	Function	Note
DC	3D	R/C BUTTON
45	Q.MENU(3D SETTING)	R/C BUTTON

EXTERNAL CONTROL DEVICE SETUP

RS-232C Setup

Connect the RS-232C (serial port) input jack to an external control device (such as a computer or an A/V control system) to control the product's functions externally.

Connect the serial port of the control device to the RS-232C jack on the product back panel.

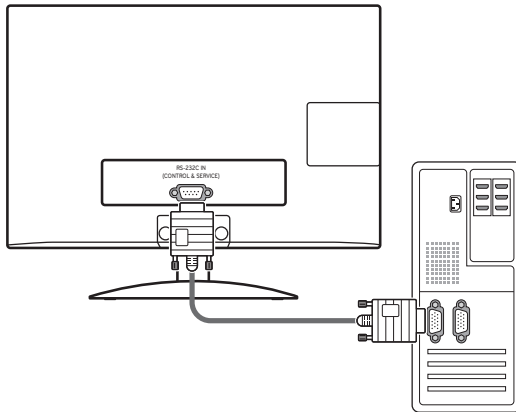

! NOTE

RS-232C on this unit is intended to be used with third party RS-232C control hardware and software. The instructions below are provided to help with programming software or to test functionality using telenet software. RS-232C connection cables are not supplied with the product.

Type of connector; D-Sub 9-Pin Male

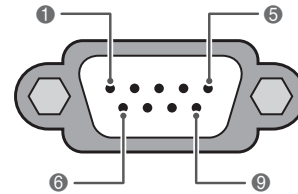

RS-232C IN
(CONTROL & SERVICE)

No.	Pin name
1	No connection
2	RXD (Receive data)
3	TXD (Transmit data)
4	DTR (DTE side ready)
5	GND
6	DSR (DCE side ready)
7	RTS (Ready to send)
8	CTS (Clear to send)
9	No Connection

Communication Parameters

- Baud rate: 9600 bps (UART)
- Data length: 8 bits
- Parity: None
- Stop bit: 1 bit
- Communication code: ASCII code
- Use a crossed (reverse) cable.

! NOTE

This product has command echo back in the RS-232C Command.

RS-232C configurations

7-Wire Configuration

(Serial female-female NULL modem cable)

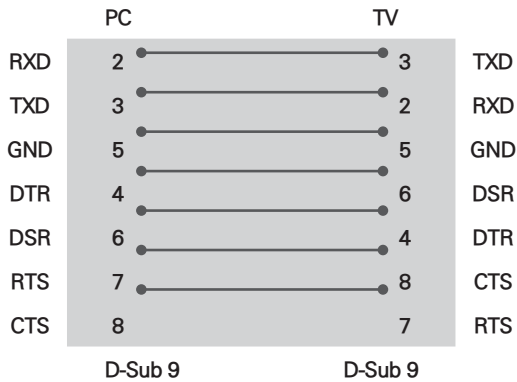

3-Wire Configurations(Not standard)

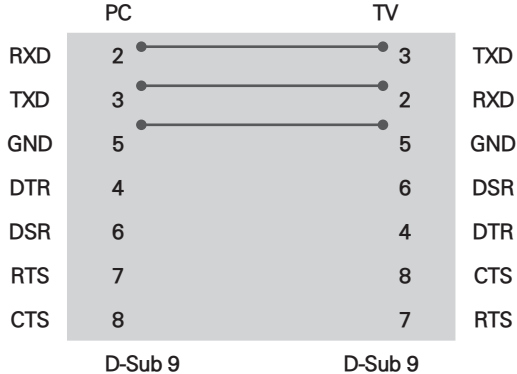

Set ID

Set ID number. "Real Data Mapping"



- 1 Press **MENU** to access the main menus.
- 2 Press the Navigation buttons to scroll to **OPTION** and press **ENTER**.
- 3 Press the Navigation buttons to scroll to **Set ID** and press **ENTER**.
- 4 Scroll left or right to select a set ID number and select **Close**. The adjustment range is 1-99.
- 5 When you are finished, press **EXIT**.
When you return to the previous menu, press **BACK**.

* REAL DATA MAPPING

```

1 : Step 0
:
A : Step 10 (Set ID 10)
:
F : Step 15 (Set ID 15)
10 : Step 16 (Set ID 16)
:
63 : Step 99 (Set ID 99)
64 : Step 100

```

Command reference list

	COMMAND1	COMMAND2	DATA (Hexadecimal)
01. Power	k	a	00 to 01
02. Input Select	x	b	See p.74
03. Aspect Ratio	k	c	00 to 10
04. Screen Mute	k	d	00 to 01
05. Volume Mute	k	e	00 to 64
06. Volume Control	k	f	00 to 64
07. Contrast	k	g	00 to 64
08. Brightness	k	h	00 to 64
09. Color	k	i	00 to 64
10. Tint	k	j	00 to 64
11. Sharpness	k	k	00 to 01
12. OSD Select	k	l	00 to 01
13. Remote Control Lock Mode	k	m	00 to 64
14. Treble	k	r	00 to 64
15. Bass	k	s	00 to 64
16. Balance	k	t	00 to 64
17. Color Temperature	k	u	00 to 02
18. Energy Saving	j	q	See p.76
19. Auto Configuration	j	u	See p.76
20. Channel Add/Del	m	c	00 to 01
21. Key	m	g	Key Code
22. Backlight	m	g	00 to 64
24. 3D	x	t	See p.78
25. Extended 3D	x	v	See p.78

	COMMAND 1	COMMAND 2	DATA00 (Hexadecimal)	DATA01 (Hexadecimal)
23. Channel Tuning	m	a	physical channel	major high
	DATA02 (Hexadecimal)	DATA03 (Hexadecimal)	DATA04 (Hexadecimal)	DATA05 (Hexadecimal)
	major low	minor high	minor low	attribute

Transmission / Receiving protocol

Transmission

[Command1][Command2][Set ID][Data][Cr]

[Command 1] : First command to control the set.(j, k, m or x)

[Command 2] : Second command to control the set.

[Set ID] : You can adjust the set ID to choose desired TV ID number in Setup menu. Adjustment range is 1 to 99. When selecting Set ID '0', every connected the TV is controlled. Set ID is indicated as decimal (1 to 99) on menu and as Hexa decimal (0x0 to 0x63) on transmission /receiving protocol.

[DATA] : To transmit the command data. Transmit the 'FF' data to read status of command.

[Cr] : Carriage Return ASCII code '0x0D'

[] : ASCII code 'space (0x20)'

* In this model, TV will not send the status during the standby mode.

OK Acknowledgement

[Command2][Set ID][OK][Data][x]

The TV transmits ACK (acknowledgement) based on this format when receiving normal data. At this time, if the data is data read mode, it indicates present status data. If the data is data write mode, it returns the data of the PC computer.

* In this model, TV will not send the status during the standby mode.

* Data Format

[Command 2] : Use as command.

[Set ID] : Use the small character, if set ID is 10, it will send the '0', 'a'.

[DATA] : Use the small character, if data is 0 x ab, it will send the 'a', 'b'.

[OK] : Use the large character.

Error Acknowledgement

[Command2][Set ID][NG][Data][x]

The TV transmits ACK (acknowledgement) based on this format when receiving abnormal data from non-viable functions or communication errors.

Data1: Illegal Code

Data2: Not supported function

Data3: Wait more time

* In this model, TV will not send the status during the standby mode.

* Data Format

[Command 2] : Use as command.

[Set ID] : Use the small character, if set ID is 10, it will send the '0', 'a'.

[DATA] : Use the small character, if data is 0 x ab, it will send the 'a', 'b'.

[NG] : Use the large character

01. Power (Command: k a)

To control Power On/Off of the TV.

Transmission
[k][a][][Set ID][][Data][Cr]

Data 00: Power Off Data 01: Power On

Acknowledgement
[a][][Set ID][][OK/NG][Data][x]

* In a like manner, if other functions transmit 'FF' data based on this format, Acknowledgement data feedback presents status about each function.

* Note: In this model, TV will send the Acknowledge after power on processing completion.

There might be a time delay between command and acknowledgement.

02. Input Select (Command: x b)

To select input source for TV.

Transmission
[x][b][][Set ID][][Data][Cr]

Data 00: DTV (Antenna)
Data 01: DTV (Cable)
Data 10: Analog (Antenna)
Data 11: Analog (Cable)
Data 40: Component
Data 60: RGB-PC
Data 90: HDMI1
Data 91: DVI

Acknowledgement
[b][][Set ID][][OK/NG][Data][x]

03. Aspect Ratio (Command: k c)

To adjust the screen format.

Transmission
[k][c][][Set ID][][Data][Cr]

Data 01: 4:3
Data 02: 16:9
Data 04: Zoom
Data 06: Set by program
Data 09: Just scan
Data 10: Cinema Zoom1
:
Data 1F: Cinema Zoom16

Acknowledgement
[c][][Set ID][][OK/NG][Data][x]

04. Screen Mute (Command: k d)

To select screen mute on/off.

Transmission
[k][d][][Set ID][][Data][Cr]

Data 00: Screen mute off (Picture on),
Video-out Mute off

Data 01: Screen mute on (Picture off)

Data 10: Video-out Mute on

Acknowledgement
[d][][Set ID][][OK/NG][Data][x]

* In case of Video-out Mute on only, TV will display On Screen Display (OSD). But, in case of screen mute on, TV will not display On Screen Display (OSD).

05. Volume Mute (Command: k e)

To control volume mute on/off.

You can also adjust mute using the MUTE button on remote control.

Transmission
[k][e][][Set ID][][Data][Cr]

Data 00: Volume mute on (Volume off)

Data 01: Volume mute off (Volume on)

Acknowledgement
[e][][Set ID][][OK/NG][Data][x]

06. Volume Control (Command: k f)

To adjust volume.

You can also adjust volume with the volume buttons on remote control.

Transmission
[k][f][][Set ID][][Data][Cr]

Data Min: 00 to Max: 64

(*transmit by Hexadecimal code)

*Refer to 'Real data mapping'. See p.71

Acknowledgement
[g][][Set ID][][OK/NG][Data][x]

07. Contrast (Command: k g)

To adjust screen contrast.

You can also adjust contrast in the PICTURE menu..

Transmission
[k][g][][Set ID][][Data][Cr]

Data Min: 00 to Max: 64

(*transmit by Hexadecimal code)

*Refer to 'Real data mapping'. See p.71

Acknowledgement
[g][][Set ID][][OK/NG][Data][x]

08. Brightness (Command: k h)

To adjust screen brightness.
You can also adjust brightness in the PICTURE menu.

Transmission
[k][h][][Set ID][][Data][Cr]

Data Min: 00 to Max: 64
(*transmit by Hexadecimal code)
*Refer to 'Real data mapping'. See p.71

Acknowledgement
[h][][Set ID][][OK/NG][Data][x]

09. Color (Command: k i)

To adjust screen color.
You can also adjust color in the PICTURE menu.

Transmission
[k][i][][Set ID][][Data][Cr]

Data Min: 00 to Max: 64
(*transmit by Hexadecimal code)
*Refer to 'Real data mapping'. See p.71

Acknowledgement
[i][][Set ID][][OK/NG][Data][x]

10. Tint (Command: k j)

To adjust screen tint.
You can also adjust tint in the PICTURE menu.

Transmission
[k][j][][Set ID][][Data][Cr]

Data Red: 00 to Green: 64
(*transmit by Hexadecimal code)
*Refer to 'Real data mapping'. See p.71

Acknowledgement
[j][][Set ID][][OK/NG][Data][x]

11. Sharpness (Command: k k)

To adjust screen sharpness.
You can also adjust sharpness in the PICTURE menu.

Transmission
[k][k][][Set ID][][Data][Cr]

Data Min: 00 to Max: 64
(*transmit by Hexadecimal code)
*Refer to 'Real data mapping'. See p.71

Acknowledgement
[k][][Set ID][][OK/NG][Data][x]

12. OSD Select (Command: k l)

To select OSD (On Screen Display) on/off.

Transmission
[k][l][][Set ID][][Data][Cr]

Data 00: OSD off
Data 01: OSD on

Acknowledgement
[l][][Set ID][][OK/NG][Data][x]

13. Remote Control Lock Mode (Command: k m)

To lock the remote control and the front panel controls on the TV.

Transmission
[k][m][][Set ID][][Data][Cr]

Data 00: Lock off
Data 01: Lock on

Acknowledgement
[m][][Set ID][][OK/NG][Data][x]

If you're not using the remote control and front panel controls on the TV, use this mode. When main power is on/off, remote control lock is released. If Key Lock is on in the standby mode, TV will not turn on by POWER button of remote control and on the TV.

14. Treble (Command: k r)

To adjust treble.
You can also adjust treble in the AUDIO menu.

Transmission
[k][r][][Set ID][][Data][Cr]

Data Min: 00 to Max: 64
(*transmit by Hexadecimal code)
*Refer to 'Real data mapping'. See p.71

Acknowledgement
[r][][Set ID][][OK/NG][Data][x]

15. Bass (Command: k s)

To adjust bass.
You can also adjust bass in the AUDIO menu.

Transmission
[k][s][][Set ID][][Data][Cr]

Data Min: 00 to Max: 64
(*transmit by Hexadecimal code)
*Refer to 'Real data mapping'. See p.71

Acknowledgement
[s][][Set ID][][OK/NG][Data][x]

16. Balance (Command: k t)

To adjust balance.

You can also adjust balance in the AUDIO menu.

Transmission
[k][t][][Set ID][][Data][Cr]

Data Min: 00 to Max: 64

(*transmit by Hexadecimal code)

*Refer to 'Real data mapping'. See p.71

Acknowledgement
[t][][Set ID][][OK/NG][Data][x]

17. Color Temperature (Command: k u)

To adjust color temperature.

You can also adjust color temperature in the PICTURE menu.

Transmission
[k][u][][Set ID][][Data][Cr]

Data 00: Medium

Data01: Cool

Data02: Warm

Acknowledgement
[u][][Set ID][][OK/NG][Data][x]

18. Energy Saving (Command: j q)

To control the energy saving function.

Transmission
[j][q][][Set ID][][Data][Cr]

Data 00: Energy saving - off

Data 01: Energy saving - Minimum

Data 02: Energy saving - Medium

Data 03: Energy saving - Maximum

Data 05: Energy saving - Screen off

Acknowledgement
[q][][Set ID][][OK/NG][Data][x]

19. Auto Configuration (Command: j u)

To adjust picture position and minimize image shaking automatically. Auto configuration only works in RGB-PC mode.

Transmission
[j][u][][Set ID][][Data][Cr]

Data 01: To set

Acknowledgement
[u][][Set ID][][OK/NG][Data][x]

20. Channel Add/Del (Command: m b)

To add and delete the channels.

Transmission
[m][b][][Set ID][][Data][Cr]

Data 00: Channel Delete

Data 01: Channel Add

Acknowledgement
[b][][Set ID][][OK/NG][Data][x]

21. Key (Command: m c)

To send IR remote control code.

Transmission
[m][c][][Set ID][][Data][Cr]

* Data Key cod -See p.69

Acknowledgement
[c][][Set ID][][OK/NG][Data][x]

When TV is in the standby mode, TV will turn on by POWER button of remote control only.

22. Backlight (Command: m g)

To adjust screen backlight.

Transmission
[m][g][][Set ID][][Data][Cr]

Data Min: 00 to Max: 64

(*transmit by Hexadecimal code)

*Refer to 'Real data mapping'. See p.71

Acknowledgement
[g][][Set ID][][OK/NG][Data][x]

23. Channel Tuning (Command: m a)

To tune channel to following physical/major/minor number.

Transmission

```
[m][a][ ][Set ID][ ][Data00][ ][Data01][ ][Data02][ ][Data03][ ][Data04][ ][Data05][Cr]
```

Digital channels have a Physical, Major, and Minor channel number. The Physical number is the actual digital channel number, the Major is the number that the channel should be mapped to, and the Minor is the subchannel.

Since the ATSC tuner automatically maps the channel to the Major number, the Physical number is not required when sending a command.

Data 00: Physical Channel Number

NTSC air: 02 to 45, NTSC cable: 01, 0E to 7D

ATSC air: 01 to 45, ATSC cable: 01 to 87

Data 01 & 02: Major Channel Number

Data 01: High byte

Data 02: Low byte

Two bytes are available for the Major and Minor, normally only the second byte is used.

Data 03 & 04: Minor Channel Number

Not needed for NTSC.

Data05 :

7 Main/Sub Picture	6 Two/One Part Channel	5 Using Physical Channel	4 Reserved	3	2	1	0	Step
0 Main	0 Two	0 Use	x	0	0	0	0	NTSC Air
1 Sub	1 One	1 No Use	x	0	0	0	1	NTSC Cable
			x	0	0	1	0	ATSC Air
			x	0	0	1	1	ATSC Cable_std
			x	0	1	0	0	ATSC Cable_hrc
			x	0	1	0	1	ATSC Cable_irc
			x	0	1	1	0	ATSC cable_auto
			x	0	1	1	1	Reserved
			x	x	x	x	x	...
			x	1	1	1	1	Reserved

The table above lists the binary code that must be converted to hexadecimal before sending. For example, the binary code to tune the sub source to an NTSC cable channel is "1000 0001", which translates to "81" in hex.

* 7th bit: for which source do you want to change the channel.

* 6th bit: use a two part or one part channel. Most cases just use 0 since it's ignored when using NTSC.

* 5th bit: use 0 with NTSC since it can only use the physical channel number. Normally use 1 for ATSC since most times it doesn't matter what the physical number is

* 4th bit: set to 0.

* 3-0 bits: choose signal type.

* Tune Command Examples:

1. Tune to the analog (NTSC) cable channel 35.

Data 00 = Physical of 35 = 23

Data 01 & 02 = No Major = 00 00

Data 03 & 04 = No Minor = 00 00

Data 05 = 0000 0001 in binary = 01

Total = ma 00 23 00 00 00 00 01

2. Tune to the digital (ATSC) local channel 30-3.

Data 00 = Don't know Physical = 00

Data 01 & 02 = Major is 30 = 00 1E

Data 03 & 04 = Minor is 3 = 00 03

Data 05 = 0010 0010 in binary = 22

Total = ma 00 00 00 1E 00 03 22

Acknowledgement

```
[a][ ][Set ID][ ][OK][Data00][Data01][Data02][Data03][Data04][x][a][ ][Set ID][ ][NG][Data00][x]
```

24. 3D(Command: x t) (only 3D model)

To change 3D mode for TV.

```
Transmission
[x][t][ ][Set ID][ ][Data01][ ][Data02][ ][Data03][ ]
[Data04][Cr]
```

Data01

- 00 : 3D On
- 01 : 3D Off
- 02 : 3D to 2D
- 03 : 2D to 3D

Data02

- 00 : Top and Bottom
- 01 : Side by Side
- 02 : Check Board
- 03 : Frame Sequential

Data03

- 00 : Right to Left
- 01 : Left to Right

Data04

3D Depth : Min: 0 to Max: 14

*Refer to 'Real data mapping'. See p.71

*If data1 is 00(3D On), data4 has no meaning.

*If data1 is 01(3D Off) or 02(3D to 2D), data2, data3 and data4 have no meaning.

*If data1 is 03(2D to 3D), data2 and data3 have no meaning.

Data1	Data2	Data3	Data4
00	O	O	X
01	X	X	X
02	X	X	X
03	X	X	O

X : don't care

Acknowledgement

```
[t][ ][OK][Data01][Data02][Data03][Data04][x]
[t][ ][NG][Data01][x]
```

25. Extended 3D(Command: x v) (only 3D model)

To change 3D mode for TV.

```
Transmission
[x][v][ ][Set ID][ ][Data01][ ][Data02][Cr]
```

Data01 : 3D option

- 00 : 3D Picture Correction
- 01 : 3D Depth (2D to 3D Only)
- 02 : 3D Viewport

Data02 It has own range for each 3D option determined by Data01.

- 1) When Data01 is 00
 - 00 : Right to Left
 - 01 : Left to Right
- 2) When Data01 is 01
 - Data Min: 0 to Max: 14
- 3) When Data01 is 02
 - Data Min: 0 to Max: 14

*Refer to 'Real data mapping'. See p.71

Acknowledgement

```
[v][ ][OK][Data01][Data02][x][v][ ][NG][Data01][x]
```

LICENSES

Supported licenses may differ by model. For more information of the licenses, visit www.lg.com.



Manufactured under license from Dolby Laboratories. "Dolby" and the double-D symbol are trademarks of Dolby Laboratories.



HDMI, the HDMI logo and High-Definition Multimedia Interface are trademarks or registered trademarks of HDMI Licensing LLC.



ABOUT DIVX VIDEO: DivX® is a digital video format created by DivX, LLC, a subsidiary of Rovi Corporation. This is an official DivX Certified® device that plays DivX video. Visit divx.com for more information and software tools to convert your files into DivX videos.

ABOUT DIVX VIDEO-ON-DEMAND: This DivX Certified® device must be registered in order to play purchased DivX Video-on-Demand (VOD) movies. To obtain your registration code, locate the DivX VOD section in your device setup menu. Go to vod.divx.com for more information on how to complete your registration.

DivX Certified® to play DivX® video up to HD 1080p, including premium content.

DivX®, DivX Certified® and associated logos are trademarks of Rovi Corporation or its subsidiaries and are used under license.

Covered by one or more of the following U.S. patents:
7,295,673; 7,460,668; 7,515,710; 7,519,274

CHILD SAFETY

CHILD SAFETY:

It Makes A Difference How and Where You Use Your Flat Panel Display

Congratulations on your purchase! As you enjoy your new product, please keep these safety tips in mind:



THE ISSUE

- The home theater entertainment experience is a growing trend and larger flat panel displays are popular purchases. However, flat panel displays are not always supported on the proper stands or installed according to the manufacturer's recommendations.
- Flat panel displays that are inappropriately situated on dressers, bookcases, shelves, desks, speakers, chests or carts may fall over and cause injury.

THIS MANUFACTURER CARES!

- The consumer electronics industry is committed to making home entertainment enjoyable and safe.

TUNE INTO SAFETY

- One size does NOT fit all. Follow the manufacturer's recommendations for the safe installation and use of your flat panel display.
- Carefully read and understand all enclosed instructions for proper use of this product.
- Don't allow children to climb on or play with furniture and television sets.
- Don't allow place flat panel displays on furniture that can easily be used as steps, such as a chest of drawers.
- Remember that children can become excited while watching a program, especially on a "larger than life" flat panel display. Care should be taken to place or install the display where it cannot be pushed, pulled over, or knocked down.
- Care should be taken to route all cords and cables connected to the flat panel display so that they cannot be pulled or grabbed by curious children.

WALL MOUNTING: IF YOU DECIDE TO WALL MOUNT YOUR FLAT PANEL DISPLAY, ALWAYS:

- Use a mount that has been recommended by the display manufacturer and/or listed by an independent laboratory (such as UL, CSA, ETL).
- Follow all instructions supplied by the display and wall mount manufacturers.
- If you have any doubts about your ability to safely install your flat panel display, contact your retailer about professional installation.
- Make sure that the wall where you are mounting the display is appropriate. Some wall mounts are not designed to be mounted to walls with steel studs or old cinder block construction. If you are unsure, contact a professional installer.
- A minimum of two people are required for installation. Flat panel displays can be heavy.





Make sure to read the Safety Precautions before using the product.

Keep the Owner's Manual (CD) in an accessible place for future reference.

The model and serial number of the TV is located on the back and one side of the TV.

Record it below should you ever need service.

MODEL _____

SERIAL _____

■■■ Regulatory Information cont.

:: FCC Compliance Statement

This equipment has been tested and found to comply within the limits of a Class B digital device pursuant to Part 15 of the FCC Rules. These limits are designed to provide reasonable protection against harmful interference in a residential installation.

This equipment generates, uses, and can radiate radio frequency energy and if not installed and used in accordance with the instructions, may cause harmful interference to radio communications. However, there is no guarantee that interference will not occur in a particular installation.

If this equipment does cause harmful interference to radio or television reception (which can be determined by turning the equipment on and off), the user is encouraged to try to correct the interference by using one or more of the following measures:

- Reorient or relocate the receiving antenna.
- Increase the separation between the equipment and the receiver.
- Connect the equipment into an outlet on a circuit different from that to which the receiver is connected.
- Consult the dealer or an experienced radio/TV technician for help.

Caution: Changes or modifications not expressly approved by the party responsible for compliance could void the user's (or your) authority to operate the equipment. Only peripherals (digital input/output devices, terminals, printers, etc.) certified to comply with the Class B limits may be attached to this monitor. Operation with non-certified peripherals is likely to result in interference to radio and TV reception. Only shielded signal cables may be used with this System.

NOTICE

The regulations are applied only to the products with the ID LABEL indicating specific requirements.

:: Canadian DOC Notice

This Class B digital apparatus meets all requirements of the Canadian Interference-Causing Equipment Regulations. Cet appareil numérique de la classe B

respecte toutes les exigences du Règlement sur le matériel brouilleur du Canada.

NOTICE

The regulations are applied only to the products with the ID LABEL indicating specific requirements.

:: CE Conformity Notice (for Europe)

Products with the "CE" Marking comply with the EMC Directive(89/336/EEC) and LOW VOLTAGE Directive (73/23/EEC) issued by the Commission of the European Community.

Compliance with these directives implies conformity to the following European Norms :

- EN 55022 ; Radio Frequency Interference
- EN 55024 ; Electromagnetic Immunity
- EN 61000-3-2 ; Power Line Harmonics
- EN 61000-3-3 ; Voltage Fluctuations
- EN 60950-1 ; Product Safety

NOTICE

The regulations are applied only to the products with the ID LABEL indicating specific requirements.

:: Low Radiation Compliance (MPR II)

This monitor meets one of the strictest guidelines available today for low radiation emissions, offering the user extra shielding and an antistatic screen coating. These guidelines, set forth by a government agency in Sweden, limit the amount of emission allowed in the Extremely Low Frequency (ELF) and Very Low Frequency (VLF) electromagnetic range.

:: TCO'99 (TCO'99 applied model only)



Congratulations!

You have just purchased a TCO'99 approved and labelled product! Your choice has provided you with a product developed for professional use. Your purchase has also contributed to reducing the burden on the environment and also to the further development of environmentally adapted electronics products.

■■■ Regulatory Information cont.

Why do we have environmentally labelled computers?

In many countries, environmental labelling has become an established method for encouraging the adaptation of goods and services to the environment. With the growing manufacture and usage of electronic equipment throughout the world, there is a recognized concern for the materials and substances used by electronic products with regards to their eventual recycling and disposal. By proper selection of these materials and substances, the impact on the environment can be minimized.

There are also other characteristics of a computer, such as energy consumption levels, that are important from the viewpoints of both the work (internal) and natural (external) environments. Electronic equipment in offices is often left running continuously, resulting in unnecessary consumption of large amounts of energy and additional power generation. From the standpoint of carbon dioxide emissions alone, it is vital to save energy.

What does labelling involve?

The product meets the requirements for the TCO'99 scheme which provides for international and environmental labelling of personal computers and/or displays.

The labelling scheme was developed as a joint effort by the TCO (The Swedish Confederation of Professional Employees), Svenska Naturskyddsforeningen (The Swedish Society for Nature Conservation) and Statens Energimyndighet (The Swedish National Energy Administration).

Approval requirements cover a wide range of issues: ecology, ergonomics, emission of electrical and magnetical fields, energy consumption and electrical safety.

Ecological criteria impose restrictions on the presence and use of heavy metals, brominated and chlorinated flame retardants, and other substances. The product must be prepared for recycling and the manufacturing site(s) shall be certified according to ISO14001 or EMAS registered.

Energy requirements include a demand that the system unit and/or display, after a certain period of inactivity, shall reduce its power consumption to a lower level in one or more stages. The length of time to reactivate the system unit shall be reasonable for the user.

Labelled products must meet strict environmental demands, for example, in respect of the reduction of electrical and magnetical fields as well as work load and

visual ergonomics.

Below you will find a brief summary of the ecological requirements met by this product. The complete ecological criteria document can be found at TCO Development's website <http://www.tcodevelopment.com> or may be ordered from:

TCO Development

SE-114 94 STOCKHOLM, Sweden

Fax: +46 8 782 92 07

Email : development@tco.se

Information regarding TCO'99 approved and labelled products may also be obtained at <http://www.tcodevelopment.com>

Ecological requirements

Flame retardants

Flame retardants may be present in printed wiring board laminates, cables, and housings. Their purpose is to prevent, or at least to delay the spread of fire. Up to 30% by weight of the plastic in a computer casing can consist of flame retardant substances. Many flame retardants contain bromine or chlorine, and these flame retardants are chemically related to PCBs (polychlorinated biphenyls). Both the flame retardants containing bromine or chlorine and the PCBs are suspected of giving rise to health effects, including reproductive damage in fish-eating birds and mammals, due to the bio-accumulative* processes when not disposed of in accordance with strict standards for disposal.

TCO'99 requires that plastic components weighing more than 25 grams shall not contain flame retardants with organically bound bromine or chlorine. Flame retardants are allowed in the printed wiring board laminates due to the lack of commercially available alternatives.

Cadmium**

Cadmium is present in rechargeable batteries and in the colour-generating layers of certain computer displays. TCO'99 requires that batteries, the colour-generating layers of display screens, and the electrical or electronics components shall not contain any cadmium.

Mercury**

Mercury is sometimes found in batteries, relays and switches. TCO'99 requires that batteries shall not contain any mercury. It also demands that mercury is not present in any of the electrical or electronics components associated with the labelled unit. There is however one

■■■ Regulatory Information cont.

exception. Mercury is, for the time being, permitted in the back light system of flat panel monitors as there today is no commercially available alternative. TCO aims on removing this exception when a mercury free alternative is available.

Lead**

Lead can be found in picture tubes, display screens, solders and capacitors. TCO'99 permits the use of lead due to the lack of commercially available alternatives, but in future requirements TCO Development aims at restricting the use of lead.

* **Bio-accumulative is defined as substances which accumulate in living organisms.**

** **Lead, Cadmium and Mercury are heavy metals which are bio-accumulative.**

:: TCO'03 (TCO'03 applied model only)



Congratulations!

The display you have just purchased carries the TCO'03 Displays label.

This means that your display is designed, manufactured and tested according to some of the strictest quality and environmental requirements in the world. This makes for a high performance product, designed with the user in focus that also minimizes the impact on our natural environment. Some of the features of the TCO'03 Display requirements:

Ergonomics

- Good visual ergonomics and image quality in order to improve the working environment for the user and to reduce sight and strain problems. Important parameters are luminance, contrast, resolution, reflectance, colour rendition and image stability.

Energy

- Energy-saving mode after a certain time – beneficial both for the user and the environment
- Electrical safety

Emissions

- Electromagnetic fields

- Noise emissions

Ecology

- The product must be prepared for recycling and the manufacturer must have a certified environmental management system such as EMAS or ISO 14 001
- Restrictions on
 - chlorinated and brominated flame retardants and polymers
 - heavy metals such as cadmium, mercury and lead.

The requirements included in this label have been developed by TCO Development in co-operation with scientists, experts, users as well as manufacturers all over the world. Since the end of the 1980s TCO has been involved in influencing the development of IT equipment in a more user-friendly direction. Our labelling system started with displays in 1992 and is now requested by users and IT-manufacturers all over the world.

For more information, please visit
www.tcodevelopment.com

English

Information for Environmental Preservation

LGE. announced the 'LG Declaration for a Cleaner Environment' in 1994, and this ideal has served as a guiding managerial principle ever since. The Declaration is a foundation that has allowed us to undertake environmentally friendly activities in careful consideration of economic, environmental, and social aspects.

We promote activities for environmental preservation, and we specifically develop our products to embrace the concept of environment-friendly.

We minimize the hazardous materials contained in our products. For example, there is no cadmium to be found in our monitors.

Information for recycling

This monitor may contain parts which could be hazardous to the environment. It is important that this monitor be recycled after use.

LGE. handles all waste monitors through an environmentally acceptable recycling method. There are several take-back and recycling systems currently in

■■■ Regulatory Information cont.

operation worldwide. Many parts will be reused and recycled, while harmful substances and heavy metals are treated by an environmentally friendly method.

If you want to find out more information about our recycling program, please contact your local LG vendor or a corporate representative of LG.

We set our vision and policies on a cleaner world by selecting the issue of the global environment as a task for corporate improvement. Please visit our website for more information about our 'green' policies.

<http://www.lge.com/about/environment/html/Recycling.jsp>

■ ■ ■ Deutsch

Informationen zur Erhaltung der Umwelt

Im Jahr 1994 verkündete LGE die 'LG Declaration for a Cleaner Environment' (LG Erklärung für eine sauberere Umwelt). Seitdem dient dieses Ideal als führendes Prinzip des Unternehmens. Diese Erklärung war die Basis für die Durchführung von

umweltfreundlichen Aktivitäten, wobei wirtschaftliche, umweltbezogene und soziale Aspekte in die Überlegungen mit einbezogen wurden.

Wir fördern Aktivitäten zum Schutz der Umwelt und die Entwicklung unserer Produkte ist darauf ausgerichtet, unserem Konzept bezüglich Umweltfreundlichkeit gerecht zu werden.

Wir sind darauf bedacht, den Anteil der in unseren Produkten enthaltenen schädlichen Materialien zu minimieren. So ist in unseren Monitoren beispielsweise kein Kadmium zu finden.

Informationen zum Thema Recycling

Dieser Monitor enthält Teile, die umweltschädlich sein können. Es ist unbedingt erforderlich, dass der Monitor recycelt wird, nachdem er außer Dienst gestellt wurde.

Bei LGE werden alle ausrangierten Monitore in einem unter umweltbezogenen Aspekten geeigneten Verfahren recycelt. Augenblicklich sind weltweit mehrere Rücknahme- und Recyclingsysteme im Einsatz. Viele Teile werden wieder verwendet und recycelt. Schädliche Substanzen und Schwermetalle werden durch umweltverträgliche Verfahren behandelt.

Falls Sie mehr über unser Recyclingprogramm erfahren möchten, wenden Sie sich bitte an Ihren lokalen LG-Händler oder einen Unternehmensvertreter von LG.

Wir richten unsere Firmenpolitik auf eine sauberere Umwelt hin aus, indem wir umweltspezifische Aspekte als wichtigen Punkt in die Weiterentwicklung unseres Unternehmens einfließen lassen. Zusätzliche Informationen über unsere 'grüne' Firmenpolitik erhalten Sie auf unserer Website.

<http://www.lge.com/about/environment/html/Recycling.jsp>

■ ■ ■ Français

Information sur la protection de l'environnement

LGE a publié sa 'Déclaration en faveur d'un environnement plus propre' en 1994 et celle-ci est restée, depuis lors, un principe directeur de notre entreprise. Cette déclaration a servi de base à notre réflexion et nous a permis de prendre en compte à la fois les aspects économiques et sociaux de nos activités, tout en respectant l'environnement.

Nous encourageons les activités en faveur de la préservation de l'environnement et c'est dans cet esprit que nous développons nos produits : nous réduisons au minimum les matières dangereuses qui entrent dans leur composition et l'on ne trouve pas de cadmium, par exemple, dans nos moniteurs.

Information sur le recyclage

Ce moniteur peut contenir des composants qui présentent un risque pour l'environnement. Il est donc important que celui-ci soit recyclé après usage.

LGE traite les moniteurs en fin de cycle conformément à une méthode de recyclage respectueuse de l'environnement. Nous reprenons nos produits et les recyclons dans plusieurs sites répartis dans le monde entier. De nombreux composants sont réutilisés et recyclés, et les matières dangereuses, ainsi que les métaux lourds, sont traités selon un procédé écologique.

Si vous souhaitez plus de renseignements sur notre programme de recyclage, veuillez contacter votre revendeur LG ou un l'un de nos représentants.

Nous voulons agir pour un monde plus propre et croyons au rôle de notre entreprise dans l'amélioration de l'environnement. Pour plus de renseignements sur notre politique "verte", rendez visite à notre site :

<http://www.lge.com/about/environment/html/Recycling.jsp>

■■■ Regulatory Information cont.

■ ■ ■ Italiano

Informazioni per la tutela dell'ambiente

La LGE. ha annunciato nel 1994 la cosiddetta 'LG Declaration for a Cleaner Environment' (Dichiarazione di LG a favore di un ambiente più pulito), un ideale che da allora funge da principio ispiratore della gestione aziendale. La dichiarazione rappresenta il fondamento che consente di intraprendere attività a favore dell'ambiente tenendo conto degli aspetti economici, ambientali e sociali. Noi della LG, promuoviamo attività a favore della tutela dell'ambiente sviluppando appositamente i nostri prodotti per cogliere il concetto del rispetto dell'ambiente riducendo i materiali dannosi presenti nei nostri prodotti. Ad esempio nei nostri monitor non è presente il cadmio.

Informazioni per il riciclaggio

Il monitor può presentare componenti che potrebbero risultare eventualmente dannosi per l'ambiente. È importante che il monitor sia riciclato al termine del suo utilizzo.

La LGE. gestisce tutti i monitor di rifiuto con un metodo di riciclaggio soddisfacente dal punto di vista ambientale. In tutto il mondo sono attualmente in funzione numerosi sistemi di riciclaggio e recupero. I diversi componenti sono riutilizzati e riciclati, mentre le sostanze dannose e i metalli pesanti vengono trattati con un metodo rispettoso dell'ambiente.

Se si desiderano maggiori informazioni in merito al programma di riciclaggio, è consigliabile rivolgersi al proprio rivenditore LG o ad un rappresentante aziendale della LG.

Noi della LG impostiamo la nostra visione e le nostre politiche a favore di un mondo più pulito ponendo la questione dell'ambiente dal punto di vista globale come una mansione rivolta al miglioramento della nostra azienda. Vi invitiamo a visitare il nostro sito internet per ulteriori informazioni sulla nostra politica "verde".
<http://www.lge.com/about/environment/html/Recycling.jsp>

■ ■ ■ Español

Información para la conservación medioambiental

LGE. presentó la 'Declaración para un entorno más limpio de LG' en 1994 y este ideal ha servido para guiar nuestros principios empresariales desde entonces. La Declaración es la base que nos ha permitido llevar a cabo tareas que

respetan el medio ambiente siempre teniendo en cuenta aspectos sociales, económicos y medioambientales.

Promocionamos actividades orientadas a la conservación del medio ambiente y desarrollamos nuestros productos específicamente para que se ajusten a la filosofía que protege el entorno.

Reducimos al máximo el uso de materiales de riesgo en nuestros productos. Un ejemplo de ello es la ausencia total de cadmio en nuestros monitores.

Información para el reciclaje

Este monitor puede contener piezas que entrañen riesgos medioambientales. Es importante reciclar este monitor después de su utilización.

LGE. trata todos los monitores usados siguiendo un método de reciclaje que no daña al entorno. Contamos con diversos sistemas de recuperación y reciclaje que funcionan a nivel mundial en la actualidad. Es posible reciclar y reutilizar muchas de las piezas, mientras que las sustancias dañinas y los metales pesados se tratan siguiendo un método que no perjudique al medio ambiente. Si desea obtener más información acerca del programa de reciclaje, póngase en contacto con su proveedor local de LG o con un representante empresarial de nuestra marca.

Basamos nuestra visión y nuestras políticas en un mundo más limpio y para ellos optamos por un entorno global como tarea principal de nuestra evolución como empresa. Visite nuestra página Web para obtener más información sobre nuestras políticas ecológicas.

<http://www.lge.com/about/environment/html/Recycling.jsp>

■ ■ ■ Português

Informações relacionadas à preservação ambiental

A LGE. anunciou a 'LG Declaration for a Cleaner Environment' (Declaração da LG para um ambiente mais limpo) em 1994 e esse ideal tem servido desde então como um princípio administrativo de orientação. A Declaração é a base que nos tem permitido realizar atividades favoráveis ao ambiente com consideração atenta aos aspectos econômicos, ambientais e sociais.

Promovemos atividades de preservação ambiental e desenvolvemos nossos produtos para englobar

■■■ Regulatory Information cont.

especificamente o conceito de favorável ao ambiente.

Reduzimos os materiais perigosos contidos em nossos produtos. Por exemplo, não há cádmio em nossos monitores.

Informações relacionadas à reciclagem

Este monitor pode conter peças que podem representar riscos ao ambiente. É importante que ele seja reciclado após o uso.

A LGE. cuida de todos os monitores descartados através de um método de reciclagem agradável ao ambiente. Há vários sistemas de devolução e reciclagem atualmente em operação no mundo. Muitas peças serão reutilizadas e recicladas e as substâncias nocivas e os metais pesados passarão por tratamento através de um método favorável ao ambiente.

Para obter mais informações sobre nosso programa de reciclagem, entre em contato com seu fornecedor LG local ou com um representante corporativo da LG.

Definimos nossa visão e nossas políticas relacionadas a um mundo mais limpo selecionando a questão do ambiente global como uma tarefa de aprimoramento corporativo. Visite nosso site para obter mais informações sobre nossas políticas de meio ambiente.

<http://www.lge.com/about/environment/html/Recycling.jsp>

■ ■ ■ Nederlands

Informatie met betrekking tot het behoud van het milieu

LGE. publiceerde in 1994 de 'LG Declaration for a Cleaner Environment' (de LG-verklaring met betrekking tot een schoner milieu). Deze verklaring en het ideaal van een schoner milieu fungeren sindsdien als een bestuurlijke leidraad voor onze onderneming. Op basis van deze verklaring ontplooiën wij milieuvriendelijke activiteiten, waarbij er zowel met sociale en economische aspecten, als met milieuaspecten zorgvuldig rekening wordt gehouden.

Wij ondersteunen activiteiten die zijn gericht op het behoud van het milieu en wij houden bij het ontwikkelen onze producten specifiek rekening met de milieuvriendelijkheid van onze producten.

Wij minimaliseren het gebruik van schadelijke stoffen in onze producten. Er wordt bijvoorbeeld geen cadmium verwerkt in onze monitoren.

Informatie met betrekking tot recycling

Deze monitor bevat materialen die schadelijk zouden kunnen zijn voor het milieu. Het is belangrijk dat deze monitor aan het einde van zijn levensduur wordt gerecycled.

LGE. verwerkt alle afvalmonitoren via een milieuvriendelijke recyclingmethode. Hiervoor worden er momenteel wereldwijd verscheidene inname- en recyclingsystemen gehanteerd. Een groot aantal onderdelen wordt opnieuw gebruikt en gerecycled, waarbij schadelijke stoffen en zware metalen volgens een milieuvriendelijke methode worden verwerkt.

Voor meer informatie over ons recyclingprogramma kunt u contact opnemen met uw plaatselijke LG-vertegenwoordiger of een LG-vestiging.

Onze visie en ons beleid met betrekking tot een schonere wereld vloeien voort uit het feit dat wij het milieu hebben aangemerkt als een onderwerp dat speciale aandacht verdient binnen onze onderneming. Bezoek onze website voor meer informatie over ons 'groene' beleid.

<http://www.lge.com/about/environment/html/Recycling.jsp>

■ ■ ■ Russian

Информация по охране окружающей среды

В 1994 году корпорация LGE опубликовала 'Декларацию LG по охране окружающей среды', которая с тех пор служит основным принципом управления. На основе этой декларации мы смогли предпринять действия, обеспечивающие безопасность окружающей среды, уделяя при этом должное внимание экономическим, экологическим и социальным аспектам.

Мы стимулируем деятельность по охране окружающей среды, уделяя особое внимание разработке нашей продукции в соответствии с концепцией экологической безопасности.

Мы сводим к минимуму содержание опасных веществ в нашей продукции. Например, в наших мониторах вы не найдете кадмия.

Информация по утилизации отходов

Этот монитор может содержать компоненты, которые могут нанести ущерб окружающей среде.

■■■ Regulatory Information cont.

Необходимо утилизировать монитор после использования.

Корпорация LGE перерабатывает все бракованные мониторы с помощью экологически приемлемого метода утилизации отходов. По всему миру действуют системы утилизации отходов и возврата использованной продукции. Многие компоненты будут вторично использованы и утилизированы, в то время как вредные вещества и тяжелые металлы будут обработаны с помощью экологически приемлемого метода.

За более подробной информацией по нашей программе утилизации отходов обращайтесь к местному поставщику или представителю корпорации LG.

Мы ориентируемся на обеспечение экологической безопасности, ставя себе целью глобальную защиту окружающей среды. Дополнительную информацию о нашей политике по охране окружающей среды вы можете найти на нашем сайте:
<http://www.lge.com/about/environment/html/Recycling.jsp>

한국어

환경 보존 정보

LG 전자는 1994년 'LG 환경 선언문'을 발표한 후 현재까지 이를 기업 경영의 이념으로 삼아왔습니다. 이 선언문을 바탕으로 LG 전자는 모든 경영 활동에서 경제성뿐만 아니라 환경성 및 사회성을 주요 의사 결정의 기준으로 삼음으로써 지속적으로 환경 친화적인 경영을 전개하고 있습니다.

본사는 보다 활발한 환경 보존 활동과 더불어 환경 친화적 제품 개발에 주력해 왔습니다.

또한 제품에 포함되는 환경 위해 요소를 최소화하는 데에도 노력을 기울이지 않고 있습니다. LG 전자 모니터의 경우 카드를 전혀 사용하지 않는 것에서도 이러한 노력을 알 수 있습니다.

재활용 정보

본 모니터에는 환경에 위해를 주는 부품이 포함되어 있을 수도 있습니다. 따라서 사용이 끝난 모니터는 재활용하는 것이 좋습니다.

폐모니터는 모두 환경 친화적 방식으로 처리됩니다. 현재 세계적으로 운영되고 있는 회수 및 재활용 시스템에는

여러 가지가 있습니다. 대부분의 부품의 경우 재사용 또는 재활용되지만 환경 위해 물질과 중금속은 환경 친화적 방법으로 처리됩니다.

본사의 재활용 프로그램에 대한 자세한 정보는 각 지역의 LG 공급업체나 LG 기업 대표부에 문의하시기 바랍니다.

LG 전자는 기업 개선 정책의 하나로 지구 환경 문제를 채택함으로써 보다 나은 환경을 만들어 나가기 위한 비전과 정책을 수립했습니다. 본사의 친환경 정책에 대한 자세한 정보를 보시려면 아래의 웹 사이트를 방문하십시오.

http://www.lge.co.kr/cckr/about/environment/purity_02.jsp

∴EPA (EPA applied model only)

ENERGY STAR is a set of power-saving guidelines issued by the U.S. Environmental Protection Agency(EPA).



As an ENERGY STAR Partner LGE U. S. A.,Inc. has determined that this product meets the ENERGY STAR guidelines for energy efficiency.

∴NOM MARK (Mexico only)



■■■ Regulatory Information cont.

:: WEEE (for Europe)



English

Disposal of your old appliance

1. When this crossed-out wheeled bin symbol is attached to a product it means the product is covered by the European Directive 2002/96/EC.
2. All electrical and electronic products should be disposed of separately from the municipal waste stream via designated collection facilities appointed by the government or the local authorities.
3. The correct disposal of your old appliance will help prevent potential negative consequences for the environment and human health.
4. For more detailed information about disposal of your old appliance, please contact your city office, waste disposal service or the shop where you purchased the product.

French

Élimination de votre ancien appareil

1. Ce symbole, représentant une poubelle sur roulettes barrée d'une croix, signifie que le produit est couvert par la directive européenne 2002/96/EC.
2. Les éléments électriques et électroniques doivent être jetés séparément, dans les vide-ordures prévus à cet effet par votre municipalité.
3. Une élimination conforme aux instructions aidera à réduire les conséquences négatives et risques éventuels pour l'environnement et la santé humaine.
4. Pour plus d'information concernant l'élimination de votre ancien appareil, veuillez contacter votre mairie, le service des ordures ménagères ou encore la magasin où vous avez acheté ce produit.

Italian

Smaltimento delle apparecchiature obsolete

1. Quando su un prodotto è riportato il simbolo di

un bidone della spazzatura barrato da una croce significa che il prodotto è coperto dalla direttiva europea 2002/96/EC.

2. Tutti i prodotti elettrici ed elettronici dovrebbero essere smaltiti separatamente rispetto alla raccolta differenziata municipale, mediante impianti di raccolta specifici designati dal governo o dalle autorità locali.
3. Il corretto smaltimento delle apparecchiature obsolete contribuisce a prevenire possibili conseguenze negative sulla salute umana e sull'ambiente.
4. Per informazioni più dettagliate sullo smaltimento delle apparecchiature obsolete, contattare il comune, il servizio di smaltimento rifiuti o il negozio in cui è stato acquistato il prodotto.

Swedish

Kassering av din gamla apparat

1. När den här symbolen med en överkryssad soptunna på hjul sitter på en produkt innebär det att den regleras av European Directive 2002/96/EC.
2. Alla elektriska och elektroniska produkter bör kasseras via andra vägar än de som finns för hushållsavfall, helst via för ändamålet avsedda uppsamlingsanläggningar som myndigheterna utser.
3. Om du kasserar din gamla apparat på rätt sätt så bidrar du till att förhindra negativa konsekvenser för miljön och människors hälsa.
4. Mer detaljerad information om kassering av din gamla apparat kan fås av kommunen, renhållningsverket eller den butik där du köpte produkten.

Dutch

Uw oude toestel wegdoen

1. Als het symbool met de doorgekruiste verrijdbare afvalbak op een product staat, betekent dit dat het product valt onder de Europese Richtlijn 2002/96/EC.
2. Elektrische en elektronische producten mogen niet worden meegegeven met het huishoudelijk afval, maar moeten worden ingeleverd bij speciale inzamelingspunten die door de lokale of landelijke overheid zijn aangewezen.
3. De correcte verwijdering van uw oude toestel helpt negatieve gevolgen voor het milieu en de menselijke gezondheid voorkomen.

■■■ Regulatory Information cont.

4. Wilt u meer informatie over de verwijdering van uw oude toestel? Neem dan contact op met uw gemeente, de afvalophaaldienst of de winkel waar u het product hebt gekocht.

■■■ Finnish

Vanhon laitteen hävittäminen

1. Tämä merkki tuotteessa tarkoittaa, että tuote kuuluu sähkö- ja elektroniikkalaiteromusta annetun EU-direktiivin 2002/96/EY soveltamisalaan.
2. Kaikki elektroniset laitteet ovat ongelmajätettä, joten ne on toimitettava paikalliseen keräyspisteeseen.
3. Vanhan laitteen asianmukainen hävittäminen ehkäisee mahdollisia ympäristöön ja terveyteen kohdistuvia haittavaikutuksia.
4. Lisätietoa vanhan laitteen hävittämisestä saat ottamalla yhteyden paikallisiin viranomaisiin, kierrätyskeskukseen tai myymälään, josta ostit laitteen.

■■■ German

Entsorgung von Altgeräten

1. Wenn dieses Symbol eines durchgestrichenen Abfalleimers auf einem Produkt angebracht ist, unterliegt dieses Produkt der europäischen Richtlinie 2002/96/EC.
2. Alle Elektro- und Elektronik-Altgeräte müssen getrennt vom Hausmüll über dafür staatlich vorgesehenen Stellen entsorgt werden.
3. Mit der ordnungsgemäßen Entsorgung des alten Geräts vermeiden Sie Umweltschäden und eine Gefährdung der persönlichen Gesundheit.
4. Weitere Informationen zur Entsorgung des alten Geräts erhalten Sie bei der Stadtverwaltung, beim Entsorgungsamt oder in dem Geschäft, wo Sie das Produkt erworben haben.

■■■ Danish

Sådan smider du dit gamle apparat ud

1. Når der er et tegn med et kryds over en skraldespand, betyder det, at produktet er omfattet af EU-direktiv 2002/96/EC.
2. Alle elektriske og elektroniske produkter skal smides ud et andet sted end gennem den kommunale affaldsordning ved hjælp af specielle indsamlingsfaciliteter, der er organiseret af staten

eller de lokale myndigheder.

3. Korrekt bortskaffelse af dit gamle apparat er med til at forhindre mulige skadevirkninger på miljøet og menneskelig sundhed.
4. Mere detaljerede oplysninger om bortskaffelse af dit gamle apparat kan fås ved at kontakte dit lokale kommunekontor, renovationselskab eller den butik, hvor du købte produktet.

■■■ Greek

Απόρριψη της παλιάς σας συσκευής

1. Όταν ένα προϊόν διαθέτει το σύμβολο ενός διαγραμμένου κάλαθου απορριμμάτων, τότε το προϊόν καλύπτεται από την Ευρωπαϊκή Οδηγία 2002/96/ΕΟΚ.
2. Η απόρριψη όλων των ηλεκτρικών και ηλεκτρονικών προϊόντων πρέπει να γίνεται χωριστά από τα γενικά οικιακά απορρίμματα μέσω καθορισμένων εγκαταστάσεων συλλογής απορριμμάτων, οι οποίες έχουν δημιουργηθεί είτε από την κυβέρνηση ή από τις τοπικές αρχές.
3. Η σωστή απόρριψη της παλιάς σας συσκευής θα βοηθήσει στην αποτροπή πιθανών αρνητικών συνεπειών ως προς το περιβάλλον και την υγεία του ανθρώπου.
4. Για πιο λεπτομερείς πληροφορίες σχετικά με την απόρριψη της παλιάς σας συσκευής, επικοινωνήστε με το αρμόδιο τοπικό γραφείο, υπηρεσία διάθεσης οικιακών απορριμμάτων ή το μαγαζί από το οποίο αγοράσατε το προϊόν.

■■■ Spanish

Cómo deshacerse de aparatos eléctricos y electrónicos viejos

1. Si en un producto aparece el símbolo de un contenedor de basura tachado, significa que éste se acoge a la Directiva 2002/96/CE.
2. Todos los aparatos eléctricos o electrónicos se deben desechar de forma distinta del servicio municipal de recogida de basura, a través de puntos de recogida designados por el gobierno o las autoridades locales.
3. La correcta recogida y tratamiento de los dispositivos inservibles contribuye a evitar riesgos potenciales para el medio ambiente y la salud pública.
4. Para obtener más información sobre cómo deshacerse de sus aparatos eléctricos y electrónicos viejos, póngase en contacto con su ayuntamiento, el servicio de recogida de basuras o el establecimiento donde adquirió el producto.

Regulatory Information cont.

Portuguese

Eliminação do seu antigo aparelho

1. Quando este símbolo de latão cruzado estiver afixado a um produto, significa que o produto é abrangido pela Directiva Europeia 2002/96/EC.
2. Todos os produtos eléctricos e electrónicos devem ser eliminados separadamente do lixo doméstico através de pontos de recolha designados, facilitados pelo governo ou autoridades locais.
3. A eliminação correcta do seu aparelho antigo ajuda a evitar potenciais consequências negativas para o ambiente e para a saúde humana.
4. Para obter informações mais detalhadas acerca da eliminação do seu aparelho antigo, contacte as autoridades locais, um serviço de eliminação de resíduos ou a loja onde comprou o produto.

Slovak

Likvidácia váš ho starého prístroja

1. Keď sa na produkte nachádza tento symbol prečiarknutej smetnej nádoby s kolieskami, znamená to, že daný produkt vyhovuje európskej Smernici č. 2002/96/EC.
2. Všetky elektrické a elektronické produkty by mali byť zlikvidované oddelene od komunálneho odpadu prostredníctvom na to určených zberných zariadení, ktoré boli ustanovené vládou alebo orgánmi miestnej správy.
3. Správnu likvidáciu starých zariadení pomôžete predchádzať potenciálnym negatívnym následkom pre prostredie a ľudské zdravie.
4. Podrobnejšie informácie o likvidácii starých zariadení nájdete na miestnom úrade, v službe na likvidáciu odpadu alebo u predajcu, kde ste tento produkt zakúpili.

Czech

Likvidace starých spotřebičů

1. Pokud je u výrobku uveden symbol pojízdného kontejneru v přeškrtnutém poli, znamená to, že na výrobek se vztahuje směrnice Evropské unie číslo 2002/96/EC.
2. Všechny elektrické a elektronické výrobky by měly být likvidovány odděleně od běžného komunálního odpadu prostřednictvím sběrných zařízení zřízených za tímto účelem vládou nebo místní samosprávou.
3. Správný způsob likvidace starého elektrického spotřebiče pomáhá zamezit možným negativním dopadům na životní prostředí a zdraví.
4. Bližší informace o likvidaci starého spotřebiče získáte u místní samosprávy, ve sběrném zařízení nebo v obchodě, ve kterém jste výrobek zakoupili.

Croatian

Uklanjanje starog aparata

1. Ako se na proizvodu nalazi simbol prekrizene kante za smeće, to znači da je proizvod pokriven europskom direk-

tivom 2002/96/EC.

2. Električni i elektronski proizvodi ne smiju se odlagati zajedno s komunalnim otpadom, već u posebna odlagališta koja je odredila vlada ili lokalne vlasti.
3. Pravilno odlaganje starog proizvoda sprečiti će potencijalne negativne posljedice po okoliš i zdravlje ljudi.
4. Podrobnije informacije o odlaganju starog proizvoda potražite u gradskom uredu, službi za odlaganje otpada ili u trgovini u kojoj ste kupili proizvod.

Hungarian

Régi eszközök ártalmatlanítása

1. A termékhez csatolt áthúzott, keresek szeméttároló jel jelöli, hogy a termék a 2002/96/EC EU-direktíva hatálya alá esik.
2. Minden elektromos és elektronikai terméket a lakossági hulladéktól elkülönítve kell begyűjteni, a kormány vagy az önkormányzatok által kijelölt begyűjtő eszközök használatával.
3. Régi eszközeinek megfelelő ártalmatlanítása segíthet megelőzni az esetleges egészségre vagy környezetre ártalmas hatásokat.
4. Ha több információra van szüksége régi eszközeinek ártalmatlanításával kapcsolatban, tanulmányozza a vonatkozó környezetvédelmi szabályokat, vagy lépjen kapcsolatba az üzlettel, ahol a terméket vásárolta.

Polish

Utylizacja starych urządzeń

1. Kiedy do produktu dołączony jest niniejszy przekreślony symbol kołowego pojemnika na śmieci, oznacza to, że produkt jest objęty dyrektywą 2002/96/EC.
2. Wszystkie elektryczne i elektroniczne produkty powinny być utylizowane niezależnie od odpadów miejskich, z wykorzystaniem przeznaczonych do tego miejsc składowania wskazanych przez rząd lub miejscowe władze.
3. Właściwy sposób utylizacji starego urządzenia pomoże zapobiec potencjalnie negatywnemu wpływowi na zdrowie i środowisko.
4. Aby uzyskać więcej informacji o sposobach utylizacji starych urządzeń, należy skontaktować się z władzami lokalnymi, przedsiębiorstwem zajmującym się utylizacją odpadów lub sklepem, w którym produkt został kupiony.

■ ■ ■ Regulatory Information cont.

■ ■ Estonian

Kasutuskõlbmatu seadme käitlemise kord

1. Kui seade on märgistatud selle elektri- ja elektroonikaseadmete lahuskogumist märgistava tähisega (ratastega prügikonteineri kujutis, millele on rist peale tõmmatud), tuleb toodet käidelda vastavalt Eurodirektiivile 2002/96/EÜ.
2. Elektri- ja elektroonikaseadmeid ei tohi visata tavalise prügi hulka. Nad kuuluvad lahuskogumisele selleks määratud kogumispunktides.
3. Kasutuskõlbmatu tervikseadme käitlemine tavaprügist lahus on korraldatud selleks, et vältida negatiivseid tagajärgi, mida põhjustaksid seadme osade purunemisel vabaneda võivad ohtlikud jäätmed loodusele või inimorganismile.
4. Täpsemat informatsiooni selle kohta, kuhu ja millal saab ära anda oma kasutamiskõlbmatu elektri- ja elektroonikaseadme, küsige kohalikult omavalitsuselt, prügifirmalt või kaupluselt, kust seadme ostsite.

■ ■ Latvian

Vecās elektroierīces nodošana

1. Ja uz produkta ir simbols ar pārsvītrotu atkritumu tvertni, tas nozīmē, ka produkts ir iekļauts Eiropas direktīvā 2002/96/EC.
2. Visi elektriskie un elektroniskie produkti ir jāutilizē, nododot pašvaldības īpaši noteiktās pieņemšanas vietās. Tos nedrīkst izmest parastās municipalitātes atkritumu urnās.
3. Ievērojot prasības veco elektroierīču utilizēšanā, jūs pasargāsiet apkārtējo vidi un cilvēku veselību no iespējami nelabvēlīgajām sekām, kādas varētu rasties, ierīcēm sadaloties nepiemērotā vietā.
4. Lai gūtu plašāku informāciju par veco ierīču utilizēšanas iespējām, sazinieties ar pilsētas pašvaldību, atkritumu savākšanas saimniecību vai veikalu, kurā ierīci iegādājāties.

■ ■ Lithuanian

Senos įrangos atliekų tvarkymas

1. Užbrauktas konteinerio simbolis priverčia ant prekės reiškia, kad įrangą saugo Europos direktyva 2002/96/EC.
2. Visos elektros ir elektroninės įrangos atliekos turi būti renkamos atskirai ir neišmetamos į atliekų konteinerį kartu su kitomis komunalinėmis atliekomis, taikant specialią atliekų surinkimo sistemą, patvirtintą vyriausybės ar vietos valdžios.
3. Teisingas senos įrangos atliekų tvarkymas, padės išvengti neigiamų pasekmių aplinkai ir žmonių sveikatai.
4. Dėl išsamesnės informacijos apie senos įrangos tvarkymą, prašome kreiptis į miesto valdžią, atliekų perdirbimo tarnybą arba parduotuvę, kurioje pirkote įrangą.