



APPENDIX G
: USER'S MANUAL



ENGLISH

OWNER'S MANUAL

LED LCD MONITOR

Please read this manual carefully before operating your set and retain it for future reference.

LED LCD MONITOR MODELS

E2370V

E2770V

www.lg.com

This unit has been engineered and manufactured to ensure your personal safety, however improper use may result in potential electrical shock or fire hazards. In order to allow the proper operation of all safeguards incorporated in this display, observe the following basic rules for its installation, use, and servicing.

On Safety

Use only the power cord supplied with the unit. In case you use another power cord, make sure that it is certified by the applicable national standards if not being provided by the supplier. If the power cable is faulty in any way, please contact the manufacturer or the nearest authorized repair service provider for a replacement.

The appliance coupler is used as the disconnect device.

Please make sure the device is installed near the wall outlet to which it is connected and that the outlet is easily accessible.

Operate the display only from a power source indicated in the specifications of this manual or listed on the display. If you are not sure what type of power supply you have in your home, consult with your dealer.

Overloaded AC outlets and extension cords are dangerous. So are frayed power cords and broken plugs. They may result in a shock or fire hazard. Call your service technician for replacement.

As long as this unit is connected to the AC wall outlet, it is not disconnected from the AC power source even if the unit is turned off.

Do not Open the Display:

- There are no user serviceable components inside.
- There are Dangerous High Voltages inside, even when the power is OFF.
- Contact your dealer if the display is not operating properly.

To Avoid Personal Injury :

- Do not place the display on a sloping shelf unless properly secured.
- Use only a stand recommended by the manufacturer.
- Do not drop an object on or apply impact to the product. Do not throw any toys or objects on the product screen.
It can cause injury to human, problem to product and damage the display.

To Prevent Fire or Hazards:

- Always turn the display OFF if you leave the room for more than a short period of time. Never leave the display ON when leaving the house.
- Keep children from dropping or pushing objects into the display's cabinet openings. Some internal parts carry hazardous voltages.
- Do not add accessories that have not been designed for this display.
- When the display is to be left unattended for an extended period of time, unplug it from the wall outlet.
- In the presence of thunder and lightning, never touch the power cord and signal cable because it can be very dangerous. It can cause electric shock.

On Installation

Do not allow anything to rest upon or roll over the power cord, and do not place the display where the power cord is subject to damage.

Do not use this display near water such as near a bathtub, washbowl, kitchen sink, laundry tub, in a wet basement, or near a swimming pool.

Displays are provided with ventilation openings in the cabinet to allow the release of heat generated during operation. If these openings are blocked, built-up heat can cause failures which may result in a fire hazard. Therefore, NEVER:

- Block the bottom ventilation slots by placing the display on a bed, sofa, rug, etc.
- Place the display in a built-in enclosure unless proper ventilation is provided.
- Cover the openings with cloth or other material.
- Place the display near or over a radiator or heat source.

Do not rub or strike the Active Matrix LCD with anything hard as this may scratch, mar, or damage the Active Matrix LCD permanently.

Do not press the LCD screen with your finger for a long time as this may cause some afterimages.

Some dot defects may appear as Red, Green or Blue spots on the screen. However, this will have no impact or effect on the display performance.

If possible, use the recommended resolution to obtain the best image quality for your LCD display. If used under any mode except the recommended resolution, some scaled or processed images may appear on the screen. However, this is characteristic of the fixed-resolution LCD panel.

Leaving a fixed image on the screen for a long time may cause damage to the screen and cause image burn-in. Make sure to use a screen saver on the product. Burn-in and related problems are not covered by the warranty on this product.

Do not shock or scratch the front and sides of the screen with metallic objects. Otherwise, it may cause damage to the screen.

Make sure the panel faces forward and hold it with both hands to move. If you drop the product, the damaged product can cause electric shock or fire. Contact an authorized the service center for repair.

Avoid high temperatures and humidity.

On Cleaning

- Unplug the display before cleaning the face of the display screen.
- Use a slightly damp (not wet) cloth. Do not use an aerosol directly on the display screen because over-spraying may cause electrical shock.
- When cleaning the product, unplug the power cord and scrub gently with a soft cloth to prevent scratching. Do not clean with a wet cloth or spray water or other liquids directly onto the product. An electric shock may occur. (Do not use chemicals such as benzene, paint thinners or alcohol)
- Spray water onto a soft cloth 2 to 4 times, and use it to clean the front frame; wipe in one direction only. Too much moisture may cause staining.

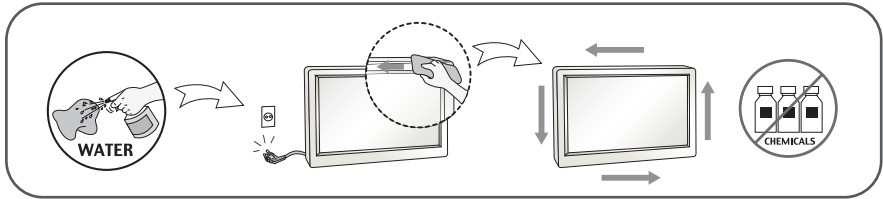

On Repacking

- Do not throw away the carton and packing materials. They make an ideal container in which to transport the unit. When shipping the unit to another location, repack it in its original material.

On Disposal (Only , Hg lamp used LCD Monitor)

- The fluorescent lamp used in this product contains a small amount of mercury.
- Do not dispose of this product with general household waste.
- Disposal of this product must be carried out in accordance to the regulations of your local authority.

!!! Thank you for selecting LGE products !!!

Please make sure the following items are included with your monitor. If any items are missing, contact your dealer.



Owner's Manual/Cards

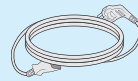

Power Cord
(Depending on the country)

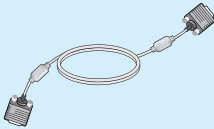

15-pin D-Sub Signal Cable

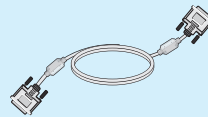

DVI-D Signal Cable
(This feature is not available in all countries.)

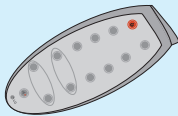

Remote control



Primary Cell Battery, Lithium

NOTE

- This accessories may look different from those shown here.
- User must use shielded signal interface cables (D-sub 15 pin cable, DVI-D cable) with ferrite cores to maintain standard compliance for the product.

Connecting the Display

Before setting up the monitor, ensure that the power to the monitor, the computer system, and other attached devices is turned off.

Connecting the stand

1. Place the monitor face down on the cushion or soft cloth.

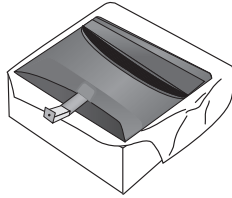

2. Assemble the **Stand Base** into the **Stand Body** in the correct direction as shown in the picture.

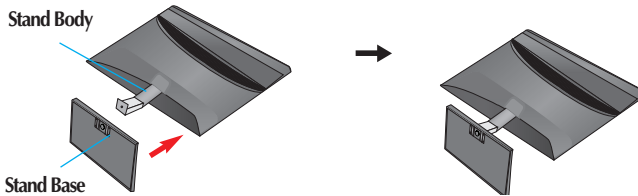

3. Use a Coin on the bottom of the stand base and turn screw clockwise to tighten.

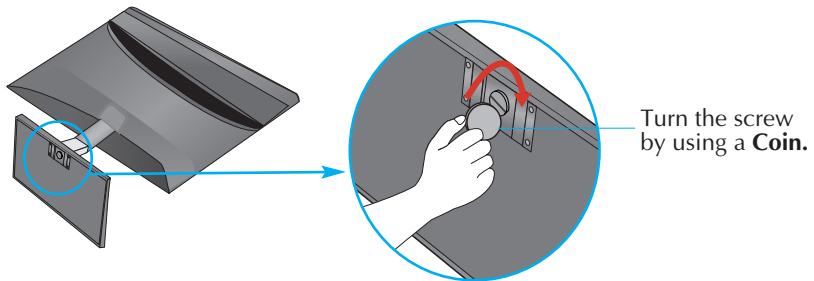

4. Once assembled take the monitor up carefully and face the front side.



Connecting the Display

- Detach the monitor to the Stand Base by turning the screw to the left.

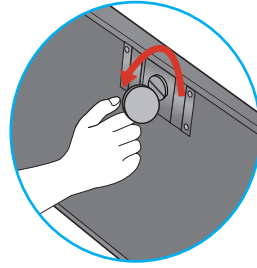

IMPORTANT

- This illustration depicts the general model of connection. Your monitor may differ from the items shown in the picture.
- Do not carry the product upside down holding only the stand base. The product may fall and get damaged or injure your foot.

Before setting up the monitor, ensure that the power to the monitor, the computer system, and other attached devices is turned off.

Positioning your display

Adjust the position of the panel in various ways for maximum comfort.

- Tilt Range : -5° to 15°

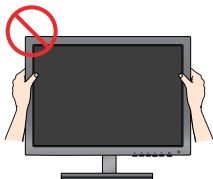
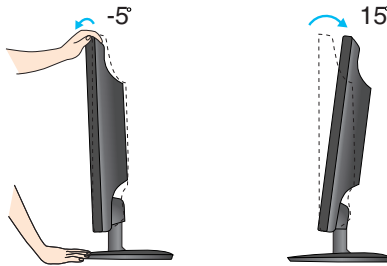

IMPORTANT

- It is recommended that in order to maintain an ergonomic and comfortable viewing position, the forward tilt angle of the monitor should not exceed 5 degrees.
- Do not touch or press the screen when adjusting the angle of the monitor.

Connecting with the PC

1. Before setting up the monitor, ensure that the power to the monitor, the computer system, and other attached devices is turned off.
2. Connect signal input cable **1** and power cord **2** in order, then tighten the screw of the signal cable.
 - A Connect DVI-D(Digital signal) Cable
 - B Connect D-sub(Analog signal) Cable
 - C Connect HDMI Cable

NOTE

- This is a simplified representation of the rear view.
- This rear view represents a general model; your display may differ from the view as shown.

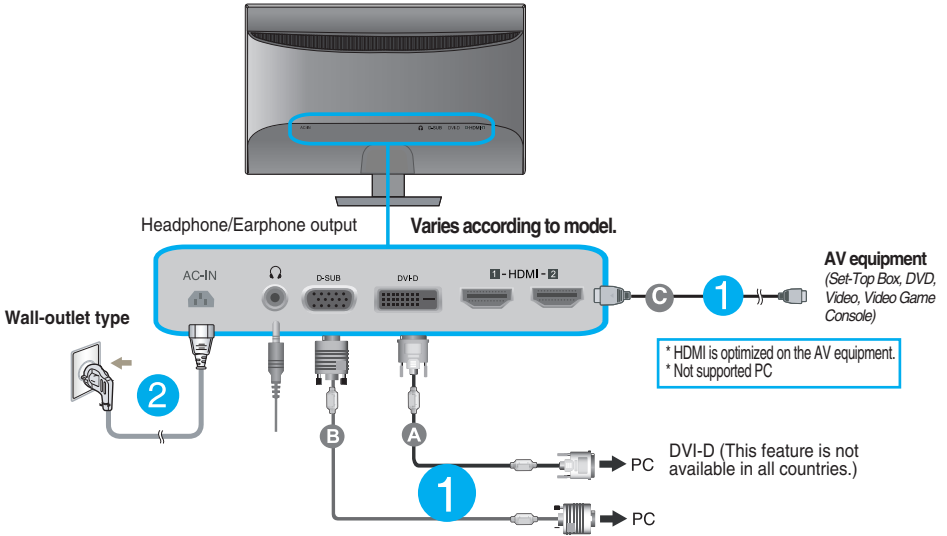

Connect the signal input cable and tighten it up by turning in the direction of the arrow as shown in the figure.

When using a D-Sub signal input cable connector for Macintosh

MAC

Mac adapter : For Apple Macintosh use, a separate plug adapter is needed to change the 15 pin high density (3 row) D-sub VGA connector on the supplied cable to a 15 pin 2 row connector.

Connecting the Display

3. Press the power button on the bottom right of the monitor to turn the power on. When monitor power is turned on, the **'Self Image Setting Function'** is executed automatically. (Only Analog Mode)

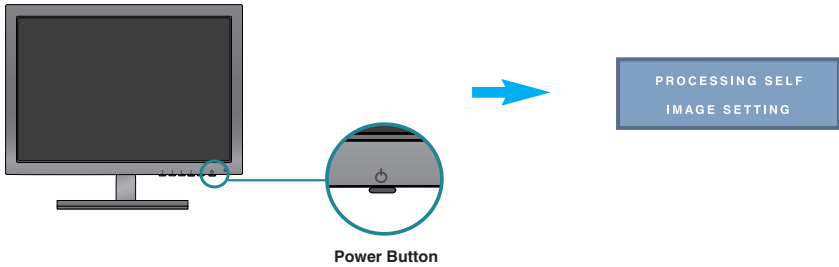



NOTE

'Self Image Setting Function'? This function provides the user with optimal display settings. When the user connects the monitor for the first time, this function automatically adjusts the display to optimal settings for individual input signals.

'AUTO' Function? When you encounter problems such as blurry screen, blurred letters, screen flicker or tilted screen while using the device or after changing screen resolution, press the AUTO function button to improve resolution.

Remote Control Controls



 Button	Use this button to turn the display on or off.
Input Button	Use this button to select the input signal. (D-SUB/DVI-D/HDMI1/HDMI2)
User Mode Button	Use this button to select the User Mode.
Aspect Ratio Button	Use Aspect Ratio control.
Thru Mode Button	Use Frame-Buffer to prevent picture delay.
Super Res. Button	Use Super+ Resolution control.
PIP Button	Use this button to select the PIP function.
Swap Button	Use this button to switch between the main screen and the PIP screen.
Brightness Button	To adjust the brightness.
Volume Button	To adjust the volume. (Use for the HDMI input)
 Button	To select the mute. (Use for the HDMI input)

Replacing the Remote Control Battery



1. Take out the battery cap.
2. Replace the battery (CR 2032 3V) with the + side facing up.
3. Close the battery cap.

* Use a coin to open or close the battery cover.

Front Panel Controls

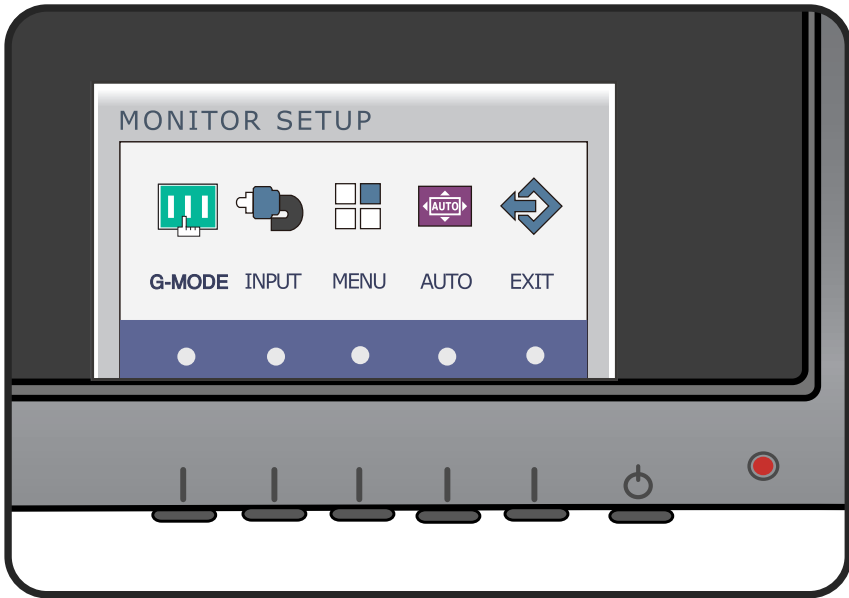

-
- 1 G-MODE Button** Use this button to enter **USER MODE, THRU MODE, SUPER+ RESOLUTION, ASPECT RATIO** or **AUTO BRIGHT** menus. For more information, refer to page 15 to 20.

-
- 2 INPUT Button (SOURCE Hot key)** When two input signals at least are connected, you can select the input signal (D-SUB/DVI-D/HDMI1/HDMI2) you want. When only one signal is connected, it is automatically detected. The default setting is D-Sub.



3 MENU Button

Use this button to enter or exit from the On Screen Display.



OSD LOCKED/UNLOCKED

This function allows you to lock the current control settings, so that they cannot be inadvertently changed. Press and hold the **MENU button** for several seconds. The message "**OSD LOCKED**" should appear.

You can unlock the OSD controls at any time by pushing the **MENU button** for several seconds. The message "**OSD UNLOCKED**" should appear.

4 AUTO Button

AUTO IMAGE ADJUSTMENT

When adjusting your display settings, always press the **AUTO** button before entering the On Screen Display(OSD). (Only Analog Mode)



This will automatically adjust your display image to the ideal settings for the current screen resolution size (display mode).

The best display mode is
1920 x 1080

VOLUME Button To adjust the headphone/ earphone volume.
(Only HDMI Mode)

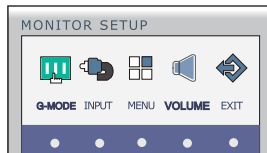

5 EXIT Button

Exit the OSD(On Screen Display).

6 Power Button & Power Indicator

Use this button to turn the display on or off.

The power indicator stays red if the display is running properly (On Mode). If the display is in Sleep Mode (Energy Saving), the power indicator is blinking red.

Screen Adjustment

Making adjustments to the image size, position and operating parameters of the display is quick and easy with the On Screen Display Control system.

A short example is given below to familiarize you with the use of the controls. The following section is an outline of the available adjustments and selections you can make using the OSD.

To make adjustments in the On Screen Display, follow these steps:

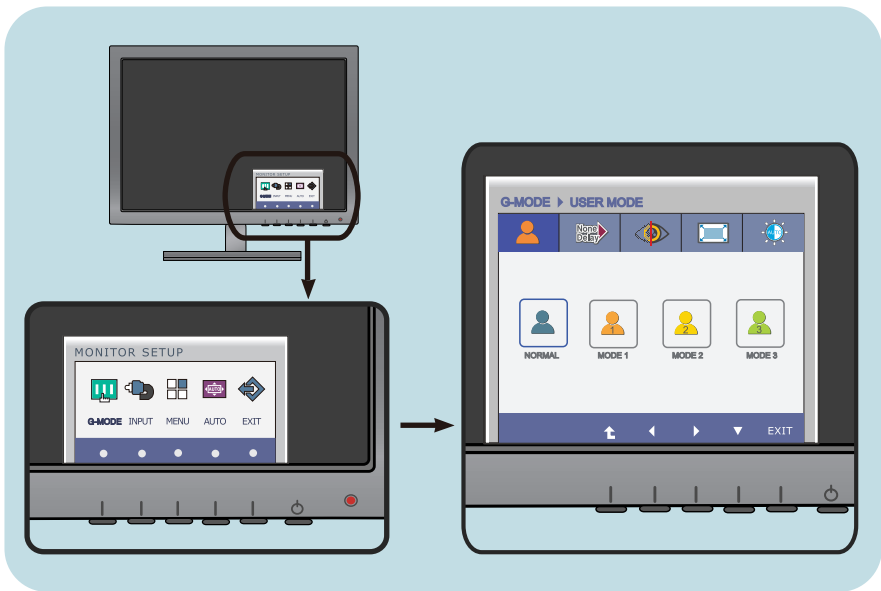

- 1 Press the discretionary button, then the main menu of the OSD appears. (except for the power button)
- 2 To access a control, use the corresponding buttons.
- 3 Use the ◀/▶ buttons to adjust the image to the desired level. Use the ▼ button to select other sub-menu items.
- 4 Press the **EXIT Button** to exit from the OSD.

On Screen Display(OSD) Selection and Adjustment

The following table indicates all the On Screen Display control, adjustment, and setting menus.

D-SUB : D-SUB(Analog signal) input

DVI-D : DVI-D(Digital signal) input

HDMI : HDMI signal

Main menu	Sub-menu	Supported input	Description
G-MODE	USER MODE	D-SUB	Use this menu to select the User Mode.
	THRU MODE	DVI-D HDMI	To prevent picture delay, frame buffer (video memory) is not used in this mode.
	SUPER+ RESOLUTION		With the picture improvement technology that minimizes the degradation of picture quality due to enlargement (e.g. blurred focus and unsharp edge), resolution is not compromised even when images are enlarged, thus guaranteeing a clear image.
	ASPECT RATIO		Use this menu to adjust the aspect ratio of a picture displayed on the screen.
	AUTO BRIGHT		Use this menu to adjust the screen brightness automatically.
INPUT	D-SUB	D-SUB	Use this button to select the input signal. (D-SUB/DVI-D/HDMI1/HDMI2)
	DVI-D	DVI-D	
	HDMI 1	HDMI	
	HDMI 2	HDMI	
PICTURE	BRIGHTNESS	D-SUB DVI-D HDMI	Use this menu to adjust the screen brightness, contrast, sharpness and offset level.
	CONTRAST		
	SHARPNESS		
	BLACK LEVEL	HDMI	
COLOR	COLOR TEMP	D-SUB DVI-D HDMI	To customize the color of the screen
	(PRESET)		
	sRGB	(USER)	
	5000K	RED	
	6500K	GREEN	
	7200K	BLUE	
8200K			
9300K			
	GAMMA		
	HUE	HDMI	
	SATURATION		
	COLOR RESET	D-SUB DVI-D HDMI	

On Screen Display(OSD) Selection and Adjustment

DISPLAY	HORIZONTAL VERTICAL	D-SUB	To adjust the position of the screen
	CLOCK PHASE	D-SUB	To improve the clarity and stability of the screen
	OVERSCAN	HDMI	Use this menu to allow the picture to completely fill the screen, removing noise around the edges of HDMI input video signal.
OTHERS	LANGUAGE	D-SUB DVI-D HDMI	Use this menu to set the user preferences and the picture options.
	WHITE BALANCE	D-SUB	
	POWER INDICATOR	D-SUB	
	FACTORY RESET	DVI-D HDMI	
PIP	PIP ON / OFF PIP INPUT PIP POSITION PIP SWAP	D-SUB DVI-D HDMI	To adjust PIP function
	PIP SOUND PIP VOLUME	HDMI	

NOTE

- The order of icons may differ depending on the model (13 to 28).

On Screen Display(OSD) Selection and Adjustment

You were introduced to the procedure of selecting and adjusting an item using the OSD system. Listed below are the icons, icon names, and icon descriptions of the all items shown on the Menu.

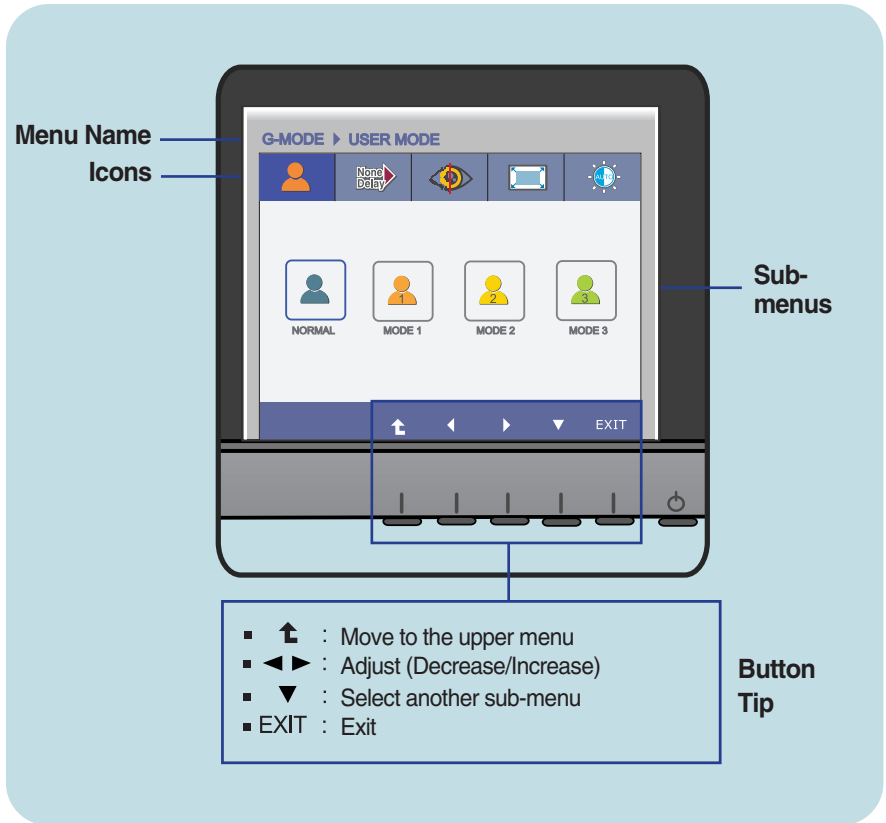
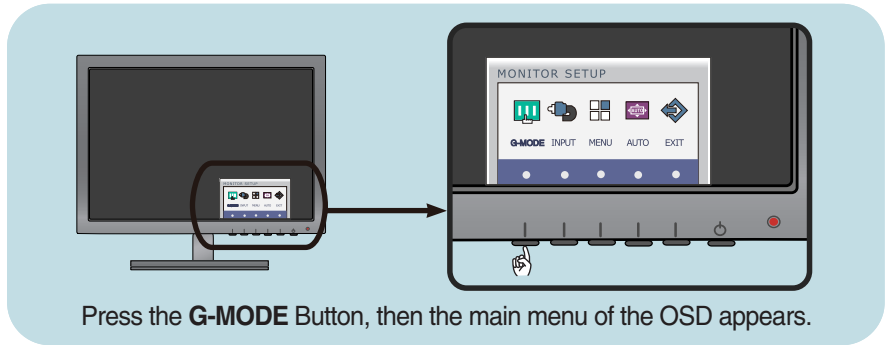

NOTE

- OSD (On Screen Display) menu languages on the monitor may differ from the manual.

On Screen Display(OSD) Selection and Adjustment

This menu allows you to easily customize the settings to your preferences, such as Brightness, SUPER+ RESOLUTION, and screen Aspect Ratio. Once set, you can select the optimized mode depending on your preferences.

Main menu	Sub menu	Description
-----------	----------	-------------



USER MODE

NORMAL

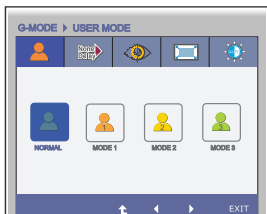

The following is the default setting.
 ASPECT RATIO (Full),
 SUPER+ RESOLUTION (NORMAL),
 BRIGHTNESS (100)

MODE 1/MODE 2/MODE 3

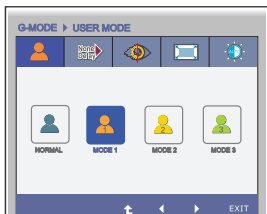

If you select MODE1 in USER MODE and set ASPECT RATIO, SUPER+ RESOLUTION, and BRIGHTNESS for your preferences, the settings are saved in MODE1. You can save your preferences in MODE2 and MODE3 in the same way.

- : Move to the upper menu
- : Move
- **EXIT** : Exit





* The table shows the settings available for three menus in each user mode.

USER MODE	ASPECT RATIO	SUPER+ RESOLUTION	BRIGHTNESS	Remark
NORMAL	FULL	NORMAL	100	Brightness, SUPER+ RESOLUTION, and screen aspect ratio can be customized for user preferences.
MODE 1	FULL/ORIGINAL/1:1	NORMAL/LOW/MEDIUM/HIGH	0 ~ 100	
MODE 2	FULL/ORIGINAL/1:1	NORMAL/LOW/MEDIUM/HIGH	0 ~ 100	
MODE 3	FULL/ORIGINAL/1:1	NORMAL/LOW/MEDIUM/HIGH	0 ~ 100	

If you set the ASPECT RATIO, SUPER+ RESOLUTION, BRIGHTNESS menus for your preferences, such as UCC video viewing, gaming and Internet surfing, you can change the settings for the three menus at once by simply changing the mode.

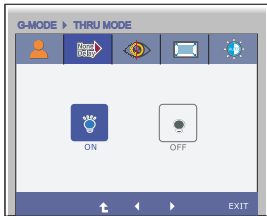

- * The settings in MODE1, MODE2 and MODE3 are not changed even after factory reset unless you change them.
- * You can save the customized settings in the General mode.
 However, the settings are changed to the factory default after factory reset.

On Screen Display(OSD) Selection and Adjustment

Main menu	Sub menu	Description
	THRU MODE	
	ON	Not use the Frame-Buffer memory to prevent the picture delay. It can use in GAME MODE to prevent picture delay. The screen blinks when you set THRU MODE to ON or OFF.
	OFF	Frame buffer (video memory) is used.
<ul style="list-style-type: none">▪  : Move to the upper menu▪  : Move▪ EXIT : Exit		

* Frame buffer must be used for PIP, screen aspect ratio, and HDMI video signal input. (THRU MODE OFF)
This function cannot be used with THRU MODE ON.

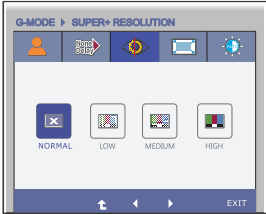
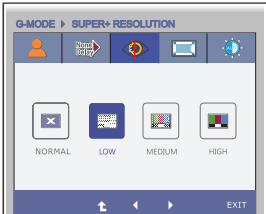
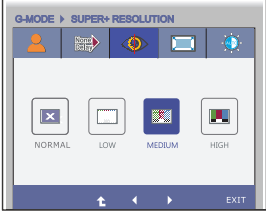
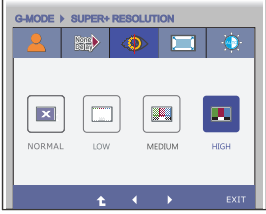

On Screen Display(OSD) Selection and Adjustment

Main menu	Sub menu	Description
	SUPER+ RESOLUTION	
	NORMAL	Select this when you want to use the product in the most general using environment. In the General mode, the SUPER+ RESOLUTION is turned off.
	LOW	When the user wants a natural video screen with soft image, it helps to get the optimized screen. It is effective for video with small movement or still image.
	MEDIUM	When the user wants a comfortable video screen at the medium level between low and high mode, it helps to get the optimized screen. It is effective for UCC and SD level videos.
	HIGH	When the user wants a sharp video screen with clear images, it helps to get the optimized screen. It is effective for high resolution video screens and games.
<ul style="list-style-type: none"> ■  : Move to the upper menu ■  : Move ■ EXIT : Exit 		



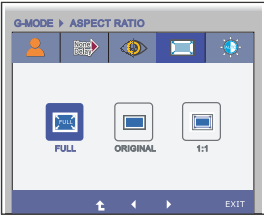
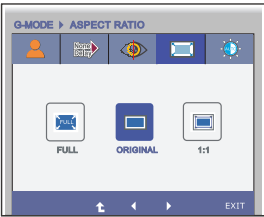
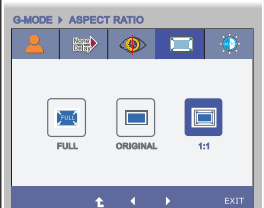

* Noise may exist according to SR(SUPER+ RESOLUTION) Mode, so enjoy the clear image by selecting SR(SUPER+ RESOLUTION) Mode according to the Contents.

On Screen Display(OSD) Selection and Adjustment

Main menu	Sub menu	Description
	ASPECT RATIO	
	FULL	The picture will be displayed with Full size.
	ORIGINAL	The picture will be displayed with input resolution ratio scaling. If 640 x 480 resolution input, the picture will keep at 4:3 ratio scaling.
	1:1	The picture will be displayed depends on Input resolution.No Scaling. If 640 x 480 resolution input, the picture will just display 640 x 480 size even though the 1920 x 1080 size panel.

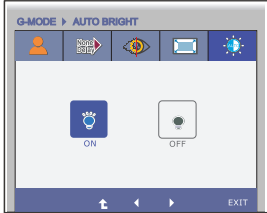
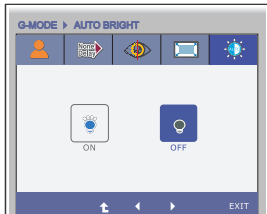
-  : Move to the upper menu
-   : Move
- **EXIT** : Exit





On Screen Display(OSD) Selection and Adjustment

Main menu	Sub menu	Description
	AUTO BRIGHT	
	ON	Select this to adjust the brightness automatically. If it is set to ON, the screen brightness is automatically adjusted using the light sensor. Depending on the ambient brightness or input data, the screen brightness is adjusted by adjusting the backlight to provide the optimal playback experience.
	OFF	Auto brightness adjustment function is turned OFF .
<ul style="list-style-type: none">■  : Move to the upper menu■  ,  : Move■ EXIT : Exit		

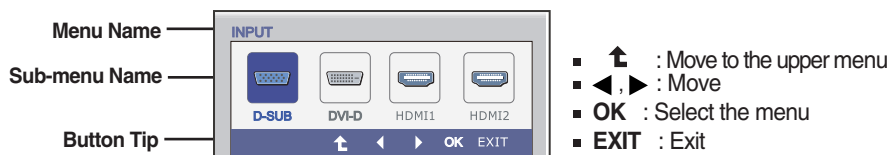
On Screen Display(OSD) Selection and Adjustment

- ■ ■ The OSD screen will appear when you press the **INPUT** button on the front of the monitor.



Main menu	Sub menu	Description
	D-SUB	This inputs video signals in analog format. Connect a 15-pin D-Sub cable and select D-SUB.
	DVI-D	This inputs video signals in digital format. Connect a DVI-D cable and select DVI-D.
	HDMI 1	This inputs video and audio signals in digital format. Connect a HDMI cable and select HDMI.
	HDMI 2	



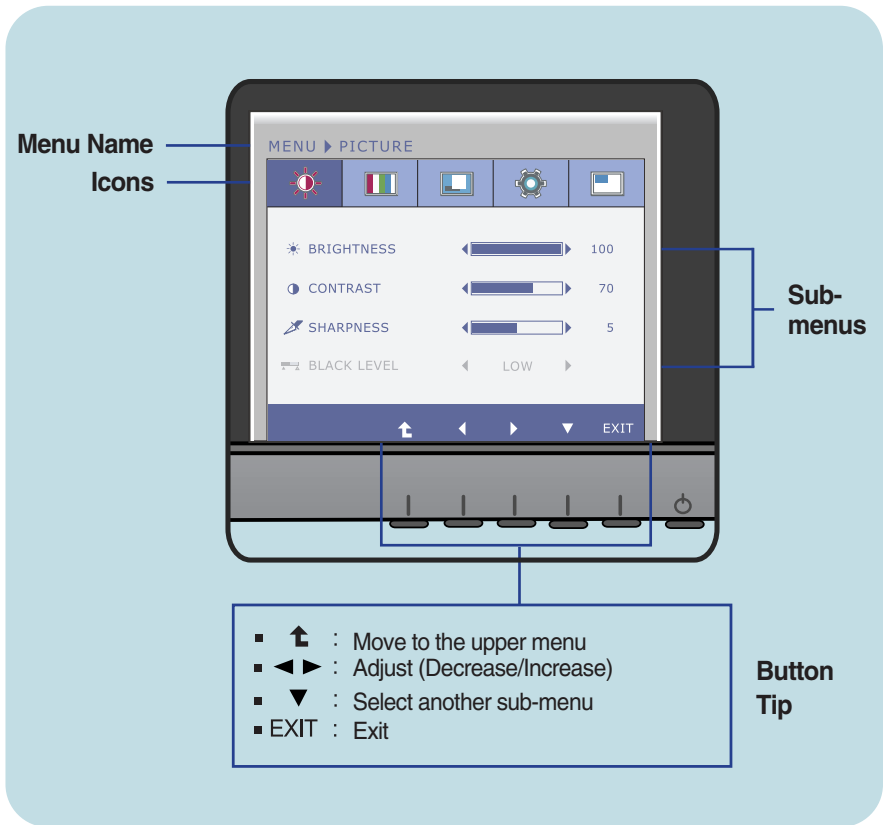
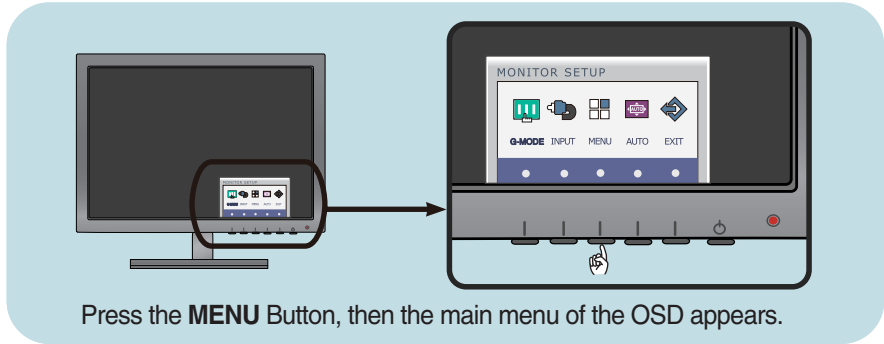

On Screen Display(OSD) Selection and Adjustment

You were introduced to the procedure of selecting and adjusting an item using the OSD system. Listed below are the icons, icon names, and icon descriptions of the all items shown on the Menu.

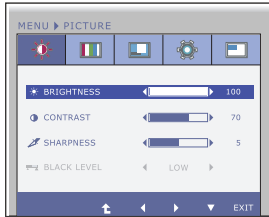
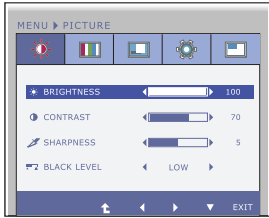

NOTE

- OSD (On Screen Display) menu languages on the monitor may differ from the manual.

Main menu	Sub menu	Description
 PICTURE		
D-SUB/DVI-D input		
	BRIGHTNESS	To adjust the brightness of the screen.
	CONTRAST	To adjust the contrast of the screen.
	SHARPNESS	To adjust the clearness of the screen.
	BLACK LEVEL	You can set the offset level. If you select 'HIGH' , the screen will be bright and if you select 'LOW' , the screen will be dark. (This option is enabled only for HDMI signal input in YUV color format.)
HDMI input		
		
		* Offset? As the criteria for video signal, it is the darkest screen the monitor can show.
<ul style="list-style-type: none">■  : Move to the upper menu■  : Decrease■  : Increase■  : Select another sub-menu■ EXIT : Exit		

On Screen Display(OSD) Selection and Adjustment

Main menu	Sub menu	Description
-----------	----------	-------------

COLOR

PRESET Mode

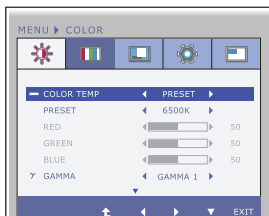

COLOR TEMP Select either **PRESET** or **USER** to adjust the screen color.

PRESET

Select the screen color.

- sRGB: Set the screen color to fit the sRGB standard color specification.
- You can select different color temperatures: 5000K, 6500K, 7200K, 8200K and 9300K.

USER Mode

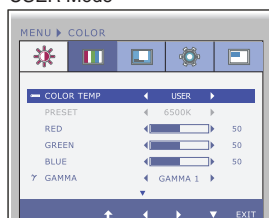

USER

- RED** The higher the color temperature gets, the bluer the screen becomes; the lower the color temperature gets, the bluer the screen becomes.
- GREEN**
- BLUE**

D-SUB/DVI-D input

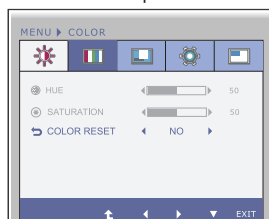

GAMMA

Set your own gamma value. : 0 / 1 / 2
On the monitor, high gamma values display whitish images and low gamma values display blackish images.

HUE

Set your own hue levels.
(only for HDMI input)

HDMI input

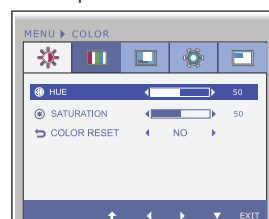

SATURATION





Set your own saturation levels.
(only for HDMI input)

* This option is enabled only for HDMI signal input in YUV color format.

COLOR RESET

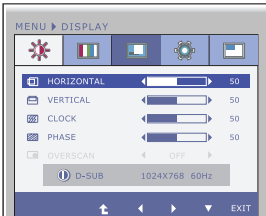
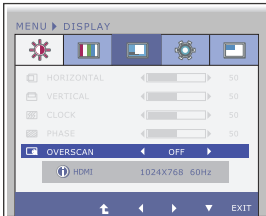
Use this menu to reset the color to factory settings.

- : Move to the upper menu
- : Decrease
- : Increase
- : Select another sub-menu
- **EXIT** : Exit

Main menu	Sub menu	Description
 DISPLAY		
D-SUB input		
	HORIZONTAL	To move image left and right.
	VERTICAL	To move image up and down.
	CLOCK	To minimize any vertical bars or stripes visible on the screen background. The horizontal screen size will also change.
	PHASE	To adjust the focus of the display. This item allows you to remove any horizontal noise and clear or sharpen the image of characters.
	OVERSCAN	Removes noise that may occur at the edges of an image when HDMI is connected to an external device. When ON is selected, the image size is reduced to prevent noise. When OFF is selected, the original image size is maintained regardless of noise. (Only for HDMI input)
HDMI input		
		
<ul style="list-style-type: none"> ■  : Move to the upper menu ■  : Decrease ■  : Increase ■  : Select another sub-menu ■ EXIT : Exit 		

Main menu	Sub menu	Description
-----------	----------	-------------

 **OTHERS**

D-SUB input

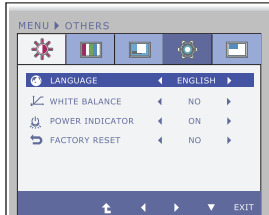

LANGUAGE

To choose the language in which the control names are displayed.

WHITE BALANCE

If the output of the video card is different the required specifications, the color level may deteriorate due to video signal distortion. Using this function, the signal level is adjusted to fit into the standard output level of the video card in order to provide the optimal image.

Activate this function when white and black colors are present in the screen.

HDMI/DVI-D input

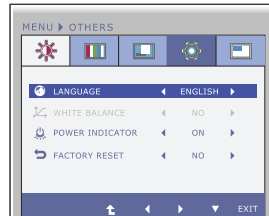





POWER INDICATOR

Use this menu to set the power indicator (on the bottom right of the monitor) to ON or OFF.



If you set **OFF**, it will go off.

If you set **ON** at any time, the power indicator will automatically be turned on.

-  : Move to the upper menu
-  : Decrease
-  : Increase
-  : Select another sub-menu
- **EXIT** : Exit

FACTORY RESET

Restore all factory default settings except "LANGUAGE."

Press the  ,  buttons to reset immediately.

NOTE

- If this does not improve the screen image, restore the factory default settings. If necessary, execute the WHITE BALANCE function again. This function will be enabled only when the input signal is an analog signal.

Main menu	Sub menu	Description
-----------	----------	-------------



PIP

D-SUB/DVI-D input



PIP ON/OFF

To select PIP on or off.

* It supports only for HDMI input in RGB (D-sub analog signal) mode.

* The combinations of main screen and sub-screen (PIP) available are as shown below:

Main screen \ Sub-screen (PIP)	D-SUB	DVI	HDMI 1	HDMI 2
D-SUB	-	○	○	○
DVI	○	-	○	○
HDMI 1	○	○	-	X
HDMI 2	○	○	X	-

HDMI input

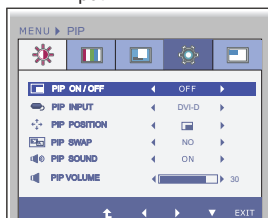





PIP INPUT

Select PIP input.

PIP POSITION

Select the PIP display location. Every time you touch the ▲ button, it will move from ① to ②, ③, ④. Every time you press the ▼ button, it will move from ① to ④, ③, ②. You can use this menu to select the PIP display location you want.

- ▲ : Move to the upper menu
- ◀ : Decrease
- ▶ : Increase
- ▼ : Select another sub-menu
- EXIT : Exit

- ①  : Top left
- ②  : Bottom left
- ③  : Bottom right
- ④  : Top right

*It operates only when PIP is on.

PIP SWAP

Use this menu to switch between the main menu and the sub menu.

PIP SOUND

Use this menu to turn the PIP Sound on or off. (Only for HDMI input)

PIP VOLUME

Use this menu to adjust the volume of the PIP Sound. (Only for HDMI input)

On Screen Display(OSD) Selection and Adjustment

- ■ ■ The OSD screen will appear when you press the **VOLUME** button on the front of the monitor.

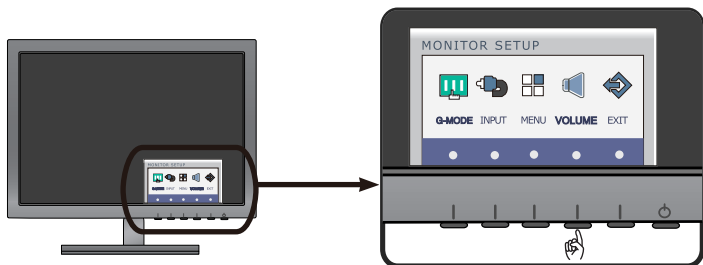

Menu Name — 음량

Sub-menu Name —

Button Tip —

- ↑ : Move to the upper menu
- ◀ : Decrease
- ▶ : Increase
- 🔇 : Mute
- EXIT : Exit

Main menu	Sub menu	Description
HDMI input	VOLUME	To adjust the volume of headphone/ Earphone. (Only for HDMI input)

Check the following before calling for service.

No image appears	
<ul style="list-style-type: none">● Is the power cord of the display connected?	<ul style="list-style-type: none">• Check and see if the power cord is connected properly to the power outlet.
<ul style="list-style-type: none">● Is the power indicator light on?	<ul style="list-style-type: none">• Press the Power button.
<ul style="list-style-type: none">● Is the power indicator blinking?	<ul style="list-style-type: none">• If the display is in power saving mode, try moving the mouse or pressing any key on the keyboard to bring up the screen.• Try to turn on the PC.
<ul style="list-style-type: none">● Do you see an "OUT OF RANGE" message on the screen?	<ul style="list-style-type: none">• This message appears when the signal from the PC (video card) is out of horizontal or vertical frequency range of the display. See the 'Specifications' section of this manual and configure your display again.
<ul style="list-style-type: none">● Do you see a "CHECK SIGNAL CABLE" message on the screen?	<ul style="list-style-type: none">• This message appears when the signal cable between your PC and your display is not connected. Check the signal cable and try again.

Do you see a "OSD LOCKED" message on the screen?	
<ul style="list-style-type: none">● Do you see "OSD LOCKED" when you push MENU button?	<ul style="list-style-type: none">• You can secure the current control settings, so that they cannot be inadvertently changed. You can unlock the OSD controls at any time by pushing the MENU button for several seconds: the message "OSD UNLOCKED" will appear.

Display image is incorrect

- | | |
|---|--|
| <ul style="list-style-type: none">● Display Position is incorrect. | <ul style="list-style-type: none">• Press the AUTO button to automatically adjust your display image to the ideal setting. |
| <ul style="list-style-type: none">● On the screen background, vertical bars or stripes are visible. | <ul style="list-style-type: none">• Press the AUTO button to automatically adjust your display image to the ideal setting. |
| <ul style="list-style-type: none">● Any horizontal noise appearing in any image or characters are not clearly portrayed. | <ul style="list-style-type: none">• Press the AUTO button to automatically adjust your display image to the ideal setting.• Check Control Panel --> Display --> Settings and adjust the display to the recommended resolution or adjust the display image to the ideal setting. Set the color setting higher than 24 bits (true color). |

IMPORTANT

- Check **Control Panel --> Display --> Settings** and see if the frequency or the resolution were changed. If yes, readjust the video card to the recommend resolution.
- If the recommended resolution (optimal resolution) is not selected, letters may be blurred and the screen may be dimmed, truncated or biased. Make sure to select the recommend resolution.
- The setting method can differ by computer and O/S (Operation System), and resolution mentioned above may not be supported by the video card performance. In this case, please ask to the computer or the video card manufacturer.

Display image is incorrect

● **The screen color is mono or abnormal.**

- Check if the signal cable is properly connected and use a screwdriver to fasten if necessary.
- Make sure the video card is properly inserted in the slot.
- Set the color setting higher than 24 bits (true color) at **Control Panel - Settings**.

● **The screen blinks.**

- Check if the screen is set to interlace mode and if yes, change it to the recommend resolution.

Do you see an "Unrecognized monitor, Plug&Play (VESA DDC) monitor found" message?

● **Have you installed the display driver?**

- Be sure to install the display driver from the display driver CD (or diskette) that comes with your display. Or, you can also download the driver from our web site: <http://www.lg.com>.
- Make sure to check if the video card supports Plug&Play function.

The Audio function is not working

● **Picture OK & No sound.**

- Check whether volume is "0".
- Check sound muted.
- HDMI cable installed properly.
- Head phone cable installed properly.
- Check sound format. Not supply to compressed sound format.

Display	58.42 cm (23 inch) Flat Panel Active matrix-TFT LCD Anti-Glare coating Visible diagonal size : 58.42 cm 0.265 mm x 0.265 mm (Pixel pitch)	
Sync Input	Horizontal Freq.	Analog,Digital: 30 kHz to 83 kHz HDMI : 30 kHz to 83 kHz
	Vertical Freq.	Analog,Digital : 56 Hz to 75 Hz HDMI : 56 Hz to 61 Hz
	Input Form	Separate Sync., Digital
Video Input	Signal Input	15 pin D-Sub Connector DVI-D connector (Digital) 19 pin HDMI Connector
	Input Form	Analog (0.7 Vp-p/ 75 ohm), Digital, HDMI
Resolution	Max	VESA 1920 x 1080 @ 60 Hz
	Recommend	VESA 1920 x 1080 @ 60 Hz
Plug&Play	DDC 2B (Analog, Digital, HDMI)	
Power Consumption	On Mode	: 39 W (Typ.)
	Sleep Mode	≤ 1 W
	Off Mode	≤ 0.5 W
Dimensions & Weight	With Stand Width 55.62 cm (21.90 inch) Height 41.27 cm (16.25 inch) Depth 17.78 cm (7 inch)	Without Stand Width 55.62 cm (21.90 inch) Height 34.51 cm (13.59 inch) Depth 6.04 cm (2.38 inch)
	Weight(excl. packing)	4.4 kg (9.70 lb)
Range	Tilt : -5° to 15°	
Power Input	AC 100-240 V~ 50 / 60 Hz 0.7 A	
Environmental Conditions	Operating Conditions Temperature 10 °C to 35 °C Humidity 10 % to 80 % non-Condensing	
	Storage Conditions Temperature -20 °C to 60 °C Humidity 5 % to 90 % non-Condensing	
Stand Base	Attached (<input type="checkbox"/>), Detached (<input type="radio"/>)	
Power cord	Wall-outlet type	

NOTE

- Information in this document is subject to change without notice.

Display	68.6 cm (27 inch) Flat Panel Active matrix-TFT LCD Anti-Glare coating Visible diagonal size : 68.6 cm 0.311 mm x 0.311 mm (Pixel pitch)	
Sync Input	Horizontal Freq.	Analog,Digital: 30 kHz to 83 kHz HDMI : 30 kHz to 83 kHz
	Vertical Freq.	Analog,Digital : 56 Hz to 75 Hz HDMI : 56 Hz to 61 Hz
	Input Form	Separate Sync., Digital
Video Input	Signal Input	15 pin D-Sub Connector DVI-D connector (Digital) 19 pin HDMI Connector
	Input Form	Analog (0.7 Vp-p/ 75 ohm), Digital, HDMI
Resolution	Max Recommend	VESA 1920 x 1080 @ 60 Hz VESA 1920 x 1080 @ 60 Hz
Plug&Play	DDC 2B (Analog, Digital, HDMI)	
Power Consumption	On Mode	: 41 W (Typ.)
	Sleep Mode	≤ 1 W
	Off Mode	≤ 0.5 W
Dimensions & Weight	With Stand Width 65.46 cm (25.77 inch) Height 48.85 cm (19.23 inch) Depth 23.08 cm (9.09 inch)	Without Stand Width 65.46 cm (25.77 inch) Height 40.45 cm (15.93 inch) Depth 6.04 cm (2.38 inch)
	Weight(excl. packing)	5.6 kg (12.35 lb)
Range	Tilt : -5° to 15°	
Power Input	AC 100-240 V~ 50 / 60 Hz 0.7 A	
Environmental Conditions	Operating Conditions Temperature 10 °C to 35 °C Humidity 10 % to 80 % non-Condensing	
	Storage Conditions Temperature -20 °C to 60 °C Humidity 5 % to 90 % non-Condensing	
Stand Base	Attached (<input type="checkbox"/>), Detached (<input type="radio"/>)	
Power cord	Wall-outlet type	

NOTE

- Information in this document is subject to change without notice.

Preset Modes (Resolution)

DSUB/DVI Timing

Display Modes (Resolution)		Horizontal Freq. (kHz)	Vertical Freq. (Hz)
1	640 x 350	31.469	70
2	720 x 400	31.468	70
3	640 x 480	31.469	60
4	640 x 480	37.500	75
5	800 x 600	37.879	60
6	800 x 600	46.875	75
7	1024 x 768	48.363	60
8	1024 x 768	60.123	75
9	1152 x 864	67.500	75
10	1280 x 1024	63.981	60
11	1280 x 1024	79.976	75
12	1680 x 1050	64.674	60
13	1680 x 1050	65.290	60
*14	1920 x 1080	67.500	60

*Recommend Mode

HDMI Timing

Display Modes (Resolution)		Horizontal Freq. (kHz)	Vertical Freq. (Hz)
1	480P	31.50	60
2	576P	31.25	50
3	720P	37.50	50
4	720P	45.00	60
5	1080i	28.12	50
6	1080i	33.75	60
7	1080P	56.25	50
8	1080P	67.50	60

Indicator

MODE	LED Color
On Mode	Red
Sleep Mode	Red Blinking
Off Mode	Off

Installing the Wall mount plate

This monitor satisfies the specifications of the Wall mount plate or the interchange device.

1. Place the monitor face down on the cushion or soft cloth.

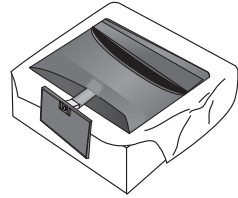

2. To remove the **Stand Base** from the **Stand Body**, turn the screw counterclockwise using a coin.

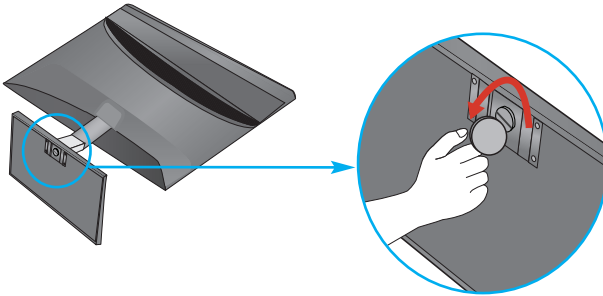

3. Check the direction of the **Stand Base** and pull it from the **Stand Body** in the direction shown in the figure below.

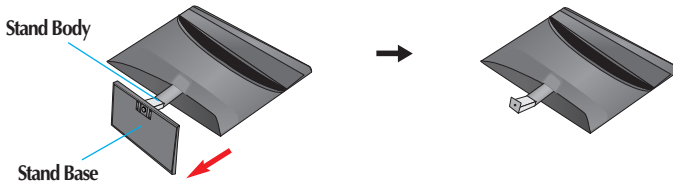

4. Loosen the screws on the back of the monitor to remove the **Stand Body** from the monitor.

(E2370V)

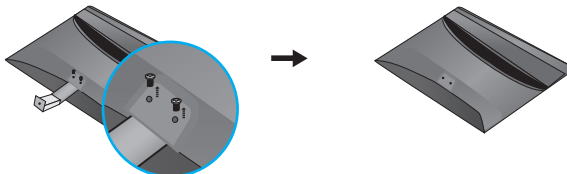

(E2770V)

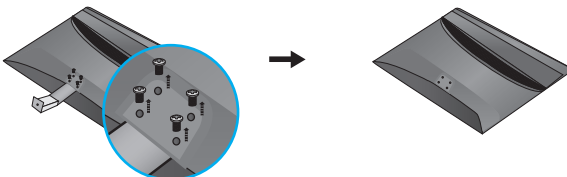

4. Install the Wall mount plate.

Wall mount plate(Separate purchase)

This is stand-type or wall mount type and is connectable with Wall mount plate.
Please refer to the installation guide for more details, which is provided when Wall mount plate is purchased.

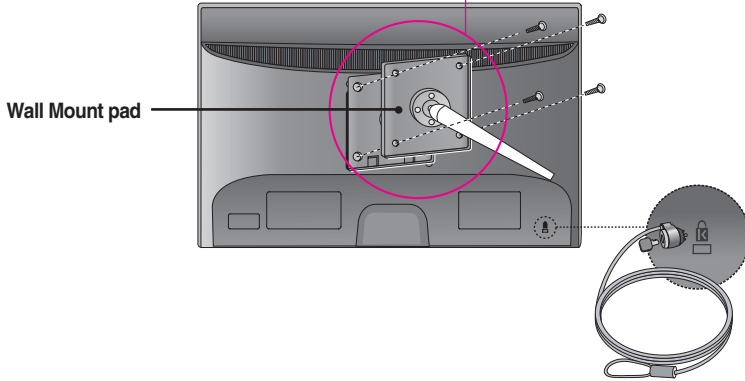

<Screw Mounting Interface Dimension>

Hole spacing : 100 mm x 100 mm. (E2370V)
200 mm x 100 mm. (E2770V)

Kensington Security Slot

Connected to a locking cable that can be purchased separately at most computer stores.



Make sure to read the Important Precautions before using the product.

Keep the Owner's Manual(CD) in an accessible place for future reference.

The model and serial number of the SET is located on the back and one side of the SET. Record it below should you ever need service.

MODEL _____

SERIAL _____

ENERGY STAR is a set of power-saving guidelines issued by the U.S. Environmental Protection Agency(EPA).



As an ENERGY STAR Partner LGE U. S. A.,Inc. has determined that this product meets the ENERGY STAR guidelines for energy efficiency.

■■■ Regulatory Information cont.

:: FCC Compliance Statement

This equipment has been tested and found to comply within the limits of a Class B digital device pursuant to Part 15 of the FCC Rules. These limits are designed to provide reasonable protection against harmful interference in a residential installation.

This equipment generates, uses, and can radiate radio frequency energy and if not installed and used in accordance with the instructions, may cause harmful interference to radio communications. However, there is no guarantee that interference will not occur in a particular installation.

If this equipment does cause harmful interference to radio or television reception (which can be determined by turning the equipment on and off), the user is encouraged to try to correct the interference by using one or more of the following measures:

- Reorient or relocate the receiving antenna.
- Increase the separation between the equipment and the receiver.
- Connect the equipment into an outlet on a circuit different from that to which the receiver is connected.
- Consult the dealer or an experienced radio/TV technician for help.

Caution: Changes or modifications not expressly approved by the party responsible for compliance could void the user's (or your) authority to operate the equipment. Only peripherals (digital input/output devices, terminals, printers, etc.) certified to comply with the Class B limits may be attached to this monitor. Operation with non-certified peripherals is likely to result in interference to radio and TV reception. Only shielded signal cables may be used with this System.

NOTICE

The regulations are applied only to the products with the ID LABEL indicating specific requirements.

:: Canadian DOC Notice

This Class B digital apparatus meets all requirements of the Canadian Interference-Causing Equipment Regulations. Cet appareil numérique de la classe B

respecte toutes les exigences du Règlement sur le matériel brouilleur du Canada.

NOTICE

The regulations are applied only to the products with the ID LABEL indicating specific requirements.

:: CE Conformity Notice (for Europe)

Products with the "CE" Marking comply with the EMC Directive(89/336/EEC) and LOW VOLTAGE Directive (73/23/EEC) issued by the Commission of the European Community.

Compliance with these directives implies conformity to the following European Norms :

- EN 55022 ; Radio Frequency Interference
- EN 55024 ; Electromagnetic Immunity
- EN 61000-3-2 ; Power Line Harmonics
- EN 61000-3-3 ; Voltage Fluctuations
- EN 60950-1 ; Product Safety

NOTICE

The regulations are applied only to the products with the ID LABEL indicating specific requirements.

:: Low Radiation Compliance (MPR II)

This monitor meets one of the strictest guidelines available today for low radiation emissions, offering the user extra shielding and an antistatic screen coating. These guidelines, set forth by a government agency in Sweden, limit the amount of emission allowed in the Extremely Low Frequency (ELF) and Very Low Frequency (VLF) electromagnetic range.

:: TCO'99 (TCO'99 applied model only)



Congratulations!

You have just purchased a TCO'99 approved and labelled product! Your choice has provided you with a product developed for professional use. Your purchase has also contributed to reducing the burden on the environment and also to the further development of environmentally adapted electronics products.

■■■ Regulatory Information cont.

Why do we have environmentally labelled computers?

In many countries, environmental labelling has become an established method for encouraging the adaptation of goods and services to the environment. With the growing manufacture and usage of electronic equipment throughout the world, there is a recognized concern for the materials and substances used by electronic products with regards to their eventual recycling and disposal. By proper selection of these materials and substances, the impact on the environment can be minimized.

There are also other characteristics of a computer, such as energy consumption levels, that are important from the viewpoints of both the work (internal) and natural (external) environments. Electronic equipment in offices is often left running continuously, resulting in unnecessary consumption of large amounts of energy and additional power generation. From the standpoint of carbon dioxide emissions alone, it is vital to save energy.

What does labelling involve?

The product meets the requirements for the TCO'99 scheme which provides for international and environmental labelling of personal computers and/or displays.

The labelling scheme was developed as a joint effort by the TCO (The Swedish Confederation of Professional Employees), Svenska Naturskyddsforeningen (The Swedish Society for Nature Conservation) and Statens Energimyndighet (The Swedish National Energy Administration).

Approval requirements cover a wide range of issues: ecology, ergonomics, emission of electrical and magnetical fields, energy consumption and electrical safety.

Ecological criteria impose restrictions on the presence and use of heavy metals, brominated and chlorinated flame retardants, and other substances. The product must be prepared for recycling and the manufacturing site(s) shall be certified according to ISO14001 or EMAS registered.

Energy requirements include a demand that the system unit and/or display, after a certain period of inactivity, shall reduce its power consumption to a lower level in one or more stages. The length of time to reactivate the system unit shall be reasonable for the user.

Labelled products must meet strict environmental demands, for example, in respect of the reduction of electrical and magnetical fields as well as work load and

visual ergonomics.

Below you will find a brief summary of the ecological requirements met by this product. The complete ecological criteria document can be found at TCO Development's website <http://www.tcodevelopment.com> or may be ordered from:

TCO Development

SE-114 94 STOCKHOLM, Sweden

Fax: +46 8 782 92 07

Email : development@tco.se

Information regarding TCO'99 approved and labelled products may also be obtained at <http://www.tcodevelopment.com>

Ecological requirements

Flame retardants

Flame retardants may be present in printed wiring board laminates, cables, and housings. Their purpose is to prevent, or at least to delay the spread of fire. Up to 30% by weight of the plastic in a computer casing can consist of flame retardant substances. Many flame retardants contain bromine or chlorine, and these flame retardants are chemically related to PCBs (polychlorinated biphenyls). Both the flame retardants containing bromine or chlorine and the PCBs are suspected of giving rise to health effects, including reproductive damage in fish-eating birds and mammals, due to the bio-accumulative* processes when not disposed of in accordance with strict standards for disposal.

TCO'99 requires that plastic components weighing more than 25 grams shall not contain flame retardants with organically bound bromine or chlorine. Flame retardants are allowed in the printed wiring board laminates due to the lack of commercially available alternatives.

Cadmium**

Cadmium is present in rechargeable batteries and in the colour-generating layers of certain computer displays. TCO'99 requires that batteries, the colour-generating layers of display screens, and the electrical or electronics components shall not contain any cadmium.

Mercury**

Mercury is sometimes found in batteries, relays and switches. TCO'99 requires that batteries shall not contain any mercury. It also demands that mercury is not present in any of the electrical or electronics components associated with the labelled unit. There is however one

■■■ Regulatory Information cont.

exception. Mercury is, for the time being, permitted in the back light system of flat panel monitors as there today is no commercially available alternative. TCO aims on removing this exception when a mercury free alternative is available.

Lead**

Lead can be found in picture tubes, display screens, solders and capacitors. TCO'99 permits the use of lead due to the lack of commercially available alternatives, but in future requirements TCO Development aims at restricting the use of lead.

* Bio-accumulative is defined as substances which accumulate in living organisms.

**Lead, Cadmium and Mercury are heavy metals which are bio-accumulative.

:: **TCO'03** (TCO'03 applied model only)



Congratulations!

The display you have just purchased carries the TCO'03 Displays label.

This means that your display is designed, manufactured and tested according to some of the strictest quality and environmental requirements in the world. This makes for a high performance product, designed with the user in focus that also minimizes the impact on our natural environment. Some of the features of the TCO'03 Display requirements:

Ergonomics

- Good visual ergonomics and image quality in order to improve the working environment for the user and to reduce sight and strain problems. Important parameters are luminance, contrast, resolution, reflectance, colour rendition and image stability.

Energy

- Energy-saving mode after a certain time – beneficial both for the user and the environment
- Electrical safety

Emissions

- Electromagnetic fields

- Noise emissions

Ecology

- The product must be prepared for recycling and the manufacturer must have a certified environmental management system such as EMAS or ISO 14 001
- Restrictions on
 - chlorinated and brominated flame retardants and polymers
 - heavy metals such as cadmium, mercury and lead.

The requirements included in this label have been developed by TCO Development in co-operation with scientists, experts, users as well as manufacturers all over the world. Since the end of the 1980s TCO has been involved in influencing the development of IT equipment in a more user-friendly direction. Our labelling system started with displays in 1992 and is now requested by users and IT-manufacturers all over the world.

For more information, please visit
www.tcodevelopment.com

English

Information for Environmental Preservation

LGE. announced the 'LG Declaration for a Cleaner Environment' in 1994, and this ideal has served as a guiding managerial principle ever since. The Declaration is a foundation that has allowed us to undertake environmentally friendly activities in careful consideration of economic, environmental, and social aspects.

We promote activities for environmental preservation, and we specifically develop our products to embrace the concept of environment-friendly.

We minimize the hazardous materials contained in our products. For example, there is no cadmium to be found in our monitors.

Information for recycling

This monitor may contain parts which could be hazardous to the environment. It is important that this monitor be recycled after use.

LGE. handles all waste monitors through an environmentally acceptable recycling method. There are several take-back and recycling systems currently in

■■■ Regulatory Information cont.

operation worldwide. Many parts will be reused and recycled, while harmful substances and heavy metals are treated by an environmentally friendly method.

If you want to find out more information about our recycling program, please contact your local LG vendor or a corporate representative of LG.

We set our vision and policies on a cleaner world by selecting the issue of the global environment as a task for corporate improvement. Please visit our website for more information about our 'green' policies.

<http://www.lge.com/about/environment/html/Recycling.jsp>

■ ■ ■ Deutsch

Informationen zur Erhaltung der Umwelt

Im Jahr 1994 verkündete LGE die 'LG Declaration for a Cleaner Environment' (LG Erklärung für eine sauberere Umwelt). Seitdem dient dieses Ideal als führendes Prinzip des Unternehmens. Diese Erklärung war die Basis für die Durchführung von

umweltfreundlichen Aktivitäten, wobei wirtschaftliche, umweltbezogene und soziale Aspekte in die Überlegungen mit einbezogen wurden.

Wir fördern Aktivitäten zum Schutz der Umwelt und die Entwicklung unserer Produkte ist darauf ausgerichtet, unserem Konzept bezüglich Umweltfreundlichkeit gerecht zu werden.

Wir sind darauf bedacht, den Anteil der in unseren Produkten enthaltenen schädlichen Materialien zu minimieren. So ist in unseren Monitoren beispielsweise kein Kadmium zu finden.

Informationen zum Thema Recycling

Dieser Monitor enthält Teile, die umweltschädlich sein können. Es ist unbedingt erforderlich, dass der Monitor recycelt wird, nachdem er außer Dienst gestellt wurde.

Bei LGE werden alle ausrangierten Monitore in einem unter umweltbezogenen Aspekten geeigneten Verfahren recycelt. Augenblicklich sind weltweit mehrere Rücknahme- und Recyclingsysteme im Einsatz. Viele Teile werden wieder verwendet und recycelt. Schädliche Substanzen und Schwermetalle werden durch umweltverträgliche Verfahren behandelt.

Falls Sie mehr über unser Recyclingprogramm erfahren möchten, wenden Sie sich bitte an Ihren lokalen LG-Händler oder einen Unternehmensvertreter von LG.

Wir richten unsere Firmenpolitik auf eine sauberere Umwelt hin aus, indem wir umweltspezifische Aspekte als wichtigen Punkt in die Weiterentwicklung unseres Unternehmens einfließen lassen. Zusätzliche Informationen über unsere 'grüne' Firmenpolitik erhalten Sie auf unserer Website.

<http://www.lge.com/about/environment/html/Recycling.jsp>

■ ■ ■ Français

Information sur la protection de l'environnement

LGE a publié sa 'Déclaration en faveur d'un environnement plus propre' en 1994 et celle-ci est restée, depuis lors, un principe directeur de notre entreprise. Cette déclaration a servi de base à notre réflexion et nous a permis de prendre en compte à la fois les aspects économiques et sociaux de nos activités, tout en respectant l'environnement.

Nous encourageons les activités en faveur de la préservation de l'environnement et c'est dans cet esprit que nous développons nos produits : nous réduisons au minimum les matières dangereuses qui entrent dans leur composition et l'on ne trouve pas de cadmium, par exemple, dans nos moniteurs.

Information sur le recyclage

Ce moniteur peut contenir des composants qui présentent un risque pour l'environnement. Il est donc important que celui-ci soit recyclé après usage.

LGE traite les moniteurs en fin de cycle conformément à une méthode de recyclage respectueuse de l'environnement. Nous reprenons nos produits et les recyclons dans plusieurs sites répartis dans le monde entier. De nombreux composants sont réutilisés et recyclés, et les matières dangereuses, ainsi que les métaux lourds, sont traités selon un procédé écologique.

Si vous souhaitez plus de renseignements sur notre programme de recyclage, veuillez contacter votre revendeur LG ou un l'un de nos représentants.

Nous voulons agir pour un monde plus propre et croyons au rôle de notre entreprise dans l'amélioration de l'environnement. Pour plus de renseignements sur notre politique "verte", rendez visite à notre site :

<http://www.lge.com/about/environment/html/Recycling.jsp>

Regulatory Information cont.

Italiano

Informazioni per la tutela dell'ambiente

La LGE. ha annunciato nel 1994 la cosiddetta 'LG Declaration for a Cleaner Environment' (Dichiarazione di LG a favore di un ambiente più pulito), un ideale che da allora funge da principio ispiratore della gestione aziendale. La dichiarazione rappresenta il fondamento che consente di intraprendere attività a favore dell'ambiente tenendo conto degli aspetti economici, ambientali e sociali. Noi della LG, promuoviamo attività a favore della tutela dell'ambiente sviluppando appositamente i nostri prodotti per cogliere il concetto del rispetto dell'ambiente riducendo i materiali dannosi presenti nei nostri prodotti. Ad esempio nei nostri monitor non è presente il cadmio.

Informazioni per il riciclaggio

Il monitor può presentare componenti che potrebbero risultare eventualmente dannosi per l'ambiente. È importante che il monitor sia riciclato al termine del suo utilizzo.

La LGE. gestisce tutti i monitor di rifiuto con un metodo di riciclaggio soddisfacente dal punto di vista ambientale. In tutto il mondo sono attualmente in funzione numerosi sistemi di riciclaggio e recupero. I diversi componenti sono riutilizzati e riciclati, mentre le sostanze dannose e i metalli pesanti vengono trattati con un metodo rispettoso dell'ambiente.

Se si desiderano maggiori informazioni in merito al programma di riciclaggio, è consigliabile rivolgersi al proprio rivenditore LG o ad un rappresentante aziendale della LG.

Noi della LG impostiamo la nostra visione e le nostre politiche a favore di un mondo più pulito ponendo la questione dell'ambiente dal punto di vista globale come una mansione rivolta al miglioramento della nostra azienda. Vi invitiamo a visitare il nostro sito internet per ulteriori informazioni sulla nostra politica "verde".
<http://www.lge.com/about/environment/html/Recycling.jsp>

Espanol

Información para la conservación medioambiental

LGE. presentó la 'Declaración para un entorno más limpio de LG' en 1994 y este ideal ha servido para guiar nuestros principios empresariales desde entonces. La Declaración es la base que nos ha permitido llevar a cabo tareas que

respetan el medio ambiente siempre teniendo en cuenta aspectos sociales, económicos y medioambientales.

Promocionamos actividades orientadas a la conservación del medio ambiente y desarrollamos nuestros productos específicamente para que se ajusten a la filosofía que protege el entorno.

Reducimos al máximo el uso de materiales de riesgo en nuestros productos. Un ejemplo de ello es la ausencia total de cadmio en nuestros monitores.

Información para el reciclaje

Este monitor puede contener piezas que entrañen riesgos medioambientales. Es importante reciclar este monitor después de su utilización.

LGE. trata todos los monitores usados siguiendo un método de reciclaje que no daña al entorno. Contamos con diversos sistemas de recuperación y reciclaje que funcionan a nivel mundial en la actualidad. Es posible reciclar y reutilizar muchas de las piezas, mientras que las sustancias dañinas y los metales pesados se tratan siguiendo un método que no perjudique al medio ambiente. Si desea obtener más información acerca del programa de reciclaje, póngase en contacto con su proveedor local de LG o con un representante empresarial de nuestra marca.

Basamos nuestra visión y nuestras políticas en un mundo más limpio y para ellos optamos por un entorno global como tarea principal de nuestra evolución como empresa. Visite nuestra página Web para obtener más información sobre nuestras políticas ecológicas.

<http://www.lge.com/about/environment/html/Recycling.jsp>

Português

Informações relacionadas à preservação ambiental

A LGE. anunciou a 'LG Declaration for a Cleaner Environment' (Declaração da LG para um ambiente mais limpo) em 1994 e esse ideal tem servido desde então como um princípio administrativo de orientação. A Declaração é a base que nos tem permitido realizar atividades favoráveis ao ambiente com consideração atenta aos aspectos econômicos, ambientais e sociais.

Promovemos atividades de preservação ambiental e desenvolvemos nossos produtos para englobar

■■■ Regulatory Information cont.

especificamente o conceito de favorável ao ambiente.

Reduzimos os materiais perigosos contidos em nossos produtos. Por exemplo, não há cádmio em nossos monitores.

Informações relacionadas à reciclagem

Este monitor pode conter peças que podem representar riscos ao ambiente. É importante que ele seja reciclado após o uso.

A LGE. cuida de todos os monitores descartados através de um método de reciclagem agradável ao ambiente. Há vários sistemas de devolução e reciclagem atualmente em operação no mundo. Muitas peças serão reutilizadas e recicladas e as substâncias nocivas e os metais pesados passarão por tratamento através de um método favorável ao ambiente.

Para obter mais informações sobre nosso programa de reciclagem, entre em contato com seu fornecedor LG local ou com um representante corporativo da LG.

Definimos nossa visão e nossas políticas relacionadas a um mundo mais limpo selecionando a questão do ambiente global como uma tarefa de aprimoramento corporativo. Visite nosso site para obter mais informações sobre nossas políticas de meio ambiente.

<http://www.lge.com/about/environment/html/Recycling.jsp>

■ ■ ■ Nederlands

Informatie met betrekking tot het behoud van het milieu

LGE. publiceerde in 1994 de 'LG Declaration for a Cleaner Environment' (de LG-verklaring met betrekking tot een schoner milieu). Deze verklaring en het ideaal van een schoner milieu fungeren sindsdien als een bestuurlijke leidraad voor onze onderneming. Op basis van deze verklaring ontplooiën wij milieuvriendelijke activiteiten, waarbij er zowel met sociale en economische aspecten, als met milieuaspecten zorgvuldig rekening wordt gehouden.

Wij ondersteunen activiteiten die zijn gericht op het behoud van het milieu en wij houden bij het ontwikkelen onze producten specifiek rekening met de milieuvriendelijkheid van onze producten.

Wij minimaliseren het gebruik van schadelijke stoffen in onze producten. Er wordt bijvoorbeeld geen cadmium verwerkt in onze monitoren.

Informatie met betrekking tot recycling

Deze monitor bevat materialen die schadelijk zouden kunnen zijn voor het milieu. Het is belangrijk dat deze monitor aan het einde van zijn levensduur wordt gerecycled.

LGE. verwerkt alle afvalmonitoren via een milieuvriendelijke recyclingmethode. Hiervoor worden er momenteel wereldwijd verscheidene inname- en recyclingsystemen gehanteerd. Een groot aantal onderdelen wordt opnieuw gebruikt en gerecycled, waarbij schadelijke stoffen en zware metalen volgens een milieuvriendelijke methode worden verwerkt.

Voor meer informatie over ons recyclingprogramma kunt u contact opnemen met uw plaatselijke LG-vertegenwoordiger of een LG-vestiging.

Onze visie en ons beleid met betrekking tot een schonere wereld vloeien voort uit het feit dat wij het milieu hebben aangemerkt als een onderwerp dat speciale aandacht verdient binnen onze onderneming. Bezoek onze website voor meer informatie over ons 'groene' beleid.

<http://www.lge.com/about/environment/html/Recycling.jsp>

■ ■ ■ Russian

Информация по охране окружающей среды

В 1994 году корпорация LGE опубликовала 'Декларацию LG по охране окружающей среды', которая с тех пор служит основным принципом управления. На основе этой декларации мы смогли предпринять действия, обеспечивающие безопасность окружающей среды, уделяя при этом должное внимание экономическим, экологическим и социальным аспектам.

Мы стимулируем деятельность по охране окружающей среды, уделяя особое внимание разработке нашей продукции в соответствии с концепцией экологической безопасности.

Мы сводим к минимуму содержание опасных веществ в нашей продукции. Например, в наших мониторах вы не найдете кадмия.

Информация по утилизации отходов

Этот монитор может содержать компоненты, которые могут нанести ущерб окружающей среде.

■■■ Regulatory Information cont.

Необходимо утилизировать монитор после использования.

Корпорация LGE перерабатывает все бракованные мониторы с помощью экологически приемлемого метода утилизации отходов. По всему миру действуют системы утилизации отходов и возврата использованной продукции. Многие компоненты будут вторично использованы и утилизированы, в то время как вредные вещества и тяжелые металлы будут обработаны с помощью экологически приемлемого метода.

За более подробной информацией по нашей программе утилизации отходов обращайтесь к местному поставщику или представителю корпорации LG.

Мы ориентируемся на обеспечение экологической безопасности, ставя себе целью глобальную защиту окружающей среды. Дополнительную информацию о нашей политике по охране окружающей среды вы можете найти на нашем сайте:
<http://www.lge.com/about/environment/html/Recycling.jsp>

한국어

환경 보존 정보

LG 전자는 1994년 'LG 환경 선언문'을 발표한 후 현재까지 이를 기업 경영의 이념으로 삼아왔습니다. 이 선언문을 바탕으로 LG 전자는 모든 경영 활동에서 경제성뿐만 아니라 환경성 및 사회성을 주요 의사 결정의 기준으로 삼음으로써 지속적으로 환경 친화적인 경영을 전개하고 있습니다.

본사는 보다 활발한 환경 보존 활동과 더불어 환경 친화적 제품 개발에 주력해 왔습니다.

또한 제품에 포함되는 환경 위해 요소를 최소화하는 데에도 노력을 기울이지 않고 있습니다. LG 전자 모니터의 경우 카드뮴을 전혀 사용하지 않는 것에서도 이러한 노력을 알 수 있습니다.

재활용 정보

본 모니터에는 환경에 위해를 주는 부품이 포함되어 있을 수도 있습니다. 따라서 사용이 끝난 모니터는 재활용하는 것이 좋습니다.

폐모니터는 모두 환경 친화적 방식으로 처리됩니다. 현재 세계적으로 운영되고 있는 회수 및 재활용 시스템에는

여러 가지가 있습니다. 대부분의 부품의 경우 재사용 또는 재활용되지만 환경 위해 물질과 중금속은 환경 친화적 방법으로 처리됩니다.

본사의 재활용 프로그램에 대한 자세한 정보는 각 지역의 LG 공급업체나 LG 기업 대표부에 문의하시기 바랍니다.

LG 전자는 기업 개선 정책의 하나로 지구 환경 문제를 채택함으로써 보다 나은 환경을 만들어 나가기 위한 비전과 정책을 수립했습니다. 본사의 친환경 정책에 대한 자세한 정보를 보시려면 아래의 웹 사이트를 방문하십시오.

http://www.lge.co.kr/cckr/about/environ/purity_02.jsp

∴EPA (EPA applied model only)

ENERGY STAR is a set of power-saving guidelines issued by the U.S. Environmental Protection Agency(EPA).



As an ENERGY STAR Partner LGE U. S. A.,Inc. has determined that this product meets the ENERGY STAR guidelines for energy efficiency.

∴NOM MARK (Mexico only)



Regulatory Information cont.

:: WEEE (for Europe)

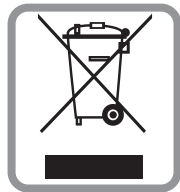

English

Disposal of your old appliance

1. When this crossed-out wheeled bin symbol is attached to a product it means the product is covered by the European Directive 2002/96/EC.
2. All electrical and electronic products should be disposed of separately from the municipal waste stream via designated collection facilities appointed by the government or the local authorities.
3. The correct disposal of your old appliance will help prevent potential negative consequences for the environment and human health.
4. For more detailed information about disposal of your old appliance, please contact your city office, waste disposal service or the shop where you purchased the product.

French

Élimination de votre ancien appareil

1. Ce symbole, représentant une poubelle sur roulettes barrée d'une croix, signifie que le produit est couvert par la directive européenne 2002/96/EC.
2. Les éléments électriques et électroniques doivent être jetés séparément, dans les vide-ordures prévus à cet effet par votre municipalité.
3. Une élimination conforme aux instructions aidera à réduire les conséquences négatives et risques éventuels pour l'environnement et la santé humaine.
4. Pour plus d'information concernant l'élimination de votre ancien appareil, veuillez contacter votre mairie, le service des ordures ménagères ou encore la magasin où vous avez acheté ce produit.

Italian

Smaltimento delle apparecchiature obsolete

1. Quando su un prodotto è riportato il simbolo di

un bidone della spazzatura barrato da una croce significa che il prodotto è coperto dalla direttiva europea 2002/96/EC.

2. Tutti i prodotti elettrici ed elettronici dovrebbero essere smaltiti separatamente rispetto alla raccolta differenziata municipale, mediante impianti di raccolta specifici designati dal governo o dalle autorità locali.
3. Il corretto smaltimento delle apparecchiature obsolete contribuisce a prevenire possibili conseguenze negative sulla salute umana e sull'ambiente.
4. Per informazioni più dettagliate sullo smaltimento delle apparecchiature obsolete, contattare il comune, il servizio di smaltimento rifiuti o il negozio in cui è stato acquistato il prodotto.

Swedish

Kassering av din gamla apparat

1. När den här symbolen med en överkryssad soptunna på hjul sitter på en produkt innebär det att den regleras av European Directive 2002/96/EC.
2. Alla elektriska och elektroniska produkter bör kasseras via andra vägar än de som finns för hushållsavfall, helst via för ändamålet avsedda uppsamlingsanläggningar som myndigheterna utser.
3. Om du kasserar din gamla apparat på rätt sätt så bidrar du till att förhindra negativa konsekvenser för miljön och människors hälsa.
4. Mer detaljerad information om kassering av din gamla apparat kan fås av kommunen, renhållningsverket eller den butik där du köpte produkten.

Dutch

Uw oude toestel wegdoen

1. Als het symbool met de doorgekruiste verrijdbare afvalbak op een product staat, betekent dit dat het product valt onder de Europese Richtlijn 2002/96/EC.
2. Elektrische en elektronische producten mogen niet worden meegegeven met het huishoudelijk afval, maar moeten worden ingeleverd bij speciale inzamelingspunten die door de lokale of landelijke overheid zijn aangewezen.
3. De correcte verwijdering van uw oude toestel helpt negatieve gevolgen voor het milieu en de menselijke gezondheid voorkomen.

Regulatory Information cont.

4. Wilt u meer informatie over de verwijdering van uw oude toestel? Neem dan contact op met uw gemeente, de afvalophaaldienst of de winkel waar u het product hebt gekocht.

Finnish

Vanhonjen laitteiden hävittäminen

1. Tämä merkki tuotteessa tarkoittaa, että tuote kuuluu sähkö- ja elektroniikkalaiteromusta annetun EU-direktiivin 2002/96/EY soveltamisalaan.
2. Kaikki elektroniset laitteet ovat ongelmajätettä, joten ne on toimitettava paikalliseen keräyspisteeseen.
3. Vanhan laitteen asianmukainen hävittäminen ehkäisee mahdollisia ympäristöön ja terveyteen kohdistuvia haittavaikutuksia.
4. Lisätietoa vanhan laitteen hävittämisestä saat ottamalla yhteyden paikallisiin viranomaisiin, kierrätyskeskukseen tai myymälään, josta ostit laitteen.

German

Entsorgung von Altgeräten

1. Wenn dieses Symbol eines durchgestrichenen Abfalleimers auf einem Produkt angebracht ist, unterliegt dieses Produkt der europäischen Richtlinie 2002/96/EC.
2. Alle Elektro- und Elektronik-Altgeräte müssen getrennt vom Hausmüll über dafür staatlich vorgesehenen Stellen entsorgt werden.
3. Mit der ordnungsgemäßen Entsorgung des alten Geräts vermeiden Sie Umweltschäden und eine Gefährdung der persönlichen Gesundheit.
4. Weitere Informationen zur Entsorgung des alten Geräts erhalten Sie bei der Stadtverwaltung, beim Entsorgungsamt oder in dem Geschäft, wo Sie das Produkt erworben haben.

Danish

Sådan smider du dit gamle apparat ud

1. Når der er et tegn med et kryds over en skraldespand, betyder det, at produktet er omfattet af EU-direktiv 2002/96/EC.
2. Alle elektriske og elektroniske produkter skal smides ud et andet sted end gennem den kommunale affaldsordning ved hjælp af specielle indsamlingsfaciliteter, der er organiseret af staten

eller de lokale myndigheder.

3. Korrekt bortskaffelse af dit gamle apparat er med til at forhindre mulige skadevirkninger på miljøet og menneskelig sundhed.
4. Mere detaljerede oplysninger om bortskaffelse af dit gamle apparat kan fås ved at kontakte dit lokale kommunekontor, renovationselskab eller den butik, hvor du købte produktet.

Greek

Απόρριψη της παλιάς σας συσκευής

1. Όταν ένα προϊόν διαθέτει το σύμβολο ενός διαγραμμένου κάλαθου απορριμμάτων, τότε το προϊόν καλύπτεται από την Ευρωπαϊκή Οδηγία 2002/96/ΕΟΚ.
2. Η απόρριψη όλων των ηλεκτρικών και ηλεκτρονικών προϊόντων πρέπει να γίνεται χωριστά από τα γενικά οικιακά απορρίμματα μέσω καθορισμένων εγκαταστάσεων συλλογής απορριμμάτων, οι οποίες έχουν δημιουργηθεί είτε από την κυβέρνηση ή από τις τοπικές αρχές.
3. Η σωστή απόρριψη της παλιάς σας συσκευής θα βοηθήσει στην αποτροπή πιθανών αρνητικών συνεπειών ως προς το περιβάλλον και την υγεία του ανθρώπου.
4. Για πιο λεπτομερείς πληροφορίες σχετικά με την απόρριψη της παλιάς σας συσκευής, επικοινωνήστε με το αρμόδιο τοπικό γραφείο, υπηρεσία διάθεσης οικιακών απορριμμάτων ή το μαγαζί από το οποίο αγοράσατε το προϊόν.

Spanish

Cómo deshacerse de aparatos eléctricos y electrónicos viejos

1. Si en un producto aparece el símbolo de un contenedor de basura tachado, significa que éste se acoge a la Directiva 2002/96/CE.
2. Todos los aparatos eléctricos o electrónicos se deben desechar de forma distinta del servicio municipal de recogida de basura, a través de puntos de recogida designados por el gobierno o las autoridades locales.
3. La correcta recogida y tratamiento de los dispositivos inservibles contribuye a evitar riesgos potenciales para el medio ambiente y la salud pública.
4. Para obtener más información sobre cómo deshacerse de sus aparatos eléctricos y electrónicos viejos, póngase en contacto con su ayuntamiento, el servicio de recogida de basuras o el establecimiento donde adquirió el producto.

Regulatory Information cont.

Portuguese

Eliminação do seu antigo aparelho

1. Quando este símbolo de latão cruzado estiver afixado a um produto, significa que o produto é abrangido pela Directiva Europeia 2002/96/EC.
2. Todos os produtos eléctricos e electrónicos devem ser eliminados separadamente do lixo doméstico através de pontos de recolha designados, facilitados pelo governo ou autoridades locais.
3. A eliminação correcta do seu aparelho antigo ajuda a evitar potenciais consequências negativas para o ambiente e para a saúde humana.
4. Para obter informações mais detalhadas acerca da eliminação do seu aparelho antigo, contacte as autoridades locais, um serviço de eliminação de resíduos ou a loja onde comprou o produto.

Slovak

Likvidácia váš ho starého prístroja

1. Keď sa na produkte nachádza tento symbol prečiarknutej smetnej nádoby s kolieskami, znamená to, že daný produkt vyhovuje európskej Smernici č. 2002/96/EC.
2. Všetky elektrické a elektronické produkty by mali byť zlikvidované oddelene od komunálneho odpadu prostredníctvom na to určených zberných zariadení, ktoré boli ustanovené vládou alebo orgánmi miestnej správy.
3. Správnu likvidáciu starých zariadení pomôžete predchádzať potenciálnym negatívnym následkom pre prostredie a ľudské zdravie.
4. Podrobnejšie informácie o likvidácii starých zariadení nájdete na miestnom úrade, v službe na likvidáciu odpadu alebo u predajcu, kde ste tento produkt zakúpili.

Czech

Likvidace starých spotřebičů

1. Pokud je u výrobku uveden symbol pojízdného kontejneru v přeškrtnutém poli, znamená to, že na výrobek se vztahuje směrnice Evropské unie číslo 2002/96/EC.
2. Všechny elektrické a elektronické výrobky by měly být likvidovány odděleně od běžného komunálního odpadu prostřednictvím sběrných zařízení zřízených za tímto účelem vládou nebo místní samosprávou.
3. Správný způsob likvidace starého elektrického spotřebiče pomáhá zamezit možným negativním dopadům na životní prostředí a zdraví.
4. Bližší informace o likvidaci starého spotřebiče získáte u místní samosprávy, ve sběrném zařízení nebo v obchodě, ve kterém jste výrobek zakoupili.

Croatian

Uklanjanje starog aparata

1. Ako se na proizvodu nalazi simbol prekrizhene kante za smeće, to znači da je proizvod pokriven europskom direk-

tivom 2002/96/EC.

2. Električni i elektronski proizvodi ne smiju se odlagati zajedno s komunalnim otpadom, već u posebna odlagališta koja je odredila vlada ili lokalne vlasti.
3. Pravilno odlaganje starog proizvoda sprečiti će potencijalne negativne posljedice po okoliš i zdravlje ljudi.
4. Podrobnije informacije o odlaganju starog proizvoda potražite u gradskom uredu, službi za odlaganje otpada ili u trgovini u kojoj ste kupili proizvod.

Hungarian

Régi eszközök ártalmatlanítása

1. A termékhez csatolt áthúzott, keresek szeméttároló jel jelöli, hogy a termék a 2002/96/EC EU-direktíva hatálya alá esik.
2. Minden elektromos és elektronikai terméket a lakossági hulladéktól elkülönítve kell begyűjteni, a kormány vagy az önkormányzatok által kijelölt begyűjtő eszközök használatával.
3. Régi eszközeinek megfelelő ártalmatlanítása segíthet megelőzni az esetleges egészségre vagy környezetre ártalmas hatásokat.
4. Ha több információra van szüksége régi eszközeinek ártalmatlanításával kapcsolatban, tanulmányozza a vonatkozó környezetvédelmi szabályokat, vagy lépjen kapcsolatba az üzlettel, ahol a terméket vásárolta.

Polish

Utylizacja starych urządzeń

1. Kiedy do produktu dołączony jest niniejszy przekreślony symbol kołowego pojemnika na śmieci, oznacza to, że produkt jest objęty dyrektywą 2002/96/EC.
2. Wszystkie elektryczne i elektroniczne produkty powinny być utylizowane niezależnie od odpadów miejskich, z wykorzystaniem przeznaczonych do tego miejsc składowania wskazanych przez rząd lub miejscowe władze.
3. Właściwy sposób utylizacji starego urządzenia pomoże zapobiec potencjalnie negatywnemu wpływowi na zdrowie i środowisko.
4. Aby uzyskać więcej informacji o sposobach utylizacji starych urządzeń, należy skontaktować się z władzami lokalnymi, przedsiębiorstwem zajmującym się utylizacją odpadów lub sklepem, w którym produkt został kupiony.

■ ■ ■ Regulatory Information cont.

■ ■ Estonian

Kasutuskõlbmatu seadme käitlemise kord

1. Kui seade on märgistatud selle elektri- ja elektroonikaseadmete lahuskogumist märgistava tähisega (ratastega prügikonteineri kujutis, millele on rist peale tõmmatud), tuleb toodet käidelda vastavalt Eurodirektiivile 2002/96/EÜ.
2. Elektri- ja elektroonikaseadmeid ei tohi visata tavalise prügi hulka. Nad kuuluvad lahuskogumisele selleks määratud kogumispunktides.
3. Kasutuskõlbmatu tervikseadme käitlemine tavaprügist lahus on korraldatud selleks, et vältida negatiivseid tagajärgi, mida põhjustaksid seadme osade purunemisel vabaneda võivad ohtlikud jäätmed loodusele või inimorganismile.
4. Täpsemat informatsiooni selle kohta, kuhu ja millal saab ära anda oma kasutamiskõlbmatu elektri- ja elektroonikaseadme, küsige kohalikult omavalitsuselt, prügifirmalt või kaupluselt, kust seadme ostsite.

■ ■ Latvian

Vecās elektroierīces nodošana

1. Ja uz produkta ir simbols ar pārsvītrotu atkritumu tvertni, tas nozīmē, ka produkts ir iekļauts Eiropas direktīvā 2002/96/EC.
2. Visi elektriskie un elektroniskie produkti ir jāutilizē, nododot pašvaldības īpaši noteiktās pieņemšanas vietās. Tos nedrīkst izmest parastās municipalitātes atkritumu urnās.
3. Ievērojot prasības veco elektroierīču utilizēšanā, jūs pasargāsiet apkārtējo vidi un cilvēku veselību no iespējami nelabvēlīgajām sekām, kādas varētu rasties, ierīcēm sadaloties nepiemērotā vietā.
4. Lai gūtu plašāku informāciju par veco ierīču utilizēšanas iespējām, sazinieties ar pilsētas pašvaldību, atkritumu savākšanas saimniecību vai veikalu, kurā ierīci iegādājāties.

■ ■ Lithuanian

Senos įrangos atliekų tvarkymas

1. Užbrauktas konteinerio simbolis priverčia ant prekės reiškia, kad įrangą saugo Europos direktyva 2002/96/EC.
2. Visos elektros ir elektroninės įrangos atliekos turi būti renkamos atskirai ir neišmetamos į atliekų konteinerį kartu su kitomis komunalinėmis atliekomis, taikant specialią atliekų surinkimo sistemą, patvirtintą vyriausybės ar vietos valdžios.
3. Teisingas senos įrangos atliekų tvarkymas, padės išvengti neigiamų pasekmių aplinkai ir žmonių sveikatai.
4. Dėl išsamesnės informacijos apie senos įrangos tvarkymą, prašome kreiptis į miesto valdžią, atliekų perdirbimo tarnybą arba parduotuvę, kurioje pirkote įrangą.