



**LG**

Life's Good

ENGLISH

# OWNER'S MANUAL

# LED LCD MONITOR

Please read this manual carefully before operating your set and retain it for future reference.

## LED LCD MONITOR MODEL

E2242V

E2342V

E2442V

E2742V

# CONTENTS

## 3 ASSEMBLING AND PREPARING

---

- 3 Unpacking
- 4 Parts and buttons
- 5 Setting up the Monitor set
- 5 - Attaching the Stand Base
- 6 - Detaching the Stand Base
- 7 - Mounting on a table
- 7 - Using the cable holder
- 9 - Mounting on a wall

## 10 USING THE MONITOR SET

---

- 10 Connecting to a PC
- 10 - D-SUB connection
- 10 - DVI-D connection
- 10 - HDMI connection

## 12 CUSTOMIZING SETTINGS

---

- 13 Customizing Settings
- 13 - Menu Settings
- 14 -PICTURE
- 15 -COLOR
- 16 -DISPLAY
- 16 -VOLUME
- 17 -OTHERS
- 18 SUPER ENERGY SAVING Setting
- 19 PICTURE MODE Setting

## 20 TROUBLESHOOTING

---

## 22 SPECIFICATIONS

---

- 22 E2242V
- 23 E2342V
- 24 E2442V
- 25 E2742V
- 26 Preset Modes (Resolution)
- 26 Indicator

## 27 PROPER POSTURE

---

- 27 Proper posture for using the Monitor set.

# ASSEMBLING AND PREPARING

## Unpacking

Check your product box for the following items. If there are any missing accessories, contact the local dealer where you purchased your product. The illustrations in this manual may differ from the actual product and accessories.

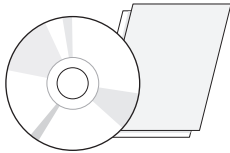

**CD(Owner's Manual) /  
Card**

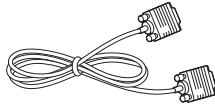

**D-SUB Cable**

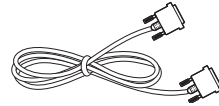

**DVI-D Cable**  
(This cable is not included  
in all countries.)

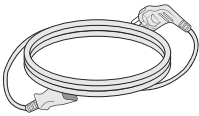

**Power Cord**

( Depending on the country )

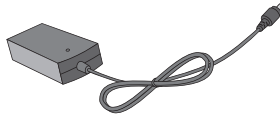

**AC-DC Adapter**

or



**AC-DC Adapter**

( Depending on the country )

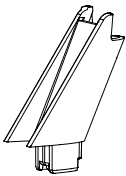

**Stand Body**

(E2242V/E2342V/E2442V)

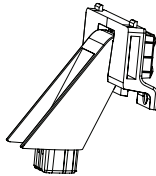

**Stand Body**

( E2742V )



**Two Screws**

( E2742V )



**Stand Base**



### CAUTION

- Do not use any unapproved accessories to ensure the safety and product life span.
- Any damages or injuries by using unapproved accessories are not covered by the warranty.



### NOTE

- The accessories supplied with your product may vary depending on the model.
- Product specifications or contents in this manual may be changed without prior notice due to upgrade of product functions.

# Parts and buttons

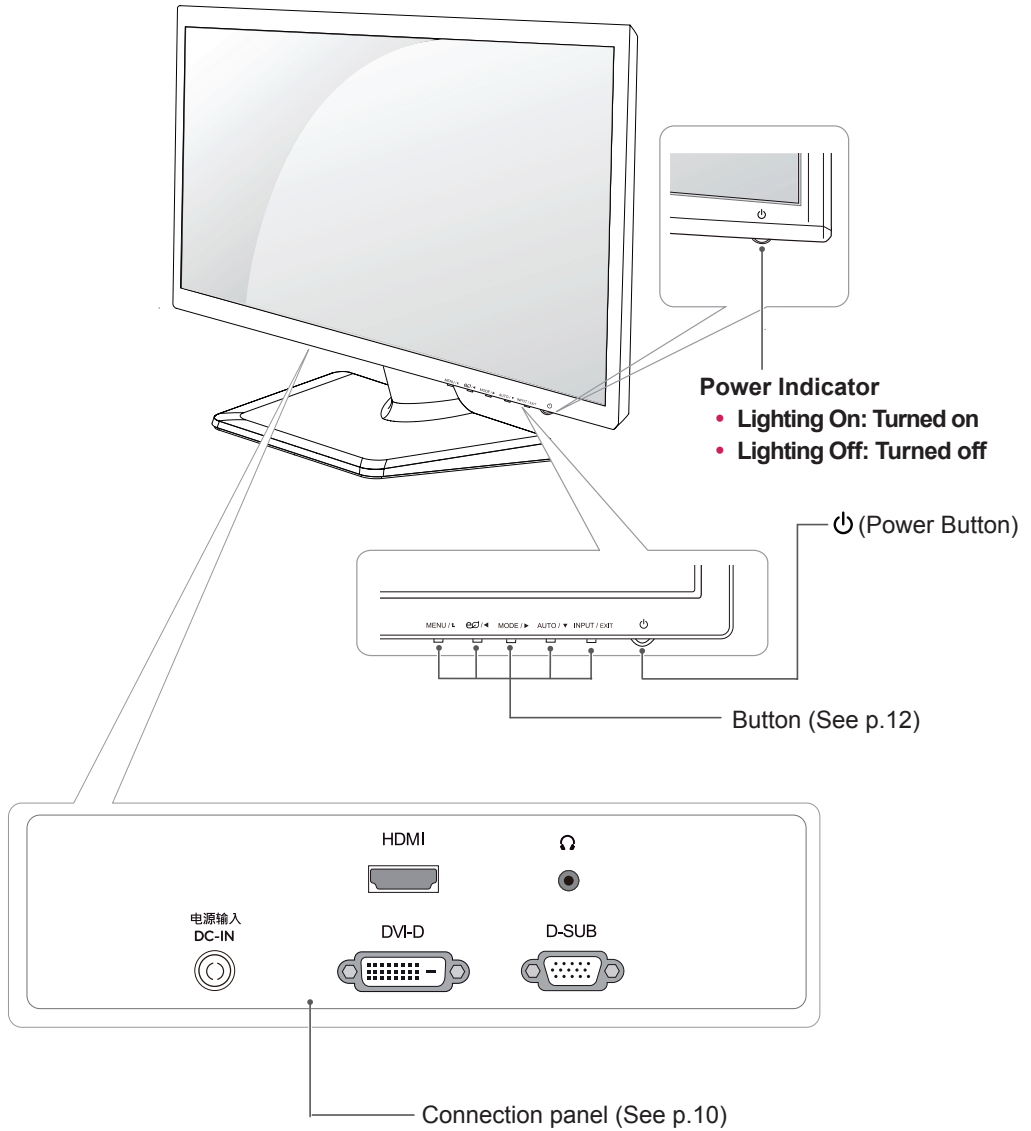

## Setting up the Monitor set

### Attaching the Stand Base

- 1 Place the Monitor set with the screen side down on a flat and cushioned surface.



#### CAUTION

Lay a foam mat or soft protective cloth on the surface to protect the screen from damage.

### 2 E2242V/E2342V/E2442V

- 1 Attach the **Stand Body** to the monitor set.
- 2 Attach the **Stand Base**.
- 3 Tighten the screw to the right with a coin.

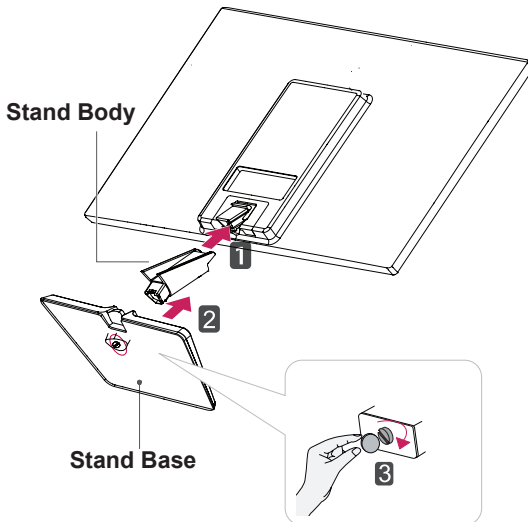

### E2742V

- 1 Attach the **Stand Body** to the monitor set.
- 2 Use two screws to fix the **Stand Body** and monitor set.
- 3 Attach the **Stand Base**.
- 4 Tighten the screw to the right with a coin.

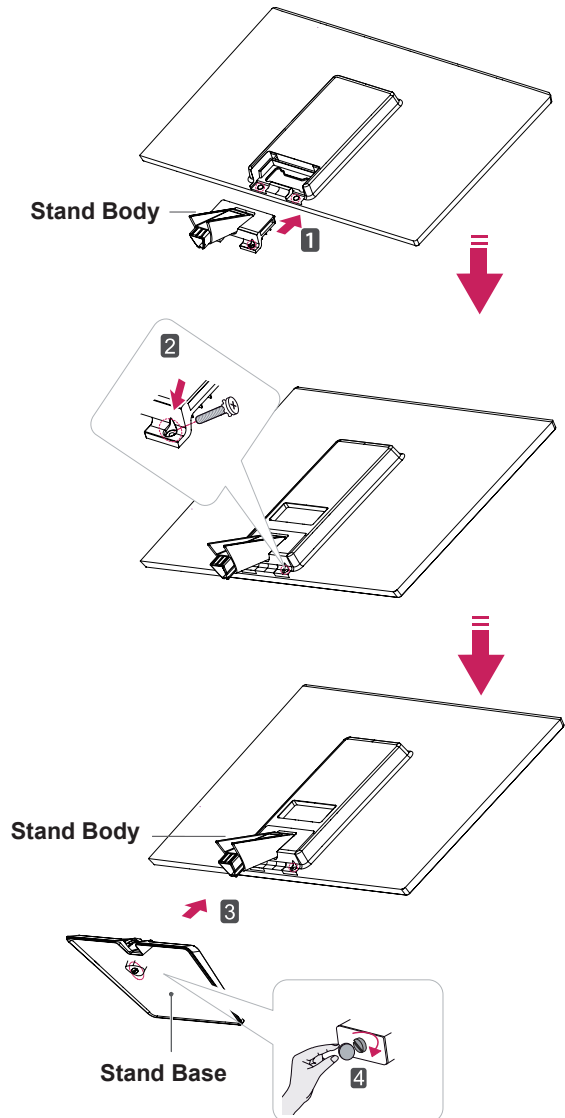

## Detaching the Stand Base

- 1 Place the Monitor set with the screen side down on a flat and cushioned surface.

### 2 E2242V/E2342V/E2442V

- 1 Pull out the **Stand Body** and **Stand Base** from the monitor set.
- 2 Turn the screw to the left with a coin.
- 3 Pull out the **Stand Base**.

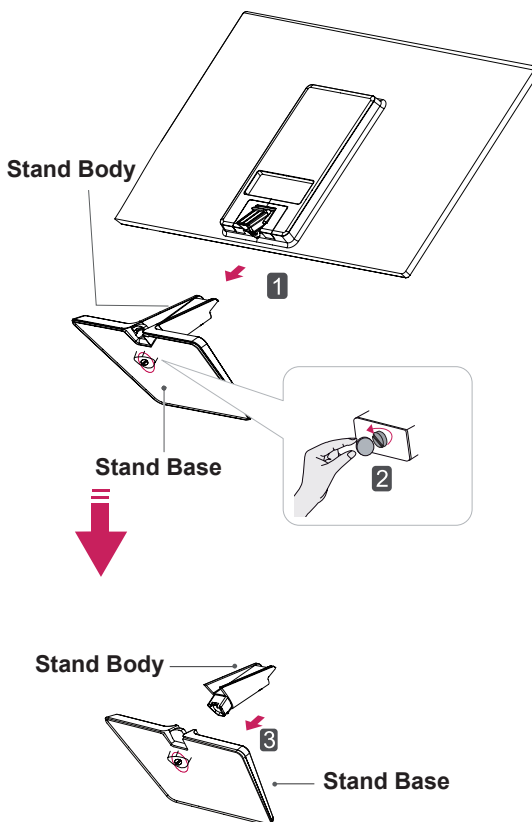

### E2742V

- 1 Turn the screw to the left with a coin.
- 2 Pull out the **Stand Base** from the **Stand Body**.
- 3 Remove two screws and pull out the **Stand Body** from the monitor set.

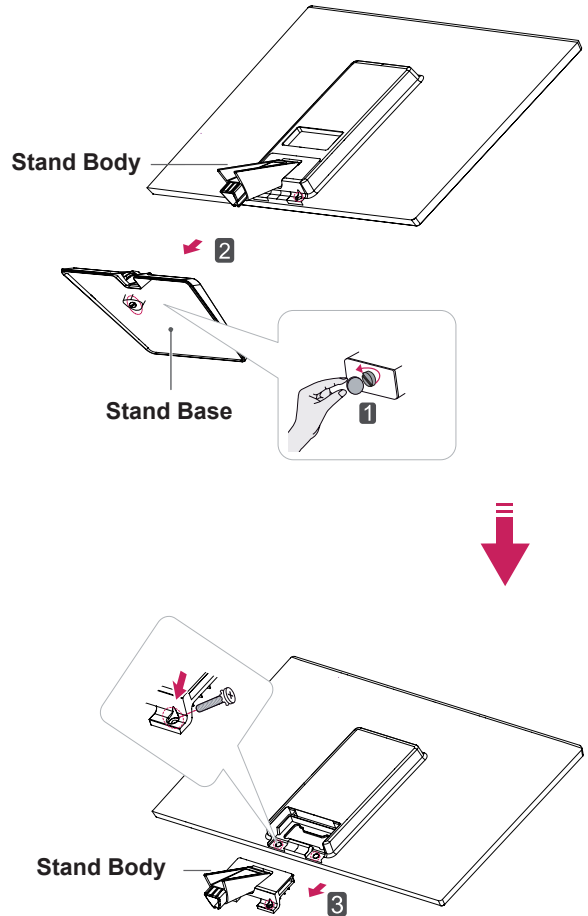

### CAUTION

- This illustration depicts the general model of connection. Your monitor may differ from the items shown in the picture.
- Do not carry the product upside down holding only the stand base. The product may fall and get damaged or injure your foot.

## Mounting on a table

- 1 Lift and tilt the Monitor set into its upright position on a table.

Leave a 10 cm (minimum) space from the wall for proper ventilation.

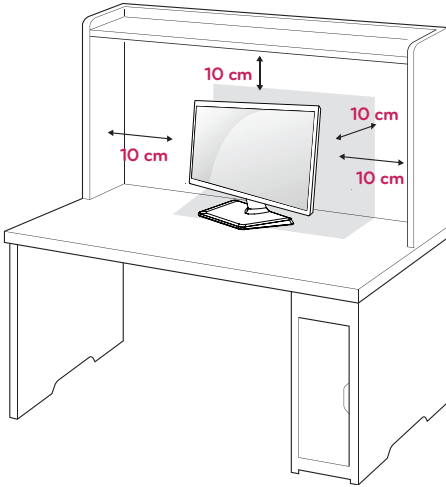

- 2 Connect the AC-DC Adapter and Power Cord to a wall outlet.

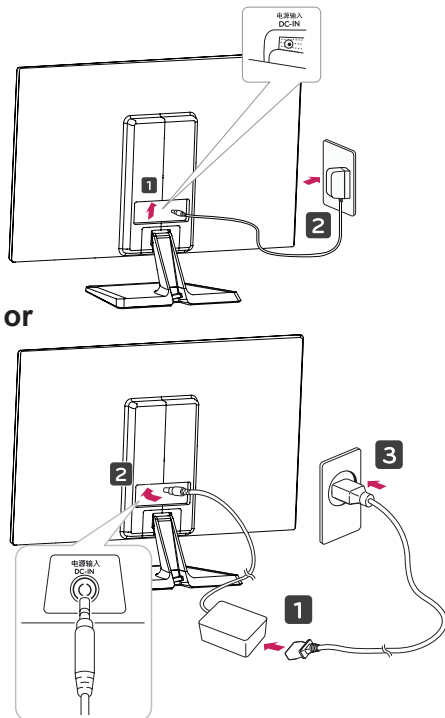

- 3 Press ⏻ (Power) button on the bottom switch panel to turn the power on.



### CAUTION

Unplug the power cord before moving the Monitor to another location. Otherwise electric shock may occur.

## Using the cable holder

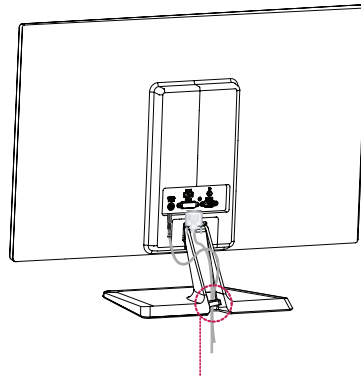

Cable holder

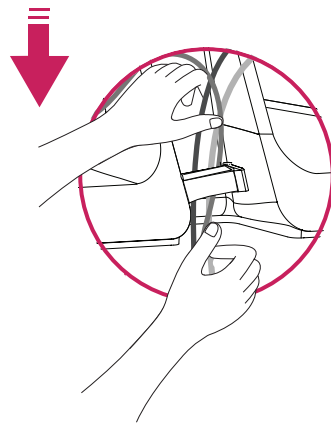

**! WARNING**

When you adjust the angle, do not hold the bottom of the Monitor set frame as shown on the following illustration, as may injure your fingers.

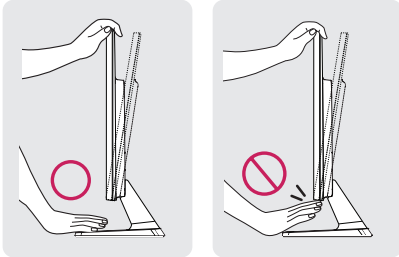

Do not touch or press the screen when adjusting the angle of the monitor.

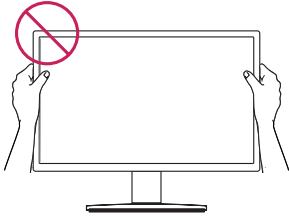

Do not hold this set like below picture. Monitor screen can detach from stand base and injure your body.

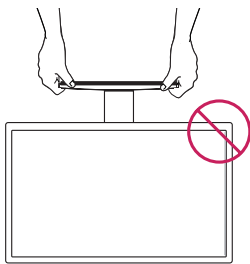

**! NOTE**

Tilt from +20 to -5 degrees up or down to adjust the angle of the Monitor set to suit your view.

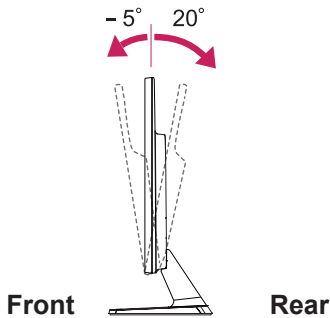

**Using the Kensington security system**

The Kensington security system connector is located at the back of the Monitor set. For more information of installation and using, refer to the manual supplied with the Kensington security system or visit <http://www.kensington.com>.

Connect the Kensington security system cable between the Monitor set and a table.

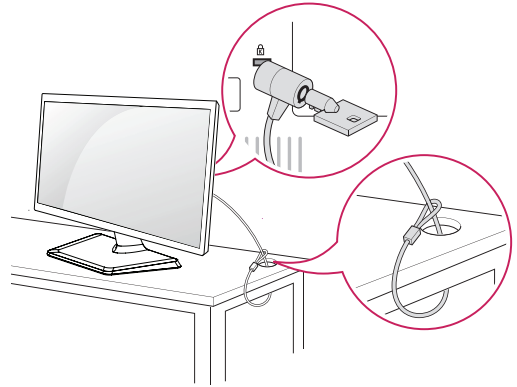

**! NOTE**

The Kensington security system is optional. You can obtain it from most electronics stores.



## Mounting on a wall

For proper ventilation, allow a clearance of 10 cm on each side and from the wall. Detailed instructions are available from your dealer, see the optional Tilt Wall Mounting Bracket Installation and Setup Guide.

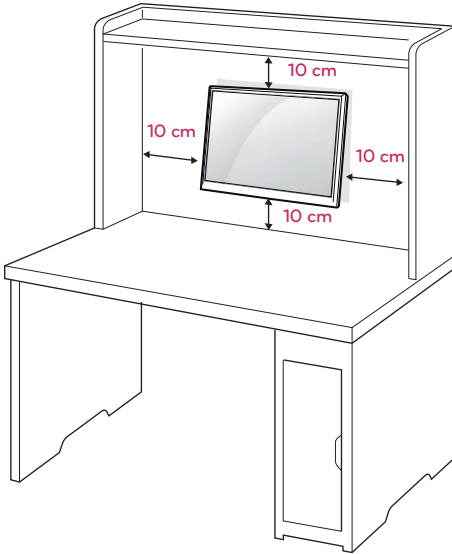

If you intend to mount the Monitor set to a wall, attach Wall mounting interface (optional parts) to the back of the set.

When you install the Monitor set using a wall mounting interface (optional parts), attach it carefully so it will not drop.

- 1 Please, Use the screw and wall mount interface in accordance with VESA Standards.
- 2 If you use screw longer than standard, the monitor might be damaged internally.
- 3 If you use improper screw, the product might be damaged and drop from mounted position. In this case, LG Electronics is not responsible for it.
- 4 VESA compatible.
- 5 Please use VESA standard as below.
  - 784.8 mm (30.9 inch) and under
    - \* Wall Mount Pad Thickness : 2.6 mm
    - \* Screw :  $\Phi$  4.0 mm x Pitch 0.7 mm x Length 10 mm
  - 787.4 mm (31.0 inch) and above
    - \* Please use VESA standard wall mount pad and screws.

Model	E2242V E2342V	E2442V E2742V
VESA (A x B)	75 x 75	100 x 100
Standard screw	M4	
Number of screws	4	



### CAUTION

- Disconnect the power cord first, and then move or install the Monitor set. Otherwise electric shock may occur.
- If you install the Monitor set on a ceiling or slanted wall, it may fall and result in severe injury.
- Use only an authorized LG wall mount and contact the local dealer or qualified personnel.
- Do not over tighten the screws as this may cause damage to the Monitor set and void your warranty.
- Use only screws and wall mounts that meet the VESA standard. Any damages or injuries by misuse or using an improper accessory are not covered by the warranty.



### NOTE

- Use the screws that are listed on the VESA standard screw specifications.
- The wall mount kit will include an installation manual and necessary parts.
- The wall mount bracket is optional. You can obtain additional accessories from your local dealer.
- The length of screws may differ depending on the wall mount. Be sure to use the proper length.
- For more information, refer to the instructions supplied with the wall mount.

# USING THE MONITOR SET

## Connecting to a PC

- Your Monitor set supports Plug & Play\*.
- \*Plug & Play: A PC recognizes a connected device that users connect to a PC and turn on, without device configuration or user intervention.

### D-SUB connection

Transmits analog video from your PC to the Monitor set. Connect the PC and the Monitor set with the supplied D-sub 15 pin signal cable as shown in the following illustrations.

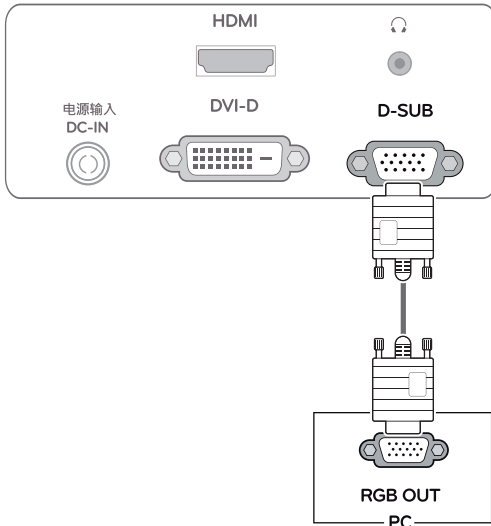

#### NOTE

- When using a D-Sub signal input cable connector for Macintosh

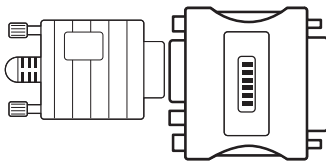

#### Mac adapter

For Apple Macintosh use, a separate plug adapter is needed to change the 15 pin high density (3 row) D-SUB VGA connector on the supplied cable to a 15 pin 2 row connector.

### DVI-D connection

Transmits a digital video signal from your PC to the Monitor set. Connect the PC and the Monitor set with a DVI cable as shown in the following illustrations.

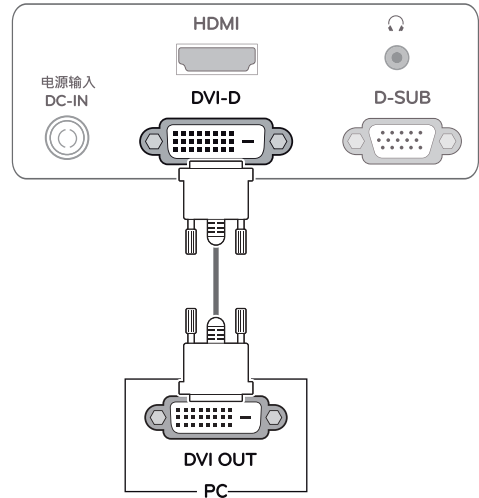

### HDMI connection

Transmits the digital video and audio signals from your PC or A/V to the Monitor set. Connect the PC or A/V and the Monitor set with the HDMI cable as shown in the following illustrations.

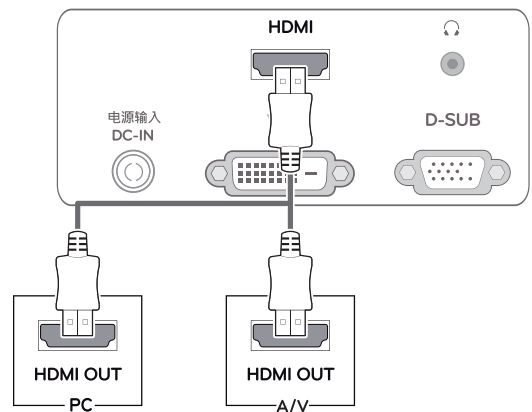

#### NOTE

- If you use HDMI PC, it can cause compatibility problem.

### ⚠ CAUTION

- Connect the signal input cable and tighten it by turning the screws clockwise.
- Do not press the screen with your finger for a long time as this may result in temporary distortion on the screen.
- Avoid displaying a fixed image on the screen for a long period of time to prevent image burn. Use a screensaver if possible.

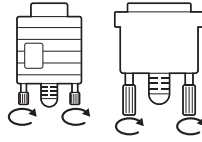

### Self Image Setting Function

Press the power button on the bottom panel to turn the power on. When monitor power is turned on, the **"Self Image Setting"** Function is executed automatically. (Only supported in Analog Mode)

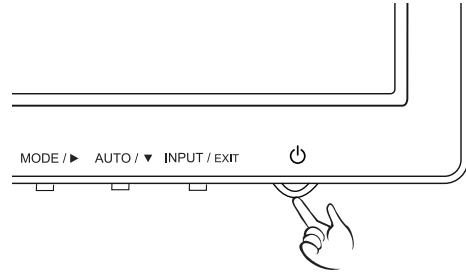

### ! NOTE

- When you want to use two PC in our Monitor, please connect the signal cable(D-SUB/ DVI-D/HDMI) respectively in Monitor set.
- If you turn the Monitor set on while it is cold, the screen may flicker. This is normal.
- Some red, green, or blue spots may appear on the screen. This is normal.

### ! NOTE

- **"Self Image Setting" Function.**  
This function provides the user with optimal display settings. When the user connects the monitor for the first time, this function automatically adjusts the display to optimal settings for individual input signals. (Only supported in Analog Mode)
- **'AUTO' Function.**  
When you encounter problems such as blurry screen, blurred letters, screen flicker or tilted screen while using the device or after changing screen resolution, press the AUTO function button to improve resolution. (Only supported in Analog Mode)

# CUSTOMIZING SETTINGS

- 1 Press the desired button on the bottom of the Monitor set.
- 2 Change the value of the menu item by pressing the buttons on the bottom of the Monitor set.  
To return to the upper menu or set other menu items, use the up arrow (⬆) button.
- 3 Select **EXIT** to leave the OSD menu.

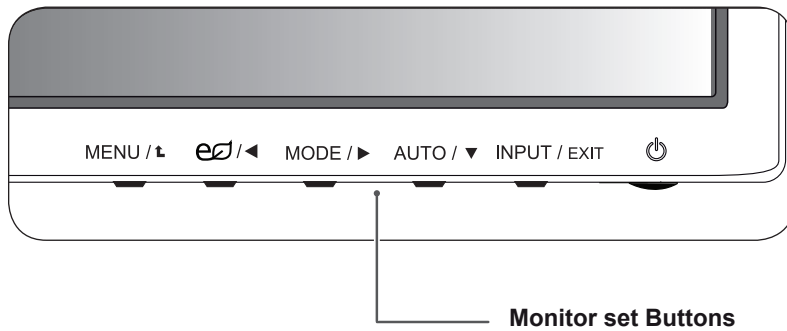

Button	Description
MENU / ⬆	<p>Accesses the main menus.(See p.13)</p> <p><b>OSD LOCKED/ UNLOCKED</b></p> <p>This function allows you to lock the current control settings, so that they cannot be inadvertently changed. Press and hold the MENU button for several seconds. The message "OSD LOCKED" should appear. You can unlock the OSD controls at any time by pushing the MENU button for several seconds. The message "OSD UNLOCKED" should appear.</p>
e/s / ⬆ (SUPER ENERGY SAVING)	Use this button to enter SUPER ENERGY SAVING menu.For more information.(See p.18)
MODE / ⬆	Use this button to enter CUSTOM, TEXT, PHOTO, CINEMA, GAME menus.(See p.19)
AUTO / ⬆	<p>When adjusting your display settings, always press the AUTO button on the MONITOR SETUP OSD. (Only supported in Analog Mode)</p> <p><b>The best display mode</b> 1920 x 1080</p>
INPUT / EXIT	<p>You can choose the input signal.</p> <ul style="list-style-type: none"> <li>• When two input signals are connected, you can select the input signal (D-SUB/DVI/ HDMI) you want.</li> <li>• When only one signal is connected, it is automatically detected. The default setting is D-SUB.</li> </ul> <p><b>EXIT</b></p> <p>Exit the OSD(On Screen Display).</p>
⏻ (Power Button)	<p>Turns the power on or off.</p> <p><b>Power Indicator</b></p> <p>The power indicator stays red if the display is running properly (On Mode). If the display is in Sleep Mode, the power indicator blinks red.</p>

# Customizing Settings

## Menu Settings

- 1 Press **MENU** button on the bottom of the Monitor set to display the **MENU** OSD.
- 2 Set the options by pressing the ◀ or ▶ or ▼ buttons.
- 3 Select the "**NEXT MENU**" button to enter the more option settings.
- 4 Select **EXIT** to leave the OSD menu.  
To return to the upper menu or set other menu items, use the up arrow (⬆) button.

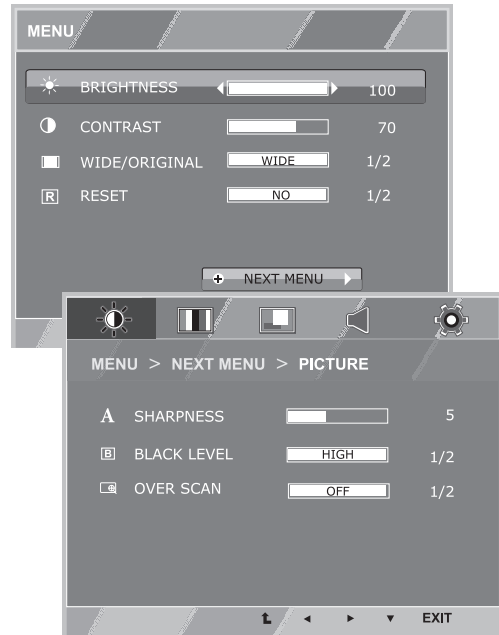

Each option is explained below.

MENU	Analog	Digital	HDMI	Description
<b>BRIGHTNESS</b>	•	•	•	To adjust the brightness, contrast of the screen
<b>CONTRAST</b>	•	•	•	
<b>WIDE/ORIGINAL</b>	•	•	•	WIDE
				Switch to full screen mode according to input image signal.
<b>RESET</b>	•	•	•	ORIGINAL
				Change the input image signal ratio to original. * This function works only if input resolution is lower than Monitor set ratio (16:9).
<b>RESET</b>	•	•	•	Restore all factory default settings. Press the ◀ , ▶ buttons to reset immediately.

MENU > NEXT MENU		Analog	Digital	HDMI	Description
<b>PICTURE</b>	<b>SHARPNESS</b>	•	•	•	To adjust the clearness of the screen .
	<b>BLACK LEVEL</b>			•	To set offset level
	<b>OVER SCAN</b>			•	To improve the clarity and stability of the screen
<b>COLOR</b>	<b>GAMMA</b>	•	•	•	To customize the color of the screen
	<b>COLOR TEMP</b>				
<b>DISPLAY</b>	<b>HORIZONTAL</b>	•			To adjust the position of the screen
	<b>VERTICAL</b>				
	<b>CLOCK</b>	•			To improve the clarity and stability of the screen
	<b>PHASE</b>				
<b>VOLUME</b>				•	To adjust the volume
<b>OTHERS</b>	<b>LANGUAGE</b>	•	•	•	To customize the screen status for a user's operating environment
	<b>POWER INDICATOR</b>				
	<b>WHITE BALANCE</b>				

- **Analog:** D-SUB(Analog signal) input.
- **Digital:** DVI-D(Digital signal) input.
- **HDMI:** HDMI(Digital signal) input.

## PICTURE

- 1 Press **MENU** button on the bottom of the Monitor set to display the **MENU OSD**.
- 2 Select the "**NEXT MENU**" button to enter the more option settings.
- 3 Enter to **PICTURE** by pressing the ▼ button.
- 4 Set the options by pressing the ◀ or ▶ or ▼ buttons.
- 5 Select **EXIT** to leave the OSD menu.  
To return to the upper menu or set other menu items, use the up arrow (⬆) button.



Each option is explained below.

MENU > NEXT MENU > PICTURE	Description
<b>SHARPNESS</b>	To adjust the clearness of the screen.
<b>BLACK LEVEL</b>	You can set the offset level. If you select 'HIGH', the screen will be bright and if you select 'LOW', the screen will be dark.(only for HDMI input) * Offset?As the criteria for video signal, it is the darkest screen the monitor can show.
<b>OVER SCAN</b>	To select the range of output image for DTV timing in HDMI input.(only for HDMI input)Recommend overscan function to turn on when connect AV equipment.

## COLOR

- 1 Press **MENU** button on the bottom of the Monitor set to display the **MENU** OSD.
- 2 Select the "**NEXT MENU**" button to enter the more option settings.
- 3 Select **COLOR** by pressing the ► button.
- 4 Enter to **COLOR** by pressing the ▼ button.
- 5 Set the options by pressing the ◀ or ▶ or ▼ buttons.
- 6 Select **EXIT** to leave the OSD menu.  
To return to the upper menu or set other menu items, use the up arrow (⬆) button.



Each option is explained below.

MENU > NEXT MENU > COLOR	Description
<b>GAMMA</b>	Set your own gamma value. : GAMMA 0, GAMMA 1, GAMMA 2 on the monitor, high gamma values display whitish images and low gamma values display blackish images.
<b>COLOR TEMP</b>	<p><b>CUSTOM</b></p> <ul style="list-style-type: none"> <li>• <b>RED</b>:Set your own red color levels.</li> <li>• <b>GREEN</b>: Set your own green color levels.</li> <li>• <b>BLUE</b>:Set your own blue color levels.</li> </ul> <p>Select the screen color.</p> <p><b>WARM</b>: Set the screen to warm color temperature (more red).</p> <p><b>MEDIUM</b>: Set the screen to medium color temperature.</p> <p><b>COOL</b>: Set the screen to cool color temperature (more blue).</p>

## DISPLAY

- 1 Press **MENU** button on the bottom of the Monitor set to display the **MENU OSD**.
- 2 Select the "**NEXT MENU**" button to enter the more option settings.
- 3 Select **DISPLAY** by pressing the ► button.
- 4 Enter to **DISPLAY** by pressing the ▼ button.
- 5 Set the options by pressing the ◀ or ▶ or ▼ buttons.
- 6 Select **EXIT** to leave the OSD menu.  
To return to the upper menu or set other menu items, use the up arrow (⬆) button.

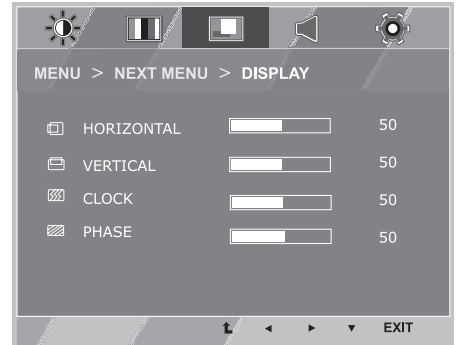

Each option is explained below.

MENU > NEXT MENU > DISPLAY	Description
<b>HORIZONTAL</b>	To move image left and right.
<b>VERTICAL</b>	To move image up and down.
<b>CLOCK</b>	To minimize any vertical bars or stripes visible on the screen background. The horizontal screen size will also change.
<b>PHASE</b>	To adjust the focus of the display. This item allows you to remove any horizontal noise and clear or sharpen the image of characters.

## VOLUME

- 1 Press **MENU** button on the bottom of the Monitor set to display the **MENU OSD**.
- 2 Select the "**NEXT MENU**" button to enter the more option settings.
- 3 Select **VOLUME** by pressing the ► button.
- 4 Enter to **VOLUME** by pressing the ▼ button.
- 5 Set the options by pressing the ◀ or ▶ buttons.
- 6 Select **EXIT** to leave the OSD menu.  
To return to the upper menu or set other menu items, use the up arrow (⬆) button.



Each option is explained below.

MENU > NEXT MENU > VOLUME	Description
<b>VOLUME</b>	To adjust the volume of headphone/earphone. (Only for HDMI input)



## OTHERS

- 1 Press **MENU** button on the bottom of the Monitor set to display the **MENU** OSD.
- 2 Select the "**NEXT MENU**" button to enter the more option settings.
- 3 Select **OTHERS** by pressing the ► button.
- 4 Enter to **OTHERS** by pressing the ▼ button.
- 5 Set the options by pressing the ◀ or ▶ or ▼ buttons.
- 6 Select **EXIT** to leave the OSD menu.  
To return to the upper menu or set other menu items, use the up arrow (⬆) button.

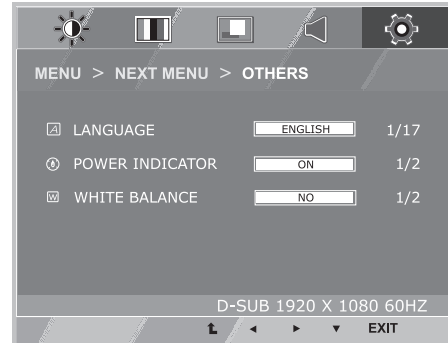

Each option is explained below.

MENU > NEXT MENU > OTHERS	Description
<b>LANGUAGE</b>	To choose the language in which the control names are displayed.
<b>POWER INDICATOR</b>	Use this function to set the power indicator on the bottom side of the monitor to ON or OFF.If you set OFF, it will go off. If you set ON at any time, the power indicator will automatically be turned on.
<b>WHITE BALANCE</b>	If the output of the video card is different the required specifications,the color level may deteriorate due to video signal distortion. Using this function, the signal level is adjusted to fit into the standard output level of the video card in order to provide the optimal image.Activate this function when white and black colors are present in the screen.

## SUPER ENERGY SAVING Setting

- 1 Press **eS** ( **SUPER ENERGY SAVING** ) button on the bottom of the Monitor set to display the **SUPER ENERGY SAVING** OSD.
- 2 Set the options by pressing the ◀ or ▶ or ▼ buttons.
- 3 Select **EXIT** to leave the OSD menu.

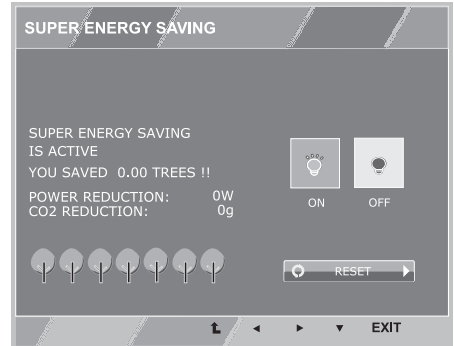

Each option is explained below.

SUPER ENERGY SAVING	Description
<b>ON</b>	Enables SUPER ENERGY SAVING you can save energy with this energy- efficient function
<b>OFF</b>	Disables SUPER ENERGY SAVING.
<b>RESET</b>	Resets the values of total energy consumption reduction and CO2 emission reduction estimates.

**NOTE**

- **TOTAL POWER REDUCTION:** How much power is saved while using the monitor.
- **TOTAL CO2 REDUCTION:** Change the TOTAL POWER REDUCTION to CO2.
- **SAVING DATA(W/h)**

	546 mm (21.5 inch)	584 mm (23 inch)	609 mm (24 inch)	685 mm (27 inch)
SUPER SAVING	6 W/h	7 W/h	7 W/h	9 W/h

- Saving Data depends on the Panel. So,those values should be different from each panel and panel vendor.
- LG calculated these values by using “**broadcast video signal**” (including broadcast video: IEC 62087)
- SUPER SAVING refers to how much power can be saved using the SUPER ENERGY SAVING function.

## PICTURE MODE Setting

- 1 Press **MODE** button on the bottom of the Monitor set to display the **PICTURE MODE** OSD .
- 2 Set the options by pressing the ◀ or ▶ or ▼ buttons.
- 3 Select **EXIT** to leave the OSD menu.

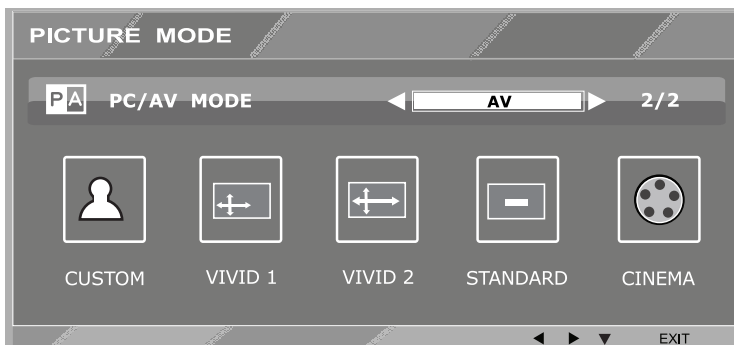
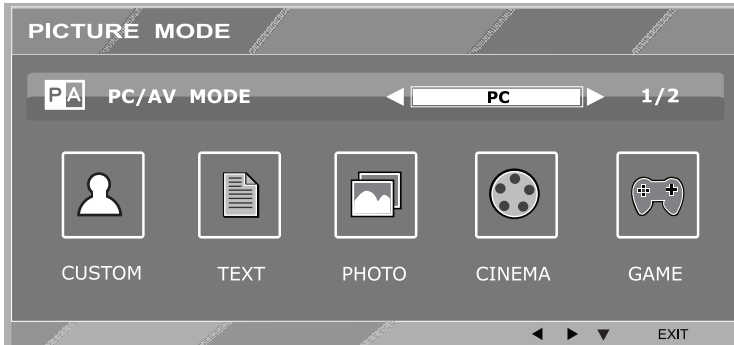

Each option is explained below.

PICTURE MODE	Description
<b>CUSTOM</b>	It is a mode that the user can adjust each element. It can adjust the color mode of the Main Menu.
<b>TEXT</b>	It is a mode that the screen is adjusted to the best for the text works.
<b>PHOTO</b>	It is a mode that the screen is adjusted to the best to view pictures.
<b>CINEMA</b>	It is a mode that the screen is adjusted to the best to view the videos.
<b>GAME</b>	It is a mode that the screen is adjusted to the best to play a game.

PICTURE MODE	Description
<b>CUSTOM</b>	It is a mode that the user can adjust each element. It can adjust the color mode of the Main Menu.
<b>VIVID 1</b>	Adjusts the video image for the retail environment by enhancing the contrast, brightness, Colour, and sharpness.
<b>VIVID 2</b>	
<b>STANDARD</b>	Adjusts the image for the normal environment.
<b>CINEMA</b>	It is a mode that the screen is adjusted to the best to view the videos.

# TROUBLESHOOTING

Check the following before calling for service.

No image appears	
Is the power cord of the display connected?	<ul style="list-style-type: none"> <li>• Check and see if the power cord is connected properly to the power outlet.</li> </ul>
Is the power indicator light on?	<ul style="list-style-type: none"> <li>• Press the Power button.</li> </ul>
Is the power on and the power indicator Red?	<ul style="list-style-type: none"> <li>• Adjust the brightness and the contrast.</li> </ul>
Is the power indicator flickering?	<ul style="list-style-type: none"> <li>• If the display is in power saving mode, try moving the mouse or pressing any key on the keyboard to bring up the screen.</li> <li>• Try to turn on the PC.</li> </ul>
Do you see an "OUT OF RANGE" message on the screen?	<ul style="list-style-type: none"> <li>• This message appears when the signal from the PC (video card) is out of horizontal or vertical frequency range of the display. See the 'Specifications' section of this manual and configure your display again.</li> </ul>
Do you see a "NO SIGNAL" message on the screen?	<ul style="list-style-type: none"> <li>• When the monitor is on "No-Signal" in 5 minutes, the monitor goes to DPM mode.</li> </ul>

Do you see a "OSD LOCKED" message on the screen?	
Do you see "OSD LOCKED" when you push MENU button?	<ul style="list-style-type: none"> <li>• You can secure the current control settings, so that they cannot be inadvertently changed. You can unlock the OSD controls at any time by pushing the MENU button for several seconds: the message "OSD UNLOCKED" will appear.</li> </ul>

Display image is incorrect	
Display Position is incorrect.	<ul style="list-style-type: none"> <li>• Press the <b>AUTO</b> button to automatically adjust your display image to the ideal setting.</li> </ul>
On the screen background, vertical bars or stripes are visible.	<ul style="list-style-type: none"> <li>• Press the <b>AUTO</b> button to automatically adjust your display image to the ideal setting.</li> </ul>
Any horizontal noise appearing in any image or characters are not clearly portrayed.	<ul style="list-style-type: none"> <li>• Press the <b>AUTO</b> button to automatically adjust your display image to the ideal setting.</li> <li>• Check <b>Control Panel ► Display ► Settings</b> and adjust the display to the recommended resolution or adjust the display image to the ideal setting. Set the color setting higher than 24 bits (true color).</li> </ul>

**CAUTION**

- Check **Control Panel ► Display ► Settings** and see if the frequency or the resolution were changed. If yes, readjust the video card to the recommend resolution.
- If the recommended resolution (optimal resolution) is not selected, letters may be blurred and the screen may be dimmed, truncated or biased. Make sure to select the recommend resolution.
- The setting method can differ by computer and O/S (Operation System), and resolution mentioned above may not be supported by the video card performance. In this case, please ask to the computer or the video card manufacturer.

**Display image is incorrect**

The screen color is mono or abnormal.

- Check if the signal cable is properly connected and use a screwdriver to fasten if necessary.
- Make sure the video card is properly inserted in the slot.
- Set the color setting higher than 24 bits (true color) at **Control Panel ► Settings**.

The screen blinks.

- Check if the screen is set to interlace mode and if yes, change it to the recommend resolution.

**Do you see an "Unrecognized monitor, Plug&Play (VESA DDC) monitor found" message?**

Have you installed the display driver?

- Be sure to install the display driver from the display driver CD (or diskette) that comes with your display. Or, you can also download the driver from our web site: <http://www.lg.com>.
- Make sure to check if the video card supports Plug&Play function.

# SPECIFICATIONS

## E2242V

<b>Display</b>	<b>Screen Type</b>	54.6 cm (21.5 inch) Flat Panel Active matrix-TFT LCD Anti-Glare coating Visible diagonal size: 54.6 cm
	<b>Pixel Pitch</b>	0.247 mm x 0.247 mm (Pixel Pitch)
<b>Sync Input</b>	<b>Horizontal Frequency</b>	30 kHz to 83 kHz (Automatic)
	<b>Vertical Frequency</b>	56Hz to 75Hz (D-SUB, DVI-D) 56Hz to 61Hz (HDMI)
	<b>Input Form</b>	Separate Sync. Digital
<b>Video Input</b>	<b>Signal Input</b>	15 pin D-SUB Connector /DVI-D Connector (Digital) HDMI Connector
	<b>Input Form</b>	RGB Analog (0.7 Vp-p/ 75 ohm), Digital
<b>Resolution</b>	<b>Max</b>	D-SUB(Analog) : 1920 x 1080 @ 60 Hz DVI / HDMI (Digital) : 1920 x 1080 @ 60 Hz
	<b>Recommend</b>	VESA 1920 x 1080 @ 60 Hz
<b>Plug &amp; Play</b>	DDC 2B(Analog,Digital,HDMI)	
<b>Power Consumption</b>	On Mode : 23 W(Typ.) Sleep Mode ≤ 0.3 W Off Mode ≤ 0.3 W	
<b>Power Input</b>	19 V --- 1.2 A	
<b>AC-DC Adapter</b>	Type ADS-40SG-19-3 19025G, manufactured by SHENZHEN HONOR ELECTRONIC or Type ADS-40FSG-19 19025GPG-1, manufactured by SHENZHEN HONOR ELECTRONIC or Type ADS-40FSG-19 19025GPBR-1, manufactured by SHENZHEN HONOR ELECTRONIC or Type ADS-40FSG-19 19025GPI-1,manufactured by SHENZHEN HONOR ELECTRONIC or Type ADS-40FSG-19 19025GPCU-1, manufactured by SHENZHEN HONOR ELECTRONIC or Type ADS-40FSG-19 19025GPB-2, manufactured by SHENZHEN HONOR ELECTRONIC or Type LCAP21, manufactured by LIEN CHANG ELECTRONIC ENTERPRISE or Type LCAP26-A, manufactured by LIEN CHANG ELECTRONIC ENTERPRISE or Type LCAP26-E, manufactured by LIEN CHANG ELECTRONIC ENTERPRISE or Type LCAP26-I, manufactured by LIEN CHANG ELECTRONIC ENTERPRISE or Type LCAP26-B, manufactured by LIEN CHANG ELECTRONIC ENTERPRISE or Type PSAB-L203A, manufactured by LG Innotek Co.,Ltd or Type PSAB-L202B, manufactured by LG Innotek Co.,Ltd or Type PSAB-L202C, manufactured by LG Innotek Co.,Ltd or Type PSAB-L202D, manufactured by LG Innotek Co.,Ltd  <b>OUTPUT: 19 V --- 1.3 A</b>	
<b>Dimensions (Width x Height x Depth)</b>	<b>With Stand</b>	50.9 cm x 38.7 cm x 18.1 cm
	<b>Without Stand</b>	50.9 cm x 31.3 cm x 5.5 cm
<b>Weight</b>	2.6 kg	
<b>Tilt Range</b>	-5° to 20°	
<b>Environmental conditions</b>	<b>Operating Temperature</b>	10°C to 35 °C
	<b>Operating Humidity</b>	10 % to 80 %
	<b>Storage Temperature</b>	-20°C to 60 °C
	<b>Storage Humidity</b>	5 % to 90 % non-Condensing
<b>Stand Base</b>	Attached ( ), Detached (O)	
<b>Power cord</b>	Wall-outlet type	

Product specifications shown above may be changed without prior notice due to upgrade of product functions.

# SPECIFICATIONS

## E2342V

<b>Display</b>	<b>Screen Type</b>	58.4 cm (23 inch) Flat Panel Active matrix-TFT LCD Anti-Glare coating Visible diagonal size: 58.4 cm
	<b>Pixel Pitch</b>	0.265 mm x 0.265 mm (Pixel Pitch)
<b>Sync Input</b>	<b>Horizontal Frequency</b>	30 kHz to 83 kHz (Automatic)
	<b>Vertical Frequency</b>	56Hz to 75Hz (D-SUB, DVI-D) 56Hz to 61Hz (HDMI)
	<b>Input Form</b>	Separate Sync. Digital
<b>Video Input</b>	<b>Signal Input</b>	15 pin D-SUB Connector / DVI-D Connector (Digital) HDMI Connector
	<b>Input Form</b>	RGB Analog (0.7 Vp-p/ 75 ohm), Digital
<b>Resolution</b>	<b>Max</b>	D-SUB(Analog) : 1920 x 1080 @ 60 Hz DVI / HDMI (Digital) : 1920 x 1080 @ 60 Hz
	<b>Recommend</b>	VESA 1920 x 1080 @ 60 Hz
<b>Plug &amp; Play</b>	DDC 2B(Analog,Digital,HDMI)	
<b>Power Consumption</b>	On Mode : 24 W(Typ.) Sleep Mode ≤ 0.3 W Off Mode ≤ 0.3 W	
<b>Power Input</b>	19 V --- 1.3 A	
<b>AC-DC Adapter</b>	Type ADS-40SG-19-3 19032G, manufactured by SHENZHEN HONOR ELECTRONIC or Type ADS-40FSG-19 19032GPG-1, manufactured by SHENZHEN HONOR ELECTRONIC or Type ADS-40FSG-19 19032GPBR-1, manufactured by SHENZHEN HONOR ELECTRONIC or Type ADS-40FSG-19 19032GPI-1, manufactured by SHENZHEN HONOR ELECTRONIC or Type ADS-40FSG-19 19032GPCU-1, manufactured by SHENZHEN HONOR ELECTRONIC or Type LCAP21A, manufactured by LIEN CHANG ELECTRONIC ENTERPRISE or Type LCAP26A-A, manufactured by LIEN CHANG ELECTRONIC ENTERPRISE or Type LCAP26A-E, manufactured by LIEN CHANG ELECTRONIC ENTERPRISE or Type LCAP26A-I, manufactured by LIEN CHANG ELECTRONIC ENTERPRISE or Type LCAP26A-B, manufactured by LIEN CHANG ELECTRONIC ENTERPRISE	
	<b>OUTPUT: 19 V --- 1.7 A</b>	
	Type ADS-40SG-19-3 19025G, manufactured by SHENZHEN HONOR ELECTRONIC or Type ADS-40FSG-19 19025GPG-1, manufactured by SHENZHEN HONOR ELECTRONIC or Type ADS-40FSG-19 19025GPBR-1, manufactured by SHENZHEN HONOR ELECTRONIC or Type ADS-40FSG-19 19025GPI-1, manufactured by SHENZHEN HONOR ELECTRONIC or Type ADS-40FSG-19 19025GPCU-1, manufactured by SHENZHEN HONOR ELECTRONIC or Type ADS-40FSG-19 19025GPB-2, manufactured by SHENZHEN HONOR ELECTRONIC or Type LCAP21, manufactured by LIEN CHANG ELECTRONIC ENTERPRISE or Type LCAP26-A, manufactured by LIEN CHANG ELECTRONIC ENTERPRISE or Type LCAP26-E, manufactured by LIEN CHANG ELECTRONIC ENTERPRISE or Type LCAP26-I, manufactured by LIEN CHANG ELECTRONIC ENTERPRISE or Type LCAP26-B, manufactured by LIEN CHANG ELECTRONIC ENTERPRISE or Type PSAB-L203A, manufactured by LG Innotek Co.,Ltd or Type PSAB-L202B, manufactured by LG Innotek Co.,Ltd or Type PSAB-L202C, manufactured by LG Innotek Co.,Ltd or Type PSAB-L202D, manufactured by LG Innotek Co.,Ltd	
<b>OUTPUT: 19 V --- 1.3 A</b>		
<b>Dimensions (Width x Height x Depth)</b>	<b>With Stand</b>	54.4 cm x 40.6 cm x 18.1 cm
	<b>Without Stand</b>	54.4 cm x 33.2 cm x 5.5 cm
<b>Weight</b>	2.9 kg	
<b>Tilt Range</b>	-5° to 20°	
<b>Environmental conditions</b>	<b>Operating Temperature</b>	10°C to 35 °C
	<b>Operating Humidity</b>	10 % to 80 %
	<b>Storage Temperature</b>	-20°C to 60 °C
	<b>Storage Humidity</b>	5 % to 90 % non-Condensing
<b>Stand Base</b>	Attached ( ), Detached (O)	
<b>Power cord</b>	Wall-outlet type	

Product specifications shown above may be changed without prior notice due to upgrade of product functions.

# SPECIFICATIONS

## E2442V

<b>Display</b>	<b>Screen Type</b>	60.9 cm (24 inch) Flat Panel Active matrix-TFT LCD Anti-Glare coating Visible diagonal size: 60.9 cm
	<b>Pixel Pitch</b>	0.277 mm x 0.277 mm (Pixel Pitch)
<b>Sync Input</b>	<b>Horizontal Frequency</b>	30 kHz to 83 kHz (Automatic)
	<b>Vertical Frequency</b>	56Hz to 75Hz (D-SUB, DVI-D) 56Hz to 61Hz (HDMI)
	<b>Input Form</b>	Separate Sync. Digital
<b>Video Input</b>	<b>Signal Input</b>	15 pin D-SUB Connector /DVI-D Connector (Digital) HDMI Connector
	<b>Input Form</b>	RGB Analog (0.7 Vp-p/ 75 ohm), Digital
<b>Resolution</b>	<b>Max</b>	D-SUB(Analog) : 1920 x 1080 @ 60 Hz DVI / HDMI (Digital) : 1920 x 1080 @ 60 Hz
	<b>Recommend</b>	VESA 1920 x 1080 @ 60 Hz
<b>Plug &amp; Play</b>	DDC 2B(Analog,Digital,HDMI)	
<b>Power Consumption</b>	On Mode : 25 W(Typ.) Sleep Mode ≤ 0.3 W Off Mode ≤ 0.3 W	
<b>Power Input</b>	19 V $\overline{\text{---}}$ 1.6 A	
<b>AC-DC Adapter</b>	Type ADS-40SG-19-3 19032G, manufactured by SHENZHEN HONOR ELECTRONIC or Type ADS-40FSG-19 19032GPG-1, manufactured by SHENZHEN HONOR ELECTRONIC or Type ADS-40FSG-19 19032GPBR-1, manufactured by SHENZHEN HONOR ELECTRONIC or Type ADS-40FSG-19 19032GPI-1, manufactured by SHENZHEN HONOR ELECTRONIC or Type ADS-40FSG-19 19032GPCU-1, manufactured by SHENZHEN HONOR ELECTRONIC or Type LCAP21A, manufactured by LIEN CHANG ELECTRONIC ENTERPRISE or Type LCAP26A-A, manufactured by LIEN CHANG ELECTRONIC ENTERPRISE or Type LCAP26A-E, manufactured by LIEN CHANG ELECTRONIC ENTERPRISE or Type LCAP26A-I, manufactured by LIEN CHANG ELECTRONIC ENTERPRISE or Type LCAP26A-B, manufactured by LIEN CHANG ELECTRONIC ENTERPRISE	
	<b>OUTPUT:</b> 19 V $\overline{\text{---}}$ 1.7 A	
<b>Dimensions (Width x Height x Depth)</b>	<b>With Stand</b>	56.7 cm x 41.8 cm x 18.1 cm
	<b>Without Stand</b>	56.7 cm x 34.3 cm x 5.5 cm
<b>Weight</b>	3.6 kg	
<b>Tilt Range</b>	-5° to 20°	
<b>Environmental conditions</b>	<b>Operating Temperature</b>	10°C to 35 °C
	<b>Operating Humidity</b>	10 % to 80 %
	<b>Storage Temperature</b>	-20°C to 60 °C
	<b>Storage Humidity</b>	5 % to 90 % non-Condensing
<b>Stand Base</b>	Attached ( ), Detached (O)	
<b>Power cord</b>	Wall-outlet type	

Product specifications shown above may be changed without prior notice due to upgrade of product functions.



# SPECIFICATIONS

## E2742V

<b>Display</b>	<b>Screen Type</b>	68.5 cm (27 inch) Flat Panel Active matrix-TFT LCD Anti-Glare coating Visible diagonal size: 68.5 cm
	<b>Pixel Pitch</b>	0.311 mm x 0.311 mm (Pixel Pitch)
<b>Sync Input</b>	<b>Horizontal Frequency</b>	30 kHz to 83 kHz (Automatic)
	<b>Vertical Frequency</b>	56Hz to 75Hz (D-SUB, DVI-D) 56Hz to 61Hz (HDMI)
	<b>Input Form</b>	Separate Sync. Digital
<b>Video Input</b>	<b>Signal Input</b>	15 pin D-SUB Connector /DVI-D Connector (Digital) HDMI Connector
	<b>Input Form</b>	RGB Analog (0.7 Vp-p/ 75 ohm), Digital
<b>Resolution</b>	<b>Max</b>	D-SUB(Analog) : 1920 x 1080 @ 60 Hz DVI / HDMI (Digital) : 1920 x 1080 @ 60 Hz
	<b>Recommend</b>	VESA 1920 x 1080 @ 60 Hz
<b>Plug &amp; Play</b>	DDC 2B(Analog,Digital,HDMI)	
<b>Power Consumption</b>	On Mode : 30 W(Typ.) Sleep Mode ≤ 0.3 W Off Mode ≤ 0.3 W	
<b>Power Input</b>	19 V --- 2.0 A	
<b>AC-DC Adapter</b>	Type PA-1650-68, manufactured by LITE-ON TECHNOLOGY CORPORATION	
	<b>OUTPUT:</b> 19 V --- 3.42 A	
	Type LCAP21B, manufactured by LIEN CHANG ELECTRONIC ENTERPRISE	
	<b>OUTPUT:</b> 19 V --- 2.1 A	
	Type PSAB-L101A, manufactured by LG Innotek Co., Ltd.	
<b>OUTPUT:</b> 19 V --- 2.53 A		
<b>Dimensions (Width x Height x Depth)</b>	<b>With Stand</b>	64.1 cm x 45.9 cm x 20.3 cm
	<b>Without Stand</b>	64.1 cm x 39.3 cm x 4.7 cm
<b>Weight</b>	4.4 kg	
<b>Tilt Range</b>	-5° to 20°	
<b>Environmental conditions</b>	<b>Operating Temperature</b>	10°C to 35 °C
	<b>Operating Humidity</b>	10 % to 80 %
	<b>Storage Temperature</b>	-20°C to 60 °C
	<b>Storage Humidity</b>	5 % to 90 % non-Condensing
<b>Stand Base</b>	Attached ( ), Detached (O)	
<b>Power cord</b>	Wall-outlet type	

Product specifications shown above may be changed without prior notice due to upgrade of product functions.

## Preset Modes (Resolution)

### E2242V, E2342V, E2442V, E2742V

Display Modes (Resolution)	Horizontal Frequency(kHz)	Vertical Frequency(Hz)	Polarity(H/V)	
720 x 400	31.468	70	-/+	
640 x 480	31.469	60	-/-	
640 x 480	37.500	75	-/-	
800 x 600	37.879	60	+/+	
800 x 600	46.875	75	+/+	
1024 x 768	48.363	60	-/-	
1024 x 768	60.023	75	+/+	
1152 x 864	67.500	75	+/+	
1280 x 1024	63.981	60	+/+	
1280 x 1024	79.976	75	+/+	
1680 x 1050	65.290	60	-/+	
1920 x 1080	67.500	60	+/+	Recommend Mode

## HDMI TIMING

Display Modes (Resolution)	Horizontal Frequency(kHz)	Vertical Frequency(Hz)	
480P	31.50	60	
576P	31.25	50	
720P	37.50	50	
720P	45.00	60	
1080i	28.12	50	
1080i	33.75	60	
1080P	56.25	50	
1080P	67.50	60	Recommend Mode

## Indicator

Mode	LED Color
On Mode	Red
Sleep Mode	Blinking Red
Off Mode	Off

# PROPER POSTURE

## Proper posture for using the Monitor set.

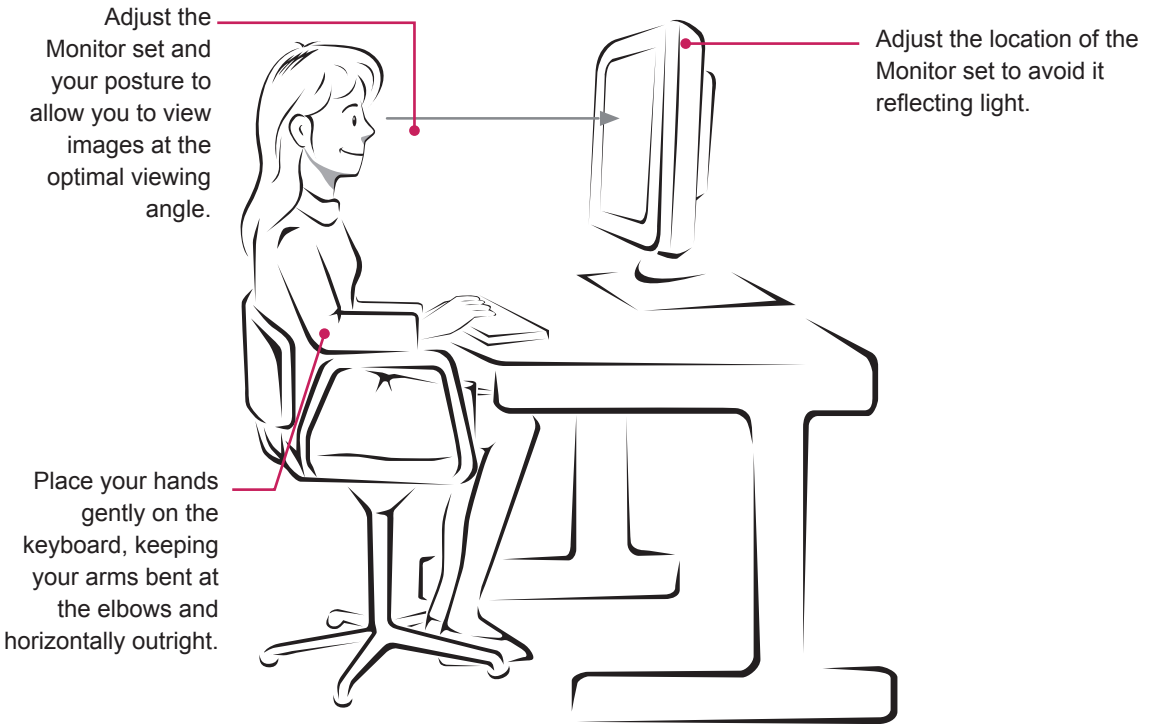



Make sure to read the Safety Precautions before using the product.

Keep the Owner's Manual (CD) in an accessible place for future reference.

The model and serial number of the SET is located on the back and one side of the SET. Record it below should you ever need service.

MODEL \_\_\_\_\_

SERIAL \_\_\_\_\_

ENERGY STAR is a set of power-saving guidelines issued by the U.S. Environmental Protection Agency (EPA).



As an ENERGY STAR Partner LGE U. S. A., Inc. has determined that this product meets the ENERGY STAR guidelines for energy efficiency.