



ENGLISH

User Guide

LG-E460

0000000 (1.0)

www.lg.com



ENGLISH

User Guide

- Screen displays and illustrations may differ from those you see on actual phone.
- Some of the contents of this guide may not apply to your phone, depending on the software and your service provider. All information in this document is subject to change without notice.
- This handset is not suitable for people who have a visual impairment due to the touch screen keyboard.
- Copyright ©2013 LG Electronics, Inc. All rights reserved. LG and the LG logo are registered trademarks of LG Group and its related entities. All other trademarks are the property of their respective owners.
- Google™, Google Maps™, Gmail™, YouTube™, Google Talk™ and Play Store™ are trademarks of Google, Inc.

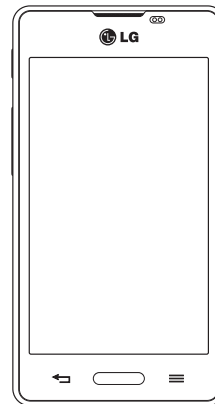

Table of contents

Guidelines for safe and efficient use	5	Bluetooth	35
Important notice	15	Sharing your phone's data connection	36
Getting to know your phone	21	PC connections with a USB cable	38
Phone overview	21	Calls	40
Installing the SIM card and battery	23	Making a call	40
Charging the phone	25	Calling your contacts	40
Using the memory card	25	Answering and rejecting a call	40
Locking and unlocking the screen	26	Adjusting the in-call volume	41
Your Home screen	27	Making a second call	41
Touch screen tips	27	Viewing your call logs	41
Home screen	28	Call settings	42
Customizing the Home screen	28	Contacts	43
Returning to recently-used applications	29	Searching for a contact	43
Notifications	29	Adding a new contact	43
Swipe down for notifications & settings	30	Favorite contacts	43
Quick Settings	30	Creating a group	44
Indicator icons on the Status Bar	31	Messaging	45
On-screen keyboard	32	Sending a message	45
Entering accented letters	32	Threaded box	46
Google account setup	33	Changing your message settings	46
Connecting to Networks and Devices	34	E-mail	47
Wi-Fi	34	Managing an email account	47
Connecting to Wi-Fi networks	34	Working with account folders	47
Turning Wi-Fi on and connecting to a Wi-Fi network	34	Composing and sending email	48
		Camera	49
		Getting to know the viewfinder	49
		Using the advanced settings	50

Taking a quick photo	51	Music	63
Once you've taken a photo.....	52	Playing a song.....	63
Viewing your saved photos	53	FM Radio	65
Video camera	54	Searching for stations.....	65
Getting to know the viewfinder	54	Tuning in automatically.....	65
Using the advanced settings	55	Utilities	66
Recording a quick video.....	55	Setting your alarm	66
After recording a video.....	56	Using your calculator	66
Watching your saved videos	56	Adding an event to your calendar	66
Adjusting the volume when viewing a		Voice Recorder	67
video	56	Recording a sound or voice	67
LG Unique Function.....	57	Tasks.....	67
QuickMemo function.....	57	Polaris Viewer 4	68
Using the QuickMemo options	58	Google+	68
Viewing the saved QuickMemo	58	Voice Search.....	68
LG SmartWorld	59	Downloads	68
How to Get to LG SmartWorld from		The Web	69
Your Phone.....	59	Internet.....	69
How to use LG SmartWorld.....	59	Using the Web toolbar	69
Multimedia	61	Viewing webpages	69
Gallery.....	61	Opening a page	70
Viewing pictures	61	Searching the web by voice.....	70
Playing videos	61	Bookmarks	70
Editing photos/videos	62	History	70
Deleting images.....	62	Chrome	71
Setting as wallpaper	62	Viewing webpages.....	71
Videos	62	Opening a page	71
Playing a video	62	Searching the web by voice.....	71
		Syncing with other devices	71

Table of contents

Settings	72
Access the Settings menu	72
WIRELESS & NETWORKS	72
DEVICE	75
PERSONAL	77
SYSTEM	78
PC software (LG PC Suite)	80
Phone software update	83
About this user guide	85
About this user guide	85
Trademarks	85
Accessories	86
Troubleshooting	87

Guidelines for safe and efficient use

Please read these simple guidelines. Not following these guidelines may be dangerous or illegal.

Exposure to radio frequency energy

THIS DEVICE MEETS INTERNATIONAL GUIDELINES FOR EXPOSURE TO RADIO WAVES
Your mobile device is a radio transmitter and receiver. It is designed and manufactured not to exceed the limits for exposure to radio frequency (RF) recommended by international guidelines (ICNIRP). These limits are part of comprehensive guidelines and establish permitted levels of RF energy for the general population. The guidelines were developed by independent scientific organisations through periodic and thorough evaluation of scientific studies. The guidelines include a substantial safety margin designed to assure the safety of all persons, regardless of age or health.

The exposure standard for mobile devices employs a unit of measurement known as the Specific Absorption Rate, or SAR. The SAR limit stated in the international guidelines is 2.0 W/kg*. Tests for SAR are conducted using standard operating positions with the device transmitting at its highest certified power level in all tested frequency bands. Although the SAR is determined at the highest certified power level, the actual SAR of the device while operating can be well below the maximum value. This is because the device is designed to operate at multiple power levels so as to use only the power required to reach the network. In general, the closer you are to a base station, the lower the power output of the device. Before a phone model is available for sale to the public, compliance with the European R&TTE directive must be shown. This directive includes as one essential requirement the protection of the health and the safety for the user and any other person.

The highest SAR value for this device when tested for use at the ear is 0.000 W/kg. This device meets RF exposure guidelines when used either in the normal use position against the ear or when positioned at least 1.5 cm away from the body. When a carry case, belt clip or holder is used for body-worn operation, it should not contain metal and should position the product at least 1.5 cm away from your body. In order

Guidelines for safe and efficient use

to transmit data files or messages, this device requires a quality connection to the network. In some cases, transmission of data files or messages may be delayed until such a connection is available. Ensure the above separation distance instructions are followed until the transmission is completed. The highest SAR value for this device when tested for use at the body is 0.000 W/kg.

* The SAR limit for mobile devices used by the public is 2.0 watts/ kilogram (W/kg) averaged over ten grams of body tissue. The guidelines incorporate a substantial margin of safety to give additional protection for the public and to account for any variations in measurements. SAR values may vary depending on national reporting requirements and the network band.

FCC SAR information

Your mobile device is also designed to meet the requirements for exposure to radio waves established by the Federal Communications Commission (USA) and Industry Canada. These requirements set a SAR limit of 1.6 W/kg averaged over 1 gram of tissue. The highest SAR value reported under this standard during product certification for use at the ear is 0.60 W/kg and when properly worn on the body is 1.18 W/kg. Additionally, this device was tested for typical body-worn operations with the back of the phone kept 1 cm (0.39 inches) between the users body and the back of the phone. To comply with FCC RF exposure requirements, a minimum separation distance of 1 cm (0.39 inches) must be maintained between the user's body and the back of the phone.

* FCC Notice & Caution

Notice!

This device complies with part 15 of the FCC Rules. Operation is subject to the following two conditions:

- (1) This device may not cause harmful interference, and
- (2) this device must accept any interference received, including interference that may cause undesired operation.

Caution!

Change or Modifications that are not specifically approved by the manufacturer could void the user's authority to operate the equipment.

Product care and maintenance** WARNING**

Only use batteries, chargers and accessories approved for use with this particular phone model. The use of any other types may invalidate any approval or warranty applying to the phone and may be dangerous.

- Do not disassemble this unit. Take it to a qualified service technician when repair work is required.
- Repairs under warranty, at LG's discretion, may include replacement parts or boards that are either new or reconditioned, provided that they have functionality equal to that of the parts being replaced.
- Keep away from electrical appliances such as TVs, radios and personal computers.
- The unit should be kept away from heat sources such as radiators or cookers.
- Do not drop.
- Do not subject this unit to mechanical vibration or shock.
- Switch off the phone in any area where you are required to by special regulations. For example, do not use your phone in hospitals as it may affect sensitive medical equipment.
- Do not handle the phone with wet hands while it is being charged. It may cause an electric shock and can seriously damage your phone.
- Do not charge a handset near flammable material as the handset can become hot and create a fire hazard.
- Use a dry cloth to clean the exterior of the unit (do not use solvents such as benzene, thinner or alcohol).

Guidelines for safe and efficient use

- Do not charge the phone when it is on soft furnishings.
- The phone should be charged in a well ventilated area.
- Do not subject this unit to excessive smoke or dust.
- Do not keep the phone next to credit cards or transport tickets; it can affect the information on the magnetic strips.
- Do not tap the screen with a sharp object as it may damage the phone.
- Do not expose the phone to liquid or moisture.
- Use accessories like earphones cautiously. Do not touch the antenna unnecessarily.
- Do not use the phone or accessories in places with high humidity such as pools, greenhouses, solariums or tropical environments, it may cause damage to the phone and invalidation of warranty.
- Do not use, touch or attempt to remove or fix broken, chipped or cracked glass. Damage to the glass display due to abuse or misuse is not covered under the warranty.
- Your phone is an electronic device that generates heat during normal operation. Extremely prolonged, direct skin contact in the absence of adequate ventilation may result in discomfort or minor burns. Therefore, use care when handling your phone during or immediately after operation.

Efficient phone operation

Electronic and medical devices

All mobile phones may receive interference, which could affect performance.

- Do not use your mobile phone near medical equipment without requesting permission. Please consult your doctor to determine if operation of your phone may interfere with the operation of your medical device.
- Some hearing aids might be disturbed by mobile phones.
- Minor interference may affect TVs, radios, PCs, etc.

Pacemakers

Pacemaker manufacturers recommend that a minimum separation of 15 cm be maintained between a mobile phone and a pacemaker to avoid potential interference with the pacemaker. To achieve this use the phone on the opposite ear to your pacemaker and do not carry it in a breast pocket.

Hospitals

Switch off your wireless device when requested to do so in hospitals, clinics or health care facilities. These requests are designed to prevent possible interference with sensitive medical equipment.

Road safety

Check the laws and regulations on the use of mobile phones in the area when you drive.

- Do not use a hand-held phone while driving.
- Give full attention to driving.
- Use a hands-free kit, if available.
- Pull off the road and park before making or answering a call if driving conditions require you to do so.
- RF energy may affect some electronic systems in your vehicle such as car stereos and safety equipment.
- If your vehicle is equipped with an air bag, do not obstruct with installed or portable wireless equipment. It can cause the air bag to fail or cause serious injury due to improper performance.
- If you are listening to music while out and about, please ensure that the volume is at a reasonable level so that you are aware of your surroundings. This is of particular importance when near roads.

Guidelines for safe and efficient use

Glass Parts

Some parts of your mobile device are made of glass. This glass could break if your mobile device is dropped on a hard surface or receives a substantial impact. If the glass breaks, do not touch or attempt to remove. Stop using your mobile device until the glass is replaced by an authorised service provider.

Blasting area

Do not use the phone where blasting is in progress. Observe restrictions, and follow any regulations or rules.

Potentially explosive atmospheres

- Do not use your phone at a refuelling point.
- Do not use near fuel or chemicals.
- Do not transport or store flammable gas, liquid or explosives in the same compartment of your vehicle as your mobile phone or accessories.

In aircraft

Wireless devices can cause interference in aircraft.

- Turn your mobile phone off before boarding any aircraft.
- Do not use it on the ground without permission from the crew.

Children

Keep the phone in a safe place out of the reach of small children. It includes small parts which may cause a choking hazard if detached.

Emergency calls

Emergency calls may not be available on all mobile networks. Therefore you should never depend solely on your phone for emergency calls. Check with your local service provider.

Part 15.21 statement

Changes or modifications that are not expressly approved by the manufacturer could void the user's authority to operate the equipment.

Part 15.105 statement

This equipment has been tested and found to comply with the limits for a class B digital device, pursuant to Part 15 of the FCC rules. These limits are designed to provide reasonable protection against harmful interference in a residential installation. This equipment generates, uses, and can radiate radio frequency energy and, if not installed and used in accordance with the instructions, may cause harmful interference to radio communications.

However, there is no guarantee that interference will not occur in a particular installation. If you experience interference with reception (e.g., television), determine if this equipment is causing the harmful interference by turning the equipment off and then back on to see if the interference is affected. If necessary, try correcting the interference by one or more of the following measures:

- Reorient or relocate the receiving antenna.
- Increase the separation between the equipment and receiver.
- Connect the equipment into an outlet on a circuit different from that to which the receiver is connected.
- Consult the dealer or an experienced radio/TV technician for help.

Guidelines for safe and efficient use

Body-worn Operation

This device was tested for typical body-worn operations with the back of the phone kept 1 cm (0.39 inches) between the user's body and the back of the phone. To comply with federal RF exposure requirements, a minimum separation distance of 1 cm (0.39 inches) must be maintained between the user's body and the back of the phone.

Third-party belt-clips, holsters, and similar accessories containing metallic components should not be used. Body-worn accessories that cannot maintain 1 cm (0.39 inches) separation distance between the user's body and the back of the phone, and have not been tested for typical bodyworn operations may not comply with federal RF exposure limits and should be avoided.

FCC Part 15 Class B Compliance

This device and its accessories comply with part 15 of FCC rules and ICES-003 Class B digital apparatus requirements for Industry Canada.

Operation is subject to the following two conditions:

(1) This device and its accessories may not cause harmful interference, and (2) this device and its accessories must accept any interference received, including interference that may cause undesired operation.

Battery information and care

- You do not need to completely discharge the battery before recharging. Unlike other battery systems, there is no memory effect that could compromise the battery's performance.
- Use only LG batteries and chargers. LG chargers are designed to maximise battery life.

- Do not disassemble or short circuit the battery pack.
- Keep the metal contacts of the battery pack clean.
- Replace the battery when it no longer provides acceptable performance. The battery pack may be recharged hundreds of times before it needs replacing.
- Recharge the battery if it has not been used for a long time to maximise usability.
- Do not expose the battery charger to direct sunlight or use it in high humidity, such as in the bathroom.
- Do not leave the battery in hot or cold places, as this may deteriorate battery performance.
- There is risk of explosion if the battery is replaced with an incorrect type.
- Dispose of used batteries according to the manufacturer's instructions. Please recycle when possible. Do not dispose as household waste.
- If you need to replace the battery, take it to your nearest authorised LG Electronics service point or dealer for assistance.
- Always unplug the charger from the wall socket after the phone is fully charged to save unnecessary power consumption of the charger.
- Actual battery life will depend on network configuration, product settings, usage patterns, battery and environmental conditions.
- Make sure that no sharp-edged items such as animal's teeth or nails, come into contact with the battery. This could cause a fire.

Guidelines for safe and efficient use

DECLARATION OF CONFORMITY

Hereby, **LG Electronics** declares that this **LG-E460** product is in compliance with the essential requirements and other relevant provisions of Directive **1999/5/EC**. A copy of the Declaration of Conformity can be found at <http://www.lg.com/global/support/cedoc/RetrieveProductCeDOC.jsp>

Ambient temperatures

Max: +50°C (discharging), +45°C (charging)
Min: -10°C

Contact office for compliance of this product :

LG Electronics Inc.
EU Representative, Krijgsman 1,
1186 DM Amstelveen, The Netherlands

Notice: Open Source Software

To obtain the corresponding source code under GPL, LGPL, MPL and other open source licences, please visit <http://opensource.lge.com/>
All referred licence terms, disclaimers and notices are available for download with the source code.

Important notice

Please read this before you start using your phone!

Please check to see whether any problems you encountered with your phone are described in this section before taking the phone in for service or calling a service representative.

1. Phone memory

When there is less than 10% of space available in your phone memory, your phone cannot receive new messages. You need to check your phone memory and delete some data, such as applications or messages, to make more memory available.

To uninstall applications:

- 1 Touch  > **Apps** tab > **Settings** > **Apps** from the DEVICE.
- 2 Once all applications appear, scroll to and select the application you want to uninstall.
- 3 Touch **Uninstall**.

2. Optimizing battery life

Extend your battery's life between charges by turning off features that you don't need to have running constantly in the background. You can monitor how applications and system resources consume battery power.

Extending your phone's battery life:

- Turn off radio communications when you're not using. If you are not using Wi-Fi, Bluetooth or GPS, turn them off.
- Reduce screen brightness and set a shorter screen timeout.
- Turn off automatic syncing for Gmail, Calendar, Contacts and other applications.
- Some applications you have downloaded may reduce battery power.

Important notice

To check the battery power level:

- Touch  > **Apps** tab > **Settings** > **About phone** from the SYSTEM > **Battery**.

The battery status (charging or discharging) and battery level (percentage charged) is displayed at the top of the screen.

To monitor and control how battery power is being used:

- Touch  > **Apps** tab > **Settings** > **About phone** from the SYSTEM > **Battery** > **Battery use**.

Battery usage time is displayed on the screen. It tells you how long it has been since you last connected your phone to a power source or, if currently connected, how long the phone was last running on battery power. The screen shows the applications or services using battery power, listed in order from the greatest to smallest amount used.

3. Before installing an open source application and OS

WARNING

If you install and use an OS other than the one provided by the manufacturer it may cause your phone to malfunction. In addition, your phone will no longer be covered by the warranty.

WARNING

To protect your phone and personal data, only download applications from trusted sources, such as Play Store™. If there are improperly installed applications on your phone, the phone may not work normally or a serious error may occur. You must uninstall those applications and all associated data and settings from the phone.

4. Using an unlock pattern

Set an unlock pattern to secure your phone. Touch  > **Apps** tab > **Settings** > **Lock screen** from DEVICE > **Select screen lock** > **Pattern**. This opens a screen that will guide you through how to draw a screen unlock pattern. You have to create a Backup PIN as a safety measure in case you forget your unlock pattern.

Caution: Create a Google account before setting an unlock pattern and remember the Backup PIN you created when creating your pattern lock.

WARNING

Precautions to take when using pattern lock.

It is very important to remember the unlock pattern you set. You will not be able to access your phone if you use an incorrect pattern 5 times. You have 5 opportunities to enter your unlock pattern, PIN or password. If you have used all 5 opportunities, you can try again after 30 seconds.

When you can't recall your unlock Pattern, PIN or Password:

< If you have forgotten your pattern >

If you logged in to your Google account on the phone but failed to enter the correct pattern 5 times, press the **Forgot pattern?** button at the bottom of the screen. You are then required to log in with your Google Account or you have to enter the Backup PIN which you entered when creating your Pattern Lock.

If you have not created a Google account on the phone or you forgot Backup PIN, you have to perform a hard reset.

Important notice

< If you have forgotten your PIN or Password >

If you forget your PIN or Password, you will need to perform a hard reset.

Caution: If you perform a hard reset, all user applications and user data will be deleted.

NOTE: If you have not logged into your Google Account and have forgotten your Unlock Pattern, you will need to enter your Backup PIN.

5. Using the Hard Reset (Factory reset)

If your phone does not restore to its original condition, use a Hard Reset (Factory Reset) to initialize it.

- 1 Turn the power off.
- 2 Press and hold the **Power/Lock key + Volume Down key + QuickMemo function key**.
- 3 When the LG Logo appears on the screen, release all keys.

WARNING



If you perform a Hard Reset, all user applications, user data and DRM licenses will be deleted. Please remember to back up any important data before performing a Hard Reset.

6. Opening and switching applications

Multi-tasking is easy with Android because you can keep more than one application running at the same time. There is no need to quit an application before opening another one. Use and switch between several open applications. Android manages each application, stopping and starting them as needed to ensure that idle applications don't consume resources unnecessarily.

To stop applications:

- 1 Touch  > **Apps** tab > **Settings** > **Apps** from DEVICE > **RUNNING**.
- 2 Scroll and touch the desired application and touch **Stop** to stop it.

NOTE: For multitasking, press Home  key to move to another app while using an app. This does not stop the previous app running in the background on the device. Make sure to touch the Back  key to exit an app after using it.

7. Transferring music, photos and videos using Media sync (MTP)

- 1 Touch  > **Apps** tab > **Settings** > **Storage** from the DEVICE to check out the storage media.
- 2 Connect the phone to your PC using the USB cable.
- 3 A USB connection type list will appear on your phone screen, Select the **Media sync (MTP)** option.
- 4 Open the memory folder on your PC. You can view the mass storage content on your PC and transfer the files.
- 5 Copy the files from your PC to the drive folder or vice versa.

Important notice

8. Hold your phone upright

Hold your cell phone vertically, as you would a regular phone. Your phone has an internal antenna. Be careful not to scratch or damage the back of the phone, as this may affect performance.

When making/receiving calls or sending/receiving data, avoid holding the lower part of the phone where the antenna is located. Doing so may affect call quality.

9. When the screen freezes

If the screen freezes or the phone does not respond when you try to operate it:

Press and hold the **Power/Lock** key for 10 seconds to turn your phone off.

If it still does not work, please contact the service center.

Getting to know your phone

Phone overview

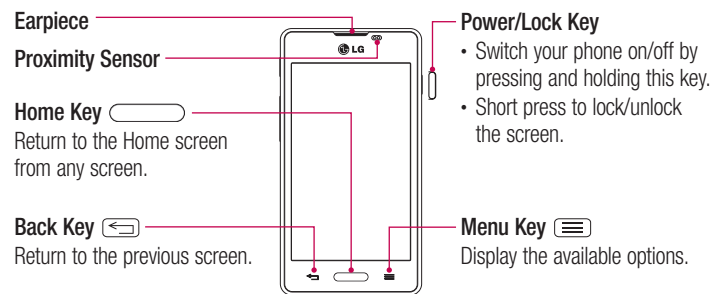

NOTE: Proximity sensor

When receiving and making calls, the proximity sensor automatically turns the backlight off and locks the touch screen by sensing when the phone is near your ear. This extends battery life and prevents you from unintentionally activating the touch screen during calls.

⚠ WARNING

Placing a heavy object on the phone or sitting on it can damage the LCD and touch screen functions. Do not cover the LCD proximity sensor with protective film. This could cause the sensor to malfunction.

Getting to know your phone

Volume keys

- In the Home screen: Control ringer volume.
- During a call: Control your earpiece volume.
- When playing a song: Control volume continuously.

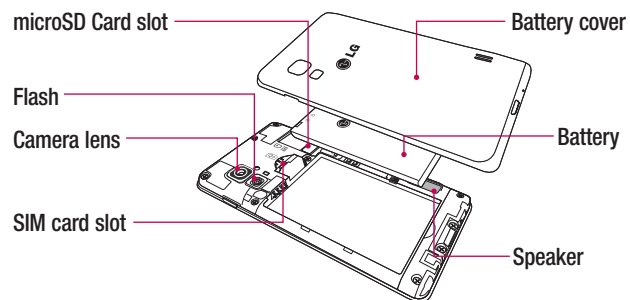
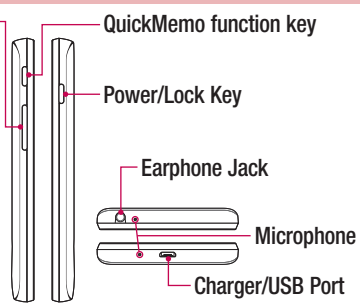

Installing the SIM card and battery

Before you can start exploring your new phone, you'll need to set it up. To insert the SIM card and battery:

- 1 To remove the battery cover, hold the phone firmly in one hand. With your other hand, lift off the battery cover with your index finger as shown in figure.

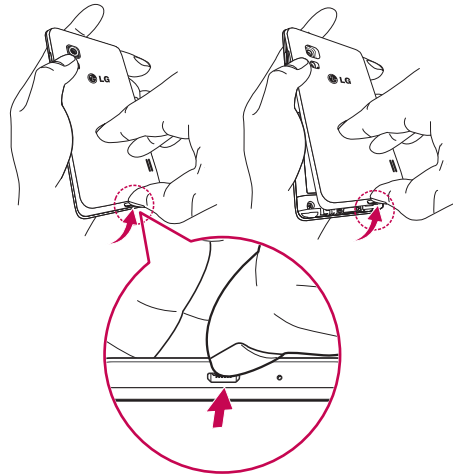

Getting to know your phone

- 2 Slide the SIM card into its respective slots as shown in the figure. Make sure the gold contact area on the card is facing downwards.

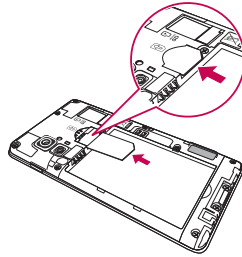

- 3 Insert the battery into place by aligning the gold contacts on the phone and the battery (1) and pressing it down until it clicks into place (2).

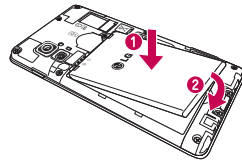

- 4 Align the battery cover over the battery compartment (1) and press it down until it clicks into place (2).

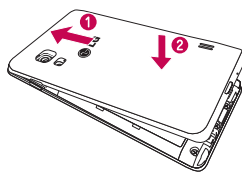

Charging the phone

The charger connector is at the bottom of the phone. Insert one end of the charging cable into the phone and plug the other end into an electrical outlet.

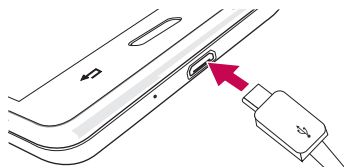

NOTE:

- The battery must be fully charged initially to improve battery lifetime.
- Do not open the battery cover while your phone is charging.

Using the memory card

Turn the phone off before inserting or removing the memory card. Remove the battery cover. Insert the memory card into the slot. Make sure the gold contact area is facing downwards.

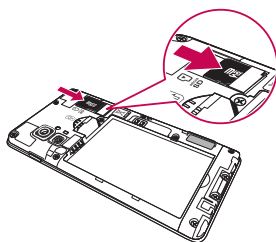

Getting to know your phone

Locking and unlocking the screen

If you do not use the phone for a while, the screen will be automatically turned off and locked. This helps to prevent accidental touches and saves battery power.

When you are not using your phone, press the **Power/Lock key**  to lock your phone.

If there are any programs running when you lock your screen, they may be still running in Lock mode. It is recommended that you exit all programs before entering Lock mode to avoid unnecessary charges (e.g. phone calls, web access and data communications).

To wake up your phone, press the **Power/Lock key** . The Lock screen will appear.

Touch and slide the Lock screen in any direction to unlock your Home screen. The last screen you viewed will open.

Your Home screen

Touch screen tips

Here are some tips on how to navigate on your phone.

Tap or touch – A single finger tap selects items, links, shortcuts and letters on the on-screen keyboard.

Touch and hold – Touch and hold an item on the screen by touching it and not lifting your finger until an action occurs. For example, to open a contact's available options, touch and hold the contact in the Contacts list until the context menu opens.

Drag – Touch and hold an item for a moment and then, without lifting your finger, move your finger on the screen until you reach the target position. You can drag items on the Home screen to reposition them.

Swipe or slide – To swipe or slide, quickly move your finger across the surface of the screen, without pausing when you first touch it (so you don't drag an item instead). For example, you can slide the screen up or down to scroll through a list, or browse through the different Home screens by swiping from left to right (and vice versa).

Double-tap – Double-tap to zoom on a webpage or a map. For example, quickly double-tap a section of a webpage to adjust that section to fit the width of the screen. You can also double-tap to zoom in and out when taking a picture (using the Camera), and when using Maps.

Pinch-to-Zoom – Use your index finger and thumb in a pinching or spreading motion to zoom in or out when using the browser, Maps or when browsing pictures.

Rotate the screen – From many applications and menus, the orientation of the screen adjusts to the device's physical orientation.

NOTE:

- To select an item, touch the center of the icon.
- Do not press too hard; the touch screen is sensitive enough to pick up a light, yet firm touch.
- Use the tip of your finger to touch the option you want. Be careful not to touch any other keys.

Your Home screen

Home screen

Simply swipe your finger to the left or right to view the panels. You can customize each panel with Apps, Downloads, Widgets and Wallpapers.

NOTE: Some screen images may be different depending on your phone provider.

On your Home screen, you can view menu icons at the bottom of the screen. Menu icons provide easy and one-touch access to the functions you use the most.



Touch the **Phone** icon to bring up the touch screen dialpad to make a call.



Touch the **Contacts** icon to open your contacts.



Touch the **Messaging** icon to access the messaging menu. This is where you can create a new message.



Touch the **Apps** icon at the bottom of the screen. This displays all of your installed applications. To open any application, simply touch the icon in the applications list.

Customizing the Home screen

You can customize your Home screen by adding apps, downloads, widgets or wallpapers. For more convenience using your phone, add your favorite apps and widgets to the Home screen.

To add items on your Home screen:

- 1 Touch and hold the empty part of the Home screen.
Or touch  at the top of the right side.
- 2 In the Add Mode menu, select the item you wish to add. You will then see this added item on the Home screen.
- 3 Drag it to the desired location and lift your finger.

To remove an item from the Home screen:

- **Home screen** > touch and hold the icon you want to remove > drag it to 

TIP! To add an application icon to the Home screen from the Apps menu, touch and hold the application you want to add.

TIP! Using folders

You can combine several app icons in a folder. Drop one app icon over another one on a Home screen, and the two icons will be combined.

Returning to recently-used applications

- 1 Touch and hold the **Home** key. The screen displays a pop-up containing the icons of applications you used recently.
- 2 Touch an icon to open the application. Or touch the **Back** key to return to your previous screen.

Notifications

Notifications alert you to the arrival of new messages, calendar events, and alarms, as well as to ongoing events, such as video downloads.

From the notifications panel, you can view your phone's current status and pending notifications.

When a notification arrives, its icon appears at the top of the screen. Icons for pending notifications appear on the left, and system icons showing things like Wi-Fi or battery strength on the right.

NOTE: The available options may vary depending on the region or service provider.

Your Home screen

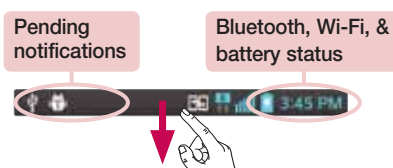

Swipe down for notifications & settings

Swipe down from the status bar to open the notifications panel. To close the notifications panel, swipe up the bar that is at the bottom of the screen.

NOTE: The available options may vary depending on the region or service provider.

Quick Settings

Use Quick Settings to easily toggle function settings like Wi-Fi, manage display brightness and more. For Quick Settings, swipe down from the status bar to open the notifications panel and swipe or touch for you desired setting.

To rearrange Quick Setting items on the notification panel

Touch . You can then check and rearrange items on the notification panel.



Indicator icons on the Status Bar





Indicator icons appear on the status bar at the top of the screen to report missed calls, new messages, calendar events, device status and more.



The icons displayed at the top of the screen provide information about the status of the device. The icons listed in the table below are some of the most common ones.

Icon	Description	Icon	Description
	No SIM card		Battery fully charged
	No signal		Battery is charging
	Airplane mode		Downloading data
	Connected to a Wi-Fi network		Uploading data
	Wired headset		GPS is acquiring
	Call in progress		Receiving location data from GPS
	Call hold		Data is syncing
	Speakerphone		New Gmail
	Missed call		New Google Talk message
	Bluetooth is on		New message
	System warning		Song is playing
	Alarm is set		Phone is connected to PC via USB cable or USB tethering is active
	New voicemail		Both USB tethering and portable hotspot are active

Your Home screen







Icon	Description	Icon	Description
	Ringer is silenced		Portable Wi-Fi hotspot is active
	Vibrate mode		P2P is on
	NFC is on		

NOTE: The icons location in the status bar may differ according to the function or service.

On-screen keyboard

You can enter text using the on-screen keyboard. The on-screen keyboard appears automatically on the screen when you need to enter text. To manually display the keyboard, simply touch a text field where you want to enter text.

Using the keypad & entering text

-  Tap once to capitalize the next letter you type. Double-tap for all caps.
-  Tap to switch to the numbers and symbols keyboard.
-  You can touch and hold this tab to view the Settings menu.
-  Tap to enter a space.
-  Tap to create a new line in the message field.
-  Tap to delete the previous character.

Entering accented letters

When you select French or Spanish as the text entry language, you can enter special French or Spanish characters (e.g. "á").

For example, to input "á", touch and hold the "a" key until the zoom-in key grows bigger and displays characters from different languages.

Then select the special character you want.

Google account setup

When you first turn on your phone, you have the opportunity to activate the network, to sign into your Google Account and select how you want to use certain Google services.

To set up your Google account:

- Sign into a Google Account from the prompted set-up screen.

OR

- Touch  > **Apps** tab > select a Google application, such as **Gmail** > select **New** to create a new account.

If you have a Google account, touch **Existing**, enter your email address and password, then touch .

Once you have set up your Google account on your phone, your phone automatically synchronizes with your Google account on the web.

Your contacts, Gmail messages, Calendar events and other information from these applications and services on the Web are synchronized with your phone. (This will depend on your synchronization settings.)

After signing in, you can use Gmail™ and take advantage of Google services on your phone.

Connecting to Networks and Devices

Wi-Fi

With Wi-Fi, you can use high-speed Internet access within the coverage of the wireless access point (AP). Enjoy wireless Internet using Wi-Fi, without extra charges.

Connecting to Wi-Fi networks

To use Wi-Fi on your phone, you need to access a wireless access point or 'hotspot'. Some access points are open and you can simply connect to them. Others are hidden or use security features, you must configure your phone to be able to connect to them. Turn off Wi-Fi when you're not using it to extend the life of your battery.

NOTE: If you are out of the Wi-Fi zone or have set Wi-Fi to **OFF**, additional charges may be applied by your mobile operator for mobile data use.

Turning Wi-Fi on and connecting to a Wi-Fi network

- 1 Touch  > **Apps** tab > **Settings** > **Wi-Fi** from the WIRELESS & NETWORKS tab.
- 2 Set **Wi-Fi** to **ON** and start scanning for available Wi-Fi networks.
- 3 Tap the Wi-Fi menu again to see a list of active and in-range Wi-Fi networks.
 - Secured networks are indicated by a lock icon.
- 4 Touch a network to connect to it.
 - If the network is secured, you are prompted to enter a password or other credentials. (Ask your network administrator for details)
- 5 The status bar displays icons that indicate Wi-Fi status.

Bluetooth

You can use Bluetooth to send data by running a corresponding application, but not from the Bluetooth menu as on most other mobile phones.

NOTE:

- LG is not responsible for the loss, interception or misuse of data sent or received via the Bluetooth wireless feature.
- Always ensure that you share and receive data with devices that are trusted and properly secured. If there are obstacles between the devices, the operating distance may be reduced.
- Some devices, especially those that are not tested or approved by Bluetooth SIG, may be incompatible with your device.

Turning on Bluetooth and pairing up your phone with a Bluetooth device

You must pair your device with another device before you connect to it.

- 1 Touch  > **Apps** tab > **Settings** > set **Bluetooth** to **ON** from the **WIRELESS & NETWORKS** tab.
- 2 Tap the **Bluetooth** menu again. You will see the option to make your phone visible and option to search devices. Now tap **Search for devices** to view the devices in the Bluetooth Range.
- 3 Choose the device you want to pair with from the list.

Once the pairing is successful, your device will connect to the other device.

NOTE: Some devices, especially headsets or hands-free car kits, may have a fixed Bluetooth PIN, such as 0000. If the other device has a PIN, you will be asked to enter it.

Connecting to Networks and Devices

Send data using the Bluetooth wireless feature

- 1 Select a file or item, such as a contact, calendar event or media file, from an appropriate application or from **Downloads**
- 2 Select the option for sending data via Bluetooth.

NOTE: The method for selecting an option may vary by data type.

- 3 Search for and pair with a Bluetooth-enabled device.

Receive data using the Bluetooth wireless feature

- 1 Touch  > **Apps** tab > **Settings** > set **Bluetooth** to **ON** and touch **Make phone visible** to be visible on other devices.

NOTE: To select the length of time that your device will be visible, touch  > **Visibility timeout**.

- 2 Select **Pair** to confirm that you are willing to receive data from the device.

Sharing your phone's data connection

USB tethering and portable Wi-Fi hotspot are great features when there are no wireless connections available. You can share your phone's mobile data connection with a single computer via a USB cable (USB tethering). You can also share your phone's data connection with more than one device at a time by turning your phone into a portable Wi-Fi hotspot.

When your phone is sharing its data connection, an icon appears in the status bar and as an ongoing notification in the notifications drawer.

For the latest information about tethering and portable hotspots, including supported operating systems and other details, visit <http://www.android.com/tether>.

To change Portable Wi-Fi hotspot settings:

- 1 Touch  > **Apps** tab > **Settings** > **More...** from the WIRELESS & NETWORKS tab > **Portable Wi-Fi hotspot** > choose options that you want to adjust.

TIP! If your computer is running Windows 7 or a recent distribution of some flavours of Linux (such as Ubuntu), you will not usually need to prepare your computer for tethering. But, if you are running an earlier version of Windows or another operating system, you may need to prepare your computer to establish a network connection via USB. For the most current information about which operating systems support USB tethering and how to configure them, visit <http://www.android.com/tether>.

To rename or secure your portable hotspot

You can change the name of your phone's Wi-Fi network name (SSID) and secure its Wi-Fi network.

- 1 On the Home screen, touch  > **Apps** tab > **Settings**.
- 2 Touch **More...** from the WIRELESS & NETWORKS tab and select **Portable Wi-Fi hotspot**.
- 3 Ensure that **Portable Wi-Fi hotspot** is checked.
- 4 Touch **Set up Wi-Fi hotspot**.
 - The **Set up Wi-Fi hotspot** dialogue box will open.
 - You can change the **Network SSID** (name) that other computers see when scanning for Wi-Fi networks.
 - You can also touch the **Security** menu to configure the network with Wi-Fi Protected Access 2 (WPA2) security using a pre-shared key (PSK).
 - If you touch the **WPA2 PSK** security option, a password field is added to the **Set up Wi-Fi hotspot** dialogue box. If you enter a password, you will need to enter that password when you connect to the phone's hotspot with a computer or other device. You can set **Open** in the **Security** menu to remove security from your Wi-Fi network.

Connecting to Networks and Devices

5 Touch **Save**.

ATTENTION! If you set the security option as Open, you cannot prevent unauthorised usage of online services by other people and additional charges may be incurred. To avoid unauthorized usage, you are advised to keep the security option active.

PC connections with a USB cable

Learn to connect your device to a PC with a USB cable in USB connection modes.

Transferring music, photos and videos using Media sync (MTP)

- 1 Connect your phone to a PC using a USB cable.
- 2 If you haven't installed the LG Android Platform Driver on your PC, you will need to manually change the settings. Choose **System settings > PC connection > USB connection type**, then select **Media sync (MTP)**.
- 3 You can now view the mass storage content on your PC and transfer the files.

Synchronize with Windows Media Player

Ensure that Windows Media Player is installed on your PC.

- 1 Use the USB cable to connect the phone to a PC on which Windows Media Player has been installed.
- 2 Select the **Media sync (MTP)** option. When connected, a pop-up window will appear on the PC.
- 3 Open Windows Media Player to synchronize music files.
- 4 Edit or enter your device's name in the pop-up window (if necessary).
- 5 Select and drag the music files you want to the sync list.

6 Start synchronization.





- The following requirements must be satisfied to synchronize with Windows Media Player.

Items	Requirement
OS	Microsoft Windows XP SP2, Vista or higher
Window Media Player version	Windows Media Player 10 or higher

- If the Windows Media Player version is lower than 10, install version 10 or higher.



Calls

Making a call

- 1 Touch  to open the keypad.
- 2 Enter the number using the keypad. To delete a digit, touch the .
- 3 Touch  to make a call.
- 4 To end a call, touch the **End** icon .

TIP! To enter “+” to make international calls, touch and hold .

Calling your contacts

- 1 Touch  to open your contacts.
- 2 Scroll through the contact list or enter the first few letters of the contact you want to call by touching **Search contacts**.
- 3 In the list, touch  to make the call.

Answering and rejecting a call

When you receive a call in Lock state, swipe the  in any direction to Answer the incoming call.

Swipe the  in any direction to Decline an incoming call.

Hold and slide the **Decline with message** icon from the bottom if you want to send a message.





TIP! Decline with message

You can send a message quickly using this function. This is useful if you need to reject a call with message during a meeting.

Adjusting the in-call volume



To adjust the in-call volume during a call, use the Volume up and down keys on the left-hand side of the phone.

Making a second call

- 1 During your first call, touch **Menu** key > **Add call** and dial the number. You can also go to the recently dialled numbers list by touching  or can search contacts by touching  and selecting the contact you want to call.
- 2 Touch  to make the call.
- 3 Both calls are displayed on the call screen. Your initial call is locked and put on hold.
- 4 Touch the displayed number to toggle between calls. Or touch  **Merge calls** to start a conference call.
- 5 To end active calls, touch **End** or touch the **Home** key, and slide down the notification bar and select the **End call** icon .

NOTE: You are charged for each call you make.

Viewing your call logs

On the Home screen, touch  and choose the **Call logs** tab .

View a complete list of all dialled, received and missed calls.



TIP!

- Touch any call log entry to view the date, time and duration of the call.
- Touch the Menu key , then touch **Delete all** to delete all the recorded items.

Calls

Call settings

You can configure phone call settings such as call forwarding, as well as other special features offered by your carrier.

- 1 On the Home screen, touch .
- 2 Touch .
- 3 Tap **Call settings** and choose the options that you wish to adjust.

Contacts

Add contacts to your phone and synchronize them with the contacts in your Google account or other accounts that support contact syncing.

Searching for a contact

On the Home screen

- 1 Touch  to open your contacts.
- 2 Touch **Search contacts** and enter the contact name using the keyboard.

Adding a new contact

- 1 Touch , enter the new contact's number, then touch the **Menu** key (). Touch **Add to Contacts > Create new contact**.
- 2 If you want to add a picture to the new contact, touch the image area. Choose from **Take photo** or **Select from Gallery**.
- 3 Select the contact type by touching .
- 4 Touch a category of contact information and enter the details about your contact.
- 5 Touch **Save**.

Favorite contacts



You can classify frequently called contacts as favorites.

Adding a contact to your favorites



- 1 Touch  to open your contacts.
- 2 Touch a contact to view its details.
- 3 Touch the star to the right of the contact's name. The star will turn yellow color.

Contacts

Removing a contact from your favorites list

- 1 Touch  to open your contacts.
- 2 Touch the  tab, and choose a contact to view its details.
- 3 Touch the yellow color star to the right of the contact's name. The star turns grey color and the contact is removed from your favorites.

Creating a group



- 1 Touch  to open your contacts.
- 2 Touch **Groups** and touch the **Menu** key . Select **New group**.
- 3 Enter a name for the new group. You can also set a ringtone for the newly created group.
- 4 Touch **Save** to save the group.

NOTE: If you delete a group, the contacts assigned to that group will not be lost. They will remain in your contacts.

Messaging

Your phone combines SMS and MMS into one intuitive, easy-to-use menu.

Sending a message

- 1 Touch  on the Home screen and touch  to open a blank message.
- 2 Enter a contact name or contact number in the **To** field. As you enter the contact name, matching contacts will appear. You can touch a suggested recipient. You can add more than one contact.

NOTE: You will be charged for a text message for every person you send the message to.

- 3 Touch the **'Enter message'** field and begin composing your message.
- 4 Touch  to open the Options menu. Choose from **Quick message**, **Insert smiley**, **Schedule sending** and **Add subject**.

TIP! You can touch the  icon to attach the file you want to share to your message.

- 5 Touch **Send** to send your message.
- 6 Responses will appear on the screen. As you view and send additional messages, a message thread is created.

WARNING

- The 160-character limit may vary from country to country, depending on the language and how the SMS is coded.
- If an image, video or audio file is added to an SMS message, it is automatically converted into an MMS message and you are charged accordingly.

Messaging

Threaded box

Unread messages (SMS, MMS) are located on the top.

And the others exchanged with another party can be displayed in chronological order so that you can conveniently see an overview of your conversation.

Changing your message settings

Your phone message settings are pre-defined, so you can send messages immediately. You can change the settings according to your preferences.

- Touch the **Messaging** icon on the Home screen, touch  and then tap **Settings**.

E-mail

You can use the E-mail application to read emails from services like Gmail. The E-mail application supports the following account types: POP3, IMAP and Exchange. Your service provider or system administrator can provide you with the account settings you need.

Managing an email account

The first time you open the **E-mail** application, a set-up wizard opens to help you to set up an email account.

After the initial set-up, E-mail displays the contents of your inbox. If you have added more than one account, you can switch among accounts.

To add another email account:

- Touch  > **Apps** tab > **E-mail** > touch  > **Accounts** > touch  > **Add account**.

To change an email account's settings:

- Touch  > **Apps** tab > **E-mail** > touch  > **Accounts** > touch  > **Entire settings**.

To delete an email account:

- Touch  > **Apps** tab > **E-mail** > touch  > **Accounts** > touch  > **Remove account** > touch an account you want to delete > **Remove** > select **Yes**.

Working with account folders



Touch  > **Apps** tab > **E-mail** > touch  and select **Folders**.

Each account has an Inbox, Outbox, Sent and Drafts folder. Depending on the features supported by your account's service provider, you may have additional folders.

Email

Composing and sending email

To compose and send a message

- 1 While in the **E-mail** application, touch the .
- 2 Enter an address for the message's intended recipient. As you enter text, matching addresses will be proposed from your Contacts. Separate multiple addresses using semicolons.
- 3 Touch the Cc/Bcc field to add a Cc/Bcc and Touch  to attach files, if required.
- 4 Enter the text of the message.
- 5 Touch .

If you aren't connected to a network, for example, if you're working in airplane mode, the messages that you send will be stored in your Outbox folder until you connect to a network again. If it contains any pending messages, the Outbox will be displayed on the **Accounts** screen.

TIP! When a new email arrives in your Inbox, you will be notified by a sound or vibration. Tap the email notification to stop receiving notifications.

Camera

To open the Camera application, tap **Camera**  on the Home screen.

Getting to know the viewfinder













- 1 **Cheese shutter** – This enables you to take a picture as voice command. Say "Cheese" when you get ready to take a photo.
- 2 **Brightness** – This defines and controls the amount of sunlight entering the image.
- 3 **Shot mode** – Choose from **Normal**, **Panorama** or **Continuous shot**.
- 4 **Flash** – Automatically turns on the flash when taking a photo in a dark place.
- 5 **Settings** – Touch this icon to open the Settings menu.
- 6 **Video mode** – Touch this icon to switch to video mode.
- 7 **Capture** – Takes a photo.
- 8 **Gallery** – Touch to view the last photo you captured. This enables you to access your gallery and view saved photos within camera mode.



NOTE: The memory capacity may differ depending on the shooting scene or shooting conditions.

Camera

Using the advanced settings

In the viewfinder, tap  to open the advanced options. You can change the camera settings by scrolling through the list. After selecting the option, tap the **Back** key.

	Touch if you want to change the viewfinder menu.
	Zoom in or out.
	Selects photo resolution. If you choose high resolution, file size will increase, which means you will be able to store fewer photos in the memory.
	Finds the appropriate color and light settings for the current environment.
	The ISO rating determines the sensitivity of the camera's light sensor. The higher the ISO, the more sensitive the camera. This is useful in darker conditions when you cannot use the flash.
	Improves color quality in various lighting conditions.
	Applies artistic effects to your pictures.
	Sets a delay after the capture button is pressed. This is ideal if you want to be in the photo.
	Activate this to use your phone's location-based services. Take pictures wherever you are and tag them with the location. If you upload tagged pictures to a blog that supports geotagging, you can see the pictures displayed on a map. NOTE: This function is only available when the GPS function is active.
	Selects a shutter sound.
	Automatically shows you the picture you just took.

	Restore all camera default settings.
	Select storage to save images.
	Touch this whenever you want to know how a function works. This icon will provide you with a quick guide.

TIP!

- When you exit the camera, some settings return to their defaults, such as white balance, color effect, timer and scene mode. Check these before you take your next photo.
- The setting menu is superimposed over the viewfinder, so when you change photo color or quality elements, you will see a preview of the changed image behind the Settings menu.



Taking a quick photo

- 1 Open the **Camera** application.
- 2 Holding the phone horizontally, point the lens towards the subject you want to photograph.
- 3 A focus box will appear in the center of the viewfinder screen. You can also tap anywhere on the screen to focus on that spot.
- 4 When the focus box turns green, the camera has focused on your subject.
- 5 Touch  to capture the photo.

Camera

Once you've taken a photo

Touch  to view the last photo you captured.

	Touch to take another photo immediately.
	Touch to send your photo to others or share it via social network services.
	Touch to delete the photo.

TIP! If you have an SNS account and set it up on your phone, you can share your photo with your SNS community.

NOTE: Additional charges may apply when MMS messages are downloaded while roaming.

Touch the **Menu key** () to open all advanced options.

Set image as – Touch to use the photo as a **Contact photo**, **Home screen wallpaper** or **Lock screen wallpaper**.

Move – Touch to move the photo to another place.





Copy – Touch to copy the selected photo and save it to another album.

Rename – Touch to edit the name of the selected photo.

Rotate left/right – To rotate left or right.

Crop – Crop your photo. Move your finger across the screen to select the area to be cropped.

Edit – View and edit the photo.

	Select photo resolution. If you choose high resolution, file size will increase, which means you will be able to store fewer photos in the memory.
	Improves color quality in various lighting conditions.
	Applies artistic effects to your photos.
	Applies additional options to your photos.

Slideshow – Automatically shows you the images in the current folder one after the other.

Details – Find out more information about the contents.

Viewing your saved photos

You can access your saved photos when in camera mode. Just tap the **Gallery** icon  and your Gallery will be displayed.

- To view more photos, scroll left or right.
- To zoom in or out, double-tap the screen or place two fingers and spread them apart (move your fingers closer together to zoom out).

Video camera

Getting to know the viewfinder











- 1 **Zoom** – Zoom in or zoom out.
- 2 **Video size** – Touch to set the size (in pixels) of the video you are recording.
- 3 **Brightness** – This defines and controls the amount of sunlight entering the video.
- 4 **Flash** – Allows you to turn on the flash when recording a video in dark conditions.
- 5 **Settings** – Touch this icon to open the settings menu.
- 6 **Camera mode** – Touch this icon to switch to camera mode.
- 7 **Record** – Starts recording.
- 8 **Gallery** – Touch to view the last video you recorded. This enables you to access your gallery and view your saved videos from within video mode.



NOTE: While recording a video, place two fingers on the screen and pinch to use the Zoom function.

Using the advanced settings

Using the viewfinder, touch  to open all the advanced options.

	Touch if you want to change the viewfinder menu.
	Improves color quality in various lighting conditions.
	Choose a colour tone to use for your new view.
	Activate this to use your phone's location-based services.
	Choose Off to record a video without sound.
	Auto review automatically shows you the video you just recorded.
	Select storage to save videos.
	Restore all video camera default settings.



Recording a quick video

- 1 Open the **Camera** application and touch the **Video mode** button.
- 2 The video camera viewfinder appears on the screen.
- 3 Hold your phone, point the lens towards the subject you wish to capture in your video.
- 4 Touch  once to start recording.
- 5 A red light will appear at the top left corner of the viewfinder with a timer showing the length of the video.
- 6 Touch  on the screen to stop recording.

Video camera

After recording a video

Touch  to view the last video you took.

	Touch to record another video immediately.
	Touch to send your video to others or share it via social network services.
	Touch to delete the video.

NOTE: Additional charges may apply when MMS messages are downloaded while roaming.

Watching your saved videos

- 1 In the viewfinder, tap .
- 2 Your Gallery will appear on the screen.
- 3 Tap a video to play it automatically.

Adjusting the volume when viewing a video

To adjust the volume of a video while it is playing, use the volume keys on the left side of the phone.

LG Unique Function

QuickMemo function

Use the **QuickMemo function** to practically and efficiently create memos during a call, with a saved picture or on the current phone screen.

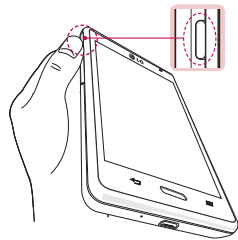

- 1 Enter the QuickMemo function screen by pressing **QuickMemo function** key.

OR



OR

Touch and slide the status bar downward and touch .



- 2 Select the desired menu option from **Pen type**, **Colour**, **Eraser** and create a memo.

LG Unique Function

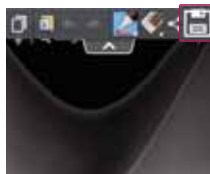







3 Touch  in the Edit menu to save the memo with the current screen.

NOTE: Please use a fingertip while using the QuickMemo function. Do not use your fingernail.

Using the QuickMemo options

You can easily use the QuickMenu options when using the QuickMemo function.

	Touch to keep the current memo on the screen and use the phone simultaneously.
	Selects whether to use the background screen or not.
	Undo or Redo.
	Selects the pen type and the colour.
	Erases the memo that you created.
	Touch to send your memo to others or share it via social network services.
	Saves the memo with the current screen in the Gallery .



Viewing the saved QuickMemo

Touch **Gallery** and select the QuickMemo album.

LG SmartWorld

LG SmartWorld offers an assortment of exciting content - games, applications, wallpaper and ringtones - giving LG phone users the chance to enjoy richer "Mobile Life" experiences.

How to Get to LG SmartWorld from Your Phone



- 1 Touch  > **Apps** tab > tap the  icon to access **LG SmartWorld**.
- 2 Tap Sign in and enter ID/PW for LG SmartWorld. If you have not signed up yet, tap Register to receive your LG SmartWorld membership.
- 3 Download the content you want.

NOTE: What if there is no icon?

- 1 Using a mobile Web browser, access LG SmartWorld (www.lgworld.com) and select your country.
- 2 Download the LG SmartWorld App.
- 3 Run and install the downloaded file.
- 4 Access LG SmartWorld by tapping the  icon.

How to use LG SmartWorld

- Participate in monthly LG SmartWorld promotions.

	Search content.
	Find content by category (e.g. Games, Education, Entertainment etc).
	List of downloaded/to-be updated content.

LG Unique Function

- Try the easy **Menu** buttons to find what you're looking for fast.
Apps for you – Recommended content based on your previous choices.
Settings – Set Profile and Display.
Sign in – Set your ID and Password.
- Try other useful functions as well. (Content Detail screen)

NOTE: LG SmartWorld may not be available from all carriers or in all countries.

Multimedia

Gallery

You can store multimedia files in internal memory for easy access to all your multimedia files. Use this application to view multimedia files like pictures and videos.

1 Touch  > **Apps** tab > **Gallery**.

Open a list of catalog bars that store your multimedia files.

NOTE:

- Some file formats are not supported, depending on the software installed on the device.
- Some files may not play properly, depending on how they are encoded.

Viewing pictures

Launching Gallery displays your available folders. When another application, such as Email, saves a picture, the download folder is automatically created to contain the picture. Likewise, capturing a screenshot automatically creates the Screenshots folder. Select a folder to open it.

Pictures are displayed by creation date in a folder. Select a picture to view it full screen. Scroll left or right to view the next or previous image.

Zooming in and out

Use one of the following methods to zoom in on an image:

- Double-tap anywhere to zoom in.
- Spread two fingers apart on any place to zoom in. Pinch to zoom out, or double-tap to return.

Playing videos

Video files show the  icon in the preview. Select a video to watch it and tap . The **Videos** application will launch.

Multimedia

Editing photos/videos

When viewing an photo/video, tap the **Menu** key (☰) and use the advanced editing options.

- **Slideshow:** Start a slideshow with the images in the current folder.

Deleting images

Use one of the following methods:

- In a folder, tap  and select photos/videos by ticking, and then tap on **Delete**.
- When viewing a photo/Video, tap .

Setting as wallpaper

When viewing a photo, touch the **Menu** key (☰) > **Set image as** to set the image as wallpaper or to assign it to a contact.

NOTE:







- Some file formats are not supported, depending on the device software.
- If the file size exceeds the available memory, an error can occur when you open files.

Videos

Your phone has a built-in video player that lets you play all of your favorite videos. To access the video player, touch  > **Apps** tab > **Videos**.

Playing a video

- 1 Touch  > **Apps** tab > **Videos**.
- 2 Select the video you want to play.

	Touch to pause video playback.
	Touch to resume video playback.
	Touch to go 10 seconds forward.
	Touch to go 10 seconds backward.
	Touch to manage the video volume.
	Touch to change the ratio of the video screen.
	Touch to lock a video screen.

To change the volume while watching a video, press the up and down volume keys on the left-hand side of the phone.



Touch and hold a video in the list. The **Share**, **Delete** and **Details** options will be displayed.

Music









Your phone has a built-in music player that lets you play all your favorite tracks. To access the music player, touch  > **Apps** tab > **Music**.

Playing a song

- 1 Touch  > **Apps** tab > **Music**.
- 2 Touch **Songs**.
- 3 Select the song you want to play.

	Touch to find the files with YouTube.
	Touch to set shuffle mode.
	Touch to set repeat mode.

Multimedia

	Touch to manage the music volume.
	Touch to pause playback.
	Touch to resume playback.
	Touch to skip to the next track on the album or in the playlist.
	Touch to go back to the beginning of the song. Touch twice to return to the previous song.
	Touch to set the favourites.
	Touch to see the current playlist.
	Touch to see all song list.

To change the volume while listening to music, press the up and down volume keys on the left-hand side of the phone.

Touch and hold any song in the list. The **Play**, **Add to playlist**, **Share**, **Set as ringtone**, **Delete**, **Details** and **Search** options will be displayed.

NOTE:

- Some file formats are not supported, depending on the device software.
- If the file size exceeds the available memory, an error can occur when you open files.
- Music file copyrights may be protected by international treaties and national copyright laws.
- Therefore, it may be necessary to obtain permission or a licence to reproduce or copy music.

In some countries, national laws prohibit private copying of copyrighted material. Before downloading or copying the file, check the national laws of the relevant country concerning the use of such material.

FM Radio



Your LG-E460 has a built-in FM radio so you can tune in to your favorite stations and listen on the go.

NOTE: You need to use your headphones to listen to the radio. Insert it into the headphone jack.

Searching for stations

You can tune in to radio stations by searching for them manually or automatically. They are then saved to specific channel numbers.

Tuning in automatically

- 1 On the Home screen, touch  > **Apps** tab > **FM Radio**.
- 2 Touch , then select **Scan**.
- 3 During auto scanning, touch **Cancel** if you want to stop scanning. Only scanned channels are saved before you stop scanning.



NOTE: You can also manually tune in to a station using the on-screen wheel.

NOTE: To improve radio reception, extend the headset cord as this also functions as the radio antenna.

If you connect a headset not specifically made for radio reception, radio reception may be poor.



Utilities

Setting your alarm



- 1 Touch  > **Apps** tab > **Alarm/Clock** > .
- 2 After you set the alarm, your phone lets you know how much time is left before the alarm will go off.
- 3 Set **Repeat**, **Snooze duration**, **Vibration**, **Alarm sound**, **Alarm volume**, **Auto app starter**, **Puzzle lock** and **Memo**. Touch **Save**.

NOTE: To change alarm settings in the alarm list screen, touch the **Menu** key  and select **Settings**.

Using your calculator

- 1 Touch  > **Apps** tab > **Calculator**.
- 2 Touch the number keys to enter numbers.
- 3 For simple calculations, touch the function you want to perform (+, -, x or ÷) followed by =.
- 4 For more complex calculations, touch , select the **Advanced panel**, then choose sin, cos, tan, log etc.
- 5 To check the history, tap the icon .

Adding an event to your calendar





- 1 Touch  > **Apps** tab > **Calendar**.
- 2 On the screen, you can find the different view types for the Calendar (Day, Week, Month, Agenda).
- 3 Tap on the date for which you wish to add an event and touch .
- 4 Touch **Event name** and enter the event name.
- 5 Touch **Location** and enter the location. Check the date and enter the time you wish your event to start and finish.

- 6 If you wish to add a note to your event, touch **Description** and enter the details.
- 7 If you wish to repeat the alarm, set **REPEAT** and set **REMINDERS**, if necessary.
- 8 Touch **Save** to save the event in the calendar.

Voice Recorder

Use the voice recorder to record voice memos or other audio files.

Recording a sound or voice

- 1 Touch  > the **Apps** tab and select **Voice Recorder**.
- 2 Touch  to begin recording.
- 3 Touch  to end the recording.
- 4 Touch  to listen to the recording.

NOTE: Touch  to access your album. You can listen to the saved recording. The available recording time may differ from actual recording time.

Tasks

This task can be synchronized with MS Exchange account. You can create task, revise it and delete it in MS outlook or MS Office Outlook Web Access.

To Synchronize MS Exchange

- 1 From the Home Screen, Touch  > **Settings**.
- 2 Touch **Accounts & sync** > **ADD ACCOUNT**.
- 3 Touch **Microsoft Exchange** to create Email address and Password.
- 4 Make sure if you checkmark Sync task.

Utilities

Polaris Viewer 4

Polaris Viewer let you view various types of electronic documents such as MS-Office, PDF, Text, etc.

- Touch  > **Apps** tab > **Polaris Viewer 4**.

Google+

Use this application to stay connected with people via Google's social network service.

- Touch  > **Apps** tab > **Google +**.

NOTE: This application may not be available depending on the region or service provider.

Voice Search

Use this application to search webpages using voice.

- 1 Touch  > **Apps** tab > **Voice Search**.
- 2 Say a keyword or phrase when **Speak now** appears on the screen. Select one of the suggested keywords that appear.

NOTE: This application may not be available depending on the region or service provider.

Downloads

Use this application to see what files have been downloaded through the applications.

- Touch  > **Apps** tab > **Downloads**.

NOTE: This application may not be available depending on the region or service provider.

The Web

Internet





Use this application to browse the Internet. Browser gives you a fast, full-color world of games, music, news, sports, entertainment and much more, right on your mobile phone wherever you are and whatever you enjoy.

NOTE: Additional charges apply when connecting to these services and downloading content. Check data charges with your network provider.

1 Touch  > **Apps** tab > **Internet**.

Using the Web toolbar

Touch and hold the Web toolbar and slide it upwards with your finger to open.

	Touch to go back one page.
	Touch to go forward one page, to the page you connected to after the current one. This is the opposite of what happens when you touch the Back key, which takes you to the previous page.
	Touch to go to the Home page.
	Touch to add a new window.
	Touch to access bookmarks.

Viewing webpages

Tap the address field, enter the web address and tap **Go**.

The Web

Opening a page

To go to new page, tap  > .

To go to another webpage, tap , scroll up or down, and tap the page to select it.

Searching the web by voice

Tap the address field, tap , speak a keyword, and then select one of the suggested keywords that appear.



NOTE: This feature may not be available depending on the region or service provider.

Bookmarks

To bookmark the current webpage, touch  > **Save to bookmarks** > **OK**.

To open a bookmarked webpage, tap  and select one.

History

Tap  > **History** to open a webpage from the list of recently-visited webpages. To clear the history, tap Menu  > **Clear all history**.

Chrome

Use Chrome to search for information and browse webpages.

1 Touch  > **Apps tab** > **Chrome**.

NOTE: This application may not be available, depending on your region and service provider.

Viewing webpages

Tap the Address field, and then enter a web address or search criteria.

Opening a page

To go to a new page, tap  > **+ New tab**.

To go to another webpage, tap , scroll up or down and tap the page to select it.

Searching the web by voice

Tap the address field, tap , speak a keyword and select one of the suggested keywords that appear.

Syncing with other devices

Sync open tabs and bookmarks to use with Chrome on another device when you are logged in with the same Google account.

To view open tabs on other devices, tap **Menu**  > **Other devices**.

Select a webpage to open.

To view bookmarks, tap .

Settings

Access the Settings menu

- 1 On the Home screen, touch  > **Apps** tab > **Settings**.
or
On the Home screen, touch  > **System settings**.
- 2 Select a setting category and select an option.

WIRELESS & NETWORKS

< Wi-Fi >

Wi-Fi – Turns on Wi-Fi to connect to available Wi-Fi networks.

TIP! How to obtain the MAC address

To set up a connection in some wireless networks with MAC filters, you may need to enter the MAC address of your phone in the router. You can find the MAC address in the following user interface: touch **Apps** tab > **Settings** > **Wi-Fi** >  > **Advanced** > **MAC address**.

< Bluetooth >

Turn the Bluetooth wireless feature on or off to use Bluetooth.

< Mobile data >

Displays the data usage and set mobile data usage limit.

< Call >

Configure phone call settings such as call forwarding and other special features offered by your carrier.

Fixed dialing numbers – Turn on and compile a list of numbers that can be called from your phone. You'll need your PIN2, which is available from your operator. Only numbers within the fixed dial list can be called from your phone.

Save unknown numbers – Add unknown numbers to contacts after a call.

Voicemail – Allows you to select your carrier's voicemail service.

Call reject – Allows you to set the call reject function. Choose from **Call reject mode** or **Rejection list**.

Decline with message – When you want to reject a call, you can send a quick message using this function. This is useful if you need to reject a call during a meeting.

Connection vibration – Vibrates your phone when the other party answers the call.

Privacy keeper – Hides the caller name and number for an incoming call.

Power button ends call – Allows you to select your end call.

Call forwarding – Choose whether to divert all calls when the line is busy, when there is no answer or when you have no signal.

Call barring – Lock incoming, outgoing or international calls.

Call duration – View the duration of calls including Last call, All calls, Dialed calls and Received calls.

Additional settings – Allows you to change the following settings:

- Caller ID:** Choose whether to display your number in an outgoing call.
- Call waiting:** If call waiting is activated, the handset will notify you of an incoming call while you are on a call (depending on your network provider).

< **More...** >

Airplane mode – After switching to airplane mode, all wireless connections are disabled.

Portable Wi-Fi hotspot – Allows you to share mobile network via Wi-Fi and you can configure portable Wi-Fi hotspot settings.

Bluetooth tethering – Allows you to set your phone whether you are sharing the Internet connection or not.

Settings

NFC – Your phone is an NFC-enabled mobile phone. NFC (Near Field Communication) is a wireless connectivity technology that enables two-way communication between electronic devices. It operates over a distance of a few centimeters. You can share your content with an NFC tag or another NFC support device by simply touching it with your device. If you touch an NFC tag with your device, it will display the tag content on your device.

To switch NFC on or off: From the Home screen, touch and slide the notification panel down with your finger, then select the NFC icon to turn it on.

NOTE: When airplane mode is activated, the NFC application can be used.

Using NFC: To use NFC, make sure your device is switched on, and activate NFC if disabled.

Android Beam – When this feature is turned on, you can beam app content to another NFC-capable device by holding the devices close together.

Just bring the device together (typically back to back) and then touch your screen. The app determines what gets beamed.

VPN – Displays the list of Virtual Private Networks (VPNs) that you've previously configured. Allows you to add different types of VPNs.

Mobile networks – Set options for data roaming, network mode & operators, access point names (APNs) etc.

NOTE: You must set a lock screen PIN or password before you can use credential storage.

DEVICE

< Sound >

Sound profile – Choose the Sound, either Vibrate only or Silent.

Volumes – Manage the volume of Phone ringtone, Notification sound, Touch feedback & system, Music, video, games and other media.

Quiet time – Set times to turn off all sounds except alarm and media.

Ringtone with vibration – Vibration feedback for calls and notifications.

Phone ringtone – Allows you to set your default incoming call ringtone.

Notification sound – Allows you to set your default notification ringtone.

Incoming call vibration – Allows you to set your default incoming call vibration.

Dial pad touch tones – Allows you to set the phone to play tones when using the dialpad to dial numbers.

Touch sounds – Allows you to set your phone to play a sound when you touch buttons, icons and other onscreen items that react to your touch.

Screen lock sound – Allows you to set your phone to play a sound when locking and unlocking the screen.

< Display >

Brightness – Adjust the screen brightness.

Screen timeout – Set the time for screen timeout.

Auto-rotate screen – Set to switch orientation automatically when you rotate the phone.

Font type – Change the type of display font.

Font size – Change the size of the display font.

Front touch key light – Set the front touch key light duration.

Home button LED – Select the item you wish to apply LED lighting.

Aspect ratio correction – Change the resolution size of downloaded applications to fit the screen size.

Settings

< Home screen >

Set the **Theme**, **Screen swipe effect**, **Wallpaper**, **Scroll screens circularly**, **Portrait view only** and **Home backup & restore**.

< Lock screen >

Select screen lock – Set a screen lock type to secure your phone. Opens a set of screens that guide you through drawing a screen unlock pattern. Set **None**, **Swipe**, **Pattern**, **PIN** or **Password**.

If you have enabled a Pattern lock type when you turn on your phone or wake up the screen, you will be asked to draw your unlock pattern to unlock the screen.

Wallpaper – Select the wallpaper for your lock screen from **Gallery** or **Wallpaper gallery**.

Clocks & shortcuts – Customize clocks & shortcuts on the lock screen.

Owner info – Show owner info on the lock screen.

Lock timer – Set the lock time after screen timeout.

Power button instantly locks – Set the screen lock when the power button is pressed.

< Storage >

PHONE STORAGE – View the internal storage usage.

SD CARD – Check total available SD card space. Touch Unmount SD card for safe removal. Erase SD card if you want to delete all data from the SD card.

< Battery >

Manage the battery and check the power saving items. You can also check the battery use.

< Apps >

View and manage your applications.

PERSONAL

< Accounts & sync >

Permits applications to synchronize data in the background, whether or not you are actively working in them. Deselecting this setting can save battery power and lower (but not eliminate) data usage.

< Location access >

Access to my location – If you select Google's location service, your phone determines your approximate location using Wi-Fi and mobile networks. When you select this option, you're asked whether you consent to allowing Google to use your location when providing these services.

GPS satellites – If you select GPS satellites, your phone determines your location to street-level accuracy.

Wi-Fi & mobile network location – Let apps use Google's location service to estimate your location faster. Anonymous location data will be collected and sent to Google.

< Security >

Set up SIM card lock – Set up SIM card lock or change the SIM PIN.

Password typing visible – Show the last character of the hidden password as you type.

Phone administrators – View or deactivate phone administrators.

Unknown sources – Default setting to install non-market applications.

Trusted credentials – Display trusted CA certificates.

Install from storage – Choose to install encrypted certificates.

Clear credentials – Remove all certificates.

Settings

< Language & input >

Use the Language & input settings to select the language for the text on your phone and to configure the on-screen keyboard, including words you've added to its dictionary.

< Backup & reset >

Change the settings for managing your settings and data.

Backup my data – Set to back up your settings and application data to the Google server.

Backup account – Set to back up your account.

Automatic restore – Set to restore your settings and application data when the applications are reinstalled on your device.

Factory data reset – Reset your settings to the factory default values and delete all your data. If you reset the phone this way, you are prompted to re-enter the same information as when you first started Android.

SYSTEM

< Hotkey customization >

Select apps you wish to get quick access to using hotkey.

< Date & time >

Use **Date & time** settings to set how dates will be displayed. You can also use these settings to set your own time and time zone rather than obtaining the current time from the mobile network.

< Accessibility >

Use the **Accessibility** settings to configure accessibility plug-ins you have installed on your phone.

NOTE: Requires additional plug-ins to become selectable.

< **PC connection** >

USB connection type – Set the desired mode: **Charge only**, **Media sync (MTP)**, **USB tethering**, **LG software** or **Camera (PTP)**.

Ask on connection – Ask in USB connection mode when connecting to a computer.

Help – Help for USB connection.

PC Suite – Checkmark this to use LG PC Suite with your Wi-Fi connection.

Help – Help for LG software.

< **Developer options** >

Keep in mind that turning on these developer settings may result in irregular device behavior. The developer options are recommended only for advanced users.

< **About phone** >

View legal information and check your phone status and software version.

PC software (LG PC Suite)

"LG PC Suite" PC software is a program that helps you connect your device to a PC via a USB cable and Wi-Fi. Once connected, you can use the functions of your device from your PC.

With your "LG PC Suite" PC Software, You Can...

- Manage and play your media contents (music, movie, picture) on your PC.
- Send multimedia contents to your device.
- Synchronizes data (schedules, contacts, bookmarks) in your device and PC.
- Backup the applications in your device.
- Update the softwares in your device.
- Backup and restore the device data.
- Play multimedia contents of your PC from your device.
- Backup and create and edit the memos in your device

NOTE: You can use the Help menu from the application to find out how to use your "LG PC Suite" PC software.

Installing "LG PC Suite" PC Software

"LG PC Suite" PC software can be downloaded from the webpage of LG.

- 1** Go to www.lg.com and select a country of your choice.
- 2** Go to **Support > MOBILE SUPPORT > LG Mobile Phones** > Select the Model
or
Go to **Support > Mobile** > Select the Model.
- 3** Click **PC SYNC** from **MANUALS & DOWNLOAD** and click **DOWNLOAD** to download "LG PC Suite" PC software.

System Requirements for "LG PC Suite" PC software

- OS: Windows XP (Service pack 3) 32bit, Windows Vista, Windows 7, Windows 8
- CPU: 1 GHz or higher processors
- Memory: 512 MB or higher RAMs
- Graphic card: 1024 x 768 resolution, 32 bit color or higher
- HDD: 500 MB or more free hard disk space (More free hard disk space may be needed depending on the volume of data stored.)
- Required software: LG integrated drivers, Windows Media Player 10 or later

NOTE: LG Integrated USB Driver

LG integrated USB driver is required to connect an LG device and PC and installed automatically when you install "LG PC Suite" PC software application.

Synchronizing your Device to a PC

Data from your device and PC can be synchronized easily with "LG PC Suite" PC software for your convenience. Contacts, schedules and bookmarks can be synchronized.

The procedure is as follows:

- 1** Connect your device to PC. (Use a USB cable or Wi-Fi connection.)
- 2** The **USB connection type** will appear, then select **LG software**.
- 3** After connection, run the program and select the device section from the category on the left side of the screen.
- 4** Click **Personal information** to select.
- 5** Select the checkbox of contents to synchronize and click the **Sync** button.

NOTE: To synchronize your phone with your PC using the USB cable, you need to install LG PC Suite onto your PC. Please refer to previous pages to install LG PC Suite.

PC software (LG PC Suite)

Moving contacts from your Old Device to your New Device

- 1 Export your contacts as a CSV file from your old device to your PC using a PC sync program.
- 2 Install "LG PC Suite" on the PC first. Run the program and connect your Android mobile phone to the PC using a USB cable.
- 3 On the top menu, select **Device > Import to device > Import contacts**.
- 4 A popup window to select the file type and a file to import will appear.
- 5 On the popup, click the **Select a file** and Windows Explorer will appear.
- 6 Select the contacts file to import in Windows Explorer and click the **Open**.
- 7 Click **OK**.
- 8 A **Field mapping** popup to link the contacts in your device and new contacts data will appear.
- 9 If there is a conflict between the data in your PC contacts and device contacts, make the necessary selections or modifications in LG PC Suite.
- 10 Click **OK**.

Phone software update

LG Mobile phone software update from the Internet

For more information about using this function, please visit <http://update.lgmobile.com> or <http://www.lg.com/common/index.jsp> → select your country and language.

This feature allows you to conveniently update the firmware on your phone to a newer version from the Internet without needing to visit a service center. This feature will only be available if and when LG makes a newer firmware version available for your device. Because the mobile phone firmware update requires the user's full attention for the duration of the update process, please make sure you check all instructions and notes that appear at each step before proceeding. Please note that removing the USB data cable during the upgrade may seriously damage your mobile phone.

NOTE: LG reserves the right to make firmware updates available only for selected models at its own discretion and does not guarantee the availability of the newer version of the firmware for all handset models.

LG Mobile Phone software update via Over-the-Air (OTA)

This feature allows you to conveniently update your phone's software to a newer version via OTA, without connecting using a USB data cable. This feature will only be available if and when LG makes a newer firmware version available for your device.

You should first check the software version on your mobile phone: **Settings > About phone > Software update > Check now for update.**

Phone software update

NOTE: Your personal data from internal phone storage—including information about your Google account and any other accounts, your system/application data and settings, any downloaded applications and your DRM licence—might be lost in the process of updating your phone's software. Therefore, LG recommends that you back up your personal data before updating your phone's software. LG does not take responsibility for any loss of personal data.

NOTE: This feature depends on your network service provider, region and country.

About this user guide

About this user guide

- Before using your device, please carefully read this manual. This will ensure that you use your phone safely and correctly.
- Some of the images and screenshots provided in this guide may appear differently on your phone.
- Your content may differ from the final product or from software supplied by service providers or carriers. This content may be subject to change without prior notice. For the latest version of this manual, please visit the LG website at www.lg.com.
- Your phone's applications and their functions may vary by country, region or hardware specifications. LG cannot be held liable for any performance issues resulting from the use of applications developed by providers other than LG.
- LG cannot be held liable for performance or incompatibility issues resulting from edited registry settings being edited or operating system software being modified. Any attempt to customize your operating system may cause the device or its applications to not work as they should.
- Software, audio, wallpaper, images and other media supplied with your device are licensed for limited use. If you extract and use these materials for commercial or other purposes is, you may be infringing copyright laws. As a user, you are fully are entirely responsible for the illegal use of media.
- Additional charges may be applied for data services, such as messaging, uploading and downloading, auto-syncing or using location services. To avoid additional charges, select a data plan to is suitable for your needs. Contact your service provider to obtain additional details.

Trademarks

- LG and the LG logo are registered trademarks of LG Electronics.
- All other trademarks and copyrights are the property of their respective owners.

Accessories

These accessories are available for use with the your phone. (Items described below may be optional.)

Travel adaptor



Battery



Stereo headset



Data cable

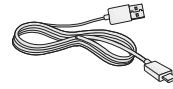

Quick Start Guide



NOTE:

- Always use genuine LG accessories.
- Failure to do this may void your warranty.
- Accessories may vary in different regions.

Troubleshooting

This chapter lists some problems you might encounter when using your phone. Some problems require you to call your service provider, but most are easy to fix yourself.

Message	Possible causes	Possible corrective measures
SIM error	There is no SIM card in the phone or it is inserted incorrectly.	Make sure that the SIM card is correctly inserted.
No network connection/ Dropped network	Signal is weak or you are outside the carrier network.	Move toward a window or into an open area. Check the network operator coverage map.
	Operator applied new services.	Check whether the SIM card is more than 6–12 months old. If so, change your SIM at your network provider's nearest branch. Contact your service provider.
Codes do not match	To change a security code, you will need to confirm the new code by re-entering it.	If you forget the code, contact your service provider.
	The two codes you have entered do not match.	

Troubleshooting

Message	Possible causes	Possible corrective measures
No applications can be set	Not supported by service provider or registration required.	Contact your service provider.
Calls not available	Dialling error	New network not authorized.
	New SIM card inserted.	Check for new restrictions.
	Pre-paid charge limit reached.	Contact service provider or reset limit with PIN2.
Phone cannot be switched on	On/Off key pressed too briefly.	Press the On/Off key for at least two seconds.
	Battery is not charged.	Charge battery. Check the charging indicator on the display.

Message	Possible causes	Possible corrective measures
Charging error	Battery is not charged.	Charge battery.
	Outside temperature is too hot or cold.	Make sure phone is charging at a normal temperature.
	Contact problem	Check the charger and its connection to the phone.
	No voltage	Plug the charger into a different socket.
	Charger defective	Replace the charger.
	Wrong charger	Use only original LG accessories.
Number not allowed	The Fixed dialling number function is on.	Check the Settings menu and turn the function off.
Impossible to receive / send SMS & photos	Memory full	Delete some messages from your phone.
Files do not open	Unsupported file format	Check the supported file formats.

Troubleshooting

Message	Possible causes	Possible corrective measures
The screen does not turn on when I receive a call.	Proximity sensor problem	If you use a protection tape or case, make sure it has not covered the area around the proximity sensor. Make sure that the area around the proximity sensor is clean.
No sound	Vibration mode	Check the settings status in the sound menu to make sure you are not in vibration or silent mode.
Hangs up or freezes	Intermittent software problem	Try to perform a software update via the website.



CE 0168 