

LG-E900 User Guide - English

Part 15.21 statement

" Change or Modifications that are not expressly approved by the manufacturer could void the user's authority to operate the equipment. "

Part 15.105 statement

This equipment has been tested and found to comply with the limits for a class B digital device, pursuant to Part 15 of the FCC Rules.

These limits are designed to provide reasonable protection against harmful interference in a residential installation. This equipment generates uses and can radiate radio frequency energy and, if not installed and used in accordance with the instructions, may cause harmful interference to radio communications. However, there is no guarantee that interference will not occur in a particular installation. If this equipment does cause harmful interference or television reception, which can be determined by turning the equipment off and on, the user is encouraged to try to correct the interference by one or more of the following measures:

- Reorient or relocate the receiving antenna.
- Increase the separation between the equipment and receiver.
- Connect the equipment into an outlet on a circuit different from that to which the receiver is connected.
- Consult the dealer or an experienced radio/TV technician for help.

Part 15 Class B Compliance

This device and its accessories comply with part15 of FCC rules and ICES-003 Class B digital apparatus requirements for Industry Canada.

Operation is subject to the following two conditions:

- (1) This device & its accessories may not cause harmful interference.
- (2) This device & its accessories must accept any interference received,
including interference that may cause undesired operation.

Body-worn Operation

This device has been tested for typical body-worn operations with the distance of 0.79inches (2.0cm) from the user's body.

To comply with FCC RF exposure requirements, a minimum separation distance of 0.79inches(2.0cm) must be maintained from the user's body.

Additionally, Belt clips, holsters & other body-worn accessories may not contain metallic components.

The Basics

This is the place to get started with your phone. Explore these topics to learn how to set up your phone and make it work the way you like.

Phone Overview

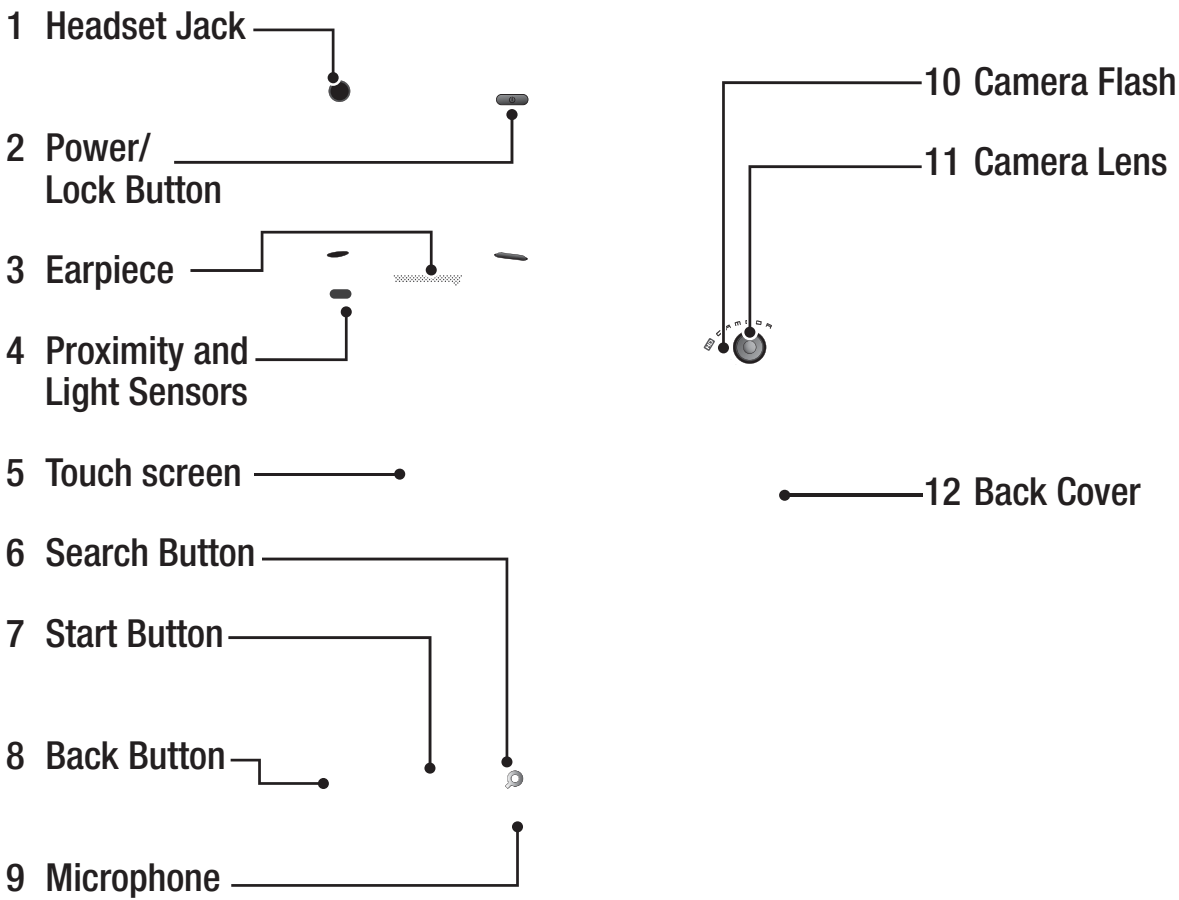

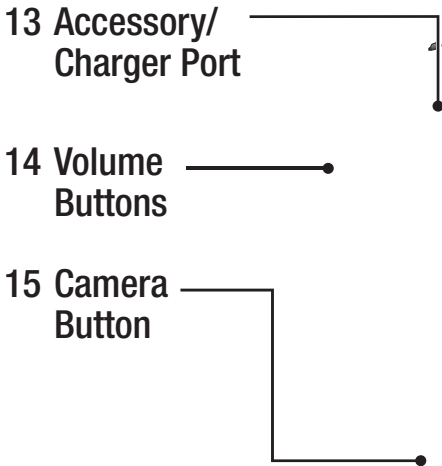

4 Proximity and Light Sensors senses proximity towards other objects (such as your head) so that touch commands are not accidentally activated during a call. The Light Sensors sense ambient light and adjust the screen backlight accordingly (if Automatic brightness is activated).

1 Headset Jack allows you to plug in an optional headset for convenient, hands-free conversations. The 3.5mm jack also allows you to plug in headphones to listen to music.

2 Power/Lock Button locks the screen. Press and hold to open the phone options menu (for the following options): Silent mode, Airplane mode, Mobile network mode, and Power off.

3 Earpiece lets you hear callers and automated prompts. Back Button returns to the previous screen. Also closes pop-up display items such as menus and dialog boxes.

5 Touch screen displays all the information needed to operate your phone, such as applications, call status, date, time, signal status, and battery strength.

6 Search Button opens Quick Search Box, from the Start screen, to search the phone and the web. In many applications, you may touch this button to search within the application itself. Touch twice to open the Quick

Search Box from any application.

- 7 Start Button** returns to the Start screen. If you're already viewing one of the Start screen extension panes, it opens the central Start screen pane. Press and hold the [Start] button to use the Voice recognition function.
- 8 Back Button** returns to the previous screen. Also closes pop-up display items such as **menus and dialog boxes**.
- 9 Microphone** transmits your voice to the other caller and to Voice-activated functions.
- 10 Camera Lens** use for taking pictures and recording videos. Keep clean for optimal performance.
- 11 Camera Flash** helps picture quality when taking pictures in low light conditions.
- 12 Back Cover** encloses the battery compartment.
- 13 Speaker** lets you hear ringtones and sounds. Also lets you hear the caller's voice when in speakerphone mode.
- 14 Volume Buttons** allow you to adjust the ringer and media volumes, or to

adjust the in-call volume during a call.

- 15 Accessory/Charger Port** allows you to connect the phone charger, USB cable, or other compatible accessories.
- 16 Camera Button** activates the camera. Once the Camera function is open, you can access the Video recorder function as well.

NOTES

- All screen shots in this guide are simulated. Actual displays may vary.
- Instructions to perform tasks in this guide are based on the default phone settings and may change depending on the software version on your phone.

Activating Your Phone

When you subscribe to a cellular network, you are provided with a SIM card that is loaded with your subscription details, such as your PIN, available optional services, and many others features.

Installing the SIM Card and Battery

- 1 If necessary, switch off the phone by holding [Power/Lock] button down until the power-off image displays.
- 2 Press the battery cover release button as shown in the image below(1).
- 3 Lift the cover away from the phone (2).



- 4 Place your thumbnail below the battery, as shown below (1), and lift it up and out (2) (as shown).

- 5 Carefully slide the SIM card into the SIM card socket as shown in the image below. Make sure that the card's gold contacts face downwards into the phone and that the upper-left angled corner of the card is positioned, as shown.

Removing the battery

Turn power off. Remove the battery cover (as demonstrated in the previous instructions). Then use the fingertip cutout to lift the top edge of the battery out.

Important: The SIM card and its contacts information can be easily damaged by scratching or bending, so be careful when handling, inserting, or removing the card. Keep all SIM cards out of reach of small children.

NOTES

- If the card is not inserted correctly, the phone will not detect the SIM card.
- If your phone does not connect to a network when you insert a SIM card and turn it on, please contact your service carrier to obtain the details of its access point name.

Understanding Your Phone

This section outlines some key features of your phone. It also displays the screen and the icons that display when the phone is in use.

Features of Your Phone

Windows Phone 7 has other hardware features available not previously mentioned, including:

- Bluetooth
- Camera flash
- Camera LED
- Micro SD
- Micro USB
- Wi-fi

Turning the Phone On and Off

Turning the phone on

- 1 Press and hold the [Power/Lock] button for a couple of seconds.

NOTE: When you turn on your phone for the first time, essential settings are going to be guided. Please follow the instructions on the screen to activate your device.

Turning the phone off

- 1 Press and hold the [Power/Lock] button.

To wake up the phone

If you don't use the phone for a while, the screen and backlight will shut off to conserve battery power.

To wake up the phone:

- 1 Press the [Power/Lock] button. Your Lock Screen will appear.
- 2 Simply touch and drag your finger up. The last screen you were working on opens.

NOTE: This is the default Lock Screen. Go to tap **SETTINGS > lock & wallpaper** for more detail settings like screen time-out.

To turn the phone sounds off

If you're in a place where your phone sounds may disturb others, you can quickly silence your phone from the lock screen.

- 1 Press the Volume [Up/Down] buttons to adjust the call volume. Plus, during an incoming call, if you press the [Volume Down] button, the ringtone will be muted.
- 2 Go to tap **SETTINGS > ringtones & sounds** for more detail settings.

Notification drawer

The notification drawer runs across the top of your screen. Touch and slide the notification drawer down with your finger. Or, on the home screen, touch Menu button and select Notifications. Here, you can check Wi-Fi and Bluetooth status as well as other notifications.





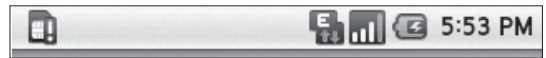

Viewing the status bar











The status bar uses different icons to display phone information, such as signal strength, new messages, battery life, and active Bluetooth and data connections.











Below is a table explaining the meaning of icons you're likely to see in the status bar.



[Status bar]

Icon	Description
	No SIM card
	No signal
	Wi-Fi is on and connected to an AP
	Wired headset
	Call forward
	Call hold

Icon	Description
	Speakerphone
	Call mute
	Missed call
	Bluetooth on
	Bluetooth connected
	System warning
	Alarm
	New voicemail
	Flight mode
	Silent
	Vibrate

Icon	Description
	No SD card
	Battery fully charged
	Battery is charging
	Data in
	Data out
	Data in and out
	USB to PC
	Download
	Upload
	GPS is acquiring
	GPS is on

Icon	Description
	Service message
	Setting message

Knowing and navigating the Start

Panoramic view on Start

Start is the beginning of the Windows Phone 7 experience for users after they power on their phone. Start displays application Tiles that users have pinned and placed in a position of their choosing for quick launch. Pressing the Start Button on the phone always returns a user to Start, no matter what application is running.

Simply swipe your finger to the left/right/up or down to view them. You can also customise tiles on the Start screen, which are shortcuts to your favourite menus, application and folders.

NOTE: Some screen images may be different depending on your phone provider.

Touch-screen tips

Here are some tips on how to navigate around your Windows Phone 7:

Single-touch:

- **Tap:** To choose a menu/ option or open an application, touch it.
- **Double Tap:** Double-tap to zoom a webpage or a map. For example, quickly double-tap a section of a webpage to zoom that section to fit the width of the screen.

- **Pan or Drag:** To scroll through a list or move slowly, drag across the touch screen.
- **Flick :** To scroll through a list or move quickly, flick across the touch screen (drag quickly and release).
- **Touch and Hold :** To open an options menu or grab an object you want to move, touch and hold it.

Multi-touch:

- **Pinch and Stretch:** Pinch and stretch provides continuous zoom on content with the center of the zoom located at the center of the two fingers.

Tiles on Start screen

A tile is an easily recognizable visual shortcut for an application or its content that users can set in an arbitrary location on the phone Start experience. Other than pre-installed application tiles, only the user can pin tiles to Start.

Adding your favourite tiles on Start

The tiles on Start screen provide easy, one-touch access to the functions you use the most.

You can pin all sorts of things to Start, including apps, websites, map locations, and even contacts. When you pin a contact to Start, you'll get all of that person's feed updates—right from that tile.

- To pin most things to Start, tap and hold the item until the menu appears, or open the app menu, then tap pin to start. For others, you can tap pin in the app bar at the bottom.
- If you'd like to move a tile somewhere else on Start, tap and hold the tile, and move it wherever you'd like it.
- To remove a tile, tap and hold it, and tap **unpin**.

Getting back to a recently used screen

- 1 Touch the [Back] button. The screen will show you the screen that you've used recently.

Navigating and Setting Application

Knowing an Application Bar

The Application Bar Menu is an optional way for users to access specific tasks from the Application Bar. The Application Bar Menu can be accessed by tapping the visual indicator of sequential dots in the Application Bar or by flicking the Application Bar up. This view can be dismissed by tapping outside of the menu area or on the dots, using the back button, or selecting a menu item or Application Bar Icon.

To prevent the menu from scrolling, the number of items displayed in the menu is limited to five.



Notes:

- A maximum of five menu items can be displayed.
- If no menu items are displayed, only the icon text hints are displayed.
- The Application Bar Menu will remain on the screen until the user performs an action.

How to get started

When you turn on your phone for the first time, essential settings are going to be guided. Please follow the instructions on the screen to activate your device.

These are based on recommended steps.

CHOOSE A LANGUAGE > WINDOWS PHONE SETTINGS > CHOOSE TIME ZONE > DATE & TIME

Step 1: Sign in with a Windows Live ID

To get application, play Xbox LIVE games, user a Zune Pass, automatically synchronise Windows Live information to the web and more, you need to sign in with a Windows LIVE ID.

A Windows Live ID is the email address you use to sign in to services like Xbox LIVE®, Zune®, Hotmail®, and so on. If you can't remember the email address you use:

For Xbox LIVE: On your Xbox 360® console, sign in with your gamer tag, then press the Guide button on your controller (the one in the middle that looks like the Xbox logo). In Settings, click **Account Management > Windows Live ID.**

For Zune: Sign in to the Zune software on your PC. Right-click your profile picture and click **Switch user** to see your Windows Live ID. To reset your password or get a reminder, go to <http://account.live.com/ResetPassword.aspx>.

Actual phone may differ from the image.

Step 2: Import your contacts

When you set up your email or Facebook account, your contacts are imported automatically into your People hub. And when you add Facebook, your friends' feeds appear in your People hub, their photos show up in your Pictures hub, and your own feeds pop up in your Me tile.

To set up a Facebook (or any kind of email) account:



- 1 Tap the arrow on Start to go to your App list.
- 2 Tap **Settings > email & accounts**.

Getting your contacts from your old phone is also easy. Put your old SIM card into your new phone, then go to **Settings**. Flick to applications, tap **people**, then tap **import SIM contacts**.

Communicating

Phone

Making a call

- 1 Touch **Phone** to open the Keypad icon [].
- 2 Enter the number on the keypad. To delete a digit, touch the Clear icon [].
- 3 Touch the Call icon [] to make a call.
- 4 To end a call, touch End call.

You can also place calls using the Phone Tile on start. You can dial calls

TIP! To enter “+” to make international calls, touch and hold down [0+] .

Calling your contacts

- 1 Touch People to open your contacts.
- 2 Scroll through the contact list or enter the first letter(s) of the contact you want to call by touching Search.
- 3 In the list, touch the contact you want to call, then select the number to use if there is more than one for that contact.

Answering and rejecting a call

When your phone rings, tap the answer tab to answer.

Tap **ignore** tab to reject an incoming call.

TIP! When the phone rings, touch and slide the Silent icon to the left if you want to switch to silent ringer mode.

Airplane mode (to disable wireless communication)

Some locations may require you to turn off your phone’s wireless connections by placing your phone in Airplane mode.

Tap **SETTINGS > system application > flight mode**. This features toggles your phone’s mobile, Wi-Fi, and Bluetooth radios simultaneously.

Adjusting call volume

To adjust the volume during a call, use volume up & down button on the left side of the phone.

Making a second call

- 1 During your initial call, Touch the [▶] then tap **add call** icon [+].
- 2 Call the number, or search your contacts using the **keypad** icon [⌨] or **people** icon [👤].
- 3 Touch the call icon to connect the call.
- 4 Both calls will be displayed on the call screen. Your initial call will be locked and put on hold.
- 5 Touch PRESS TO SWAP on the top of the screen to toggle between calls.
- 6 To end active calls, touch **end call**.
If there is no active call, it will end the Hold call.

NOTE: You will be charged for each call you make.

Viewing your call history

On the Start screen, press the **Phone** Tile [📞] to view Call log.

View a complete list of all dialed, received, and missed voice calls.

TIP! Touch any single call log entry to view the date, time, and duration of the call.

TIP! Tap the **Application Bar** tab, then touch **delete all** to delete all the recorded items.

Call settings

You can configure phone call settings, such as call forwarding, call waiting, and other special features offered by your carrier.

- 1 On the Start screen, touch **Phone** Tile.
- 2 Tap the **Applications bar** on the below of the call history screen, to open the **Call Setting menu**.
- 3 Scroll and tap call settings. and choose options that you want to adjust.

Voicemail number - Edits the Voicemail number

Show my caller ID to - Choose whether to display your number on an outgoing call.

Call forwarding - You can configure how your calls are forwarded when you're on the phone, when you don't answer, and so on. Then enter the number to forward to.

international assist- It will help automatically correct some common mistakes while dialing internationally or dialing while abroad.

Searching for a contact

There are two ways to search for a contact:

On the Start screen

- 1 On the home screen, touch the **People** Hub Tile to open your contacts (People hub).
- 2 Touch Search icon and enter the contact name using the keypad.

TIP! To search by group, touch the **Contacts** tab at the top of the screen and select **Groups**. This will display a list of all your groups.

From the main menu

- 1 On the Start screen, touch [→] tab to go the applications menu.
- 2 Touch the People and select the desired profile.

Adding a new contact

- 1 On the Start screen, touch People application, then touch [+] icon on the People screen.
- 2 If you want to add a picture to the new contact, touch **add photo** tile.

You can use a saved picture or take a new one.

- 1 On the home screen, touch Contacts, then touch New contact.
- 2 If you want to add a picture to the new contact, touch [].
You can use a saved picture or take a new one.
- 3 Touch the desired item and tap a text field to open the touch keyboard.
- 4 Touch **Done** icon to save the current added information.

- 5 Touch a category of contact information and enter the details about your contact.
- 6 Touch save icon to save the Contact

TIP! Tap the **Application Bar** tab, then touch delete all to delete all the recorded itmes.

Favourite Contacts

You can classify frequently called contacts as favourites.

To add a contact to your Favourites (Pin to Start)

- 1 On the Starts creen, touch **People** to open your profile contacts.,
- 2 Touch a contact to view its details.
- 3 Touch the pin icon [] on the application menu, and then your favourite contact pins to Start screen.

Messaging/E-mail

Messaging

Your Windows phone combines SMS and MMS into one intuitive, easy-touse menu.

Sending a message

- 1 Tap the arrow -> on Start to go to your App list and tap **messaging** application. Or, you can also tap **messaging** tile on Start screen.
- 2 Tap **new** icon [+] to open a blank message.
- 3 Enter a mobile phone number in the To field. As you enter the phone number, matching contacts appear. You can touch a suggested recipient or continue entering the phone number. You can add multiple contacts.

NOTE: You will be charged for a text message for every person you send the message to.

- 4 Touch the message box below to start entering your message.

- 5 Touch the options menu area on the bottom of the screen. Choose and the desired file like favorites pictures and so on.
- 6 Touch send icon [] to send your message.
- 7 The message screen opens, with your message after your name. Responses appear on the screen. As you view and send additional messages, a message thread is created.

Entering text

Keypad



T9 mode

The T9 mode uses a built-in dictionary to recognise the words you're writing based on the sequence of keys you've touched. It predicts the word you are inputting and suggests alternatives.

Entering accented letters

When you select French or Spanish as the text entry language, you can enter special French or Spanish characters (e.g., "á").

After the corresponding letter character disappears, press the same button repeatedly until you see the special character you want.

Example

To input “a”, press and hold the “a” button.

After the letter “a” disappears, press the “a” button repeatedly until “a” is displayed on the screen.

Enter special characters by pressing the letter continuously.

Setting up your email

Keep in touch while on the move by using your Windows Phone to send emails. It's quick and simple to set up a POP3 or IMAP4 email account.

- 1 Tap the arrow -> on Start to go to your App list and tap Email (ex. Hotmail) application. Or, you can also tap the Email (ex. Hotmail) tile on Start screen.
- 2 If the email account is not set up, start the email setup wizard.

TIP! If an email account is already set up, the wizard is not activated automatically

Sending an email using your new account

- 1 Tap the **Email** (ex. Hotmail) tile on Start screen, and then touch **new** icon [] to open a new blank message.
- 2 Enter the recipient's address, then write your message. You can also attach images, videos, audio files, and various document file formats.
- 3 Touch **send** icon [] to send your email.

TIP! During an active Wi-Fi connection, emails are sent and received using Wi-Fi.

Retrieving your email

You can automatically or manually check your account for new email.

To check manually:

- 1 Tap the arrow [→] on Start to go to your App list and tap Email application. Or, you can also tap the Email tile on Start screen, and which is the account you want to use, like Hotmail, gmail, and so on.
- 2 Choose **synchronise** and your Windows phone will then connect to your email account and retrieve your new messages.

Changing your email account's settings

You can change your email settings based on your own preferences.

- 1 Touch Email tile on the home screen, and tap the desired account.
- 2 Tap the arrow [→] on Start to go to your App list and tap Email application. Or, you can also tap the Email tile on Start screen.

- 3 Touch the Application bar on the bottom of screen to open the options menu, and tap add email account.

You can also adjust the following options using advanced setup: **Account Setup, General Settings, Download Options, and Spam message.**

Social Networking

With your phone, you can enjoy the social networking and manage your micro-blog in on-line communities. You can update your current status and view your friends' status updates real-time.

You can add your Facebook, Twitter or Bebo accounts to your phone. If you don't have an account, you can visit their sites to set it up.

NOTE: An additional costs may be incurred when connecting and using online services. Check your data charges with your network provider.

Adding your account to your phone

- 1 Tap the arrow [→] on Start to go to your App list.
- 2 Tap **Settings > email & accounts**.
- 3 Touch Add account to add a social networking account.
- 4 Select the kind of account to add.
- 5 Enter your e-mail address and password that you set up on your community, then tap Log in.
- 6 Wait for checking your account.
- 7 Check your community is turned ON. If you tap your community, you can see the current status of your social community.

TIP! If you add a social networking widget on your home screen, the widget will be show your status when your phone updates from the network. Without logging in to an application, get everyone's updates, posts and photos – all together, all the time, and always up to date.

You can also access the social community directly by touching up the widget.

Viewing and updating your status

- 1 Choose a community you want to access.
- 2 The community home will be appear. You can see the current status of your social community.
- 3 If you want to update your status, tap Status and write the current status, then touch Share.

NOTE: This is dependent on network services.

Removing accounts on your phone

- 1 Tap the arrow [→] on Start to go to your App list.
- 2 Tap **Settings > email & accounts**.

Camera

- **Video mode** - Slide down this icon to switch to video mode.
- **Zoom** - Zoom in or zoom out. Alternatively you can use the side volume buttons.
- **Settings** - Touch this icon to open the settings menu. See Using the advanced settings.

Brightness - This defines and controls of the amount of sunlight entering the image.

Photo Resolution - Touch to set the size (in pixels) of the picture you take. Select a pixel value from the numerical options

Color effect

Quality

Anti-shake

Note : You need to insert a memory card first to take a picture. Without inserting a memory card, you will not be able to save the picture you had taken.

Getting to know the viewfinder

Intelligent shot

Beauty shot

Panorama shot

Scan search

Photo resolution

Taking a quick photo

- 1 Press and hold the camera button on the right side of the phone.
- 2 Holding the phone horizontally, point the lens towards the subject you want to photograph.
- 3 Press the capture button lightly, and a focus box will appear in the centre of the viewfinder screen.
- 4 Position the phone so you can see the subject in the focus box.
- 5 When the focus box turns green, the camera has focused on your subject.
- 6 Press the capture button and hold it down.

NOTE: Activate the GEG tagging! Activate to use your phone's location-based services. Take pictures wherever you are and tag them with the location. If you upload tagged pictures to a blog that supports geotagging, you can see the pictures displayed on a map.

Once you've taken the photo

Swipe your finger left or right to change the Camera Record mode and Photo Play back mode.

On your Playback screen, double-tap on the left application bar.

Add to favourites

Delete - Touch this to delete the image.

Touch to take another photo immediately.

Upload to SkyDrive

Share... - Touch this share your photo as Bluetooth, Email, Messaging, Facebook, Picasa or SNS.

Use as wall paper- Use the image as Contact icon, Lock, screen or Wallpaper.

NOTE: Additional charges may apply when MMS messages are downloaded while roaming.

Viewing your saved photos

- 1** You can access your saved photos from within the camera mode. Just touch and your gallery will appear on the screen

Video camera

Getting to know the viewfinder

Video resolution - Touch to set the size (in pixels) of the video you record. Choose your video image size from 4:3 standard VGA (640x480), 4:3 standard QVGA (320x240) or 16:9 wide HD 720p(1280x720).

Brightness - This defines and controls of the amount of sunlight entering the image.

White balance - The white balance ensures any the white areas in your video are realistic.

To enable your camera to adjust the white balance correctly, you may need to determine the light conditions. Choose from Auto, Incandescent, Sunny, Fluorescent, and Cloudy.

Color effect - Choose a colour tone to use for your new view.

Quality

Shooting a quick video

- 1 Press and hold the camera button on the right side of the phone.
- 2 Then, switch to Video icon [].
- 3 The video camera's viewfinder will appear on the screen.
- 4 Holding the phone horizontally, point the lens towards the subject of the video.
- 5 Press the capture button once to start recording.
- 6 REC will appear at the bottom of the viewfinder with a timer showing the length of the video.
- 7 Touch on the screen to stop recording.

NOTE: You cannot control the zoom function during recording.

Watching your saved videos

- 1 In the viewfinder, slide Camera icon and Video icon.
- 2 Your gallery will appear on the screen.
- 3 Touch a video once to bring it to the front of the gallery. It starts to play automatically.

Your photos and videos

Viewing your photos and videos

- 1 Touch on the camera preview screen.
- 2 Your gallery will appear on the screen.
- 3 Touch the video or photo to open it fully.

TIP! Flick left or right to view other photos or videos.

Adjusting the volume when viewing a video

To adjust the volume of a video while it is playing, use the volume buttons on the left side of the phone.

Setting a photo as wallpaper

- 1 Touch the photo you want to set as wallpaper to open it.
- 2 Touch the screen to open the options menu.
- 3 Touch **Use as**, then touch **Set Wallpaper**.

Frame - Add frames to the photo.

Multimedia

You can store multimedia files to a memory to have easy access to all your image and video files.

1 Tap the arrow [→] on Start to go to your App list and tap **Pictures** application. Or, you can also tap the **Pictures** tile on Start screen.

2 Select **all, date, favorites**. You can open a list of catalogue bars that store all your multimedia files.

NOTE: Make sure you install a memory card into the phone to save photos and access all your pictures.

Without a memory card, the phone will not display any photos or videos.

There are five catalogue bars as shown below.

All : Displays all your pictures and videos.

Date: Gallery provides a timeline view of your photos and videos. On the left side of the screen, the date you took your photos will be displayed, from oldest to newest. If you select a specific date, all the photos you took on that day will be grouped over a white background.

Favourites : If you touch and hold a photo or video, the option screen will appear allowing you to tag the photo as a favourite.

This Favourite bar will show your favourite photos and videos.

My Images options menu

Select a photo, then touch and hold to see the available options.

Sending a photo

- 1 To send a photo, touch and hold the photo you want.
- 2 Double-tap the bottom of the screen to open the menu option .
- 3 Select **Share** and when you choose **Media Sharing** or **Messaging**, your photo will be attached to a message, then you write and send the message normally.

TIP! If you have a SNS account and set it up on your phone, you can share your photo to SNS community.

Media Player

The Media Player folder displays a list of videos you downloaded to or recorded on your phone.

Watching a video

- 1 Select **Media Player** on the Applications tab.
- 2 Touch **Video** and select a video to play.

TIP! The WINDOWS PHONE supports DivX video playback to ensure greater content availability.

Touch **Music** and select a music to play. You can play songs, categorise songs by Album and Artist, or create a Playlist.

Music Movie

- 1 Flip left and right to check the various styles. For Music Movie, you can select only photos.



 – Return to the Video editor screen.

 – Display the style name and description.

 – Preview the style.

 – Touch to select photos.

2 After you select photos, touch  to proceed to the next step.

3 Touch  to select all the photos, then touch .

4 Select the music, then set it as the background music.

5 Add movie title using the keypad, then save it.

6 Touch  to play the complete video file.

7 Touch  to save the video file you created.

Playing a game

1 The WINDOWS PHONE provides a number of games. You can download more games from Market.

2 Touch the **Launch** button to launch a game or an application.

NOTE: Additional charges may apply when using this service to download games or applications that are not free.

NOTE: Java game and application installation are only possible through the Web.

Transferring files using USB mass storage devices

To transfer files using USB devices:

- 1 Connect the WINDOWS PHONE to a PC using a USB cable.
- 2 Choose **Settings > SD Card & Phone Storage > Activate Mass Storage Only**.
- 3 In the status bar, drag the USB icon.
- 4 Choose USB Connected and Mount.
- 5 You can view the mass storage contents on your PC and transfer the files.

NOTE: You need to install and SD card first. Without an SD card, you cannot use USB mass storage.

Music

Your WINDOWS PHONE has a built-in music player that lets you play all your favourite tracks.

To access the music player

- 1 Tap the arrow [→] on Start to go to your App list and tap **Music & Video** application. Or, you can also tap **Music & Video** tile on Start screen.
- 2 Tap music on the Zune list.

Using the radio

Your WINDOWS PHONE has a built-in FM radio so you can tune in to your favourite stations and listen on the go.

NOTE: You must attach your headphones to listen to the radio. Insert them into the headphone jack.

- 1 Tap the arrow [→] on Start to go to your App list and tap **Music & Video** application. Or, you can also tap **Music & Video** tile on Start screen.
- 2 Tap **radio** on the Zune list.

Searching for stations

You can tune in to radio stations by searching for them manually or automatically. They will then be saved to specific channel numbers, so you don't have to keep re-tuning in.

You can store up to 48 channels on your phone.

To tune in automatically

- 1 On the home screen, touch Applications tab and select **FM radio**.
- 2 Touch the Menu button.
- 3 Touch **Auto Scan**, then touch **Yes**. Assign the stations found to channel numbers by selecting Set, Skip, or Stop.

NOTE: You can also manually tune in to a station using the wheel displayed next to the radio frequency.

Resetting channels

- 1 On the home screen, touch Applications tab and select **FM radio**.
- 2 Choose **Reset Channel** to reset the current channel, or choose **Reset All Channels** to reset all the channels.

Listening to the radio

- 1 On the home screen, touch Applications tab and select **FM radio**.
- 2 Touch the channel number of the station you want to listen to.

WARNING: If you connect a headset not specifically made for radio reception, radio reception may be poor.

TIP! To improve radio reception, extend the headset cord, which functions as the radio antenna.

Windows applications

- 1 First, set up a Windows account. Enter your user name and password.
- 2 After signing in, your contacts, email, and calendar in your Windows account will automatically synchronise with your WINDOWS PHONE.

Tip! If you change your Windows Live ID account after signing in, or you want to log out, please use the below step:

Applications > Settings > Applications > Manage applications > Windows Live ID Apps > Clear data.

Windows Live ID Maps

Check your current location and traffic and receive directions to your destination. The WINDOWS PHONE must be connected to Wi-Fi or 3G/GPRS.

NOTE: Windows Live ID Maps does not cover all cities and countries.

NOTE: While viewing Street View for a location, Touch the Menu button then touch Compass Mode to turn compass mode on.

Windows Market

Windows Market lets you download useful applications and games. If you install applications and games from Windows Market, they appear in the WINDOWS PHONE menu.

You can post comments about an application or flag it if you find it is incompatible with the WINDOWS PHONE.

- 1 Tap the arrow [→] on Start to go to your App list and tap **Music & Video** application. Or, you can also tap **Music & Video** tile on Start screen.
- 2 Tap marketplace on the Zune list.

NOTE: When you want to finish the game, use the [Home] or [Back] button. You will return to the home screen. Or use the [Menu] button of the game.

Windows Mail

Windows Mail is configured when you first set up your phone. Depending on your synchronization settings, Windows Mail on your phone is automatically synchronised with your Windows account on the web.

The inbox conversations list is your default Windows Mail view.

Touch the Menu button, then touch Refresh to send or receive new emails and to synchronise your emails with your Windows account on the web.

Windows messenger

Windows Messenger is Windows's instant messaging program. It lets you communicate with other people who also use Windows Messenger.

Utilities

Setting your alarm

- 1 Tap the arrow [→] on Start to go to your App list and tap **Alarms** application.
- 2 If you want to add a new alarm, tap add icon [+] on the bottom option menu bar. There are preset alarms you can activate.
- 3 Touch to checkmark to turn on the alarm, and set the time you want the alarm to sound.
After you set the time, the WINDOWS PHONE will let you know how much time is left before the alarm sounds.
- 4 Choose a ringtone, and turn on Vibrate, if you want. Set the repeat. The icons indicate the weekday you select.

NOTE: You can delete all the alarms by touching the delete icon on the bottom option menu bar.

Using your calculator

- 1 Tap the arrow [→] on Start to go to your App list and tap **Calculator** application.
- 2 Touch the number buttons to enter numbers.
- 3 For simple calculations, touch the function you want (+, −, x, or ÷), followed by =.
- 4 For more complex calculations, touch the Menu button, touch the Advanced panel, then choose sin, cos, tan, log, and so on.

Adding an event to your calendar

- 1 Tap the arrow [→] on Start to go to your App list and tap **Calendar** application.
- 2 First, you must create a Windows account to use Calendar.
- 3 Select the date you want to add an event to.
- 4 Touch the Menu button, then touch **New event**.
- 5 Touch **What**, then enter the event name. Check the date and enter the

time you want your event to begin. Enter the time and date the event finishes in the lower date and time boxes.

- 6 Also, touch **Where**, then enter the location.
- 7 If you would like to add a note to your event, touch **Description** and enter the details.
- 8 If you want to repeat the alarm, set Repetition, and set Reminders, if necessary.
- 9 Touch **Save** to save the event in the calendar. A coloured square in the calendar will mark all days that have saved events. An alarm will sound at the event start time to help you stay organised.

Changing your default calendar view

- 1 On the home screen, touch Applications tab and select **Calendar**. Touch the Menu button.
- 2 Select the calendar view for a particular day, week, or month.

Office

You can manage and view document files. The supported file types are PDF, DOC, TXT, XLS, and ZIP.

- 1 Tap the arrow [→] on Start to go to your App list and tap **Office** application.
- 2 Choose the files and folder list. If you choose **Recent Documents**, files you recently viewed will be displayed.
- 3 Touch and hold any file, and the options **Rename**, **Properties**, and **Delete** will appear.
- 4 Choose a file, then touch the Menu button to view the Open, Register, Update, Properties, and About options. There are additional options, depending on the file type.

PDF: Go To Page, Fit Page, Fit Width

DOC/TXT: Search

XLS: Worksheet – Choose Summary View or Full View.

The Web

Browser





Browser gives you a fast, fullcolour world of games, music, news, sports, entertainment, and much more, right on your mobile phone. Wherever you are and whatever you're into.

Accessing the Web

- 1 Tap the arrow [→] on Start to go to your App list and tap **Internet Explorer** application. Or, you can also tap **Internet Explorer** tile on Start screen.
- 2 You will move to the website.

NOTE: Additional charges apply when connecting to these services and downloading content. Check data charges with your network provider.

Using the Web tool bar

- 1 Touch  to refresh the web page.
- 2 Touch  to go forward one page.
- 3 Touch  to go backward one page.
- 4 Touch  to add bookmark.
- 5 Touch  to open another website in a new window.

- 6 Touch  to change the browser settings.

Using options

Touch the Menu options bar to use options.

Forward - Enter a web address and go forward to that page.

Favourites - For easy and fast access to your favourite websites, you can add bookmarks and save Web pages.

Share Page - Send page by Email or Messaging.

Page Info - Show page information.

Changing Web browser settings

Touch the Menu button then select **More > Settings**.

You can change the page layout (e.g., text size, text encoding), change the home page, manage cache, cookie, and security settings, and so on.

Settings

On the home screen, touch Applications tab then scroll and touch Settings.

System application

ringtones & sounds

Set Ringer and Vibrate and choose Ringtone, New text message, New voicemail, New mail.

Set to play a sound for Appointment reminders, Key press, Lock and unlock, All other notifications.

theme

Change your phone's background and accent colour to suit your mood today, this week or all month.

flight mode

Toggle your phone's mobile, WiFi, and Bluetooth radios simultaneously. You'll still be able to toggle WiFi and Bluetooth separately.

WiFi

Turn on Wi-Fi to connect to available Wi-Fi networks.

Wi-Fi settings – Set network notification, or add a Wi-Fi network

Bluetooth

Search and connect Bluetooth.

email & accounts

Set up email, contacts, Facebook and others.

lock & wallpaper

Set to change wallpaper and screen time-out.

Toggle to set password and create a 4-digit password.

location

Applications for which you've previously enabled location services can now access your current location.

mobile network

Set Data connection and Data roaming. Toggle to set 3G connection and select Network.

date & time

Set date, time, time zone

brightness

Adjust the brightness of the screen.

keyboard

Set Keyboard languages. You can check to Suggest text and highlight misspelt words, Correct misspelt words, Insert a space after selecting a suggestion, Insert a full-stop after double-clicking the SPACEBAR, Capitalise the first letter of a sentence.

region & language

Set Display language, Region format, Short date, Long date, First day of week, System locale and Browser & search language.

ease of access

Set TTY/TDD mode

speech

Set to Play audio confirmations and Use Speech when the phone is locked.

find my phone

phone update

Notify you when new updates are found. Use your mobile data connection to check for updates.

about

View legal information, and check phone status and software version.

feedback

Send feedback to help improve Windows Phone

Wi-Fi

Wireless Manager allows you to manage Internet connections your phone's Wi-Fi (a wireless LAN). It allows the phone to connect to local wireless networks or access the Internet wirelessly. Wi-Fi is faster and has a greater range than Bluetooth wireless technology. It allows fast emailing and Internet browsing.

NOTE: The WINDOWS PHONE supports WEP and WPA/WPA2-PSK security.

If your Wi-Fi service provider or network administrator sets encryption for network security, fill in the key in the pop-up window. If encryption is not set, this pop-up window will not be shown. You can obtain the key from your Wi-Fi service provider or network administrator.

1. How to set up Wi-Fi

- 1 Touch Wireless controls on the Settings tab, then turn Wi-Fi on.
- 2 AP (Access Point)
Search – Searches for which AP it can connect to.
- 3 AP Connect
– Connects to the desired AP from the AP search list.

– If the AP is security type WEP or WPA/WPA2-PSK, enter the security key.

2. Wi-Fi network profile support

- 1 Wi-Fi profile support (how to connect to a frequently used AP or hidden AP)
 - 1) If the AP does not appear in the search list, you can connect to it by saving it as a profile.
 - 2) Saving a frequently used AP as a profile makes it easier to enter the security key when connecting to an AP with that security type.
 - 3) If the AP does not support DHCP, you can connect to the AP using a static IP address.
- 2 Description of each field in the Wi-Fi profile.
 - 1) Network Name: SSID (ID)
 - 2) Security Type: WEP and WPA/WPA2-PSK support.
 - 3) Security Key: Saves the security key.
 - 4) IP/DNS Setting: This allows you to set to Automatic or Static,

depending on whether the AP supports DHCP.

For Static, enter the field value of the IP address and DNS server to use with the static IP address when connecting.

3 How to save the Wi-Fi profile

- 1) Select the Add Wi-Fi Network menu at the bottom of Wi-Fi Networks, then enter the SSID and Security Type.
- 2) After connecting to an AP with this security type, the profile will be saved automatically.

3. How to obtain the MAC address

To set up a connection in some wireless networks with MAC filters, you may need to enter the MAC address of your WINDOWS PHONE into the router.

You can find the MAC address in the following user interface:

Settings > Wireless controls > Wi-Fi settings > Menu > Advanced > MAC Address.