



LG-E974 User Guide

This guide helps you to get started using your phone.

- Some of the contents of this manual may not apply to your phone, depending on the software and your service provider.
- This handset is not suitable for people who have a visual impairment due to the touch screen keyboard.
- Copyright ©2012 LG Electronics, Inc. All rights reserved. LG and the LG logo are registered trademarks of LG Group and its related entities. All other trademarks are the property of their respective owners.
- Google™, Google Maps™, Gmail™, YouTube™, Google Talk™ and Play Store™ are trademarks of Google, Inc.

This device is not intended for sale in the U.S.A

Part 15.21 statement

" Change or Modifications that are not expressly approved by the manufacturer could void the user's authority to operate the equipment.

Part 15.105 statement

This equipment has been tested and found to comply with the limits for a class B digital device, pursuant to Part 15 of the FCC Rules. These limits are designed to provide reasonable protection against harmful interference in a residential installation. This equipment generates uses and can radiate radio frequency energy and, if not installed and used in accordance with the instructions, may cause harmful interference to radio communications. However, there is no guarantee that interference will not occur in a particular installation. If this equipment does cause harmful interference or television reception, which can be determined by turning the equipment off and on, the user is encouraged to try to correct the interference by one or more of the following measures:

- Reorient or relocate the receiving antenna.
- Increase the separation between the equipment and receiver.
- Connect the equipment into an outlet on a circuit different from that to which the receiver is connected.
- Consult the dealer or an experienced radio/TV technician for help.

FCC Part 15.19 Statement

This device complies with part15 of FCC rules.

Operation is subject to the following two conditions:

- (1) This device may not cause harmful interference.
- (2) This device must accept any interference received,

including interference that may cause undesired operation.

Body-worn Operation

This device has been tested for body-worn operations with the distance of 1.0cm (0.39 inches) between the user's body and the phone. To comply with FCC RF exposure requirements, a minimum separation distance of 1.0cm (0.39 inches) must be maintained from the user's body. Third-party belt-clips, holsters, and similar accessories containing metallic components may not be used. Body-worn accessories that cannot maintain 1.0cm (0.39 inches) separation distance between the user's body and the phone, and have not been tested for typical body-worn operations may not comply with FCC RF exposure limits and should be avoided.

WIFI Caution

This device is capable of operating in 802.11a/n mode. For 802.11a/n devices operating in the frequency range of 5.15 - 5.25 GHz, they are restricted for indoor operations to reduce any potential harmful interference for Mobile Satellite Services (MSS) in the US. WIFI Access Points that are capable of allowing your device to operate in 802.11a/n mode(5.15 - 5.25 GHz band) are optimized for indoor use only.

If your WIFI network is capable of operating in this mode, please restrict your WIFI use indoors to not violate federal regulations to protect Mobile Satellite Services.

Contents

Guidelines for safe and efficient use	4	Calls	36
Getting to know your phone	13	Making a call.....	36
Device components.....	19	Calling your contacts.....	36
QuickMemo.....	21	Answering and rejecting a call	36
Installing the Micro-USIM card	22	Adjusting call volume	36
Charging your phone.....	22	Making a second call	36
Locking and unlocking the screen	23	Viewing your call logs.....	37
Secure your lock screen	24	Call settings	37
Your Home screen	25	Contacts	39
Touch screen tips.....	25	Searching for a contact	39
Home.....	25	Adding a new contact.....	39
Customising the Home screen	25	Favourite contacts.....	39
Returning to recently-used applications.....	26	Moving contacts from your Old Device to your New Device.....	40
Notification drawer.....	26	Messaging	41
Viewing the status bar.....	26	Sending a message	41
Onscreen keyboard.....	28	Threaded box	41
Entering accented letters	28	Using Smilies.....	41
Google account set up	29	Changing your message settings	42
Connecting to Networks and Devices	30	E-mail	43
Wi-Fi.....	30	Managing an email account.....	43
Connecting to Wi-Fi networks	30	Email account screen.....	43
Bluetooth.....	30	Working with account folders.....	43
Sharing your phone's data connection.....	31	Composing and sending email	44
To rename or secure your portable hotspot.....	32	Camera	45
Using the Wi-Fi Cast.....	33	Getting to know the viewfinder	45
Enabling Wi-Fi Direct to share through SmartShare	33	Taking a quick photo	46
Using SmartShare	33	Once you've taken the photo	46
		Using the advanced settings	46

Video camera	49	Adding an event to your calendar	60
Getting to know the viewfinder	49	Tasks	60
Shooting a quick video	50	Polaris Office	61
After shooting a video	50	FileShare	61
Using the advanced settings	50	Backup	61
Adjusting the volume when viewing a video ..	51	Back up your smart phone data	62
		Scheduling automatic backups	62
		Restoring smart phone data.....	62
Video Wiz	52		
Multimedia	54	The web	64
Video Player	54	Internet	64
Playing a video	54	Using the web toolbar	64
Gallery	54	Using options.....	64
Music Player.....	55	Settings	65
Transferring music files using USB mass		WIRELESS & NETWORKS.....	65
storage devices	55	DEVICE.....	66
Playing a song	55	PERSONAL	68
LG Tag+	56	SYSTEM	69
Media Home.....	56	Phone software update	70
		DivX HD.....	71
Notebook	57	DTS	71
Making a note	57	Dolby Mobile	71
Getting to know the Notebook.....	57		
LG SmartWorld	59	Accessories	72
How to Get to LG SmartWorld from Your		Troubleshooting	73
Phone	59		
How to use LG SmartWorld.....	59		
Utilities	60		
Setting your alarm.....	60		
Using your calculator.....	60		

Guidelines for safe and efficient use

Please read these simple guidelines. Not following these guidelines may be dangerous or illegal.

Exposure to radio frequency energy

THIS DEVICE MEETS INTERNATIONAL GUIDELINES FOR EXPOSURE TO RADIO WAVES

Your mobile device is a radio transmitter and receiver. It is designed and manufactured not to exceed the limits for exposure to radio frequency (RF) recommended by international guidelines (ICNIRP). These limits are part of comprehensive guidelines and establish permitted levels of RF energy for the general population.

The guidelines were developed by independent scientific organisations through periodic and thorough evaluation of scientific studies. The guidelines include a substantial safety margin designed to assure the safety of all persons, regardless of age or health.

The exposure standard for mobile devices employs a unit of measurement known as the Specific Absorption Rate, or SAR. The SAR limit stated in the international

guidelines is 2.0 W/kg*. Tests for SAR are conducted using standard operating positions with the device transmitting at its highest certified power level in all tested frequency bands. Although the SAR is determined at the highest certified power level, the actual SAR of the device while operating can be well below the maximum value. This is because the device is designed to operate at multiple power levels so as to use only the power required to reach the network. In general, the closer you are to a base station, the lower the power output of the device. Before a phone model is available for sale to the public, compliance with the European R&TTE directive must be shown. This directive includes as one essential requirement the protection of the health and the safety for the user and any other person.

The highest SAR value for this device when tested for use at the ear is X.XXX W/kg.

This device meets RF exposure guidelines when used either in the normal use position against the ear or when positioned at least 1.5 cm away from the body. When a carry case, belt clip or holder is used for body-worn operation, it should not contain metal and should position the product at least 1.5 cm away from your body. In order to transmit data files or messages, this device requires a quality connection to the network. In some cases, transmission of data files or messages may be delayed until such a connection is available. Ensure the above separation distance instructions are followed until the transmission is completed.

The highest SAR value for this device when tested for use at the body is X.XXX W/kg.

* The SAR limit for mobile devices used by the public is 2.0 watts/ kilogram (W/kg) averaged over ten grams of body tissue. The guidelines incorporate a substantial margin of safety to give additional protection for the public and to account for any variations in measurements. SAR values may vary depending on national reporting requirements and the network band.

FCC SAR information

Your mobile device is also designed to meet the requirements for exposure to radio waves established by the Federal Communications Commission (USA) and Industry Canada.

These requirements set a SAR limit of 1.6 W/kg averaged over 1 gram of tissue. The highest SAR value reported under this standard during product certification for use at the ear is 0.447 W/kg and when properly worn on the body is 1.09 W/kg. Additionally, this device was tested for typical body-worn operations with the back of the phone kept 1 cm (0.39 inches) between the users body and the back of the phone.

To comply with FCC RF exposure requirements, a minimum separation distance of 1cm (0.39 inches) must be maintained between the user's body and the back of the phone.

Guidelines for safe and efficient use

* FCC Notice & Caution

Notice!

This device complies with part 15 of the FCC Rules. Operation is subject to the following two conditions:

- (1) This device may not cause harmful interference, and
- (2) this device must accept any interference received, including interference that may cause undesired operation.

Caution!

Change or Modifications that are not specifically approved by the manufacturer could void the user's authority to operate the equipment.

Product care and maintenance

WARNING

Only use batteries, chargers and accessories approved for use with this particular phone model. The use of any other types may invalidate any approval or warranty applying to the phone and may be dangerous.

- Do not disassemble this unit. Take it to a qualified service technician when repair work is required.
- Repairs under warranty, at LG's discretion, may include replacement parts or boards that are either new or reconditioned, provided that they have functionality equal to that of the parts being replaced.
- Keep away from electrical appliances such as TVs, radios and personal computers.
- The unit should be kept away from heat sources such as radiators or cookers.
- Do not drop.
- Do not subject this unit to mechanical vibration or shock.
- Switch off the phone in any area where you are required to by special

regulations. For example, do not use your phone in hospitals as it may affect sensitive medical equipment.

- Do not handle the phone with wet hands while it is being charged. It may cause an electric shock and can seriously damage your phone.
- Do not charge a handset near flammable material as the handset can become hot and create a fire hazard.
- Use a dry cloth to clean the exterior of the unit (do not use solvents such as benzene, thinner or alcohol).
- Do not charge the phone when it is on soft furnishings.
- The phone should be charged in a well ventilated area.
- Do not subject this unit to excessive smoke or dust.
- Do not keep the phone next to credit cards or transport tickets; it can affect the information on the magnetic strips.
- Do not tap the screen with a sharp object as it may damage the phone.
- Do not expose the phone to liquid or moisture.
- Use accessories like earphones cautiously. Do not touch the antenna unnecessarily.

- Do not use, touch or attempt to remove or fix broken, chipped or cracked glass. Damage to the glass display due to abuse or misuse is not covered under the warranty.
- Your phone is an electronic device that generates heat during normal operation. Extremely prolonged, direct skin contact in the absence of adequate ventilation may result in discomfort or minor burns. Therefore, use care when handling your phone during or immediately after operation.
- If your phone gets wet, immediately unplug it to dry off completely. Do not attempt to accelerate the drying process with an external heating source, such as an oven, microwave or hair dryer.
- The liquid in your wet phone, changes the color of the product label inside your phone. Damage to your device as a result of exposure to liquid is not covered under your warranty.

Efficient phone operation

Electronics devices

All mobile phones may receive interference, which could affect performance.

Guidelines for safe and efficient use

- Do not use your mobile phone near medical equipment without requesting permission. Avoid placing the phone over pacemakers, for example, in your breast pocket.
- Some hearing aids might be disturbed by mobile phones.
- Minor interference may affect TVs, radios, PCs etc.

Pacemakers

Pacemaker manufacturers recommend that a minimum separation of 15cm be maintained between a mobile phone and a pacemaker to avoid potential interference with the pacemaker. To achieve this use the phone on the opposite ear to your pacemaker and do not carry it in a breast pocket.

Hospitals

Switch off your wireless device when requested to do so in hospitals, clinics or health care facilities. These requests are designed to prevent possible interference with sensitive medical equipment.

Road safety

Check the laws and regulations on the use of mobile phones in the area when you drive.

- Do not use a hand-held phone while driving.
- Give full attention to driving.
- Pull off the road and park before making or answering a call if driving conditions so require.
- RF energy may affect some electronic systems in your vehicle such as car stereos and safety equipment.
- When your vehicle is equipped with an air bag, do not obstruct with installed or portable wireless equipment. It can cause the air bag to fail or cause serious injury due to improper performance.
- If you are listening to music whilst out and about, please ensure that the volume is at a reasonable level so that you are aware of your surroundings. This is of particular importance when near roads.

Avoid damage to your hearing



To prevent possible hearing damage, do not listen at high volume levels for long periods

Damage to your hearing can occur if you are exposed to loud sound for long periods of time. We therefore recommend that you do not turn on or off the handset close to your ear. We also recommend that music and call volumes are set to a reasonable level.

- When using headphones, turn the volume down if you cannot hear the people speaking near you, or if the person sitting next to you can hear what you are listening to.

NOTE: Excessive sound pressure from earphones and headphones can cause hearing loss

Glass Parts

Some parts of your mobile device are made of glass. This glass could break if your mobile device is dropped on a hard surface or receives a substantial impact. If the glass breaks, do not touch or attempt to remove it. Stop using your mobile device until the glass is replaced by an authorised service provider.

Blasting area

Do not use the phone where blasting is in progress. Observe restrictions and follow any regulations or rules.

Potentially explosive atmospheres

- Do not use your phone at a refueling point.
- Do not use near fuel or chemicals.
- Do not transport or store flammable gas, liquid or explosives in the same compartment of your vehicle as your mobile phone or accessories.

In aircraft

Wireless devices can cause interference in aircraft.

- Turn your mobile phone off before boarding any aircraft.
- Do not use it on the ground without permission from the crew.

Children

Keep the phone in a safe place out of the reach of small children. It includes small parts which may cause a choking hazard if detached.

Guidelines for safe and efficient use

Emergency calls

Emergency calls may not be available on all mobile networks. Therefore you should never depend solely on your phone for emergency calls. Check with your local service provider.

Battery information and care

- You do not need to completely discharge the battery before recharging. Unlike other battery systems, there is no memory effect that could compromise the battery's performance.
- Use only LG batteries and chargers. LG chargers are designed to maximise the battery life.
- Do not disassemble or short-circuit the battery.
- Replace the battery when it no longer provides acceptable performance. The battery pack may be recharged hundreds of times before it needs replacing.
- Recharge the battery if it has not been used for a long time to maximise usability.
- Do not expose the battery charger to direct sunlight or use it in high humidity, such as in the bathroom.
- Do not leave the battery in hot or cold places, as this may deteriorate battery performance.
- There is risk of explosion if the battery is replaced with an incorrect type.
- Dispose of used batteries according to the manufacturer's instructions. Please recycle when possible. Do not dispose as household waste.
- If you need to replace the battery, take it to the nearest authorised LG Electronics service point or dealer for assistance.
- Always unplug the charger from the wall socket after the phone is fully charged to save unnecessary power consumption of the charger.
- Actual battery life will depend on network configuration, product settings, usage patterns, battery and environmental conditions.
- Make sure that no sharp-edged items such as animal's teeth or nails, come into contact with the battery. This could cause a fire.

DECLARATION OF CONFORMITY

Hereby, **LG Electronics** declares that this **LG-E974** product is in compliance with the essential requirements and other relevant provisions of Directive **1999/5/EC**. A copy of the Declaration of Conformity can be found at <http://www.lg.com/global/support/cedoc/RetrieveProductCeDOC.jsp>

Regulatory and Safety

Go to "**System settings > About phone > Regulatory and Safety**" to get regulatory and safety information

Ambient temperatures

Max: +50°C (discharging),
+45°C (charging)

Min: -10°C

Notice: Open Source Software

To obtain the corresponding source code under GPL, LGPL, MPL and other open source licences, please visit <http://opensource.lge.com/>
All referred licence terms, disclaimers and notices are available for download with the source code.



Disposal of your old appliance

- 1 When this crossed-out wheeled bin symbol is attached to a product it means the product is covered by the European Directive 2002/96/EC.
- 2 All electrical and electronic products should be disposed of separately from the municipal waste stream via designated collection facilities appointed by the government or the local authorities.
- 3 The correct disposal of your old appliance will help prevent potential negative consequences for the environment and human health.
- 4 For more detailed information about disposal of your old appliance, please contact your city office, waste disposal service or the shop where you purchased the product.



Disposal of waste batteries/accumulators

- 1 When this crossed-out wheeled bin symbol is attached to batteries/accumulators of your product it means they are covered by the European Directive 2006/66/EC.
- 2 This symbol may be combined with chemical symbols for mercury (Hg), cadmium (Cd) or lead (Pb) if the battery contains more than 0.0005% of mercury, 0.002% of cadmium or 0.004% of lead.
- 3 All batteries/accumulators should be disposed separately from the municipal waste stream via designated collection facilities appointed by the government or the local authorities.
- 4 The correct disposal of your old batteries/accumulators will help to prevent potential negative consequences for the environment, animal and human health.
- 5 For more detailed information about disposal of your old batteries/accumulators, please contact your city office, waste disposal service or the shop where you purchased the product.

Getting to know your phone

Before you start using the phone, please read this!

Please check to see whether any problems you encountered with your phone are described in this section before taking the phone for service or calling a service representative.

1. Phone memory

When there is less than 10% of space available in your phone memory, your phone cannot receive new messages. You need to check your phone memory and delete some data, such as applications or messages, to make more memory available.

To uninstall applications:

- 1 Touch  > **Apps** tab > **Settings** > **Apps** from the DEVICE category.
- 2 Once all applications appear, scroll to and select the application you want to uninstall.
- 3 Touch **Uninstall**.

2. Optimising battery life

Extend your battery's life between charges by turning off features that you don't need to have running constantly in the background. You can monitor how applications and system resources consume battery power.

Extending your phone's battery life:

- Turn off radio communications you are not using. If you are not using Wi-Fi, Bluetooth or GPS, turn them off.
- Reduce screen brightness and set a shorter screen timeout.
- Turn off automatic syncing for Gmail, Calendar, Contacts and other applications.
- Some applications you have downloaded may reduce battery power.

To check the battery power level:

- Touch  > **Apps** tab > **Settings** > **About phone** from the SYSTEM > **Battery**

The battery status (charging or not charging) and battery level (percentage charged) is displayed at the top of the screen.

To monitor and control how battery power is being used:

- Touch  > **Apps** tab > **Settings** > **Power saver** from the DEVICE > **Battery use** from the BATTERY INFORMATION

Battery usage time is displayed at the bottom of the screen. It tells you how long it has been since you last connected your

Getting to know your phone

phone to a power source or, if currently connected, how long the phone was last running on battery power. The screen shows the applications or services using battery power, listed in order from the greatest to smallest amount used.

3. Using folders

You can combine several app icons in a folder. Drop one app icon over another on a home screen, and the two icons will be combined.

4. Before installing an open source application and OS

WARNING

If you install and use an OS other than the one provided by the manufacturer it may cause your phone to malfunction. In addition, your phone will no longer be covered by the warranty.

WARNING

To protect your phone and personal data, only download applications from trusted sources, such as Play Store™. If there are improperly installed applications on your phone, it may not work normally or a serious error may occur. You must uninstall those applications and all associated data and settings from the phone.

5. Using unlock pattern

Set unlock pattern to secure your phone.

Touch  > **Apps** tab > **Settings** > **Lock screen** from DEVICE > **Select screen lock** > **Pattern**. This opens a screen that guide you through how to draw a screen unlock pattern. You have to create a Backup PIN as a safety measure if you forgot pattern lock.

Caution: Create a Google account before setting an unlock pattern and remember Backup PIN you created while creating Pattern lock.



WARNING

Precautions to take when using pattern lock.

It is very important to remember the unlock pattern you set. You will not be able to access your phone if you use an incorrect pattern 5 times. You have 5 opportunities to enter your unlock pattern, PIN or password. If you have used all 5 opportunities, you can try again after 30 seconds.

When you can't recall your unlock Pattern, PIN, or Password:

< If you have forgotten pattern >

If you logged in to your Google account on the phone but failed to enter the correct pattern 5 times, tap the **Forgot Pattern** button on the bottom of the screen. You are then required to log in with your Google Account or you have to enter Backup PIN which you entered while creating Pattern Lock.

If you have not created a Google account on the phone or you forgot Backup PIN, you have to perform a hard reset.

< If you have forgotten PIN or Password >

If you forgot your PIN or Password, you need to do hard reset.

Caution: If you perform a hard reset, all user applications and user data are deleted.

Note: If you have not logged in Google Account and forgot Unlock Pattern, you need to enter Backup PIN.

6. Using the hard reset (Factory reset)

If your phone does not restore to the original condition, use a Hard Reset (Factory Reset) to initialise it.

- 1 Turn the power off.
- 2 Press and hold the **Power/Lock key + Volume Down key**.
- 3 Once LG Logo appears on the screen, release all Keys.
- 4 After some seconds, allow you to select factory reset function in the Android system recovery utility.
- 5 Scroll the list by Volume keys and select it by **Power/Lock key**.

WARNING

If you perform a Hard Reset, all user applications, user data and DRM licenses will be deleted. Please remember to back up any important data before performing a Hard Reset.

7. Opening and switching applications

Multitasking is easy with Android because you can keep more than one application running at the same time. There's no need to quit an application before opening another. Use and switch between several open applications. Android manages each application, stopping and starting them as needed to ensure that idle applications don't consume resources unnecessarily.

To return to view list recently used applications:

Simply press **Recent apps** key

To stop applications:

- 1 Touch  > **Apps** tab > **Settings** > **Apps** > **Running**
- 2 Scroll and touch the desired application and touch **Stop** to stop it.

8. Installing PC Software (LG PC Suite)

"LG PC Suite" PC Application is a program that helps you connect your device to a PC via a USB cable and Wi-Fi. Once connected, you can use the functions of your device from your PC.

With your "LG PC Suite" PC Application, You Can...

- Manage and play your media contents (music, movie, pictures) on your PC.
- Send multimedia contents to your device.
- Synchronises data (schedules, contacts, bookmarks) in your device and PC.
- Backup the applications in your device.
- Update the softwares in your device.
- Backup and restore the device.
- Play multimedia contents of your PC from your device.

NOTE: You can use the Help menu from the application to find out how to use your "LG PC Suite" PC application.

Installing "LG PC Suite" PC Application

"LG PC Suite" PC application can be downloaded from the webpage of LG.

- 1 Go to www.lg.com and select a country of your choice.
- 2 Go to **Support > MOBILE SUPPORT > LG Mobile Phones** > Select the Model (LG-E974) or Go to **Support > Mobile Phone Support** > Select the Model (LG-E974).
- 3 Click **PC Sync** from **MANUALS & DOWNLOAD**, and click **DOWNLOAD** to download "LG PC Suite" PC software or Click **PC Sync** from **Download**, and click **WINDOW PC Sync Download** to download "LG PC Suite" PC software.

System Requirements for "LG PC Suite" PC software

- OS: Windows XP 32 bit(Service pack 2), Windows Vista 32 bit/64 bit, Windows 7 32 bit/64 bit
- CPU: 1 GHz or higher processors
- Memory: 512 MB or higher RAMs
- Graphic card: 1024 x 768 resolution, 32 bit color or higher
- HDD: 100 MB or more free hard disk space (More free hard disk space may be needed depending on the volume of data stored.)

- Required software: LG integrated drivers, Windows Media Player 10 or later

NOTE: LG Integrated USB Driver

LG integrated USB driver is required to connect an LG device and PC and installed automatically when you install "LG PC Suite" PC software.

9. Synchronising your phone to a Computer

Data from your device and PC can be synchronised easily with "LG PC Suite" PC application for your convenience. Contacts, schedules, and bookmarks can be synchronised.

The procedure is as follows:

- 1 Connect your device to PC. (Use a USB cable or Wi-Fi connection.)
- 2 After connection, run the program and select the device section from the category on the left side of the screen.
- 3 Click [Personal information] to select.
- 4 Select the checkbox of contents to synchronise and click the **Sync** button.

Getting to know your phone

10. Synchronising your phone to a computer via USB

NOTE: To synchronise your phone with your PC using the USB cable, you need to install LG PC Suite onto your PC.

Please refer to previous pages to install LG PC Suite.

- 1 Touch  > **Apps** tab > **Settings** > **Storage** from the DEVICE to check out the storage media.
- 2 Connect the phone to your PC using the USB cable.
- 3 USB connection type list will appear in your phone screen, and select **Media sync (MTP)** option.
- 4 Open the memory folder on your PC. You can view the mass storage content on your PC and transfer the files.
- 5 Copy the files from your PC to the drive folder.
- 6 Select **Charge only** option to disconnect the phone.

To disconnect your phone from the computer:

Open the notification drawer and touch  > **Charge only** to disconnect your phone from the computer safely.

11. Hold your phone upright

Hold your mobile phone vertically, as you would a regular phone. The LG-E974 has an internal antenna. Be careful not to scratch or damage the back of the phone, as this may affect performance.

While making/receiving calls or sending/receiving data, avoid holding the lower part of the phone where the antenna is located. Doing so may affect call quality.

12. When the screen freezes

If the screen freezes or the phone does not respond when you try to operate it:

Press and hold the **Power/Lock** key for 10 seconds to turn it off.

If it still does not work, please contact the service centre.

Device components

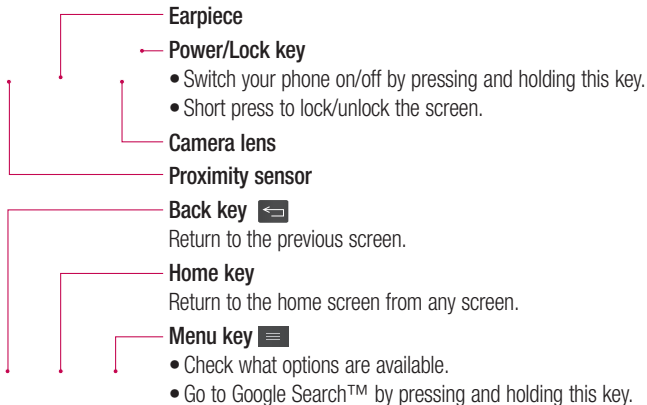

NOTE: Proximity sensor

When receiving and making calls, the proximity sensor automatically turns the backlight off and locks the touch screen by sensing when the phone is near your ear. This extends battery life and prevents you from unintentionally activating the touch screen during calls.

WARNING

Placing a heavy object on the phone or sitting on it can damage the LCD and touch screen functions. Do not cover the LCD proximity sensor with protective film. This could cause the sensor to malfunction.

Getting to know your phone

Volume keys

- **In the home screen:** Control ringer volume.
- **During a call:** Control your earpiece volume.
- **When playing a track:** Control volume continuously.

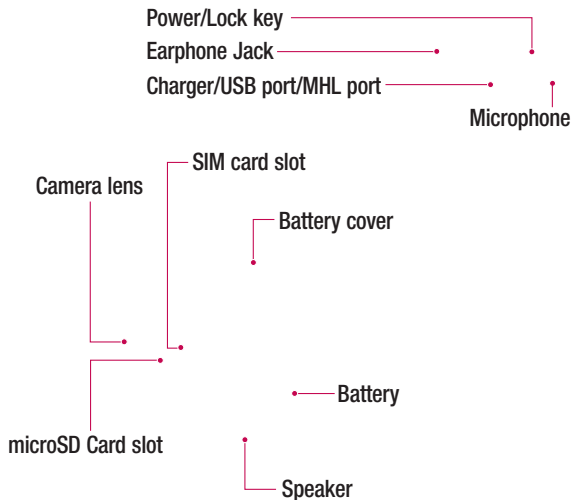

WARNING

Encloses the battery compartment. Please do not open the back cover.

QuickMemo

Use **QuickMemo™** to practically and efficiently create memos during a call, with a saved picture or on the current phone screen.









- 1 Enter the **Quick-Memo™** screen by pressing Quick-Memo™ Hotkey
- 2 Select the desired menu option from **Pen type, Colour, Eraser**, and create a memo.
- 3 Touch  to save the memo with the current screen.

NOTE: Please use a fingertip while using the QuickMemo™ function. Do not use your fingernail.

Using the QuickMemo™ options

While using the QuickMemo™ function, you can easily use the QuickMenu options.

-  – Select if you want to use the background screen or not.
-  – Undo or Redo.
-  – Select the pen type and the colour.
-  – Erase the memo that you created.
-  – Send or share the current QuickMemo™ to others.
-  – Save the memo with the current screen.

Viewing the saved QuickMemo™

Touch **Gallery** and select the QuickMemo™ album.

Getting to know your phone

Installing the Micro-USIM card

Before you can start exploring your new phone, you'll need to set it up. To insert the Micro-USIM card:

- 1 Open the Micro-USIM card slot Cover by Pin.
- 2 Slide the Micro-USIM card into the Micro-USIM card slot. Make sure the Gold contact area on the card is facing downwards.

Charging your phone

The charger connector is at the top of the phone. Insert the charger and plug it into an electrical outlet.

NOTE: The battery must be fully charged initially to improve battery lifetime.

Locking and unlocking the screen

If you do not use the phone for a while, the screen is turned off and locked automatically. This helps to prevent accidental touches and saves battery power.

When you are not using the LG-E974, press the **Power/Lock key**  to lock your phone.

If there are any programs running when you set lock screen, they may be still running in Lock mode. It is recommended that you exit all programs before entering Lock mode to avoid unnecessary charges (e.g. phone calls, web access and data communications).

To wake up your phone, press the **Power/Lock key** . The lock screen will appear. Touch and slide the lock screen in any direction to unlock your home screen. The last screen you viewed will open.

Getting to know your phone

Secure your lock screen

You can lock your screen so that only you can unlock it to access your phone.

To set an Unlock Pattern, PIN or Password for the first time:

- Touch  > **Apps** tab > **Settings** > **Lock screen** > **Select screen lock** > **None, Swipe, Face Unlock, Pattern, PIN or Password.**

NOTE:

Precautions to take when using pattern lock.

It is very important to remember the unlock pattern you set. You will not be able to access your phone if you use an incorrect pattern 5 times. You have 5 opportunities to enter your unlock pattern, PIN or password. If you have used all 5 opportunities, you can try again after 30 seconds.

When you cannot recall your unlock pattern:

If you logged in to your Google account on the phone but failed to enter the correct pattern 5 times, tap the **Forgot pattern** button. You are then required to log in with your Google account to unlock your phone.

If you have not created a Google account on the phone or you forgot it, you have to perform a hard reset.

Your Home screen

Touch screen tips

Here are some tips on how to navigate around your phone.

Touch – To choose a menu/option or open an application, touch it.

Touch and hold – To open an options menu or grab an object you want to move, touch and hold it.

Drag – To scroll through a list or move slowly, drag across the touch screen.

Flick – To scroll through a list or move quickly, flick across the touch screen (drag quickly and release).

NOTE:

- To select an item, touch the centre of the icon.
- Do not press too hard; the touch screen is sensitive enough to pick up a light, firm touch.
- Use the tip of your finger to touch the option you want. Be careful not to touch any other keys.

Home

Simply swipe your finger to the left or right to view the panels. You can customise each panel with Apps, Downloads, Widgets and wallpapers.

NOTE: Some screen images may be different depending on your phone provider.

On your home screen, you can view menu icons at the bottom of the screen. Menu icons provide easy, one-touch access to the functions you use the most.



Touch the **Phone** icon to bring up the touch screen dialpad to make a call.



Touch the **Contacts** icon to open your contacts.



Touch the **Notebook** icon to open your notebook function.



Touch the **Messaging** icon to access the messaging menu. This is where you can create a new message.



Touch the **Apps** icon at the bottom of the screen. You can then view all your installed applications. To open any application, simply touch the icon in the applications list.

Customising the Home screen

You can customise your home screen by adding Apps, Downloads, Widgets or Wallpapers. For more convenience using your phone, add your favourite apps and widgets to the home screen.

Your Home screen

To add items on your home screen:

- 1 Touch and hold the empty part of the home screen.
Or touch  at the top of the right side.
- 2 In the Add Mode menu, select items you want to add. You will then see added items on the home screen.
- 3 Drag it to the location you want and lift your finger.

To remove an item from the home screen:

- **Home screen** > touch and hold the icon you want to remove > drag it to 

TIP! To add an application icon to the home screen from the Apps menu, touch and hold the application you want to add.

Returning to recently-used applications



- 1 Touch the **Recent app** key. The screen displays a pop-up with icons of applications you used recently.
- 2 Touch an icon to open the application.
Or touch the **Back** key to return to your previous screen.

Notification drawer

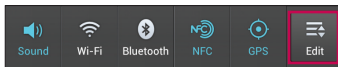
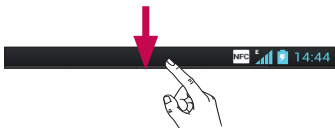
The notification drawer runs across the top of your screen.



Touch and slide the notification drawer down with your finger.







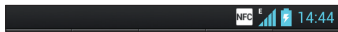







Touch  >  to manage the Notifications. Here you can check and manage Sound profile, Wi-Fi, Bluetooth, NFC, GPS, Accounts & sync, Airplane mode, Auto-rotate screen, Brightness, Data enabled or Portable Wi-Fi hotspot.













Viewing the status bar

The status bar uses different icons to display phone information such as signal strength, new messages, battery life, active Bluetooth and data connections.







Below is a table explaining the meaning of icons you're likely to see in the status bar.

Icon	Description
	No Micro-USIM card
	No signal
	Airplane mode
	Connected to a Wi-Fi network
	Wired headset
	Call in progress
	Call hold
	Speakerphone
	Phone microphone is muted
	Missed call
	Bluetooth is on
	System warning
	Alarm is set
	New voicemail

Icon	Description
	Ringer is silenced
	NFC is on
	Vibrate mode
	Battery fully charged
	Battery is charging
	Phone is connected to PC via USB cable
	Downloading data
	Uploading data
	GPS is acquiring
	Receiving location data from GPS
	Data is syncing
	New Gmail
	New Google Talk message

Your Home screen

Icon	Description
	New message
	Song is playing
	USB tethering is active
	Portable Wi-Fi hotspot is active
	Both USB tethering and portable hotspot are active

Onscreen keyboard

You can enter text using the onscreen keyboard. The onscreen keyboard appears automatically on the screen when you need to enter text. To manually display the keyboard, simply touch a text field where you want to enter text.

Using the keypad & entering text

 Tap once to capitalise the next letter you type. Double-tap for all caps.

 Tap to switch to the numbers and symbols keyboard. You can also touch and hold this tab to view the Settings menu.

 Tap to enter a space.

 Tap to create a new line in the message field.

 Tap to delete the previous character.

Entering accented letters

When you select French or Spanish as the text entry language, you can enter special French or Spanish characters (e.g. "á"). For example, to input "á", touch and hold the "a" key until the zoom-in key grows bigger and displays characters from different languages. Then select the special character you want.

Google account set up

When you first turn on your phone, you have the opportunity to activate the network, to sign into your Google Account and how you want to use some Google services.

To set up your Google account:

- Sign into a Google Account from the prompted set up screen.

OR

- Touch  > **Apps** tab > select a Google application, such as **Gmail** > select **New** to create a new account.

If you have a Google account, touch **Existing**, enter your email address and password, then touch **Sign in**.

Once you have set up your Google account on your phone, your phone automatically synchronises with your Google account on the web.

Your contacts, Gmail messages, Calendar events and other information from these applications and services on the web are synchronised with your phone. (This depends on your synchronisation settings.)

After signing in, you can use Gmail™ and take advantage of Google services on your phone.

Connecting to Networks and Devices

Wi-Fi

With Wi-Fi, you can use high-speed Internet access within the coverage of the wireless access point WAP. Enjoy wireless Internet using Wi-Fi, without extra charges.

Connecting to Wi-Fi networks

To use Wi-Fi on your phone, you need to access a wireless access point or "hotspot". Some access points are open and you can simply connect to them. Others are hidden or use security features, you must configure your phone to be able to connect to them.

Turn off Wi-Fi when you're not using it to extend the life of your battery.

NOTE: If you are out of the Wi-Fi zone or set Wi-Fi to **OFF**, additional charges may be applied by your mobile operator for mobile data use.

Turning Wi-Fi on and connecting to a Wi-Fi network

- 1 Touch  > **Apps** tab > **Settings** > **Wi-Fi** from the WIRELESS & NETWORKS
- 2 Set **Wi-Fi** to **ON** to turn it on and start scanning for available Wi-Fi networks.

- 3 Tap Wi-Fi menu again to see a list of active and in-range Wi-Fi networks.
 - Secured networks are indicated by a lock icon.
- 4 Touch a network to connect to it.
 - If the network is secured, you are prompted to enter a password or other credentials. (Ask your network administrator for details)
- 5 After connecting to a Wi-Fi network, the status bar displays icon that indicate Wi-Fi status.

Bluetooth

You can use Bluetooth to send data by running a corresponding application as on most other mobile phones.

TIP! With LG-E974, you can enjoy Bluetooth high speed. If the device you want to share files which also supports high speed Bluetooth, the files will automatically be transferred via the high-speed network. To use Bluetooth high speed data transfer, please make sure the Wi-Fi is OFF on your devices before use. The settings for Bluetooth high speed may be different depends on the device. Please check the device's settings with their service provider.

Turning on Bluetooth and pairing up your phone with a Bluetooth device

You must pair your device with another device before you connect to it.

- 1 Touch  > **Apps** tab > **Settings** > Set **Bluetooth** to **ON** from the WIRELESS & NETWORKS
- 2 Tap **Bluetooth** menu again. Your phone will scan for and display the IDs of all available Bluetooth in-range devices. If the device you want to pair which isn't on the list, make sure the target device is set to be discoverable, then tap **Search for devices** again.
- 3 Choose the device you want to pair up with from the list.

Once the pairing is successful, your device will connect to the device.

Sending pictures using Bluetooth

- 1 Select a **Picture** >  > **Bluetooth**
- 2 Check whether **Bluetooth** is **ON**, then select **Search for devices**.
- 3 Choose the device you want to send data to from the list.

Sharing your phone's data connection

USB tethering and portable Wi-Fi hotspot are great features when there are no wireless connections available. You can share your phone's mobile data connection with a single computer via a USB cable (USB tethering). You can also share your phone's data connection with more than a single device at a time by turning your phone into a portable Wi-Fi hotspot.

When your phone is sharing its data connection, an icon appears in the status bar and as an ongoing notification in the notifications drawer.

For the latest information about tethering and portable hotspots, including supported operating systems and other details, visit <http://www.android.com/tether>.

To change Portable Wi-Fi hotspot settings:

- Touch  > **Apps** tab > **Settings** > **More** from the WIRELESS & NETWORKS > **Portable Wi-Fi hotspot** > Choose options that you want to adjust

Connecting to Networks and Devices

TIP!

If your computer is running Windows 7 or a recent distribution of some flavours of Linux (such as Ubuntu), you don't usually need to prepare your computer for tethering. But if you're running an earlier version of Windows or another operating system, you may need to prepare your computer to establish a network connection via USB. For the most current information about which operating systems support USB tethering and how to configure them, visit <http://www.android.com/tether>.

- The **Configure Wi-Fi hotspot** dialog box will open.
- You can change the network SSID (name) that other computers or devices see when scanning for Wi-Fi networks.
- You can also touch the **Security** menu to configure the network with Wi-Fi Protected Access 2 (WPA2) security using a pre-shared key (PSK).
- If you touch the **WPA2 PSK** security option, a password field is added to the **Configure Wi-Fi hotspot** dialog. If you enter a password, you will need to enter that password when you connect to the phone's hotspot with a computer or other device. You can set **Open** in the **Security** menu to remove security from your Wi-Fi network.

5 Touch **Save**.

ATTENTION!

If you set the security option as **Open**, you cannot prevent unauthorised usage of online services by other people and additional charges can be incurred. To avoid unauthorised usage, you are advised to keep the security option active.

To rename or secure your portable hotspot

You can change the name of your phone's Wi-Fi network name (SSID) and secure its Wi-Fi network.

- 1 On the home screen, touch  > **Apps** tab > **Settings**
- 2 Touch **More** from the WIRELESS & NETWORKS and select **Portable Wi-Fi hotspot**.
- 3 Ensure **Portable Wi-Fi hotspot** is ticked.
- 4 Touch **Configure Wi-Fi hotspot**.

Using the Wi-Fi Cast

You can share your music, picture and video content between users who use Android Phones connected via the same Wi-Fi & Wi-Fi Direct network.

Check your Wi-Fi & Wi-Fi Direct network in advance and make sure the users are connected to the same network.

- 1 Touch  > **Apps** tab > **Settings** > **More** from the WIRELESS & NETWORKS > **Wi-Fi Direct**
- 2 Touch the Wi-Fi Direct checkbox to turn on.
- 3 Select a device to connect from the scanned device list.
- 4 Touch **Connect**.

Enabling Wi-Fi Direct to share through SmartShare

Wi-Fi Direct automatically scans nearby Wi-Fi Direct devices and the searched devices are listed as they are found and you can select a specific device to share multimedia data through SmartShare.

Wi-Fi Direct cannot be enabled while using other Wi-Fi functions.

- 1 Touch  > **Apps** tab > **Settings** > **More** from the WIRELESS & NETWORKS > **Wi-Fi Direct**

- 2 Select a device to connect from the scanned device list.



CREATE GROUP – Touch to activate group owner mode, which enables the legacy Wi-Fi devices to connect by scanning your phone. In this case you must enter the password that is set in **Password**.

NOTE: When your phone becomes a group owner, it will consume more battery power than when it is a client. Wi-Fi Direct connection does not provide Internet service. Additional costs may be incurred when connecting and using online services. Check data charges with your network provider.

Using SmartShare

SmartShare uses DLNA (Digital Living Network Alliance) technology to share digital content through a wireless network. Both devices must be DLNA certified to support this feature.

To turn SmartShare on and allow sharing contents

- 1 Touch  > **Apps** tab > **SmartShare** 
- 2 Touch the **Menu** key  > **Settings**.
- 3 Touch **Discoverable** to allow your device to be detected by other devices.





Connecting to Networks and Devices

- Touch **Always accept request** if you would like to automatically accept sharing requests from other devices.
 - Touch **Receive files** if you would like to allow the other devices to upload media files to my phone.
- 4 Under the My shared contents section, touch to checkmark the types of content you would like to share. Choose from **Pictures**, **Videos**, and **Music**.
 - 5 **SmartShare** is now activated and ready to share contents.

To control your renderer devices

Let your renderer device (e.g., TV) play multimedia contents from your remote content library (e.g., PC).







NOTE: Make sure that the DLNA functionality of your devices is properly configured (e.g., TV and PC).

- 1 Touch  > **Apps tab** > **SmartShare** .
- 2 Touch the **To** button  and select the device from the renderer device list.
- 3 Touch the **From** button  and select the device of the remote content library.
- 4 You can browse the content library.

- 5 Touch and hold a content thumbnail and flick them to the top area with your finger or touch the **Menu Key**  > **Play**.

To share contents from your phone to your renderer device (e.g. TV)

NOTE: Make sure that your renderer device is properly configured.

- 1 While watching your pictures or videos using the Gallery application, touch tab  /  /  on the Title area.
 : Need to be connected network
 : Select the device on network
 : Currently, the content is being shared through SmartShare.
- 2 Select the device from renderer lists to play the files.

NOTICE: Check that your device is connected with your home network using Wi-Fi connection to use this application.
Some DLNA enabled devices (e.g. TV) support only the DMP feature of DLNA and will not appear in the renderer device list.
Your device might not be able to play some contents.

To download contents from the remote content library



- 1 Touch  > **Apps** tab > **SmartShare** .
- 2 Touch the **From** button  and select the device of the remote content library.
- 3 You can browse the content library.
- 4 Touch and hold a content thumbnail and then touch **Download**.

NOTICE: A few types of contents are not supported.

NOTICE: Some DLNA enabled devices do not support the DMS upload functionality and will not upload files. A few types of contents are not supported.





To upload contents from the remote content library

NOTE: Make sure that the internal storage is correctly mounted and the Receive files option in the Settings menu is checked.

- 1 Touch  > **Apps** tab > **SmartShare** .
- 2 Touch the **From** button  and select **My phone**.
- 3 You can browse the local content library.
- 4 Touch and hold a content thumbnail and then touch **Upload**.
- 5 Select the device of the remote content library to be uploaded.



Calls

Making a call

- 1 Touch  to open the keypad.
- 2 Enter the number using the keypad. To delete a digit, touch the .
- 3 Touch  to make a call.
- 4 To end a call, touch the **End** icon .

TIP! To enter "+" to make international calls, touch and hold .

Calling your contacts

- 1 Touch  to open your contacts.
- 2 Scroll through the contact list or enter the first few letters of the contact you want to call by touching **Search contacts**.
- 3 In the list, touch the contact twice or touch  you want to call.

Answering and rejecting a call

When you receive a call in Lock state, hold and slide the  to Answer incoming call.

Hold and slide the  to Decline an incoming call.

Hold and slide the **Quick msg** icon from the bottom if you want to send a message.





TIP! Quick msg

You can send a message quickly using this function. This is useful if you need to reject a call with message during a meeting.

Adjusting call volume

To adjust the in-call volume during a call, use the Volume up and down keys on the left-hand side of the phone.

Making a second call

- 1 During your first call, touch **Menu** > **Add call** and dial the number. Also, you can go recent dialled list by touching  or can search contacts by touching  and select the contact you want to call.
- 2 Touch  to make the call.
- 3 Both calls are displayed on the call screen. Your initial call is locked and put on hold.
- 4 Touch the displayed number to toggle between calls. Or touch  **Merge call** to make a conference call.
- 5 To end active calls, touch **End** or press **Home Key** and slide the notification bar down and select **End call** icon .

NOTE: You are charged for each call you make.

Viewing your call logs

On the home screen, touch  and choose the **Call logs** tab .

View a complete list of all dialled, received and missed calls.

TIP! Touch any call log entry to view the date, time and duration of the call.

TIP! Press the **Menu** key, then touch **Delete all** to delete all the recorded items.

Call settings

You can configure phone call settings such as call forwarding and other special features offered by your carrier.

- 1 On the home screen, touch .
- 2 Touch menu.
- 3 Tap **Call settings** and choose the options that you want to adjust.

Fixed dialing numbers – To turn on and compile a list of numbers that can be called from your phone. You'll need your PIN2, which is available from your operator. Only numbers within the fixed

dial list can be called from your phone.

Voicemail service – Allows you to select your carrier's voicemail service.

Voicemail settings – If you are using your carrier's voicemail service, this option allows you to enter the voicemail number to use for listening to and managing your voicemail.

Save unknown numbers – Add unknown numbers to contacts after a call.

Call reject – Allows you to set the call reject function. Choose from **Disabled**, **Reject calls on list** or **Reject all calls**.

Quick messages – When you want to reject a call, you can send a quick message using this function. This is useful if you need to reject a call during a meeting.

Call forwarding – Choose whether to divert all calls, when the line is busy, when there is no answer or when you have no signal.

Call barring – Select when you would like calls to be barred. Enter the call barring password. Please check with your network operator about this service.

Call duration – View the duration of calls including Last call, All calls, Dialled calls and received calls.

Calls

Call costs – View the charges applied to your calls. (This service is network dependent; some operators do not support this function)

Additional settings – This lets you change the following settings:

Caller ID: Choose whether to display your number on an outgoing call.

Call waiting: If call waiting is activated, the handset will notify you of an incoming call while you are in call (depending on your network provider).

Contacts



Add contacts to your phone and synchronise them with the contacts in your Google account or other accounts that support contact syncing.

Searching for a contact

In the home screen

- 1 Touch  to open your contacts.
- 2 Touch **Search contacts** and enter the contact name using the keyboard.

Adding a new contact

- 1 Touch , enter the new contact's number, then press the **Menu** key. Touch **Add to Contacts > Create new contact**.
- 2 If you want to add a picture to the new contact, touch the image area. Choose from **Take photo** or **Select from Gallery**.
- 3 Select the contact type by touching .
- 4 Touch a category of contact information and enter the details about your contact.
- 5 Touch **Save**.



Favourite contacts

You can classify frequently called contacts as favourites.

Adding a contact to your favourites

- 1 Touch  to open your contacts.
- 2 Touch a contact to view their details.
- 3 Touch the star to the right of the contact's name. The star turns yellow color.

Removing a contact from your favourites list

- 1 Touch  to open your contacts.
- 2 Touch the  tab, and choose a contact to view its details.
- 3 Touch the yellow color star to the right of the contact's name. The star turns grey and the contact is removed from your favourites.

Moving contacts from your Old Device to your New Device



Export your contacts as a CSV file from your old device to your PC using a PC sync program.

- 1 Install "LG PC Suite" on the PC first. Run the program and connect your Android mobile phone to the PC using a USB cable.
- 2 On the top menu, select **Device > Import to device > Import contacts**.
- 3 A popup window to select the file type and a file to import will appear.
- 4 On the popup, click the **Select a file** and Windows Explorer will appear.
- 5 Select the contacts file to import in Windows Explorer and click the **Open**.
- 6 Click **OK**.
- 7 A **Field mapping** popup to link the contacts in your device and new contacts data will appear.
- 8 If there is a conflict between the data in your PC contacts and device contacts, make the necessary selections or modifications in LG PC Suite.
- 9 Click **OK**.

Messaging

Your LG-E974 combines SMS and MMS into one intuitive, easy-to-use menu.

Sending a message

- 1 Touch  on the home screen, and touch  to open a blank message.
- 2 Enter a contact name or contact number in the To field. As you enter the contact name, matching contacts appear. You can touch a suggested recipient. You can add multiple contacts.

NOTE: You will be charged for a text message for every person you send the message to.

- 3 Touch Enter message field and start to compose your message.
- 4 Press  to open the Options menu. Choose from **Add subject**, **Discard**, **Insert smiley** and **All messages**.

TIP! You can touch  icon to attach the file you want to share with your message.

- 5 Touch **Send** to send your message.
- 6 Responses appear on the screen. As you view and send additional messages, a message thread is created.

 **WARNING:** The 160-character limit may vary from country to country depending on the language and how the SMS is coded.

 **WARNING:** If an image, video or audio file is added to an SMS message, it is automatically converted into an MMS message and you are charged accordingly.

Threaded box

Messages (SMS, MMS) exchanged with another party can be displayed in chronological order so that you can conveniently see an overview of your conversation.

Using Smilies

Liven up your messages using Smilies. When writing a new message, press the **Menu** key, then choose **Insert smiley**.

Changing your message settings

Your LG-E974 message settings are predefined, so you can send messages immediately. You can change the settings based on your preferences.

- Touch Messaging icon on the home screen, and touch the **Menu** key, then tap **Settings**.

E-mail

You can use the Email application to read emails from services like Gmail. The Email application supports the following account types: POP3, IMAP and Exchange.

Your service provider or system administrator can provide the account settings you need.

Managing an email account



The first time you open the **E-mail** application, a setup wizard opens to help you to set up an email account.

To add another email account:



- Touch  > **Apps** tab > **E-mail** > in the account screen, touch  > **Add account**

After the initial setup, Email displays the contents of your inbox. If you have added more than one account, you can switch among accounts.

To change an email account's setting:

- Touch  > **Apps** tab > **E-mail** > in the account screen, touch  > **Settings**

To delete an email account:

- Touch  > **Apps** tab > **E-mail** > in the account screen, touch  > **Delete account** > touch an account you want to delete > **Delete** > **OK**

Email account screen

You can touch an account to view its Inbox.

The account from which you send email by default is indicated with a tick.

 – Touch to open your Combined Inbox, with messages sent to all of your accounts. Messages in the Combined Inbox are colour coded on the left, by account, using the same colours used for your accounts in the Accounts screen.

 – Touch the folder icon to open the account folders.

TIP!

If you long-press an account from the list of email accounts, you can select the desired option in the pop-up window.



For example, select **Add to home screen** to create a shortcut icon of the account on the home screen.

Working with account folders

Each account has an Inbox, Outbox, Sent and Drafts folder. Depending on the features supported by your account's service provider, you may have additional folders.

Composing and sending email

To compose and send a message

- 1 While in the **E-mail** application, touch the .
- 2 Enter an address for the message's intended recipient. As you enter text, matching addresses are offered from your Contacts. Separate multiple addresses with semicolon.
- 3 Touch Cc/Bcc field to add Cc/Bcc and Touch  to attach files if required.
- 4 Enter the text of the message.
- 5 Touch the .

If you aren't connected to a network, for example, if you're working in airplane mode, the messages that you send are stored in your Outbox folder until you're connected to a network again. If it contains any pending messages, the Outbox is displayed on the Accounts screen.

TIP! When a new email arrives in the inbox, you will receive a notification by sound or vibration. Tap the email notification to stop notifications.

Camera

Getting to know the viewfinder

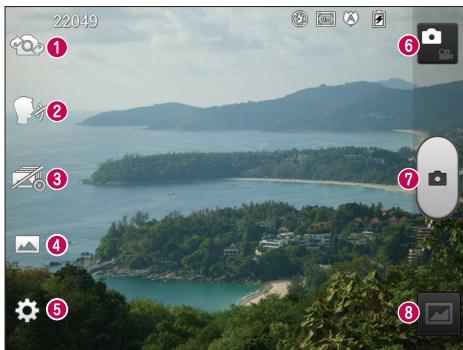

- 1 Swap camera** – Switch between the rear-facing camera lens and the front-facing camera lens.
- 2 Cheese shutter** – Say Cheese when you get ready to take a photo.
- 3 Time catch shot** – Touch this icon to capture the missing moment before pressing the shutter.
- 4 Shot mode** – Choose from **Normal**, **HDR**, **Panorama** or **Continuous shot**.
- 5 Settings** – Touch this icon to open the Settings menu.
- 6 Video mode** – Touch this icon to switch to video mode.
- 7 Taking a photo**
- 8 Gallery** – Touch to view the last photo you captured. This enables you to access your gallery and view saved photos within camera mode.

Taking a quick photo

- 1 Open the **Camera** application.
- 2 Hold the phone, point the lens towards the subject you want to photograph.
- 3 Touch the screen and a focus box will appear in the viewfinder screen.
- 4 When the focus box turns green, the camera has focused on your subject.
- 5 Click on the  to capture the photo.

Once you've taken the photo

Touch  to view the last photo you captured.

 Touch to share your photo via **Bluetooth, E-mail, Gmail, Google+, Memo, Messaging, Picasa** and **Social+**.

TIP! If you have an SNS account and set it up on your phone, you can share your photo with the SNS community.

 Touch to delete the photo.

Touch  to open the options.

Set image as – Touch to use the photo as a Contact photo, Home Screen wallpaper or Lockscreen Wallpaper.

Move – Touch to move the photo to other place.

Rename – Touch to edit the name of the selected picture.

Rotate left/right – To rotate left or right.

Crop – Crop your photo. Move your finger across the screen to select the area.

Edit – View and edit the picture.

 Select the photo resolution. If you choose the high resolution, the file size will increase, which means you will be able to store fewer photos in the memory.

 Improves colour qualities in different lighting conditions.

 Applies artistic effects to the pictures.

 Applies the additional options for pictures.

Slideshow – Automatically shows you the images one after the other.

Details – Show the picture information.

Using the advanced settings

In the viewfinder, touch  to open all advanced options.

 – Touch if you want to change the viewfinder menu.

 – Switch between the rear-facing camera lens and the front-facing camera lens.

 – Say Cheese when you get ready to take a photo.

 – Touch this icon to capture the missing moment before pressing the shutter.

 – Choose from Normal, HDR, Panorama or Continuous shot.

 – Allows you to turn on the flash when taking a photo in dark conditions.

 – Zoom in or out

 – This defines and controls the amount of sunlight entering the photo.

 – Focuses on the specific spot.

 – Select the photo resolution. If you choose the high resolution, the file size will increase, which means you will be able to store fewer photos in the memory.

 – Finds the color and light settings appropriate for the current environment. Choose from **Normal**, **Portrait**, **Landscape**, **Sports** or **Night**.

 – The ISO rating determines the sensitivity of the camera's light sensor. The higher the ISO, the more sensitive the camera is. This is useful in darker conditions when you cannot use the flash.

 – Improves colour qualities in different lighting conditions.

 – Applies artistic effects to the pictures.

 – Set a delay after the capture button is pressed. This is ideal if you want to be in the photo.

 – Activate to use your phone's location-based services. Take pictures wherever you are and tag them with the location. If you upload tagged pictures to a blog that supports geotagging, you can see the pictures displayed on a map.

NOTE: This function is only available when GPS is active.

 – Select one of shutter sounds.

 – It automatically shows you the picture you just took.

 – Restore all camera default settings.

 – Touch whenever you want to know how some function operates. This provides you with a quick guide.

TIP! When you exit the camera, some settings return to their defaults, such as white balance, colour tone, timer and scene mode. Check these before you take your next photo.

TIP! The Settings menu is superimposed over the viewfinder so, when you change elements of the photo colour or quality, you see a preview of the image change behind the Settings menu.

Video camera

Getting to know the viewfinder

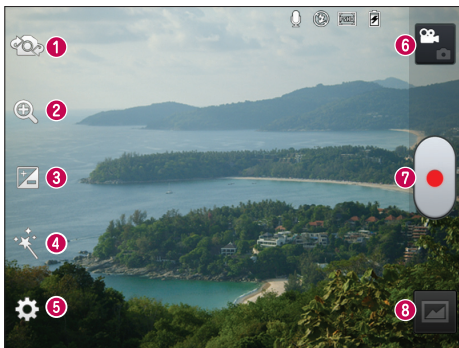

- 1 Swap camera** – Switch between the rear-facing camera lens and the front-facing camera lens.
- 2 Zoom** – Zoom in or out.
- 3 Brightness** – This defines and controls the amount of sunlight entering the video.
- 4 Live effect** – Live effect provides various visual effects when taking a video.
- 5 Settings** – Touch this icon to open the settings menu.
- 6 Camera mode** – Touch this icon to switch to camera mode.
- 7 Start recording**
- 8 Gallery** – Touch to view the last video you recorded. This enables you to access your gallery and view your saved videos from within video mode.

Video camera

Shooting a quick video

- 1 Open the camera application and touch video mode button.
- 2 The video camera viewfinder appears on the screen.
- 3 Holding the phone, point the lens towards the subject you want to capture in your video.
- 4 Press the Record  button once to start recording.
- 5 A red light appears at the top corner of the viewfinder with a timer showing the length of the video.

Tip!

 – Touch to capture image during recording a video.

- 6 Touch  on the screen to stop recording.

After shooting a video

Your captured video will appear on the Gallery. Touch  to view the last video you recorded.

 Touch to play the video.

 Touch to share the video via **Bluetooth, E-mail, Gmail, Google+, Messaging or YouTube.**

 Touch to delete the video you just made. Confirm by touching **OK**. The viewfinder reappears.

Touch  to open the options.

Move – Touch to move the video to other place.

Rename – Tap to edit the name of the selected video.

Details – Tap to see a detailed information, such as the name, date, time, size and type.

Using the advanced settings

Using the viewfinder, touch  to open all the advanced options.

 – Touch if you want to change the viewfinder menu.

 – Switch between the rear-facing camera lens and the front-facing camera lens.

 – Zoom in or zoom out.

 – This defines and controls the amount of sunlight entering the video.

 – Provides various visual effects when recording a video.

 – Allows you to turn on the flash when taking a video in dark conditions.

 – Touch to set the size (in pixels) of the video you are recording.

-  – Improves colour qualities in different lighting conditions.
-  – Choose a colour tone to use for your new view.
-  – Activate to use your phone's location-based services.
-  – Choose **Off** to record a video without sound.
-  – Auto review automatically shows you the video you just recorded.
-  – Restore all video camera default settings.
-  – Touch if you want to know how this function operates. This provides you with a quick guide.

Adjusting the volume when viewing a video

To adjust the volume of a video while it is playing, use the volume keys on the right-hand side of the phone.







Video Wiz

You can make your own movie using your images/video and music.

- 1 From the Home Screen, touch the **Apps Key** > **Video Wiz**.
- 2 Select the desired options to create a movie.



- 1 **Add Media** – Touch this icon add images and/or video to your movie.
 - Touch **Images** to add images, then touch the image(s) you want to add.
 - Touch **Videos** to add video footage, then touch the video(s) you want to add.
 - Touch **OK** to exit after all of the media files have been added.
- 2 **Delete Media** – Touch this icon to remove the selected image(s) and/or video(s).
 - Touch an image or video in the added media contents section, touch **Delete Media** , then touch **Delete selected files** (or **Delete all files**).
- 3 **Add Style** – Touch this icon to select the desired movie style.
 - Touch the up or down arrow to scroll through and select the style you want.
- 4 **Add image/video** – Displays all of the selected image(s) and/or video(s) for your movie.
- 5 **Save** – Touch this icon to save the movie file.
- 6 **Edit** – Touch this icon to edit the movie file.

- Swipe left and right to select the footage to edit.
- Touch the **Overlay Text** icon  to insert text.
- Touch the **Overlay Image** icon  to insert selected graphic(s).
- Touch the **Trim Video** icon  to trim segments from your video footage.
- Touch the **OK** icon  to exit when you're finished editing.
- 7 **Add Music** – Touch this button to set the background music.
- 8 **Preview**  – Touch this icon to play your movie.
- 9 **Help**  – Touch this icon to view information on how to use the Video Wiz application.

Multimedia





You can store multimedia files on a internal memory for easy access to all your multimedia files.





Video Player

Your LG-E974 has a built-in video player that lets you play all your favourite videos. To access the video player, Touch  > **Apps** tab > **Video Player**.

Playing a video

- 1 In the home screen, touch  > **Apps** tab > **Video Player**.
- 2 Select the video you want to play.

	Touch to pause playback a video.
	Touch to resume playback a video.
	Touch to go 10 seconds forward.
	Touch to go 10 seconds backward.
	Touch to manage the video volume.

	Touch to set Dolby audio effect when connected with headset jack.
	Touch Speed controller icon and drag the progress bar to control playback speed.
	Touch Preview frame icon and drag the handler of seek bar to explore the content with a preview screen.
	Touch to lock a video screen.
	Touch the direct list icon to see the list of videos.

To change the volume while watching video, press the up and down volume keys on the righthand side of the phone. Touch and hold any video in the list. It displays **Delete** and **Details** as options.

Gallery

Touch  > **Apps** tab > **Gallery**. Open a list of catalogue bars that store all your multimedia files.

Music Player



Your LG-E974 has a built-in music player that lets you play all your favourite tracks. To access the music player, Touch  > **Apps** tab > **Music Player**.







Transferring music files using USB mass storage devices

- 1 Connect the LG-E974 to a PC using a USB cable.
- 2 If you haven't installed LG Android Platform Driver on your PC, you need to change the settings manually. Choose **Settings** > **Connectivity** > **USB connection type**, then select **Media sync (MTP)**.
- 3 You can view the mass storage content on your PC and transfer the files.

Playing a song

- 1 In the Home screen, touch  > **Apps** tab > **Music Player**.
- 2 Touch **Songs**.
- 3 Select the song you want to play.

	Touch to pause playback.
	Touch to resume playback.

	Touch to skip to the next track in the album, playlist.
	Touch to go back to the beginning of the song. Touch twice to return to the previous song.
	Touch to manage the music volume.
	Touch to set repeat mode.
	Touch to set shuffle mode.
	Touch to see the current playlist.
	Touch to see lyrics. This option is on only if the song includes the lyrics.

To change the volume while listening to music, press the up and down volume keys on the right-hand side of the phone. Touch and hold any song in the list. It displays **Play**, **Add to playlist**, **Set as ringtone**, **Delete**, **Share**, **Search** and **Details**.

NOTE: Music file copyrights may be protected by international treaties and national copyright laws. Therefore, it may be necessary to obtain permission or a licence to reproduce or copy music. In some countries, national laws prohibit private copying of copyrighted material. Before downloading or copying the file, check the national laws of the relevant country concerning the use of such material.

LG Tag+

What is LG Tag+

LG Tag+ allows easy saving and loading to NFC tag, which can be customized to suit certain environments.

Using Tag+ writing

- 1 Touch  > **Apps** tab > **LG Tag+**.
- 2 Select the desired mode (**Car/Office/Sleep/User mode**) and tap **Write on NFC tag**.
- 3 Touch the back of your device to a tag, then launching application and changing settings can be set.

Using Tag+ reading

When touching the set tag, mode will be activated right away.

Media Home

Using media home

- 1 Touch  > **Apps** tab > **Media Home**
- 2 Select the desired function among of videos, photos, music.

Setting media home

- 1 Touch  > **Apps** tab > **Media Home** > **Settings**
- 2 You can change the settings based on your preferences.

Tip!

Once you connect your device to a TV or monitor via a MHL cable, media home apps will be launch automatically when **Media Home** > **Settings** > **Auto-launch and auto-off** option is enabled.

Notebook





With Notebook application, you can manage and personalize a wide variety of information.

Making a note

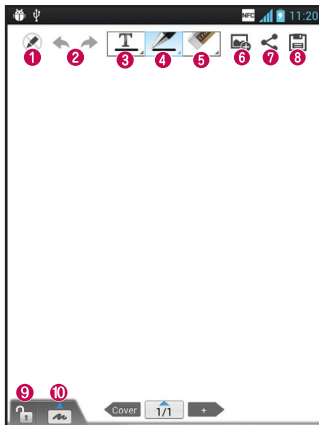





- 1 Touch  > **Apps** tab > **Notebook**.
- 2 Touch **New note** to create a new note.
- 3 Select the desired mode(**Cover, Title, Paper, Paper colour**) and **OK**.

Getting to know the Notebook



- 1  – Select the Read only or edit mode.
- 2  – Undo or Redo.
- 3  – Tap this button to write.
- 4  – Select the Pen type, Thickness, Opacity and Colour.



Notebook

-  – Erase the memo that you created.
-  – Touch to attach the files using Picture, Capture picture, Video, Capture video, Audio, Record voice, Location, Sticker and Date and time.
-  – Share the current note to others via Gmail, E-mail, Social+, Bluetooth, Messaging, Picasa, Google+, Memo.
-  – Save the note with the current screen.
-  – Select to lock or unlock the Front key.
-  – Tap this button to enlarge the input area.

LG SmartWorld

LG SmartWorld offers an assortment of exciting content - games, applications, wallpaper and ringtones - giving LG phone users the chance to enjoy richer "Mobile Life" experiences.

How to Get to LG SmartWorld from Your Phone

- 1 Touch  > **Apps** tab > Tap the  icon to access LG SmartWorld.
- 2 Tap Sign in and enter ID/PW for LG SmartWorld. If you have not yet signed up, tap Register and get a LG SmartWorld membership.
- 3 Download the content you want.

NOTE: What if there is no icon?

- 1 Using a mobile Web browser, access LG SmartWorld (www.lgworld.com) and select your country.
- 2 Download LG SmartWorld App.
- 3 Execute and install the downloaded file.
- 4 Access LG SmartWorld by tapping the .



How to use LG SmartWorld

- Participate in monthly LG SmartWorld promotions.
 -  – Search Content.
 -  – Find contents by category(e.g. Games, Education, Entertainment etc).
 -  – List of downloaded/to-be updated contents.
- Try the easy "Menu" buttons to find what you're looking for fast.
 - Apps for you** – Recommended content based on your previous choices.
 - Settings** – Set Profile and Display.
 - Sign in** – Set your ID and Password.
- Try other useful functions as well. (Content Detail screen)

NOTE: LG SmartWorld may not be available in all carriers or countries.



Utilities

Setting your alarm

- 1 Touch  > **Apps** tab > **Alarm/Clock** > .
- 2 After you set the alarm, the LG-E974 lets you know how much time is left before the alarm will invoke.
- 3 Set **Repeat**, **Snooze duration**, **Vibration**, **Alarm sound**, **Puzzle lock** and **Memo**. Touch **Save**.

NOTE: To change alarm settings on alarm list screen, touch the Menu key and select Settings. You can adjust the below options: Alarm in silent mode, Alarm volume, Side button behavior and Puzzle lock option.

Using your calculator

- 1 Touch  > **Apps** tab > **Calculator**
- 2 Touch the number keys to enter numbers.
- 3 For simple calculations, touch the function you want (+, -, x or ÷) followed by =.
- 4 For more complex calculations, touch , select the **Advanced panel**, then choose sin, cos, tan, log and so on.
- 5 To check history tap the icon .

Adding an event to your calendar

- 1 Touch  > **Apps** tab > **Calendar**
- 2 On the screen, you can find the different view types of the Calendar (Day, Week, Month, Agenda).
- 3 Tap on the date you want to add event on and touch .
- 4 Touch **Event name** then enter the event name.
- 5 Touch **Location** and enter the location. Check the date and enter the time you want your event to start and finish.
- 6 If you want to add a note to your event, touch **Description** and enter the details.
- 7 If you want to repeat the alarm, set **REPEAT**, and set **REMINDERS**, if necessary.
- 8 Touch **Save** to save the event in the calendar.

Tasks

This task can be synchronized with MS Exchange account. You can create task, revise it and delete it in MS outlook or MS Office Outlook Web Access.

To Synchronize MS Exchange

- 1 From the Home Screen, Touch  > Settings.
- 2 Touch Accounts & sync > ADD ACCOUNT.
- 3 Touch Microsoft Exchange to create Email address and Password.
- 4 Make sure if you checkmark Sync task.

Polaris Office

Polaris Office is a professional mobile office solution that lets users conveniently view various types of office documents, including Word, Excel and PowerPoint files, anywhere, anytime, using their mobile devices.

Touch  > **Apps** tab > **Polaris Office**.

Managing files

Polaris Office provides mobile users with convenient file management features, including copying, moving and pasting, and deleting files and folders right on the device.

Viewing files

Mobile users can now easily view a wide variety of file types, including Microsoft Office documents and Adobe PDF, right on their mobile devices. When viewing

documents using Polaris Office, the objects and layout remain the same as in their original documents.

FileShare

This feature allows you to share files from your phone.

- 1 Touch  > FileShare
- 2 Choose the types of content you would like to share. Choose from Images, Videos, Music and Document.

Backup

About backing up and restoring smart phone data

It recommends that you regularly create and save a backup file on the Internal Storage, especially before you update any software. Maintaining a current backup file on Storage memory might allow you to recover smart phone data if your smart phone is lost, stolen, or corrupted by an unforeseen issue.

This Backup application support between LG smart phones, other S/W version or OS. And so, when you buy the new LG smart phone, you can back up the current LG-E974 smart phone data on your new one.

Utilities

If you have preloaded application Backup & Restore on your smart phone, you can back up and restore most of your smart phone data, **Applications** including unprotected applications, their settings, **Applications (Downloaded)**, **Applications (Pre-installed)**, **Bookmarks**, **Calendar**, **Call log**, **Contacts**, **Home screen**, **Messages**, and **System settings** using this application.

- To perform a manual backup of your smart phone data.
- To schedule automatic backups of your smart phone data.
- To restore your smart phone data.

Back up your smart phone data

- 1 Touch  > **Apps** tab > and then select **Backup** > **Backup** > **Internal Storage**.
- 2 Touch the **Add new** to enter a name for your backup file, and then select **Continue**.
- 3 Select the check box next to the item you want to back up, and then select **Continue** to back up.
- 4 When all selected files backed up, you will see the message '**Done**' and

select **Continue** to finish backing up data.

Scheduling automatic backups

You can also enable automatic backups of the data on your smart phone according to your schedule setting. To do this, complete the following steps:

- 1 Touch  > **Apps** tab > and then select **Backup** > **Schedule**.
- 2 On the **Scheduled Backup Location** screen, touch **Internal Storage**.
- 3 From the list, select how often you want to back up your device data and settings, and select **Continue**.
- 4 Select the check box next to the data you want to back up, and then select **Continue** to finish the schedule set.

Restoring smart phone data

To restore data that is in your on-board device memory, mass storage mode must be turned off.

NOTE: All files that are stored on your smart phone are deleted before the backup file is restored.

- 1 Touch  > **Apps** tab > and then select **Backup > Restore > Internal Storage**.
- 2 On the **Restore** screen, select a backup file that contains the data you want to restore.
- 3 Select the check box next to the item you want to restore, and then select **Continue** to restore to phone.

NOTE: Please note that your phone data will be overwritten with the contents of your backup.

- 4 If the backup file is encrypted, type the password that you set to encrypt.
- 5 When all selected files restored, you will see the message '**Done**' and select **Yes** to restart the phone.

NOTE:

- While in Mass storage mode, this Backup Application cannot be functioned. Select Charge only option when the USB cable is connected.
- You can set Enable encryption to encrypt your backup files for extra protection.

Press the **Menu**  from the **Backup** screen, and select **Settings > Security > Enable encryption** and select the check box. To restore synchronised organizer data, you must have an activation password.

NOTE:

You can also enable automatic delete old backups and only keep the most recent backup. Press the **Menu**  from the **Backup** screen, and select **Settings > Scheduled backup > Auto delete old backups** to select the number of scheduled backups to keep.

The web

Internet

Browser gives you a fast, full-colour world of games, music, news, sport, entertainment and much more, right on your mobile phone. Wherever you are and whatever you enjoy.

NOTE: Additional charges apply when connecting to these services and downloading content. Check data charges with your network provider.

Using the web toolbar



Touch to go back a page.



Touch to go forward a page, to the page you connected to after the current one. This is the opposite of what happens when you press the **Back** key, which goes to the previous page.



While holding down the icon, tilt the device toward body to zoom in or reverse to zoom out.



Touch to add a new window.



Touch to access bookmarks.

Using options

Press  to view options.

Refresh – Update the current web page.

Save to bookmarks – Add the current web page as bookmark.

Go to Homepage – Allow you to go to a homepage.

Share page – Allows you to share the web page with others via Bluetooth, E-mail, Gmail, Google+, Messaging, Social+.

Find on page – Allows you to find letters or words on the current web page.

Request desktop site – Allows you to view the web page as desktop.

Save for offline reading – Save current page to read it during offline.

Brightness – Modify viewing brightness for comfortable web browsing.

Settings – Displays Browser settings.

Exit – Exit from the browser.

Settings

In the home screen, touch  > **Apps** tab > **Settings**.

WIRELESS & NETWORKS

Here, you can manage Wi-Fi and Bluetooth. You can also set up mobile networks and switch to airplane mode.

< Wi-Fi >

Wi-Fi – Turns on Wi-Fi to connect to available Wi-Fi networks.

TIP! How to obtain the MAC address

To set up a connection in some wireless networks with MAC filters, you may need to enter the MAC address of your LG-E974 into the router.

You can find the MAC address in the following user interface: Touch

Apps tab > **Settings** > **Wi-Fi** >  > **Advanced** > **MAC address**.

< Bluetooth >

Turns on Bluetooth to connect to Bluetooth devices.

< Data usage >

Displays the data usage and set mobile data usage limit.

< Call >

You can configure phone call settings such as call forwarding and other special features offered by your carrier.

< More >

Airplane mode – After switching to airplane mode, all wireless connections are disabled.

Wi-Fi Direct – Make a connection directly with Wi-Fi devices without any Access Point.

Portable Wi-Fi hotspot – Allows you to share mobile network via Wi-Fi and you can configure the portable Wi-Fi hotspot settings.

NFC – Your LG-E974 is NFC-enabled mobile phone. NFC (Near Field Communication) is a wireless connectivity technology that enables two-way communication between electronic devices. It operates over a distance of a few centimeters. You can share your contents with a NFC tag or another NFC support device via simple touch with your device. If you touch a NFC tag with your device, it will display the tag contents on your device.

To switch NFC on or off: From the home screen, touch and slide the

Settings

notification drawer down with your finger, then select the NFC icon to turn it on.

NOTE: When the Airplane mode is activated, NFC application can be used.

Using NFC: To use NFC, make sure your device is switched on and activate the NFC, if disabled.

Android Beam – You can beam a web page, a video, or other content from your screen to another device by bringing the devices together (typically back to back).

NOTE: Make sure both devices are unlocked, support Near Field Communication (NFC), and have both NFC and Android Beam™ turned on.

VPN – Displays the list of Virtual Private Networks (VPNs) that you've previously configured. Allows you to add different types of VPN.

Mobile networks – Set options for data roaming, network mode & operators, access point names (APNs) and so on.

NOTE: You must set a lock screen PIN or password before you can use credential storage.

DEVICE

< Sound >

Sound profile – You can choose the Sound, Vibrate only or Silent.

Volumes – You can manage the volume of Phone Ringtone, Notification sound, Touch feedback & system, Music, video, games and other media, Alarms.

Phone ringtone – Allows you to set your default incoming call ringtone.

Notification sound – Allows you to set your default notification ringtone.

Ringtone with vibration – Vibration feedback for calls and notifications.

Quiet time – Set times to turn off all sounds except alarm and media.

Dial pad touch tones – Allows you to set the phone to play tones when using the dialpad to dial numbers.

Touch sounds – Allows you to set your phone to play a sound when you touch buttons, icons and other onscreen items that react to your touch.

Screen lock sound – Allows you to set your phone to play a sound when locking and unlocking the screen.

Vibrate on touch – Allows you to set the vibration feedback for phone screen touch.

< Display >

Brightness – Adjust the screen brightness.

Auto-rotate screen – Set to switch orientation automatically when you rotate the phone.

Screen timeout – Set the time for screen timeout.

Font type – Change the type of the display font.

Font size – Change the size of the display font.

Aspect ratio correction – Change the resolution size of downloaded applications to fit the screen size.

Front key light – Set the front key light duration.

Motion sensor calibration – Allows you to improve the accuracy of the tilt and speed of the sensor.

< Home screen >

Set the **Theme**, **Animation**, **Screen swipe effect** or **Wallpaper**. Select the option to set **Scroll wallpaper**, **Scroll screens circularly** and **Home backup & restore**.

< Lock screen >

Select screen lock – Set a screen lock type to secure your phone. Opens a set of screens that guide you through drawing a screen unlock pattern. You can set among of **None**, **Swipe**, **Face Unlock**, **Pattern**, **PIN**, **Password**.

If you have enabled Pattern lock type then , When you turn on your phone or wake up the screen, you're asked to draw your unlock pattern to unlock the screen.

Wallpaper – You can select the wallpaper for lockscreen from Wallpapers or Gallery.

Clocks & shortcuts – Customize clocks & shortcuts on lock screen.

Owner info – Show owner info on lock screen.

Lock timer – Set the lock time after screen timeout.

Power button instantly locks – Set the screen lock when press the power button.

< Gesture >

Move home screen items – Press and hold item and tilt device to move item within home screens or applications.

Tilt sensitivity – Test and adjust sensitivity of tilt sensor for home screen and applications.

Settings

Silence incoming calls – Flip device to mute incoming call.

Snooze or stop alarm – Flip device to snooze or stop alarm.

Pause video – Flip device to pause playing video.

Help – Help for gesture functions.

< Storage >

INTERNAL STORAGE – View the internal storage usage.

< Power saver >

Here, you can manage the battery and check the power saving items. Also, you can check the battery use.

< Apps >

You can view and manage the applications.

PERSONAL

< Accounts & sync >

Permits applications to synchronise data in the background, whether or not you are actively working in them. Deselecting this setting can save battery power and lowers (but does not eliminate) data usage.

< Location services >

Google's location service – If you select Google's location service, your phone determines your approximate location using Wi-Fi and mobile networks. When you select this option, you're asked whether you consent to allowing Google to use your location when providing these services.

GPS satellites – If you select GPS satellites, your phone determines your location to street level accuracy.

Location & Google search – If you select google use your location to improve search results and other services.

< Security >

Set up SIM card lock – Set up Micro-USIM card lock or change the Micro-USIM PIN.

Password typing visible – Show last character of the hidden password as you type.

Device administrators – View or deactivate device administrators.

Unknown sources – Default setting to install non-Market applications.

Trusted credentials – Display trusted CA certificates.

Install from storage – Choose to install encrypted certificates.

Clear credentials – Remove all certificates.

< **Language & input** >

Use the Language & input settings to select the language for the text on your phone and for configuring the on-screen keyboard, including words you've added to its dictionary.

< **Backup & reset** >

Change the settings for managing your settings and data.

Back up my data – Set to back up your settings and application data to the Google server.

Backup account – Set to back up your account.

Automatic restore – Set to restore your settings and application data when the applications are reinstalled on your device.

Factory data reset – Reset your settings to the factory default values and delete all your data. If you reset the phone in this way, you are prompted to reenter the same information as when you first started Android.

SYSTEM

< **Date & time** >

Use **Date & time** settings to set how dates are displayed. You can also use these settings to set your own time and time zone rather than obtaining the current time from the mobile network.

< **Accessibility** >

Use the **Accessibility** settings to configure accessibility plug-ins you have installed on your phone.

NOTE: Requires additional plug-ins to become selectable.

< **Connectivity** >

USB connection type – You can set the desired mode (**Charge only**, **Media sync (MTP)**, **USB tethering**, **LG software** or **Camera (PTP)**).

Ask on connection – Ask USB connection mode when connecting to a computer.

Help – Help for connectivity.

On-Screen Phone – Displaying screen and controlling phone from PC are available through USB, Bluetooth or Wi-Fi connection.

PC Suite – Check mark this to use **LG PC Suite** with Wi-Fi connection.

Settings

Please note that Wi-Fi network should be connected for LG PC Suite via Wi-Fi connection from the WIRELESS & NETWORKS.

< About phone >

View legal information and check phone status and software version.

Phone software update

LG Mobile phone software update from the Internet

For more information about using this function, please visit <http://update.lgmobile.com> or <http://www.lg.com/common/index.jsp> → select country and language.

This feature allows you to update the firmware on your phone to a newer version conveniently from the Internet without needing to visit a service centre. This feature will only be available if and when LG makes a newer firmware version available for your device.

As the mobile phone firmware update requires the user's full attention for the duration of the update process, please make sure you check all instructions and notes that appear at each step before proceeding. Please note that removing the

USB data cable during the upgrade may seriously damage your mobile phone.

NOTE: LG reserves the right to make firmware updates available only for selected models at its own discretion and does not guarantee the availability of the newer version of the firmware for all handset models.

LG Mobile Phone software update via Over-the-Air (OTA)

This feature allows you to update your phone's software to a newer version conveniently via OTA, without connecting with a USB data cable. This feature will only be available if and when LG makes a newer firmware version available for your device.

First, you can check the software version on your mobile phone: **Settings > About phone > Software update > Check now for update.**

You can also delay the update by 1 hour, 4 hours, 8 hours or One day. In this case, the application will notify you to update when the time is up. You can also rearrange an update manually.

NOTE: Your personal data from internal phone storage—including information about your Google account and any other accounts, your system/application data and settings, any downloaded applications and your DRM licence—might be lost in the process of updating your phone's software. Therefore, LG recommends that you back up your personal data before updating your phone's software. LG does not take responsibility for any loss of personal data.

NOTE: This feature is dependent on your network service provider, region and country.

DivX HD **DivX**[®] HD

ABOUT DIVX VIDEO: DivX[®] is a digital video format created by DivX, LLC, a subsidiary of Rovi Corporation. This is an official DivX Certified[®] device that plays DivX video. Visit divx.com for more information and software tools to convert your files into DivX videos.

ABOUT DIVX VIDEO-ON-DEMAND: This DivX Certified[®] device must be registered in order to play purchased DivX Video-

on-Demand (VOD) movies. To obtain your registration code, locate the DivX VOD section in your device setup menu. Go to vod.divx.com for more information on how to complete your registration.

DivX Certified[®] to play DivX[®] video up to HD 720p, including premium content DivX[®], DivX Certified[®] and associated logos are trademarks of Rovi Corporation or its subsidiaries and are used under license.



Manufactured under license under U.S. Patent Nos: 5,956,674; 5,974,380; 6,487,535 & other U.S. and worldwide patents issued & pending. DTS, the Symbol, & DTS and the Symbol together are registered trademarks & DTS 2.0+Digital Out is a trademark of DTS, Inc. Product includes software. © DTS, Inc. All Rights Reserved.

Dolby Mobile 

Manufactured under license from Dolby Laboratories. Dolby and the double-D symbol are trademarks of Dolby Laboratories.

Accessories

These accessories are available for use with the LG-E974. (Items described below may be optional.)

Travel adaptor



Stereo headset



User Guide

Learn more about your LG-E974.



Data cable

Connect your LG-E974 and PC.



LG Tag+



Micro-USIM Slot Pin



Rubberdium™ Pen



Notice: You can use more convenient if you are use the Rubberdium Pen for homescreen touch. However, the bottom button (back/home/recently apps/menu button) is not run to Rubberdium Pen. Please use your finger directly.

WARNING: Do not touch strongly and rub such as sharp edges

NOTE:

- Always use genuine LG accessories.
- Failure to do this may void your warranty.
- Accessories may vary in different regions.

Troubleshooting

This chapter lists some problems you might encounter while using your phone. Some problems require you to call your service provider, but most are easy to fix yourself.

Message	Possible causes	Possible corrective measures
Micro-USIM error	There is no Micro-USIM card in the phone or it is inserted incorrectly.	Make sure that the Micro-USIM card is correctly inserted.
No network connection/ Losing network	Signal is weak or you're outside the carrier network.	Move towards a window or into an open area. Check the network operator coverage map.
	Operator applied new services.	Check whether the Micro-USIM card is more than 6~12 months old. If so, change your Micro-USIM at your network provider's nearest branch. Contact your service provider.
Codes do not match	To change a security code, you will need to confirm the new code by re-entering it.	If you forget the code, contact your service provider.
	The two codes you have entered do not match.	

Troubleshooting

Message	Possible causes	Possible corrective measures
Any application cannot be set	Not supported by service provider or registration required.	Contact your service provider.
Calls not available	Dialling error	New network not authorised.
	New Micro-USIM card inserted.	Check for new restrictions.
	Pre-paid charge limit reached.	Contact service provider or reset limit with PIN2.
Phone cannot be switched on	On/Off key pressed too briefly.	Press the On/Off key down for at least two seconds.
	Battery is not charged.	Charge battery. Check charging indicator on the display.

Message	Possible causes	Possible corrective measures
Charging error	Battery is not charged.	Charge battery.
	Outside temperature is too hot or cold.	Make sure phone is charging at a normal temperature.
	Contact problem	Check the charger and connection to the phone.
	No voltage	Plug the charger into a different socket.
	Charger defective	Replace charger.
	Wrong charger	Only use original LG accessories.
Number not permitted	The Fixed dialling number function is on.	Check the Settings menu and turn the function off.
Impossible to receive / send SMS & picture	Memory full	Delete some messages from the phone.
Files not opening	Unsupported file format	Check the file formats that can be supported.

Troubleshooting

Message	Possible causes	Possible corrective measures
The screen does not turn on when I receive a call.	Proximity sensor problem	If you use any protection tape or case, check to see if it has covered the area around the proximity sensor. Make sure that the area around the proximity sensor is clean.
No sound	Vibration mode	Check the settings status of the sound menu to make sure you are not in vibrate or silent mode.
Hang up or freeze	Intermittent software problem	Try to perform a software update via the website.