



Description of Functional Blocks

EBR64966601

Rev A, Jan 2010



< EBR64966601 >

LG Electronics
Hanyang Univ. 1271, Sa-dong, Sangrok-gu ,
Ansan-si, Gyeonggi-do 426-791, Korea
Tel:82-31-436-7653
Fax:82-31-436-7991
www.lge.com

1. RF Transmitter Block

1.1 Transmitter Feature

The transmitter part of RF-Receiver is internally based on direct synthesis of the RF frequency. The frequency synthesizer includes a completely on-chip LC VCO and a 90 degrees phase shifter for generating the I / Q LO signals to the down-conversion mixers in receive mode. The baseband transmit data is digitally 2-FSK/GFSK/MSK modulated in the modem block and up-converted to the 2.4 GHz ISM band in the transmitter path. The transmitter path consists of Modulator, I/Q up-conversion through frequency synthesizer, high-output power amplifier (PA). RF-Receiver also uses MSK modulation schemes for 250kbps.

1.1.1 Digital Modulator

RF-Receiver supports frequency and phase shift modulation formats (2-FSK/GFSK/MSK). It is suited for systems targeting compliance with digital modulation systems as defined by FCC part 15.247. Also, the sync word is a 16 bit configurable field (can be repeated to get a 32 bit) that is automatically inserted at the start of the packet by the modulator in transmit mode.

1.1.2 Digital Demodulator and Symbol Synchronizer and Data Decision

The RF-Receiver contains an advanced and highly configurable demodulator. Channel filtering and frequency offset compensation is performed digitally. When using MSK modulation, the demodulator will compensate for the offset between the transmitter and receiver frequency, within certain limits, by estimating the centre of the received data. The bit synchronization algorithm extracts the clock from the incoming symbols. Byte synchronization is achieved by a continuous sync word search. The demodulator uses this field to find the byte boundaries in the stream of bits.

1.1.3 Power Amplifier

The integrated PA for the RF-Receiver can transmit at a maximum power of +1dBm. In some applications it may be necessary to extend the link range. Adding an external power amplifier is the most effective way of doing this. The power amplifier should be inserted between the antenna and the balun, and two. T/R switches are needed to disconnect the PA in RX mode.

2. RF Receiver Block

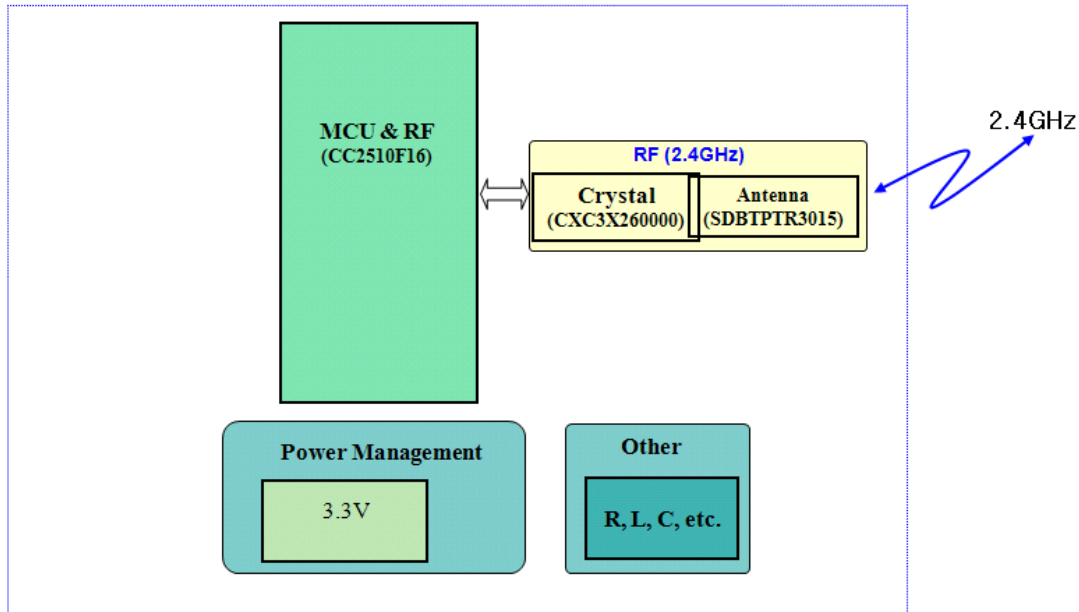

2.1 Receiver Feature

The RF-Receiver features a low-IF receiver. The received RF signal is amplified by the low noise amplifier (LNA) and down-converted in quadrature (I and Q) to the intermediate frequency (IF). At IF, the I/Q signals are digitized by the ADCs. Automatic gain control (AGC), fine channel filtering, demodulation bit/packet synchronization are performed digitally.

2.1.1 Digital Demodulator and Symbol synchronizer

The digital demodulator and bit synchronizer takes the low IF received signal and performs an optimal frequency tracking and bit/byte symbol synchronization algorithm as like a transmit part. If the sync word detection in RX is enabled, the sync word will also function as a system identifier since only packets with the correct predefined sync word symbol will be received.

2.1.2 Received Signal Qualifiers and Link Quality Information

The RF-Receiver has several qualifiers that can be used to increase the likelihood that a valid sync word is detected. Preamble Quality Indicator for detecting preambles and improved protection against sync word detection in random noise. To generate the RSSI level, the signal level in the channel is estimated. Data filtering is also included for enhanced performance

3. Baseband Core

The RF-Receiver is based on the industry leading CC2500 radio core. It has few external components (On-chip frequency synthesizer, no external filters or RF switch needed). It also flexibly manage for packet oriented systems (On-chip support for sync word detection, address check, flexible packet length, and automatic CRC handling). With Supports use of DMA for both RX and TX it results in minimal CPU intervention even on high data rates. In addition to It is programmable for channel filter bandwidth

4. Microprocessor Unit

The RF-Receiver includes an 8-bit CPU core which is an enhanced version of the industry standard 8051 core. It has 16kB in-system programmable flash, and 2 kB RAM. Also it supports various and useful peripheral components (I2S interface, 7 - 12 bit ADC with up to eight inputs, 128-bit AES security coprocessor, Powerful DMA functionality, Two USARTs, 16-bit timer with DSM mode, Three 8-bit timers, Hardware debug support)

5. Crystal Interface and Clock Generation

The RF-Receiver uses a fractional-N synthesizer to generate the radio frequencies, clock, and data packet timing. This enables it to operate from any of a multitude of frequency sources. System clock source is either a high speed crystal oscillator (24 - 27 MHz) or a high speed RC oscillator (12 - 13.5 MHz). The high speed crystal oscillator must be used when the radio is active. To reduce system power consumption, clock source for ultra-low power operation can be either a low-power RC oscillator or external 32.768KHz crystal. The RF-Receiver's reference frequency reference setting is a 26-MHz crystal in active mode and internal low RC oscillator in low power mode.

This device complies with part 15 of FCC Rules. Operation is subject to the following two conditions:

1. This device may not cause harmful interference received.
2. This device must accept any interference received. Including interference that may cause undesired operation.

FCC WARNING

This equipment may generate or use radio frequency energy.

Changes or modifications to this equipment may cause harmful interference unless the modifications are expressly approved in the instruction manual. The user could lose the authority to operate this equipment if an unauthorized change or modification is made.

To satisfy FCC exterior labeling requirements, the following text must be placed on the exterior Of the end product.

Contains Transmitter Module FCC ID: BEJEBR64966601

CAUTION: This device and it ' s antenna(s) must not be co - located or operated in conjunction with any other antenna or transmitter. End users cannot modify this transmitter device. Any Unauthorized modification could void the user ' s authority to operate this device.