

ATTACHMENT J –USERS MANUAL

FCC Warning

Class B Computing Device

Information to the User

This equipment has been tested and found to comply with the limits for a class B digital device pursuant to part 15 of FCC Rules. These limits are designed to provide reasonable protection against harmful interference in a residential installation. This equipment generates, uses, and can radiate radio frequency energy and, if not installed and used in accordance with the instructions, may cause harmful interference to radio communications. However, there is no guarantee that interference will not occur in a particular installation. If this equipment does cause interference to radio or television reception, which can be determined by turning the equipment off and on, the user is encouraged to try to correct the interference by one or more of the following measures:

- Reorient or relocate the receiving antenna.
- Increase the separation between the equipment and receiver.
- Connect the equipment into an outlet on a circuit different from that to which the receiver is connected.
- Consult the dealer or an experienced radio/TV technician for help and for additional suggestions.

The user may find the following booklet prepared by the Federal Communications Commission helpful: "How to Identify and Resolve Radio-TV Interference Problems." This booklet is available from the U.S. Government Printing Office, Washington, D.C. 20402, Stock No. 004-000-00345-4.

FCC Warning

The user is cautioned that changes or modifications not expressly approved by the manufacturer could void the user's authority to operate the equipment.

NOTE: In order for an installation of this product to maintain compliance with the limits for a Class B device, shielded cables must be used.



FLATRON 776FM

Color Monitor



<http://www.lg.com>

User's Guide
Benutzerhandbuch
Manuel d'utilisation
Guida Utente
Guia del Usuario
Manual do proprietário
Handleiding

Please read this manual carefully before operating your set.
Retain it for future reference.

Record model number and serial number of the set.

See the label attached on the back cover and quote this information to your dealer when you require service.

P/NO : 3828TUL- (0109-Rev00)

Printed in Korea



Contents

INTRODUCTION

Introduction	A1
Connecting the Monitor.....	A2
Location and Function of Controls	A4
Control Panel Function	A5
On Screen Display (OSD) Control Adjustment	A7
On Screen Display(OSD) Selection and Adjustment	A8
Sound Selection and Adjustment	A10
Video Memory Modes	A11
Troubleshooting	A12
Specifications	A13

DEUTSCH

Einleitung	B1
Anschließen	B2
Ort und Funktion der Bedienungselemente	B4
Bedienungselemente der Bildkontrolle.....	B5
On Screen Display (OSD) Anpassung	B7
OSD Einstellung und Auswahlssymbole	B8
Ton Einstellung und Auswahlssymbole	B10
Videospeichermodi	B11
Störungen	B12
Produktbeschreibung	B13

FRANÇAIS

Introduction	C1
Branchement du Moniteur	C2
Nomenclature et Fonctions	C4
Fonctions du Panneau de Commande.....	C5
Réglage des Commandes Affichage Écran.....	C7
Options de sélection et de Réglage OSD (affichage écran)	C8
Son de Sélection et de Réglage	C10
Mise en Mémoire de Modes Vidéo.....	C11
Quelques Conseils en Cas D'incident	C12
Spécifications D'entree	C13

ITALIANO

Introduzione	D1
Collegamento del Monitor	D2
Posizione e Funzione dei Conando di Controllo ..	D4
Funzione del Pannello di Controllo.....	D5

Controllo Regolazione On Screen Display (OSD)	D7
Elementi di Selezione e Regolazione dell'OSD.....	D8
Souno di Selezione e Regolazione	D10
Modalità di Memoria Video	D11
In Caso di Problemi	D12
Specifiche.....	D13

ESPAÑOL

Introducción	E1
Conectando el Monitor	E2
Ubicación y Función de los Controles	E4
Función del Panel de Control	E5
Ajuste del Control de Exhibición en Pantalla (OSD)	E7
Ajuste del OSD y Selección de Elementos	E8
Ajuste del Sonido y Selección de Elementos.....	E10
Modos de Memoria de Video	E11
Sugerencias para Localizar las Fallas	E12
Especificaciones	E13

PORTUGUÊS

Introdução.....	F1
Conectando o Monitor	F2
Posição dos Controles e Descrição	F4
Funções do Painel de Controle	F5
Ajuste On Screen Display(OSD)	F7
Ajustes OSD e Itens de Seleção	F8
Ajustes Som e Seleção	F10
Modos de Memória de Vídeo	F11
Resolvendo Problemas.....	F12
Especificações	F13

NETSPEK

Inleiding	N1
De Monitor Aansluiten	N2
De plaatsing en de werking van de knoppen.....	N4
Het bedieningspaneel	N5
Bediening via het beeldscherm OSD (On Screen Display)	N7
Kiezen en instellen via het OSD-systeem.....	N8
Selectie en aanpassing van het geluid	N10
Modi voor videogeheugen.....	N11
Problemen oplossen	N12
Specificaties	N13

Introduction



Thank you for purchasing a high resolution monitor. It will give you high resolution performance and convenient reliable operation in a variety of video operating modes.

ENGLISH

Features

- The monitor is a 17 inches (16.0 inches viewable) intelligent, microprocessor based monitor compatible with most analog RGB (Red, Green, Blue) display standards, including IBM PC®, PS/2®, Apple®, Macintosh®, Centris®, Quadra®, and Macintosh II family.
- The monitor provides crisp text and vivid color graphics with VGA, SVGA, XGA, and VESA Ergonomic modes (non-interlaced), and most Macintosh compatible color video cards when used with the appropriate adaptor. The monitor's wide compatibility makes it possible to upgrade video cards or software without purchasing a new monitor.
- Digitally controlled auto-scanning is done with the micro-processor for horizontal scan frequencies between 30 and 70kHz, and vertical scan frequencies between 50-160Hz.
- This monitor is capable of producing a maximum horizontal resolution of 1280 dots and a maximum vertical resolution of 1024 lines.
- The microprocessor-based digital controls allow you to adjust conveniently a variety of image controls by using the OSD (On Screen Display).
- On Screen Display (OSD) adjustments in 11 languages: English, German, French, Spanish, Italian, Swedish, Finnish, Portuguese, Korean, Chinese and Russian.
- Plug and play capability if supported by your system.
- This monitor has DDC 2B function.*
- Compliant with the following regulated specifications :*
 - EPA ENERGY STAR
 - Swedish MPRII
 - Swedish TCO'99

**For detailed information, please refer to the Reference Guide provided .*

Connecting the Monitor

- Turn off the equipment and all attached options.
- Carefully set the monitor face-down with the underside facing you.

Installation

1. Align the hooks on the tilt/swivel stand with the matching slots in the base of the monitor.
2. Insert the hooks into slots.
3. Slide the tilt/swivel stand toward the front of the monitor until the latches click into the locked position.

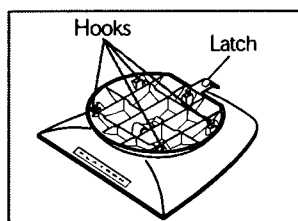
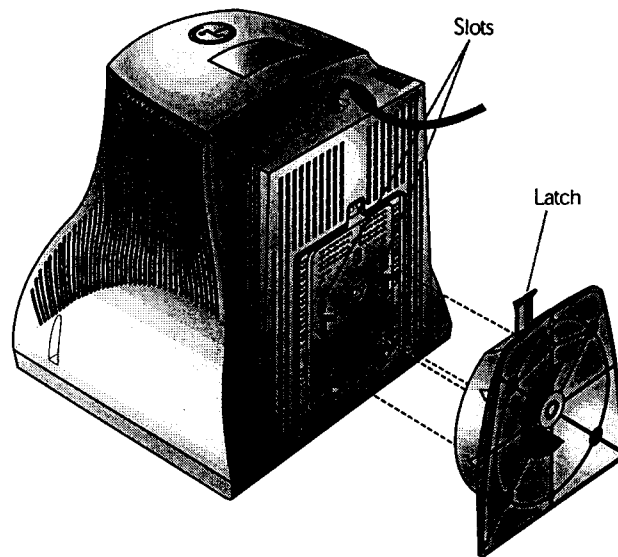

Connecting the Monitor

On the back of the monitor are two plug-in connections; one for the AC power cord, and the other for the signal cable from the video card.

- 1 Power off both the monitor and PC.
- 2 Connect the 15 pin VGA connector of the supplied signal cable to the output VGA video connector on the PC and the matching input connector on the rear of the monitor. The connectors will mate only one way. If you cannot attach the cable easily, turn the connector upside down and try again. When mated, tighten the thumbscrews to secure the connection.
- 2 Locate the appropriate MAC to VGA adapter block at your local computer store. This adapter changes the high density 3 row 15 pin VGA connector to the correct 15 pin 2 row connection to mate with your MAC. Attach the other end of the signal cable to the side of the adapter block with 3 rows.

Connect the attached adapter block/signal cable to the video output on your MAC.

- 3 One end of the AC power cord is connected into the AC power connector on the back of the monitor. The other end is plugged into a properly grounded three-prong AC outlet.
- 4 Power on the PC, then the monitor.
- 5 If you see the SELF DIAGNOSTICS message, check the signal cable and connectors.
- 6 After using the system, power off the monitor, then the PC.

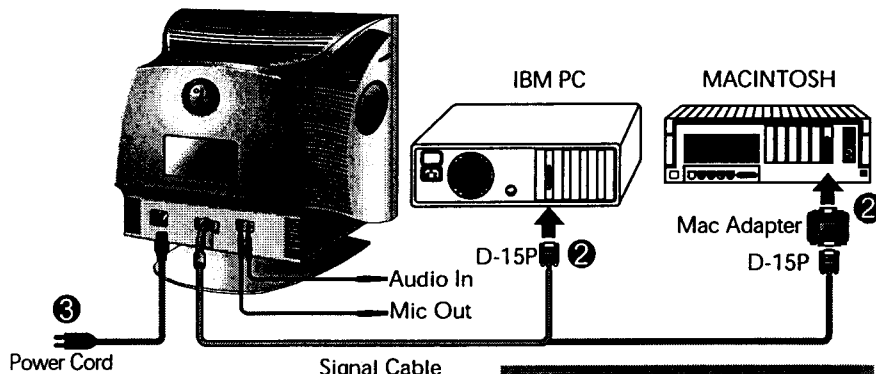

NOTE: The Apple Adapter block is not available in all countries. If you are unable to find one, you may use a standard 15 pin D-sub connector cable with a 3 row connector on the Macintosh side.

Location and Function of Controls

Front View

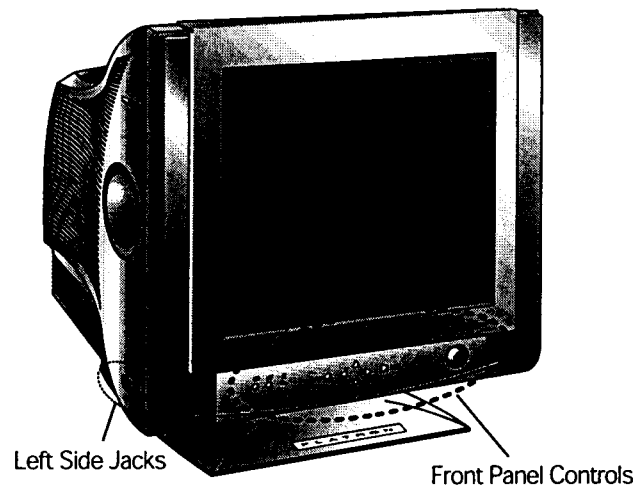



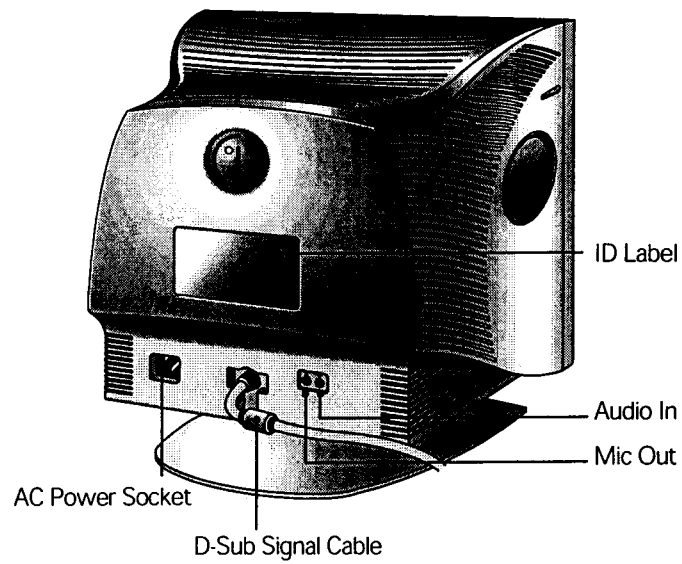



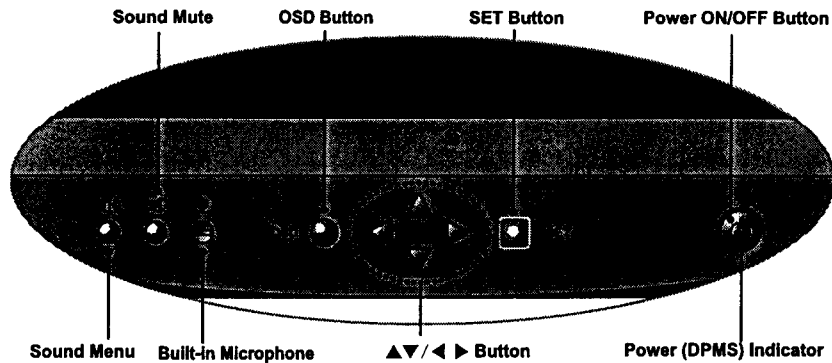

Rear View



Control Panel Function



Front Panel Controls



Control	Function
 Sound Menu	To adjust sound menu.
 Sound Mute	Used to select mute on (means sound off) and mute off (means sound on).
 Built-in Microphone	Built-in Microphone.
 OSD Button	Use this button to enter or exit the on screen display.
 ▲▼/◀▶ Button	Use these buttons to choose or adjust items in the on screen display.
 SET Button	Use this button to enter a selection in the on screen display.
 Power ON/OFF Button	Use this button to turn the monitor on or off.
Power (DPMS) Indicator	The power indicator light is shown in the power button. This Indicator lights up green when the monitor operates normally. If the monitor is in DPM (Energy Saving) mode (stand-by/suspend/power off), this indicator color changes to amber.

Control Panel Function

Left Side Jacks

	 Headphone Jack	Headphone Jack that automatically mutes the speaker volume when headphone is attached.
	 Microphone Jack	An external microphone can be used instead of the built-in microphone.

Rear Panel Jacks

	Mic. Out	Connects microphone sound to PC via cable.
	Audio In	Connects speaker sound to PC via cable attachment.

Microphone Operation

On the left side there is a MIC (Microphone) jack. By plugging a microphone in here, it may reduce the long length of cable needed to reach the PC's sound card. In order to use this MIC jack, you need to use a cable (supplied) to plug into the rear of the monitor (MIC OUT) and into the MIC input jack of your sound card (if available).

Audio Features

A major feature of this monitor is its built-in audio system. This conveniently integrates a stereo audio amplifier and speakers without taking up any more space. Because the monitor is designed like this, you can easily upgrade to audio capable multimedia applications by attaching your PC with sound card to the back of this monitor. It will result in significantly less cabling and space requirements.

On Screen Display (OSD) Control Adjustment

Making adjustments to the image size, position and operating parameters of the monitor are quick and easy with the On Screen Display Control system. A quick example is given below to familiarize you with the use of the controls. Following section is an outline of the available adjustments and selections you can make using the OSD.

NOTE

To make adjustments in the On Screen Display, follow these steps:

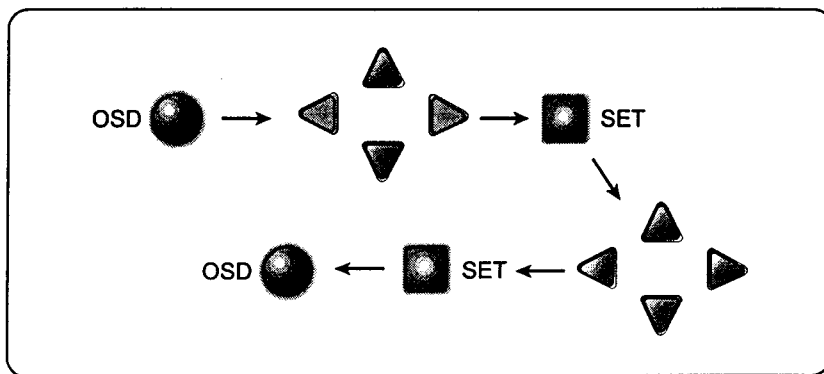





- 1 Press the OSD Button, then the main menu of the OSD appears.
- 2 To access a control, use the \triangle or ∇ Buttons. When the icon you want becomes highlighted, press the SET Button.
- 3 Use the \triangle / ∇ / \triangleleft / \triangleright Buttons to adjust the item to the desired level.
- 4 Accept the changes by pressing the SET Button.
- 5 Exit the OSD by pressing the OSD Button.

On Screen Display(OSD) Selection and Adjustment

You were introduced to the procedure of selection and adjusting an item using the OSD system. Listed below are the icons, icon names, and icon descriptions of the items that are shown on the Menu.

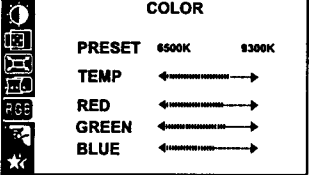
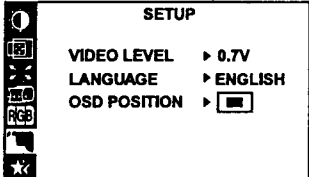
OSD Adjust	Description
	<p> Brightness Used to adjust the brightness of the screen.</p> <p> Contrast Adjust the display to the contrast desired.</p>
	<p> Vertical Position To move image up and down.</p> <p> Horizontal Position To move picture image left and right.</p>
	<p> Vertical Size To adjust image height.</p> <p> Horizontal Size To adjust image width.</p>
	<p> Tilt To correct image rotation.</p> <p> Side Pincushion To correct the bowing in and out of the image.</p> <p> Side pincushion balance To correct the balance of both sides bowing.</p> <p> Parallelogram This control adjusts for a skewing of the screen image.</p> <p> Trapezoid To correct geometric distortion.</p> <p> Corner Top To correct the irregular distortion of the displayed image.</p> <p> Corner Bottom To correct the irregular distortion of the displayed image.</p>

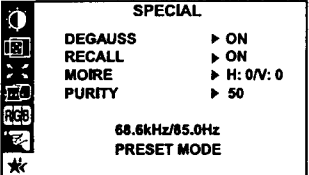
On Screen Display(OSD) Selection and Adjustment

OSD Adjust	Description
 <p>COLOR</p> <p>PRESET 6500K 9300K</p> <p>TEMP ←→</p> <p>RED ←→</p> <p>GREEN ←→</p> <p>BLUE ←→</p>	<p>PRESET 6500K / 9300K To appear the displays color temperature.</p> <ul style="list-style-type: none"> • 6500K : Slightly reddish white. • 9300K : Slightly bluish white. <p>TEMP User easily color set without adjustment Red, Green and Blue (R/G/B).</p> <p>RED To set your own color levels.</p> <p>GREEN To set your own color levels.</p> <p>BLUE To set your own color levels.</p>
 <p>SETUP</p> <p>VIDEO LEVEL ▶ 0.7V</p> <p>LANGUAGE ▶ ENGLISH</p> <p>OSD POSITION ▶ </p>	<p>VIDEO LEVEL This item is used to select the monitor's input signal level. The normal level used for most PC's is 0.7V. When the screen suddenly gets brightened or blurry, please select 1.0V and try again.</p> <p>LANGUAGE To choose the language in which the control names are displayed.</p> <p>OSD POSITION To adjust position of the OSD window on the screen.</p>
 <p>SPECIAL</p> <p>DEGAUSS ▶ ON</p> <p>RECALL ▶ ON</p> <p>MOIRE ▶ H: 0/V: 0</p> <p>PURITY ▶ 50</p> <p>68.6kHz/85.0Hz</p> <p>PRESET MODE</p>	<p>DEGAUSS To manually demagnetize the screen which may show some image or color incorrectly.</p> <p>RECALL You can use this function when you want to go back to the screen display of the time you purchased the product after adjusting to modify it in the Preset Mode.</p> <p>When you are in the User mode, you can recall only  items.</p> <p>After using Recall, adjust the screen display again if necessary. If you want more information on the Preset Mode, refer to A11 page.</p> <p>MOIRE This item allows you to reduce the moire (Moire is caused by interference Horizontal Scan Line with the periodical dot screen). It is normally OFF(H:0/V:0).</p> <p>The moire adjustments may affect the focus of the screen. The screen image may shake slightly while the moire reduction function is on.</p> <p>PURITY Use to adjust the overall purity of the image if the color appears uneven.</p>

Sound Selection and Adjustment

You were introduced to the procedure of selection and adjusting an item using the OSD system. Listed below are the icons, icon names, and icon descriptions of the items that are shown on the main Menu.

To make adjustments in the On Screen Display, follow these steps:

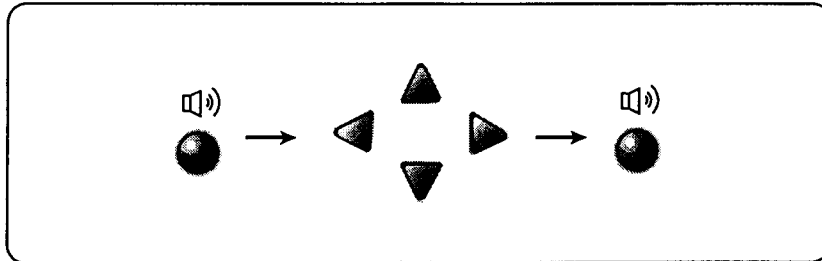

OSD Adjust	Description
	VOLUME Raises or lowers audio level.
	TREBLE Raises or lowers treble level.
	BASS Raises or lowers bass level.
	BALANCE Changes balance of left/right speaker level.
	MICROPHONE Enables or disables microphone usage.

Video Memory Modes

The monitor has 34 memory locations for display modes, 10 of which are factory preset to popular video modes.

Display Modes (Resolution)

Display Modes (Resolution)	Horizontal Freq.(kHz)	Vertical Freq.(Hz)
1 VESA 640 x 480	37.50	75
2 VESA 800 x 600	46.88	75
3 VESA 800 x 600	53.68	85
4 VESA 1024 x 768	68.677	85
*5 VESA 640 x 400	31.47	70
*6 VESA 640 x 480	31.47	60
*7 VESA 800 x 600	37.88	60
*8 VESA 640 x 480	43.27	85
*9 VESA 1024 x 768	60.02	75
*10 VESA 1280 x 1024	63.98	60

* Pre-loaded mode

User Modes

- Modes 11-34 are empty and can accept new video data. If the monitor detects a new video mode that has not been present before or is not one of the preset modes, it stores the new mode automatically in one of the empty modes starting with mode 11.

If you use up the 24 blank modes and still have more new video modes, the monitor replaces the information in the user modes starting with mode 11.

Recalling Display Modes

- When your monitor detects a mode it has seen before, it automatically recalls the image settings you may have made the last time you used that mode.

You may, however, manually force a recall of each of the 10 preset modes by pressing the Recall button. All preset modes are automatically recalled as the monitor senses the incoming signal.

The ability to recall the preset modes is dependent on the signal coming from your PC's video card or system. If this signal does not match any of the factory modes, the monitor automatically sets itself to display the image.

Troubleshooting

Check the following before calling for service.

SELF DIAGNOSTICS(NO SIGNAL) message.

- The signal cable is not connected, or is loose. Check and secure the connection.

OUT OF FREQUENCY(OUT OF RANGE) message appears.

- The frequency of the signal from the video card is outside the operating range of the monitor.

* Horizontal Frequency : 30-70kHz

* Vertical Frequency : 50-160Hz

Use the graphics board's utility software to change the frequency setting (Refer to the manual for graphics board).

The power LED is illuminated amber.

- Display power management mode.
- There is no active signal coming from the PC.
- The signal cable is not fastened securely.
- Check the computer power and graphics adapter configuration.

The image on the SCREEN is not centered, or too small, or not a rectangle shape.

- Image adjustment not been done yet in the current operating mode. Use the OSD, SET and Δ / ∇ / \leftarrow / \rightarrow buttons to set the image to your liking.

The monitor doesn't enter the power saving off mode (Amber).

- Computer video signal is not VESA DPMS standard. Either the PC or the video controller card is not using the VESA DPMS power management function.

An abnormal picture is displayed on the screen. For example, the upper part of the picture may be missing or dark.

- If using certain non-VESA Standard video card, an abnormal picture may be displayed. Try setting it to one of the factory preset modes, or selecting to a resolution and refresh rate within the specification limits of the monitor.

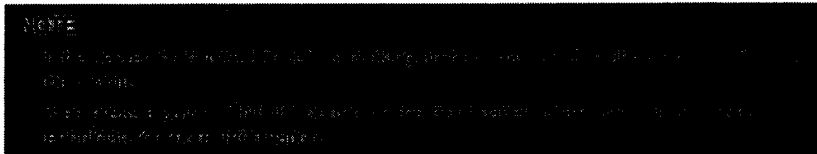

Specifications

Picture Tube	17 inch (16.0 inches viewable) Perfect Flat Tube	
	90 degree deflection	
	0.24mm Slot pitch	
	W-ARAS(Wide Anti-Reflective Anti-Static) coating	
Sync Input	Horizontal Freq.	30 - 70kHz (Automatic)
	Vertical Freq.	50 - 160Hz (Automatic)
	Input Form	Separate, TTL, Positive/Negative
	Signal Input	15 pin D-Sub Connector
Video Input	Input Form	Separate, RGB Analog, 0.7Vp-p/75 ohm, Positive
	Resolution(max)	1280 x 1024@60Hz
Audio	RMS Audio Output	2W + 2W (R+L)
	Input Sensitivity	0.7 Vrms
	Speaker Impedance	4Ω
Power Consumption	Max	≤ 110W
	Normal	≤ 74W
	Stand-by/Suspend	≤ 15W
	Power Off	≤ 8W
Dimensions (With tilt wheel stand)	Width	46.0 cm / 18.1 inches
	Height	43.9 cm / 17.28 inches
	Depth	44.0 cm / 17.3 inches
Power Input	Europe	AC 200-240V 50Hz 1.5A
	Others	AC 100-240V 50/60Hz 2.0A
	The products should be used according to the Power requirements of each ID LABEL.	
Weight	Net	21 kg (46.3 lbs)
Environmental Conditions	Operating Condition	
	Temperature	10 °C to 40 °C
	Humidity	10 % to 90 % non-Condensing
	Storage Condition	
	Temperature	0 °C to 60 °C
	Humidity	5 % to 90 % non-Condensing

Notes

1. All the products are in the state of initial inspection and are not for use in the field.