



USER GUIDE

# LG-G420

# About this user guide

Thank you for choosing this LG product. Please carefully read this user guide before using the device for the first time to ensure safe and proper use.

- Some content and illustrations may differ from your device depending on the region, service provider, software version, or OS version, and are subject to change without prior notice.
- Always use genuine LG accessories. The supplied items are designed only for this device and may not be compatible with other devices.

## Instructional notices



**WARNING:** Situations that could cause injury to the user and third parties.



**CAUTION:** Situations that may cause minor injury or damage to the device.



**NOTE:** Notices or additional information.

# Table of contents

- 3 Guidelines for safe and efficient use
- 10 Safety instructions

## 01

### Basic Functions

- 18 Product components and accessories
- 19 Parts overview
- 21 Turning Your Phone On and Off
- 21 Installing the SIM Cards
- 24 Charging the phone

## 02

### Useful Apps

- 26 Calls
- 28 Contacts
- 29 Messaging
- 32 Organizer
- 33 Camera
- 34 Multimedia
- 36 Internet

## 03

### Phone Settings

- 38 Profiles
- 38 Display
- 39 Phone
- 40 Call
- 42 Connectivity
- 43 Dual SIM setting
- 43 Restore settings

## 04

### Appendix

- 45 FAQ
- 47 More information

# Guidelines for safe and efficient use

## Read before use

- To purchase optional items, contact the LG Customer Information Centre for available dealers.
- The appearance and specifications of the device are subject to change without notice.

## Important Information

This user's guide contains important information about the use and operation of this phone. Read all information carefully for optimal performance and to avoid any damage or misuse of the phone. Any changes or modifications not expressly approved in this user's guide could void your warranty for this equipment.

## Before you begin

### Safety Guidelines

#### **WARNING!**

- To reduce the possibility of electric shock, do not expose your product to high humidity areas, such as bathroom or swimming pool.

Keep the phone away from heat. Never store your phone in environment that may expose it to temperatures below 0 °C or above 40 °C, such as outdoor during snowstorm, or in your car in hot days. Exposure to cold or heat will result in malfunction, damage or permanent failure. Be careful when using your phone near other electronic devices. The RF emissions from mobile phones may affect nearby electronic equipment that not adequately shielded. You should consult manufacturers of any personal medical devices, as in the case of pacemakers and hearing aides, to determine whether they are susceptible to interference from cell phones.

Turn off your phone in medical facilities or at gas stations. Never place your phone in microwaves, as it will cause the battery to explode.

### Important!

- Before using your phone, please read the SAFETY INFORMATION OF THE TELECOMMUNICATIONS INDUSTRY ASSOCIATION (TIA).

## Safety Information

Read these simple guidelines. Breaking the rules may be illegal or dangerous. More detailed information is provided in this user's guide.

- Never use an unapproved battery that could cause damages to the phone or the battery itself, or even explode.
- Never place your phone in a microwave oven, as this will result in an explosion of the battery.
- Do not dispose of your battery in fire or with hazardous or flammable materials.
- Make sure the battery does not come into contact with sharp-edged items, such as animal teeth or claws. This could cause a fire.
- Store the battery in a place out of the reach of children.
- Be careful so that children do not swallow any parts of the phone, such as rubber plugs (earpiece, parts that connect to the phone, etc.). This could cause asphyxiation or suffocation.
- Disconnect the plug and charger from the outlet when the phone shows that the battery has been fully charged, because it may cause electric shock or fire hazard.
- When in the car, do not leave your phone, or install a hands-free kit, near the airbag. If wireless equipment is improperly installed, you can be seriously injured if the airbag is deployed.
- Do not use mobile phone while driving.
- Do not use the phone in areas where its usage is prohibited. (For example: in airplanes).
- Do not expose the battery charger or adapter to direct sunlight, or use it in places with high humidity, such as bathroom.
- Never store your phone in temperatures lower than  $-20^{\circ}\text{C}$  or higher than  $50^{\circ}\text{C}$ .
- Do not use harsh chemicals (such as alcohol, benzene, solvents, etc.) or detergents to clean the phone. This could cause fire.
- Do not drop the phone, strike it, or shake it hard. Such actions may harm the phone's internal circuit boards.

- Do not use your phone in high explosive areas, as this may generate sparks.
- Do not damage the power cord by bending, twisting, pulling, or heating it. Do not use the plug if it is loose as it may cause fire or electric shock.
- Do not handle the phone with wet hands while it is charging. This can cause electric shock or seriously damage your phone.
- Do not disassemble the phone.
- Do not make or answer calls while charging the phone, which can cause a short circuit, electric shock, or fire.
- Use only batteries and chargers provided by LG. The warranty does not apply to products provided by other providers.
- Only authorized personnel should service the phone and its accessories. Installation or service may result in accidents and consequently invalidate the warranty.
- Do not hold or let the antenna come in contact with your body during a call.
- Emergency calls can be made only within a service area. To make an emergency call, make sure you are within a service area and the phone is on.
- Use your accessories, such as headphones or headsets, with caution, ensuring that the cables are plugged properly and that they do not touch the antenna unnecessarily.
- Do not use the product in places where it may be exposed to humidity or steam. (bathroom, shower, sauna, etc.) this exposition may cause damage for your device and may be not covered by the warranty.
- Damages caused by misuse, including but not limited to intentionally bending or continually exerting force on the product, may lead to permanent damage to the display and/or other parts and functions of the phone. We therefore recommend that you do not use this product inside the back pocket and sit down on it or inside the jeans pocket. This bending may cause damage for your device and may be not covered by the warranty.

## Information about the RF exposure from FCC

### **WARNING!**

- Read this information before operating the phone.

In August 1996, the Federal Communications Commission (FCC) of the United States, with its action in Report and Order FCC 96-502, adopted an updated safety standard for human exposure to radio frequency (RF) electromagnetic energy emitted by FCC regulated transmitters. Those guidelines are consistent with the safety standard previously set by both international and U.S. standards.

The highest SAR value for this phone FCC tested for use in the ear is 0.44 W/kg, and when worn on the body-worn is 0.47 W/kg.

The design of this phone complies with FCC guidelines and international standards

### FCC Part 15.19 Statements

This device complies with part 15 of the FCC Rules. Operation is subject to the following two conditions:

- (1) This device may not cause harmful interference, and
- (2) this device must accept any interference received, including interference that may cause undesired operation.

### Part 15.21 statement

Any changes or modifications not expressly approved by the manufacturer could void the user's authority to operate the equipment.

### Part 15.105 statement

This equipment has been tested and found to comply with the limits for a Class B digital device, pursuant to part 15 of the FCC Rules. These limits are designed to provide reasonable protection against harmful interference in a residential installation. This equipment generates, uses and can radiate radio frequency energy and, if not installed and used in accordance with the instructions, may cause harmful interference to radio communications. However, there is no guarantee that interference will not occur in a particular installation.

If this equipment does cause harmful interference to radio or television reception, which can be determined by turning the equipment off and on, the user is encouraged to try to correct the interference by one or more of the following measures:

- Reorient or relocate the receiving antenna.
- Increase the separation between the equipment and receiver.
- Connect the equipment into an outlet on a circuit different from that to which the receiver is connected.
- Consult the dealer or an experienced radio/TV technician for help.

## Body effects

This device was tested for typical body operation, keeping a distance of 15 **mm** between the user's body and the back of the phone. To comply with RF exposure requirements of the FCC standards, a minimum distance of 15 **mm** between the user's body and the back of the phone is required.

Any beltclips, holsters, and similar accessories containing metallic components may not be used. Body-worn accessories that cannot maintain 15**mm** separation distance between the user's body and the back of the phone, and have not been tested for typical body-worn operations may not comply with FCC/IC RF exposure limits and should be avoided.

## Battery Precautions

- Do not disassemble.
- Do not short-circuit.
- Do not expose to high temperatures, over 60 °C (140 °F).
- Do not incinerate.



## Battery Disposal

- Please dispose of your battery properly, or bring it to your wireless provider for recycling.
- Do not dispose of your battery in fire or with hazardous or flammable materials.

## Adapter Precautions (Charger)

- Using the wrong battery charger could damage your phone and void your warranty.
- The adapter or battery charger is only designed for indoor use.
- Do not expose the battery charger or adapter to direct sunlight, or use it in places with high humidity, such as the bathroom.

## Cautions for Battery

- Do not disassemble or open crush, bend or deform, puncture or shred.
- Do not modify or remanufacture, attempt to insert foreign objects into the battery, immerse or expose to water or other liquids, expose to fire, explosion or other hazard.
- Only use the battery for the system for which it is specified.
- Only use the battery with a charging system that has been qualified with the system per this standard. Use of an unqualified battery or charger may present a risk of fire, explosion, leakage, or other hazard.
- Do not short circuit a battery or allow metallic conductive objects to contact battery terminals.
- Promptly dispose of used batteries in accordance with local regulations.
- Battery usage by children should be supervised.
- Avoid dropping the phone or battery. If the phone or battery is dropped, especially on a hard surface, and the user suspects damage, take it to a service center for inspection.
- Improper battery use may result in a fire, explosion or other hazard.
- For those host devices that utilize a USB port as a charging source, the host device's user manual shall include a statement that the phone shall only be connected to products that bear the USB-IF logo or have completed the USB-IF compliance program.

- Always unplug the charger from the wall socket after the phone is fully charged to save unnecessary power consumption of the charger.

## **Avoid damage to your ear**

- Damage to your hear can occur due to constant exposure to excessive high sound. We, therefore, recommend that you do not turn on or off the phone near your ear. We also recommend you be reasonable with the music and volume level.
- If you listen to music, please ensure that the volume level is adequate, so that you are aware of your surroundings. This is particularly important when attempting to cross a street.

# Safety instructions

## TIA's Safety Information

This includes complete security information on wireless phones from TIA (Telecommunications Industry Association).

It's required, for CTIA Certification, the inclusion in the user manual of text covering pacemakers, hearing aids and other medical devices. It's encouraged the use of the remaining TIA language when relevant.

## Suggestions for a more efficient operation

For your phone to operate most efficiently:

- Do not touch the antenna unnecessarily, when the phone is in use. The contact with the antenna affects call quality, and may cause the phone to operate at a higher power level than otherwise would be need.

## Driving

Check the laws and regulations related to the use of wireless phones in the areas where you drive. Always obey these regulations. Also, if using your phone while driving, make sure to:

- Pay full attention to driving; driving safely is your first responsibility;
- Use hands-free operation, if available;
- Pull off the road and park, before making or answering a call, if driving conditions demand so.

## Electronic Devices

Most modern electronic equipment is shielded from RF signals.

However, certain electronic equipment may not be shielded against the RF signals from your wireless phone.

## Pacemaker

The Medical Industry Manufacturers Association recommends a minimum distance of fifteen (15) centimeters, or six (6) inches, between a handheld wireless phone and a pacemaker, in order to avoid potential interference between them.

These advices are consistent with independent researches, and with recommendations based on wireless technology research.

People with pacemakers should:

- ALWAYS keep the phone at least fifteen centimeters (six inches) from their pacemaker, whenever the phone is turned on;
- Not carry the phone in a shirt pocket;
- Use the ear opposite to the pacemaker, to minimize the potential interference;
- If you have any reason to suspect that interference is taking place, switch off your phone immediately.

## Hearing Aids

Some digital wireless phones may interfere with some hearing aids. In the event of such interference, we recommend that you contact your service provider.

## Other Medical Devices

If you use any other personal medical devices, consult your device manufacturer to determine if they are adequately shielded from external RF energy. Your doctor can help you obtain this information.

## Health Care Facilities

Turn off your phone in health care facilities, whenever there are signs asking you to do so. Hospitals or health care facilities may use equipment that could be sensitive to external RF energy.

## Vehicles

RF signals may affect improperly installed or inadequately shielded devices in motor vehicles.

Check with the manufacturer, or its representative, regarding your vehicle.

You should also consult the manufacturer about any equipment that has been added to your vehicle.

## Facilities with signs

Turn off the phone in any facility where warning signs request you to do so.

## Airplanes

FCC regulations prohibit the use of phones while in the air. Turn off your phone before boarding an airplane.

## Blasting Areas

To avoid interfering with blasting operations, turn your phone off when in a 'blasting area' or in areas with signs that read: 'Turn off two-way radios'. Obey all signs and instructions.

## Potentially Explosive Atmosphere

Turn off the phone when in an area with a potentially explosive atmosphere, and obey all signs and instructions.

Sparks in such areas could cause an explosion or fire that could result in personal injury or death.

Areas with a potentially explosive atmosphere are often clearly marked, but not always. Among the potentially dangerous areas are:

Fueling areas (such as gas stations), areas below deck on boats, facilities where chemical products are transferred or stored, vehicles using liquefied petroleum gas (as propane or butane), areas where the air contains chemicals or particles (such as grain, dust or metal powders), and any other areas where you would normally be advised to turn off your vehicle engine.

## For vehicles equipped with air bags

Air bags inflate with strong force. Do not place objects in the area over the air bag or in its deployment area, including wireless equipment, either installed or portable.

Serious injuries could occur if wireless equipment is improperly installed into the car when the air bag inflates.

## Safety Information

Read and observe the following information for the safe and proper use of your phone, and to prevent any damage.

Also, keep the user's guide in an accessible place at all times after reading it.

## Charger, Adapter and Battery Security

- The charger and adapter are designed only for indoor use.
- Dispose of your battery properly, or bring it to your wireless provider for recycling.
- The battery doesn't need to be fully discharged before recharging.
- Only use LG approved chargers that are specifically made for your phone model, since they are designed to maximize the battery life.
- Do not disassemble or short-circuit it.
- Keep the metal contacts on the battery clean.

- Replace the battery when it no longer provides acceptable performance. The battery can be recharged several hundred times before replacement.
- Charge the battery after long periods without use to maximize its life.
- The battery life will vary depending on usage patterns and environmental conditions.
- Intensive use of backlighting, browser, and packet data connectivity affect battery life and talk/standby times.
- The role of self-protection interrupts the phone when its operation is in an abnormal state. In this case, remove the battery from the phone, reinstall it, and turn on the phone.

## Explosion, Shock and Fire Danger

- Do not place the phone in a place exposed to excessive dust, and keep the minimum required distance between the power cord and heat sources.
- Unplug the power cord before cleaning the phone, and clean the power plug whenever it is dirty.
- When using the power plug, make sure it is firmly connected. Otherwise, it can overheat or start a fire.
- Placing the phone in a pocket or bag without covering the receptacle (power plug pin), metallic articles (such as a coin, clip or pen) may short-circuit the phone. Always cover the receptacle when not in use.
- Do not short-circuit the battery. Metal items, such as coins, paper clips, or pens, in your pocket or bag may cause a shortcircuit between the + and - terminals of the battery (metal strips on the battery). The short-circuit of the terminals may damage the battery and cause an explosion.

## General Notice

- Using a damaged battery, or inserting it into the mouth can cause serious injuries.
- Do not place the phone in proximity to items containing magnetic components, such as credit cards, calling cards, bank books, or subway tickets. The phone magnetism may damage the data stored in the magnetic strip.
- Talking on the phone for a long period of time may reduce call quality, because of the heat generated during use.

- When the phone has not been in use for a long time, store it in a safe place, with the power cord unplugged.
- Using the phone close to a receiving equipment (such as TV or radio) may cause interference.
- Do not use the phone if the antenna is damaged. If a damaged antenna contacts skin, it may cause a slight singe. Contact an LG Authorized Service Facility to replace the damaged antenna.
- Do not immerse your phone in water. If this happens, immediately turn it off and remove the battery. If your phone does not work, take it to an LG Authorized Service Facility.
- The power supply contains elements that could be harmful to your health, if components are handled directly. If this happens, we recommend immediate hand-washing.
- Do not paint the phone.
- Data stored in your phone might be deleted due to careless use, hardware repair or software upgrade. Please backup your important phone numbers (ringtones, text or voice messages, images, and videos might also get deleted). The manufacturer is not liable for damages due to loss of data.
- When using the phone in public places, you may set the ringer on vibrate to avoid disturbing others.
- Do not switch the phone on/off while it is in your ear.
- Repairs under warranty, at LG's discretion, may include replacement parts or boards that are either new or reconditioned, provided that they have functionality equal to that of the parts being replaced.

### **Ambient temperatures**

- Use your phone in temperatures between 0 °C and 40 °C, if possible. Exposing your phone to extremely low or high temperatures may result in damage, malfunction, or even explosion.



## Precautions when using SIM cards

- Do not insert the SIM card into the device with the label or seal attached. This may cause damage.
- Do not remove the SIM card while using the device. This may damage the SIM card or the system.
- Take extra care to ensure that the SIM card is not scratched, bent, or damaged by magnet. This may delete files saved on the SIM card or cause device malfunctions.

## Precautions when using memory cards

- Make sure that the orientation is correct when inserting the memory card. Inserting using the wrong orientation may damage the card.



01

## **Basic Functions**

# Product components and accessories

Make sure that none of the following items are missing:

- Travel adaptor
- Battery
- User Guide
- Stereo headset



- The items described above may be optional.
- The items supplied with the device and any available accessories may vary depending on the area and service provider.
- Always use genuine LG Electronics accessories. Using accessories made by other manufacturers may affect your device's call performance or cause malfunctions. This may not be covered by LG's repair service.



- If any of these basic items are missing, contact the dealer from which you purchased your device.
- To purchase additional basic items, contact the LG Customer Service Centre.
- To purchase optional items, contact the LG Customer Service Centre for available dealers.
- Some items in the product box are subject to change without notice.
- The appearance and specifications of your device are subject to change without notice.

# Parts overview

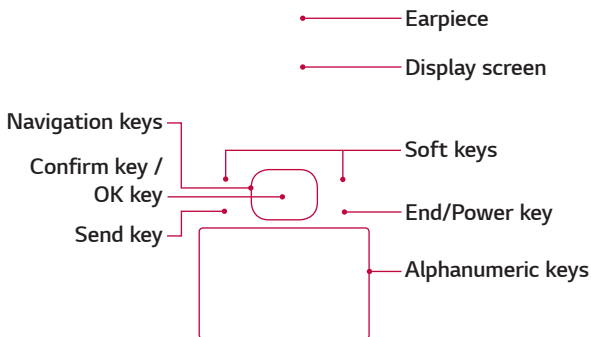

Earphone jack

Torch

Rear Camera Lens

Microphone

Charger port

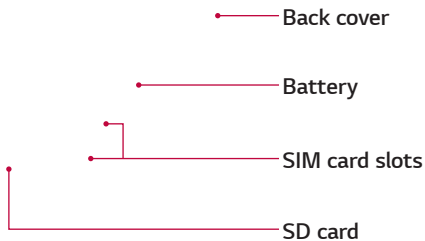

- **Send key**
  - You can dial a phone number and answer incoming calls.
- **Soft keys**
  - Each of these keys performs the functions indicated by the text on the display immediately above them.
- **Navigation keys**
  - Use for quick access to phone functions.
  - (up) : Long press up key : Torch
  - (down) : Message
  - (left) : Media Player
  - (right) : Camera
- **End/Power key**
  - Ends or rejects a call.
  - Returns to the home screen when you use the menu.
  - Long press to turn On/Off your phone.
- **Alphanumeric keys**
  - Most of the time, the numeric keys are used to input numbers or characters.



- Only alphanumeric key is lighting when using a phone.

## Turning Your Phone On and Off

You can power the phone On or Off by pressing and holding the End/Power key.

## Installing the SIM Cards

When you subscribe to a cellular network, you are provided with a SIM card loaded with your subscription details, such as your PIN, any optional services available and many others.



- The SIM card can be easily damaged by scratches or bending, so be careful when handling, inserting or removing the card. Keep all SIM cards out of the reach of small children.



- Only 2G/2.5G SIM cards are supported.

- 1 Open back cover.

2 Make sure the gold contact area on the card is facing downwards.

3 Insert your battery.

4 Close the back cover.



# Charging the phone

- Insert one end of the charging cable into the phone and plug the charger into an electrical socket.
- To maximize the battery lifetime, ensure that the battery is fully charged before you use it for the first time.



- Use only LG-approved chargers, batteries, and cables. When using unapproved chargers or cables, it may cause battery charging slowly or pop up the message regarding slow charging. Or, unapproved chargers or cables can cause the battery to explode or damage the device, which are not covered by the warranty.





02

## Useful Apps

# Calls

## Making a call

- 1 Enter the number using the keypad. To delete a digit press **Clear**.
- 2 Press  to initiate the call.
- 3 To end the call, press .



- To control the volume during a call, press the Up/Down navigation keys.

## Making a call from your contacts

- 1 Select **Contacts** from the home screen.
- 2 Using the keypad, enter the first letter of the contact you want to call and scroll through the Contacts.
- 3 Press  to begin the call.



- To scroll through your contacts, use the Up/Down navigation keys.

## Answering and rejecting a call

When your phone rings, press  to answer the call.

While your phone is ringing, select **Silent** to mute the ringing.

Press  or select **Silent** then **Reject** to reject the incoming call.



- You can change the settings on your phone to answer your calls in different ways.
- Press **Menu** > **Settings** > **Call** > **Advanced settings** > **Answer mode** and choose **Any key** or **Auto answer when headset mode**.

## Using the speakerphone

During in call, you can activate speakerphone by pressing RSK (H-Free) and you can use the handset in hands-free mode.

If the speakerphone is active, press RSK (H-Held) again to resume normal handset conversation mode.

## Share contact

Share contact feature provides an easy access to share contacts to caller while in Call, through SMS. User can send maximum of 5 contacts at a time. If more than one call is present, message will be sent to the highlighted number.

## Viewing your call logs

Press **Menu** and choose **Logs**.

- **All calls** – Displays the lists of all three types (Received/Dialled/ Missed calls) by time. This option lets you view the details of last 60 calls.
- **Missed calls** – This option lets you view the unanswered calls.
- **Received calls** – This option lets you view the incoming calls.
- **Dialled calls** – This option lets you view the outgoing calls (called or attempted).
- **Call duration** – Allows you to view the duration of your last call, dialled calls, received calls and reset all.
- **Text msg. counter** – Allows you to count the number of messages sent and received from the phone.
- **Data information** – Allows you to view the information of Last sent, Last received, All sent, All received and Reset counter.

# Contacts

## Searching for a contact

- 1 Select **Contacts** from the home screen.
- 2 Using the keypad enter the first letter of the contact you want to call.
- 3 Press Up/Down navigation keys to scroll through the contacts.

## Adding a new contact

- 1 Select **Contacts** from the home screen.
- 2 Choose **Add new contact**.
- 3 Select **To SIM1/SIM2** or **To Phone** and Press **OK**.
- 4 Then enter the Name, Number & details of your new contact, select **Options** then choose **Save**.

## Speed dial

User can map a specific calling number or URL to any key between 2-9 depending on availability in **Phonebook settings > Speed dial > Set speed dial**.

The service can be enabled by setting the status to "On" in **Phonebook settings > Speed dial > Status**.

Long press of the mapped key will initiate the call or launch the browser with the mapped URL depending upon speed dial type.

# Messaging

## Sending a message

- 1 Press **Menu**, select **Messaging**, select **Write message** and choose **Text message** or **Multimedia message**.
- 2 Enter your message using either the T9 predictive mode or Abc manual mode or 123 mode. You can switch text input modes by pressing the  key.
- 3 After completing a message, press the **OK key** to select a recipient.
- 4 Enter your recipients by either entering manually or from Options choose **Add from Phonebook** to enter from phonebook.

## Entering text

You can enter alphanumeric characters using the phone's keypad. The following text input methods are available in the phone: T9 mode () Abc), Abc mode and 123 mode.

To change modes, press the  key.





- Some fields may allow only one text input mode (e.g. telephone number in address book fields).

## T9 mode ( \$| Abc)

T9 mode ( \$| Abc) uses a built-in dictionary to recognise words you're writing based on the key sequences you press. Simply press the number key associated with the letter you want to enter, and the dictionary will recognise the word once all the letters are entered.

### Using the T9 mode ( \$| Abc)

- 1 When you are in the T9 predictive text input mode, start entering a word by pressing keys  to . Press one key per letter.
  - If the word is still incorrect after typing completely, press the left & right navigation keys to scroll through the other word options.
  - If the desired word is missing from the word choices list, add it by using the Abc mode.
- 2 Enter the whole word.
  - To delete letters, press **Clear**.

## Abc mode

This mode allows you to enter letters by pressing the key labelled with the required letter once, twice, three or four times until the letter is displayed.

## 123 mode

Type numbers using one keystroke per number. You can also add numbers while remaining in letter modes by pressing and holding the desired key.

## Inserting symbols

If you want to insert symbols, press the  key, then you can choose a symbol. And in some editors you can press **Options**, go to **Insert symbol**.

## Changing the language

There are two ways to change the writing language from the writing screen. You can press **Options**, go to **Writing language** and then set the language you want or long press  key in editor.

## Message folders

Press **Menu**, select **Messaging**. And select the folder you want.

- **Inbox** – You will be alerted when you have received messages. They will be stored in Inbox.
- **Drafts** – If you don't have time to finish writing a message, you can save what you have written so far in here.
- **Outbox** – This is a temporary storage folder used while messages are being sent.
- **Sent messages** – After sending out the message, the text message is saved in the Sent folder.
- **E-mail** – Allows you to set E-mail.



- While doing any email operation, if you get certificate error then install certificate using options menu and save it with any name to import certificate. After certificate is imported, email operation will work fine.

- **Broadcast messages** – Allows you to set broadcast messages.
- **Templates** – Allows you to set preferences for text messages.
- **Message settings** – Your message settings are pre-defined so that you can send messages immediately. If you would like to change the settings, you can do this using the settings options.



# Organizer

## Calendar

When you enter this menu, a calendar appears. A square cursor is located on the current date. You can move the cursor to another date using the navigation keys.

## Tasks

This feature allows you to save and manage a task.

## Alarm clock

You can set up to 5 alarms to invoke on a specified time.

## World time

Allows you to determine the current time in another time zone or country.

## Notes

You can register your own notes here.

## Calculator

The calculator provides the basic arithmetic functions: addition, subtraction, multiplication and division.

## Unit converter

This converts any measurement into a unit you want.

## Torch

You can use a torch at the top of the phone. Choose the switch On or Off.

# Camera

## Taking a photo

- 1 Press **Menu** and choose **Camera**.
- 2 Holding the phone and point the lens towards the subject of the photo.
- 3 Press **OK** key to take a photo.

The following options will appear at the bottom of the screen by pressing left soft key.

- **EV** – Allows you to set the brightness.
- **Switch to** – Choose Photo album to Image viewer or Video recorder to switch to shoot a video.
- **Capture mode** – Choose Normal or Continuous shot to set capture mode.
- **Image size** – Choose Wallpaper, VGA, or 1MP to set Image size.
- **Self-timer** – Set your camera's timer. Choose from Off, 5 sec or 10 sec.
- **White balance** – The white balance ensures any white areas in your video are realistic. To enable your camera to adjust the white balance correctly, you may need to determine the light conditions. Choose from Auto, Daylight, Tungsten, Fluorescent, Cloudy or Incandescent.
- **Effects** – Set the Effects as Normal, Grayscale, Sepia, Sepia green, Sepia blue or Colour invert.
- **Adv. settings** – Allows to choose from Storage, Image quality, Contrast, Shutter sound, Anti-flicker and Restore default.

## Shooting a video

- 1 Press **Menu** and choose **Camera**.
- 2 Press **down navigation key** to convert into the video mode.
- 3 Point the lens towards the subject of the video and press **OK** key to start recording.
- 4 A timer will appear at the bottom of left-side.
- 5 Press **OK** key to stop recording and select the **right soft key** to save.
  - **Record limit** – Allows you to set record time limit.
  - **Adv. settings** – Allows to choose from Storage, Video quality, Contrast, Record audio, Anti-flicker and Restore default.



- You can adjust the zoom scale by using the left and right navigation keys. The zoom scale ranges from Level 1 to Level 4.

## Multimedia

### Media Player

This menu allows you to play audio and video files. You can also manage play lists. Choose from **Now playing**, **All songs**, **All videos** and **Music playlists**.

### My Stuff

You can store multimedia files in your phone's memory so you have easy access to all your audio, photos and videos. You can also save your files to a memory card. Using a memory card allows you to free up space in your phone's memory. By choosing **My Stuff**, you can open a list of the folders that store all your multimedia files.

## Image viewer

This menu allows you to view pictures and videos that are captured with camera. You can access the following options by pressing

**Options: View, Send, Use as, Rename, Delete, Sort by, Details** and **Storage**. In **Use as**, you can choose from **Wallpaper, Power on display, Power off display** and **Caller picture**.

## FM radio

Your phone has an FM radio feature so you can tune into your favourite stations and listen on the move.

### Searching for stations

- 1 Press **Menu** > **Multimedia** > **FM radio**.
- 2 Select **Options** and choose **Auto search**. You can also use the left and right navigation keys to increase/decrease the frequency.



- Insert the earphone into the headset connector in order to listen to the radio and keep the good radio reception.

## Voice recorder

You can use Voice recorder to record voice memos or other sounds.

- 1 Press **Menu** > **Multimedia** > **Voice recorder**.
- 2 Press **up navigation key** to begin recording.
- 3 Press **Pause** to pause recording, **Cont.** to continue recording.
- 4 Choose **Stop** to end the recording.



- After recording, you can access the following options by pressing **Options: New record, Play, Append, Rename, Delete, List, Settings** and **Send**.

## Applications

Allows you to access applications.

Press **Menu** > **Multimedia** > **Applications** > **My apps**.

## Internet

The internet gives you a fast, full colour world of games, music, news, sports, entertainment, and much more, right on your mobile phone.

Press **Menu** > **Internet**.



- Additional charges apply when connecting to these services and downloading content. Check data charges with your network provider.



03

## **Phone Settings**

# Profiles

You can adjust and customize the phone profile for different events or environments.

- **General** – Ring tone and key tone volume are set to normal.
- **Silent** – Ring tone is disabled and Vibrate is activated.
- **Meeting** – Ring tone and Vibrate are disabled.
- **Outdoor** – Ring tone and key tone volume are set to maximum.
- **My style** – Ringtone and key tone are set as you desired.

# Display

This menu allows you to configure your display settings.

- **Wallpaper** – Allows you to set a picture as your background.
- **Power on display** – Allows you to set a picture as your background when the phone turns on.
- **Power off display** – Allows you to set a picture as your background when the phone turns off.
- **Show date and time** – Allows you to show the date and time on the idle screen.
- **LCD backlight settings** – Allows you to set the brightness of the LCD backlight settings.

# Phone

Enjoy the freedom of adapting how your phone works for your own style.

- **Date and time** – You can set functions relating to the date and time.
- **Language** – You can change the language for the display texts in your phone. This change will also affect the Language Input mode.
- **Security** – Allows you to protect the features and settings of your phone. Choose from SIM, Phone security, Certificate manager, Anti-theft mobile tracker and Anti keypad lock.

Password based key lock can be enabled by setting Phone lock “On”. This feature enables the device to ask the user for password whenever user tries to unlock the phone.

Phone lock can be set to “On” after providing recovery details. These recovery details will be used to retrieve the password in case user forgets the password. Password retrieval can be done by either selecting retrieve option in lock screen or through the retrieve password option in phone lock menu. Password retrieve will prompt user to answer the security question saved during setup. Alternately, user can choose to receive the password in a message to the number specified during phone lock setup.



• Default security password is “0000”.

- **Schedule power on/off** – Allows you to set up time for the phone automatically power on or off. Once the time is set by you, the phone will power on or off automatically at the time specified.
- **Preferred writing language** – You can set the desired languages.
- **SOS service** – When SOS service is turned on, send the emergency SMS by press and holding the ‘9’ key on your keypad in idle screen, SOS mode will now be turned on. The SOS messages will be sent to the phone number(s) listed in Recipient list. While SOS mode is active, incoming calls by them will be automatically



accepted. To exit SOS mode, on the idle screen push the end key and select Yes.

- **Emergency notice** – Once this feature is Set ON, Message will be sent to Emergency contact(s), when Emergency call is dialled or when Phone is in non-usage for certain duration. This may incur additional charges.
- **Encoding** – You can choose from ASCII, ISO-8859-5, Windows-1251, ISO-8859-1 and Windows-1252.
- **Auto update time** – Allows you to set the phone to automatically update the time and date according to the current local time zone.
- **Flight mode** – You can use this function to switch the flight mode on. You will not be able to make calls, send messages when flight mode is switched on.
- **UART settings** – You can choose from SIM1 and SIM2.
- **Legal information** – You can check Open source license information.

## Call

You can set the menu relevant to a call.

### SIM1/ SIM2

- **Caller ID** – Select Set by network or Hide ID or Send ID.
- **Call waiting** – Select Active or Deactivate.
- **Call divert** – Select methods for diverting calls.
- **Call barring** – Choose a barring password for all outgoing calls, outgoing international, outgoing international except to home PLMN, all incoming calls, or incoming when roaming.

## Cost save mode

Every contact is added along with assigned SIM when adding in phone book. During Calling, matching operator SIM is identified and the operation is completed using the matching operator SIM. This makes possible to use benefit from using same operator. To use Cost save mode feature, make sure the feature is On [**Menu** > **Settings** > **Call** > **Cost save mode**].



- Cost save mode doesn't work during in-call.

## Smart call divert

Smart call divert activates call waiting and call forwarding for both SIMs. When you are in call with SIM1, SIM2 calls are forwarded to SIM1 and vice versa.

## Advanced settings

- **Blacklist** – You can set to reject unknown callers or reject number in blacklist.
- **Auto redial** – Choose the switch Off or On.
- **Call time display** – Choose the switch Off or On.
- **Call time reminder** – Choose the Off, Single or Periodic.
- **Reject by SMS** – Choose the switch On or Off.
- **Fake call** – This is a useful function for avoiding awkward situation politely. You can call yourself by setting the time in fake call menu.
- **Connect notice** – Choose the switch Off or On.
- **Answer mode** – You can change the settings on your phone to answer your calls in different ways.
- **Hearing Aid** – Hearing Aid increases volume levels in call. Volume will be increased only in receiver mode. Not applicable for Speaker, Headset and Bluetooth® path.



- Fake call can be activated or deactivated from idle screen using shortcut code **##\*#**.

## Connectivity

### Bluetooth

Your phone has built-in Bluetooth wireless technology, which makes it possible for you to connect your phone wirelessly to other Bluetooth devices such as a handsfree device, PC, laptop, or other phones. The devices registered in your phone can only be connected one at a time (To make a connection to the same type of device or change Bluetooth preferences, disconnect the existing device first).

#### Power

Allows you to turn your Bluetooth functionality On or Off.

#### Visibility

Allows you to set your device to be visible to other Bluetooth devices. Choose from **Permanent visible**, **Temporary visible** or **Off**.

#### Smart Pair

Allows you to view the list of all devices that are paired with your phone. Connect your phone wirelessly to other Bluetooth devices via Smart Pair. Using Smart Pair you can make a Call, View the Call History of your smart phone on the basic phone.

Some features may be limited depending on carrier's policy or compatibility of your phone model.

#### My name

Allows you to edit the name of your device.

#### Advanced

Choose from **Storage**, **Sharing permission** and **My address**.

## Network settings

You can select a network that will be registered either automatically or manually.

## Data connection SIM

Allow you to choose SIM for data connection.

## Data accounts

Pre defined APN, Homepage, IP Address, Port settings have been given for all operators of targeted countries. Data account settings are used to launch Opera and any other network based apps, which uses data connection.

## Data Service

Set Data Service to On or Off.

## Data roaming

Set Data roaming to Off or On.

## Dual SIM setting

You can see two Network Signal icons on the left-top of the screen when you insert two SIM-Card. To Activate/Deactivate the SIM card, Go to **Menu > Settings > Dual SIM settings**.

## Restore settings

You can restore and restart the phone by inputting the phone password.



04

## **Appendix**

# FAQ

This chapter lists some problems you might encounter when using your phone. Some problems require you to call your service provider, but most are easy to fix yourself.

Message	Possible causes	Possible corrective measures
SIM card error	There is no SIM card in the phone or it is inserted incorrectly.	Make sure that the SIM card is correctly inserted.
No network connection/ Dropped network	Signal is weak or you are outside the carrier network.	Move toward a window or into an open area. Check the network operator coverage map.
	Operator applied new services.	Check whether the SIM card is more than 6-12 months old. If so, change your SIM card at your network provider's nearest branch. Contact your service provider.
Codes do not match	To change a security code, you will need to confirm the new code by re-entering it.	If you forget the code, contact your service provider.
	The two codes you have entered do not match.	

<b>Message</b>	<b>Possible causes</b>	<b>Possible corrective measures</b>
Calls not available	Dialling error	New network not authorized.
	New SIM card inserted.	Check for new restrictions.
	Pre-paid charge limit reached.	Contact service provider or reset limit with PIN2.
Phone cannot be switched on	On/Off key pressed too briefly.	Press the On/Off key for at least two seconds.
	Battery is not charged.	Charge battery. Check the charging indicator on the display.
Charging error	Battery is not charged.	Charge battery.
	Outside temperature is too hot or cold.	Make sure phone is charging at a normal temperature.
	Contact problem	Check the charger and its connection to the phone.
	No voltage	Plug the charger into a different socket.
	Charger defective	Replace the charger.
	Wrong charger	Use only original LG accessories.
No sound	Vibration mode	Check the settings status in the sound menu to make sure you are not in vibration or silent mode.

# More information

## Open Source Software Notice Information

To obtain the source code under GPL, LGPL, MPL, and other open source licenses, that is contained in this product, please visit <http://opensource.lge.com>.

In addition to the source code, all referred license terms, warranty disclaimers and copyright notices are available for download.

LG Electronics will also provide open source code to you on CD-ROM for a charge covering the cost of performing such distribution (such as the cost of media, shipping, and handling) upon email request to [opensource@lge.com](mailto:opensource@lge.com). This offer is valid for three (3) years from the date on which you purchased the product.

## Trademarks

- Copyright ©2016 LG Electronics, Inc. All rights reserved. LG and the LG logo are registered trademarks of LG Group and its related entities.
- Bluetooth® is a registered trademark of Bluetooth SIG, Inc. worldwide.
- All other trademarks and copyrights are the property of their respective owners.

## DECLARATION OF CONFORMITY

Hereby, **LG Electronics** declares that this **LG-G420** product is in compliance with the essential requirements and other relevant provisions of Directive **1999/5/EC**.

A copy of the Declaration of Conformity can be found at <http://www.lg.com/global/declaration>



