

This device is not intended for sale in the USA.

### **Part 15.21 statement**

" Change or Modifications that are not expressly approved by the manufacturer could void the user's authority to operate the equipment. "

### **Part 15.105 statement**

This equipment has been tested and found to comply with the limits for a class B digital device, pursuant to Part 15 of the FCC Rules.

These limits are designed to provide reasonable protection against harmful interference in a residential installation. This equipment generates uses and can radiate radio frequency energy and, if not installed and used in accordance with the instructions, may cause harmful interference to radio communications. However, there is no guarantee that interference will not occur in a particular installation. If this equipment does cause harmful interference or television reception, which can be determined by turning the equipment off and on, the user is encouraged to try to correct the interference by one or more of the following measures:

- Reorient or relocate the receiving antenna.
- Increase the separation between the equipment and receiver.
- Connect the equipment into an outlet on a circuit different from that to which the receiver is connected.
- Consult the dealer or an experienced radio/TV technician for help.

## **Part 15 Class B Compliance**

This device and its accessories comply with part15 of FCC rules.

Operation is subject to the following two conditions:

- (1) This device & its accessories may not cause harmful interference.
- (2) This device & its accessories must accept any interference received,  
including interference that may cause undesired operation.

## **Body-worn Operation**

This device has been tested for typical body-worn operations  
with the distance of 0.79inches (2.0cm) from the user's body.

To comply with FCC RF exposure requirements, a minimum separation distance  
of 0.79inches(2.0cm) must be maintained from the user's body.

Additionally, Belt clips, holsters & other body-worn accessories may not contain  
metallic components.



Some of the contents in this manual may differ from your phone depending on the software of the phone or your service provider.

This handset is not recommended for blind disability person due to touch screen keypad.

## **GW382f** User Guide

# Your Phone

## Phone Components

### Charger/USB Port

### Earpiece

Lets you hear the caller and automated prompts.

### Main LCD

### Multi-tasking key

### SEND key

Press this key in standby mode to quickly access the most recent, missed, dialed and received calls.

### END / Power

Ends or rejects a call. Turns the phone on/off. Press once to return to the standby screen.

### microSD™ memory card socket

### Lock / Unlock key

### Camera key

Press to start the Camera function. Press and hold to start the Video record function.

### Side volume keys

- When on the Standby screen: Allows you to set the Ringtone and Touchtone volume. Hold the Down key to toggle the Vibration Mode On and Off.
- During a call: Allows you to change the Earpiece volume.
- When playing background music: Allows you to change the music volume.

## Slide Open View

**Text Msg**

**Mobile Email**

**VideoCall Key**

**Contact list**

**BigPond Home Key**

**Caps**

Press to change between Upper Case and Lower Case.

**Fn**

Press to input symbols and numbers on Qwerty key pad.

**Del**

Deletes digits and letters.

Press to input "@".

Press to input ".com".

Press to move to the next row.

**Right**

**Up**

**Down**

**Left**

**Space**

Press to create a space between words.

**Sym**

Press to open the menu with Symbol entry options.

# Your Phone

## Rear View

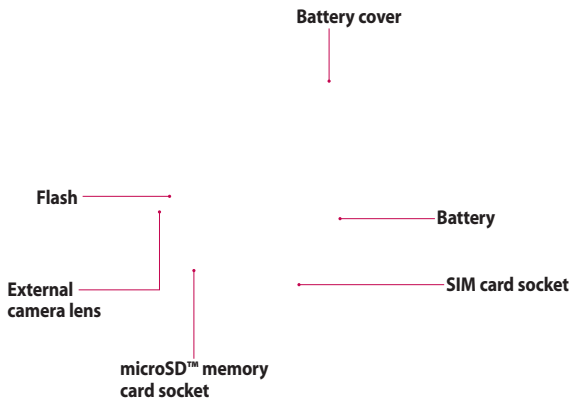

# Getting Started

## Installing the SIM Card and Battery

### 1 Remove the battery cover

Press the battery cover release latch. The battery cover should lift off easily.

### 2 Remove the battery

Lever the bottom edge of the battery and remove it carefully from the battery compartment.



**WARNING:** Do not remove the battery when the phone is switched on, as this may damage the phone.

# Getting Started

## **3 Install the SIM card**

Slide the SIM card into the SIM card holder. Make sure that the gold contact area on the card is facing downward. To remove the SIM card, pull it gently in the opposite direction.

## **4 Install the battery**

Insert the top of the battery first into the top edge of the battery compartment. Ensure that the battery contacts align with the terminals on the phone. Press the bottom of the battery down until it clips into place.



## 5 Charging your phone

Lift the charger port cover on the top side of your GW382f. Insert the charger connector to the phone ('B' side of the connector has to be facing up when connecting to the phone) and then plug into the wall socket. Your GW382f will need to be charged until a message reading "Battery full. Please unplug charger to save energy." appears on the screen.

**Important!** You should insert the battery before charging.

 **WARNING:** Use of unauthorized accessories could damage your phone and void your warranty.

# Getting Started

## Installing a Memory Card

You can expand the memory available on your phone by using a microSD™ memory card. The GW382f will support up to a 16 GB microSD™ memory card.



















**TIP!** A memory card is an optional accessory.

- 1 Lift the memory card cover and insert a microSD™ card with the gold contact area facing downwards. Close the memory card cover so that it clicks shut.

**Note:** If your memory card has existing content it will automatically be filed in the correct folder. For example, videos will be accessible from the Videos folder. If your memory card has protected content (i.e. content such as songs or graphics with Digital Rights Management copywriting loaded from another device), it will not work. You will need to reformat the memory card prior to using it with this device.

## On-Screen Icons



The table below describes various display indicators or icons that appear on the phone's display screen.

ICON	DESCRIPTION
	Multitasking
	Network signal strength (number of bars will vary)
	No network signal
	Battery empty
	New text message
	New email
	An alarm is set
	Normal profile in use
	Silent profile in use
	3G available
	Bluetooth® is active
	The browser is active
	Vibration mode
	Speakerphone
	Call in Progress
	Voicemail
	Battery Full
	Battery Charging
	Flight Mode

## Touch Calibration



Set your touch screen for ease of use. Touch  and press the '+' markers to calibrate the screen.

- Once you've finished calibrating your screen, Save the settings.

**Note:** To reset the touch calibration, touch , and the  tab. Touch , and choose **Touch Calibration**.

# Start Up Guide





After you install SIM card and battery, and turn on the GW382f, you will see Start Up Guide on the screen.

Touch Start  to begin the Start Up Guide feature. Touch  to play the animated Guide for that subject. Or, touch  to move on to the next Guide. Available Guides include:



- How to Unlock Your Phone
- How to Open Menu and Select Item
- How to Scroll
- How to Navigate Between Items
- How to Rotate Screen Orientation
- How to Open Keypad and Enter Text
- How to Change Home Screen
- How to Add Shortcuts on Home Screen
- How to Add Contacts on Home Screen

# General Functions





## Making a Call

- 1 Make sure your phone is powered on.
- 2 Touch  and enter a phone number using the touch pad or slide open the qwerty pad and enter a phone number using the qwerty keys. To edit a number on the display screen, simply press the  key to erase one digit at a time.
  - Press and hold the  key to erase the entire number.
- 3 Press the  [SEND] key to call the number. Or touch  on the touch pad.

## Making a Call with the Send Key

- 1 Press the  [SEND] key, and the most recent missed, dialed and received phone numbers will be displayed.
- 2 Select the desired number.
- 3 Press the  [SEND] key or touch .

## Making International Calls

- 1 When entering a phone number, press the  key and the international access character '+' will appear. When using the touch pad to dial, touch and hold .
- 2 Enter the country code, area code and the phone number.
- 3 Press the  [SEND] key to call the number. Or touch  on the pad.

## Ending a Call

When you have finished a call, press the  [END] key.

## Making a Call from the Contacts



You can store frequently called names and phone numbers in the SIM card as well as in the phone memory known as the Contacts.

You can dial a number by simply selecting a name in the contacts and pressing the  [SEND] key.

## Making a Video Call

You can make a video call in a 3G-covered service area if the user you are calling also has a 3G video phone in a 3G-covered service area. You can also receive video calls.



To make a video call, do the following.

- 1 Enter the phone number, as before.
- 2 To start the video function, touch  and choose **Make Video Call**. You will be notified that you will need to close other applications to make the video call.
- 3 Adjust the camera position if necessary.
- 4 If you do not want to use the speakerphone, ensure you have the headset plugged in.
- 5 Press  to finish the call, or close the handset.

**Note:** Your Telstra NextG LG GW382f is only designed to make video calls in portrait orientation.



# Getting Started

## Changing your video call settings

- 1 Press  for longer or for while, select , and choose .
- 2 Select **Video call**.
- 3 Choose the settings of your video calling. Determine whether to Use Substitute Image and select one, switch on the Mirror (so you can see yourself on screen).

## Making a video call from Contacts

It is easy to call anyone whose number you have stored in your Contacts.





Press the down navigation key to access the contacts list. Scroll to your chosen contact. Press the right soft key  Options and select **Make Video call**. Press the  key to finish the call.

## Answering a Call

When you receive a call, the phone rings and the phone icon appears on the screen. If the caller can be identified, the caller's phone number (or name if stored in your Address Book) is displayed.

- 1 Press the  [SEND] or unlock the screen and touch

 Accept.

If Any Key has been set as the Answer Mode, any key press will answer a call except for the  [END] key, ,  and .

- 2 End the call by pressing the  [END] key.

**Note:** You can answer a call while using the Address Book or other menu features.



## **Adjusting the Volume**

During a call, if you want to adjust the earpiece volume, use the side volume keys of the phone.

In the Standby screen, you can adjust the ring volume using the side volume keys.

## **Setting Profiles**

Press either of the side volume keys. You can set your Ringtone to Vibrate All, Alarm Only or Silent All.

# Getting Started

You can also adjust the touchtone sound and vibration volume from the Touchtone tab.

## **Vibration Mode (Quick)**

Vibration Mode can be activated by touching and holding  from the dial pad. You can also set Vibration Mode by pressing and holding down side volume key as well.

The phone will display 'Vibrating Mode On'. If you would like to turn Vibration mode Off, touch and hold  again.

## Signal Strength

If you are inside a building, being near a window may give you better reception. You can see the strength of your signal by the signal indicator on your phone's display screen.

## Entering Text

You can enter alphanumeric characters by using the phone's touch pad. For example, storing names in the Address Book, writing a message or scheduling events in the calendar all require text to be entered.

The following text input modes are available on the phone.

### Using the Symbol Mode

The Symbol Mode enables you to enter various symbols or special characters. To enter a symbol, touch . Then select the desired symbol.

### ABC Mode

This mode allows you to enter letters by touching the key labeled with the required letter once, twice, three or four times until the letter is displayed.

# Getting Started

## 123 Mode (Numbers Mode)



Type numbers using one keytouch per number. To change to 123 mode in a text entry field, touch .





## Changing the Text Input Mode

You can change the text input mode by touching pressing the Text Input Mode toggle button  on the touch screen.



## Using the T9 Mode

The T9 predictive text input mode allows you to enter words easily with a minimum number of key presses. As you touch each key, the phone begins to display the characters that it thinks you are typing based on a built-in dictionary. As new letters are added, the word changes to reflect the most likely candidate from the dictionary.

1 When you are in the T9 predictive text input mode, begin entering a word by pressing the touch screen keys  to . Press one key per letter.

- The word changes as letters are typed - ignore what is displayed on the screen until the word is typed completely.
- If the word is still incorrect after typing completely, press  on the pop up menu to see the options. Then select the word you want by touch.
- If the desired word is missing from the word choices list, add it by pressing  and selecting  to enter the new word. Then press  to save the word into the built-in dictionary.



- 2 Enter the whole word before editing or deleting any letters.
- 3 Complete each word with a space by touching .

To delete letters, touch . Touch and hold down  to erase the entire text entry.



Note: Pressing the  [END] key will save your unsaved message in the Drafts folder.

## Using the ABC Mode

Use the touch pad keys to enter your text.

- 1 Touch the touch key labeled with the required letter:
  - Once for the first letter
  - Twice for the second letter
  - And so on
- 2 To insert a space, touch . To delete letters, touch . Touch and hold down  to erase the entire text entry.

**Note:** Refer to the table below for more information on the characters available using the keys.

Touch  to input a Upper Case letter. To change text entry mode from Lower Case to Upper Case, touch  twice and the key will turn to orange color  - indicating that Caps Lock has been activated.

Key	Characters in the Order Display	
	Upper Case	Lower Case
1	., '@?!-: / 1	., '@?!-: / 1
2	A B C 2	a b c 2
3	D E F 3	d e f 3
4	G H I 4	g h i 4
5	J K L 5	j k l 5
6	M N O 6	m n o 6
7	P Q R S 7	p q r s 7
8	T U V 8	t u v 8
9	W X Y Z 9	w x y z 9
0	Space Key, 0 (Long press)	Space Key, 0 (Long press)

# Getting Started

## Using the 123 (Numbers) Mode

The 123 Mode enables you to enter numbers in a text message (a telephone number, for example) more quickly. Touch the keys corresponding to the required digits before manually switching back to the appropriate text entry mode.

## T9 Dictionary

The T9 Dictionary is a feature that allows the user to add any unique or personal words to the T9 standard language database. The T9 Dictionary function can be selected from the Text Entry Settings by using Options .

Within the T9 Dictionary function, the user can add, modify, delete or reset personal words.



**Note:** You can select a different T9 language from the same Options menu. The default setting on the phone is the T9 disabled mode.



## Qwerty Keypad

### Text input mode using the Qwerty Keypad

When you are required to enter text, for example when writing a message, the keypad will default to ABC mode. If you are entering a number, for example when making a call, the keypad number keys will default to numbers. In ABC mode you can enter numbers by first pressing  and then the number you require.

**Note:** Some fields may allow only one text input mode (e.g. telephone number in Address Book fields).

To input a symbol in the text entry field, press the  key and select a symbol from touch screen. Or to enter a symbol from the qwerty keys, just press  and then press the corresponding key. To return to ABC mode, press  again.

Complete each word with a space by pressing . To delete a character, press  key.

## Using the Korean Mode

Allows you to type in Korean when you set the language to Korean.

## When you use Touch Keypad



Allows you easily input the letters.



To input , touch  and touch .

To input , touch  and touch .

# Getting Started





## When you use Qwerty Keypad

Open the slide and touch .  
Choose Text Entry Settings and Show Key Guide. You can see the Korean key guide on the monitor. To input numbers, touch .



Touch  once, and you can see the Korean key guide as below. To return its normal input mode, touch  again.





# Address Book

From standby screen, touch , choose  and touch . You will see following Address Book's submenus. Or simply touch  from standby screen.

## Contact List

This menu allows you to save and manage contact address information. The Contact List's functions allow you to add a new address or search saved contact addresses by name. To search a contact, touch  and input the contact person's name. From the standby screen, you can directly search for a contact by touching  and .





- : Search a contact.
- : Shows your contacts by first letter/character.
- : Shows your contacts designated as Favorites.

# Address Book

## New Contact

This menu allows you to add a new contact address. You can enter contact address information, including: name, phone numbers, email addresses, group information, pictures, ringtone and a memo.

1 From the standby screen, Touch  and touch .

- 2 Touch  to set a Picture ID for a contact by using a saved picture from Pictures or taking a new picture of the contact person. Choose from **No picture**, **Pictures** or **Take New Picture**. After you take a new picture of the contact person, touch  set as the Contact Picture ID. To delete the picture, touch , select **Yes**, and take a new picture.
- Enter the First name, last name or both.
  - Enter up to five different numbers. Touch  and you can set that number as Speed Dial.
  - Enter an email address.
  - Select a Group for the contact.
  - Set the ringtone for the contact or leave it as default ringtone.
  - Add Memo if necessary.
  - Choose whether to save the contact to Phone or SIM Card memory.



3 Touch  to save the contact.

## Caller Groups

This menu allows you to manage group information. By default, there are 4 groups: Colleague, Family, Friends and School. Or you can put a contact in No Group. You can also configure a ring tone for a group so that the group ring tone sounds when a call from a specific contact address within that group is received and there is no ring tone configured for the specific contact address.

## Speed Dial

You can assign a frequently-called contact to a speed dial list. You can select a number from 2 to 9 as a speed dial. You can configure speed dial numbers for any of the 8 numbers for a specific contact address.

- Your Voicemail is already set to speed dial 1. This is a default setting and can not be changed. Touch the number you wish to assign a speed dial contact, then touch .
- This will open your address book. Touch the contact you would like to assign to that number twice.
- To call an assigned speed dial number, touch  from the Standby Screen. Then touch and hold the assigned number; the call will be placed to the assigned number automatically.

# Address Book

## Management

This menu allows you to copy information from your SIM card, e.g. name, handset number, etc. to your handset. If a name is duplicated during the copying operation, the information is also duplicated.

You can also copy entries from the SIM card to the phone memory and entries from the handset memory to the SIM card (not all the data will be copied).

From this menu, you are also able to delete entries in the SIM card and the Handset.

## Service Numbers

You can view the list of Service Dialing Numbers (SDN) assigned by your network provider. Such numbers could include the emergency services, directory assistance and voice mail numbers.



You may see the names of the available services. Select a service dial number and press the  [[SEND] key.

Please check with your network service provider for details of this service.

## My Numbers

This displays your own phone numbers stored in your phone/SIM card. You can send this via Text Message, Multimedia Message and Bluetooth.

# In-Call Menu

Your phone provides a number of control functions that you can use during a call. To access these functions during a call, touch  to unlock the screen and then touch .



## During a Call

The menu displayed on the handset screen during a call is different from the default main menu displayed when in the Standby screen, and these options are described below.



## Making a Second Call

You can select a number you wish to dial, to make a second call.

- 1 Unlock the Screen. During a call, an In-Call menu will be available.

- 2 Press , enter the 2nd phone number and press .



or

Press  to select a contact from your Address Book and then press the Call button .

When the second call is connected, the first call is automatically placed on hold.



## Swapping Between Two Calls

By using one of the two methods below, you can switch between two on-going calls.

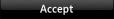

- 1 Press  [SEND] key.
- 2 Touch  and select "Swap Calls".

# In-Call Menu



## Answering an Incoming Call

To answer an incoming call when the handset is ringing, simply press the  [SEND] key or touch . The handset is also able to warn you of an incoming call while you are already on a call. A tone will sound in the earpiece, and the display will show that a second call is waiting. This feature, known as **Call Waiting**, is only available if your network supports it. If Call Waiting is turned on, you can put the first call on hold and answer the second call by pressing the  [SEND] key.

## Rejecting an Incoming Call

You can reject an incoming call without answering by simply pressing the  [END] key or touching .

## Muting the Microphone

You can mute the microphone during a call by touching . The handset can be unmuted by touching  again. When the handset is muted, the caller cannot hear you, but you can still hear the caller.

## Using the Speakerphone

You can use the integrated Speakerphone during a call by touching . The loudspeaker is automatically deactivated when you end the call.



**WARNING:** Due to increased volume levels, do not place the phone near your ear while the speakerphone is enabled.

## Conference Calls

The conference service provides you with the ability to have a simultaneous conversation with more than one caller. The conference call feature can be used only if your network service provider supports this feature.

Once a conference call is set up, calls may be added, disconnected or separated (that is, removed from the conference call but still connected to you) by the person who set up the conference call. These options are all available from the In-Call menu.

The maximum number of callers in a conference call is five. Once started, you are in control of the conference call, and only you can add calls to the conference call.

## Setting Up a Conference Call

To set up a conference call, place the first call. Once that is connected, follow the steps above to make a second call. You can then join the two separate calls by touching  and select the Join Calls from the Conference Call menu.

### Activate the Conference Call on Hold

To activate a conference call on hold, press the  key.

### Adding Calls to the Conference Call

To add a call to an existing conference call, touch  and choose Conference Call, then select the Exclude Call and View Members from the Conference Call option.

# In-Call Menu

## Private Call in a Conference Call

To have a private call with one caller from a conference call, touch  and select Private Call from the Conference Call option. When the numbers of the callers are displayed, select the one you wish to speak in private with. Only the person who initiates the Conference Call can initiate a Private Call.

## Ending a Conference Call

The currently active conference call can be disconnected by pressing the  key.



## Your Standby Screen

From here you can access all menu options, make a quick call and view the status of your phone - as well as many other things.

### Touch Screen Tips

The standby screen is also a great place to get accustomed to the touch screen.

To select an item, touch the icon accurately. Your GW382f can be set to vibrate slightly when it recognises you've touched an option.

To scroll through lists, touch the last item visible and slide your finger up the screen. The list will move up so more items are visible.

- There's no need to press hard, the touchscreen is sensitive enough to pick up on a light yet firm touch.
- Use the tip of your finger to touch the option you require. Be careful not to touch any other keys.

- When the screen light is off, press the  key on the right hand side twice to restore the standby screen.
- Don't cover the phone with a case or cover as the touch screen will not work with any material covering it.

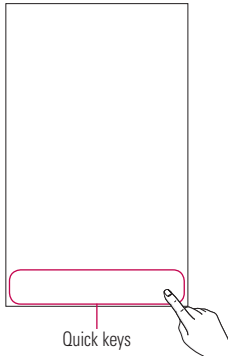

# Your Standby Screen

## The Quick Keys

The quick keys on your standby screen provide easy, one-touch access to your most used functions.



Touch to bring up the touch Dialing Keypad to make a call. Input the number as you would use a normal keypad and touch **Call** or press the  hard key.



Touch to open your contacts and search for the number you want to call. You can also create new contacts and edit existing ones.





Touch to access the Messages options menu. From here you can create a new outgoing Message.



Touch to open the full Top menu which is separated into four sub-menus. Touch the vertical tabs to view further options.

## Home Screen

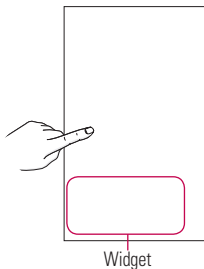

Allows you to use Widgets and even add them to your Home screen.

- Click  to open the Home Screen.
- Drag a Widget from the roll-out Menu onto the Home screen. This will enable you to use Widgets.
- You can play songs, add memos, check the calendar, play slide show, set an alarm or add events directly from the standby screen using Home Screen.
- Click  again to close the Home Screen.



## Visual Contacts



Allows you to easily contact your friends and family by displaying your favorite contacts on the standby screen.





- First, touch  from the standby screen. Touch and hold down .

## Your Standby Screen

- Select  to choose a contact. You can choose up to 6 contacts for one page.
- Touch  to align the contacts on the screen.

- If you want to delete a contact from this screen, touch .

**Note:** Touch  and the contact will have a slight shadow around it. If you slightly shake or move the phone, the contacts will float in the screen. Touch  again and the contacts will be fixed and not be moved by the phone's status.



- Touch  to finish editing the Contacts on this screen. Then to access your Contacts, simply touch on their corresponding icon. Touch  to call,  to send a message and  to check messages received from that person.

- If you want to edit one of the Contacts, touch and hold the contact or the margin space of the screen. It will turn to the Edit screen.

## Shortcuts

Add your favorite menu on the standby screen.

- Touch and hold down any of the items and it will turn to the Edit Screen.

- Touch  to add another application, touch  to delete the application from Shortcuts, touch  to finish.

**Note:** Only three application button can be delete or add which is Bluetooth, Alarm Clock & Camera.







# Your Standby Screen

## Annunciator

With GW382f's Annunciator, you can quickly connect to the Music Player, Bluetooth service and more.

Touch the top side of the standby screen.



- You can use Music Player to edit a playlist or turn on Bluetooth.
- You can set your profile by touching .  
You can set your profile to Normal, Ring and Vibration, Ring after Vibration or Silent and Vibration.
- To check Inbox, touch .
- To send a Mobile Email, touch .
- To check Voicemail, touch .
- If you want to set an Alarm, touch .
- To view the Calendar and add new events, touch .

# Menu Tree

Touch  in the standby screen to open a **Top menu**. From here you can access the following menus: **Phone, Multimedia, My Stuff** and **Settings**



## Phone



Dialing



Address Book



Call Register



Messaging



My EMail



Whereis



Yellow



Social Web



## Multimedia



BigPond



My place



TV & Movies



Music



Applications



Games



Camera



Web Pages



## My Stuff



Audio



Pictures



Video



Tools



Calendar



Alarm Clock



Calculator



More



## Settings



Call



Date & Time



Sound



Display



Touch



Phone



Bluetooth



More

# Messaging

This menu includes functions related to SMS (Short Message Service), MMS (Multimedia Message Service), voice mail as well as the network's service messages.

- **Send-A-Card:** You can send a greeting card by SMS or MMS. Check the availability of this service, pricing and tariffs with your network operator and/or the service provider.



## New Message

- 1 In the standby screen, select .
- 2 Touch **Create Message**.

**Note:** If you attach a graphic or an audio file while writing a multimedia message, the file loading time can take up to 5 seconds. You will not be able to activate any key during the file loading time. When the file loading is complete, you will be able to write a multimedia message.



## Editing a message

The following options are available when Editing a Message.





- **Symbol:** You can insert symbols ranging from sentence notes to emoticons. Touching the  twice, and you can select the symbols you want. You can use  and  to scroll through the various pages of symbols.



Inserting Multimedia files in outgoing messages is easy. Press the  button and select an option from below:

- **Picture:** You can preview the selected picture. Touch  to insert the selected picture.
- **Audio:** You can insert from your saved Audio files.
- **Video:** You can insert from your saved Video clips.
- **New Picture:** You can insert a new image taken from the camera by touching  [Capture].

**Note:** Refer to page 77 for camera options.

- **New Audio:** You can record a new audio clip by touching  .
  -  **Record Mode:** MMS mode record time is about 6 minutes and the General mode provides a longer recording time.
  -  **Quality:** Set the audio quality to Fine, Normal or Economy.
  -  **Select Storage Defaults:** You can assign the default storage to Phone Memory or Memory Card.
- **New Video:** You can record a new video. The options are similar to those when inserting a New Picture.

# Messaging

## • **Template**

- **Text:** You can easily insert frequently used sentences in the text message.
- **Multimedia:** Preset multimedia templates are available.
- **Signature:** Input your own created signature.

- **More:** Allows you to insert Subject, vCard, vCalendar, vNote, vTask or Contact.

**Note:** vCard, vCalendar, vNote, vTask and Contact are created by the Address Book, Calendar, Notepad and Tasks functions. Go to the corresponding sections for more detailed information.

## Using Options

Touch  to use the options below.

### • **Text Entry Settings**

- **Language:** Allows you to set the text entry language to English, Français, Español or Korean.
- **Show/Hide Candidate:** When in T9 Entry Mode, you can see the word candidates as you type.
- **Show/Hide Next Word**
- **T9 Dictionary:** Here you can add/delete/reset/modify words to the T9 Dictionary.

### • **Delivery Options**

- **Delivery Receipt:** If this is set to be On in this menu, you can check whether your message was sent successfully.
- **Reply via Same Message Center:** You can set this to be On or Off.

- **Save to Drafts:** Saves the selected message to Drafts.
- **Writing Font Size:** Set the Writing Font size to Small, Medium and Large.
- **Cancel Message:** Allows you to exit the Message without saving your input message.

### **Sending a Message**

After completing a message using the **Insert/Options**, select **Send To** to send a message.

- Enter the recipient(s). From , you can choose an option item below.
  - **Enter Number:** You can input the recipient(s) number using the Touch keypad or Qwerty keypad.
  - **Enter Email:** You can enter an Email address instead of a phone number.

- **Caller Groups:** Displays Contact Groups.
- **Recent Messages:** Choose a contact from recent messages.
- **Recent Calls:** Choose a contact from recent calls.
- **Delivery Options:** Options of **Delivery Receipt, Reply via Same Message Center, Add Cc,** and **Add Bcc.**
- **Edit Message:** Go back to the message editing mode.
- **Save to Drafts:** Saves the selected message to Drafts.
- **Text Entry Settings:** This menu allows you to set the text entry **Language**. It also allows you to **Show/Hide Candidate, Show/Hide Next Word** and access the **T9 Dictionary** to delete/add/modify words.
- **Cancel Message:** You can cancel the message.

# Messaging

## Message folders

The folder structure on your GW382f was designed to be fast and easy to use.

- **Inbox:** All the messages you receive are placed into your Inbox.
- **Drafts:** If you don't have time to finish writing a message, you can save what you've done so far here.
- **Outbox:** This is a temporary storage folder where messages are stored while being sent.

**Note:** If you see the message “No space for USIM messages”, then you should delete some messages from your Inbox. If you see the message “No space for messages”, then you can delete either messages or saved files to create space.



## Inbox

You will be alerted when you receive a message. They will be stored in the Inbox. In the Inbox, you can identify each message by icons. To reach the Inbox, from the Standby screen, touch  and touch Inbox.

The following options are available when you select a message and touch .

## Conversation View

This mode allows you to view all messages with each contact in conversational order.

Choose  to see messages in detail or choose  for the simple view.

## Standard View

The following options are available in standard view:

- **Add to Address Book:** You can save the sender's phone number in the Contact List.
- **Select Slide:** If the multimedia message has more than one slide, you can select and move to the desired slide.
- **Extract Data:** You can make a voice call or send a message. You can save the number As New contact or Updating Existing.
- **Message Details:** You can view information about received messages; message Type, Subject, Sender's address, and message Time.

The following Options are available in Inbox folder.

- **Delete:** You can pick a message and delete it.
- **Standard/Conversation View:** You can select between the two viewing modes.
- **Sort By:** You can sort all messages by Name, Title, Date and Read/Unread.
- **Delete All Read Messages:** You can delete all read messages.

## Drafts

You can view the messages saved as drafts. To see the Drafts folder, touch the . Quick key from the Standby screen, then touch **Drafts**.

# Messaging

## Outbox

Outbox is a temporary storage place for messages waiting to be sent. When you press the  [SEND] key, you can make a call to the number of the recipient number of the selected message.

If the message is not sent from the Outbox, you will receive a sound alert along with a Message Sending Failure notice on the screen.

Another attempt will be made to send the failed message and after two unsuccessful attempts, the message will no longer be sent automatically. In order to send the message that has failed, you must touch  to resend the message.

After the maximum number of Send attempts has been reached, the **Send** function has failed. If you were trying to send a text message, open the message and check that the Sending options are correct.

Outbox list will display messages in sending failed, sending or waiting, sent order. Touch  to use options available from Outbox list.

- **Delete:** Deletes a message you choose.
- **Sort by:** Sorts by name, title and date.

• **Delete All:** Delete all messages. Those options are available when you choose a message in Outbox.

- **Make Video Call:** You can make a video call to the sender.
- **View Status:** Shows message status as failed, sent or error.
- **Edit:** Allows you to edit the selected message.

- **Select slide:** If the multimedia message has more than one slide, you can select and move to the desired slide.
- **View Attachment:** View attachment of the message.
- **Message Details:** Allows you to view the information on the message.

## Voice mail

This menu provides you with a quick way of accessing your voice mailbox (if provided by your network).

**Note:** Please check with your network service provider for details of their service in order to configure the handset accordingly.

## Videomail

If your operator supports this service you can create a new account.

## Message Settings

To configure **Messaging settings**, touch the  Quick key from the Standby screen, then touch **Message Settings**.

## Message Alert

You can set the Sounds and Alert Type here.

## Save to

Choose between Phone and SIM Card to save message.

## Signature

This feature allows you to create your Text signature. You can use symbols, templates and contacts as part of the signature.

# Messaging

## Text Message

### • Text Templates

There are 6 predefined messages in the list. You can view and edit the template messages or create new ones.



The following options are available when you touch .

- **Add New:** Allows you to create a new template.
- **Delete:** Allows you to delete the selected template message.
- **Delete All:** Deletes all messages in the folder.

To edit an existing Template, touch it (to open) then touch the text.

The Edit Template screen will automatically open.

- **Msg Center No.:** If you want to send a text message, you can get the address of the SMS center by using this menu.

- **Subject:** You can enter SMS Subject when this menu is ON. You can switch between  to  by dragging it from left to right.
- **Message Types:** Message types: Convert your text into Voice, Fax, X.400 or Email.
- **Validity period:** Choose how long your messages are stored at the message centre.
- **Delivery Receipt:** Set  to receive confirmation that your messages have been delivered.
- **Reply via Same Message Centre:** You can set On or Off.
- **Signature:** You can set On or Off.



## Multimedia Message

- **Templates:** Multimedia templates are available and can be created here.
- **Priority:** You can choose to set the priority of the message.
- **Subject:** You can enter the MMS Subject when this option is  ON . You can switch between  OFF to  ON by dragging it from left to right.
- **Validity Period:** This network service allows you to decide how long your multimedia messages will be stored at the message center.
- **Send Delivery Receipt:** Allows you to send a delivery confirmation mail for a Multimedia Message.
- **Send Read Receipt:** Allows you to send a message read confirmation mail for a Multimedia Message.
- **Download Options**
  - **Download Without Ask:** Allows Multimedia Messages to be downloaded automatically.
  - **Ask Always:** You can download a multimedia message manually.
  - **Discard:** Used when the user rejects download of the Multimedia Message.
- **Message Center:** The details for the Multimedia gateway are pre-loaded onto your handset and should not be changed.

# Messaging

## Email

- **Email Accounts:** Manage your email accounts.
- **Allow Reply Email:** Choose whether to allow read confirmation messages to be sent.
- **Request Reply Email:** Choose whether to request read confirmation messages.
- **Retrieve Interval:** Select how often your GW382f checks for new email messages.
- **Retrieve amount**
- **Include Message in Fwd & Reply:** Select to include the original message in your reply.
- **Include Attachment:** Select to include the original attachment in any reply.
- **Auto Retrieval in Roaming:** Choose whether to retrieve messages automatically when abroad (roaming).

- **New Email Notification:** Choose whether to be alerted about a new e-mail without a pop-up message.
- **Priority:** Choose the priority level of your Email.
- **Message Sending Size:** Choose the sending size of your Email.

## Voicemail Number

This menu allows you to set the voicemail center number if this feature is supported by Telstra. Please check with Telstra for details of their service in order to configure the handset correctly.

## Videomail Number

This menu allows you to set the voicemail center number if this feature is supported by Telstra. Please check with Telstra for details of their service in order to configure the handset correctly.