



USER GUIDE

**LG** LG-H540T

This model is not intended for sale in the USA



# User Guide

ENGLISH





- Some contents and illustrations may differ from your device depending on the region, service provider, software version, or OS version, and are subject to change without prior notice.
- Always use genuine LG accessories. The supplied items are designed only for this device and may not be compatible with other devices.
- This device is not suitable for people who have a visual impairment due to the touchscreen keyboard.
- Copyright ©2015 LG Electronics, Inc. All rights reserved. LG and the LG logo are registered trademarks of LG Group and its related entities. All other trademarks are the property of their respective owners.
- Google™, Google Maps™, Gmail™, YouTube™, Hangouts™ and Play Store™ are trademarks of Google, Inc.









# Table of contents



<b>Guidelines for safe and efficient use</b> .....	<b>4</b>	Creating your Google account .....	45
<b>Important notice</b> .....	<b>18</b>	Signing into your Google account.....	45
<b>Getting to know your phone</b> .....	<b>21</b>	<b>Connecting to Networks and Devices</b> ....	<b>47</b>
Phone layout.....	21	Wi-Fi .....	47
Installing the SIM or USIM card and		Bluetooth.....	48
battery.....	23	Wi-Fi Direct .....	49
Charging the battery.....	25	Transferring data between a PC and	
Inserting a memory card.....	26	the device.....	50
Removing the memory card.....	27	<b>Calls</b> .....	<b>51</b>
Locking and unlocking the device .....	27	Making a call.....	51
<b>Your Home screen</b> .....	<b>29</b>	Calling your contacts .....	51
Touch screen tips .....	29	Answering and rejecting a call .....	51
Home screen .....	30	Making a second call.....	52
Customizing the Home screen .....	31	Viewing your call logs.....	52
Returning to recently-used		Call settings.....	52
applications.....	32	<b>Contacts</b> .....	<b>53</b>
Notifications panel.....	33	Searching for a contact.....	53
On-screen keyboard .....	36	Favourites contacts.....	53
<b>Special Features</b> .....	<b>37</b>	Creating a group.....	54
Gesture shot.....	37	<b>Messaging</b> .....	<b>55</b>
Glance View.....	39	Sending a message .....	55
KnockON .....	39	Conversation view .....	56
Knock Code .....	40	Changing your messaging settings .....	56
Dual window.....	41	<b>E-mail</b> .....	<b>57</b>
QuickMemo+.....	42	Managing email accounts.....	57
<b>Google account setup</b> .....	<b>45</b>	Working with account folders.....	57

Composing and sending email .....	58	<b>Phone software update .....</b>	<b>92</b>
<b>Camera and Video.....</b>	<b>59</b>	Phone software update .....	92
Camera options on the viewfinder.....	59	<b>About this user guide .....</b>	<b>94</b>
Using the advanced settings .....	60	About this user guide.....	94
Manual mode on the viewfinder.....	61	Trademarks .....	95
Once you have taken a photo.....	62	<b>Accessories.....</b>	<b>96</b>
Recording a video.....	64	<b>Troubleshooting .....</b>	<b>97</b>
After recording a video.....	64	<b>FAQ .....</b>	<b>100</b>
Gallery.....	66		
<b>Multimedia .....</b>	<b>70</b>		
Music .....	70		
<b>Utilities .....</b>	<b>72</b>		
Clock.....	72		
Calculator .....	73		
Calendar.....	73		
Voice Recorder .....	74		
Voice Search.....	74		
Downloads .....	74		
FM Radio .....	75		
LG Health .....	75		
<b>Web Browser.....</b>	<b>76</b>		
Internet.....	76		
Chrome .....	78		
<b>Settings .....</b>	<b>79</b>		
Networks.....	79		
Sound & notification .....	82		
Display .....	83		
General.....	85		

## Guidelines for safe and efficient use

Symbol	Description
	Read these instructions for safe use of this wireless device.
	You must always exercise extreme caution when driving in order to reduce the risk of accidents. Do not use your wireless device while driving.
	Do not leave the device or its accessories within the reach of children and do not allow to play with. The device contains small parts with sharp edges that may cause injury or break off and give rise to danger of suffocation.
	This device may produce a loud sound.
	Switch off your phone when prompted to do so in hospitals, clinics or health care facilities. These requests are designed to prevent possible interference with sensitive medical devices.

Symbol	Description
	Turn off your wireless device when prompted to do so by airport personnel or aircraft. For information on the use of wireless devices on board aircraft, contact the crew. If the device has a "flight mode", this must be activated before boarding an aircraft.
	Turn off the device or wireless device when in any area in which they occur explosions or areas where there are reports that indicate to "turn off two-way radio" or "electronic devices" to avoid interfering with the operation of trigger explosions.
	Among the areas with potentially explosive atmospheres include fueling areas are, the holds of ships, facilities for the transportation or storage of fuel and chemicals, areas where the air contains chemicals or particles such as grain, dust or metal powders.
	This device may produce a bright or flashing light.
	Do not expose your device or its accessories to open flames.
	Do not expose your device or its accessories to magnetic media (floppy disks, credit cards, etc).
	Do not expose your device or its accessories to extreme temperatures.
	Do not expose your device or its accessories to liquid or moisture.

Symbol	Description
	<p>Not groped to disassemble the device or its accessories, only authorized personnel can do it.</p>
	<p>This device, like any wireless device, operates using radio signals which, by their nature, are not able to guarantee connection in all conditions. Therefore, for emergency communications, never rely solely upon any wireless device.</p>
	<p>Only use approved accessories.</p>

Please read these simple guidelines. Not following these guidelines may be dangerous or illegal. Should a fault occur, a software tool is built into your device that will gather a fault log.

This tool gathers only data specific to the fault, such as signal strength, cell ID position in sudden call drop and applications loaded. The log is used only to help determine the cause of the fault. These logs are encrypted and can only be accessed by an authorized LG Repair centre should you need to return your device for repair.



## Information about the RF exposure from FCC

In August 1996, the Federal Communications Commission (FCC) of the United States, with its action in Report and Order FCC 96-326, adopted an updated safety standard for human exposure to radio frequency (RF) electromagnetic energy emitted by FCC regulated transmitters. Those guidelines are consistent with the safety standard previously set by both international and U.S. standards. The design of this phone complies with FCC guidelines and these international standards.

### Part 15.19 statement

This device complies with part 15 of the FCC Rules. Operation is subject to the following two conditions:

- (1) This device may not cause harmful interference, and
- (2) this device must accept any interference received, including interference that may cause undesired operation.

### Part 15.21 Statement

Changes or modifications not expressly approved by the manufacturer could void the user's authority to operate the equipment.

## Body-worn Operation

This device was tested for typical bodyworn operations with the back of the phone kept 0.39 inches (1cm) between the user's body and the back of the phone. To comply with FCC RF exposure requirements, a minimum separation distance of 0.39 inches (1cm) must be maintained between the user's body and the back of the phone.

Any beltclips, holsters, and similar accessories containing metallic components may not be used. Body-worn accessories that cannot maintain 0.39 inches (1cm) separation distance between the user's body and the back of the phone, and have not been tested for typical body-worn operations may not comply with FCC RF exposure limits and should be avoided.

### **Part 15.105 Statement**

This equipment has been tested and found to comply with the limits for a class B digital device, pursuant to Part 15 of the FCC Rules. These limits are designed to provide reasonable protection against harmful interference in a residential installation. This equipment generates uses and can radiate radio frequency energy and, if not installed and used in accordance with the instructions, may cause harmful interference to radio communications. However, there is no guarantee that interference will not occur in a particular installation. If this equipment does cause harmful interference or television reception, which can be determined by turning the equipment off and on, the user is encouraged to try to correct the interference by one or more of the following measures:

- Reorient or relocate the receiving antenna.
- Increase the separation between the equipment and receiver.
- Connect the equipment into an outlet on a circuit different from that to which the receiver is connected.
- Consult the dealer or an experienced radio/TV technician for help.

## Product care and maintenance

### **WARNING**

Only use batteries, chargers and accessories approved for use with this particular phone model. The use of any other types may invalidate any approval or warranty applying to the phone and may be dangerous.

- Do not disassemble this unit. Take it to a qualified service technician when repair work is required.
- Repairs under warranty, at LG's discretion, may include replacement parts or boards that are either new or reconditioned, provided that they have functionality equal to that of the parts being replaced.
- Keep away from electrical appliances such as TVs, radios and personal computers.
- The unit should be kept away from heat sources such as radiators or cookers.
- Do not drop.
- Do not subject this unit to mechanical vibration or shock.
- Switch off the phone in any area where you are required to by special regulations. For example, do not use your phone in hospitals as it may affect sensitive medical equipment.
- Do not handle the phone with wet hands while it is being charged. It may cause an electric shock and can seriously damage your phone.
- Do not charge a handset near flammable material as the handset can become hot and create a fire hazard.
- Use a dry cloth to clean the exterior of the unit (do not use solvents such as benzene, thinner or alcohol).
- Do not charge the phone when it is on soft furnishings.
- The phone should be charged in a well ventilated area.
- Do not subject this unit to excessive smoke or dust.
- Do not keep the phone next to credit cards or transport tickets; it can affect the information on the magnetic strips.

- Do not tap the screen with a sharp object as it may damage the phone.
- Do not expose the phone to liquid or moisture.
- Use accessories like earphones cautiously. Do not touch the antenna unnecessarily.
- Do not use, touch or attempt to remove or fix broken, chipped or cracked glass. Damage to the glass display due to abuse or misuse is not covered under the warranty.
- Your phone is an electronic device that generates heat during normal operation. Extremely prolonged, direct skin contact in the absence of adequate ventilation may result in discomfort or minor burns. Therefore, use care when handling your phone during or immediately after operation.
- If your phone gets wet, immediately unplug it to dry off completely. Do not attempt to accelerate the drying process with an external heating source, such as an oven, microwave or hair dryer.
- The liquid in your wet phone, changes the color of the product label inside your phone. Damage to your device as a result of exposure to liquid is not covered under your warranty.

## Efficient phone operation

### Electronics devices

All mobile phones may receive interference, which could affect performance.

- Do not use your mobile phone near medical equipment without requesting permission. Avoid placing the phone over pacemakers, for example, in your breast pocket. Please consult your doctor to determine if operation of your phone may interfere with the operation of your medical device.
- Some hearing aids might be disturbed by mobile phones.
- Minor interference may affect TVs, radios, PCs etc.
- Use your phone in temperatures between 0 °C and 40 °C, if possible. Exposing your phone to extremely low or high temperatures may result in damage, malfunction, or even explosion.

## Hospitals

Switch off your wireless device when requested to do so in hospitals, clinics or health care facilities. These requests are designed to prevent possible interference with sensitive medical equipment.

## Road safety

Check the laws and regulations on the use of mobile phones in the area when you drive.

- Do not use a hand-held phone while driving.
- Give full attention to driving.
- Use a hands-free kit, if available.
- Pull off the road and park before making or answering a call if driving conditions require you to do so.
- RF energy may affect some electronic systems in your vehicle such as car stereos and safety equipment.
- If your vehicle is equipped with an air bag, do not obstruct with installed or portable wireless equipment. It can cause the air bag to fail or cause serious injury due to improper performance.
- If you are listening to music while out and about, please ensure that the volume is at a reasonable level so that you are aware of your surroundings. This is of particular importance when near roads.

## Avoid damage to your hearing



To prevent possible hearing damage, do not listen at high volume levels for long periods.

Damage to your hearing can occur if you are exposed to loud sound for long periods of time. We therefore recommend that you do not turn on or off the handset close to your ear. We also recommend that music and call volumes are set to a reasonable level.

- When using headphones, turn the volume down if you cannot hear the people speaking near you, or if the person sitting next to you can hear what you are listening to.

**NOTE:** Excessive sound pressure from earphones and headphones can cause hearing loss.

## Glass Parts

Some parts of your mobile device are made of glass. This glass could break if your mobile device is dropped on a hard surface or receives a substantial impact. If the glass breaks, do not touch or attempt to remove it. Stop using your mobile device until the glass is replaced by an authorised service provider.

## Blasting area

Do not use the phone where blasting is in progress. Observe restrictions and follow any regulations or rules.

## Potentially explosive atmospheres

- Do not use your phone at a refueling point.
- Do not use near fuel or chemicals.
- Do not transport or store flammable gas, liquid or explosives in the same compartment of your vehicle as your mobile phone or accessories.

## In aircraft

Wireless devices can cause interference in aircraft.

- Turn your mobile phone off before boarding any aircraft.
- Do not use it on the ground without permission from the crew.

## Children

Keep the phone in a safe place out of the reach of small children. It includes small parts which may cause a choking hazard if detached.

## Emergency calls

Emergency calls may not be available on all mobile networks. Therefore you should never depend solely on your phone for emergency calls. Check with your local service provider.

## Battery information and care

- You do not need to completely discharge the battery before recharging. Unlike other battery systems, there is no memory effect that could compromise the battery's performance.
- Use only LG batteries and chargers. LG chargers are designed to maximise the battery life.
- Do not disassemble or short-circuit the battery.
- Keep the metal contacts of the battery clean.
- Replace the battery when it no longer provides acceptable performance. The battery pack may be recharged hundreds of times before it needs replacing.
- Recharge the battery if it has not been used for a long time to maximise usability.
- Do not expose the battery charger to direct sunlight or use it in high humidity, such as in the bathroom.
- Do not leave the battery in hot or cold places, as this may deteriorate battery performance.
- There is risk of explosion if the battery is replaced with an incorrect type.
- Dispose of used batteries according to the manufacturer's instructions. Please recycle when possible. Do not dispose as household waste.
- If you need to replace the battery, take it to the nearest authorised LG Electronics service point or dealer for assistance.
- Always unplug the charger from the wall socket after the phone is fully charged to save unnecessary power consumption of the charger.
- Actual battery life will depend on network configuration, product settings, usage patterns, battery and environmental conditions.
- Make sure that no sharp-edged items such as animal's teeth or nails, come into contact with the battery. This could cause a fire.



## Laser safety statement

### Caution!

This product employs a laser system. To ensure proper use of this product, please read this owner's manual carefully and retain for future reference. Should the unit require maintenance, contact an authorized service center.

Use of controls, adjustments, or the performance of procedures other than those specified herein may result in hazardous radiation exposure.

To prevent direct exposure to laser beam, do not try to open the enclosure or make direct contact with the laser.

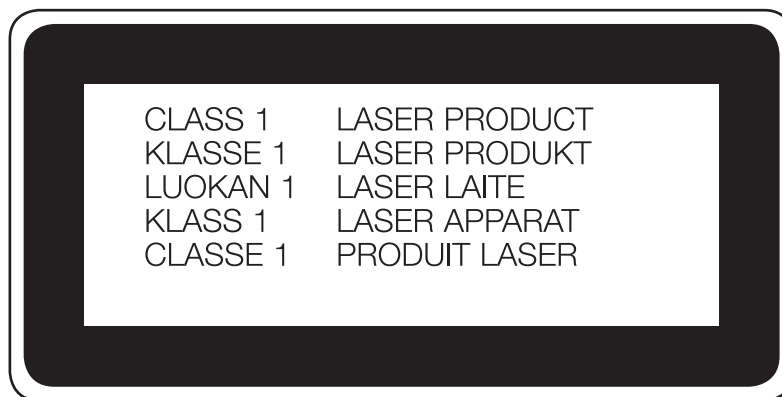

### **Open Source Software Notice Information**

To obtain the source code under GPL, LGPL, MPL, and other open source licenses, that is contained in this product, please visit <http://opensource.lge.com>.

In addition to the source code, all referred license terms, warranty disclaimers and copyright notices are available for download.

LG Electronics will also provide open source code to you on CD-ROM for a charge covering the cost of performing such distribution (such as the cost of media, shipping, and handling) upon email request to [opensource@lge.com](mailto:opensource@lge.com). This offer is valid for three (3) years from the date on which you purchased the product.

### **HOW TO UPDATE YOUR DEVICE**

Access to latest firmware releases, new software functions and improvements.

- **Select the software update in settings menu on your device.**
- **Update your device by connecting it to your PC.** For more information about using this function, please visit <http://www.lg.com/common/index.jsp> select country and language.



### Disposal of your old appliance

- 1** All electrical and electronic products should be disposed of separately from the municipal waste stream via designated collection facilities appointed by the government or the local authorities.
- 2** The correct disposal of your old appliance will help prevent potential negative consequences for the environment and human health.
- 3** For more detailed information about disposal of your old appliance, please contact your city office, waste disposal service or the shop where you purchased the product.



### Disposal of waste batteries/accumulators

- 1** This symbol may be combined with chemical symbols for mercury (Hg), cadmium (Cd) or lead (Pb) if the battery contains more than 0.0005% of mercury, 0.002% of cadmium or 0.004% of lead.
- 2** All batteries/accumulators should be disposed separately from the municipal waste stream via designated collection facilities appointed by the government or the local authorities.
- 3** The correct disposal of your old batteries/accumulators will help to prevent potential negative consequences for the environment, animal and human health.
- 4** For more detailed information about disposal of your old batteries/accumulators, please contact your city office, waste disposal service or the shop where you purchased the product.

# Important notice



## Please read this before you start using your phone!

Please check to see whether any problems you encountered with your phone are described in this section before taking the phone in for service or calling a service representative.

### 1. Phone memory

When there is less than 10MB of space available in your phone memory, your phone cannot receive new messages. You may need to check your phone memory and delete some data, such as applications or messages, to make more memory available.

To uninstall applications:

- 1 Tap  >  >  > **General** tab > **Apps**.
- 2 Once all applications appear, scroll to and select the application you want to uninstall.
- 3 Tap **Uninstall**.

### 2. Optimizing battery life

Extend your battery's power by turning off features that you do not need to run constantly in the background. You can monitor how applications and system resources consume battery power.

Extending your phone's battery life:

- Turn off radio communications when you are not using. If you are not using Wi-Fi, Bluetooth or GPS, turn them off.
- Reduce screen brightness and set a shorter screen timeout.
- Turn off automatic syncing for Gmail, Calendar, Contacts and other applications.

- Some applications you download may consume battery power.
- While using downloaded applications, check the battery charge level.

### 3. Before installing an open source application and OS

#### **WARNING**

- If you install and use an OS other than the one provided by the manufacturer it may cause your phone to malfunction. In addition, your phone will no longer be covered by the warranty.
- To protect your phone and personal data, only download applications from trusted sources, such as Play Store™. If there are improperly installed applications on your phone, the phone may not work normally or a serious error may occur. You must uninstall those applications and all associated data and settings from the phone.

### 4. Using the Hard Reset (Factory Reset)

If your phone does not restore to its original condition, use a Hard Reset (Factory Reset) to initialize it.

- 1** Turn the power off.
- 2** Press and hold the **Power/Lock Key + Volume Down Key** on the back of the phone.
- 3** Release the **Power/Lock Key** only when the boot logo is displayed, then immediately press and hold the **Power/Lock Key** again.



- 4 Release all Keys when the Factory hard reset screen is displayed.
- 5 Press the **Volume Keys** to select **Yes**, and then press the **Power/Lock Key** to perform a Hard Reset.
- 6 Press the **Volume Keys** to highlight **Yes** once more, then press the **Power/Lock Key** to confirm.

### **WARNING**

If you perform a Hard Reset, all user applications, user data and DRM licenses will be deleted. Please remember to backup any important data before performing a Hard Reset.

## 5. Opening and switching applications

Multitasking is easy with Android; you can keep more than one application running at the same time. There is no need to quit an application before opening another. Use and switch between several open applications. Android manages each application, stopping and starting them as needed to make sure that idle applications don't consume resources unnecessarily.

- 1 Tap . App previews of recently used applications will be displayed.
- 2 Tap the application you want to access. This does not stop the previous app from running in the background. Make sure to tap  to back out of an app after using it.
  - To close an app from the recent apps list, swipe the app preview to the left or right. To clear all apps, tap **Clear all**.

## 6. When the screen freezes

If the screen freezes or the phone does not respond when you try to operate it, remove the battery and reinsert it. Then power the phone back on.

# Getting to know your phone

## Phone layout

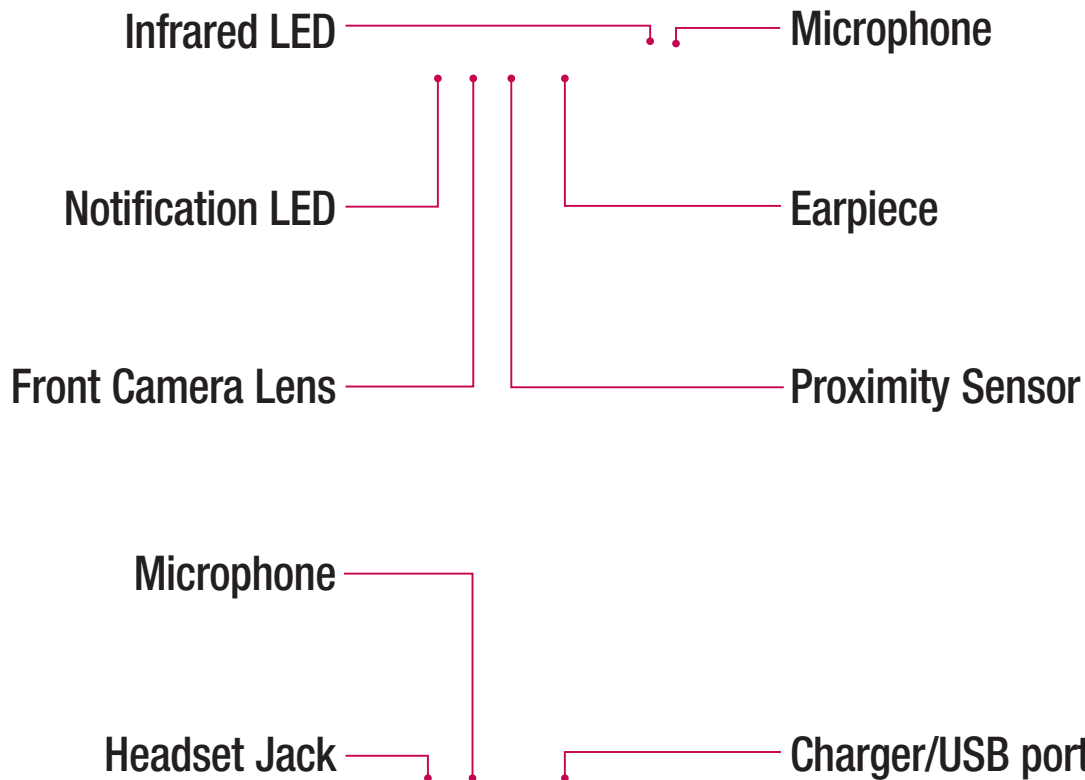

### NOTE: Proximity sensor

- When receiving and making calls, the proximity sensor automatically turns the backlight off and locks the touch screen by sensing when the phone is near your ear. This extends battery life and prevents you from unintentionally activating the touch screen during calls.

### WARNING

Placing a heavy object on the phone or sitting on it can damage the display and touch screen functions. Do not cover the proximity sensor with screen protectors or any other type of protective film. This could cause the sensor to malfunction.

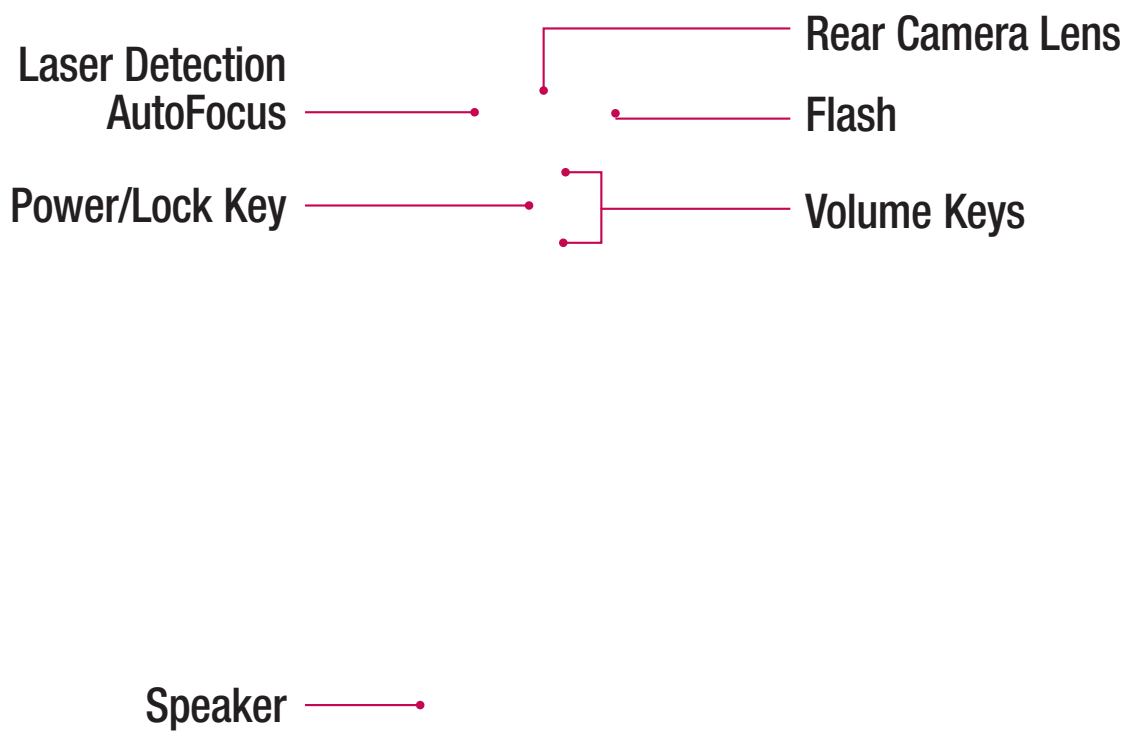

<b>Power/Lock Key</b>	<ul style="list-style-type: none"> <li>• Turn your phone on/off by pressing and holding this key.</li> <li>• Short press to lock/unlock the screen</li> </ul>
<b>Volume Keys</b>	<p><b>(While screen is off)</b></p> <ul style="list-style-type: none"> <li>• Press Volume Up Key twice to launch QuickMemo+</li> <li>• Press Volume Down Key twice to launch Camera</li> </ul>





 **WARNING**

Do not insert a memory card into the SIM card slot. If a memory card happens to be lodged in the SIM card slot, take the device to a LG Service Center to remove the memory card.

**NOTE**

- Only the microSIM cards work with the device.

**3** Insert the battery.

**4** To replace the cover onto the device, align the back cover over the battery compartment **1** and press it down until it clicks into place **2**.

## Charging the battery

Charge the battery before using it for first time. Use the charger to charge the battery. A computer can also be used to charge the battery by connecting the phone to it using the USB cable.

### **WARNING**

Use only LG-approved chargers, batteries and cables. If you use unapproved chargers, batteries or cables, it may cause battery charging delay. Or this can cause the battery to explode or damage the device, which are not covered by the warranty.

The charger connector is located at the bottom of the phone. Insert the charger and plug it into a power outlet.

### **NOTE**

- Do not open the back cover while your phone is charging.

## Inserting a memory card

Your device supports up to a 32GB microSD card. Depending on the memory card manufacturer and type, some memory cards may not be compatible with your device.

### **WARNING**

Some memory cards may not be fully compatible with the device. Using an incompatible card may damage the device or the memory card, or corrupt the data stored in it.

### **NOTE**



- Frequent writing and erasing of data shortens the lifespan of memory cards.

- 1** Remove the back cover.
- 2** Insert a memory card with the gold-coloured contacts facing downwards.

- 3** Replace the back cover.

## Removing the memory card

Before removing the memory card, first unmount it for safe removal.

- 1 Tap  >  >  > **General tab** > **Storage** > **Unmount SD card**.
- 2 Remove the back cover and pull out the memory card.

### **WARNING**

Do not remove the memory card while the device is transferring or accessing information. Doing so can cause data to be lost or corrupted or damage to the memory card or device. It is not responsible for losses that result from the misuse of damaged memory cards, including the loss of data.

## Locking and unlocking the device

Pressing the **Power/Lock Key** turns off the screen and puts the device into lock mode. The device automatically gets locked if it is not used for a specified period. This helps to prevent accidental taps and saves battery power.



To unlock the device, press the **Power/Lock Key** and swipe the screen in any direction.

### **NOTE**

- Double-tapping on the screen also can wake up the screen instead of the **Power/Lock Key**.

## Changing the screen lock method

You can change the way that you lock the screen to prevent others accessing your personal information.

- 1 Tap  >  >  > **Display tab** > **Lock screen** > **Select screen lock**.
- 2 Select a desired screen lock from None, Swipe, Knock Code, Pattern, PIN and Password.

## NOTE



- Create a Google account before setting an unlock pattern and remember the Backup PIN you created when creating your pattern lock.

**Caution!** If you haven't created a Google account on the phone and you forgot your PIN, Password, and the backup PIN, you need to perform a hard reset. But if you perform a hard reset, all user applications and user data will be deleted. Please remember to back up any important data before performing a hard reset.

## TIP! Smart Lock

You can use **Smart Lock** to make unlocking your phone easier. You can set it to keep your phone unlocked when you have a trusted Bluetooth device connected to it, when it's in a familiar location like your home or work, or when it recognises your face.

### Setting up Smart Lock

- 1 Tap  >  > .
- 2 Tap **Display** tab > **Lock screen** > **Smart Lock**.
- 3 Before you add any trusted devices, trusted places, or trusted face, you need to set up a screen lock (Pattern, PIN or Password).

# Your Home screen

## Touch screen tips

Here are some tips on how to navigate on your phone.

- **Tap or touch** – A single finger tap selects items, links, shortcuts and letters on the on-screen keyboard.
- **Touch and hold** – Touch and hold an item on the screen by tapping it and not lifting your finger until an action occurs.
- **Drag** – Touch and hold an item for a moment and then, without lifting your finger, move your finger on the screen until you reach the target position. You can drag items on the Home screen to reposition them.
- **Swipe or slide** – To swipe or slide, quickly move your finger across the surface of the screen, without pausing when you first tap it (so you don't drag an item instead).
- **Double-tap** – Double-tap to zoom on a webpage or a map.
- **Pinch-to-Zoom** – Use your index finger and thumb in a pinching or spreading motion to zoom in or out when using the browser, Maps, or when viewing pictures.
- **Rotate the screen** – From many applications and menus, the screen orientation adjusts to the device's physical orientation.

### NOTE

- Do not press too hard; the tap screen is sensitive enough to pick up a light, yet firm tap.
- Use the tip of your finger to tap the option you want. Be careful not to tap any other buttons.

## Home screen

The Home screen is the starting point for many applications and functions. It allows you to add items like app shortcuts and Google widgets to give you instant access to information and applications. This is the default canvas and accessible from any menu by tapping .



- 1** Shows phone's status information, including the time, signal strength, battery status and notification icons.
- 2** Widgets are self-contained applications that can be accessed through the Apps drawer or on the Home screen. Unlike a shortcut, a Widget can function as an on-screen application.
- 3** Tap an icon (application, folder, etc.) to open and use it.
- 4** Indicates which Home screen canvas you are currently viewing.
- 5** Provides one-touch access to the function in any Home screen canvas.



<b>6</b> ◀ <b>Back Button</b>	Returns to the previous screen. Also closes pop-up items, such as menus, dialog boxes and the on-screen keyboard.
○ <b>Home Button</b>	Return to the Home screen from any screen.
□ <b>Recent Apps Button</b>	Displays recently used applications. If you touch and hold this Button, it opens a menu of available options.

## Extended Home screen

The operating system provides multiple Home screen canvases to provide more space for adding icons, widgets and more.

- Slide your finger left or right across the Home screen to access additional canvases.

## Customizing the Home screen

You can customize your Home screen by adding apps and widgets and changing wallpapers.

### Adding items on your Home screen

- 1 Touch and hold the empty part of the Home screen.
- 2 In the Add Mode menu, select the item you want to add. You then see this added item on the Home screen.
- 3 Drag it to the desired location and lift your finger.

**TIP!** To add an application icon to the Home screen from the Apps screen, touch and hold the application you want to add.

### Removing an item from the Home screen

- While on the Home screen, touch and hold the icon you want to remove > drag it to .

## Adding an app to the Quick Button Area

- From the Apps screen or on the Home screen, touch and hold an application icon and drag it to the Quick Button Area. Then release it in the desired location.

## Removing an app from the Quick Button Area

- Touch and hold the desired Quick Button, drag it to .



### NOTE

- The **Apps Button**  cannot be removed.

## Customizing app icons on the Home screen

- 1 Touch and hold an application icon until it unlocks from its current position, then release it. The editing icon  appears in the upper-right corner of the application.
- 2 Tap the application icon again and select the desired icon design and size.
- 3 Tap **OK** to save the change.

## Returning to recently-used applications

- 1 Tap . App previews of recently used applications will be displayed.
- 2 Tap an app preview to open the application.  
- OR -  
Tap  to return to your previous screen.

## Notifications panel

Notifications alert you to the arrival of new messages, calendar events and alarms, as well as ongoing events, such as when you are on a call.

When a notification arrives, its icon appears at the top of the screen. Icons for pending notifications appear on the left, and system icons, such as Wi-Fi and battery strength are shown on the right.

### NOTE

- The available options may vary depending on the region or service provider.

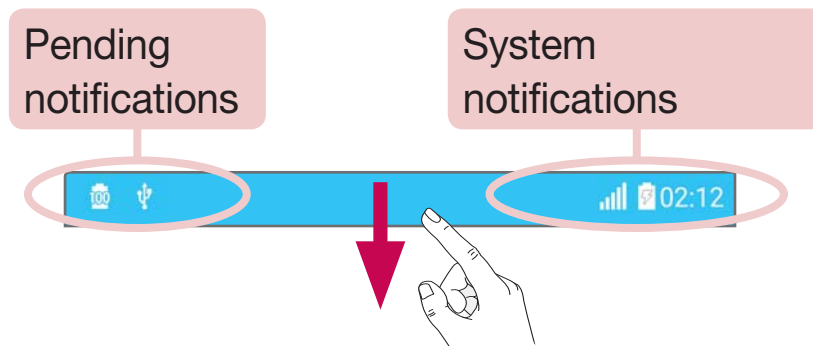

### Opening the notifications panel

Swipe down from the status bar to open the notifications panel. To close the notifications panel, swipe the screen upwards or tap .

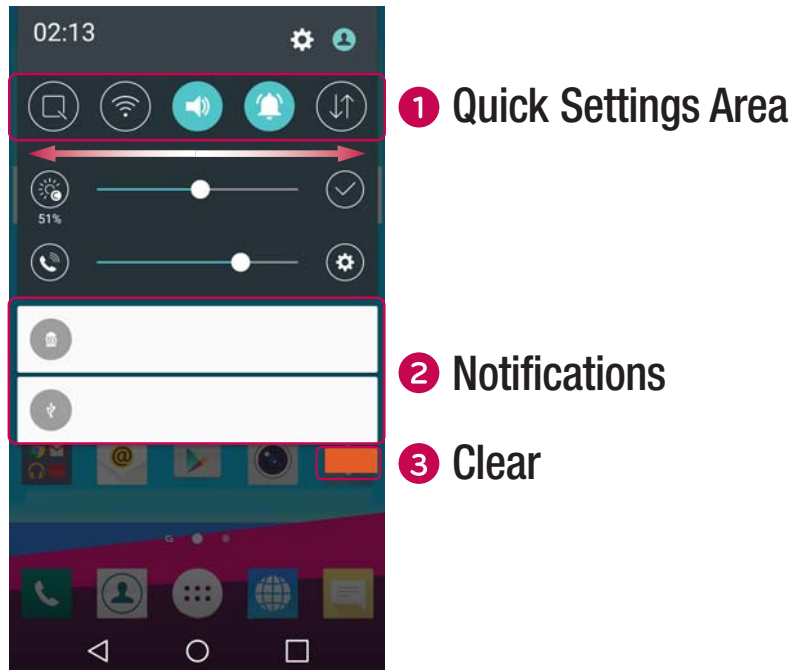



























- 1 Tap each quick setting button to toggle it on/off. Touch and hold the desired button to directly access the settings menu for the function. To see more toggle buttons, swipe left or right. Tap  to remove, add or rearrange quick setting buttons.
- 2 Current notifications are listed, each with a brief description. Tap a notification to view it.
- 3 Tap to clear all the notifications.

### Indicator icons on the Status Bar

Indicator icons appear on the status bar at the top of the screen to report missed calls, new messages, calendar events, device status and more.



The icons displayed at the top of the screen provide information about the status of the device. The icons listed in the table below are some of the most common ones.

Icon	Description	Icon	Description
	No SIM card inserted		A song is currently playing
	No network signal available		Ringer is silenced
	Airplane mode is on		Vibrate mode is on
	Connected to a Wi-Fi network		Battery fully charged
	Wired headset connected		Battery is charging
	Call in progress		The phone is connected to a PC via a USB cable
	Missed call		Downloading data
	Bluetooth is on		Uploading data
	System warning		GPS is on
	An alarm is set		Data is synchronizing
	New voicemail available		Choose input method
	New text or multimedia message		Wi-Fi hotspot is active
	NFC is on		Media server content sharing is on





#### NOTE

- The icon's location in the status bar may differ according to the function or service.

## On-screen keyboard

You can enter text using the on-screen keyboard. The on-screen keyboard appears on the screen when you tap an available text entry field.

### Using the keypad and entering text

-  Tap once to capitalize the next letter you type. Double-tap for all caps.
-  Tap to go to the keyboard settings. Touch and hold to change entering text method.
-  Tap to enter a space.
-  Tap to create a new line.
-  Tap to delete the previous character.

### Entering accented letters

When you select French or Spanish as the text entry language, you can enter special French or Spanish characters (e.g. "á").

For example, to input "á", touch and hold the "a" key until the zoom-in key expands and displays characters from different languages. Then select the special character you want.

# Special Features

## Gesture shot

The Gesture shot feature allows you to take a picture with a hand gesture using the front camera.

### To take a photo

There are two methods for using the Gesture shot feature.

- Raise your hand, with an open palm, until the front camera detects it and a box appears on the screen. Then close your hand into a fist to start the timer, allowing you time to get ready.
- OR -
- Raise your hand, in a clenched fist, until the front camera detects it and a box appears on the screen. Then unclench your fist to start the timer, allowing you time to get ready.

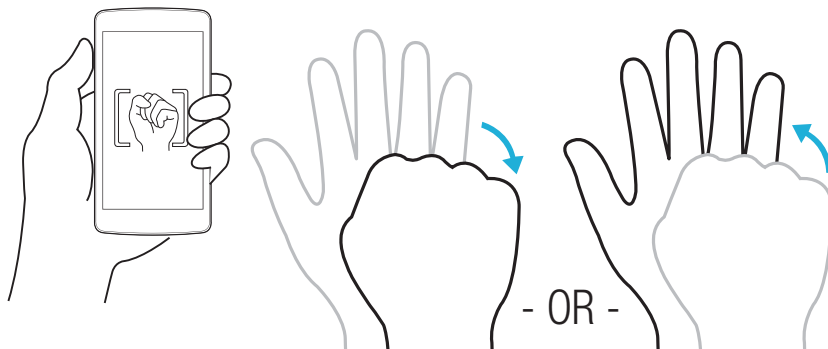



### **TIP! Interval shot**

If you make a fist twice or touch and hold , the camera consecutively takes 4 photos at a time.

## Gesture View

After taking a photo with the front camera lens, you can automatically check the captured photo with this gesture.

- 1 Tap  >  > .
- 2 Take a picture with the front camera.
- 3 After taking the picture, bring the phone close to your face. The captured photo will be displayed.

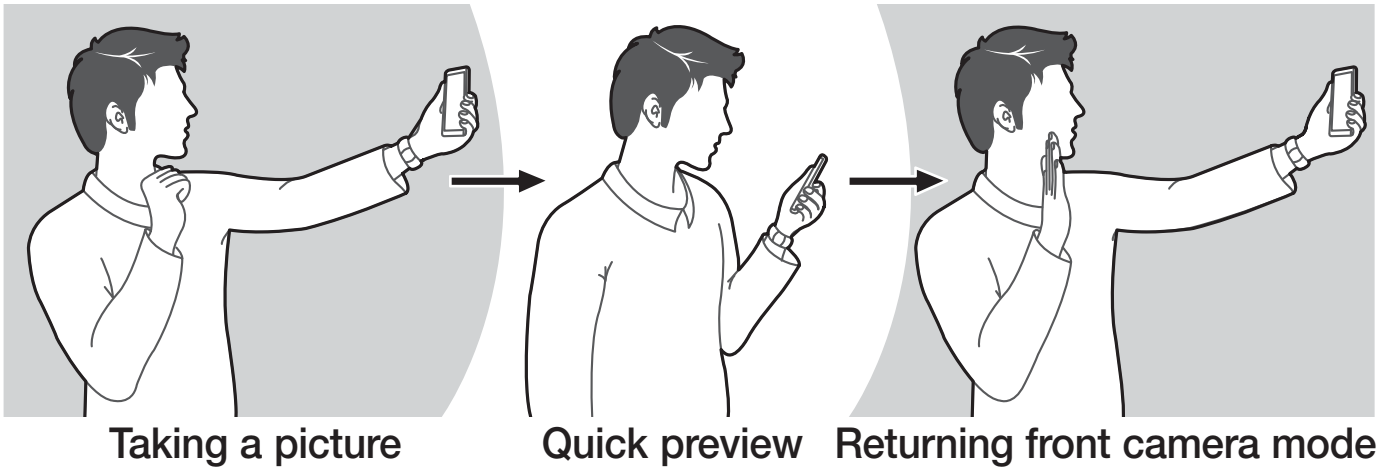

### NOTE

- Depends on the speed and angle of the gesture, this feature may not work properly.
- When the angle is changed after Quick preview, it will go back to the camera mode. You should go to Gallery to view the picture again.



## Glance View

When the phone screen is off, you can see the status bar, time and date by dragging your finger down on the screen.



## KnockON

The KnockON feature allows you to double-tap the screen to easily turn it on or off.

### To turn the screen on

- 1 Double-tap the center of the Lock screen to turn the screen on.
- 2 Unlock the screen or access any of the available shortcuts or widgets.

### To turn the screen off

- 1 Double-tap an empty area of the Home screen or the Status Bar.
- 2 The screen will turn off.

#### NOTE



- Tap on the center area of the screen. If you tap on the bottom or the top area, the recognition rate may decrease.

## Knock Code

The Knock Code feature allows you to create your own unlock code using a combination of knocks on the screen. You can access the Home screen directly when the screen is off by tapping the same sequence on the screen.

### NOTE

- If you enter the wrong Knock Code 6 times, it will compulsorily take you to your google account log in/backup PIN.
- Use the fingertip instead of finger nail to tap the screen for turning it on or off.
- When the Knock Code is not in use, you can use Knock On function by tapping the screen.

- 1 Tap  >  >  > **Display** tab > **Lock screen** > **Select screen lock** > **Knock Code**.
- 2 Tap the squares in a pattern to set your Knock Code. Your Knock Code pattern can be 3 to 8 taps.

### Unlocking the screen using the Knock Code

You can unlock the screen by tapping the Knock Code pattern you already set, when the screen turns off.

## Dual window

This feature allows you to multi-task by splitting up the screen into two, allowing you to use two compatible applications at the same time.

1 Tap  > **Dual window**.

2 Tap or drag the app icon for the corresponding application you wish to use.

 : Tap to view the Dual window menu options, or drag to resize the split screens.

 : Switch two screens.



 : View the app list.

 : Change the selected window to full screen.

 : Close the currently selected app window.

### NOTE

- You can enable or disable Dual window through the Settings menu.

1 Tap  >  >  > **General** tab > **Dual window**.

2 Slide the toggle key to **On** or **Off**.





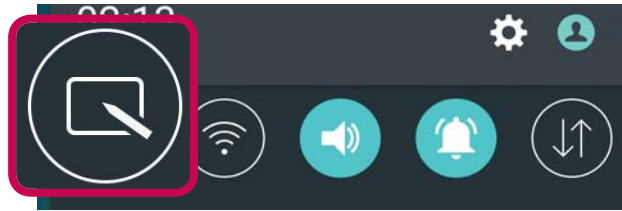

## QuickMemo+

The **QuickMemo+** feature allows you to create memos and capture screen shots. You can use QuickMemo+ to easily and efficiently create memos during a call, with a saved picture or on the current phone screen.

- 1 Tap and drag the Status Bar down and tap .



- 2 Create a memo using the following options:

	Tap to undo the most recent action.
	Tap to redo the most recently deleted action.
	Tap to insert text into your memo.
	Tap to select the pen type and color.
	Tap to use the eraser to erase the pen marks on the memo.
	Tap to save the memo you've created.
	Tap to hide or display the toolbar.

### NOTE







- Please use a fingertip while using the QuickMemo+ feature. Do not use your fingernail.

- 3 Tap  to save the current memo to the **QuickMemo+** or **Gallery**.

## Discard QuickMemos

- Tap .





## View the Saved Memo

- Tap  >  >  and select the **QuickMemo+** album.  
- OR -  
Tap  >  >  and select the desired memo.

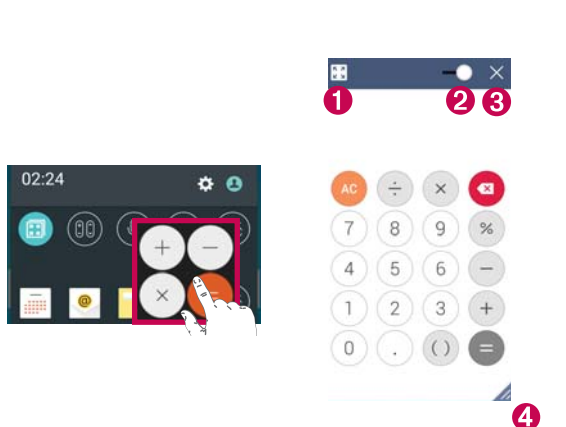
## QSlide

From any screen, use the Notification panel to easily access and use the Notepad, Calendar, Calculator, and more with QSlide.



1		Tap to expand the window to full window size.
2		Tap to adjust the window's transparency.
3		Tap to close the QSlide window.
4		Drag to adjust the size.

- 1 Touch and slide the status bar downward > tap **QSlide** to view the available QSlide apps.

**TIP!** While using applications that support QSlide, tap  > **QSlide**. The function is displayed as a small window on your screen.

- 2 You can use and tap the screen under the **QSlide** windows when the transparency bar is not full .

**NOTE** QSlide can support up to two windows at the same time.

# QuickRemote

QuickRemote turns your phone into a Universal Remote for your home TV, set-top box and audio system, and more.

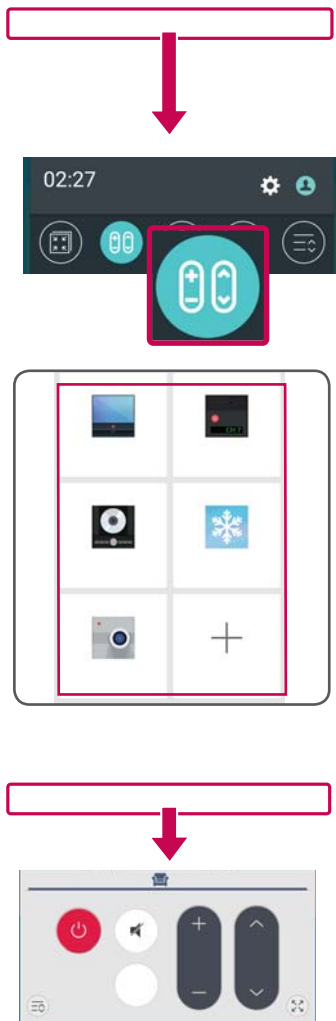

## Set up

1 Touch and slide the Status bar downward and tap  > **ADD REMOTE**.

- OR -

Tap  >  > **Apps** tab (if necessary) >  > tap .

2 Select the type and brand of the device, then follow the on-screen instructions to configure the device.

## Access your QuickRemote

3 Once you have completed the initial set up, you can easily access the QuickRemote from the Notification panel. Open the Notification panel and use the QuickRemote functions.



### NOTE

- The QuickRemote operates the same way as an ordinary remote control infrared (IR) signals. Be careful not to cover the infrared sensor at the top of the phone when you use the QuickRemote function. This function may not be supported depending on the model, the manufacturer or service company.



# Google account setup

The first time you open a Google application on your phone, you will be required to sign in with your existing Google account. If you do not have a Google account, you will be prompted to create one.

## Creating your Google account

- 1 Tap  >  >  > **General** tab > **Accounts & sync**.
- 2 Tap **Add account** > **Google** > **Create a New Account**.
- 3 Enter your first and last name, then tap **Next**.
- 4 Enter a username and tap **Next**. Your phone will communicate with Google servers and check for username availability.
- 5 Enter your password and tap **Next**.
- 6 Follow the instructions and enter the required and optional information about the account. Wait while the server creates your account.

## Signing into your Google account

- 1 Tap  >  >  > **General** tab > **Accounts & sync**.
- 2 Tap **Add account** > **Google**.
- 3 Enter your email address and tap **Next**.
- 4 After signing in, you can use Gmail and take advantage of Google services on your phone.
- 5 Once you have set up your Google account, your phone will automatically synchronise with your Google account on the web (if a data connection is available).

After signing in, your phone will sync with your Google services, such as Gmail, Contacts, and Google Calendar. You can also use Maps, download applications from Play Store, back up your settings to Google servers, and take advantage of other Google services on your phone.

## **IMPORTANT**

- Some applications, such as Calendar, work only with the first Google Account you add. If you plan to use more than one Google Account with your phone, be sure to sign into the one you want to use with such applications first. When you sign in, your contacts, Gmail messages, Calendar events, and other information from these applications and services on the web are synchronized with your phone. If you don't sign into a Google Account during setup, you will be prompted to sign in or to create a Google Account the first time you start an application that requires one, such as Gmail or Play Store.
- If you have an enterprise account through your company or other organization, your IT department may have special instructions on how to sign into that account.







# Connecting to Networks and Devices

## Wi-Fi

You can use high-speed Internet access while within the coverage of the wireless access point (AP).





### Connecting to Wi-Fi networks

- 1 Tap  >  >  > **Networks** tab > **Wi-Fi**.
- 2 Tap  to turn Wi-Fi on and start scanning for available Wi-Fi networks.
- 3 Tap a network to connect to it.
  - If the network is secured with a lock icon, you will need to enter a security key or password.
- 4 The status bar displays icons that indicate Wi-Fi status.

#### NOTE

- If you are out of the Wi-Fi zone or have set Wi-Fi to Off, the device may automatically connect to the Web using mobile data, which may incur data charges.

#### TIP! How to obtain the MAC address

Tap  >  >  > **Networks** tab > **Wi-Fi** >  > **Advanced Wi-Fi** > **MAC address**.





## Bluetooth

Bluetooth is a short-range communications technology that allows you to connect wirelessly to a number of Bluetooth devices, such as headsets and hands-free car kits, and Bluetooth-enabled handhelds, computers, printers, and wireless devices.

### NOTE

- LG is not responsible for the loss, interception or misuse of data sent or received via the Bluetooth feature.
- Always make sure that you share and receive data with devices that are trusted and properly secured.
- If there are obstacles between the devices, the operating distance may be reduced.
- Some devices, especially those that are not tested or approved by Bluetooth SIG, may be incompatible with your device.

### Pairing your phone with another Bluetooth device

- 1 Tap  >  >  > **Networks** tab > **Bluetooth**.
- 2 Tap  to turn Bluetooth on and start scanning for available Bluetooth devices.
  - If you want to detect the visible devices in range additionally, tap **Search for devices**.
- 3 Choose the device you want to pair with from the list. Once the pairing is successful, your phone connects to the other device.

### NOTE

- Pairing between two Bluetooth devices is a one-time process. Once a pairing has been created, the devices will continue to recognize their partnership and exchange information.

**TIP!** Please consult documentation included with Bluetooth device for information on pairing mode and passcode (typically 0 0 0 0 – four zeroes).

## Sending data via Bluetooth

- 1 Select a file or item such as a contact or media file.
- 2 Select the option for sending data via Bluetooth.
- 3 Search for and pair with a Bluetooth-enabled device.

### NOTE

- Due to different specifications and features of other Bluetooth-compatible devices, display and operations may be different, and functions such as transfer or exchange may not be possible with all Bluetooth compatible devices.

## Receiving data via Bluetooth

- 1 Tap  >  >  > **Networks** tab > **Bluetooth**.
- 2 Tap  to turn Bluetooth on.
- 3 You will receive a request to accept a pairing attempt from the sending device. Be sure to select **Accept**.

## Wi-Fi Direct

Wi-Fi Direct provides a direct connection between Wi-Fi enabled devices without requiring an access point.

### Turning on Wi-Fi Direct

- 1 Tap  >  >  > **Networks** tab > **Wi-Fi**.
- 2 Tap  > **Advanced Wi-Fi** > **Wi-Fi Direct**.

### NOTE

- When in this menu, your device is visible to other visible Wi-Fi Direct devices nearby.

## Transferring data between a PC and the device

You can copy or move data between a PC and the device.

### Transferring data

- 1 Connect your device to a PC using the USB cable that came with your phone.
- 2 Open the Notifications panel, tap the current connection type, and select **Media device (MTP)**.
- 3 A window will pop-up on your PC, allowing you to transfer the desired data.





#### NOTE

- The LG Android Platform Driver is required to be installed on your PC to be able to detect the phone.
- Check the requirements for using **Media device (MTP)**.

Items	Requirement
OS	Microsoft Windows XP SP3, Vista or higher
Window Media Player version	Windows Media Player 10 or higher



# Calls

## Making a call



- 1 Tap  >  to open the dialer.
- 2 Enter the number using the dialer. To delete a digit, tap  .
- 3 After entering the desired number, tap  to place the call.
- 4 To end the call, tap .

**TIP!** To enter "+" to make international calls, touch and hold .

## Calling your contacts

- 1 Tap  >  to open your contacts.
- 2 Scroll through the contact list. You can also enter the contact's name in the Search field or scroll along the alphabet letters on the right edge of the screen.
- 3 In the list that is displayed, tap the contact you want to call.





## Answering and rejecting a call

- Swipe  in any direction to answer the incoming call.
- Swipe  in any direction to decline an incoming call.

### NOTE

- Tap or swipe the **Decline with message** if you want to send a message to the caller.

## Making a second call

- 1 During your first call, tap  > **Add call** and enter the number.
- 2 Tap  to place the call.
- 3 Both calls are displayed on the call screen. Your initial call is locked and put on hold.
- 4 Tap the displayed number to toggle between calls. Or tap  to start a conference call.
- 5 To end all calls, tap .

### NOTE

- You are charged for each call you make.

## Viewing your call logs

- 1 Tap  >  > **Call logs** tab.
- 2 View a list of all dialed, received and missed calls.

### TIP!

- Tap any call log entry to view the date, time and duration of the call.
- Tap  > **Delete all** to delete all of the recorded items.

## Call settings



You can configure phone call settings, such as call forwarding, as well as other special features offered by your carrier.

- 1 Tap  >  to open the dialer.
- 2 Tap  > **Call settings** and configure the desired options.

# Contacts

You can add contacts on your phone and synchronize them with the contacts in your Google Account or other accounts that support syncing contacts.

## Searching for a contact

- 1 Tap  >  to open your contacts.
- 2 Tap **Search contacts** and enter the contact name using the keyboard.



## Adding a new contact

- 1 Tap  >  and enter the new contact's number.
- 2 Tap  > **Add to Contacts** > **New contact**.
- 3 If you want to add a picture to the new contact, tap the image icon. Choose **Take photo** or **Select from Gallery**.
- 4 Enter the desired information for the contact.
- 5 Tap **Save**.



## Favourites contacts

You can classify frequently called contacts as favourites.



### Adding a contact to your favourites

- 1 Tap  >  to open your contacts.
- 2 Tap a contact to view its details.
- 3 Tap the star at the top right of the screen. The star turns yellow.

## Removing a contact from your favourites list

- 1 Tap  >  > **Favourites** tab.
- 2 Choose a contact to view its details.
- 3 Tap the yellow star at the top right of the screen. The star turns a dark color and the contact is removed from your favourites.

## Creating a group

- 1 Tap  >  > **Groups** tab.
- 2 Tap  > **New group**.
- 3 Enter a name for the new group. You can also set a distinct ringtone for the newly created group.
- 4 Tap **Add members** to add contacts to the group and tap **ADD**.
- 5 Tap **SAVE** to save the group.

### NOTE



- If you delete a group, the contacts assigned to that group will not be lost. They will remain in your contact list.



# Messaging

Your phone combines text and multimedia messaging into one intuitive, easy to use menu.

## Sending a message

- 1 Tap  >  > .
- 2 Enter a contact name or contact number into the **To** field. As you enter the contact name, matching contacts appear. You can tap a suggested recipient and add more than one contact.

### NOTE

- You may be charged for each text message you send. Please consult with your service provider.

- 3 Tap the text field and start entering your message.
- 4 Tap  to open the options menu. Choose from any of the available options.

**TIP!** You can tap  to attach the file that you want to share with message.

- 5 Tap **Send** to send your message.

### TIP!

- The 160-character limit may vary from country to country depending on how the text message is coded and the language used in the message.
- If an image, video, or audio file is added to a text message, it will be automatically converted into a multimedia message and you will be charged accordingly.

## NOTE

- When you get a text message during a call, there will be an audible notification.

## Conversation view

Messages exchanged with another party are displayed in chronological order so that you can conveniently see and find your conversations.

## Changing your messaging settings

Your phone's messaging settings are predefined to allow you to send messages immediately. You can change the settings based on your preferences.

- Tap  >  >  > **Settings**.



# E-mail

You can use the Email application to read email from providers other than Gmail. The Email application supports the following account types: POP3, IMAP and Microsoft Exchange (for Enterprise users).

## Managing email accounts

### To open the Email application





The first time you open the Email application, a setup wizard opens to help you add an email account.

- Tap  >  > .

### Adding another email account:

- Tap  >  >  >  > **Settings** > .

### Changing an email general settings:

- Tap  >  >  >  > **Settings** > **General settings**.

### Deleting an email account:





- Tap  >  >  >  > **Settings** >  > **Remove account** > Select the account to delete > **Remove** > **Yes**.

## Working with account folders

- Tap  >  >  >  > **Folders**.

Each account has Inbox, Outbox, Sent and Drafts folders. Depending on the features supported by your account's service provider, you may have additional folders.

## Composing and sending email

- 1 Tap  >  >  to create a new email.
- 2 Enter an address for the message's intended recipient. As you enter text, matching addresses will be offered from your contacts. Separate multiple addresses with semicolons.
- 3 Tap the **Cc/Bcc** field to copy or blind copy to other contacts/email addresses.
- 4 Tap the text field and enter your message.
- 5 Tap  to attach the file you want to send with your message.
- 6 Tap  to send the message.

# Camera and Video

## Camera options on the viewfinder

You can use the camera or camcorder to take and share pictures and videos.

- Tap  >  >  >  > .

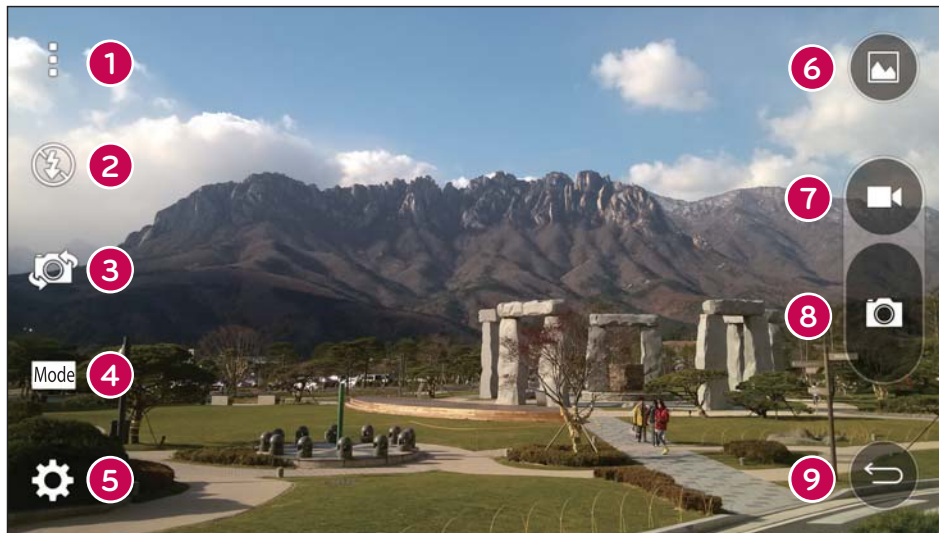







- 1 Hide/Display Options** – Tap to hide/display the camera options on the viewfinder. Choose from **Simple**, **Basic** or **Manual**.
- 2 Flash** – Allows you to manage the camera's flash.
- 3 Swap camera** – Tap to swap between the rear camera lens and the front camera lens.
- 4 Shot mode** – Allows you to select the shot mode for the picture.
- 5 Settings** – Tap this icon to open the camera settings menu.
- 6 Gallery** – Tap to view the last photo or video you recorded.
- 7 Record** – Tap to start recording.
- 8 Capture** – Tap to take a photo.
- 9 Back Button** – Tap to exit the camera.

**NOTE** Be sure to clean the protective lens cover with a microfiber cloth before taking pictures. A lens cover with smudges from fingers can cause blurry pictures with a "halo" effect.

## Using the advanced settings

In the camera viewfinder, tap  to show the advanced options. Tap each icon to adjust the following camera settings.

	Combines photos taken at multiple exposures into one optimal photo to get a better photo in difficult lighting situations.
	Set the size of your picture and video.
	Allows you to take pictures with voice commands. When on, you just say " <b>Cheese</b> ", " <b>Smile</b> ", " <b>LG</b> ", etc. to take a picture.
	Set your camera's timer. This is ideal if you want to be a part of the picture or video.
	Allows you to take better pictures and record better videos by displaying a grid line for help with alignment.
	Set the storage location for your pictures and videos. Choose from <b>IN</b> (internal memory) and <b>SD</b> (memory card). This menu appears only when the SD card is inserted.
	Allows you to learn how a function works. This icon will provide you with a help guide.

## Manual mode on the viewfinder

You can control every detail option manually.



- Tap > > > .







- 1 – Tap to select a file format between the JPEG and the DNG.
- 2 – Tap to improve color quality in various lighting conditions.
- 3 – Tap to use the manual focus mode.
- 4 – Tap to adjust the brightness.
- 5 – Tap to adjust the ISO.
- 6 – Tap to adjust the shutter speed.
- 7 – Tap to use the auto expose lock.
- 8 Display the manual status information.

## Using the advanced settings for the manual mode

In the camera viewfinder, tap  to show the advanced options. Tap each icon to adjust the following camera settings.





	Tap to display a crop line or a grid line for help with alignment.
	Tap to display a histogram.

## Taking a photo

- 1 Tap  >  > .
- 2 Frame your subject on the screen.
- 3 A square around the subject indicates that the camera has focused.
- 4 Tap  to take a photo. Your picture will be automatically saved to the Gallery.

## Once you have taken a photo

Tap the image thumbnail on the screen to view the last photo you took.

	Tap to edit the photo.
	Tap to take another photo immediately.
	Tap to open the available sharing options.
	Tap to delete the photo.
	Tap to access additional options.
	Tap to add the photo to your favorites.



## Multi-point Auto Focus







When you take a picture, the Multi-point Auto Focus (AF) function operates automatically and will allow you to see a clear image.

## Burst shot

Allows you to take multiple shots quickly. Touch and hold .





## Panorama mode

Allows you to take a panoramic picture.

- 1 Tap  >  > .
- 2 Tap  > .
- 3 Tap  to start taking the panoramic picture.
- 4 Pan your phone slowly in one direction.
- 5 Make sure that the focus area aligns with the blue guideline while taking the photo.
- 6 Tap  to stop taking the panoramic picture.



## Dual

The Dual feature allows you to take a picture or record a video with the front and rear cameras at the same time.

- 1 Tap  >  > .
- 2 Tap  > .

### NOTE

- Drag the small screen to move it to your desired location. Touch and hold the small screen to resize it. Tap on the small screen to alternate between the two cameras.

- 3 Tap  to take a picture.  
- OR -  
Tap  to record video.
- 4 Tap  to stop dual recording.





## 8X Zooming

When using the rear camera lens, you can zoom in or out to 8x.





### NOTE

- Use a steady hand. This feature does not work with some functions. Objects may be overlapped when taking a picture of fast-moving subjects.

## Recording a video





- 1 Tap  >  > .
- 2 Frame your subject on the screen.
- 3 Tap  to start recording the video.
- 4 The length of the recording is displayed on the top of the screen.

### NOTE

- Tap  to take pictures while recording video.
- 5 Tap  to pause recording video. You can resume recording again by tapping .
  - OR -
  - Tap  to stop recording. Your video will be automatically saved to the Gallery.

## After recording a video

Tap the video thumbnail on the screen to view the last video you recorded.

	Tap to record another video immediately.
	Tap to open the available sharing options (such as Messaging or Bluetooth) to share.
	Tap to delete the video.
	Tap to access additional options.



Tap to add the video to your favorites

## Live Zoom

Live Zoom allows you to zoom in or out on a portion of a video that is being played to make the desired section appear larger or smaller.

When viewing a video, use your index finger and thumb in a pinching or spreading motion to zoom in or out.

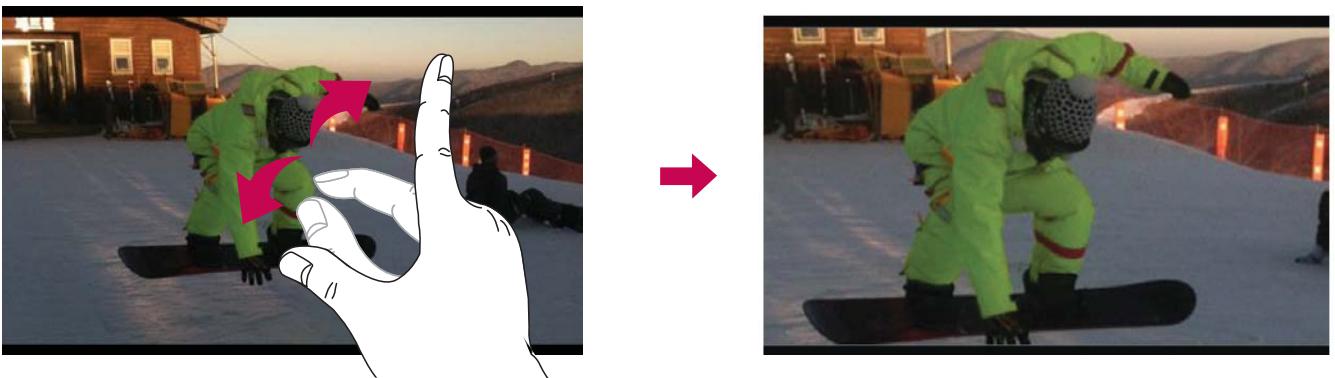

**NOTE** Do not press too hard; the touch screen is sensitive enough to pick up a light, but firm touch.

## Dual Play



Dual Play (wired or wireless connection to two displays) can be run on a different screen.

### NOTE

- Connect two devices using a wired (Slimport-HDMI) cable or wirelessly (Miracast). The connectable device can be a TV or a monitor supported by an HDMI cable or Miracast. The Gallery and Video apps are supported on Dual Play. Tap  once when two displays are a different status (i.e. the monitor is playing a video and your phone's video app is displaying an empty screen), then Dual Play will start. Not all videos are supported by Dual Play. Dual Play operates at 1280X720 or higher display resolution.

## Gallery

The Gallery application presents the pictures and videos in your storage, including those you've taken with the Camera application and those you downloaded from the web or other locations.

- 1 Tap  >  >  to view the images stored in the storage.
- 2 Tap an album to open it and view its contents. (The pictures and videos in the album are displayed in chronological order.)
- 3 Tap a picture in an album to view it.

### NOTE

- Depending on the software installed, some file formats may not be supported.
- Some files may not play properly due to their encoding.





## Viewing pictures

The Gallery displays your pictures in folders. When an application, such as E-mail, saves a picture, the download folder is automatically created to contain the picture. Likewise, capturing a screenshot automatically creates the Screenshots folder.

Pictures are displayed by the date they were created. Select a picture to view it full screen. Scroll left or right to view the next or previous image.





## Timeline view

The Gallery automatically sorts and displays a lot of photos in chronological order to see at a glance.

- 1 Tap  >  > .
- 2 Tap  > **Timeline**.
- 3 Select from **Year**, **Month** and **Day**.

## Memories view

The Gallery automatically organises and displays the memories albums depending on the region and time information of saved photos.

- 1 Tap  >  > .
- 2 Tap  > **Memories**.
- 3 Select memories albums.

### NOTE



- This feature is a location based service. Take photos and videos with their locations.

## Zooming in and out







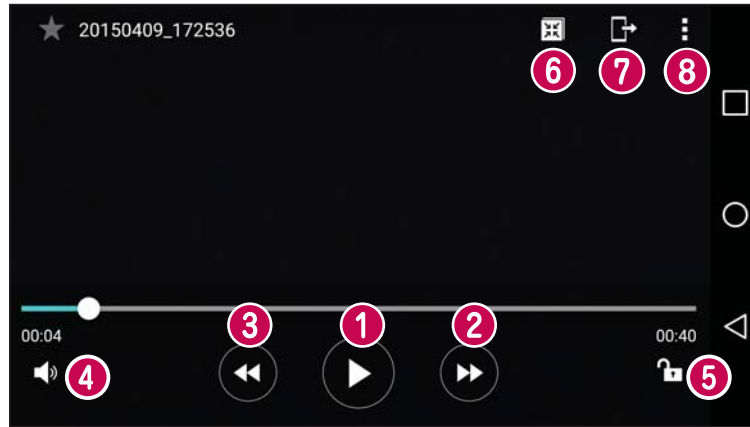

Use one of the following methods to zoom in on an image:

- Double-tap anywhere to zoom in.
- Spread two fingers apart on any place in the picture zoom in. Pinch in or double-tap the image to zoom out.

## Video options

- 1 Tap  >  > .
- 2 Select the video you want to watch.



	Tap to pause/resume video playback.
	Touch and hold to fast-forward in 3 second increments. Tap to fast-forward 10 seconds.
	Touch and hold to rewind in 3 second increments. Tap to rewind 10 seconds.
	Tap to adjust the video volume.
	Tap to lock/unlock the screen.
	Tap to use QSlide for the Video app.
	Tap to share your video using the SmartShare function.
	Tap to access additional options.

## NOTE



- While playing a video, slide the right side of the screen up or down to adjust the sound.
- While playing a video, slide the left side of the screen up or down to adjust the brightness.
- While playing a video, slide your finger from left to right (or vice versa) to fast-forward and rewind.

## Editing photos

While viewing a photo, tap .

## Deleting photos/videos

Use one of the following methods:

- While in a folder, tap , select the photos/videos and then tap **Delete**.
- While viewing a photo, tap .

## Setting wallpaper

While viewing a photo, tap  > **Set image as** to set the image as wallpaper or assign it to a contact.

## NOTE



- Depending on the software installed, some file formats may not be supported.
- If the file size exceeds the available memory, an error can occur when you open files.

# Multimedia



## Music

Your phone has a music player that lets you play all your favorite tracks.









### Playing a song

- 1 Tap  >  > .
- 2 Tap the **Songs** tab.
- 3 Select the song you want to play.
- 4 The following options are available.



1		Tap to pause playback.
		Tap to resume playback.
2		Tap to skip to the next track in the album, playlist or shuffle list. Touch and hold to fast-forward.



3		Tap to restart the current track or skip to the previous track in the album, playlist or shuffle list. Touch and hold to rewind.
4		Tap to adjust the volume.
5		Tap to set audio effects.
6		Tap to play the current playlist in shuffle mode (tracks are played in random order).
7		Tap to toggle through repeat all songs, repeat current song and repeat off.
8		Tap to share your music using the SmartShare function.
9		Tap to add the song to your favorites.
10		Tap to open the current playlist.
11		Tap to access additional options.



## NOTE

- Depending on the software installed, some file formats may not be supported.
- If the file size exceeds the available memory, an error can occur when you open files.
- Music file copyrights may be protected by international treaties and national copyright laws. Therefore, it may be necessary to obtain permission or a licence to reproduce or copy music. In some countries, national laws prohibit private copying of copyrighted material. Before downloading or copying the file, please check the national laws of the relevant country concerning the use of such material.

# Utilities



## Clock

The Clock app gives you access to the Alarms, Timer, World clock and Stopwatch functions. Access these functions by tapping the tabs across the top of the screen or swiping horizontally across the screen.

- Tap  >  > .

## Alarms

The Alarms tab allows you to set alarms.

- 1 Tap  >  >  > **Alarm** tab.
- 2 Tap  to add a new alarm.
- 3 Adjust the settings as necessary and tap **Save**.

### NOTE

- You can also tap an existing alarm to edit it.

## Timer

The Timer tab can alert you with an audible signal when a set amount of time has passed.

- 1 Tap  >  >  > **Timer** tab.
- 2 Set the desired time on the timer.
- 3 Tap **Start** to start the timer.
- 4 Tap **Stop** to stop the timer.

## World clock

The World clock tab allows you to easily check the current time in other cities around the world.

- 1 Tap  >  >  > **World clock** tab.

2 Tap  $+$  and select the desired city.

## Stopwatch

The Stopwatch tab allows you to use your phone as a stopwatch.

1 Tap  $\circ$  >  $\odot$  >  > **Stopwatch** tab.

2 Tap **Start** to initiate the stopwatch.

- Tap **Lap** to record lap times.

3 Tap **Stop** to stop stopwatch.

## Calculator

The Calculator app allows you to perform mathematical calculations using a standard or scientific calculator.

1 Tap  $\circ$  >  $\odot$  > .

2 Tap the number buttons to enter numbers.

3 For simple calculations, tap the function you want to perform (+, −, x or ÷) followed by =.

### NOTE

- For more complex calculations, tap .

## Calendar

The Calendar app allows you to track your schedule of events.







1 Tap  $\circ$  >  $\odot$  > .

2 Tap the date you want to add an event to. Then tap  $+$ .

## Voice Recorder

The Voice Recorder app records audible files for you to use in a variety of ways.

### Recording a sound or voice



- 1 Tap  >  > .
- 2 Tap  to begin recording.
- 3 Tap  to end the recording.
- 4 Tap  to listen to the recording.

#### NOTE

- Tap  to access your recordings. You can listen to your saved recordings.

## Voice Search

Use this application to search webpages using voice.



- 1 Tap  >  > **Google** folder > .
- 2 Say a keyword or phrase when **Speak now** appears on the screen. Select one of the suggested keywords that appear.

#### NOTE

- This application may not be available depending on the region or service provider.

## Downloads

Use this application to see what files have been downloaded through the applications.



- Tap  >  > .

## NOTE

- This application may not be available depending on the region or service provider.

## FM Radio

Your phone has a built-in FM radio so you can tune in to your favorite stations and listen on the go.

- Tap  >  > .



**TIP!** You must plug in your earphones in order to use them as an antenna.

## NOTE

- This application may not be available depending on the region or service provider.

## LG Health

The LG Health helps you manage your health and maintain good exercise habits by tracking logs and competing with people.

- 1 Tap  >  > .
- 2 Read and agree to the terms and conditions.
- 3 On the Profile and goal page, enter your profile information and tap Save.
- 4 Use the options below to begin tracking activity.

## NOTE

- This feature is provided for user convenience. Please use for reference only.



# Web Browser

## Internet

The internet gives you a fast, full-color world of games, music, news, sports, entertainment, and much more, right on your mobile phone.





### NOTE

- Additional charges apply when connecting to these services and downloading content. Check data charges with your network provider.

- Tap  >  > .

## Using the Web toolbar

Scroll towards the top of the webpage to access the browser toolbar.

	Tap to go back one page.
	Tap to go forward one page.
	Tap to go to the Home page.
	Tap to open a new window.
	Tap to access your bookmarks.

## Viewing webpages

Tap the address field, enter the web address and tap **Go** on the keyboard.

## Opening a page

To go to a new page, tap  > .

To go to another webpage, tap , scroll up or down, and tap the page to select it.

## Searching the web by voice

Tap the address field and then tap . When prompted, say a keyword and select one of the suggested keywords that appear.

### NOTE

- This feature may not be available depending on the region or service provider.

## Bookmarks

To bookmark the current webpage, tap  > **Add to bookmarks** > **OK**.



To open a bookmarked webpage, tap  and select the desired bookmark.

## History

Tap  > **History** tab to open a list of recently visited webpages. To clear all of your history, tap  > **Yes**.

## Chrome

Use Chrome to search for information and browse webpages.

- Tap  >  > .

### NOTE

- This application may not be available depending on your region and service provider.

## Viewing webpages

Tap the address field, and then enter a web address or search criteria.

## Opening a page

To open a new page, tap  > **New tab**.

To go to another webpage, tap  and tap the page to select it.



# Settings

The Settings application contains most of the tools for customizing and configuring your phone. All of the settings in the Settings application are described in this section.

## To open the Settings application

- Tap  > touch and hold  > **System settings**.
- OR -
- Tap  >  > .

## Networks

### < WIRELESS NETWORKS >

#### Wi-Fi

Turns on Wi-Fi to connect to available Wi-Fi networks.

#### Bluetooth

Turns the Bluetooth wireless feature on or off to use Bluetooth.

#### Mobile data

Displays the data usage and mobile data usage limit.

#### Call

This menu allows you to configure various call settings.

- **Voicemail** – Allows you to select your carrier's voicemail service.
- **Fixed dialing numbers** – Allows you to manage and compile a list of numbers that can be called from your phone. You need your PIN2, which is available from your operator. If activated, only numbers in the fixed dial list can be called from your phone.
- **Incoming voice call pop-up** – Displays a pop-up for an incoming call when an app is in use.
- **Call reject** – Allows you to set the call decline function.

- **Decline with message** – When you want to decline a call, you can send a quick message using this function. This is useful if you need to decline a call during a meeting.
- **Call forwarding** – Allows you to choose when to forward calls.
- **Auto answer** – Sets the time before a connected hands-free device automatically answers an incoming call.
- **Connection vibration** – Vibrates your phone when the other party answers the call.
- **Noise suppression** – Suppresses background noise on your device during a call.
- **Voice clarity** – Enhances voice quality in noisy environments so you can hear more clearly.
- **Save unknown numbers** – Allows you to add unknown numbers to contacts after a call.
- **Power key ends call** – Allows you to use the Power key to end calls.
- **Answer an incoming call** – Checkmark to enable you to bring the device to your ear to automatically answer the incoming call.
- **Silence incoming calls** – Checkmark to allow you to flip the device to silence incoming calls.
- **Call barring** – Locks incoming, outgoing or international calls.
- **Call duration** – Allows you to view the call duration for various types of calls.
- **Additional settings** – Allows you to change the following settings.

## < CONNECTIVITY >

### Share & connect

- **Android Beam** – When this feature is turned on, you can transfer app content to another NFC-capable device by holding the devices close together. Just bring the device together (typically back to back) and then tap your screen. The app determines what gets beamed.
- **SmartShare Beam** – Allows you to receive multimedia content via LG phones and tablets.
- **Media server** – Share media content with nearby DLNA-compatible devices.
- **Miracast** – Allows you to wirelessly mirror the phone screen and sound onto a Miracast dongle or TV.
- **LG Bridge** – Allows you to connect to a computer to manage your phone.

## Tethering

- **USB tethering** – Allows you to share the internet connection with your computer via a USB cable.
- **Wi-Fi hotspot** – Allows you to create a hotspot and share your connection. Please consult "**Sharing your phone's data connection**" for more information.
- **Bluetooth tethering** – Allows you to connect to other devices via Bluetooth.
- **Help** – Displays Help information about USB tethering, Wi-Fi hotspot, and Bluetooth tethering.

## More

- **Airplane mode** – Airplane Mode (flight mode) allows you to use many of your phone's features, such as games, and music, when you are in an area where making or receiving calls or data use is prohibited. When you set your phone to Airplane Mode, it cannot send or receive any calls or access online data.
- **Mobile networks** – This menu allows you to configure various mobile network settings.
- **VPN** – From your phone, you can add, set up, and manage virtual private networks (VPNs) that allow you to connect and access resources inside a secured local network, such as your corporate network.

## Sound & notification

### < BASIC >

#### Sound profile

Allows you to set your phone's sound profile. Choose from **Sound**, **Vibrate only**.

### < SOUND >

#### Volume

Adjust the phone's volume settings to suit your needs and environment.

#### Ringtone

Allows you to set the ringtones for calls. You can also add a ringtone by tapping  in the upper-right corner of the screen.

#### Ring ID

Allows you to compose ringtones based on phone number of incoming call.

### < VIBRATIONS >

#### Vibration strength

Allows you to set the vibration strength for calls, notifications and touch feedback.

#### Sound with vibration

Checkmark to set the phone to vibrate in addition to the ringtone when you receive calls.

#### Vibration type

Allows you to choose the type of vibration.

### < NOTIFICATIONS >

#### Interruptions

Allows you to set a schedule when to prevent interruptions from notifications. You can set to allow certain features to interrupt when Priority only is set.

#### Lock screen

Allows you to choose if you want to show or hide notifications on the lock screen.

## Apps

Allows you to prevent apps from displaying notifications or set apps to show notifications with priority when Do not disturb is set to Priority only.

## Notification LED

Tap the switch to toggle it On or Off. On activates the LED light for the notifications you select, in the color you set for each.

### < ADVANCED SETTINGS >

#### More

- **Notification sound** – Allows you to set the notification sound. You can also add a notification sound by tapping  in the upper-right corner of the screen.
- **Vibrate on tap** – Checkmark to vibrate when tapping the Home touch buttons and during other UI interactions.
- **Sound effects** – Tap to set the dial pad touch tones, touch sounds and screen lock sound.
- **Message/call voice notifications** – Tap the **Message/call voice notifications** switch to toggle it On or Off. On allows your device to read out incoming calls and message events automatically.

## Display

### < HOME & LOCK >

#### Home screen

- **Select Home** – Set **Home** or **EasyHome** as the default home.
- **Smart Bulletin** – Tap the **Smart Bulletin** switch to toggle it On or Off. Activating this feature adds an additional Home screen showing customized information.
- **Theme** – Sets the screen theme for your device. You can download new themes from **LG SmartWorld**.
- **Wallpaper** – Sets the wallpaper to use on your Home screen.
- **Screen swipe effect** – Choose the desired type of effect to display when you swipe from one Home screen canvas to the next.

- **Allow Home screen looping** – Displays the first screen after the last screen when scrolling the Home screen.
- **Help** – Displays help information for the Home screen.

## Lock screen

- **Select screen lock** – Set a screen lock type to secure your phone. Opens a set of screens that guide you through drawing a screen unlock pattern. If you enabled a Pattern lock type when you turn on your phone or wake up the screen, you are asked to draw your unlock pattern to unlock the screen.
- **Smart Lock** – Sets to keep your phone unlocked with trusted device or a place.
- **Screen swipe effect** – Sets the screen swipe effect options.

### NOTE

- This setting name may be Pattern effect if the Screen lock is set to Pattern.
- **Wallpaper** – Allows you to set your Lock screen wallpaper.
- **Shortcuts** – Allows you to choose the shortcuts available on the lock screen.
- **Weather animation** – Checkmark to show weather animation on the lock screen for the current location.
- **Contact info for lost phone** – Allows you to display the owner information on the lock screen in case the phone is lost.
- **Lock timer** – Sets the amount of time before the screen automatically locks after the screen has timed out.
- **Power button instantly locks** – Checkmark to instantly lock the screen when the Power/Lock Button is pressed. This setting overrides the Security lock timer setting.

## Home touch buttons

Set the Home touch buttons displayed at the bottom of all screens. Set which keys are displayed, their position on the bar and what they look like.

## < FONT >

### Font type

Select the desired font type.

### Font size

Select the desired font size.

## < OTHER SCREEN SETTINGS >

### Brightness

Adjust the screen brightness by using the slider.

### Auto-rotate screen

Set to switch orientation automatically when you rotate the phone.

### Screen timeout

Set the time delay before the screen automatically turns off.

### More

- **Daydream** - Select the screen saver to display when the phone is sleeping while docked and/or charging.
- **Motion sensor calibration** – Allows you to improve the accuracy of the tilt and speed of the sensor.

## General

## < PERSONAL >

### Language & input

Select the language for the text on your phone and for configuring the on-screen keyboard, including words that you've added to its dictionary.

- **Language** – Choose a language to use on your phone.
- **Default** – Allows you to select the default keyboard type.
- **LG Keyboard** – Tap the Settings icon to change the LG Keyboard settings.
- **Google voice typing** – Checkmark to select Google voice typing to enter data. Tap the Settings icon to change the Google voice settings.

- **Voice Search** – Tap to configure the Voice Search settings.
- **Text-to-speech output** – Tap to set the preferred engine or general settings for text-to-speech output.
- **Pointer speed** – Adjust the pointer speed.

## Location

Turn on location service, your phone determines your approximate location using Wi-Fi and mobile networks. When you select this option, you're asked whether you consent to allowing Google to use your location when providing these services.

- **Mode** – Sets the how your current location information is determined.
- **Camera** – Checkmark to tag photos or videos with their locations.
- **Google Location Reporting** – Allows you to choose your location information settings as accessed by Google and its products.

## Accounts & sync

Use the Accounts & sync settings menu to add, remove, and manage your Google and other supported accounts. You also use these settings to control how and whether all applications send, receive, and sync data on their own schedules and whether all applications can synchronize user data automatically.

Gmail™, Calendar, and other applications may also have their own settings to control how they synchronize data; see the sections on those applications for details. Tap **Add account** to add new account.

## Cloud

Allows you to add a cloud account to quickly and easily use a cloud service.

## Users

Checkmark to add users when phone locked.

Add user to share the phone with other people. Each user can have their own apps and content in their own space. Anyone using the phone can change settings like Wi-Fi and accept app updates that will affect everyone. Initial setup is required for new users to use phone.



## Accessibility

Use the Accessibility settings to configure accessibility plug-ins you have installed on your phone.

### • Vision

- **TalkBack** – Allows you to set up the TalkBack function which assists people with impaired vision by providing verbal feedback.
- **Message/call voice notifications** – Tap  to toggle it On or Off. On allows you to hear automatic spoken alerts for incoming calls and messages.
- **Screen shade** – Checkmark to set the screen to a darker contrast.
- **Font size** – Sets the font size.
- **Touch zoom** – Allows you to zoom in and out by triple-tapping the screen.
- **Screen colour inversion** – Checkmark to invert the colours of the screen and content.
- **Screen colour adjustment** – Allows you to invert the colours of screen and content.
- **Screen colour filter** – Allows you to change the colours of screen and content.
- **Power key ends call** – Checkmark so that you can end voice calls by pressing the Power/Lock Key.

### • Hearing

- **Captions** – Allows you to customize caption settings for those with hearing impairments.
- **Notification LED** – Allows you to activate the LED light for incoming calls and notifications.
- **Flash alerts** – Checkmark to set the flash to blink for incoming calls and notifications.
- **Turn off all sounds** – Checkmark to turn off all device sounds.
- **Audio type** – Sets the audio type.
- **Sound balance** – Sets the audio route. Move the slider on the slide bar to set it.

- **Motor & cognition**
  - **Touch feedback time** – Sets the touch feedback time.
  - **Touch assistant** – Show a touch board with easy access to common actions.
  - **Screen timeout** – Sets the amount of time before the backlight turns off automatically.
  - **Touch control areas** – Allows you to select an area of the screen to limit touch activation to just that area of the screen.
- **Accessibility features shortcut**  
Allow you to access selected features quickly when triple-tapping the Home button.
- **Auto-rotate screen**  
Checkmark to allow the phone to rotate the screen depending on the physical phone orientation (portrait or landscape)..
- **Switch Access**  
Allows you to interact with your device using one or more switches that work like keyboard keys. This menu can be helpful for users with mobility limitations that prevent them from interacting directly with the your device.

## Shortcut key

Get quick access to apps by pressing and holding the **Volume Keys** when the screen is off or locked.

## < PRIVACY >

### Security

Use the Security menu to configure how to help secure your phone and its data.

- **Content lock** – Select lock types to lock files in Gallery. Choose from **Password** or **Pattern**.
- **Encrypt phone** – Allows you to encrypt data on the phone for security. You will be required to enter a PIN or password to decrypt your phone each time you power it on.
- **Encrypt SD card storage** – Encrypt SD card storage and keep data unavailable for other devices.

- **Set up SIM card lock** – Sets the PIN to lock your SIM card and allows you to change the PIN.
- **Password typing visible** – Checkmark to briefly show each character of passwords as you enter them so that you can see what you enter.
- **Phone administrators** – View or deactivate phone administrators.
- **Unknown sources** – Allow installation of non-Play Store applications.
- **Verify apps** – Disallow or warn before installation of apps that may cause harm.
- **Storage type** – Hardware-backed.
- **Certificate management**
  - **Trusted credentials** – Checkmark to allow applications to access your phone's encrypted store of secure certificates and related passwords and other credentials. You use credential storage to establish some types of VPN and Wi-Fi connections. If you have not set a password for the secure credential storage, this setting is dimmed.
  - **Install from storage** – Tap to install a secure certificate.
  - **Clear credentials** – Deletes all secure certificates and related credentials and erases the secure storage's own password.
- **Trust agents** – Select apps to use without unlocking screen.
- **Screen pin** – You can enable your device to only show a certain app's screen using screen pin.
- **App usage access** – Allows you to view usage information of apps on your phone.

## < SMART FUNCTIONS >

### Smart settings

Allows you to turn on/off, open or change something such as Wi-Fi, Music, Sound profile according to where you are or what you do.

### QuickCircle case

This menu allows you to select apps to be used directly on the cover in small view using QuickCircle. Keep in mind that turning on these QuickCircle case settings may result in irregular device behavior.

## Dual window

Allows you to configure the Dual Window feature.

- **Split view** – Checkmark to allow you to tap a link on the full screen or attachments from emails to open Dual window.
- **Help** – Display tips for using Dual window.

## < PHONE MANAGEMENT >

### Date & time

Set your preferences for how the date and time is displayed.

### Storage

You can monitor the used and available internal memory in the device.

### Battery & power saving

- **Battery usage** – View battery usage.
- **Battery percentage on status bar** – Checkmark to display the battery level percentage on the Status Bar next to the Battery icon.
- **Battery saver** – Tap the Battery Saver switch to toggle it on or off. Sets the battery charge percent level that automatically turns on Battery Saver. Chooser from **Immediately**, **5% battery**, and **15% battery**.
- **Help** – Displays battery saving items information.

### Smart cleaning

Allows you to manage unused apps and data.

### Apps

Allows you to view details about the apps installed on your phone, manage their data, and force them to stop.

### Default message app

This menu allows you to choose what messaging app to use as your default messaging app.

## Backup & reset

Change the settings for managing your settings and data.

- **LG Backup** – Backs up all information on the device and restores it in the event of data loss or replacement.
- **Backup my data** – Back up app data, Wi-Fi passwords, and other settings to Google servers.
- **Backup account** – Displays the account that is currently being used to back up information.
- **Automatic restore** – When reinstalling an app, restore backed up settings and data.
- **Factory data reset** – Reset your settings to the factory default values and delete all your data. If you reset the phone this way, you are prompted to re-enter the same information as when you first started Android.

## About phone

View legal information, check phone status and software versions, and perform a software update.

# Phone software update

## Phone software update

### LG Mobile phone software update from the Internet

For more information about using this function, please visit <http://www.lg.com/common/index.jsp> → select your country and language.

This feature allows you to conveniently update the firmware on your phone to a newer version from the Internet without needing to visit a service center. This feature will only be available if and when LG makes a newer firmware version available for your device. Because the mobile phone firmware update requires the user's full attention for the duration of the update process, please make sure you check all instructions and notes that appear at each step before proceeding. Please note that removing the USB data cable during the upgrade may seriously damage your mobile phone.

#### NOTE

- LG reserves the right to make firmware updates available only for selected models at its own discretion and does not guarantee the availability of the newer version of the firmware for all handset models.

### LG Mobile Phone software update via Over-the-Air (OTA)

This feature allows you to conveniently update your phone's software to a newer version via OTA, without connecting using a USB data cable. This feature will only be available if and when LG makes a newer firmware version available for your device.

You should first check the software version on your mobile phone: **Settings > General tab > About phone > Update Center > Software Update > Check now for update.**

**NOTE**

- Your personal data from internal phone storage—including information about your Google account and any other accounts, your system/application data and settings, any downloaded applications and your DRM licence—might be lost in the process of updating your phone's software. Therefore, LG recommends that you backup your personal data before updating your phone's software. LG does not take responsibility for any loss of personal data.
- This feature depends on your network service provider, region and country.

# About this user guide

## About this user guide

- Before using your device, please carefully read this guide. This ensures that you use your phone safely and correctly.
- Some of the images and screenshots provided in this guide may appear differently on your phone.
- Your content may differ from the final product or from software supplied by service providers or carriers. This content is subject to change without prior notice. For the latest version of this guide, please visit the LG website at [www.lg.com](http://www.lg.com).
- Your phone's applications and their functions may vary by country, region or hardware specifications. LG cannot be held liable for any performance issues resulting from the use of applications developed by providers other than LG.
- LG cannot be held liable for performance or incompatibility issues resulting from edited registry settings or modified operating system software. Any attempt to customize your operating system may cause the device or its applications to work incorrectly.
- Software, audio, wallpaper, images, and other media supplied with your device are licensed for limited use. If you extract and use these materials for commercial or other purposes, you may be infringing copyright laws. As a user, you are fully and entirely responsible for the illegal use of media.
- Additional charges may apply for data services, such as messaging, uploading, downloading, auto-syncing and location services. To avoid additional charges, select a data plan suitable to your needs. Contact your service provider to obtain additional details.



## Trademarks

- LG and the LG logo are registered trademarks of LG Electronics.
- All other trademarks and copyrights are the property of their respective owners.

## DivX HD

This DivX Certified<sup>®</sup> device has passed rigorous testing to ensure it plays DivX<sup>®</sup> video. To play purchased DivX movies, first register your device at [vod.divx.com](http://vod.divx.com). Find your registration code in the DivX VOD section of your device setup menu.

**DivX Certified<sup>®</sup> to play DivX<sup>®</sup> video up to HD 720p, including premium content.**  
DivX<sup>®</sup>, DivX Certified<sup>®</sup> and associated logos are trademarks of DivX, LLC and are used under license.

## Dolby Digital Plus DOLBY. DIGITAL PLUS

Manufactured under license from Dolby Laboratories. Dolby, Dolby Digital Plus, and the double-D symbol are trademarks of Dolby Laboratories.

# Accessories

These accessories are available for use with the your phone. **(Items described below may be optional.)**

- Travel adaptor
- Quick Start Guide
- Stereo headset
- USB cable
- Battery

## NOTE

- Always use genuine LG accessories. The supplied items are designed only for this device and may not be compatible with other devices.
- The items supplied with the device and any available accessories may vary depending on the region or service provider.

# Troubleshooting

This chapter lists some problems you might encounter when using your phone. Some problems require you to call your service provider, but most are easy to fix yourself.



Message	Possible causes	Possible corrective measures
SIM or USIM card error	There is no SIM or USIM card in the phone or it is inserted incorrectly.	Make sure that the SIM or USIM card is correctly inserted.
No network connection/ Dropped network	Signal is weak or you are outside the carrier network.	Move toward a window or into an open area. Check the network operator coverage map.
	Operator applied new services.	Check whether the SIM or USIM card is more than 6~12 months old. If so, change your SIM or USIM card at your network provider's nearest branch. Contact your service provider.
Codes do not match	To change a security code, must need to confirm the new code by re-entering it.	If you forget the code, contact your service provider.
	The two codes you entered do not match.	

<b>Message</b>	<b>Possible causes</b>	<b>Possible corrective measures</b>
No applications can be set	Not supported by service provider or registration required.	Contact your service provider.
Calls not available	Dialing error	New network not authorized.
	New SIM or USIM card inserted.	Check for new restrictions.
	Pre-paid charge limit reached.	Contact service provider or reset limit with PIN2.
Phone cannot be turned on	On/Off key pressed too briefly.	Press the On/Off key for at least two seconds.
	Battery is not charged.	Charge battery. Check the charging indicator on the display.
Charging error	Battery is not charged.	Charge battery.
	Outside temperature is too hot or cold.	Make sure phone is charging at a normal temperature.
	Contact problem	Check the charger and its connection to the phone.
	No voltage	Plug the charger into a different outlet.
	Charger defective	Replace the charger.
	Wrong charger	Use only original LG accessories.

<b>Message</b>	<b>Possible causes</b>	<b>Possible corrective measures</b>
Number not allowed.	The Fixed dialling number function is on.	Check the Settings menu and turn the function off.
Impossible to receive/send SMS & photos	Memory full	Delete some messages from your phone.
Files do not open	Unsupported file format	Check the supported file formats.
The screen does not turn on when I receive a call.	Proximity sensor problem	If you use a protection tape or case, make sure it has not covered the area around the proximity sensor. Make sure that the area around the proximity sensor is clean.
No sound	Vibration mode	Check the settings status in the sound menu to make sure you are not in vibration or silent mode.
Hangs up or freezes	Intermittent software problem	Try to perform a software update through the website.

## FAQ



Category	Question	Answer
Bluetooth Devices	What functions are available via Bluetooth?	You can connect a Bluetooth audio device, such as a Stereo/Mono headset or car kit.
Contacts Backup	How can I back up Contacts?	Contacts data can be synchronized between your phone and your Google account.
Synchronization	Is it possible to set up one-way sync with Gmail?	Only two-way synchronization is available.
Synchronization	Is it possible to synchronize all email folders?	The Inbox is automatically synchronized. You can view other folders by tapping  and selecting <b>Folders</b> to choose a folder.
Gmail Log-In	Do I have to log into Gmail whenever I want to access Gmail?	Once you have logged into Gmail, there is no need to log into Gmail again.
Google Account	Is it possible to filter emails?	No, the phone does not support email filtering.
Email	What happens when I execute another application while writing an email?	Your email is automatically saved as a draft.
Ringtone	Is there a file size limit for using MP3 files as ringtones?	There is no file size limit.

Category	Question	Answer
Message Time	My phone does not display the time of receipt for messages older than 24 hrs. How can I view the time?	Open the conversation and touch and hold the desired message. Then tap <b>Details</b> .
Navigation	Is it possible to install another navigation application on my phone?	Any application that is available at Play Store™ and is compatible with the hardware can be installed and used.
Synchronisation	Is it possible to synchronize my contacts from all my email accounts?	Only Gmail and MS Exchange server (company email server) contacts can be synchronized.
Wait and Pause	Is it possible to save a contact with Wait and Pause in the numbers?	If you transferred a contact using the Wait & Pause functions saved into the number, you cannot use those features. You must save each number again. How to save with Wait and Pause: 1. Tap  >  . 2. Dial the number, then tap  . 3. Tap <b>Add 2-sec pause</b> or <b>Add wait</b> .
Security	What are the phone's security functions?	You can set the phone to require an Unlock Pattern to be entered before the phone can be accessed or used.

Category	Question	Answer
Unlock Pattern	How do I create the Unlock Pattern?	<ol style="list-style-type: none"> <li>1. From the Home screen, touch and hold .</li> <li>2. Tap <b>System settings</b> &gt; <b>Display</b> tab &gt; <b>Lock screen</b>.</li> <li>3. Tap <b>Select screen lock</b> &gt; <b>Pattern</b>. The first time you do this, a short tutorial about creating an Unlock Pattern appears.</li> <li>4. Set up your pattern by drawing it then drawing it a second time for confirmation.</li> </ol> <p>Precautions to take when using the pattern lock.</p> <p>It is very important to remember the unlock pattern you set. You can no longer access your phone if you use an incorrect pattern five times. You have five chances to enter your unlock pattern, PIN or password. If you have used all 5 opportunities, you can try again after 30 seconds. (Or, if you preset the backup PIN, you can use the backup PIN code to unlock the pattern.)</p>



Category	Question	Answer
Unlock Pattern	What should I do if I forget the unlock pattern and I did not create my Google account on the phone?	<p>If you forgot your pattern: If you logged into your Google account on the phone but failed to enter the correct pattern 5 times, tap the <b>Forgot pattern</b> button. You are then required to log in with your Google account to unlock your phone. If you have not created a Google account on the phone or you have forgotten it, you must perform a hard reset.</p> <p>Caution: If you perform a factory reset, all user applications and user data are deleted. Please remember to back up any important data before performing a factory reset.</p>
Memory	Will I know when my memory is full?	Yes, you will receive a notification.
Language Support	Is it possible to change my phone's language?	<p>The phone has multilingual capabilities. To change the language:</p> <ol style="list-style-type: none"> <li>1. From the Home screen, touch and hold  and tap <b>System settings</b>.</li> <li>2. Tap <b>General</b> tab &gt; <b>Language &amp; input</b> &gt; <b>Language</b>.</li> <li>3. Tap the desired language.</li> </ol>
VPN	How do I set up a VPN?	VPN access configuration is different for each company. To configure VPN access on your phone, you must obtain the details from your company's network administrator.

Category	Question	Answer
Screen time out	My screen turns off after only 15 seconds. How can I change the amount of time for the backlight to turn off?	<ol style="list-style-type: none"> <li>1. From the Home screen, touch and hold .</li> <li>2. Tap <b>System settings</b> &gt; <b>Display</b> tab.</li> <li>3. Tap <b>Screen timeout</b>.</li> <li>4. Tap the preferred screen backlight timeout time.</li> </ol>
Wi-Fi & mobile network	When the Wi-Fi and mobile networks are both available, which service does my phone use?	<p>When using data, your phone may default to the Wi-Fi connection (if Wi-Fi connectivity on your phone is set to On). However, there is no notification when your phone switches from one to the other.</p> <p>To know which data connection is being used, view the mobile network or Wi-Fi icon at the top of your screen.</p>
Home screen	Is it possible to remove an application from the Home screen?	Yes. Just touch and hold the icon until the trash can icon appears at the top and center of the screen. Then, without lifting your finger, drag the icon to the trash can.
Application	I downloaded an application and it causes a lot of errors. How do I remove it?	<ol style="list-style-type: none"> <li>1. From the Home screen, touch and hold .</li> <li>2. Tap <b>System settings</b> &gt; <b>General</b> tab &gt; <b>Apps</b> &gt; <b>DOWNLOADED</b>.</li> <li>3. Tap the application, then tap <b>Uninstall</b>.</li> </ol>
Charger	Is it possible to charge my phone using a USB data cable without installing the necessary USB driver?	Yes, the phone is charged through the USB cable regardless of whether the necessary drivers are installed.

Category	Question	Answer
Alarm	Can I use music files for my alarm?	<p>Yes. After saving a music file as a ringtone, you can use it as an alarm.</p> <ol style="list-style-type: none"> <li>1. Touch and hold a song in a library list. In the menu that opens, tap <b>Set as ringtone</b> &gt; <b>Phone ringtone</b> or <b>Contact ringtone</b>.</li> <li>2. On the Alarm Clock Setting screen, select the song as a ringtone.</li> </ol>
Alarm	Will my alarm be audible or will it go off if the phone is turned off?	No, this is not supported.
Alarm	If my ringer volume is set to vibrate, will I hear my alarm?	Your alarm is programmed to be audible even in these scenarios.
Hard Reset (Factory Reset)	How can I perform a factory reset if I cannot access the phone's Settings menu?	If your phone does not restore to its original condition, use a hard reset (factory reset) to initialize it.

