



APPENDIX G
: USER'S MANUAL

2nd Draft



HP LD4201, LD4210 and LD4710 Digital Signage Displays

User Guide

2nd Draft

© 2010 Hewlett-Packard Development Company, L.P. The information contained herein is subject to change without notice.

Microsoft®, Windows®, Windows® XP, and Windows Vista® are either trademarks or registered trademarks of Microsoft Corporation in the United States and/or other countries.

The only warranties for HP products and services are set forth in the express warranty statements accompanying such products and services. Nothing herein should be construed as constituting an additional warranty. HP shall not be liable for technical or editorial errors or omissions contained herein.

This document contains proprietary information that is protected by copyright. No part of this document may be photocopied, reproduced, or translated to another language without the prior written consent of Hewlett-Packard Company.

First Edition (November 2010)

Document Part Number: 626995-001

2nd Draft

About this guide

This guide provides information on setting up the display, installing drivers, using the On-Screen Display menu, troubleshooting, and technical specifications.

-
- ⚠ **WARNING!** Text set off in this manner indicates that failure to follow directions could result in bodily harm or loss of life.
 - ⚠ **CAUTION:** Text set off in this manner indicates that failure to follow directions could result in damage to equipment or loss of information.
 - 📄 **NOTE:** Text set off in this manner provides important supplemental information.
-

2nd Draft

2nd Draft

Table of contents

1 Product features	1
HP Digital Signage models	1
Accessories	2
Optional accessories	2
2 Safety and maintenance guidelines	3
Important safety information	3
Maintenance guidelines	4
Cleaning the display	5
Shipping the display	5
3 Setting up the display	7
Installing the stand (sold separately)	7
Connecting the speakers (sold separately)	9
Rotating to the portrait position	11
Using the remote control	12
Inserting the batteries (sold separately)	12
Identifying remote control buttons	13
Identifying display components	15
VESA mounting support and security slot	17
Connecting to external devices	18
Connecting RGB	20
Connecting DisplayPort (480p/576p/720p/1080i/1080p)	20
Connecting HDMI (480p/576p/720p/1080i/1080p)	21
Connecting LAN (HP LD4210 and HP LD4710 only)	22
Connecting daisy chain displays	24
4 Operating the display	27
Software and utilities	27
The information file	27
The image color matching file	27
Installing the .INF and .ICM files	28
Installing from the CD	28

2nd Draft

Downloading from the Web	28
Using the auto-adjustment function (RGB INPUT source only)	29
Using the On-Screen Display menu	30
Using the remote control to adjust the OSD	30
OSD menu selections	31
Selecting an Aspect Ratio	37
Adjusting the timer function	37
Clock	38
On Time and Off Time	38
Sleep Timer	38
Auto Off	39
Power On Delay	39
Using Key Lock	39
Using ISM Method	40
Using Tile Mode	40
5 Using the HP Media Sign Player	41
Using Photo List	43
Using Music List	44
Using Movie List	45
6 Installing HP Network Sign Manager	47
Signage display	48
System requirements	49
Features	50
Environment setup	51
Connecting a display via LAN or WAN	51
Setting IP address to the network display	51
Connecting a display via RS-232-C serial port	52
HP Network Sign Manager installation	53
Installing HP Network Sign Manager	53
Removing HP Network Sign Manager	53
Quick overview	54
Home screen	54
Toolbar	54
Control tab	55
Log-in	56
Connection settings	57
Ethernet communication settings	57
Serial communication settings	57
Display registration	58
Registering a networked display	58
Registering a display via serial communication	59

2nd Draft

Display and group management	60
Making a group	60
Adding a display to group	60
Viewing group information	60
Deleting a group	61
Deleting a group	61
Deleting a display from a group	61
Deleting a display	61
Adding a tag to a display	61
Display configuration	62
Viewing information	62
Display	62
IP Configuration	62
Status	62
Diagnosis	63
Controlling a display	63
Power	63
Select Input	63
Volume	63
Screen Mute	64
Volume Mute	64
OSD Select	64
Configuring audio/video settings	64
Picture Mode	64
Backlight	64
Contrast	64
Brightness	64
Color	64
Sharpness	65
Color Temperature (White Balance)	65
Auto Config	65
Sound Mode	65
Auto Volume	65
Balance	65
Speaker	65
Setting screen options	65
Aspect Ratio	65
ISM Method	65
Power indicator	66
DDC-CI	66
DFC	66
DPM Select	66
Remote/Key Lock	66
Sleep Timer	66

2nd Draft

Auto Off	66
Power On Delay	66
Energy Saving	67
Factory Reset	67
Scheduling	67
Clock	67
Time Schedule Setting	67
On/Off Time Schedule Info	67
Saving and loading display configuration	68
Saving display configuration	68
Loading display configuration	68
Tile Mode	69
Creating a tile mode	69
Modifying a tile mode	69
Schedule and Playback contents (USB)	70
Scheduling the playback of files	70
USB Schedule	70
Saving files in the USB device	71
Scheduling the playback of files	71
USB Export	72
Exporting to USB	72
Saving files and the playback schedules in the USB device	72
Toolbar	74
Search	74
Setting	74
Ethernet Network	74
RS-232C Serial Communication	74
Connect	74
Refresh	75
Message	75
Alarm	76
Security	76
Help	77
Log history	78
Log data	78
Log file name and location	78
Upgrade	79
Appendix A Troubleshooting	81
Solving common problems	81
Using the Web	83
Preparing to call technical support	83

2nd Draft

Appendix B Technical specifications	85
HP Digital Signage Display	85
HP LD4201 and HP LD4210 dimensions	88
HP LD4710 dimensions	89
Recognizing preset display resolutions	90
Preset display modes	90
DTV mode	90
Power indicator	91
Appendix C Command reference	93
Connecting the cable	93
RS-232-C configurations	93
Communication parameter	94
Command reference list	94
Transmission/Receiving Protocol	96
01. Power (Command : a)	97
02. Input Select (Command : b) (Main Picture Input)	97
03. Aspect Ratio (Command : c) (Main picture format)	98
04. Screen Mute (Command : d)	99
05. Volume Mute (Command : e)	99
06. Volume Control (Command : f)	100
07. Contrast (Command : g)	101
08. Brightness (Command : h)	101
09. Color (Command : i) (Video Timing only)	102
10. Tint (Command : j) (Video Timing only)	103
11. Sharpness (Command : k) (Video Timing only)	104
12. OSD Select (Command : l)	105
13. Remote Lock /Key Lock (Command : m)	106
14. Balance (Command : t)	106
15. Color Temperature (Command : u)	107
16. Abnormal state (Command : z)	107
17. ISM mode (Command : j p)	108
18. Auto Configure (Command : j u)	108
19. Key (Command : m c)	109
20. Tile Mode (Command : d d)	109
21. Tile H Position (Command : d e)	110
22. Tile V Position (Command : d f)	110
23. Tile H Size (Command : d g)	110
24. Tile V Size (Command : d h)	111
25. Tile ID Set (Command : d i)	112
26. Natural Mode (In Tile Mode) (Command : d j)	112
27. Picture Mode (Command : d x)	113
28. Sound Mode (Command : d y)	113

2nd Draft

29. Fan Fault check (Command : d w)	114
30. Elapsed time return (Command : d l)	114
31. Temperature value (Command : d n)	115
32. Lamp fault Check (Command : d p)	115
33. Auto volume (Command : d u)	116
34. Speaker (Command : d v)	116
35. Time (Command : f a)	117
36. On Timer (On/Off Timer) Time (Command : f d)	117
37. Off Timer (On/Off Timer) Time (Command : f e)	118
38. Scheduling Input select (Command : f u) (Main Picture Input)	120
39. Sleep Time (Command : f f)	121
40. Auto Sleep (Command : f g)	121
41. Power On Delay (Command : f h)	122
42. Language (Command : f i)	122
43. DPM Select (Command : f j)	123
44. Reset (Command : f k)	123
45. Power saving(Command : f l)	124
46. Power Indicator (Command : f o)	124
47. Serial no. Check (Command : f y)	125
48. S/W Version (Command : f z)	125
49. Input Select (Command : x b)	125
IR codes	126
Remote Control IR Code	126
Output waveform	126
Configuration of frame	127
Lead code	127
Repeat code	127
Bit description	127
Frame interval: Tf	127
IR Codes Table	128
Appendix D Agency regulatory notices	131
Federal Communications Commission notice	131
Modifications	131
Cables	131
Declaration of Conformity for products marked with the FCC logo (United States only)	132
Canadian notice	132
Avis Canadien	132
European Union regulatory notice	132
German ergonomics notice	133
Japanese notice	133
Korean notice	133
Power cord set requirements	134

2nd Draft

Japanese power cord requirements	134
Product environmental notices	134
Materials disposal	134
Disposal of waste equipment by users in private households in the European Union	134
Chemical substances	135
HP recycling program	135
Restriction of Hazardous Substances (RoHS)	135
Turkey EEE regulation	136

2nd Draft

1 Product features

HP Digital Signage models

The HP LCD digital signage displays have a wide aspect active matrix thin-film transistor (TFT) panel. The displays features include the following:

- HP LD4201 model, 106.7 cm (42-inch diagonal) widescreen viewable area display with 1920 x 1080 native resolution
- HP LD4210 model, 106.7 cm (42-inch diagonal) widescreen viewable area display with 1920 x 1080 native resolution
- HP LD4710 model, 119.28 cm (47-inch diagonal) widescreen viewable area display with 1920 x 1080 native resolution
- Landscape and portrait wall mounting positions
- Video inputs support DisplayPort In/Out, HDMI In/Out, RGB In/Out, and RS-232-C In/Out signal inputs
- Audio input jack and external speaker ports
- LAN port (HP LD4210 and HP LD4710 only) for remote display control and controlling the HP Media Sign Player
- HP Media Sign Player—Play image, video, and music files from a USB storage device, define play list, timing options, scheduling
- USB port for the HP Media Sign Player
- On-Screen Display (OSD) menu in several languages for ease of setup and screen optimization
- Screen adjustment buttons (Power On/Off, AUTO/SET, OSD Controls, MENU, and SOURCE) on the back of the display
- User controls to adjust Picture, Tile Mode, Timer, Energy Saving, Aspect Ratio, Audio, and additional setup options
- Plug and play capability if supported by the system
- Security cable provision on rear panel to lock down the display and help prevent theft
- Support VESA compliant mounting interface with 600 x 400 mm (23.62 x 15.75 in) hole pattern for the HP LD4201 and HP LD4210 models and 800 x 400 mm (31.50 x 15.75 in) hole pattern for the HP LD4710 model

2nd Draft

Accessories

- Software and documentation CD
- Remote control
- Power cable
- DisplayPort cable
- HDMI cable
- RGB (VGA) cable

Optional accessories

Optional accessories (purchased separately) might vary depending on the model.

- Stand kit
- Speakers kit
- Wall mount kit

2 Safety and maintenance guidelines

Important safety information

A power cord is included with the display. If another cord is used, use only a power source and connection appropriate for this display. For information on the correct power cord set to use with the display, refer to the [Power cord set requirements on page 134](#).

△ **WARNING!** To reduce the risk of electric shock or damage to the equipment:

- Do not disable the power cord grounding feature. The grounding plug is an important safety feature.
- Plug the power cord in a grounded (earthed) outlet that is easily accessible at all times.
- Disconnect power from the product by unplugging the power cord from the electrical outlet.

For your safety, do not place anything on power cords or cables. Arrange them so that no one can accidentally step on or trip over them. Do not pull on a cord or cable. When unplugging from the electrical outlet, grasp the cord by the plug.

To reduce the risk of serious injury, read the *Safety and Comfort Guide*. It describes proper workstation, setup, posture, and health and work habits for computer users, and provides important electrical and mechanical safety information. This guide is located on the Web at www.hp.com/ergo and/or on the documentation CD, if one is included with the display.

△ **CAUTION:** For the protection of the display, as well as the media player/computer, connect all power cords for the media player/computer and its peripheral devices (such as a display, printer, scanner) to some form of surge protection device such as a power strip or Uninterruptible Power Supply (UPS). Not all power strips provide surge protection; the power strips must be specifically labeled as having this ability. Use a power strip whose manufacturer offers a Damage Replacement Policy so you can replace the equipment, if surge protection fails.

Use the appropriate and correctly sized furniture designed to properly support your display.

△ **WARNING!** Displays that are inappropriately situated on dressers, bookcases, shelves, desks, speakers, chests, or carts can fall over and cause personal injury.

Care should be taken to route all cords and cables connected to the display so that they cannot be pulled, grabbed, or tripped over.

2nd Draft

Maintenance guidelines

To enhance the performance and extend the life of the display:

- Do not open the display cabinet or attempt to service this product yourself. Adjust only those controls that are covered in the operating instructions. If the display is not operating properly or has been dropped or damaged, contact an authorized HP dealer, reseller, or service provider.
- Use only a power source and connection appropriate for this display, as indicated on the label/back plate of the display.
- Be sure the total ampere rating of the products connected to the outlet does not exceed the current rating of the electrical outlet, and the total ampere rating of the products connected to the cord does not exceed the rating of the cord. Look on the power label to determine the ampere rating (AMPS or A) for each device.
- Install the display near an outlet that you can easily reach. Disconnect the display by grasping the plug firmly and pulling it from the outlet. Never disconnect the display by pulling the cord.
- Turn the display off when not in use. You can substantially increase the life expectancy of the display by using a screen saver program and turning off the display when not in use.

△ **CAUTION:** [Author note:]Delete this Caution?

Burn-in damage might occur on displays that display the same static image on the screen for a prolonged period of time (12 consecutive hours of non-use). To avoid burn-in image damage on the display screen, you should always activate a screen saver application or turn off the display when it is not in use for a prolonged period of time or cycle between 5 minutes of static information and 10 seconds of a moving image. Image retention is a condition that might occur on all LCD screens. Screen burn-in is not covered under the HP warranty.

- Slots and openings in the cabinet are provided for ventilation. These openings must not be blocked or covered. Never push objects of any kind into cabinet slots or other openings.
- Do not drop the display or place it on an unstable surface.
- Do not allow anything to rest on the power cord. Do not walk on the cord.
- Keep the display in a well-ventilated area, away from excessive light, heat or moisture.
- When removing the display base, you must lay the display face down on a soft area to prevent it from getting scratched, defaced, or broken.

2nd Draft

Cleaning the display

1. Turn off the display and unplug the power cord from the back of the unit.
2. Dust the display by wiping the screen and the cabinet with a soft, clean antistatic cloth.
3. For more difficult cleaning situations, use a 50/50 mix of water and Isopropyl alcohol.

△ **CAUTION:** Spray the cleaner onto a cloth and use the damp cloth to gently wipe the screen surface. Never spray the cleaner directly on the screen surface. It might seep behind the bezel and damage the electronics.

CAUTION: To clean the display screen or cabinet, do not use cleaners that contain any petroleum-based materials such as benzene or thinner or any volatile substance. These chemicals might damage the display.

Shipping the display

Keep the original packing box in a storage area. You might need it later if you move or ship the display.

2nd Draft

3 Setting up the display

To set up the display, ensure that the power is turned off to the display, media player/computer system, and other attached devices, and then follow the instructions below.

Installing the stand (sold separately)

1. [Author note:]Update this stand section to show differences between the 42 and 47 models. David N. as the screw measurements as 42" =33mm (1 5/16") and 47"=17mm (5/8 ") with a washer, but Brian D. has LGE guide that says 42"=30mm and 47"=10mm.

Take the parts for the stand out of the box.

- For the HP LD4201 and LD4210—four screws M4 x 33 mm (in) (1) and stand (2)
- HP LD4710—four screws M4 x 17 mm (in) (1) and stand (2)

Figure 3-1 Stand accessory contents

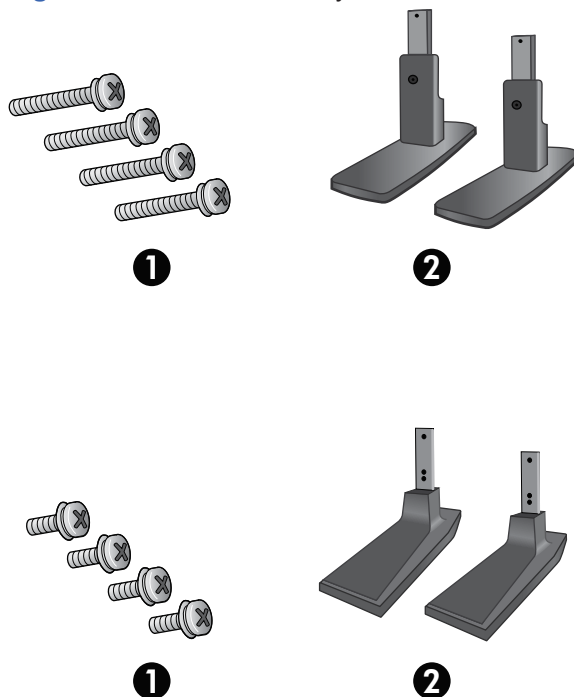

2nd Draft

2. Place a soft cloth on the table and place the display with the screen facing downward. Connect the stand as shown in the following figure.

Figure 3-2 Sliding the stand onto the display

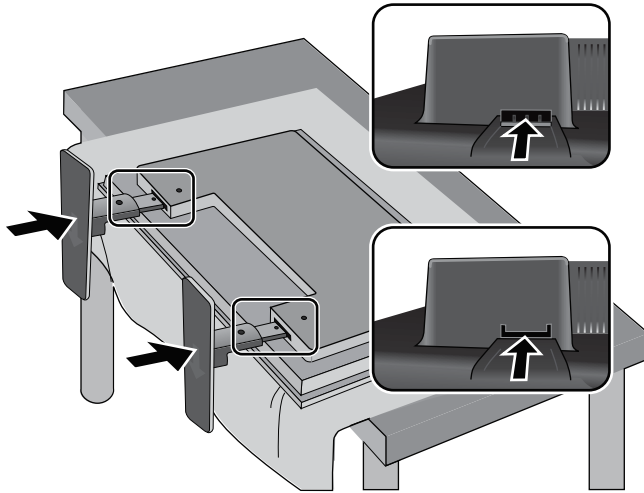

3. Use the screws to secure the stand on the rear side of the product as shown in the figure.

Figure 3-3 Securing the stand to the display

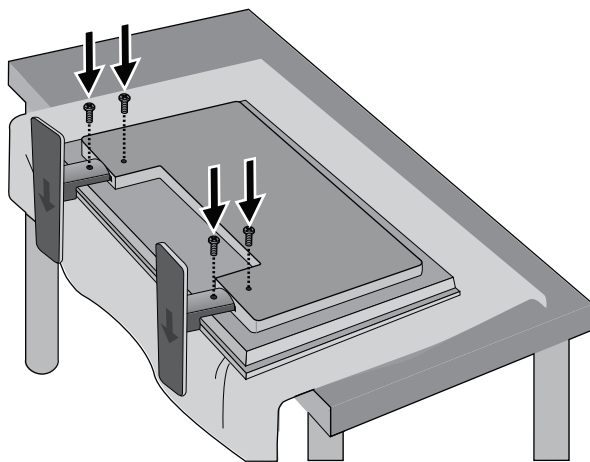

2nd Draft

Connecting the speakers (sold separately)

1. Mount the speakers onto the display.

Figure 3-4 Mounting the speakers

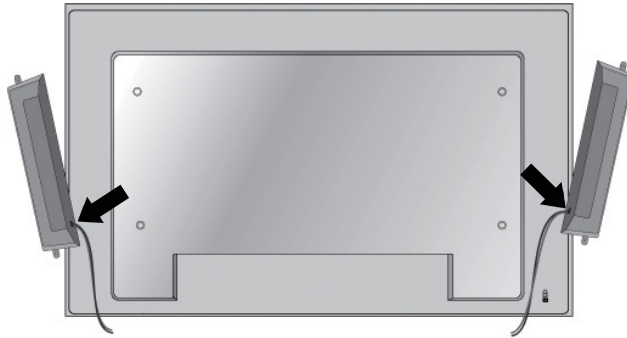

2. Use the four Taptite D3 x 12 mm (0.47 in) screws to secure the speakers to the display.

Figure 3-5 Securing the speakers to the display

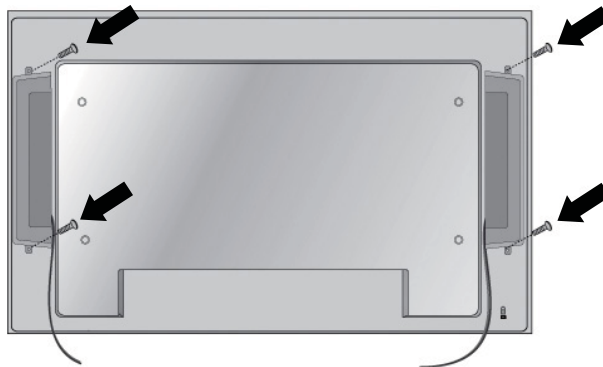

2nd Draft

3. After installing the speakers, use the cable holders and cable ties (available on select models) to organize the speaker cables.

Figure 3-6 Using the cable holders (feature available on select models)

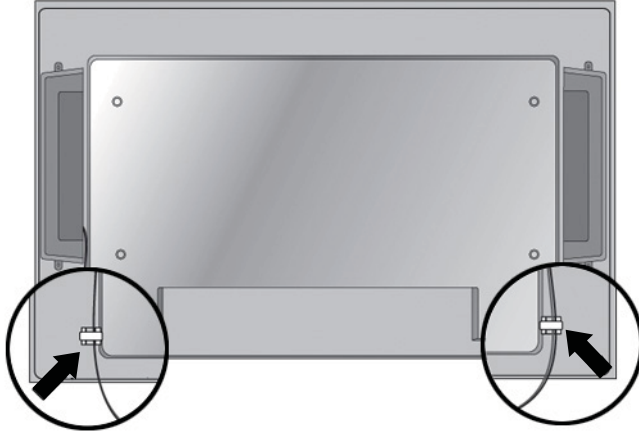
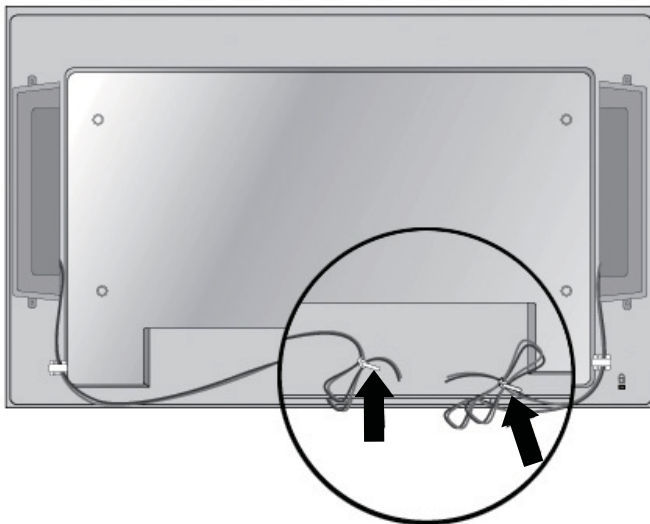

Figure 3-7 Using the cable ties (feature available on select models)



2nd Draft

4. After installing the speakers, connect the input terminal with a proper color match.

Figure 3-8 Connecting to the input terminal

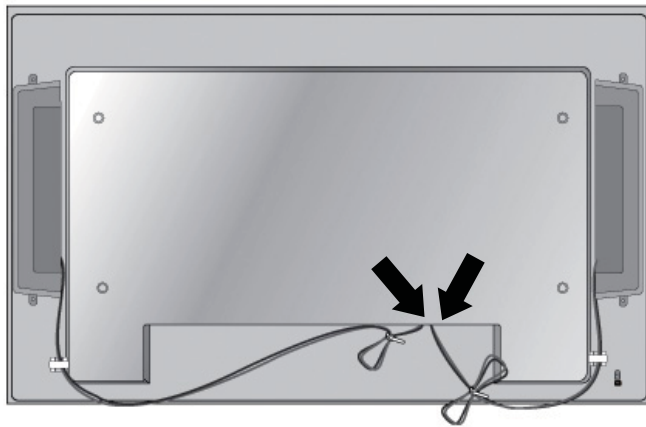

Rotating to the portrait position

When installing the display in the portrait position, rotate it clockwise based on its front. The display can be rotated in only one direction.



 **NOTE:** The display cannot be rotated if it is installed on the stand.

Figure 3-9 Installing portrait

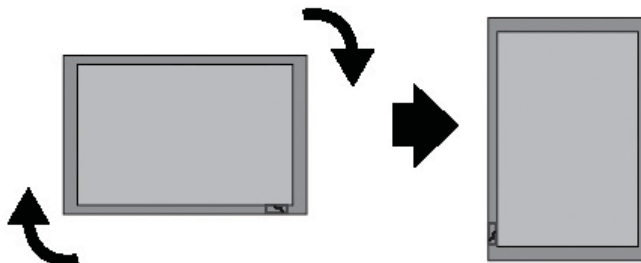

 **NOTE:** The LED indicator light orientation is on the bottom-right corner in the landscape position and on the bottom-left corner when rotated to the portrait position.

2nd Draft

Using the remote control

Inserting the batteries (sold separately)

1. Slide off the battery cover.
2. Insert the batteries with correct polarity (+/-).
3. Close the battery cover.

 **NOTE:** To prevent environmental pollution, dispose of used batteries in accordance with your local recycling guidelines.

Figure 3-10 Inserting batteries



2nd Draft

Identifying remote control buttons

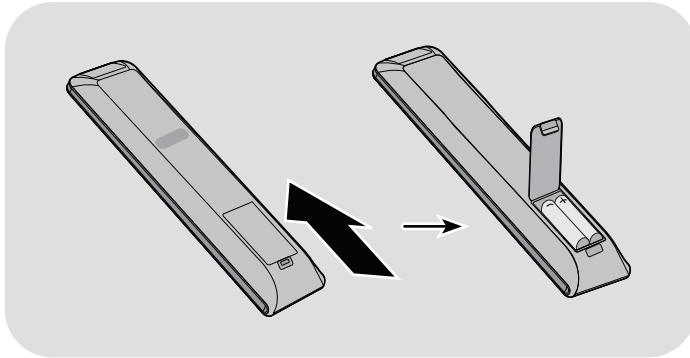
Figure 3-11 Remote control buttons [Author note:] Graphic is being updated — component 4 and 16 are not supported and component 20 is now USB instead of S.Menu

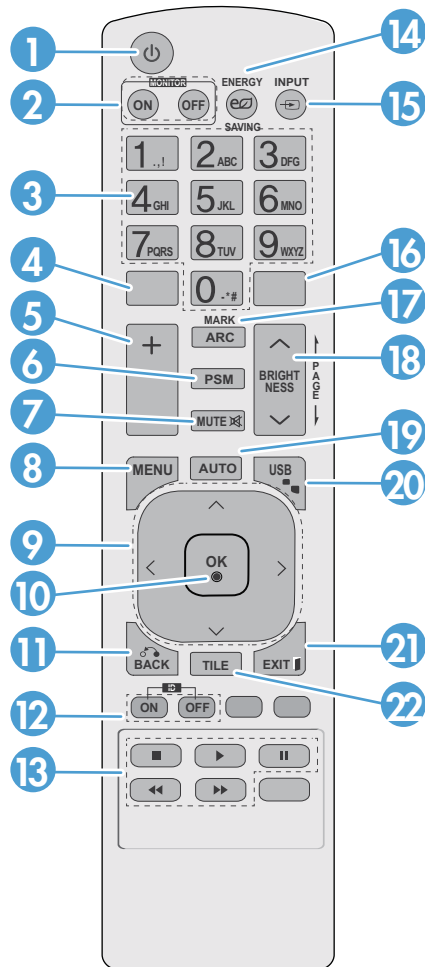

Component	Function	
1	Power on/off	Turns the display on from standby or off to standby
2	MONITOR ON or OFF	Turns the display on and off
3	Number and alphabet	Types numbers and alphabet letters
4		Not supported
5	Volume up (+) or down (-)	Adjusts the volume
6	PSM	Selects the Picture Status Mode
7	MUTE	Turns the sound on or off
8	MENU	Selects a menu or clears all on-screen displays and returns to display viewing from any menu
9	Up/down/left/right arrows	Allows navigation of the On-Screen Display menus and adjustment of the system settings

2nd Draft

Component	Function
10 OK	Accepts a selection or displays the current mode
11 BACK	Navigates one step back in an interactive application
12 ID ON or OFF	Enables the display lock
13 USB menu control buttons	Use with the HP Media Sign Player option lists in the USB menu
14 ENERGY SAVING	Adjusts the Energy Saving mode
15 INPUT	Opens the Input Source menu options (RGB , HDMI/DVI , and DisplayPort)
16	Not supported
17 ARC	Selects the Aspect Ratio converter mode
18 BRIGHTNESS	Adjusts the resolution and brightness by pressing the Up and Down buttons on the remote control In USB mode, the OSD menu uses the Page function of the BRIGHTNESS button to move to the next file list.
19 AUTO	Automatically adjusts picture position and minimizes image instability (RGB input only)
20 USB	Opens the USB menu options
21 EXIT	Clears all on-screen displays and returns to display viewing from any menu
22 TILE	Selects the TILE Mode

2nd Draft

Identifying display components

Figure 3-12 Display components [Author note:] Update graphic —need new front and back component graphics with callouts.

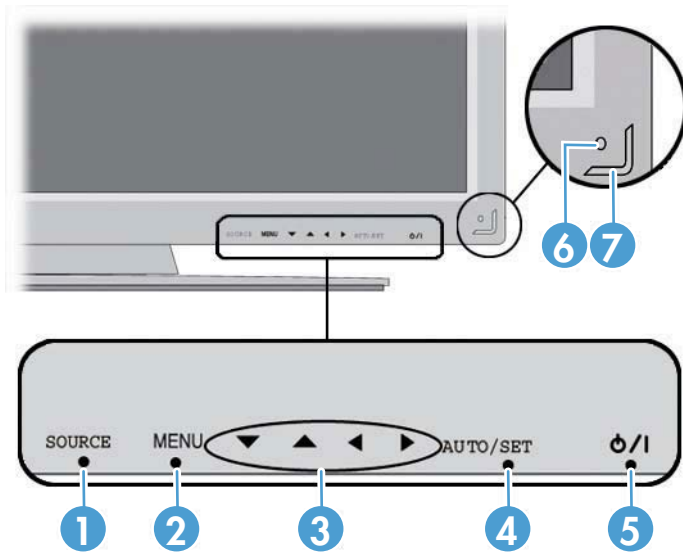

Component	Function
1 SOURCE	Toggles between video inputs: <ul style="list-style-type: none"> • HDMI/DVI - Digital signal • RGB - 15-pin D-Sub analog signal • DisplayPort
2 MENU	Opens or closes the OSD (On-Screen Display) menu screen.
3 OSD select/adjust buttons	Selects an OSD menu icon or adjusts the settings in the OSD screen. Down arrow ▼ and up arrow ▲ buttons adjust up and down Left arrow ◀ and right arrow ▶ buttons adjust the volume
4 AUTO/SET	When the OSD window is closed, the auto-adjustment feature to optimize the screen image is activated. When the OSD window is open, press to select a menu item or save changes.
5 Power	Press to turn on the power. Press again to turn it off.
6 IR receiver	Receives signals from the remote control.
7 LED indicator light	Lights up blue when the display operates normally (on mode). If the display is in sleep (Energy Saving) mode, the indicator color changes to amber.

2nd Draft

Figure 3-13 Display ports

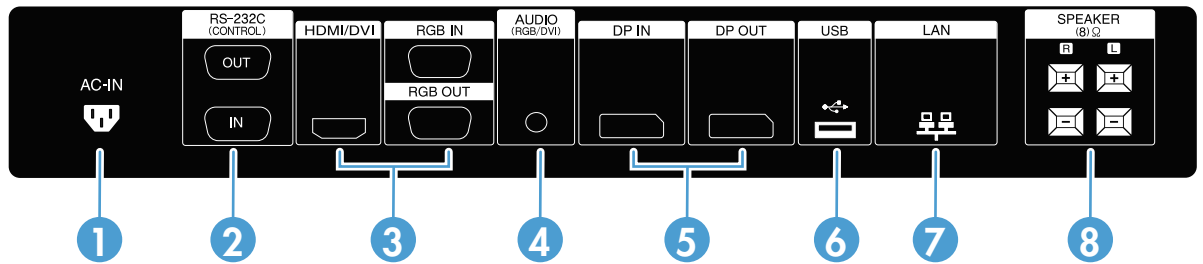

Component	Function
1 AC-IN power	AC-IN connects the AC power cord to the display.
2 RS-232-C (Control) serial ports	RS-232-C (Control) serial ports connect to RS-232 devices
3 HDMI/DVI, RGB IN, and RGB OUT	HDMI supports High Definition input and HDCP (High-bandwidth Digital Content Protection). Some devices require HDCP in order to display HD signals. DVI input is supported with an HDMI to DVI signal cable (not included). RGB IN supports analog VGA connections from PCs. RGB OUT supports cloning connections with VGA cables from display to display.
4 AUDIO (RGB/DVI)	AUDIO (RGB/DVI) connects the audio cable to the Line Out on the media player/computer sound card. NOTE: Before connecting to the AUDIO (RGB/DVI) port on the display, verify what type of Audio Out connection is available on the media player/computer sound card. The Line Out on a media player/computer is used to connect to speakers, including a built-in amplifier (AMP). For additional instructions, refer to the sound card manual. If the Audio Out on the media player/computer sound card has only Speaker Out, reduce the media player/computer volume before connecting to the AUDIO (RGB/DVI) port on the display. If the Audio Out on the media player/computer sound card supports both Speaker Out and Line Out, choose Line Out.
5 DP IN and DP OUT (DisplayPort)	DP IN supports digital input with DisplayPort cables from a media player/computer. DP OUT supports cloning of connections with DisplayPort cables from display to display.
6 USB	USB connects a USB storage device to an HP Media Sign Player.
7 LAN (HP LD4210 and HP LD4710 models only)	LAN connects the display directly to a media player/computer or to a network directly or indirectly by a router, hub, or switch using the LAN cable.
8 SPEAKER	SPEAKER connects the external speakers to the display.

2nd Draft

VESA mounting support and security slot

VESA FDMI (Video Electronics Standards Association Flat Display Mounting Interface) wall mounting—This product supports a VESA FDMI-compliant mounting device. The mounting devices can be purchased separately from HP.

Security cable provision—To help prevent theft, a security cable provision is available on the rear of the display. The cable and lock required to connect to the display are available separately and can be purchased from HP.

Figure 3-14 VESA mounting holes

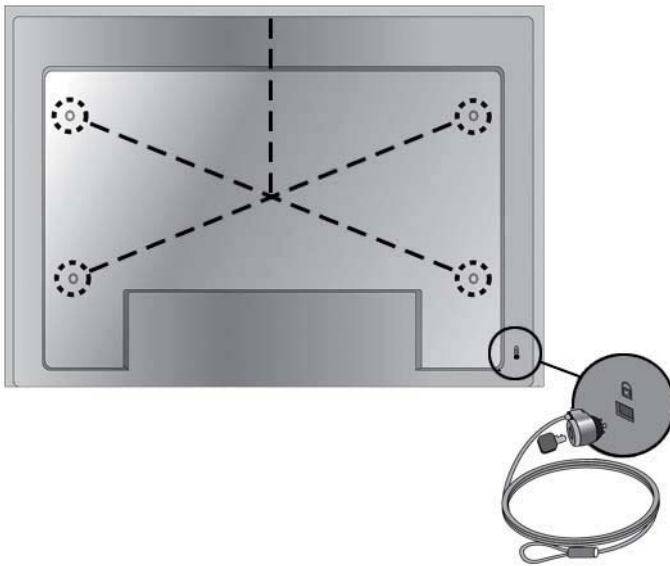

Connecting to external devices

1. Be sure that the display, media player/computer, and all attached devices are turned off.
2. Connect the signal input cable.

For additional information, see one of the following signal input cable sections:

- [Connecting RGB on page 20](#)
- [Connecting DisplayPort \(480p/576p/720p/1080i/1080p\) on page 20](#)
- [Connecting HDMI \(480p/576p/720p/1080i/1080p\) on page 21](#)
- [Connecting LAN \(HP LD4210 and HP LD4710 only\) on page 22](#)

3. Connect the audio cable (sold separately) to the Audio (RGB/DVI) (1) connector on the rear of the display and the other end to the Line Out port (2) on the media player/computer if the video signal connection is from either a RGB (VGA) or DVI connector on the media player/computer.

Figure 3-15 Connecting the audio

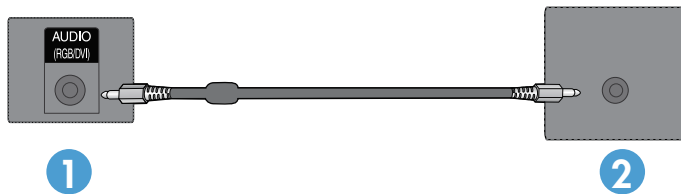

NOTE: The ferrite core can be used to reduce electromagnetic waves when connecting an audio cable. As shown in the image, fit the ferrite core to the audio cable. The ferrite core needs to be separated from the mold by 5 cm (2 in).

4. Connect the AC power cord to the AC-IN connector (1) on the rear of the display and the other end to an electrical outlet (2). Before connecting the power cord, please read the power-cord safety precautions in the [Important safety information on page 3](#).

[Author note:] I have removed the Warning message that appeared below this step, because it was identical to the Warning in the “Important safety information” section; instead, I have referenced this safety section that contains the Warning message. Is this ok?

Figure 3-16 Connecting the power cord **[Author note:]** Update graphic —Needs a new graphic of the power cord.

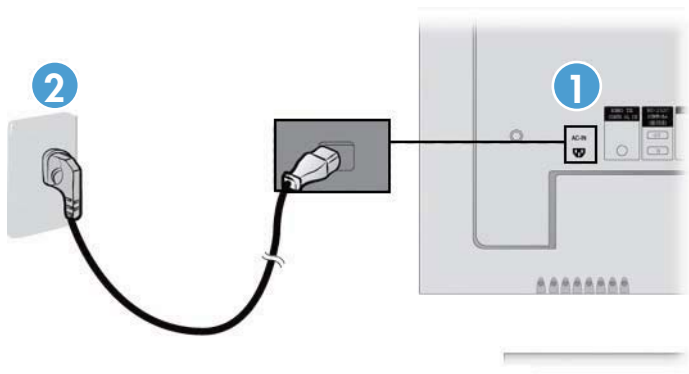

2nd Draft

5. Turn on power to the display by pressing the power button.

Figure 3-17 Power button [Author note:] Update graphic-Needs a new graphic of front of display.

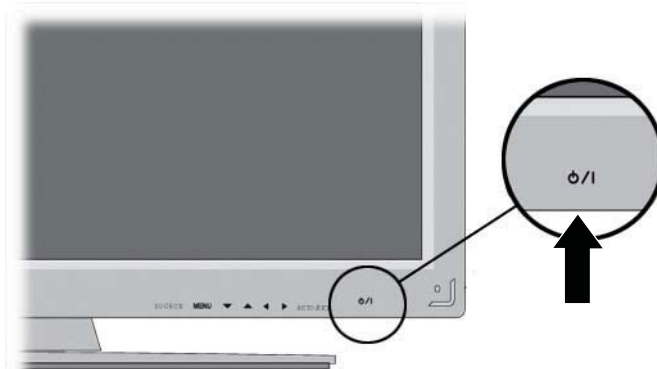

6. Turn on the media player/computer.
7. Select an input signal.

Press the **INPUT** button on the remote control to open the **Input List**, select the appropriate input signal (RGB, HDMI/DVI, DP), and then press the **OK** button to save your change.

Or, press the **SOURCE** button on the back of the display, and then press the **AUTO/SET** button to save your change.

NOTE: If connecting more than one input source, connect the signal cables [HDMI/DVI, RGB (VGA), and DisplayPort] to each media player/computer. Press the **INPUT** button on the remote control to select the input to view.

2nd Draft

Connecting RGB

1. For analog operation, connect the D-Sub signal cable to the RGB IN (1) connector on the rear of the display and the other end to the connector (2) on the media player/computer.

 **NOTE:** If connecting to a Mac media player/computer, use the standard Mac adapter (3)—not included.

Figure 3-18 Connecting the D-Sub signal cable



2. Connect the audio cable (sold separately) to the Audio (RGB/DVI) (1) connector on the rear of the display and the other end to the Line Out port (2) on the media player/computer if the video signal connection is from either a RGB (VGA) or DVI connector on the media player/computer.
3. Select an input signal.

Press the INPUT button on the remote control, select the **RGB** input signal, and then press the OK button to save.

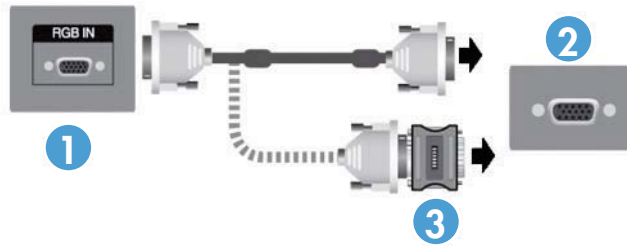
Or, press the **SOURCE** button on the back of the display, select the **RGB** input signal, and then press the **AUTO/SET** button to save.

Connecting DisplayPort (480p/576p/720p/1080i/1080p)

1. Connect the DisplayPort cable to the DP IN port on the display and to the DisplayPort OUT port on the media player/computer, and then connect the power cord.

Figure 3-19 Connecting DisplayPort input to a media player/computer

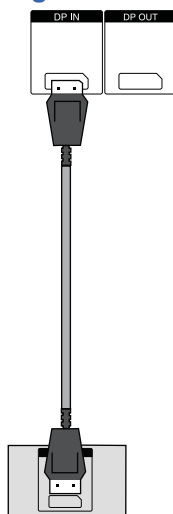

2. Select an input signal.

2nd Draft

Press the **INPUT** button on the remote control, select the **DP** input signal, and then press the **OK** button to save.

Or, press the **SOURCE** button on the back of the display, select the **DP** input signal from the Input List, and then press the **AUTO/SET** button to save.

Connecting HDMI (480p/576p/720p/1080i/1080p)

HDMI supports High Definition Input and HDCP. Some devices require HDCP in order to display HD signals.

1. Use one of the following examples to connect the HDMI input:

- Connect an HDMI to DVI signal cable and RCA-PC audio cable (cables not included) to the display and VCR/DVD/Set-top box, and then connect the power cable (1).
- Connect an HDMI cable to the display and DVR/DVD/Set-top box, and then connect the power cable (2).

Figure 3-20 Connecting HDMI input to VCR/DVD/Set-top box

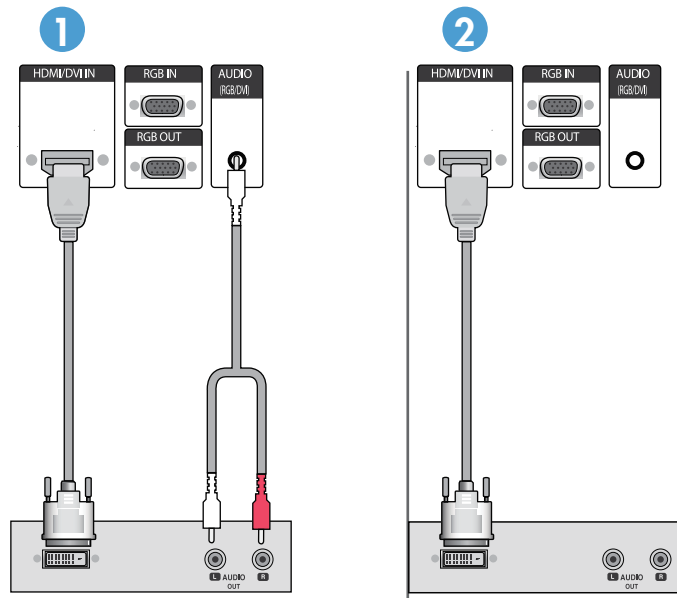

- Connect the HDMI to DVI signal cable (not included) to the HDMI/DVI (1) connector on the rear of the display and the other end to the DVI connector (2) on the media player/ computer.

NOTE: Use shielded signal interface cables (D-sub 15 pin cable, DVI cable) with ferrite cores to maintain standard compliance for this product.

Figure 3-21 Connecting the HDMI to DVI signal cable

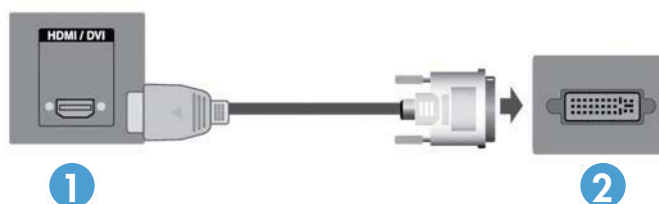

2nd Draft

- Connect the HDMI to HDMI signal cable (not included) to the HDMI/DVI (1) connector on the rear of the display and the other end to the HDMI connector (2) on the media player/ computer.

Figure 3-22 Connecting the HDMI to HDMI signal cable [Author note:] Create graphic for HDMI to HDMI?



2. Select an input signal.

Press the **INPUT** button on the remote control, select the **HDMI/DVI** input signal, and then press the **OK** button to save.

Or, press the **SOURCE** button on the back of the display, select the **HDMI/DVI** input signal, and then press the **AUTO/SET** button to save.

Connecting LAN (HP LD4210 and HP LD4710 only)

The LAN input on the display can connect to a media player/computer, a router (switch), or an Intranet. A LAN connection with the display establishes communication between your media player/ computer and the display, which enables the use of the HP Network Sign Manager program running

2nd Draft

on the connected media player/computer to assign an IP address to the monitor, change monitor settings, and set up HP Media Sign Player options, play lists, and On/Off schedule times.

1. Connect the LAN cable (not included) using one of the following connections:
 - Computer Direct Connection—Connect the LAN cable to the LAN port on the display and to the LAN port on the media player/computer (1).
 - Router—Connect the LAN cable to the LAN port on the display and to a LAN port on the router (2).
 - Intranet—Connect the LAN cable to the LAN port on the display and to the Intranet network via an access point (3).

Figure 3-23 Connecting the LAN cable

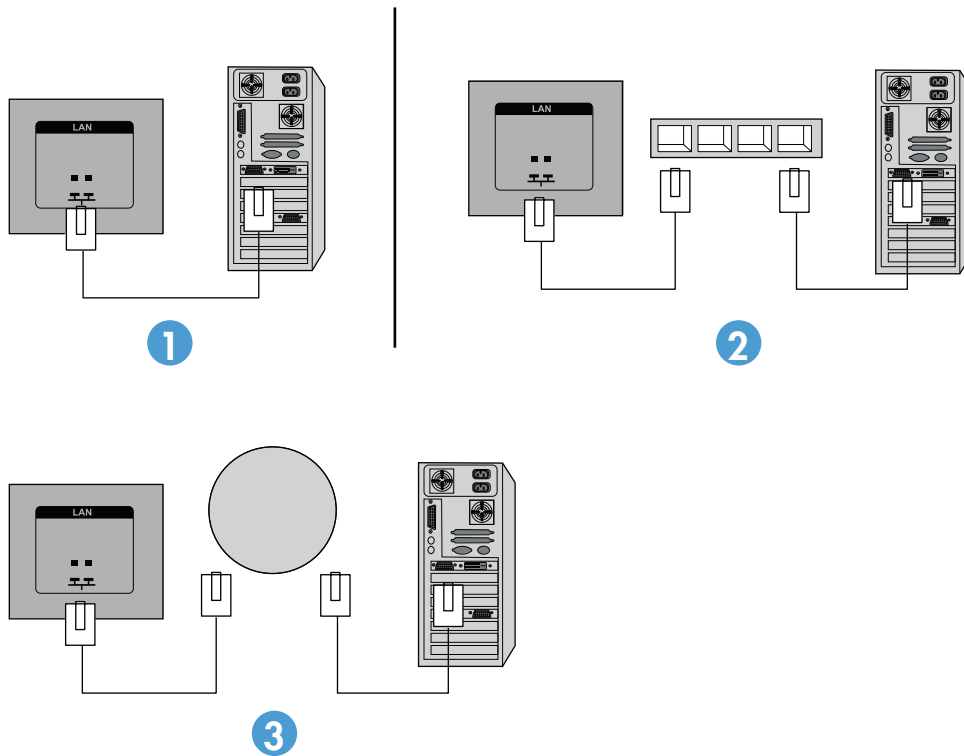

2. Install the HP Network Sign Manager on the media player/computer attached to the intranet. To download the HP Network Sign Manager, see the website www.xxxxxxxx.com. See [Installing HP Network Sign Manager on page 47](#) for details on using the HP Network Sign Manager application.

Connecting daisy chain displays

Multiple monitors (up to 25) can be connected in a daisy chain (connect several monitors together in tile mode) to a computer using DisplayPort IN/OUT or with the combination of RGB IN/OUT and RS-232-C IN/OUT ports on the display.

To connect displays in a daisy chain, the displays must all be connected with the same input/output source (DisplayPort IN/OUT or RGB IN/OUT and RS-232-C IN/OUT) as shown in the figures below.

- To daisy chain displays for video, use DisplayPort IN/OUT connections or RGB IN/OUT connections.
- To daisy chain for both video and display command and control, use DisplayPort IN/OUT plus RS-232-C IN/OUT or RGB IN/OUT plus RS-232-C IN/OUT.

NOTE: The number of displays that can be connected by daisy chain to one media player/computer might vary depending on the signal status and cable loss. If the signal status is good, and there is no cable loss, it is possible to connect up to twenty-five displays in a daisy chain from one media player/computer.

To connect multiple displays in a daisy chain, connect the input signal cable from the media player/computer to the first display in the daisy chain and connect the subsequent displays, using the same input signal cables, from the OUT port to the IN port of the next display, as shown in the figures below, until all the displays are connected together.

Figure 3-24 Daisy chain connection—RGB for video input signal

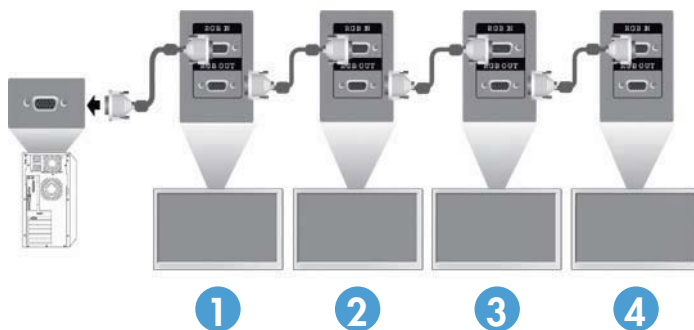
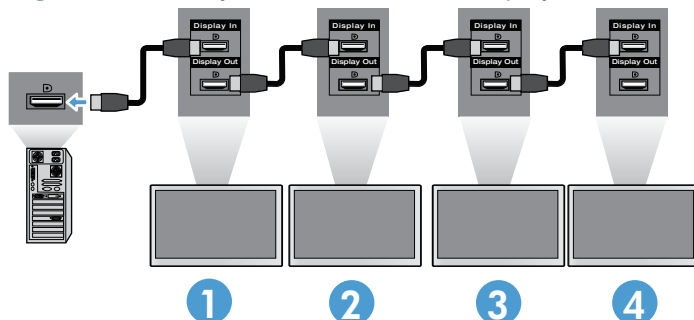

Figure 3-25 Daisy chain connection—RGB for video input signals and RS-232-C for display command and control [Author note:] Create graphic for daisy chain RGB and RS-232-C?



Figure 3-26 Daisy chain connection—DisplayPort for video input signal



2nd Draft

Figure 3-27 Daisy chain connection—DisplayPort for video input signal and RS-232-C for display command and control **[Author note:]Create graphic for daisy chain DisplayPort and RS-232-C?**



2nd Draft

4 Operating the display

Software and utilities

HP displays are Plug-and-Play with Windows® XP, Windows Vista®, and Windows 7 operating systems, so you do not need to download the .INF file or the .ICM file for these operating systems. The most current versions of the following software and utilities can be downloaded from the following HP website for use with the displays as needed: www.xxx.com.

- Auto-adjustment Pattern Utility—optimizes the display.
- HP Network Sign Manager (HP LD4210 and HP LD4710 only)—allows you to select and control the display options remotely from a connected media player/computer and allows you to select the options for the HP Media Sign Player. For more details on the HP Media Sign Player, see the **Using the HP Media Sign Player** chapter.

PDF Complete is supplied on this CD and can be installed from the menu.

 **NOTE:** If the display does not include a CD, the .INF and .ICM files can be downloaded from the HP displays support website. See [Downloading from the Web on page 28](#) in this chapter.

The information file

The setup information, or .INF file, defines display resources used by Microsoft® Windows operating systems to ensure display compatibility with the media player/computer's graphics adapter.

The image color matching file

The image color matching, or .ICM file, is a color data file that is used in conjunction with graphics applications to provide consistent color matching from display screen to printer, or from scanner to the display screen. The .ICM file is only activated from within the graphics applications that support this feature.

2nd Draft

Installing the .INF and .ICM files

You can install the .INF and .ICM files from the CD or download them from the HP displays support website.

Installing from the CD

To install the .INF and .ICM files on the media player/computer from the CD:

1. Insert the CD in the media player/computer CD-ROM drive. The CD menu appears.
2. View the **Display Driver Readme** file.
3. Select **Install display driver software**.
4. Follow the on-screen instructions.
5. Ensure that the proper resolution and refresh rates appear in the Windows Display control panel.

 **NOTE:** You might need to install the digitally signed display .INF and .ICM files manually from the CD in the event of an installation error. Refer to the *Display Driver Readme* file on the CD for instructions (in English only).

Downloading from the Web

To download the latest version of .INF and .ICM files from the HP displays support website:

1. Refer to www.hp.com/support and select the country/region.
2. Follow the links for the display to the support page and download page.
3. Ensure the system meets the requirements.
4. Download the software by following the instructions.

2nd Draft

Using the auto-adjustment function (RGB INPUT source only)

You can optimize the screen performance by using the **AUTO/SET** button on the display (AUTO button on the remote control) and the Auto-adjustment Pattern Utility software on the CD provided.

 **NOTE:** Do not use this procedure if the display is set to use a DisplayPort or HDMI/DVI input source.

If the monitor is using a PC analog signal input, this procedure can correct the following image quality conditions:

- Fuzzy or unclear focus
- Ghosting, streaking or shadowing effects
- Faint vertical bars
- Thin, horizontal scrolling lines
- An off-center picture

To use the auto-adjustment feature:

1. Allow the display to warm up for 20 minutes before adjusting.
2. Press the **AUTO/SET** button.







If the result is not satisfactory, continue with the procedure.

3. Insert the CD in the disc drive. The CD menu appears.
4. Select **Open auto-adjustment software**. The setup test pattern appears.
5. Press the **AUTO/SET** button to produce a stable, centered image.
6. Press the **ESC** key or any other key on the keyboard to exit the test pattern.

2nd Draft

Using the On-Screen Display menu

The display settings can be adjusted from the On-Screen Display (OSD) menu.

Icon	Main menu	Function description
	Picture	Adjusts screen brightness, contrast, and color
	Audio	Adjusts the audio options
	Time	Adjusts the timer options
	Option	Adjusts the screen status according to the circumstances
	Tile	Adjusts the tile options
	USB	Adjusts the USB options

Using the remote control to adjust the OSD

Use the OSD to adjust the screen image based on your viewing preferences. To access the OSD, do the following:

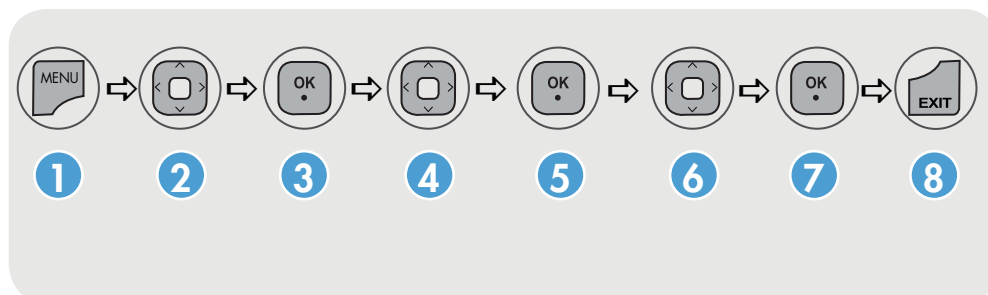

1. If the display is not already on, press the power button to turn on the display.
2. Press the MENU button (1) on the remote control.
3. To access a control, use the down arrow ▼ or up arrow ▲ button (2).
4. When the icon you want becomes highlighted, press the OK button (3).
5. To access a control, use the down arrow ▼ or up arrow ▲ button (4).
6. When the list you want becomes highlighted, press the OK button. (5).
7. Use the down arrow ▼, up arrow ▲, left arrow ◀, or right arrow ▶ button (6) to adjust the item to the desired level.
8. Accept the changes by pressing the OK button (7).
9. Exit the OSD menu by pressing the EXIT button (8).

2nd Draft

OSD menu selections

The following table lists the On-Screen Display (OSD) menu selections and their functional descriptions.

Icon	Main menu	Submenu	Description
	PICTURE	Aspect Ratio	Selects from the following screen image sizes: <ul style="list-style-type: none">• 16:9—widescreen mode.• 1:1—the picture format is 1:1 aspect ratio.• Just Scan—allows you to enjoy the transmitted data fully without any images cut off. (This menu is activated only in 720p and 1080i in Component mode.)• Original—the aspect ratio is not adjusted from the original. It is set by the program being watched.• 4:3—the picture format is 4:3 aspect ratio.• 14:9—programs are viewed normally in 14:9 with black bars added to the top and bottom. The 4:3 programs are magnified on the top/bottom and left/right sides.• Zoom—4:3 programs are magnified until they fill the 16:9 screen. The top and bottom will be cut off.• Cinema Zoom 1—adjusts the picture both horizontally extended and vertically cropped. The picture adopting a compromise between alteration and screen coverage.
		Energy Saving	Select from the following screen brightness levels: <ul style="list-style-type: none">• Off—100% light• Level 1—80% light• Level 2—60% light• Level 3—40% light

2nd Draft

Icon	Main menu	Submenu	Description
		Picture Mode	<p>Select from the following screen presets:</p> <ul style="list-style-type: none">• Standard—the most general and natural screen display status.• Vivid—select to display with a sharp image.• Cinema—lowers brightness by one level.• Sport—displays with a soft image.• Game—to enjoy dynamic image when playing a game.• Expert 1 and Expert 2—allows user-defined settings:<ul style="list-style-type: none">◦ Backlight—controls the brightness of the screen, adjust the brightness of the LCD panel.◦ Contrast—adjusts the difference between the light and dark levels.◦ Brightness—adjusts the brightness of the screen.◦ Sharpness, H Sharpness, and V Sharpness—adjusts the clearness of the screen.◦ Color—adjusts the color to desired level.◦ Tint—adjusts the tint to a desired level. <p>NOTE: If the Picture Mode setting in the Picture menu is set to Vivid, Standard, Cinema, Sport, or Game, the subsequent menus will be automatically set.</p>

2nd Draft

Icon	Main menu	Submenu	Description
		Advanced Control	<p>Select from the following screen color adjustment settings:</p> <ul style="list-style-type: none">• Color Temperature—select from the following color settings:<ul style="list-style-type: none">◦ Cool—slightly purplish white.◦ Medium—slightly bluish white.◦ Warm—slightly reddish white.• Dynamic Contrast—optimizes the contrast automatically according to the brightness of the reflection.• Dynamic Color—adjusts the color of the reflection automatically to reproduce natural colours as close as possible.• Noise Reduction—removes the noise up to the point where it does not damage the original picture.• Gamma—set your own gamma value. On the display, high gamma values display whitish images and low gamma values display high contrast images.• Black Level—adjusts the contrast and the brightness of the screen using the black level of the screen.<ul style="list-style-type: none">◦ Low—The reflection of the screen gets darker.◦ High—The reflection of the screen gets brighter.• Film Mode—adjusts the display, when watching a movie, to the best picture appearance.

2nd Draft

Icon	Main menu	Submenu	Description
		Expert 1 and Expert 2	Select from the following settings:
		Control	<ul style="list-style-type: none"> • Dynamic Contrast—optimizes the contrast automatically according to the brightness of the reflection. • Noise Reduction—removes the noise up to the point where it does not damage the original picture. • Gamma—set your own gamma value. On the display, high gamma values display whitish images and low gamma values display high contrast images. • Black Level—adjusts the contrast and the brightness of the screen using the black level of the screen. • Film Mode—adjusts the display, when watching a movie, to the best picture appearance. • Color Standard—adjusts color. • White Balance—adjusts the overall color of the screen to the feeling you want. • Color Management System—adjusts by using test patterns. This does not affect other colors but can be used to selectively adjust the 6 color areas (Red/ Green/ Blue/Cyan/Magenta/Yellow). Color difference might not be distinctive even when you make the adjustments for a general video.
		Picture Reset	Returns the Picture Mode to the default factory settings.
		Screen	Select from the following screen video settings: <ul style="list-style-type: none"> • Resolution—to view a normal picture, match the resolution of RGB mode and selection of PC mode. (Function works in the following mode: RGB [PC] mode.) • Auto Config. (RGB PC input only)—automatic adjustment of the screen position, clock, and phase. (Function is available for analog signals only.) • Position—moves the screen position. • Size—adjusts the size of the screen. • Phase—adjusts the focus of the display. This item allows you to remove any horizontal noise and clear or sharpen the image of characters. (Function is available for analog signals only.) • Reset—returns Manual Config. to the default factory settings.
	AUDIO	Auto Volume	Adjusts uneven sound volumes across all channels or signals automatically to the most appropriate level. To use this feature, select On ; to turn off the feature, select Off .

2nd Draft

Icon	Main menu	Submenu	Description
		Clear Voice II	Differentiates the human sound range from other sounds, which helps to make the human voices easier to hear. To use this feature, select On ; to turn off the feature, select Off .
		Balance	Balances sound between the left and right speakers.
		Sound Mode	Automatically selects the best sound tone quality, depending on the video type that you are currently watching, from the following options: <ul style="list-style-type: none"> • Standard—most commanding and natural audio. • Music—select for original sound when listening to music. • Cinema—select for sublime sound. • Sport—select for sports broadcasting. • Game—select for dynamic sound when playing a game.
		Treble	Adjust treble 0–100.
		Bass	Adjust bass 0–100.
		Reset	Resets the Sound Mode to the factory default settings.
		Speaker	Adjusts internal speaker status (speakers sold separately). To use this feature, select On ; to turn off the feature, select Off . To use an external hi-fi stereo system, turn off the internal speakers of the display.
		DisplayPort Audio Out	Select DisplayPort or Analog .
	TIME	Clock	Resets the Day , Hour , and Minute if the current time is incorrect.
		On Time	The on time automatically switches the display on at the pre-set time.
		Off Time	The off time automatically switches the display to standby at the pre-set time.
		Sleep Timer	Automatically turns off power when the time set by a user has passed.
		Auto Off	If active and there is no input signal, the display switches to off mode automatically after 10 minutes.
		Power On Delay	When connecting multiple displays and turning the power on, the displays are turned on individually to prevent overload.
	OPTION	Language	Selects the language in which the OSD menu is displayed.
		Input Label	Selects a label for each input source.

2nd Draft

Icon	Main menu	Submenu	Description
		Key Lock	Sets up the display so that it can only be used with the remote control. This feature can prevent unauthorized viewing.
		Set ID	Use to assign a unique Set ID NO (name assignment) to each product when several products are connected for display.
		ISM Method	Image Sticking Minimalization Method—avoids allowing a fixed or burn-in image to remain on the screen for a long period of time.
		DPM Select	Display Power Management Select—Turns the power saving mode On or Off .
		Power Indicator	Sets the power indicator on the front of the display to On or Off .
		DDC-CI	To use this feature, select On ; to turn off the feature, select Off .
		DFC	Digital Fine Contrast—To use this feature, select On ; to turn off the feature, select Off .
		Interface Select	Sets up network connections. <ul style="list-style-type: none"> • RS-232C—Enables communication via Serial. • Network—Enables communication via Ethernet.
		Network Setup	DHCP —Allocates and sets up IP automatically.
		IP Mode	Manual —Sets up IP Address , Gateway , Subnet Mask , and DNS Server .
		Information	Contains the Serial No. , SW Version (MNT) , SW Version (LAN) , IP Address , and MAC Address information.
		Factory Reset	Resets to the default factory settings.
	TILE	Tile Mode	Enlarges the screen and is also used with several products to view the screen. To use Tile Mode , the following must occur: <ul style="list-style-type: none"> • It must be displayed with several other products. • It must be in a function that can be connected to RS-232-C OUT, RGB OUT, or DisplayPort OUT.
		Tile ID	Selects the location of the Tile by setting an ID of 1–25.
		Natural Mode	The image is omitted by the distance between the screens to be naturally shown. To use this feature, select On ; to turn off the feature, select Off .
		H Size	Adjusts the horizontal size of the screen taking into account the size of the bezel.

2nd Draft

Icon	Main menu	Submenu	Description
		V Size	Adjusts the vertical size of the screen taking into account the size of the bezel.
		H Position	Moves the screen position horizontally.
		V Position	Moves the screen position vertically.
		Reset	Resets the Tile Mode configuration.
	USB	Photo List	View photo files on a USB storage device.
		Music List	Play music files on a USB storage device.
		Movie List	Play movie files on a USB storage device.
		Lock System	Sets the password function to On or Off. To use this feature, select On ; to turn off the feature, select Off .
		Set Password	Sets or changes the password to use the USB function.

Selecting an Aspect Ratio

The aspect ratio modes available for your selection depend on the current input source. Use the following table to determine which mode is available for your display.

Mode	DisplayPort	DisplayPort	RGB	HDMI/DVI	HDMI/DVI
	DTV	PC	PC	DTV	PC
16:9	X	X	X	X	X
Just Scan	X			X	
Original	X	X	X		X
4:3	X	X	X	X	X
1:1		X	X		X
14:9	X			X	
Zoom	X			X	
Cinema Zoom 1	X			X	

Adjusting the timer function

Use the remote control to set the following timer options.

2nd Draft

Clock

The **Clock** menu allows you to reset the clock manually if the current time is incorrect.

1. Press the MENU button, and then use the down arrow ▼ or up arrow ▲ button to select the **TIME** menu.
2. Press the right arrow ► button, and then use the down arrow ▼ or up arrow ▲ button to select the **Clock** menu.
3. Press the right arrow ► button, and then use the down arrow ▼ or up arrow ▲ button to set the hour (00h–23h).
4. Press the right arrow ► button, and then use the down arrow ▼ or up arrow ▲ button to set the minutes (00–59 min).

On Time and Off Time

The **On Time** and **Off Time** menus lets you set the display to automatically switch to standby at a pre-set time.

1. Press the MENU button, and then use the down arrow ▼ or up arrow ▲ button to select the **TIME** menu.
2. Press the right arrow ► button, and then use the down arrow ▼ or up arrow ▲ button to select **On Time** or **Off Time**.
3. Press the right arrow ► button, and then use the down arrow ▼ or up arrow ▲ button to set the hour (00h–23h).
4. Press the right arrow ► button, and then use the down arrow ▼ or up arrow ▲ button to set the minutes (00–59 min).
5. Press the right arrow ► button, and then use the down arrow ▼ or up arrow ▲ button to select **On** or **Off**.

 **NOTE:** Once the **On Time** or **Off Time** is set, these functions operate daily at the preset time. The **Off Time** function overrides the **On Time** function if they are set to the same time. When the **On Time** is operated, the input screen is turned on just as it was turned off.

Sleep Timer

The **Sleep Timer** menu lets you set the display power to automatically turn off when the time set by a user has passed.

1. Press the MENU button, and then use use the down arrow ▼ or up arrow ▲ button to select the **TIME** menu.
2. Press the right arrow ► button, and then use the down arrow ▼ or up arrow ▲ button to select the **Sleep Timer** menu.

2nd Draft

3. Press the right arrow ► button, and then use the down arrow ▼ or up arrow ▲ button to set the hour (00h–23h).
4. Press the right arrow ► button, and then use the down arrow ▼ or up arrow ▲ button to set the minutes (00–59 min).

 **NOTE:** In the event of a power interruption (disconnection or power failure), the **Sleep Timer** clock must be reset.

Auto Off

To set the display to switch to the off mode automatically after 10 minutes if **Auto Off** is active and there is no input signal:

1. Press the MENU button, and then use the down arrow ▼ or up arrow ▲ button to select the **TIME** menu.
2. Press the right arrow ► button, and then use the down arrow ▼ or up arrow ▲ button to select the **Auto Off** menu.
3. Press the right arrow ► button, and then use the down arrow ▼ or up arrow ▲ button to select **On** or **Off**.

Power On Delay

When connecting multiple displays and turning the power on, the displays are turned on individually to prevent overload.

Using Key Lock

The display can be set up so you can only use the remote control. To lock or unlock the OSD screen adjustment:

1. Press the MENU button, and then use the down arrow ▼ or up arrow ▲ button to select the **OPTION** menu.
2. Press the right arrow ► button, and then use the down arrow ▼ or up arrow ▲ button to select the **Key Lock** menu.
3. To lock the OSD screen adjustment, press the right arrow ► button, and then use the down arrow ▼ or up arrow ▲ button to select **On**.
4. To unlock the OSD screen adjustment, press the MENU button on the remote control, and then use the down arrow ▼ or up arrow ▲ button to select **Off**.

2nd Draft

Using ISM Method

A frozen or still picture from a media player/computer/Video game that appears on the screen for a prolonged period of time could result in a ghost image remaining even when you change the image. To avoid a fixed or burn-in image to remain on the screen for a long period of time:

1. Press the MENU button, and then use the down arrow ▼ or up arrow ▲ button to select the **OPTION** menu.
2. Press the right arrow ► button, and then use the down arrow ▼ or up arrow ▲ button to select the **ISM Method** menu.
3. Select one of the following menu options:
 - **Normal**—leave on normal if you do not foresee image burn-in being a problem.
 - **Orbiter**—might help prevent ghost images. However, it is best not to allow any fixed image to remain on the screen. To avoid a permanent image on the screen, the screen will move every 2 minutes.
 - **Inversion**—this function inverts the panel color of the screen. The panel color is automatically inverted every 30 minutes.
 - **White wash**—white wash fills the screen with solid white. This helps to remove permanent images burned into the screen. A permanent image might be impossible to clear entirely with white wash.

Using Tile Mode

Tile Mode is used to enlarge the screen and also used with several products to view the screen. This function must be displayed with various other products and connected to RS-232-C or RGB Out.

Tile mode allows you to:

- Choose tile alignment and set the ID of the current product to set location
- Set column by row (c = 1, 2, 3, 4, 5; r = 1, 2, 3, 4, 5) up to 5 x 5
- Configure an integration screen as well as configure one-by-one display

 **NOTE:** Adjustments made to the settings will be saved only after pressing the OK button on the remote control.

Figure 4-1 Tile Mode Enlarged screen



5 Using the HP Media Sign Player

[Author note:]The content for this section came from pages 34–37 of the 1st Draft of this User Guide- per Brian Dodge.

When you connect a USB storage device, the **MY MEDIA** menu appears with the options **Photo List**, **Music List**, or **Movie List**.

 **NOTE:** The **MY MEDIA** menu will not be displayed while the OSD is active, including the **Menu**, **EPG**, or **Schedule list**.

 **CAUTION:** Back up important files on the USB storage device before using with the display. Data management is the responsibility of the user. Do not turn off the display or unplug the USB storage device when the connected device is working. When a USB storage device is suddenly separated or unplugged, the stored files or the device might be damaged.

Information about using a USB storage device

- Only a USB storage device is recognizable.
- If the USB storage device is connected through a USB hub, the device is not recognizable.
- A USB storage device using an automatic recognition program might not be recognized.
- A USB storage device which uses its own driver might not be recognized.
- The recognition speed of a USB storage device is specific to each device.
- Do not connect a USB storage device which is artificially maneuvered on the media player/ computer. The device might cause the display to malfunction or fail to play the files. Only use a USB storage device which has standard music files or image files.
- Use only a USB storage device which was formatted as a FAT16, FAT32, or NTFS file system provided with the Windows operating system. If a storage device is formatted using a different utility program, which is not supported by Windows, it might not be recognized.
- Data in a USB storage device cannot be deleted or added in the NTFS file system.
- Connect power to a USB storage device that requires an external power supply; otherwise, the device might not be recognized.
- Connect a USB storage device with the cable provided by the USB manufacturer. When using other cables or an excessively long cable, the device might not be recognized.
- Some USB storage devices might not be supported or operate smoothly.
- A maximum of 999 files and folders can be recognized.

2nd Draft

- Data in a USB storage device cannot be aligned. Up to 128 English characters can be recognized as a file name.
- If the USB is connected in **Standby Mode**, the USB device might be detected when the display is turned on.
- The recommended capacity is 1TB or less for a USB external hard disk and 32GB or less for USB memory. Any device with more than the recommended capacity might not work properly.
- If a USB external hard disk with a “power saving” function does not work, turn the USB external hard disk off and on again.

2nd Draft

Using Photo List

Use **Photo List** to view photo files on a USB storage device.

Information about using **Photo List**

- PHOTO (*.JPEG) supporting file
- Baseline—15360 x 8640
- Progressive—1024 x 768
- You can view JPEG files only; non-supported files are displayed in the form of a bitmap.

Photo selection and menu options

- **View**—Display the selected item
- **Mark All**—Mark all photos on the screen
- **Delete**—Deleted the selected photo item
- **Close**—Close the pop-up menu

Options on full-sized photo view

- **Slideshow**—When no picture is selected, all photos in the current folder are displayed during slide show. If some photos are selected, those photos are displayed in a slide show. Set the time interval of the slide show in **Option**.
- **BGM** (Background Music)—Listen to music while viewing photos in full-size view. Before using this function, set the **Music Folder** for **BGM** in **Options**.
- **Rotate icon**—Use the rotate icon to rotate the photo 90°, 180°, 270°, or 360° clockwise. You cannot rotate when the width of a picture is bigger than the supported height.
- **Delete**—Deletes photos.
- **Option**—Set values for **Slide Speed** and **Music Folder** for **BGM**. Use the down arrow ▼, up arrow ▲, left arrow ◀, or right arrow ▶ button and the OK button to set values. Press OK to save the settings. You cannot change **Music Folder** while **BGM** is playing.
- **Hide**—Hide the menu on the full-sized screen. To see the menu again on the full-sized screen, press the OK button to display.

2nd Draft

Using Music List

Use **Music List** to play music files on a USB storage device.

 **NOTE:** If you do not select any button for a while, the play information box will float as a screen saver. Press the OK button to stop the screen saver.

Information about using **Music List**

- **MUSIC (*.MP3) supporting file**—Purchased music files (*.MP3) might contain copyright restrictions; playback of these files might not be supported.
- Damaged or corrupted music does not play but displays 00:00 in playtime.
- Bit rate 32 to 320kbps
- Sampling rate MPEG1 layer 3: 32 kHz, 44.1 kHz, 48 kHz.

Music selection and menu options

The Play ►, Pause II, Stop ■, Reverse ◀◀, and Forward ▶▶ buttons on the remote control are also available to use when playing music.

- **Play** (during stop)—Play the selected music titles. Once playback of a piece of music finishes, the next selected one will be played. When there are no selected music titles to play, the next one in the current folder will be played. If you go to a different folder and press the OK button, the current music in playback will stop.
- **Play Marked**—Play the selected music titles. Once a music finishes playing, the next selected one will be played automatically.
- **Stop Play** (during stop)—Stop the playing music titles.
- **Play with Photo**—Start playing the selected music titles and then move to the **Photo List**.
- **Mark All**—Mark all music titles in the folder.
- **Delete**—Delete the selected music titles.
- **Close**—Close the pop-up menu.

2nd Draft

Using Movie List

Use **Movie List** to play movie files on a USB storage device.

Information about using **Movie List**

- MOVIE (*.avi) supporting file
- Video format—MPEG1, MPEG2, MPEG4 (does not support Microsoft MPEG 4-V2, V3)
- Audio format—Mpeg, Mp3, PCM, Dolby Digital
- Sampling frequency—within 32k to 48 khz
- Bit rate—32k to 320 kbps
- Subtitle format—*.smi/ *.srt/ *.sub (MicroDVD, SubViewer 2.0)/ *.ass/ *.ssa/*.txt (DVD Subtitle System)
- If the video and audio structure of recorded file is not interleaved, either video or audio is outputted.
- Maximum FPS (frame per second) can be reached only at SD level. FPS is 25 FPS (720*576) or 30 FPS (720*480) depending on Resolution.
- Files more than 25 FPS or 30 FPS or higher might not be played properly.
- A video file name and its subtitle file name must be identical for it to be displayed.
- Playing a video via a USB connection that does not support high speed might not work properly.
- USB storage devices below USB 2.0 are supported as well, but they might not work properly in the **Movie List**.
- Files encoded with GMC (Global Motion Compensation) might not be played.

File	Video decoder	Audio codec	Max. resolution
Extension name			
mpg, mpeg, vob, dat	MPEG1, MPEG2	AC3, MPEG, MP3, PCM	720 x 576 @ 25p
Avi, m4v	MPEG4-SP, MPEG4-ASP, Xvid	AC3, MPEG, MP3, PCM	720 x 480 @ 30p

Movie selection and menu options

- **Play**—Play the selected movie
- **Mark All**—Mark all movies in the folder
- **Delete**—Delete the selected movie item
- **Close**—Close the pop-up menu

2nd Draft

Table 5-1 Using the remote control for movies

Reverse ◀◀ and Fast Forward ▶▶ buttons	<p>When the movie is in play mode, press the Reverse ◀◀ button repeatedly to increase the reverse speed ◀◀ (x2) → ◀◀◀◀ (x4) → ◀◀◀◀◀◀ (x8) → ◀◀◀◀◀◀◀◀ (x16) → ◀◀◀◀◀◀◀◀◀◀◀ (x32). Press the Fast Forward ▶▶ button repeatedly to increase the forward speed ▶▶ (x2) → ▶▶▶▶ (x4) → ▶▶▶▶▶▶ (x8) → ▶▶▶▶▶▶▶▶ (x16) → ▶▶▶▶▶▶▶▶▶▶ (x32).</p> <p>When the movie is in play mode, press the Fast Forward ▶▶ button repeatedly to increase the forward speed ▶▶ (x2) → ▶▶▶▶ (x4) → ▶▶▶▶▶▶ (x8) → ▶▶▶▶▶▶▶▶ (x16) → ▶▶▶▶▶▶▶▶▶▶ (x32).</p>
Pause button	<p>During playback, press the Pause button; a still screen appears. Press the Pause button, and then use the Forward ▶▶ button for slow motion. If no buttons are pressed on the remote control for 10 minutes after pausing, the TV returns to the playback state.</p>
Left arrow ◀ and right arrow ▶ buttons	<p>When using the left arrow ◀ or right arrow ▶ buttons during playback, a cursor indicating the position can be viewed on the screen.</p>
Play ▶ button	<p>Press the Play ▶ button to return to normal playback.</p>
ENERGY SAVING button	<p>Press the ENERGY SAVING button repeatedly to change the brightness of your screen.</p>

6 Installing HP Network Sign Manager

 **NOTE:** The HP Network Sign Manager is available only for the HP LD4210 and HP LD4710 Digital Signage Displays.

HP Network Sign Manager is a digital signage solution that consists of the signage display and management software that supports a network connection to a commercial display and combines the conventional USB playback feature to allow users to easily and simply enjoy media content at any time they want.

HP Network Sign Manager is a management software to help you easily adjust the settings (e.g. display and power on/off) of the monitors connected to the network or serial communications and play media files stored in the USB device. It also allows you to group the monitors depending on the purpose to manage the content playback list and playback schedule easily and efficiently.”

2nd Draft

Signage display

The signage display has a built-in Ethernet network interface card to play different media files simultaneously from different displays connected to the Internet or the local network and to control the settings for each display separately.

2nd Draft

System requirements

CPU	P1.8
RAM	256M
HDD	400M
Ethernet	100M
Operating system	Windows XP (32 bit) Windows Vista (32 bit) Windows 7 (32 bit)

2nd Draft

Features

- **Integrated Control of LAN and Serial Communications**—Ensures to easily manage the display connected to the local network and serial communications.
- **Wide Area Network (WAN) Control**—Efficiently controls the displays even at remote sites through WAN such as Internet.
- **Automatic Search for displays on the Same Network**—Automatically searches, adds, and manages displays connected to the same network such as HP Network Sign Manager.
- **Self-diagnosis**—Checks the failure of the connected displays in real time.
- **Power on/off Scheduling and Input Signal Settings**—Sets the display to be turned on/off the automatically and sets an input signal to be applied when the display is turned on.
- **Easy Tile Mode** —Allows to set the tile mode with the easy-to-use and intuitive GUI design.
- **Firmware Upgrade via LAN**—Updates the display firmware easily via network.
- **Instant Messaging**—Allows to display a message you want on the screen.
- **Log History**—Logs and manages all events that occur in the HP Network Sign Manager solution.
- **Alarm**—Automatically sends an alert message to the administrator if any problem occurs on the display.

2nd Draft

Environment setup

The HP Network Sign Manager environment setup refers to connecting your signage display and the HP Network Sign Manager program to the network. There are three networking methods supported for the HP Network Sign Manager network setup:

- Local Area Network (LAN)
- Wide Area Network (WAN)
- RS-232 Serial Communication

Connecting a display via LAN or WAN

You can connect the display to the network directly or indirectly via a router, hub, or switch. Connect the network cable that is connected to the LAN or WAN to the Ethernet port on the signage display.

Figure 6-1 Connecting a display via LAN or WAN [Author note:]Include this graphic from eZ-Net Manager?



Setting IP address to the network display

Once the network cable is connected, set an IP address of the signage display to complete the network connection.

Follow the steps below to set an IP address of the display:

1. Go to **Menu** on the display, and then select **Option**.
2. In the **Option** dialog, select **Interface Select**, and then select **Network**.



[Author note:]Need screen shot

3. In the **Option** dialog, select **Network Setup**. Select how to assign an IP address under **IP Mode**. You can assign an IP address either manually or using DHCP connection.
 - If you choose to use the DHCP connection:
 - a. Click **Apply** to assign an IP address automatically.
 - b. Click **Close** to complete the IP address configuration.
 - If you choose to assign manually:
 - a. Configure an IP address, subnet mask, gateway, and DNS server address.
 - b. Click **Apply** to save the IP address configuration.
 - c. Click **Close** to complete the IP address configuration.
4. Return to the **Option** dialog, select **Information**, and then select **IP Address** to check whether the IP address is properly assigned.

2nd Draft

Connecting a display via RS-232-C serial port

Directly connect the display to the media player/computer where HP Network Sign Manager is installed using an RS-232-C cable (sold separately). To connect more than one display to the media player/computer, connect the first monitor to the media player/computer with an RS-232-C cable, and then connect the rest of the displays with an RS-232-C cable.

Would this “Connecting ... RS-232-C” section be better placed in the “Connecting to external devices” section?

Figure 6-2 Daisy chain connection—RS-232-C



NOTE: The number of displays that can be connected by daisy chain to one media player/computer might vary depending on the signal status and cable loss. If the signal status is good, and there is no cable loss, it is possible to connect up to twenty-five displays in a daisy chain from one media player/computer.

2nd Draft

HP Network Sign Manager installation

Install HP Network Sign Manager on the media player/computer to be connected with the display and to the network. HP Network Sign Manager installed on your media player/computer allows you to control the display options and playback schedule.

Installing HP Network Sign Manager

1. Insert the HP Software and Documentation CD, that comes with the display, into the CD-ROM. The **HP Network Sign Manager Installation** screen appears.
2. From the Home screen, select **HP Network Sign Manager & Guide**. The **HP Network Sign Manager & Guide** screen appears.
3. Select **HP Network Sign Manager**. The **HP Network Sign Manager Setup: Installation Options** dialog appears.
4. Select shortcut(s) to create during the installation, and then click **Next**. The **HP Network Sign Manager Setup: Installation Folder** dialog appears.
5. Select a folder to install the **HP Network Sign Manager** program. Click **Browse...** to change the installation directory.
6. Click **Install**. The installation of the **HP Network Sign Manager** starts in the selected folder.
7. When the installation is complete, the **HP Network Sign Manager Setup: Installation Completed** dialog appears. Click **Close** to close the dialog.

Removing HP Network Sign Manager

This following describes how to uninstall HP Network Sign Manager from your computer:

1. Click **Start**, click **All Programs**, click **HP Network Sign Manager**, and then select **Uninstall**. The **HP Network Sign Manager Uninstall: Confirmation** dialog appears.
2. Click **Uninstall**. The **HP Network Sign Manager Uninstall: Completed** window appears when the HP Network Sign Manager program is successfully removed.
3. Click **Close** to close the dialog box.

2nd Draft

Quick overview

HP Network Sign Manager is a network-based integrated solution management program supporting various features, including digital signage display control, image/video playback, and remote control.

Home screen









[Author note:]Need screen shot of Home screen



A	Toolbar	Provides functions commonly used in HP Network Sign Manager such as networked display search/connection and communication configuration.
B	Monitor Register Window	Adds and manages networked displays.
C	Control Tab	Controls the settings of the selected display.
D	Control Panel	Displays and configures settings for the selected function in the one of the control tabs.

Toolbar









Table 6-1 Provides functions commonly used in HP Network Sign Manager.[Author note:]Do you want a single graphic with callouts or individual graphics in the left column of the table?

	Search is used to find display(s) that can be connected to the network and add them in the Add Monitor pane. The Search icon is enabled only when the communication configuration of HP Network Sign Manager is set to Ethernet .
	Setting is used to configure the communication method of HP Network Sign Manager. You can choose either Ethernet or serial connection.
	Connect is used to manually connect the selected display. The Connect icon is enabled only when the communication configuration of HP Network Sign Manager is set to Ethernet .
	Refresh is used to refresh the control panel information of HP Network Sign Manager.
	Message is used to display an instant message on the selected display.
	Alarm is used to send an alert message to the administrator if any problem occurs on the display or the network.
	Security is used to change the user ID and password of HP Network Sign Manager.
	Help displays information about the HP Network Sign Manager program.

2nd Draft

Control tab

Table 6-2 The control tabs control the settings of the selected display. [Author note:] Do you want a single graphic with callouts or individual graphics in the left column of the table?

	Information displays information on the hardware, network, status, and failures of the display.
	Control is used to control the power, input, volume, and OSD display settings of the display.
	A/V is used to change the sound and video settings of the display.
	Option is used to change the display of the display and settings of additional functions.
	Schedule is used to configure the timer settings to turn on and off the display.
	Tile is used to connect and set multiple displays.
	USB is used to set the playback schedule for the medial files stored in the USB device.
	Upgrade is used to upgrade the firmware of the display.

2nd Draft

Log-in

The **Log-in** dialog appears when HP Network Sign Manager starts. You must log in to use HP Network Sign Manager.

Enter your ID and password in the **Log-in** dialog, and then click **OK**. Then, you are returned to the main window of HP Network Sign Manager.



 **NOTE:** The **ID** and **password** are case-sensitive.

The default **ID** and **password** for HP Network Sign Manager are “Administrator” and “0000” respectively.

You can change the password.

2nd Draft

Connection settings

HP Network Sign Manager supports both Ethernet and serial communications to connect to the display. The following sections describe how to configure communication in HP Network Sign Manager.

Ethernet communication settings

1. Click **Setting** on the toolbar of HP Network Sign Manager. The **Setting** dialog appears.
2. Select **Network** under **Communication Select**, and then click **OK**.



3. Click **Yes** to confirm and save the settings. The program exits upon confirmation. The new settings will be applied the next time you start the program.

Serial communication settings

1. Click **Setting** on the toolbar of HP Network Sign Manager.



2. Select **Serial** under **Communication Select** dialog. Then, the **Serial Setting** fields become activated.



3. When all fields are filled, click **OK**.

Item	Description
Port	Communication port (COM1 - COM9), Default: COM1
Baud Rate	Communication speed (2400 - 115200), Default: 9600
Data	Communication data (Data5 - Data8), Default: Data8
Parity	Parity check (even, odd, none), Default: none
Stop	The number of stop bits (0 - 1), Default: 1
Flow Control	Data flow (Xon/Xoff, hardware, none), Default: none

4. Click **OK** to confirm and save the settings. The program exits upon confirmation. The new settings will be applied next time you start the program.

 **NOTE:** When you run HP Network Sign Manager for the first time, the communication is set to **Ethernet (Network)** by default.

2nd Draft

Display registration

HP Network Sign Manager allows you to add and manage multiple monitors with both Ethernet and serial communications.

Registering a networked display

The following describes how to add a monitor with Ethernet communication.

1. Click **Search** on the toolbar. The **Signage Monitor Search** dialog appears.



2. Specify a **Search Method** in the **Signage Monitor Search** dialog. There are two search methods:

- **Subnet (Broadcasting)** — Automatically searches monitor(s) on the same local network to which the computer running HP Network Sign Manager is connected.
- **Enter IP address manually** — An IP address for the monitor needs to be entered manually to add it to HP Network Sign Manager. Monitors connected to the external network can also be connected.

 **NOTE:** Sharing the same network means using the same default gateway and subnet host.



3. Click **Search** to search for a monitor. When the search is complete, the **Completed** message appears under **Status**.



4. When the search is complete, click **Close** to close the dialog. You can see the searched monitor(s) added in the Add Monitor pane of the main window.



The added monitor is displayed with three different icons depending on the current status as shown below:

	Successfully connected to HP Network Sign Manager
	Disconnected from HP Network Sign Manager
	When the fan, panel, or temperature is not normal

2nd Draft

Registering a display via serial communication

No extra search for displays is required when they are connected via serial communication using HP Network Sign Manager. All displays connected via serial communication are displayed in the **Add Monitor** pane.



A display connected via serial communication must have an ID assigned. HP Network Sign Manager uses this ID to communicate with the display connected to the computer using the serial cable. To control a monitor, select an ID of the monitor that you wish to control in the **Add Monitor** pane.

 **NOTE:** If you select Monitor 0 in the **Add Monitor** pane, you can control all monitors regardless of the IDs. However, controlling all monitors by selecting Monitor 0 prevents from receiving acknowledgement (ACK) data from the monitors.

2nd Draft

Display and group management

HP Network Sign Manager supports to group and manage the monitors added in the Add Monitor pane.

[Author note:]This sentence is confusing; what should it say?

Making a group

The following describes how to create a monitor group:

1. Right-click the group in the **Add Monitor** pane. The shortcut menu appears.
2. Click **Make Group**. The **Make Group** dialog appears.
3. Enter a group name in the **Make Group** dialog, and then click **Set**.

A new group is created under **Group** in the **Add Monitor** pane.

Adding a display to group

You can add monitors to the group you want and manage them by group.

The following describes how to add monitors to a group:

1. Right-click a monitor to group in the **Add Monitor** pane. The shortcut menu appears.
2. Click **Add to Group** from the shortcut menu. The **Group Selection** dialog appears.
3. Select a group to which the monitor is to be added under **Group List**.

The monitor is now added to the selected group.

 **NOTE:** Alternatively, you can simply drag and drop a monitor to the group you want in the **Add Monitor** pane.

Viewing group information

If you select a group in the **Add Monitor** pane, you can see a summary of all monitors included in the group.



A	Status	Displays the network connection status of the monitors included in the selected group.
B	IP Address	Displays the IP address of the monitors included in the selected group.
C	Tag	Displays the tag of the monitors included in the selected group. This field appears as "- - -" if the monitor tag is not specified.
D	Power	Displays the power on/off of the monitors included in the selected group.
E	Input	Displays the input settings of the monitors included in the selected group.
F	Signal	Displays the signal status of the monitors included in the selected group.

2nd Draft

G	FAN	Displays the fan settings of the monitors included in the selected group.
H	LAMP	Displays the lamp settings of the monitors included in the selected group.
I	Temp	Displays the temperature settings of the monitors included in the selected group.

Deleting a group

You can delete a monitor and group added in the **Add Monitor** pane. The following sections describe how to delete a monitor and group.

Deleting a group

1. Right-click a group to delete. The shortcut menu appears.
2. Click **Remove Group** from the shortcut menu. The selected group is now deleted.

Deleting a display from a group

1. Right-click a monitor to delete from a group. The shortcut menu appears.
2. Click **Remove Monitor** from the shortcut menu. The selected monitor is now deleted from the group.

Deleting a display

You can completely delete a monitor added in the **Add Monitor** pane.

The following describes how to completely delete a monitor from the **Add Monitor** pane:

1. Right-click a monitor to delete under the **Single** node. The shortcut menu appears.
2. Click **Remove Monitor** from the shortcut menu. The selected monitor is now deleted.

 **NOTE:** Deleting a monitor under **Single** in the **Add Monitor** pane will also delete the same monitor added in the group.

Adding a tag to a display

By default, displays added in the **Add Monitor** pane have only the IP address displayed. You can also add a tag for each display to identify it easily.

The following describes how to add a tag to a display:

1. Right-click a display to add a tag. The shortcut menu appears.
2. Click **Add Tag**. The **Add Tag** dialog appears.
3. Enter a tag name in the **New Tag** field, and then click **Set**.

You can see the tag is added before the IP address of the display in the **Add Monitor** pane.

2nd Draft

Display configuration

HP Network Sign Manager can remotely control the connected monitors and changes their settings.

Viewing information

You can see details of the display configuration in the **Information** tab.



Display

The **Display** section shows the basic information on the selected display.

Item	Description
Model Name	Name
Serial Number	Serial number
Monitor SW Version	Software version
LAN SW Version	Software version of LAN.

IP Configuration

The **IP Configuration** section allows you to configure a network for the selected display.

Item	Description
IP Configuration Method	IP configuration (DHCP/Static)
Network properties	Network properties

Status

The **Status** section shows the current configuration of the selected display.

Item	Description
Power	Power on/off status
Input	Input setting status
Signal	Signal status
Screen Mute	Screen on/off status
Volume Mute	Sound on/off setting status
Picture Mode	Screen mode status
Aspect	Screen aspect ratio

2nd Draft

Diagnosis

The **Diagnosis** section shows display activities and failures.

Item	Description
FAN	Fan status
Lamp	Lamp status
Power	Power status.
Temperature (inside)	Temperature inside the display



Controlling a display

The **Control** tab allows you to control the selected display.



Power

You can turn the display on or off with a mouse-click under **Power**. The color of the button changes depending on the display status.

Item	Description
	When the display is turned on
	When the display is turned off
	The display is in energy-saving mode

 **NOTE:** When the display is turned off or in energy-saving mode, you can use **Power on, Volume control, Signal check, Fan check, and Lamp check** functions only.

Select Input

Use **Select Input** to select an input type supported in the display.

 **NOTE:** The input type supported in the display might vary depending on the model.

Volume

Volume is used to adjust the position of the slider to set the volume between 0 and 100.

2nd Draft

Screen Mute

Screen Mute is used to turn on or off the screen. Set to **Mute On** to play the sound only (no image/video on the screen).

Volume Mute

Volume Mute is used to turn on or off the sound. Set to **Mute On** to play the image/video only on the screen without sound.

OSD Select

OSD Select is used to turn on or off the OSD (on-screen display) of the display. Set to **OSD Select Off** to not have the OSD appear on the screen.

 **NOTE:** Note that you cannot configure the screen settings with a remote control or key operations of the display when **OSD Select** is set to **Off**.

Configuring audio/video settings

You can change the audio and video settings of the selected display in the **Control** tab.



 **NOTE:** Audio/video setting options might vary depending on the display model.

Picture Mode

Picture Mode is used to set the screen mode.

Backlight

Backlight is used to adjust the position of the slider between 0 and 100 to set the brightness of the screen backlight.

Contrast

Contrast is used to adjust the position of the slider between 0 and 100 to set the contrast of the screen.

Brightness

Brightness is used to adjust the position of the slider between 0 and 100 to set the brightness of the screen.

Color

Color is used to adjust the position of the slider between 0 and 100 to set the color density of the screen.

2nd Draft

Sharpness

Sharpness is used to adjust the position of the slider between 0 and 100 to set the sharpness of the screen.

Color Temperature (White Balance)

Color Temperature (White Balance) is used to change the color temperature of the screen. You can choose one from Normal (6500K), Cool (9300K), and Warm (5000K).

Auto Config

Auto Config is used to automatically configure the screen settings. When the display is connected to the media player/computer with an RGB cable, click the **Set** button to automatically adjust the screen position and minimize the screen flicker.

Sound Mode

Sound Mode is used to set the sound mode of the display.

Auto Volume

Auto Volume is used to turn on/off the auto volume adjustment function. Setting Auto Volume to On will automatically adjust and optimize the display volume.

Balance

Balance is used to control the left and right speaker balance by adjusting the position of the slider between -50 (left) and 50 (right).

Speaker

Speaker is used to turn on or off the display speaker. You can turn off the speaker when connecting an external speaker to the display or when not in use.

Setting screen options

The **Option** tab allows you to change the screen settings of the selected display.



NOTE: Screen setting options might vary depending on the display model.

Aspect Ratio

Aspect Ratio is used to set the aspect ratio of the screen.

ISM Method

ISM Method is used to change the Image Sticking Minimization (ISM) method for the monitor. ISM prevents an image-sticking phenomenon where a frozen still picture displayed on the screen for prolonged periods can result in a ghost image.

2nd Draft

There are four ISM methods available in the display:

Image Sticking Method	Description
Normal	Does not use the ISM method.
White Wash	Refreshes the screen into white to remove the ghost image.
Orbiter	Moves the screen up/down/left/right every 2 minutes to remove the ghost image.
Inversion	Inverts the current screen color to remove the ghost image.

Power indicator

Power Indicator is used to enable or disable the power indicator of the display.

DDC-CI

DDC-CI is used to change the display DDC-CI setting.

DFC

DFC (Digital Fine Contrast)

DPM Select

DPM Select is used to change the display DPM (Dynamic Power Management) setting. Setting **DPM Select** to **On** will automatically switch the display into the energy-saving mode when no image signal is entered to the display.

Remote/Key Lock

Remote/Key Lock is used to lock or unlock the remote control and the keys on the display. Setting **Remote/Key Lock** to **Lock On** will disable the remote control and keys on the display, preventing you from controlling the display.

Sleep Timer

Sleep Timer is used to set the timer to go to the sleep mode. Once the specified time passes, the display turns off automatically.

Auto Off

Auto Off is used to enable or disable the auto power off function. Setting **Auto Off** to **On** will turn off the display if no image signal is detected for 10 minutes.

Power On Delay

Power On Delay is used to adjust the slider between 0 and 100 to set the delay time before turning the display on. When turning more than one display at the same time, set Power On Delay of each display to be different from each other to protect from overload.

2nd Draft

Energy Saving

Energy Saving is used to change the energy-saving mode.

Factory Reset

Factory Reset is used to reset the display to the factory default settings. Be careful with this option because all settings will be reset.

Scheduling

The **Schedule** tab allows you to schedule the power on and off of the display.



Clock

Clock is used to set the current time of the display.

- Select hour/minute/day, and then click **Set** to complete the time setting.
- Click **Set by PC Time** to synchronize the clock of the display to the clock of the computer where HP Network Sign Manager is installed.

Time Schedule Setting

Time Schedule Setting is used to schedule the power on/off of the display.

The following describes how to schedule the power on/off of the display:

1. Select an option in the **Repeat Set** drop-down list to set the power on/off schedule. You can set it to Daily, Monday to Friday, Monday to Saturday, Saturday to Sunday, or day of week.
2. Set both **On Time** (time to turn the display on) and **Off Time** (time to turn the display off). You can specify **On Time** and **Off Time** separately by selecting each checkbox as shown below.
3. Set an input setting to use when the display is turned on. Selecting **No change** will keep the last input setting.
4. Check whether the monitor On/Off Time settings are correct, and then click **Set** to save the changes. You can see your display on/off schedule added under **On/ Off Time Schedule Info**.

On/Off Time Schedule Info

On/Off Time Schedule Info is used to check and manage the power on/off schedule of the display.

- To delete the on/off schedule of the selected display, select a schedule (time) to delete, and then click **Delete**. The on/off schedules of all selected displays are deleted.
- To delete all schedules, select a list to delete, and then click **Delete All**. All the selected display on/off times are deleted.

2nd Draft

Saving and loading display configuration

All display settings set in HP Network Sign Manager can be saved as a file. You can import the saved settings later when necessary.

Saving display configuration

The following describes how to save the current display settings:

1. Right-click a display for which the settings are to be saved.
2. Click **Save Configuration** from the shortcut menu. The **Save As...** dialog appears.
3. Enter a file name, and then click **Save**. The **Finish Save Configuration** message appears when it is successfully saved.

Loading display configuration

You can import (load) the saved settings to restore the display settings easily.

The following describes how to import the saved display settings.

1. Right-click a display for which the settings are to be imported and restored.
2. Click **Load Configuration** from the shortcut menu. The **Open** dialog appears.
3. Select the display settings file to import, and then click **Open**. The selected settings are imported for the display, and the **Load Configuration Status** dialog shows the progress. The **Configuration load complete** message appears when they are successfully imported.

2nd Draft

Tile Mode

The Tile mode allows you to connect more than one display and play a single media file simultaneously from these connected displays.

Creating a tile mode

1. Select the **Tile** tab. The **Tile Mode Wizard** appears as shown below.
2. To create a new tile mode, select **Create Tile Mode**. To modify a previous tile mode, select **Adjust Tile Mode**.
3. Select the number of columns and rows to create for the tile mode.
4. Select a display group to apply the tile matrix, and then click **Set**. The **Set** button is enabled only when a display group is selected. Click **Next**.

 **NOTE:** The tile size cannot exceed the maximum number of displays connected. A group of displays must be properly configured in advance. The maximum size of tile mode supported is 5 x 5.

5. Assign a tile **ID** to each display of the group that you chose for the tile mode. This tile **ID** helps you to identify the displays within the group. The display tile IDs are numbered from top-left (1 - 25). Click **Next**.
6. Set an input signal to use for each display within the group. The input signal type for each display can be different within the same group.
7. Check whether the the display ID, tile ID, input signal type, and tile size are set correctly, and then click **Apply**.
8. Click **OK** to confirm and exit the **Tile Mode Wizard**.

Modifying a tile mode

The following describes how to modify the previous tile mode.

1. Select the **Tile** tab. The **Tile Mode Wizard** appears.
2. To modify a previous tile mode, select **Adjust Tile Mode**. The **Tile Mode Summary** dialog appears.
3. Modify the tile mode as necessary.

2nd Draft

Schedule and Playback contents (USB)

This function allows you to set the playback schedule of HP Network Sign Manager. All files to play should be saved in a separate USB device and then connected to the USB port on the display. The playback schedule can be set to weekday, weekend, day of week, or daily.

Scheduling the playback of files

Set the playback schedule of HP Network Sign Manager.

USB Schedule

USB Schedule allows you to schedule the playback of media files saved in the USB device connected to the display. **USB Schedule** has three sections: **File List**, **Schedule List**, and **Repeat Set**.



File List	Lists the media files in the USB device connected to the display. <ul style="list-style-type: none">• Select All—Selects all media files in File List.• Clear All—Deselects all media files in File List.• Add Schedule List—Adds the selected file to Schedule List.
Schedule List	Lists the media files to play on the display. <ul style="list-style-type: none">• Up—Moves up the selected file in Schedule List.• Down—Moves down the selected file in Schedule List.• Delete—Removes the selected file from Schedule List.• Delete All—Removes all files from Schedule List.
Repeat Set	Schedules the playback time (duration) of the media file(s). <ul style="list-style-type: none">• Repeat Set—Schedules the playback of media files.

There are 12 options of repetition playback.

Repetition option	Description
Always	Plays the file all the time. You do not need to set a specific playback schedule with this option.
Daily	Plays the file everyday for the specified time period.
Mon–Fri	Plays the file for the specified time period from Monday to Friday.
Mon–Sat	Plays the file for the specified time period from Monday to Saturday.
Sat–Sun	Plays the file for the specified time period from Saturday to Sunday.
Sun	Plays the file for the specified time period on Sunday.

2nd Draft

Repetition option	Description
Mon	Plays the file for the specified time period on Monday.
Tue	Plays the file for the specified time period on Tuesday.
Wed	Plays the file for the specified time period on Wednesday.
Thu	Plays the file for the specified time period on Thursday.
Fri	Plays the file for the specified time period on Friday.
Sat	Plays the file for the specified time period on Saturday.

- **Apply**—Saves the playback schedule.
- **Cancel**—Deletes the current playback schedule set for the display.
- **Option**—Sets the playback schedule option
- **Back**—Moves back to the USB function selection view.

Saving files in the USB device

Before you schedule the playback of files, all media files to play on the display should be saved in the USB device separately. Use the Windows Explorer to save the media files to your USB device.

The following describes how to save media files directly to the USB device:

1. Connect the USB device to the media player/computer. When the USB device appears in the **My Computer** window, double-click the USB device.
2. Copy the media file(s) to play to the USB root directory.

 **NOTE:** The media files should be saved to the USB root directory; otherwise, HP Network Sign Manager will not be able to load them.

 **NOTE:** HP Network Sign Manager supports the following media file formats—Image: jpg / Video: avi / Music: mp3. When playing media files on the USB device, you can use Power on, Power off, Volume mute, Volume control, and self diagnosis (FAN, LAMP).

Scheduling the playback of files

The following describes how to schedule the playback of files using the **USB Schedule** function:

1. Connect the USB device to the display and turn on the display.
2. Select the display to which the USB device is connected in the **Add Monitor** pane, and then select the **USB** tab. The USB function selection view appears in the control panel.
3. Click **USB Schedule**. The **USB Schedule** view appears, and the files saved in the USB device are displayed in **File List**.

 **NOTE:** **File List** does not display the files with invalid formats which are not supported by HP Network Sign Manager, or the files not located in the USB root directory. Up to 31 characters are allowed for the file name. Up to 80 files are added to the file list.

2nd Draft

4. Select the file(s) to schedule the playback, and then click **Add Schedule List**. The files are now added to **Schedule List**. Use **Select All** and **Clear All** to easily select and deselect the files.
5. Change the playback order of the files in **Schedule List** using **Up** and **Down**.
6. Set the playback schedule option.
7. Set the playback start and end times between 00:00 and 23:59.

 **NOTE:** You do not have to set the playback duration if **Repeat Set** is set to **Always**.

8. Click **Option** to adjust the slide time interval and the aspect ratio. Select one of the options in the **Slide Time** drop-down list. You can set the slide time to 5, 10, or 30 seconds, and 1, 5, 10, 30, or 60 minutes. Use the **Aspect** drop-down list to adjust the aspect ratio of photos and movies. Select **Original** to keep the original aspect ratio; select **Full** to view in full screen mode.
9. Click **Apply** to complete the playback schedule. The media files will be played on the display according to the playback schedule.

USB Export

Use the **USB Export** function when the HP Network Sign Manager mediaPlayer/computer does not have a network connection to the display. **USB Export** helps you to move media files and the playback schedules of files to the USB device easily and conveniently. After you export media files and the playback schedules of files to the USB device, the media files will be automatically played on the monitor according to the playback schedule whenever you connect the USB device to the monitor.

Exporting to USB

The following describes how **USB Export** works:

1. Create playlist and the playback schedules of media files.
2. Export media files and the playback schedules of files to the USB device.
3. Connect the USB device to the display. The media files will be automatically played on the display according to the playback schedule.

 **NOTE:** The media files will be automatically played only when the display is turned on.

Saving files and the playback schedules in the USB device

The following describes how to save media files to the USB device using the USB Export function:

1. Connect your USB device and start HP Network Sign Manager.
2. Click the **USB** tab. The USB function selection view appears in the control panel.
3. Click **USB Export**. The USB Export settings appear.
4. Click **File Load**. The **Open** dialog appears.
5. Select a file to save in the USB device, and then click **Open**. The file appears in the list.

2nd Draft

6. Use **Up**, **Down**, **Delete**, and **Delete All** to set the playback order or delete the file(s).

 **NOTE:** Up to 31 characters are allowed for the file name. Up to 80 files are added to the file list.

7. Select an option in the **Repeat Set** drop-down list to set the playback repetition pattern.

8. Set the playback start and end times between 00:00 and 23:59.

 **NOTE:** You do not have to set the playback duration if **Repeat Set** is set to **Always**.

9. Click **Export**. The .tll file containing the selected file(s) and the playback schedule is now saved to the USB device.

10. When successfully saved, click **Back** to go back to the main window.

2nd Draft

Toolbar

The toolbar has a collection of useful functions.



Search

Search searches the display(s) connected to the network and adds them.

 **NOTE:** Displays connected to serial communication will not be detected.

Setting

Setting allows you to set a communication method to connect to the signage display. You can select either Ethernet (Network) or RS-232 serial communication depending on your environment.

 **NOTE:**

Ethernet Network

To use Ethernet (network) communication:

1. Under **Communication Select**, select **Network**.
2. Click **OK** to complete.

RS-232C Serial Communication

To use RS-232-C serial communication:

1. Under **Communication Select**, select **Serial**. Adjust the serial communication settings to fit your environment.

Item	Description
Port	Communication port (COM1 - COM9), Default: COM1
Baud Rate	Communication speed (2400 - 115200), Default: 9600
Data	Communication data (Data5 - Data8), Default: Data8
Parity	Parity check (even, odd, none), Default: none
Stop	The number of stop bits (0 - 1), Default: 1
Flow Control	Data flow (Xon/Xoff, hardware, none), Default: none

2. Click **OK** to complete.

Connect

Connect is used to reconnect the display to the network manually when the display is disconnected.

2nd Draft

The following describes how to reconnect a specified monitor to the network.

1. Select a display or display group to reconnect.
2. Click **Connect**.

 **NOTE:** This function does not support a display connected with serial communication.

Refresh

Refresh is used to refresh the information in the selected control tab. For example, select the **Information** tab, and then click **Refresh**. The information for the selected display or display group is updated.

Similarly, to view the current display settings, select a display, select the **A/V** tab, and then click **Refresh**.

Message

Message is used to display a message you want on the display. You specify a message to be displayed constantly in a specific position of the screen.

 **NOTE:** Up to 60 characters are allowed in the message field. Only alphanumeric characters can be entered.

The following describes how to use the **Message** function:

1. From **Network Communication**, select a display or display group on which you want to display a message.
2. On the toolbar, click **Message**. The **Message Setting** dialog appears.

 **NOTE:** If a display or display group has not been selected, the **Message Setting** dialog does not appear.

3. Set the position, color, and content of the message displayed on the monitor

Item	Description
Message Align	Sets the position where the message is displayed.
Message Color	Selects a color of the message displayed.
Message Send	Enters the content of the message displayed.

4. Click **Send** to send the created message.

Item	Description
Send	Displays the created message on the selected display or display group.
Clear	Clears the text entered in the Message Send field.
Close	Closes the Message Send dialog.

2nd Draft

Alarm

Alarm is used to automatically send an alert email to the administrator if an error is detected during self-diagnosis. This function is activated when:

- The network connection is not normal (except for serial communication).
- An error in the fan, lamp, or temperature is detected during self-diagnosis.
- The ID or password is changed.

Before using this function, you need to configure the SMTP email settings. The following describes how to configure the SMTP email:

1. On the toolbar, select **Alarm**. The **Alarm** dialog appears.
2. To send an alert email automatically to the administrator, set the following fields:

Item	Description
Subject	Enter the subject.
To	Enter the email address of the administrator.
From	Enter the email address of the sender.
SMTP Server	Enter the host name or IP address of the SMTP server to use.

NOTE: HP Network Sign Manager cannot use the **Alert Mail** function if the specified SMTP server requests the ID and password of the email sender.

3. Once all fields are filled, click **Test Email**.
4. Check that the alert email was successfully sent to the email address that you specified.
5. Click **OK** to save the SMTP mailing settings. The **Alert Mail** function is now activated.

Security

Security is used to change the ID and password of the administrator to be used when logging in to HP Network Sign Manager.

The following describes how to change the administrator ID and password:

1. On the toolbar, select **Security**. The **Security Manager** dialog appears.
2. Enter the current administrator ID and password under **Current ID & Password**, and then click **Confirm**.

 **NOTE:** You cannot create a new account if an invalid ID or password is entered. Do not forget that your ID and password are case sensitive.

3. The fields under **New ID & Password** are enabled. Enter a new administrator ID and password that you want to use. Enter the same password again in the **Verify** field.

2nd Draft

 **NOTE:** The default ID and password of HP Network Sign Manager are **Administrator** and **0000** respectively.

4. Click **Change** to apply changes. You should use the changed ID and password the next time that you log into HP Network Sign Manager.

 **NOTE:** If you forgot the ID or password, you should reinstall the HP Network Sign Manager program to reset the administrator account.

Help

Help displays information about the HP Network Sign Manager program.

2nd Draft

Log history

All events that occurs in HP Network Sign Manager, including button operations, network connection history, and display failures, are automatically saved in a log file.

Log data

Item	Description
Date	The date when the event is generated.
Time	The time when the event is generated.
IP Address	The IP address of the display from which the event is generated.
Operation	The operation when the event is generated.

Log file name and location

The log file is saved in the directory where HP Network Sign Manager is installed. The file name might vary from the communication settings of HP Network Sign Manager.

Communication method	File name
For network communication	Network_HistoryReport.txt
For serial communication	Serial_HistoryReport.txt

2nd Draft

Upgrade

HP Network Sign Manager supports firmware upgrades for the display.

The following describes how to upgrade the display firmware in HP Network Sign Manager:

1. Under **Add Monitor**, click a display for which the firmware is to be upgraded.
2. Click the **Upgrade** tab.
3. In the **Upgrade Item** drop-down list, select the device to upgrade.
 - **Ethernet**—Firmware for the Ethernet network card installed in the display
 - **Monitor**—Firmware for the display
4. Under **Selected Upload File**, click **Upload**. The **Open** dialog appears.
5. Select a firmware to upgrade, and then click **Open**.
6. Under **Progress** to start upgrading, click **Start**. The firmware upgrade progress appears. The **Download Complete** message appears when the upgrade is complete.
7. Click **OK** to complete the firmware upgrade.

2nd Draft

A Troubleshooting

Solving common problems

The following table lists possible problems, the possible cause of each problem, and the recommended solutions.

Problem	Possible cause	Solution
No image is displayed.	Power cord is not connected.	<p>Be sure the power cord is properly connected to the outlet.</p> <ul style="list-style-type: none"> • Verify that the outlet has power to it. • Check that the fuse or breaker has not tripped or burned out. <p>See if the power switch is turned on.</p> <p>Might need service.</p>
Power is on, power indicator is blue, but the screen appears extremely dark.	Screen needs adjustment.	<p>Adjust brightness and contrast again.</p> <p>Backlight might need repair.</p>
Power indicator is amber.	Display is in power saving mode.	<p>Move the mouse or press any key on the keyboard.</p> <p>Turn off equipment and then back on.</p>
Out of Range message appears.	Input signal is out of frequency range.	<p>The signal from the media player/computer (video card) is out of the vertical or horizontal frequency range of the display. Adjust the frequency range by referring to the specifications in this manual (maximum resolution: RGB—1920 x 1080 @ 60 Hz; HDMI—1920 x 1080 @ 60 Hz).</p> <p>NOTE: Vertical Frequency - to enable the user to watch the display display, the screen image should change multiple times every second like a fluorescent lamp. The vertical frequency or refresh rate is the number of times the image displays per second. The unit is measured in Hz.</p> <p>Horizontal Frequency - the horizontal interval is the time to display one vertical line. When 1 is divided by the horizontal interval, the number of horizontal lines displayed every second can be tabulated as the horizontal frequency. The unit is measured in kHz.</p>
Check signal cable message appears.	Signal cable is not connected.	<p>The signal cable between the media player/computer and display is not connected.</p> <p>Make sure that the signal cable is properly connected.</p> <p>Press the INPUT button on the remote control to check the input signal.</p>

2nd Draft

Problem	Possible cause	Solution
Unknown Product message appears when the display is connected.	Display driver is not installed.	<p>Install the display driver, which is provided with the display or download from the HP website www.hp.com.</p> <p>See if the Plug and Play function is supported by referring to the video card user manual.</p>
Key Lock On message appears when pressing the Menu button.	Key Lock function is turned on.	The control locking function prevents unintentional OSD setting changes. To unlock the controls, simultaneously press the Menu button and right arrow ► button for several seconds. (You cannot set this function using the remote control buttons. You can set this function with the display only.)
The screen looks abnormal; screen position is wrong.	Screen is out of adjustment.	<p>D-sub analog signal - press the AUTO button on the remote control to automatically select the optimal screen status that fits into the current mode.</p> <p>Check that the video card resolution and frequency are supported by the display. If the frequency is out of range, set to the recommended resolution in the Control Panel → Display → Settings of the operating system.</p>
Lines appear on the background screen.	Screen is out of adjustment.	D-sub analog signal - press the AUTO button on the remote control to automatically select the optimal screen status that fits into the current mode.
Horizontal noise appears or the characters look blurred.	Screen is out of adjustment.	D-sub analog signal - press the AUTO button on the remote control to automatically select the optimal screen status that fits into the current mode.
The screen displays abnormally.	Using an incorrect input signal.	The proper input signal is not connected to the signal port. Connect the signal cable that matches with the source input signal.
An after image appears when the display is turned off.	Using a fixed image that is too long.	If you used a fixed image for a long time, the pixels might be damaged. Use a screen-saver function or set the OSD menu to the ISM Method .
No sound.	Audio cable not connected.	<p>Check that the audio cable is properly connected.</p> <p>Adjust the volume.</p> <p>Check if the sound is set properly.</p>
Sound is too dull.	Equalizer is not balanced.	Select the appropriate sound equalize.
Sound is too low.	Sound needs adjusting.	Adjust the volume by pressing the volume buttons on the remote control.
Screen has poor color resolution (16 colors).	Color is not set correctly.	Set the number of colors to more than 24 bit (true color). Select Control Panel → Display → Settings → Color quality in the operating system.
Screen color is unstable or mono colored.	Signal cable or video card connection is loose.	Check the connection status of the signal cable, or reinsert the media player/computer video card.

2nd Draft

Problem	Possible cause	Solution
Black spots appear on the screen.	Black spots are characteristics of the LCD panel.	Several pixels (red, green, white, or black color) might appear on the screen, which can be attributable to the unique characteristics of the LCD panel. It is not a malfunction of the LCD.
The power is suddenly turned off.	Sleep timer setting is turned on, or power is interrupted.	Check that the sleep timer is set. Check the power control settings. If power is turned off after the message, CAUTION! FAN ERROR! appears, the fan is out of order. Contact your local service center.

Using the Web

For online access to technical support information, self-solve tools, online assistance, community forums of IT experts, broad multi-vendor knowledge base, monitoring and diagnostic tools, go to www.hp.com/support

Preparing to call technical support

If you cannot solve a problem using the troubleshooting tips in this section, you might need to call technical support. Contact your regional HP authorized service provider. Have the following information available when you call:

- Display model number
- Serial number for the display
- Purchase date on invoice
- Conditions under which the problem occurred
- Error messages received
- Hardware configuration
- Hardware and software you are using

2nd Draft

2nd Draft

B Technical specifications

 **NOTE:** All performance specifications are provided by the component manufacturers. Performance specifications represent the highest specification of all HP's component manufacturers' typical level specifications for performance and actual performance might vary either higher or lower.

HP Digital Signage Display

Table B-1 Specifications

		HP LD4201	HP LD4210	HP LD4710
Display	Size	106.73 cm (42 in)	106.73 cm (42 in)	119.28 cm (47 in)
	Type	TFT LCD panel	TFT LCD panel	TFT LCD panel
Viewable image size		106.73 cm (42 in) diagonal	106.73 cm (42 in) diagonal	119.28 cm (47 in) diagonal
Pixel pitch		0.4845 x 0.4845 mm (0.0191 x 0.0191 in) X RGB	0.4845 x 0.4845 mm (0.0191 x 0.0191 in) X RGB	0.5415 x 0.5415 mm (0.0213 x 0.0213 in) X RGB
Weight—maximum	Without stand and speaker	18.6 kg (41.01 lbs)	18.6 kg (41.01 lbs)	22.7 kg (50.05 lbs)
	With speaker	19.3 kg (42.55 lbs)	19.3 kg (42.55 lbs)	23.4 kg (51.59 lbs)
	With stand	21.9 kg (48.28 lbs)	21.9 kg (48.28 lbs)	26.0 kg (57.32 lbs)
	With stand and speaker	22.6 kg (49.82 lbs)	22.6 kg (49.82 lbs)	26.7 kg (58.86 lbs)
Dimensions (W x H x D)	Without stand and speaker	96.71 x 55.98 x 12.37 cm (38.07 x 22.04 x 4.87 in)	96.71 x 55.98 x 12.37 cm (38.07 x 22.04 x 4.87 in)	107.95 x 62.46 x 12.29 cm (42.50 x 24.59 x 4.84 in)
	With speaker	96.71 x 55.98 x 12.37 cm (38.07 x 22.04 x 4.87 in)	96.71 x 55.98 x 12.37 cm (38.07 x 22.04 x 4.87 in)	107.95 x 62.46 x 12.29 cm (42.50 x 24.59 x 4.84 in)
	With stand	96.71 x 63.50 x 25.86 cm (38.07 x 25 x 10.18 in)	96.71 x 63.50 x 25.86 cm (38.07 x 25 x 10.18 in)	107.95 x 69.77 x 29.83 cm (42.50 x 27.47 x 11.7 in)
	With stand and speaker	96.71 x 63.50 x 25.86 cm (38.07 x 25 x 10.18 in)	96.71 x 63.50 x 25.86 cm (38.07 x 25 x 10.18 in)	107.95 x 69.77 x 29.83 cm (42.50 x 27.47 x 11.7 in)
Power	Rated voltage	AC 100-240 V~50/60 Hz 2.2 A	AC 100-240 V~50/60 Hz 2.2 A	AC 100-240 V~50/60 Hz 2.2 A
		Japan: AC 100 V~50/60 Hz 2.2 A	Japan: AC 100 V~50/60 Hz 2.2 A	Japan: AC 100 V~50/60 Hz 2.2 A

2nd Draft

Table B-1 Specifications (continued)

		HP LD4201	HP LD4210	HP LD4710
Power consumption	On mode	220 W Typical	220 W Typical	270 W Typical
	Sleep mode	≤ 1 W (RGB) / 2 W (HDMI/DVI)	≤ 1 W (RGB) / 2 W (HDMI/DVI) (if LAN OFF is selected)	≤ 1 W (RGB) / 2 W (HDMI/DVI) (if LAN OFF is selected)
Resolution— maximum	RGB	1920 x 1080 @ 60 Hz	1920 x 1080 @ 60 Hz	1920 x 1080 @ 60 Hz
	HDMI/DVI	1920 x 1080 @ 60 Hz (if supported by OS or video card type)	1920 x 1080 @ 60 Hz (if supported by OS or video card type)	1920 x 10800 @ 60 Hz (if supported by OS or video card type)
	DisplayPort	1920 x 1080 @ 60 Hz (if supported by OS or video card type)	1920 x 1080 @ 60 Hz (if supported by OS or video card type)	1920 x 1080 @ 60 Hz (if supported by OS or video card type)
Resolution— recommended	RGB	1920 x 1080 @ 60 Hz	1920 x 1080 @ 60 Hz	1920 x 1080 @ 60 Hz
	HDMI/DVI	1920 x 1080 @ 60 Hz (if supported by OS or video card type)	1920 x 1080 @ 60 Hz (if supported by OS or video card type)	1920 x 1080 @ 60 Hz (if supported by OS or video card type)
	DisplayPort	1920 x 1080 @ 60 Hz (if supported by OS or video card type)	1920 x 1080 @ 60 Hz (if supported by OS or video card type)	1920 x 1080 @ 60 Hz (if supported by OS or video card type)
Horizontal frequency	RGB	30–83 kHz	30–83 kHz	30–83 kHz
	HDMI/DVI	30–83 kHz	30–83 kHz	30–83 kHz
	DisplayPort	30–83 kHz	30–83 kHz	30–83 kHz
Vertical frequency	RGB	56–75 Hz	56–75 Hz	56–75 Hz
	HDMI/DVI	56–60 Hz	56–60 Hz	56–60 Hz
	DisplayPort	56–60 Hz	56–60 Hz	56–60 Hz
Synchronization type	Composite/Separate/Digital	Composite/Separate/Digital	Composite/Separate/Digital	
Input connector	15-pin D-Sub type, HDMI/DVI (digital), RS-232C, DisplayPort, USB	15-pin D-Sub type, HDMI/DVI (digital), RS-232C, DisplayPort, USB, LAN	15-pin D-Sub type, HDMI/DVI (digital), RS-232C, DisplayPort, USB, LAN	
Environmental conditions	Operating temperature	0° to 40°C	0° to 40°C	0° to 40°C
		Humidity 10% to 80%	Humidity 10% to 80%	Humidity 10% to 80%
	Storage temperature	–20° to 60°C	–20° to 60°C	–20° to 60°C
		Humidity 20% to 80%	Humidity 20% to 80%	Humidity 20% to 80%

2nd Draft

Table B-1 Specifications (continued)

		HP LD4201	HP LD4210	HP LD4710
Audio (select models)	RMS audio output	10 W + 10 W (R + L)	10 W + 10 W (R + L)	10 W + 10 W (R + L)
	Input sensitivity	0.7 Vrms	0.7 Vrms	0.7 Vrms
	Speaker impedance	8 Ohms	8 Ohms	8 Ohms

2nd Draft

HP LD4201 and HP LD4210 dimensions

Figure B-1 HP LD4201 and HP LD4210—Front and side view

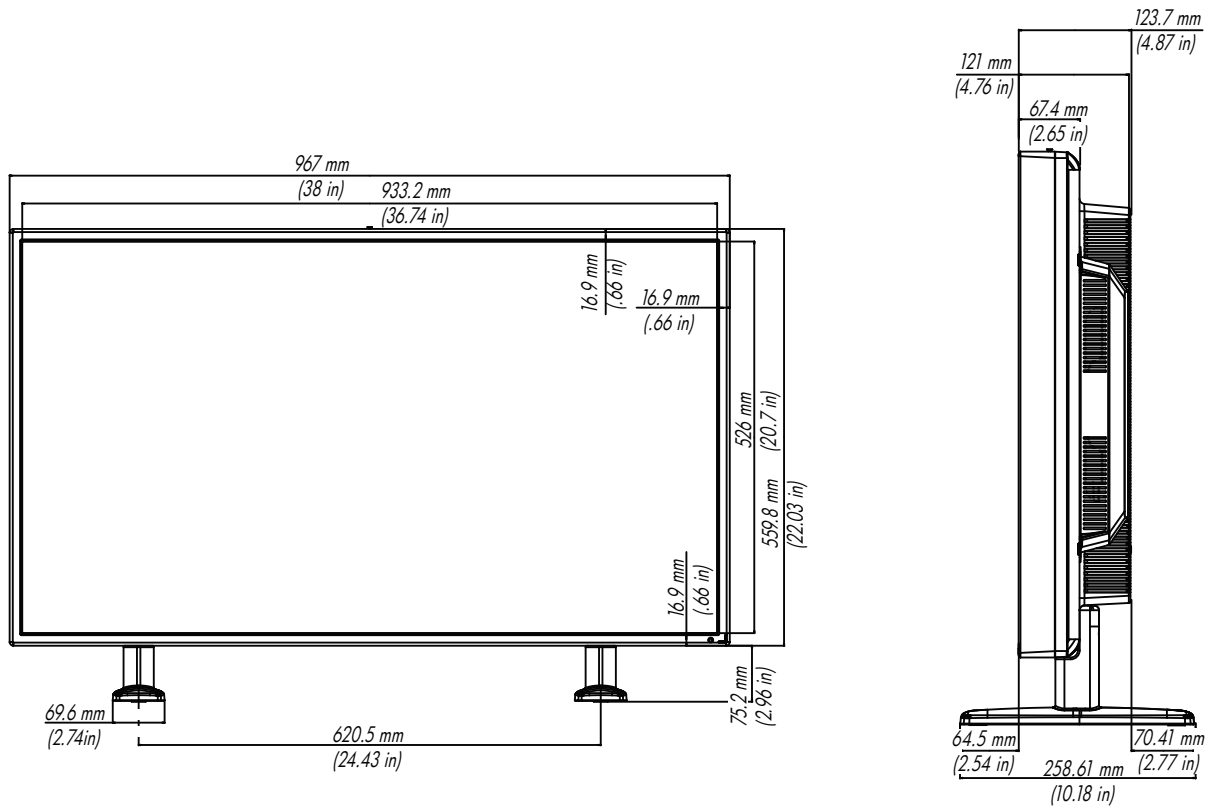
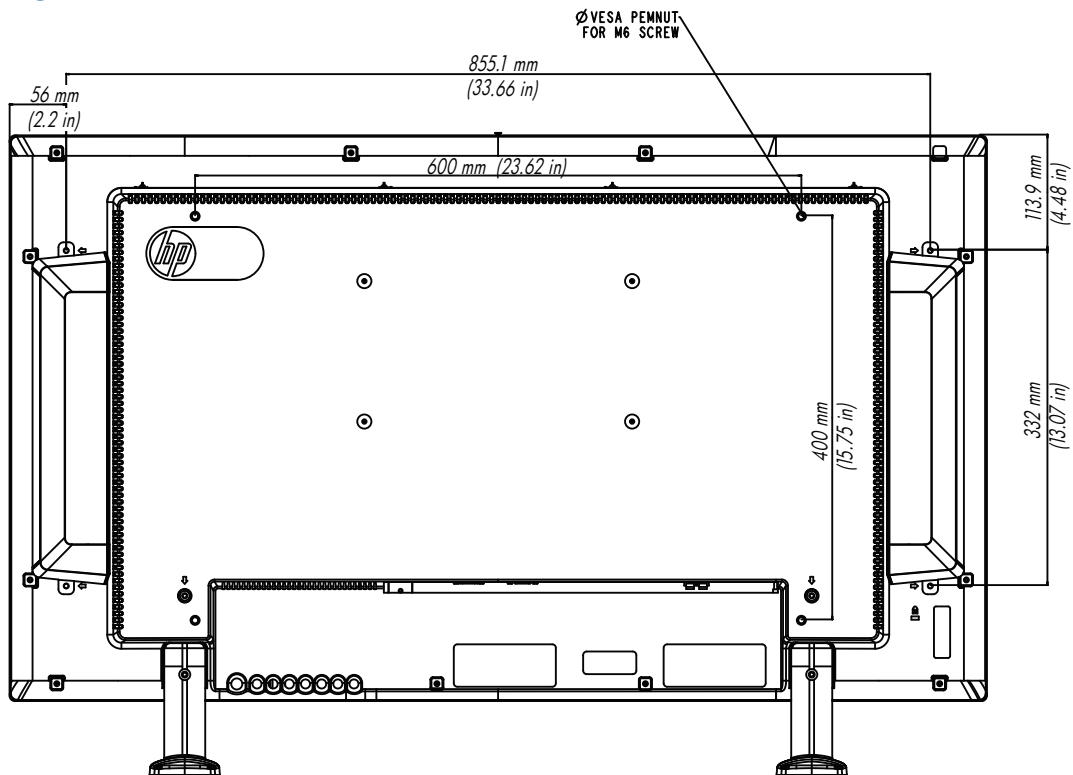

Figure B-2 HP LD4201 and HP LD4210—Back view



2nd Draft

HP LD4710 dimensions

Figure B-3 HP LD4710—Front and side view

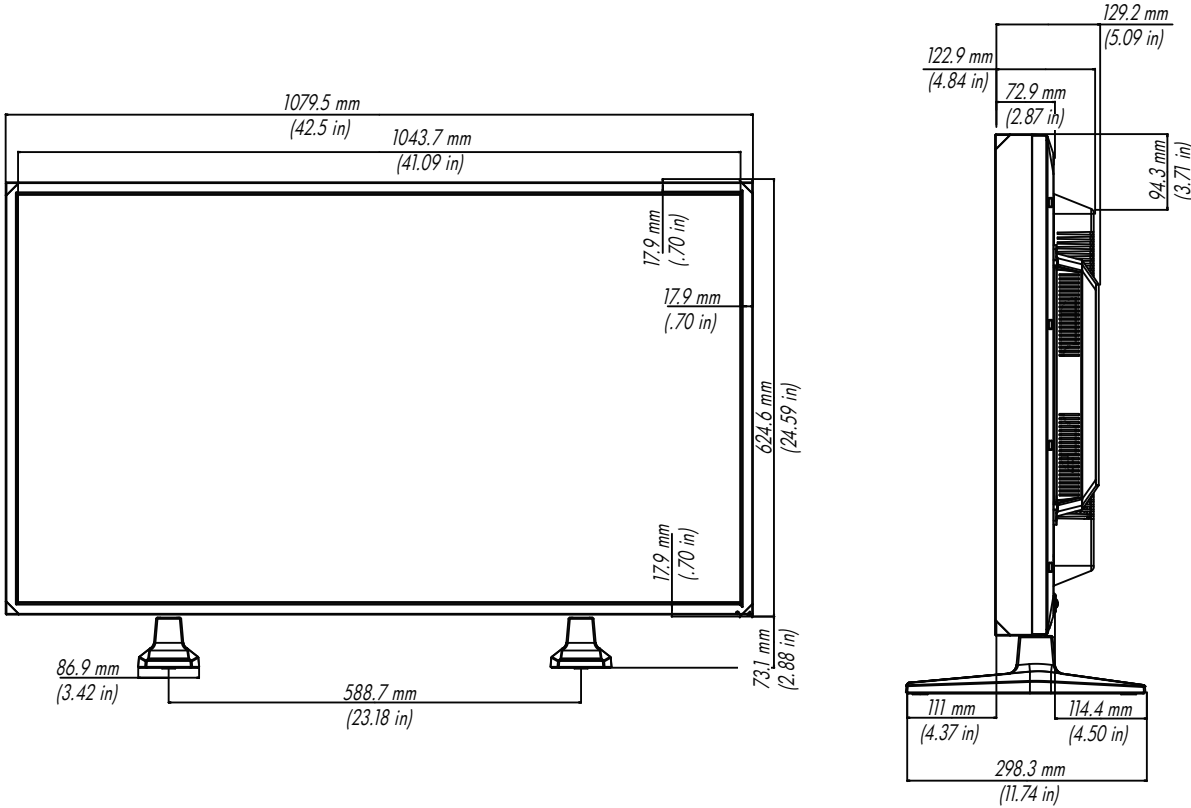
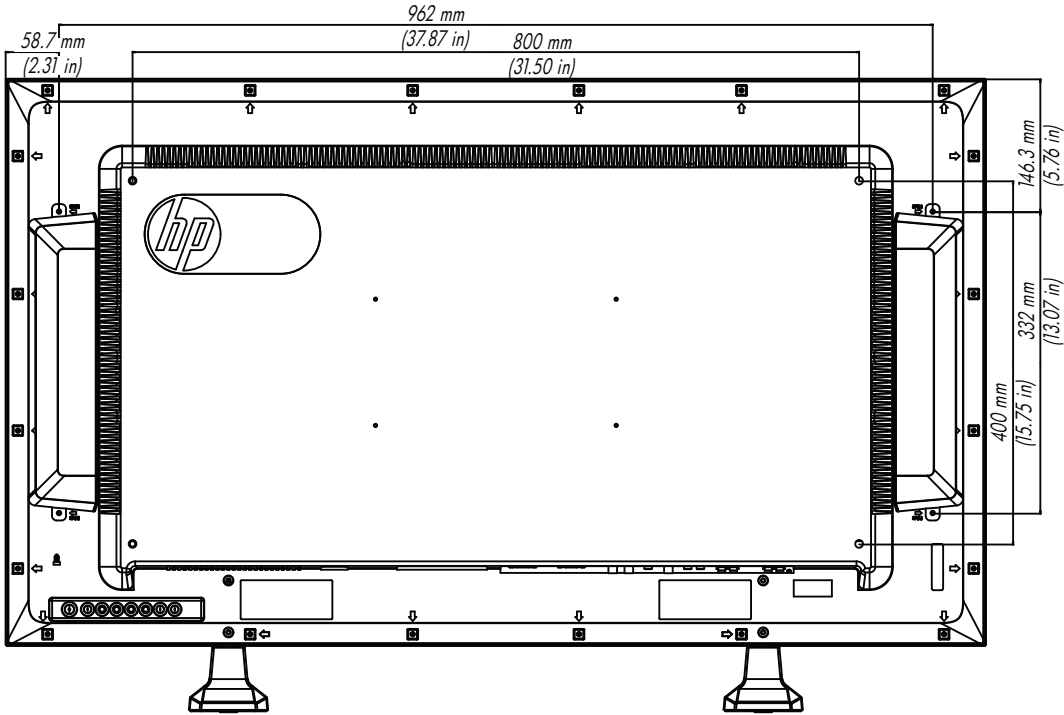

Figure B-4 HP LD4710—Back view



2nd Draft

Recognizing preset display resolutions

The display resolutions listed below are the most commonly used modes and are set as factory defaults. This display automatically recognizes these preset modes and they will appear properly sized and centered on the screen.

Preset display modes

Table B-2 Factory preset display modes

Preset	Pixel format	Horizontal frequency (kHz)	Vertical Frequency (Hz)
1	640 x 350	31.469	70.8
2	720 x 400	31.468	70.8
*3	640 x 480	31.469	59.94
4	640 x 480	37.5	75
*5	800 x 600	37.879	60.317
6	800 x 600	46.875	75
7	832 x 624	49.725	74.55
*8	1024 x 768	48.363	60
9	1024 x 768	60.123	75.029
*10	1280 x 720	44.772	59.855
*11	1280 x 768	47.7	60
*12	1360 x 768	47.72	59.799
*13	1360 x 768	47.7	60
*14	1280 x 1024	63.981	60.02
15	1280 x 1024	79.98	75.02
*16	1680 x 1050	65.290	59.954
*17	1920 x 1080	67.5	60
1 to 17 RGB mode			
* HDMI/DVI mode			

DTV mode

	HDMI/DVI (DTV)	DisplayPort
480i	x	x
480p	o	o
576i	x	x

2nd Draft

	HDMI/DVI (DTV)	DisplayPort
576p	o	o
720p	o	o
1080i	o	o
1080p	o	o

 **NOTE:** DTV/PC selection on HDMI/DVI inputs is available for media player/computer resolutions—640 x 480/60 Hz, 1280 x 720/60 Hz, 1920 x 1080/60 Hz and DTV resolutions—480p, 720p, 1080p.

Power indicator

Mode	LED indicator light
On Mode	Blue
Sleep Mode	Amber
Off Mode	-

2nd Draft

C Command reference

Use this method to connect several displays to a single media player/computer. You can control several displays at a time by connecting them to a single media player/computer.

Connecting the cable

Connect the RS-232-C cable as shown in the following illustration. The RS-232-C protocol is used for communication between the media player/computer and the display. You can turn the display on/off, select an input source or adjust the OSD menu from the media player/computer.

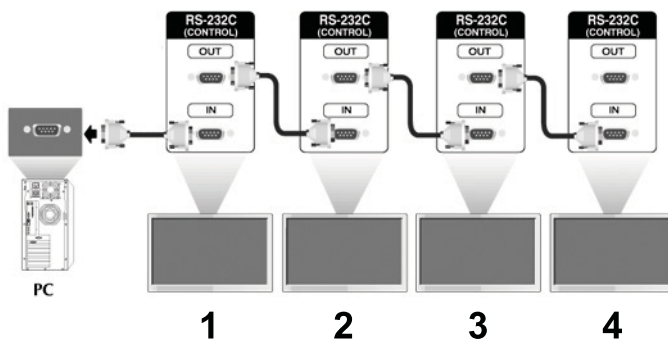

RS-232-C configurations

7-Wire configurations (Standard RS-232-C cable)				3-Wire configurations (Not Standard)			
media player/ computer		Display		media player/ computer		Display	
RXD	2	3	TXD	RXD	2	3	TXD
TXD	3	2	RXD	TXD	3	2	RXD
GND	5	5	GND	GND	5	5	GND
DTR	4	6	DSR	DTR	4	6	DSR
DSR	6	4	DTR	DSR	6	4	DTR
RTS	7	8	CTS	RTS	7	7	CTS

2nd Draft

7-Wire configurations				3-Wire configurations			
(Standard RS-232-C cable)				(Not Standard)			
CTS	8		7	RTS	CTS	8	8 RTS
	D-Sub 9		D-Sub 9		D-Sub 9		D-Sub 9
	(Female)		(Female)		(Female)		(Female)

Communication parameter

- Baud Rate—9600 baud Rate (UART)
- Data Length—8 bit
- Parity Bit—None
- Stop Bit—1 bit
- Flow Control—None
- Communication Code—ASCII code
- Use a crossed (reverse) cable

Command reference list

	COMMAND1	COMMAND2	DATA1	DATA2	DATA3
01. Power	k	a	00H–01H		
02. Input Select	k	b	07H–0BH		
03. Aspect Ratio	k	c	01H–1FH		
04. Screen Mute	k	d	00H–01H		
05. Volume Mute	k	e	00H–01H		
06. Volume Control	k	f	00H–64H		
07. Contrast	k	g	00H–64H		
08. Brightness	k	h	00H–64H		
09. Color	k	i	00H–64H		
10. Tint	k	j	00H–64H		
11. Sharpness	k	k	00H–64H		
12. OSD Select	k	l	00H–01H		
13. Remote Lock/Key Lock	k	m	00H–01H		
14. Balance	k	t	00H–64H		
15. Color Temperature	k	u	00H–02H		

2nd Draft

	COMMAND1	COMMAND2	DATA1	DATA2	DATA3
16. Abnormal State	k	z	FFH		
17. ISM Mode	j	p	01H-08H		
18. Auto Configuration	j	u	01H		
19. Key	m	c	Key Code		
20. Tile Mode	d	d	00H-55H		
21. Tile H Position	d	e	00H-14H		
22. Tile V Position	d	f	00H-14H		
23. Tile H Size	d	g	00H-64H		
24. Tile V Size	d	h	00H-64H		
25. Tile ID Set	d	i	00H-19H		
26. Natural Mode (In Tile Mode)	d	j	00H-01H		
27. Picture Mode (PSM)	d	x	00H-06H		
28. Sound Mode	d	y	01H-05H		
29. Fan Fault Check	d	w	FFH		
30. Elapsed Time Return	d	l	FFH		
31. Temperature Value	d	n	FFH		
32. Lamp Fault Check	d	p	FFH		
33. Auto Volume	d	u	00H-01H		
34. Speaker	d	v	00H-01H		
35. Time	f	a	00H-06H	00H-17H	00H-3BH
36. On Timer (On/Off Timer) Time	f	d	F1H-F4H E0H-E4H 01H-80H	00H-17H	00H-3BH
37. Off Timer (On/Off Timer) Time	f	e	F1H-F4H E0H-E4H 01H-80H	00H-17H	00H-3BH
38. Scheduling Input Select	f	u	F1H-F4H	07H-0BH	
39. Sleep Time	f	f	00H-08H		
40. Auto Sleep	f	g	00H-01H		
41. Power On Delay	f	h	00H-64H		
42. Language	f	i	00H-09H		
43. DPM Select	f	j	00H-01H		

2nd Draft

	COMMAND1	COMMAND2	DATA1	DATA2	DATA3
44. Reset	f	k	00H-02H		
45. Power Saving	f	l	00H-03H		
46. Power Indicator	f	o	00H-01H		
47. Serial No.	f	y	FFH		
48. S/W Verison	f	z	FFH		
49. Input Select	x	b	60H-C0H		

Transmission/Receiving Protocol

Transmission

[Command1][Command2][Set ID][Data][Cr]

[Command 1] First command (k, j, m, d, f, x)

[Command 2] Second command (a to u)

[Set ID] Set up the Set ID number of product. range : 01H to 63H. by setting '0', server can control all products.

In case of operating with more than 2 sets using set ID as '0' at the same time, it should not be checked the ack message. Because all sets will send the ack message, so it's impossible the check the whole ack messages.

[Data] To transmit command data.

Transmit 'FF' data to read status of command.

[Cr] Carriage Return

ASCII code '0 x 0 D'

[] ASCII code Space (0 x 20)

OK Acknowledgement

[Command2][Set ID][OK][Data][x]

*The Product transmits ACK (acknowledgement) based on this format when receiving normal data. At this time, if the data is in data read mode, it indicates present status data. If the data is in data write mode, it returns the data of the media player/computer.

Error Acknowledgement

2nd Draft

[Command2][Set ID][NG][Data][x]

*If there is error, it returns NG

01. Power (Command : a)

To control Power On/Off of the Set.

Transmission

[k][a][Set ID][Data][Cr]

[Data]	0 : Power Off
	1 : Power On

Acknowledgement

[a][Set ID][OK][Data][x]

To show the status of Power On/Off.

Transmission

[k][a][Set ID][FF][Cr]

Acknowledgement

[a][Set ID][OK][Data][x]

[Data]	0 : Power Off
	1 : Power On

02. Input Select (Command : b) (Main Picture Input)

To select input source for the Set.

You can also select an input source using the INPUT button on the remote control.

Transmission

2nd Draft

[k][b][Set ID][Data][Cr]

[Data] 7 : RGB (PC)
 8 : HDMI (DTV)
 9 : HDMI (PC)
 A: Display port (DTV)
 B: Display port (PC)

Acknowledgement

[b][Set ID][OK][Data][x]

[Data] 7 : RGB (PC)
 8 : HDMI (DTV)
 9 : HDMI (PC)
 A: Display port (DTV)
 B: Display port (PC)

03. Aspect Ratio (Command : c) (Main picture format)

To adjust the screen format.

You can also adjust the screen format using the ARC (Aspect Ratio Control) button on remote control or in the Screen menu.

Transmission

[k][c][Set ID][Data][Cr]

2nd Draft

[Data]	1 : Normal Screen (4:3)
	2 : Wide Screen (16:9)
	4 : Zoom (HDMI-PC, Display Port-PC)
	6 : Original
	7 : 14:9 (HDMI-PC, Display Port-PC)
	9 : Just Scan (HD-DTV)
	*When the RGB, HDMI/DVI-PC, DisplayPort-PC mode (1:1)
	10 to 1F : Cinema Zoom 1 to 16 (HD-DTV)

Acknowledgement

[c][Set ID][OK][Data][x]

04. Screen Mute (Command : d)

To select screen mute on/off.

Transmission

[k][d][Set ID][Data][Cr]

[Data]	0 : Screen mute off (Picture on)
	1 : Screen mute on (Picture off)

Acknowledgement

[d][Set ID][OK][Data][x]

05. Volume Mute (Command : e)

To control On/Off of the Volume Mute.

Transmission

[k][e][Set ID][Data][Cr]

2nd Draft

[Data] 0 : Volume Mute On (Volume Off)
 1 : Volume Mute Off (Volume On)

Acknowledgement

[e][Set ID][OK][Data][x]

[Data] 0 : Volume Mute On (Volume Off)
 1 : Volume Mute Off (Volume On)

06. Volume Control (Command : f)

To adjust Volume.

Transmission

[k][f][Set ID][Data][Cr]

[Data] Min : 00H to Max : 64H
 (Hexadecimal code)

Acknowledgement

[f][Set ID][OK][Data][x]

[Data] Min : 00H to Max : 64H

2nd Draft

Real data mapping	0 : Step 0
	:
	A : Step 10
	:
	F : Step 15
	10 : Step 16
	:
	64 : Step 100

07. Contrast (Command : g)

To adjust screen contrast. You can also adjust the contrast in the Picture menu.

Transmission

```
[k][g][Set ID][Data][Cr]
```

```
[Data]      Min : 00H to Max : 64H
```

Acknowledgement

```
[g][Set ID][OK][Data][x]
```

Real data mapping	0 : Step 0
	:
	A : Step 10
	:
	F : Step 15
	10 : Step 16
	:
	64 : Step 100

08. Brightness (Command : h)

To adjust screen brightness. You can also adjust the brightness in the Picture menu.

2nd Draft

Transmission

[k][h][Set ID][Data][Cr]

[Data] Min : 00H to Max : 64H

Refer to “Real data mapping” as shown below.

Acknowledgement

[h][Set ID][OK][Data][x]

Real data mapping	0 : Step 0
	:
	A : Step 10
	:
	F : Step 15
	10 : Step 16
	:
	64 : Step 100

09. Color (Command : i) (Video Timing only)

To adjust the screen color. You can also adjust the color in the Picture menu.

Transmission

[k][i][Set ID][Data][Cr]

[Data] Min : 00H to Max : 64H

(Hexadecimal code)

2nd Draft

Real data mapping	0 : Step 0
	:
	A : Step 10
	:
	F : Step 15
	10 : Step 16
	:
	64 : Step 100

Acknowledgement

[i][Set ID][OK][Data][x]

[Data] Min : 00H to Max : 64H
(Hexadecimal code)

10. Tint (Command : j) (Video Timing only)

To adjust the screen tint. You can also adjust the tint in the Picture menu.

Transmission

[k][Set ID][Data][Cr]

[Data] Red: 00H to Green: 64H
(Hexadecimal code)

2nd Draft

Real data mapping	0 : Step 0
	:
	A : Step 10
	:
	F : Step 15
	10 : Step 16
	:
	64 : Step 100

Acknowledgement

[j][Set ID][OK][Data][x]

[Data] Red: 00H to Green: 64H

Tint real data mapping	0 : Step 0 to Red
	:
	64 : Step 100 to Green

11. Sharpness (Command : k) (Video Timing only)

To adjust the screen Sharpness. You can also adjust the sharpness in the Picture menu.

Transmission

[k][k][Set ID][Data][Cr]

[Data] Min : 00H to Max : 64H
(Hexadecimal code)

2nd Draft

Real data mapping	0 : Step 0
	:
	A : Step 10
	:
	F : Step 15
	10 : Step 16
	:
	64 : Step 100

Acknowledgement

[k][Set ID][OK][Data][x]

[Data] Min : 00H to Max : 64H

12. OSD Select (Command : I)

To control OSD on/off to the set.

Transmission

[k][Set ID][Data][Cr]

[Data] 0 : OSD Off
 1 : OSD On

Acknowledgement

[l][Set ID][OK][Data][x]

[Data] 0 : OSD Off
 1 : OSD On

2nd Draft

13. Remote Lock /Key Lock (Command : m)

To control Remote Lock on/off to the set.

This function, when controlling RS-232C, locks the remote control and the local keys.

Transmission

```
[k][m][Set ID][Data][Cr]
```

[Data]	0 : Off
	1 : On

Acknowledgement

```
[m][Set ID][OK][Data][x]
```

[Data]	0 : Off
	1 : On

14. Balance (Command : t)

To adjust the sound balance.

Transmission

```
[k][t][Set ID][Data][Cr]
```

[Data]	Min : 00H to Max : 64H
	(Hexadecimal code)

00H : Step L50

64H : Step R50

Acknowledgement

```
[t][Set ID][OK][Data][x]
```

2nd Draft

[Data] Min : 00H to Max : 64H

00H : Step 0 to L50

64H : Step 100 to R50

Balance : L50 to R50

15. Color Temperature (Command : u)

To adjust the screen color temperature.

Transmission

[k][u][Set ID][Data][Cr]

[Data] 0 : Medium

1 : Cool

2 : Warm

Acknowledgement

[u][Set ID][OK][Data][x]

[Data] 0 : Medium

1 : Cool

2 : Warm

16. Abnormal state (Command : z)

Abnormal State : Used to Read the power off status when Stand-by mode.

Transmission

[k][z][Set ID][Data][Cr]

[Data] FF : Read

Acknowledgement

2nd Draft

[z][Set ID][OK][Data][x]

[Data]	0 : Normal (Power on and signal exist)
	1 : No signal (Power on)
	2 : Turn the display off by remote control
	3 : Turn the display off by sleep time function
	4 : Turn the display off by RS-232-C function
	8 : Turn the display off by off time function
	9 : Turn the display off by auto off function

17. ISM mode (Command : j p)

Used to select the afterimage preventing function.

Transmission

[j][p][Set ID][Data][Cr]

[Data]	1H : Inversion
	2H : Orbiter
	4H : White Wash
	8H : Normal

Acknowledgement

[p][Set ID][OK][Data][x]

18. Auto Configure (Command : j u)

To adjust picture position and minimize image shaking automatically. It works only in RGB (PC) mode.

Transmission

[j][u][Set ID][Data][Cr]

2nd Draft

[Data] 1 : To set

Acknowledgement

[u][Set ID][OK][Data][x]

19. Key (Command : m c)

To send IR remote key code.

Transmission

[m][c][Set ID][Data][Cr]

Data Key code : Refer to the [IR Codes Table on page 128](#) section.

Acknowledgement

[c][Set ID][OK][Data][x]

20. Tile Mode (Command : d d)

Change a Tile Mode.

Transmission

[d][d][Set ID][Data][x]

[Data]	Description
00 or 11	Tile mode is off.
12	1 x 2 mode (column x row)
13	1 x 3 mode
14	1 x 4 mode
...	...
55	5 x 5 mode

*The data cannot be set to 0X or X0 except 00.

Acknowledgement

2nd Draft

[d][00][OK/NG][Data][x]

21. Tile H Position (Command : d e)

To set the Horizontal position.

Transmission

[d][e][Set ID][Data][x]

[Data] Min : 00H to Max : 14H

00H : Step -10 (Left)

14H : Step 10 (Right)

Acknowledgement

[e][Set ID][OK/NG][Data][x]

22. Tile V Position (Command : d f)

To set the Vertical position.

Transmission

[d][f][Set ID][Data][x]

[Data] Min : 00H to Max : 14H

00H : Step -10 (Left)

14H : Step 10 (Right)

Acknowledgement

[f][Set ID][OK/NG][Data][x]

23. Tile H Size (Command : d g)

To set the Horizontal size.

2nd Draft

Transmission

[d][g][Set ID][Data][x]

[Data] Min : 00H to Max : 64H

Real data mapping	0 : Step 0
	:
	A : Step 10
	:
	F : Step 15
	10 : Step 16
	:
	64 : Step 100

Acknowledgement

[g][Set ID][OK/NG][Data][x]

24. Tile V Size (Command : d h)

To set the Vertical size.

Transmission

[d][h][Set ID][Data][x]

[Data] Min : 00H to Max : 64H

2nd Draft

Real data mapping	0 : Step 0
	:
	A : Step 10
	:
	F : Step 15
	10 : Step 16
	:
	64 : Step 100

Acknowledgement

[h][Set ID][OK/NG][Data][x]

25. Tile ID Set (Command : d i)

To assign the Tile ID for Tiling function.

Transmission

[d][i][Set ID][Data][x]

[Data] Min : 00H to Max : 19H
(Hexadecimal code)

Acknowledgement

[i][Set ID][OK/NG][Data][x]

26. Natural Mode (In Tile Mode) (Command : d j)

To assign the Title Natural mode for Tiling function.

Transmission

[d][j][Set ID][Data][x]

2nd Draft

[Data]	0 : Natural Off
	1 : Natural On
	ff : Read Status

Acknowledgement

[][Set ID][OK/NG][Data][x]

27. Picture Mode (Command : d x)

To adjust the picture mode.

Transmission

[d][x][Set ID][Data][x]

Data Structure

Data (Hex)	MODE
00	Vivid
01	Standard
02	Cinema
03	Sport
04	Game
05	Expert 1
06	Expert 2

Acknowledgement

[x][Set ID][OK/NG][Data][x]

28. Sound Mode (Command : d y)

To adjust the Sound mode.

Transmission

[d][y][Set ID][Data][X]

2nd Draft

Data Structure

Data (Hex)	MODE
01	Standard
02	Music
03	Cinema
04	Sport
05	Game

Acknowledgement

[y][Set ID][OK/NG][Data][x]

29. Fan Fault check (Command : d w)

To check the Fan fault of the TV.

Transmission

[d][w][Set ID][Data][x]

[Data] Data is always FF (in Hex)

Data ff: Read Status

Acknowledgement

[w][Set ID][OK/NG][Data][x]

[Data] * Data is the status value of the Fan fault.

0: Fan fault

1: Fan OK

2: N/A (Not Available)

30. Elapsed time return (Command : d I)

To read the elapsed time.

2nd Draft

Transmission

[d][i][Set ID][Data][x]

[Data] Data is always FF (in Hex)

Acknowledgement

[i][Set ID][OK/NG][Data][x]

[Data] The data means used hours.
(Hexadecimal code)

31. Temperature value (Command : d n)

To read the inside temperature value.

Transmission

[d][n][Set ID][Data][x]

[Data] Data is always FF (in Hex)

Acknowledgement

[n][Set ID][OK/NG][Data][x]

[Data] The data is 1 byte long in Hexadecimal.

32. Lamp fault Check (Command : d p)

To check lamp fault.

Transmission

[d][p][Set ID][Data][x]

2nd Draft

[Data] Data is always FF (in Hex)

Acknowledgement

[p][Set ID][OK/NG][Data][x]

[Data] 0 : Lamp Fault
 1 : Lamp OK
 2 : N/A(DPM/Power Off)

33. Auto volume (Command : d u)

Automatically adjust the volume level.

Transmission

[d][u][Set ID][Data][x]

[Data] 0 : Off
 1 : On

Acknowledgement

[u][Set ID][OK/NG][Data][x]

34. Speaker (Command : d v)

Turn the speaker on or off.

Transmission

[d][v][Set ID][Data][x]

[Data] 0 : Off
 1 : On

Acknowledgement

2nd Draft

[v][Set ID][OK/NG][Data][x]

35. Time (Command : f a)

Set the current time.

Transmission

[f][a][Set ID][Data1][Data2][Data3][Cr]

[Data1] 0 : Monday

1 : Tuesday

2 : Wednesday

3 : Thursday

4 : Friday

5 : Saturday

6 : Sunday

[Data2] 0H to 17H (Hours)

[Data3] 00H to 3BH (Minutes)

Acknowledgement

[a][Set ID][OK/NG][Data1][Data2][Data3][x]

*When reading data, FFH is inputted for [Data1], [Data2] and [Data3]. In other cases, all are treated as NG.

36. On Timer (On/Off Timer) Time (Command : f d)

Set On Timer.

Transmission

[f][d][Set ID][Data1][Data2][Data3][Cr]

2nd Draft

	1.	2.	3.
[Data1]	f1h to f4h (read one index)	e0htoef4h (delete one index), e0h (delete all indexes)	01h to 80h (write) (Day of Week)
	f1: read 1st index of On Time List	e0: delete all indexes of On Time List	bit0 (01h) : Monday
	f2: read 2nd index of On Time List	e1: delete 1st index of On Time List	bit1 (02h) : Tuesday
	f3: read 3rd index of On Time List	e2: delete 2nd index of On Time List	bit2 (04h) : Wednesday
	f4: read 4th index of On Time List	e3: delete 3rd index of On Time List	bit3 (08h) : Thursday
			bit4 (10h) : Friday
		e4: delete 4th index of On Time List	bit5 (20h) : Saturday
			bit6 (40h) : Sunday
			bit7 (80h) : Everyday
			(1fh) : Monday to Friday
			(3fh) : Monday to Saturday
			(60h) : Saturday to Sunday

[Data2] 00h to 17h, ffh (Hours)

[Data3] 00h to 3bh, ffh (Minutes)

*When you read/delete the current on time list, all of [Data2][Data3] have to be 0xff.

ex1: fd 01 f1 ff ff - when you read 1st index of On Time List

ex2: fd 01 e1 ff ff - when you delete 1st index of On Time List

ex3: fd 01 3f 02 03 - when you write one On Time Data, "Monday to Saturday, 02:03"

Acknowledgement

[d][Set ID][OK][Data1][Data2][Data3][x]

37. Off Timer (On/Off Timer) Time (Command : f e)

Set Off Timer.

2nd Draft

Transmission

[f][e][Set ID][Data1][Data2][Data3][Cr]

	1.	2.	3.
[Data1]	f1h to f4h (read one index)	e0hto e4h(delete one index), e0h (delete all indexes)	01h to 80h (write) (Day of Week)
	f1: read 1st index of On Time List	e0: delete all indexes of On Time List	bit0 (01h) : Monday
	f2: read 2nd index of On Time List	e1: delete 1st index of On Time List	bit1 (02h) : Tuesday
	f3: read 3rd index of On Time List	e2: delete 2nd index of On Time List	bit2 (04h) : Wednesday
	f4: read 4th index of On Time List	e3: delete 3rd index of On Time List	bit3 (08h) : Thursday
			bit4 (10h) : Friday
		e4: delete 4th index of On Time List	bit5 (20h) : Saturday
			bit6 (40h) : Sunday
			bit7 (80h) : Everyday
			(1fh) : Monday to Friday
			(3fh) : Monday to Saturday
			(60h) : Saturday to Sunday

[Data2] 00h to 17h, ffh (Hours)

[Data3] 00h to 3bh, ffh (Minutes)

*When you read/delete the current on time list, all of [Data2][Data3] have to be 0xff.

ex1: fd 01 f1 ff ff - when you read 1st index of On Time List

ex2: fd 01 e1 ff ff - when you delete 1st index of On Time List

ex3: fd 01 3f 02 03 - when you write one On Time Data, "Monday to Saturday, 02:03"

Acknowledgement

2nd Draft

[e][Set ID][OK][Data1][Data2][Data3][x]

38. Scheduling Input select (Command : f u) (Main Picture Input)

To select input source for TV depending on day.

Transmission

[f][u][Set ID][Data1][Data2][Cr]

1.

[Data1]	f1h to f4h(write/read one index)
	f1: read 1st index of On Time Input
	f2: read 2nd index of On Time Input
	f3: read 3rd index of On Time Input
	f4: read 4th index of On Time Input

	Data (Hex)	INPUT
[Data2]	07	RGB-PC
	08	HDMI/DVI — HD-DVD
	09	HDMI/DVI—PC
	A	Display port (-HD-DVI)
	B	Display port PC)

*When you read/delete the current On Time Input, [Data2] needs to be 0xff.

ex1: fu 01 f1 ff - when you read 1st index of On Time Input

ex2: fu 01 f3 02 - when you write one On Time Input Data in to 3rd index, "AV"

Acknowledgement

[u][Set ID][OK][Data1][Data2][x]

2nd Draft

39. Sleep Time (Command : f f)

Set Sleep Time.

Transmission

[f][f][Set ID][Data][Cr]

[Data]	0 : Off
	1 : 10
	2 : 20
	3 : 30
	4 : 60
	5 : 90
	6 : 120
	7 : 180
	8 : 240

Acknowledgement

[f][Set ID][OK/NG][Data][x]

40. Auto Sleep (Command : f g)

Set Auto Sleep.

Transmission

[f][g][Set ID][Data][Cr]

[Data]	0 : Off
	1 : On

Acknowledgement

[g][Set ID][OK/NG][Data][x]

2nd Draft

41. Power On Delay (Command : f h)

Set the schedule delay when the power is turned on (Unit: second).

Transmission

```
[f][h][Set ID][Data][Cr]
```

```
[Data]      00H to 64H (Data value)
```

Real data mapping	0 : Step 0
	:
	A : Step 10
	:
	F : Step 15
	10 : Step 16
	:
	64 : Step 100

Acknowledgement

```
[h][Set ID][OK/NG][Data][x]
```

42. Language (Command : f i)

Set the OSD language.

Transmission

```
[f][i][Set ID][Data][Cr]
```

2nd Draft

[Data]	0 : English
	1 : French
	2 : German
	3 : Spanish
	4 : Italian
	5 : Portuguese
	6 : Chinese
	7 : Japanese
	8 : Korean
	9 : Russian

Acknowledgement

```
[i][Set ID][OK/NG][Data][x]
```

43. DPM Select (Command : f j)

Set the DPM (Display Power Management) function.

Transmission

```
[f][j][Set ID][Data][Cr]
```

[Data]	0 : Off
	1 : On

Acknowledgement

```
[j][Set ID][OK/NG][Data][x]
```

44. Reset (Command : f k)

Execute the Picture, Screen and Factory Reset functions.

Transmission

```
[f][k][Set ID][Data][Cr]
```

2nd Draft

[Data]	0 : Picture Reset
	1 : Screen Reset
	2 : Factory Reset

Acknowledgement

[k][Set ID][OK/NG][Data][x]

45. Power saving(Command : f l)

To set the Power saving mode.

Transmission

[f][l][Set ID][Data][Cr]

[Data]	0 : Off
	1: (static level 1)
	2: (static level 2)
	3: (static level 3)

Acknowledgement

[l][Set ID][OK/NG][Data][x]

46. Power Indicator (Command : f o)

To set the LED for Power Indicator

Transmission

[f][o][Set ID][Data][Cr]

[Data]	0 : Off
	1 : On

Acknowledgement

2nd Draft

[o][Set ID][OK/NG][Data][x]

47. Serial no. Check (Command : f y)

To read the serial numbers

Transmission

[f][y][Set ID][Data][Cr]

[Data] Data FF (to read the serial numbers)

Acknowledgement

[y][Set ID][OK/NG][Data1]to[Data13][x]

[Data] The data format is ASCII Code.

48. S/W Version (Command : f z)

Check the software version.

Transmission

[f][z][Set ID][Data][Cr]

[Data] FFH : Read

Acknowledgement

[z][Set ID][OK/NG][Data][x]

49. Input Select (Command : x b)

To select input source for the display.

Transmission

2nd Draft

[x][b][Set ID][Data][Cr]

[Data]	60H : RGB (PC)
	90H : HDMI/DVI (DTV)
	A0H : HDMI/DVI (PC)
	B0H: Display port(HD-DVD)
	C0H: Display port(PC)

Acknowledgement

[b][Set ID][OK][Data][x]

[Data]	60H : RGB (PC)
	90H : HDMI/DVI (DTV)
	A0H : HDMI/DVI (PC)
	B0H: Display port(HD-DVD)
	C0H: Display port(PC)

IR codes

Use this method to connect your wired remote control port on the display.

Remote Control IR Code

Output waveform

- Single pulse, modulated with 37.917kHz signal at 455kHz
- Carrier Frequency
 - $FCAR = 1/Tc = fosc/12$
 - Duty Ratio = $T1/Tc = 1/3$

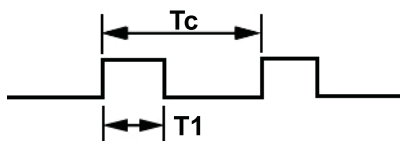

2nd Draft

Configuration of frame

- 1st frame

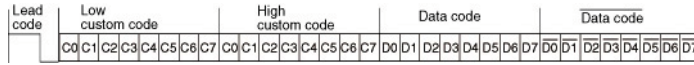

- Repeat frame

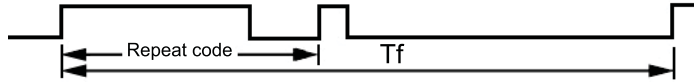

Lead code

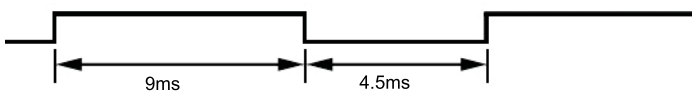

Repeat code

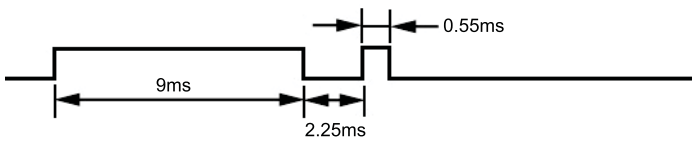

Bit description

- Bit "0"

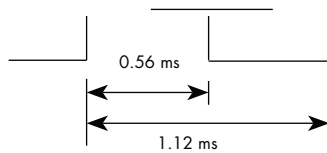

- Bit "1"

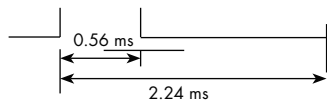

Frame interval: Tf

The waveform is transmitted as long as a key is depressed.



2nd Draft

IR Codes Table

Code (Hex)	Function	Note
40	Up arrow ▲	R/C Button
41	Down arrow ▼	R/C Button
06	Right arrow ►	R/C Button
07	Left arrow ◀	R/C Button
08	POWER ON/OFF	R/C Button
C4	MONITOR ON	R/C Button (Discrete IR Code)
C5	MONITOR OFF	R/C Button (Discrete IR Code)
09	MUTE	R/C Button
95	Energy Saving	R/C Button
0B	INPUT	R/C Button
43	MENU	R/C Button
5B	EXIT	R/C Button
4D	PSM	R/C Button
44	OK	R/C Button
10	Number Key 0	R/C Button
11	Number Key 1	R/C Button
12	Number Key 2	R/C Button
13	Number Key 3	R/C Button
14	Number Key 4	R/C Button
15	Number Key 5	R/C Button
16	Number Key 6	R/C Button
17	Number Key 7	R/C Button
18	Number Key 8	R/C Button
19	Number Key 9	R/C Button
79	ARC (MARK)	R/C Button (Discrete IR Code)
02	Vol+	R/C Button
03	Vol-	R/C Button
E0	Bright▼ (Page UP)	R/C Button
E1	Bright▼ (Page Down)	R/C Button
28	BACK	R/C Button

2nd Draft

Code (Hex)	Function	Note
99	AUTO CONFIG	R/C Button
72	ID ON (Red Color)	R/C Button (Discrete IR Code)
71	ID OFF (Green Color)	R/C Button
63	(Yellow Color)	R/C Button
61	(Blue Color)	R/C Button
7B	TILE	R/C Button
B0	Play ▶	R/C Button
B1	Stop ■	R/C Button
BA	Pause II	R/C Button
8F	Reverse ◀◀	R/C Button
8E	Fast forward ▶▶	R/C Button
D5	RGB PC	Discrete IR Code (Input RGB PC Selection)
C6	HDMI/DVI	Discrete IR Code (Input HDMI/DVI Selection)
76	ARC (4:3)	Discrete IR Code (Only 4 : 3 mode)
77	ARC (16:9)	Discrete IR Code (Only 16 : 9 mode)
AF	ARC (ZOOM)	Discrete IR Code (Only ZOOM, Cinena ZOOM mode)
CA	USB	

2nd Draft

D Agency regulatory notices

Federal Communications Commission notice

This equipment has been tested and found to comply with the limits for a Class B digital device, pursuant to Part 15 of the FCC Rules. These limits are designed to provide reasonable protection against harmful interference in a residential installation. This equipment generates, uses, and can radiate radio frequency energy and, if not installed and used in accordance with the instructions, may cause harmful interference to radio communications. However, there is no guarantee that interference will not occur in a particular installation. If this equipment does cause harmful interference to radio or television reception, which can be determined by turning the equipment off and on, the user is encouraged to try to correct the interference by one or more of the following measures:

- Reorient or relocate the receiving antenna.
- Increase the separation between the equipment and the receiver.
- Connect the equipment into an outlet on a circuit different from that to which the receiver is connected.
- Consult the dealer or an experienced radio or television technician for help.

Modifications

The FCC requires the user to be notified that any changes or modifications made to this device that are not expressly approved by Hewlett Packard Company may void the user's authority to operate the equipment.

Cables

Connections to this device must be made with shielded cables with metallic RFI/EMI connector hoods to maintain compliance with FCC Rules and Regulations.

2nd Draft

Declaration of Conformity for products marked with the FCC logo (United States only)

This device complies with Part 15 of the FCC Rules. Operation is subject to the following two conditions:

1. This device may not cause harmful interference.
2. This device must accept any interference received, including interference that may cause undesired operation.

For questions regarding the product, contact:

Hewlett Packard Company

P. O. Box 692000, Mail Stop 530113

Houston, Texas 77269-2000

Or, call 1-800-HP-INVENT (1-800 474-6836)

For questions regarding this FCC declaration, contact:

Hewlett Packard Company

P. O. Box 692000, Mail Stop 510101

Houston, Texas 77269-2000

Or, call (281) 514-3333

To identify this product, refer to the Part, Series, or Model number found on the product.

Canadian notice

This Class B digital apparatus meets all requirements of the Canadian Interference-Causing Equipment Regulations.

Avis Canadien

Cet appareil numérique de la classe B respecte toutes les exigences du Règlement sur le matériel brouilleur du Canada.

European Union regulatory notice

Products bearing the CE marking comply with the following EU Directives:



- Low Voltage Directive 2006/95/EC
- EMC Directive 2004/108/EC
- Ecodesign Directive 2009/125/EC, where applicable

2nd Draft

CE compliance of this product is valid if powered with the correct CE-marked AC adapter provided by HP.

Compliance with these directives implies conformity to applicable harmonized European standards (European Norms) that are listed in the EU Declaration of Conformity issued by HP for this product or product family and available (in English only) either within the product documentation or at the following web site: www.hp.eu/certificates (type the product number in the search field).

The compliance is indicated by one of the following conformity markings placed on the product:

	For non-telecommunications products and for EU harmonized telecommunications products, such as Bluetooth® within power class below 10mW.
	For EU non-harmonized telecommunications products (If applicable, a 4-digit notified body number is inserted between CE and !).

Please refer to the regulatory label provided on the product.

The point of contact for regulatory matters is: Hewlett-Packard GmbH, Dept./MS: HQ-TRE, Herrenberger Strasse 140, 71034 Boeblingen, GERMANY.

German ergonomics notice

HP products which bear the "GS" approval mark, when forming part of a system comprising HP brand computers, keyboards and monitors that bear the "GS" approval mark, meet the applicable ergonomic requirements. The installation guides included with the products provide configuration information.

Japanese notice

この装置は、クラスB情報技術装置です。この装置は、家庭環境で使用することを目的としていますが、この装置がラジオやテレビジョン受信機に近接して使用されると、受信障害を引き起こすことがあります。取扱説明書に従って正しい取り扱いをして下さい。

VCCI-B

Korean notice

B급 기기 (가정용 방송통신기기)	이 기기는 가정용(B급)으로 전자파적합등록을 한 기기로서 주로 가정에서 사용하는 것을 목적으로 하며, 모든 지역에서 사용할 수 있습니다.
------------------------------	--

2nd Draft

Power cord set requirements

The display power supply is provided with Automatic Line Switching (ALS). This feature allows the display to operate on input voltages between 100–120V or 200–240V.

The power cord set (flexible cord or wall plug) received with the display meets the requirements for use in the country where you purchased the equipment.

If you need to obtain a power cord for a different country, you should purchase a power cord that is approved for use in that country.

The power cord must be rated for the product and for the voltage and current marked on the product's electrical ratings label. The voltage and current rating of the cord should be greater than the voltage and current rating marked on the product. In addition, the cross-sectional area of the wire must be a minimum of 0.75 mm² or 18 AWG, and the length of the cord must be between 6 feet (1.8 m) and 12 feet (3.6 m). If you have questions about the type of power cord to use, contact an authorized HP service provider.

A power cord should be routed so that it is not likely to be walked on or pinched by items placed upon it or against it. Particular attention should be paid to the plug, electrical outlet, and the point where the cord exits from the product.

Japanese power cord requirements

For use in Japan, use only the power cord received with this product.

△ **CAUTION:** Do not use the power cord received with this product on any other products.

Product environmental notices

Materials disposal

This HP product contains mercury in the fluorescent lamp in the display LCD that might require special handling at end-of-life.

Disposal of this material can be regulated because of environmental considerations. For disposal or recycling information, contact the local authorities or the Electronic Industries Alliance (EIA) www.eiae.org.

Disposal of waste equipment by users in private households in the European Union



This symbol on the product or on its packaging indicates that this product must not be disposed of with your household waste. Instead, it is your responsibility to dispose of your waste equipment by handing it over to a designated collection point for the recycling or waste electrical and electronic equipment. The separate collection and recycling of your waste equipment at the time of disposal will help to conserve natural resources and ensure that it is recycled in a manner that protects human

2nd Draft

health and the environment. For more information about where you can drop off your waste equipment for recycling, please contact the local city office, the household waste disposal service or the shop where you purchased the product.

Chemical substances

HP is committed to providing our customers with information about the chemical substances in our products as needed to comply with legal requirements such as REACH (Regulation EC No 1907/2006 of the European Parliament and Council). A chemical information report for this product can be found at www.hp.com/go/reach.

HP recycling program

HP encourages customers to recycle used electronic hardware, HP original print cartridges, and rechargeable batteries. For more information about recycling programs, go to www.hp.com/recycle.

Restriction of Hazardous Substances (RoHS)

A Japanese regulatory requirement, defined by specification JIS C 0950, 2005, mandates that manufacturers provide Material Content Declarations for certain categories of electronic products offered for sale after July 1, 2006. To view the JIS C 0950 material declaration for this product, visit www.hp.com/go/jisc0950.

2008年、日本における製品含有表示方法、JISC0950が公示されました。製造事業者は、2006年7月1日以降に販売される電気・電子機器の特定化学物質の含有につきまして情報提供を義務付けられました。製品の部材表示につきましては、www.hp.com/go/jisc0950を参照してください。

2nd Draft

有毒有害物质/元素的名称及含量表

根据中国
《电子信息产品污染控制管理办法》

液晶显示器

部件名称	有毒有害物质和元素					
	铅 (Pb)	汞 (Hg)	镉 (Cd)	六价铬 (Cr(VI))	多溴联苯 (PBB)	多溴二苯醚 (PBDE)
液晶显示器显示面板	X	X	○	○	○	○
机箱/其它	X	○	○	○	○	○

CRT 显示器

部件名称	有毒有害物质和元素					
	铅 (Pb)	汞 (Hg)	镉 (Cd)	六价铬 (Cr(VI))	多溴联苯 (PBB)	多溴二苯醚 (PBDE)
阴极射线管	X	○	○	○	○	○
机箱/其它	X	○	○	○	○	○

O: 表示该有毒或有害物质在该部件所有均质材料中的含量均在 SJ/T11363-2006 标准规定的限量要求以下。

X: 表示该有毒或有害物质至少在该部件所用的某一均质材料中的含量超出 SJ/T11363-2006 标准规定的限量要求。

表中标有“X”的所有部件都符合欧盟 RoHS 法规 — “欧洲议会和欧盟理事会 2003 年 1 月 27 日关于电子电器设备中限制使用某些有害物质的 2002/95/EC 号指令”。

注: 环保使用期限的参考标识取决于产品正常工作的温度和湿度等条件。

Turkey EEE regulation

In Conformity with the EEE Regulation

EEE Yönetmeliğine Uygun

■■■ Regulatory Information cont.

:: FCC Compliance Statement

This equipment has been tested and found to comply within the limits of a Class B digital device pursuant to Part 15 of the FCC Rules. These limits are designed to provide reasonable protection against harmful interference in a residential installation.

This equipment generates, uses, and can radiate radio frequency energy and if not installed and used in accordance with the instructions, may cause harmful interference to radio communications. However, there is no guarantee that interference will not occur in a particular installation.

If this equipment does cause harmful interference to radio or television reception (which can be determined by turning the equipment on and off), the user is encouraged to try to correct the interference by using one or more of the following measures:

- Reorient or relocate the receiving antenna.
- Increase the separation between the equipment and the receiver.
- Connect the equipment into an outlet on a circuit different from that to which the receiver is connected.
- Consult the dealer or an experienced radio/TV technician for help.

Caution: Changes or modifications not expressly approved by the party responsible for compliance could void the user's (or your) authority to operate the equipment. Only peripherals (digital input/output devices, terminals, printers, etc.) certified to comply with the Class B limits may be attached to this monitor. Operation with non-certified peripherals is likely to result in interference to radio and TV reception. Only shielded signal cables may be used with this System.

NOTICE

The regulations are applied only to the products with the ID LABEL indicating specific requirements.

:: Canadian DOC Notice

This Class B digital apparatus meets all requirements of the Canadian Interference-Causing Equipment Regulations. Cet appareil numérique de la classe B

respecte toutes les exigences du Règlement sur le matériel brouilleur du Canada.

NOTICE

The regulations are applied only to the products with the ID LABEL indicating specific requirements.

:: CE Conformity Notice (for Europe)

Products with the "CE" Marking comply with the EMC Directive(89/336/EEC) and LOW VOLTAGE Directive (73/23/EEC) issued by the Commission of the European Community.

Compliance with these directives implies conformity to the following European Norms :

- EN 55022 ; Radio Frequency Interference
- EN 55024 ; Electromagnetic Immunity
- EN 61000-3-2 ; Power Line Harmonics
- EN 61000-3-3 ; Voltage Fluctuations
- EN 60950-1 ; Product Safety

NOTICE

The regulations are applied only to the products with the ID LABEL indicating specific requirements.

:: Low Radiation Compliance (MPR II)

This monitor meets one of the strictest guidelines available today for low radiation emissions, offering the user extra shielding and an antistatic screen coating. These guidelines, set forth by a government agency in Sweden, limit the amount of emission allowed in the Extremely Low Frequency (ELF) and Very Low Frequency (VLF) electromagnetic range.

:: TCO'99 (TCO'99 applied model only)



Congratulations!

You have just purchased a TCO'99 approved and labelled product! Your choice has provided you with a product developed for professional use. Your purchase has also contributed to reducing the burden on the environment and also to the further development of environmentally adapted electronics products.

■■■ Regulatory Information cont.

Why do we have environmentally labelled computers?

In many countries, environmental labelling has become an established method for encouraging the adaptation of goods and services to the environment. With the growing manufacture and usage of electronic equipment throughout the world, there is a recognized concern for the materials and substances used by electronic products with regards to their eventual recycling and disposal. By proper selection of these materials and substances, the impact on the environment can be minimized.

There are also other characteristics of a computer, such as energy consumption levels, that are important from the viewpoints of both the work (internal) and natural (external) environments. Electronic equipment in offices is often left running continuously, resulting in unnecessary consumption of large amounts of energy and additional power generation. From the standpoint of carbon dioxide emissions alone, it is vital to save energy.

What does labelling involve?

The product meets the requirements for the TCO'99 scheme which provides for international and environmental labelling of personal computers and/or displays.

The labelling scheme was developed as a joint effort by the TCO (The Swedish Confederation of Professional Employees), Svenska Naturskyddsforeningen (The Swedish Society for Nature Conservation) and Statens Energimyndighet (The Swedish National Energy Administration).

Approval requirements cover a wide range of issues: ecology, ergonomics, emission of electrical and magnetical fields, energy consumption and electrical safety.

Ecological criteria impose restrictions on the presence and use of heavy metals, brominated and chlorinated flame retardants, and other substances. The product must be prepared for recycling and the manufacturing site(s) shall be certified according to ISO14001 or EMAS registered.

Energy requirements include a demand that the system unit and/or display, after a certain period of inactivity, shall reduce its power consumption to a lower level in one or more stages. The length of time to reactivate the system unit shall be reasonable for the user.

Labelled products must meet strict environmental demands, for example, in respect of the reduction of electrical and magnetical fields as well as work load and

visual ergonomics.

Below you will find a brief summary of the ecological requirements met by this product. The complete ecological criteria document can be found at TCO Development's website <http://www.tcodevelopment.com> or may be ordered from:

TCO Development

SE-114 94 STOCKHOLM, Sweden

Fax: +46 8 782 92 07

Email : development@tco.se

Information regarding TCO'99 approved and labelled products may also be obtained at <http://www.tcodevelopment.com>

Ecological requirements

Flame retardants

Flame retardants may be present in printed wiring board laminates, cables, and housings. Their purpose is to prevent, or at least to delay the spread of fire. Up to 30% by weight of the plastic in a computer casing can consist of flame retardant substances. Many flame retardants contain bromine or chlorine, and these flame retardants are chemically related to PCBs (polychlorinated biphenyls). Both the flame retardants containing bromine or chlorine and the PCBs are suspected of giving rise to health effects, including reproductive damage in fish-eating birds and mammals, due to the bio-accumulative* processes when not disposed of in accordance with strict standards for disposal.

TCO'99 requires that plastic components weighing more than 25 grams shall not contain flame retardants with organically bound bromine or chlorine. Flame retardants are allowed in the printed wiring board laminates due to the lack of commercially available alternatives.

Cadmium**

Cadmium is present in rechargeable batteries and in the colour-generating layers of certain computer displays. TCO'99 requires that batteries, the colour-generating layers of display screens, and the electrical or electronics components shall not contain any cadmium.

Mercury**

Mercury is sometimes found in batteries, relays and switches. TCO'99 requires that batteries shall not contain any mercury. It also demands that mercury is not present in any of the electrical or electronics components associated with the labelled unit. There is however one

■■■ Regulatory Information cont.

exception. Mercury is, for the time being, permitted in the back light system of flat panel monitors as there today is no commercially available alternative. TCO aims on removing this exception when a mercury free alternative is available.

Lead**

Lead can be found in picture tubes, display screens, solders and capacitors. TCO'99 permits the use of lead due to the lack of commercially available alternatives, but in future requirements TCO Development aims at restricting the use of lead.

* Bio-accumulative is defined as substances which accumulate in living organisms.

**Lead, Cadmium and Mercury are heavy metals which are bio-accumulative.

:: **TCO'03** (TCO'03 applied model only)



Congratulations!

The display you have just purchased carries the TCO'03 Displays label.

This means that your display is designed, manufactured and tested according to some of the strictest quality and environmental requirements in the world. This makes for a high performance product, designed with the user in focus that also minimizes the impact on our natural environment. Some of the features of the TCO'03 Display requirements:

Ergonomics

- Good visual ergonomics and image quality in order to improve the working environment for the user and to reduce sight and strain problems. Important parameters are luminance, contrast, resolution, reflectance, colour rendition and image stability.

Energy

- Energy-saving mode after a certain time – beneficial both for the user and the environment
- Electrical safety

Emissions

- Electromagnetic fields

- Noise emissions

Ecology

- The product must be prepared for recycling and the manufacturer must have a certified environmental management system such as EMAS or ISO 14 001
- Restrictions on
 - chlorinated and brominated flame retardants and polymers
 - heavy metals such as cadmium, mercury and lead.

The requirements included in this label have been developed by TCO Development in co-operation with scientists, experts, users as well as manufacturers all over the world. Since the end of the 1980s TCO has been involved in influencing the development of IT equipment in a more user-friendly direction. Our labelling system started with displays in 1992 and is now requested by users and IT-manufacturers all over the world.

For more information, please visit
www.tcodevelopment.com

English

Information for Environmental Preservation

LGE. announced the 'LG Declaration for a Cleaner Environment' in 1994, and this ideal has served as a guiding managerial principle ever since. The Declaration is a foundation that has allowed us to undertake environmentally friendly activities in careful consideration of economic, environmental, and social aspects.

We promote activities for environmental preservation, and we specifically develop our products to embrace the concept of environment-friendly.

We minimize the hazardous materials contained in our products. For example, there is no cadmium to be found in our monitors.

Information for recycling

This monitor may contain parts which could be hazardous to the environment. It is important that this monitor be recycled after use.

LGE. handles all waste monitors through an environmentally acceptable recycling method. There are several take-back and recycling systems currently in

■■■ Regulatory Information cont.

operation worldwide. Many parts will be reused and recycled, while harmful substances and heavy metals are treated by an environmentally friendly method.

If you want to find out more information about our recycling program, please contact your local LG vendor or a corporate representative of LG.

We set our vision and policies on a cleaner world by selecting the issue of the global environment as a task for corporate improvement. Please visit our website for more information about our 'green' policies.

<http://www.lge.com/about/environment/html/Recycling.jsp>

■ ■ ■ Deutsch

Informationen zur Erhaltung der Umwelt

Im Jahr 1994 verkündete LGE die 'LG Declaration for a Cleaner Environment' (LG Erklärung für eine sauberere Umwelt). Seitdem dient dieses Ideal als führendes Prinzip des Unternehmens. Diese Erklärung war die Basis für die Durchführung von

umweltfreundlichen Aktivitäten, wobei wirtschaftliche, umweltbezogene und soziale Aspekte in die Überlegungen mit einbezogen wurden.

Wir fördern Aktivitäten zum Schutz der Umwelt und die Entwicklung unserer Produkte ist darauf ausgerichtet, unserem Konzept bezüglich Umweltfreundlichkeit gerecht zu werden.

Wir sind darauf bedacht, den Anteil der in unseren Produkten enthaltenen schädlichen Materialien zu minimieren. So ist in unseren Monitoren beispielsweise kein Kadmium zu finden.

Informationen zum Thema Recycling

Dieser Monitor enthält Teile, die umweltschädlich sein können. Es ist unbedingt erforderlich, dass der Monitor recycelt wird, nachdem er außer Dienst gestellt wurde.

Bei LGE werden alle ausrangierten Monitore in einem unter umweltbezogenen Aspekten geeigneten Verfahren recycelt. Augenblicklich sind weltweit mehrere Rücknahme- und Recyclingsysteme im Einsatz. Viele Teile werden wieder verwendet und recycelt. Schädliche Substanzen und Schwermetalle werden durch umweltverträgliche Verfahren behandelt.

Falls Sie mehr über unser Recyclingprogramm erfahren möchten, wenden Sie sich bitte an Ihren lokalen LG-Händler oder einen Unternehmensvertreter von LG.

Wir richten unsere Firmenpolitik auf eine sauberere Umwelt hin aus, indem wir umweltspezifische Aspekte als wichtigen Punkt in die Weiterentwicklung unseres Unternehmens einfließen lassen. Zusätzliche Informationen über unsere 'grüne' Firmenpolitik erhalten Sie auf unserer Website.

<http://www.lge.com/about/environment/html/Recycling.jsp>

■ ■ ■ Français

Information sur la protection de l'environnement

LGE a publié sa 'Déclaration en faveur d'un environnement plus propre' en 1994 et celle-ci est restée, depuis lors, un principe directeur de notre entreprise. Cette déclaration a servi de base à notre réflexion et nous a permis de prendre en compte à la fois les aspects économiques et sociaux de nos activités, tout en respectant l'environnement.

Nous encourageons les activités en faveur de la préservation de l'environnement et c'est dans cet esprit que nous développons nos produits : nous réduisons au minimum les matières dangereuses qui entrent dans leur composition et l'on ne trouve pas de cadmium, par exemple, dans nos moniteurs.

Information sur le recyclage

Ce moniteur peut contenir des composants qui présentent un risque pour l'environnement. Il est donc important que celui-ci soit recyclé après usage.

LGE traite les moniteurs en fin de cycle conformément à une méthode de recyclage respectueuse de l'environnement. Nous reprenons nos produits et les recyclons dans plusieurs sites répartis dans le monde entier. De nombreux composants sont réutilisés et recyclés, et les matières dangereuses, ainsi que les métaux lourds, sont traités selon un procédé écologique.

Si vous souhaitez plus de renseignements sur notre programme de recyclage, veuillez contacter votre revendeur LG ou un l'un de nos représentants.

Nous voulons agir pour un monde plus propre et croyons au rôle de notre entreprise dans l'amélioration de l'environnement. Pour plus de renseignements sur notre politique "verte", rendez visite à notre site :

<http://www.lge.com/about/environment/html/Recycling.jsp>

Regulatory Information cont.

Italiano

Informazioni per la tutela dell'ambiente

La LGE. ha annunciato nel 1994 la cosiddetta 'LG Declaration for a Cleaner Environment' (Dichiarazione di LG a favore di un ambiente più pulito), un ideale che da allora funge da principio ispiratore della gestione aziendale. La dichiarazione rappresenta il fondamento che consente di intraprendere attività a favore dell'ambiente tenendo conto degli aspetti economici, ambientali e sociali. Noi della LG, promuoviamo attività a favore della tutela dell'ambiente sviluppando appositamente i nostri prodotti per cogliere il concetto del rispetto dell'ambiente riducendo i materiali dannosi presenti nei nostri prodotti. Ad esempio nei nostri monitor non è presente il cadmio.

Informazioni per il riciclaggio

Il monitor può presentare componenti che potrebbero risultare eventualmente dannosi per l'ambiente. È importante che il monitor sia riciclato al termine del suo utilizzo.

La LGE. gestisce tutti i monitor di rifiuto con un metodo di riciclaggio soddisfacente dal punto di vista ambientale. In tutto il mondo sono attualmente in funzione numerosi sistemi di riciclaggio e recupero. I diversi componenti sono riutilizzati e riciclati, mentre le sostanze dannose e i metalli pesanti vengono trattati con un metodo rispettoso dell'ambiente.

Se si desiderano maggiori informazioni in merito al programma di riciclaggio, è consigliabile rivolgersi al proprio rivenditore LG o ad un rappresentante aziendale della LG.

Noi della LG impostiamo la nostra visione e le nostre politiche a favore di un mondo più pulito ponendo la questione dell'ambiente dal punto di vista globale come una mansione rivolta al miglioramento della nostra azienda. Vi invitiamo a visitare il nostro sito internet per ulteriori informazioni sulla nostra politica "verde".
<http://www.lge.com/about/environment/html/Recycling.jsp>

Espanol

Información para la conservación medioambiental

LGE. presentó la 'Declaración para un entorno más limpio de LG' en 1994 y este ideal ha servido para guiar nuestros principios empresariales desde entonces. La Declaración es la base que nos ha permitido llevar a cabo tareas que

respetan el medio ambiente siempre teniendo en cuenta aspectos sociales, económicos y medioambientales.

Promocionamos actividades orientadas a la conservación del medio ambiente y desarrollamos nuestros productos específicamente para que se ajusten a la filosofía que protege el entorno.

Reducimos al máximo el uso de materiales de riesgo en nuestros productos. Un ejemplo de ello es la ausencia total de cadmio en nuestros monitores.

Información para el reciclaje

Este monitor puede contener piezas que entrañen riesgos medioambientales. Es importante reciclar este monitor después de su utilización.

LGE. trata todos los monitores usados siguiendo un método de reciclaje que no daña al entorno. Contamos con diversos sistemas de recuperación y reciclaje que funcionan a nivel mundial en la actualidad. Es posible reciclar y reutilizar muchas de las piezas, mientras que las sustancias dañinas y los metales pesados se tratan siguiendo un método que no perjudique al medio ambiente. Si desea obtener más información acerca del programa de reciclaje, póngase en contacto con su proveedor local de LG o con un representante empresarial de nuestra marca.

Basamos nuestra visión y nuestras políticas en un mundo más limpio y para ellos optamos por un entorno global como tarea principal de nuestra evolución como empresa. Visite nuestra página Web para obtener más información sobre nuestras políticas ecológicas.

<http://www.lge.com/about/environment/html/Recycling.jsp>

Português

Informações relacionadas à preservação ambiental

A LGE. anunciou a 'LG Declaration for a Cleaner Environment' (Declaração da LG para um ambiente mais limpo) em 1994 e esse ideal tem servido desde então como um princípio administrativo de orientação. A Declaração é a base que nos tem permitido realizar atividades favoráveis ao ambiente com consideração atenta aos aspectos econômicos, ambientais e sociais.

Promovemos atividades de preservação ambiental e desenvolvemos nossos produtos para englobar

■■■ Regulatory Information cont.

especificamente o conceito de favorável ao ambiente.

Reduzimos os materiais perigosos contidos em nossos produtos. Por exemplo, não há cádmio em nossos monitores.

Informações relacionadas à reciclagem

Este monitor pode conter peças que podem representar riscos ao ambiente. É importante que ele seja reciclado após o uso.

A LGE. cuida de todos os monitores descartados através de um método de reciclagem agradável ao ambiente. Há vários sistemas de devolução e reciclagem atualmente em operação no mundo. Muitas peças serão reutilizadas e recicladas e as substâncias nocivas e os metais pesados passarão por tratamento através de um método favorável ao ambiente.

Para obter mais informações sobre nosso programa de reciclagem, entre em contato com seu fornecedor LG local ou com um representante corporativo da LG.

Definimos nossa visão e nossas políticas relacionadas a um mundo mais limpo selecionando a questão do ambiente global como uma tarefa de aprimoramento corporativo. Visite nosso site para obter mais informações sobre nossas políticas de meio ambiente.

<http://www.lge.com/about/environment/html/Recycling.jsp>

■ ■ ■ Nederlands

Informatie met betrekking tot het behoud van het milieu

LGE. publiceerde in 1994 de 'LG Declaration for a Cleaner Environment' (de LG-verklaring met betrekking tot een schoner milieu). Deze verklaring en het ideaal van een schoner milieu fungeren sindsdien als een bestuurlijke leidraad voor onze onderneming. Op basis van deze verklaring ontplooiën wij milieuvriendelijke activiteiten, waarbij er zowel met sociale en economische aspecten, als met milieuaspecten zorgvuldig rekening wordt gehouden.

Wij ondersteunen activiteiten die zijn gericht op het behoud van het milieu en wij houden bij het ontwikkelen onze producten specifiek rekening met de milieuvriendelijkheid van onze producten.

Wij minimaliseren het gebruik van schadelijke stoffen in onze producten. Er wordt bijvoorbeeld geen cadmium verwerkt in onze monitoren.

Informatie met betrekking tot recycling

Deze monitor bevat materialen die schadelijk zouden kunnen zijn voor het milieu. Het is belangrijk dat deze monitor aan het einde van zijn levensduur wordt gerecycled.

LGE. verwerkt alle afvalmonitoren via een milieuvriendelijke recyclingmethode. Hiervoor worden er momenteel wereldwijd verscheidene inname- en recyclingsystemen gehanteerd. Een groot aantal onderdelen wordt opnieuw gebruikt en gerecycled, waarbij schadelijke stoffen en zware metalen volgens een milieuvriendelijke methode worden verwerkt.

Voor meer informatie over ons recyclingprogramma kunt u contact opnemen met uw plaatselijke LG-vertegenwoordiger of een LG-vestiging.

Onze visie en ons beleid met betrekking tot een schonere wereld vloeien voort uit het feit dat wij het milieu hebben aangemerkt als een onderwerp dat speciale aandacht verdient binnen onze onderneming. Bezoek onze website voor meer informatie over ons 'groene' beleid.

<http://www.lge.com/about/environment/html/Recycling.jsp>

■ ■ ■ Russian

Информация по охране окружающей среды

В 1994 году корпорация LGE опубликовала 'Декларацию LG по охране окружающей среды', которая с тех пор служит основным принципом управления. На основе этой декларации мы смогли предпринять действия, обеспечивающие безопасность окружающей среды, уделяя при этом должное внимание экономическим, экологическим и социальным аспектам.

Мы стимулируем деятельность по охране окружающей среды, уделяя особое внимание разработке нашей продукции в соответствии с концепцией экологической безопасности.

Мы сводим к минимуму содержание опасных веществ в нашей продукции. Например, в наших мониторах вы не найдете кадмия.

Информация по утилизации отходов

Этот монитор может содержать компоненты, которые могут нанести ущерб окружающей среде.

■■■ Regulatory Information cont.

Необходимо утилизировать монитор после использования.

Корпорация LGE перерабатывает все бракованные мониторы с помощью экологически приемлемого метода утилизации отходов. По всему миру действуют системы утилизации отходов и возврата использованной продукции. Многие компоненты будут вторично использованы и утилизированы, в то время как вредные вещества и тяжелые металлы будут обработаны с помощью экологически приемлемого метода.

За более подробной информацией по нашей программе утилизации отходов обращайтесь к местному поставщику или представителю корпорации LG.

Мы ориентируемся на обеспечение экологической безопасности, ставя себе целью глобальную защиту окружающей среды. Дополнительную информацию о нашей политике по охране окружающей среды вы можете найти на нашем сайте:
<http://www.lge.com/about/environment/html/Recycling.jsp>

한국어

환경 보존 정보

LG 전자는 1994년 'LG 환경 선언문'을 발표한 후 현재까지 이를 기업 경영의 이념으로 삼아왔습니다. 이 선언문을 바탕으로 LG 전자는 모든 경영 활동에서 경제성뿐만 아니라 환경성 및 사회성을 주요 의사 결정의 기준으로 삼음으로써 지속적으로 환경 친화적인 경영을 전개하고 있습니다.

본사는 보다 활발한 환경 보존 활동과 더불어 환경 친화적 제품 개발에 주력해 왔습니다.

또한 제품에 포함되는 환경 위해 요소를 최소화하는 데에도 노력을 기울이지 않고 있습니다. LG 전자 모니터의 경우 카드뮴을 전혀 사용하지 않는 것에서도 이러한 노력을 알 수 있습니다.

재활용 정보

본 모니터에는 환경에 위해를 주는 부품이 포함되어 있을 수도 있습니다. 따라서 사용이 끝난 모니터는 재활용하는 것이 좋습니다.

폐모니터는 모두 환경 친화적 방식으로 처리됩니다. 현재 세계적으로 운영되고 있는 회수 및 재활용 시스템에는

여러 가지가 있습니다. 대부분의 부품의 경우 재사용 또는 재활용되지만 환경 위해 물질과 중금속은 환경 친화적 방법으로 처리됩니다.

본사의 재활용 프로그램에 대한 자세한 정보는 각 지역의 LG 공급업체나 LG 기업 대표부에 문의하시기 바랍니다.

LG 전자는 기업 개선 정책의 하나로 지구 환경 문제를 채택함으로써 보다 나은 환경을 만들어 나가기 위한 비전과 정책을 수립했습니다. 본사의 친환경 정책에 대한 자세한 정보를 보시려면 아래의 웹 사이트를 방문하십시오.

http://www.lge.co.kr/cckr/about/environ/purity_02.jsp

∴EPA (EPA applied model only)

ENERGY STAR is a set of power-saving guidelines issued by the U.S. Environmental Protection Agency(EPA).



As an ENERGY STAR Partner LGE U. S. A.,Inc. has determined that this product meets the ENERGY STAR guidelines for energy efficiency.

∴NOM MARK (Mexico only)



Regulatory Information cont.

:: WEEE (for Europe)

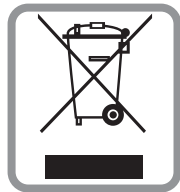

English

Disposal of your old appliance

1. When this crossed-out wheeled bin symbol is attached to a product it means the product is covered by the European Directive 2002/96/EC.
2. All electrical and electronic products should be disposed of separately from the municipal waste stream via designated collection facilities appointed by the government or the local authorities.
3. The correct disposal of your old appliance will help prevent potential negative consequences for the environment and human health.
4. For more detailed information about disposal of your old appliance, please contact your city office, waste disposal service or the shop where you purchased the product.

French

Élimination de votre ancien appareil

1. Ce symbole, représentant une poubelle sur roulettes barrée d'une croix, signifie que le produit est couvert par la directive européenne 2002/96/EC.
2. Les éléments électriques et électroniques doivent être jetés séparément, dans les vide-ordures prévus à cet effet par votre municipalité.
3. Une élimination conforme aux instructions aidera à réduire les conséquences négatives et risques éventuels pour l'environnement et la santé humaine.
4. Pour plus d'information concernant l'élimination de votre ancien appareil, veuillez contacter votre mairie, le service des ordures ménagères ou encore la magasin où vous avez acheté ce produit.

Italian

Smaltimento delle apparecchiature obsolete

1. Quando su un prodotto è riportato il simbolo di

un bidone della spazzatura barrato da una croce significa che il prodotto è coperto dalla direttiva europea 2002/96/EC.

2. Tutti i prodotti elettrici ed elettronici dovrebbero essere smaltiti separatamente rispetto alla raccolta differenziata municipale, mediante impianti di raccolta specifici designati dal governo o dalle autorità locali.
3. Il corretto smaltimento delle apparecchiature obsolete contribuisce a prevenire possibili conseguenze negative sulla salute umana e sull'ambiente.
4. Per informazioni più dettagliate sullo smaltimento delle apparecchiature obsolete, contattare il comune, il servizio di smaltimento rifiuti o il negozio in cui è stato acquistato il prodotto.

Swedish

Kassering av din gamla apparat

1. När den här symbolen med en överkryssad soptunna på hjul sitter på en produkt innebär det att den regleras av European Directive 2002/96/EC.
2. Alla elektriska och elektroniska produkter bör kasseras via andra vägar än de som finns för hushållsavfall, helst via för ändamålet avsedda uppsamlingsanläggningar som myndigheterna utser.
3. Om du kasserar din gamla apparat på rätt sätt så bidrar du till att förhindra negativa konsekvenser för miljön och människors hälsa.
4. Mer detaljerad information om kassering av din gamla apparat kan fås av kommunen, renhållningsverket eller den butik där du köpte produkten.

Dutch

Uw oude toestel wegdoen

1. Als het symbool met de doorgekruiste verrijdbare afvalbak op een product staat, betekent dit dat het product valt onder de Europese Richtlijn 2002/96/EC.
2. Elektrische en elektronische producten mogen niet worden meegegeven met het huishoudelijk afval, maar moeten worden ingeleverd bij speciale inzamelingspunten die door de lokale of landelijke overheid zijn aangewezen.
3. De correcte verwijdering van uw oude toestel helpt negatieve gevolgen voor het milieu en de menselijke gezondheid voorkomen.

Regulatory Information cont.

4. Wilt u meer informatie over de verwijdering van uw oude toestel? Neem dan contact op met uw gemeente, de afvalophaaldienst of de winkel waar u het product hebt gekocht.

Finnish

Vanhonjen laitteiden hävittäminen

1. Tämä merkki tuotteessa tarkoittaa, että tuote kuuluu sähkö- ja elektroniikkalaiteromusta annetun EU-direktiivin 2002/96/EY soveltamisalaan.
2. Kaikki elektroniset laitteet ovat ongelmajätettä, joten ne on toimitettava paikalliseen keräyspisteeseen.
3. Vanhan laitteen asianmukainen hävittäminen ehkäisee mahdollisia ympäristöön ja terveyteen kohdistuvia haittavaikutuksia.
4. Lisätietoa vanhan laitteen hävittämisestä saat ottamalla yhteyden paikallisiin viranomaisiin, kierrätyskeskukseen tai myymälään, josta ostit laitteen.

German

Entsorgung von Altgeräten

1. Wenn dieses Symbol eines durchgestrichenen Abfalleimers auf einem Produkt angebracht ist, unterliegt dieses Produkt der europäischen Richtlinie 2002/96/EC.
2. Alle Elektro- und Elektronik-Altgeräte müssen getrennt vom Hausmüll über dafür staatlich vorgesehenen Stellen entsorgt werden.
3. Mit der ordnungsgemäßen Entsorgung des alten Geräts vermeiden Sie Umweltschäden und eine Gefährdung der persönlichen Gesundheit.
4. Weitere Informationen zur Entsorgung des alten Geräts erhalten Sie bei der Stadtverwaltung, beim Entsorgungsamt oder in dem Geschäft, wo Sie das Produkt erworben haben.

Danish

Sådan smider du dit gamle apparat ud

1. Når der er et tegn med et kryds over en skraldespand, betyder det, at produktet er omfattet af EU-direktiv 2002/96/EC.
2. Alle elektriske og elektroniske produkter skal smides ud et andet sted end gennem den kommunale affaldsordning ved hjælp af specielle indsamlingsfaciliteter, der er organiseret af staten

eller de lokale myndigheder.

3. Korrekt bortskaffelse af dit gamle apparat er med til at forhindre mulige skadevirkninger på miljøet og menneskelig sundhed.
4. Mere detaljerede oplysninger om bortskaffelse af dit gamle apparat kan fås ved at kontakte dit lokale kommunekontor, renovationselskab eller den butik, hvor du købte produktet.

Greek

Απόρριψη της παλιάς σας συσκευής

1. Όταν ένα προϊόν διαθέτει το σύμβολο ενός διαγραμμένου κάλαθου απορριμμάτων, τότε το προϊόν καλύπτεται από την Ευρωπαϊκή Οδηγία 2002/96/ΕΟΚ.
2. Η απόρριψη όλων των ηλεκτρικών και ηλεκτρονικών προϊόντων πρέπει να γίνεται χωριστά από τα γενικά οικιακά απορρίμματα μέσω καθορισμένων εγκαταστάσεων συλλογής απορριμμάτων, οι οποίες έχουν δημιουργηθεί είτε από την κυβέρνηση ή από τις τοπικές αρχές.
3. Η σωστή απόρριψη της παλιάς σας συσκευής θα βοηθήσει στην αποτροπή πιθανών αρνητικών συνπειών ως προς το περιβάλλον και την υγεία του ανθρώπου.
4. Για πιο λεπτομερείς πληροφορίες σχετικά με την απόρριψη της παλιάς σας συσκευής, επικοινωνήστε με το αρμόδιο τοπικό γραφείο, υπηρεσία διάθεσης οικιακών απορριμμάτων ή το μαγαζί από το οποίο αγοράσατε το προϊόν.

Spanish

Cómo deshacerse de aparatos eléctricos y electrónicos viejos

1. Si en un producto aparece el símbolo de un contenedor de basura tachado, significa que éste se acoge a la Directiva 2002/96/CE.
2. Todos los aparatos eléctricos o electrónicos se deben desechar de forma distinta del servicio municipal de recogida de basura, a través de puntos de recogida designados por el gobierno o las autoridades locales.
3. La correcta recogida y tratamiento de los dispositivos inservibles contribuye a evitar riesgos potenciales para el medio ambiente y la salud pública.
4. Para obtener más información sobre cómo deshacerse de sus aparatos eléctricos y electrónicos viejos, póngase en contacto con su ayuntamiento, el servicio de recogida de basuras o el establecimiento donde adquirió el producto.

Regulatory Information cont.

Portuguese

Eliminação do seu antigo aparelho

1. Quando este símbolo de latão cruzado estiver afixado a um produto, significa que o produto é abrangido pela Directiva Europeia 2002/96/EC.
2. Todos os produtos eléctricos e electrónicos devem ser eliminados separadamente do lixo doméstico através de pontos de recolha designados, facilitados pelo governo ou autoridades locais.
3. A eliminação correcta do seu aparelho antigo ajuda a evitar potenciais consequências negativas para o ambiente e para a saúde humana.
4. Para obter informações mais detalhadas acerca da eliminação do seu aparelho antigo, contacte as autoridades locais, um serviço de eliminação de resíduos ou a loja onde comprou o produto.

Slovak

Likvidácia váš ho starého prístroja

1. Keď sa na produkte nachádza tento symbol prečiarknutej smetnej nádoby s kolieskami, znamená to, že daný produkt vyhovuje európskej Smernici č. 2002/96/EC.
2. Všetky elektrické a elektronické produkty by mali byť zlikvidované oddelene od komunálneho odpadu prostredníctvom na to určených zberných zariadení, ktoré boli ustanovené vládou alebo orgánmi miestnej správy.
3. Správnu likvidáciu starých zariadení pomôžete predchádzať potenciálnym negatívnym následkom pre prostredie a ľudské zdravie.
4. Podrobnejšie informácie o likvidácii starých zariadení nájdete na miestnom úrade, v službe na likvidáciu odpadu alebo u predajcu, kde ste tento produkt zakúpili.

Czech

Likvidace starých spotřebičů

1. Pokud je u výrobku uveden symbol pojízdného kontejneru v přeškrtnutém poli, znamená to, že na výrobek se vztahuje směrnice Evropské unie číslo 2002/96/EC.
2. Všechny elektrické a elektronické výrobky by měly být likvidovány odděleně od běžného komunálního odpadu prostřednictvím sběrných zařízení zřízených za tímto účelem vládou nebo místní samosprávou.
3. Správný způsob likvidace starého elektrického spotřebiče pomáhá zamezit možným negativním dopadům na životní prostředí a zdraví.
4. Bližší informace o likvidaci starého spotřebiče získáte u místní samosprávy, ve sběrném zařízení nebo v obchodě, ve kterém jste výrobek zakoupili.

Croatian

Uklanjanje starog aparata

1. Ako se na proizvodu nalazi simbol prekrizhene kante za smeće, to znači da je proizvod pokriven europskom direk-

tivom 2002/96/EC.

2. Električni i elektronski proizvodi ne smiju se odlagati zajedno s komunalnim otpadom, već u posebna odlagališta koja je odredila vlada ili lokalne vlasti.
3. Pravilno odlaganje starog proizvoda sprečiti će potencijalne negativne posljedice po okoliš i zdravlje ljudi.
4. Podrobnije informacije o odlaganju starog proizvoda potražite u gradskom uredu, službi za odlaganje otpada ili u trgovini u kojoj ste kupili proizvod.

Hungarian

Régi eszközök ártalmatlanítása

1. A termékhez csatolt áthúzott, keresek szeméttároló jel jelöli, hogy a termék a 2002/96/EC EU-direktíva hatálya alá esik.
2. Minden elektromos és elektronikai terméket a lakossági hulladéktól elkülönítve kell begyűjteni, a kormány vagy az önkormányzatok által kijelölt begyűjtő eszközök használatával.
3. Régi eszközeinek megfelelő ártalmatlanítása segíthet megelőzni az esetleges egészségre vagy környezetre ártalmas hatásokat.
4. Ha több információra van szüksége régi eszközeinek ártalmatlanításával kapcsolatban, tanulmányozza a vonatkozó környezetvédelmi szabályokat, vagy lépjen kapcsolatba az üzlettel, ahol a terméket vásárolta.

Polish

Utylizacja starych urządzeń

1. Kiedy do produktu dołączony jest niniejszy przekreślony symbol kołowego pojemnika na śmieci, oznacza to, że produkt jest objęty dyrektywą 2002/96/EC.
2. Wszystkie elektryczne i elektroniczne produkty powinny być utylizowane niezależnie od odpadów miejskich, z wykorzystaniem przeznaczonych do tego miejsc składowania wskazanych przez rząd lub miejscowe władze.
3. Właściwy sposób utylizacji starego urządzenia pomoże zapobiec potencjalnie negatywnemu wpływowi na zdrowie i środowisko.
4. Aby uzyskać więcej informacji o sposobach utylizacji starych urządzeń, należy skontaktować się z władzami lokalnymi, przedsiębiorstwem zajmującym się utylizacją odpadów lub sklepem, w którym produkt został kupiony.

■ ■ ■ Regulatory Information cont.

■ ■ Estonian

Kasutuskõlbmatu seadme käitlemise kord

1. Kui seade on märgistatud selle elektri- ja elektroonikaseadmete lahuskogumist märgistava tähisega (ratastega prügikonteineri kujutis, millele on rist peale tõmmatud), tuleb toodet käidelda vastavalt Eurodirektiivile 2002/96/EÜ.
2. Elektri- ja elektroonikaseadmeid ei tohi visata tavalise prügi hulka. Nad kuuluvad lahuskogumisele selleks määratud kogumispunktides.
3. Kasutuskõlbmatu tervikseadme käitlemine tavaprügist lahus on korraldatud selleks, et vältida negatiivseid tagajärgi, mida põhjustaksid seadme osade purunemisel vabaneda võivad ohtlikud jäätmed loodusele või inimorganismile.
4. Täpsemat informatsiooni selle kohta, kuhu ja millal saab ära anda oma kasutamiskõlbmatu elektri- ja elektroonikaseadme, küsige kohalikult omavalitsuselt, prügifirmalt või kaupluselt, kust seadme ostsite.

■ ■ Latvian

Vecās elektroierīces nodošana

1. Ja uz produkta ir simbols ar pārsvītrotu atkritumu tvertni, tas nozīmē, ka produkts ir iekļauts Eiropas direktīvā 2002/96/EC.
2. Visi elektriskie un elektroniskie produkti ir jāutilizē, nododot pašvaldības īpaši noteiktās pieņemšanas vietās. Tos nedrīkst izmest parastās municipalitātes atkritumu urnās.
3. Ievērojot prasības veco elektroierīču utilizēšanā, jūs pasargāsiet apkārtējo vidi un cilvēku veselību no iespējami nelabvēlīgajām sekām, kādas varētu rasties, ierīcēm sadaloties nepiemērotā vietā.
4. Lai gūtu plašāku informāciju par veco ierīču utilizēšanas iespējām, sazinieties ar pilsētas pašvaldību, atkritumu savākšanas saimniecību vai veikalu, kurā ierīci iegādājāties.

■ ■ Lithuanian

Senos įrangos atliekų tvarkymas

1. Užbrauktas konteinerio simbolis priverčia ant prekės reiškia, kad įrangą saugo Europos direktyva 2002/96/EC.
2. Visos elektros ir elektroninės įrangos atliekos turi būti renkamos atskirai ir neišmetamos į atliekų konteinerį kartu su kitomis komunalinėmis atliekomis, taikant specialią atliekų surinkimo sistemą, patvirtintą vyriausybės ar vietos valdžios.
3. Teisingas senos įrangos atliekų tvarkymas, padės išvengti neigiamų pasekmių aplinkai ir žmonių sveikatai.
4. Dėl išsamesnės informacijos apie senos įrangos tvarkymą, prašome kreiptis į miesto valdžią, atliekų perdirbimo tarnybą arba parduotuvę, kurioje pirkote įrangą.