



LG

Life's Good

ENGLISH

OWNER'S MANUAL

LCD MONITOR

Please read this manual carefully before operating the your set and retain it for future reference.

LCD MONITOR MODEL

IPS225V

IPS235V

MODEL NO.:

IPS235*X

IPS225*X

CONTENTS

3 ASSEMBLING AND PREPARING

- 3 Unpacking
- 4 Parts and buttons
- 6 Setting up the Monitor set
 - 6 - Attaching the Stand Base
 - 6 - Detaching the Stand Base
- 7 - Mounting on a table
- 8 - Mounting on a wall

10 USING THE MONITOR SET

- 10 Connecting to a PC
 - 10 - D-SUB connection
 - 10 - DVI-D connection
 - 10 - HDMI connection

12 CUSTOMIZING SETTINGS

- 12 Accessing The Main Menus
- 13 Customizing Settings
 - 13 - Menu Settings
 - 14 - PICUURE
 - 15 - COLOR
 - 16 -DISPLAY
 - 16 -VOLUME
 - 17 -OTHERE
- 18 MODE Setting
- 19 DUAL PACKAGE Setting

20 TROUBLESHOOTING

22 SPECIFICATIONS

- 22 IPS225V
- 23 IPS235V
- 24 Preset Modes (Resolution)
- 24 Indicator

ASSEMBLING AND PREPARING

Unpacking

Check your product box for the following items. If there are any missing accessories, contact the local dealer where you purchased your product. The illustrations in this manual may differ from the actual product and accessories.

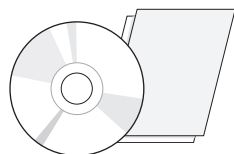

**CD(Owner's Manual) /
Card**



Power Cord

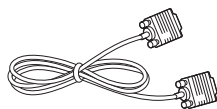

D-SUB Cable

(This signal cable may be attached to this product before shipping out.)

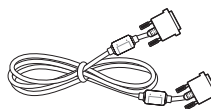

DVI-D Cable

(This cable is not included in all countries.)

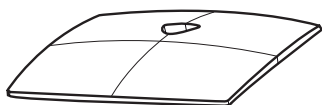

Stand Base



CAUTION

- Do not use any unapproved accessories to ensure the safety and product life span.
- Any damages or injuries by using unapproved accessories are not covered by the warranty.



NOTE

- The accessories supplied with your product may vary depending on the model.
- Product specifications or contents in this manual may be changed without prior notice due to upgrade of product functions.
- User should use shielded signal interface cables (RGB cable / DVI-D cable) with ferrite cores to maintain standard compliance for the product.

Parts and buttons

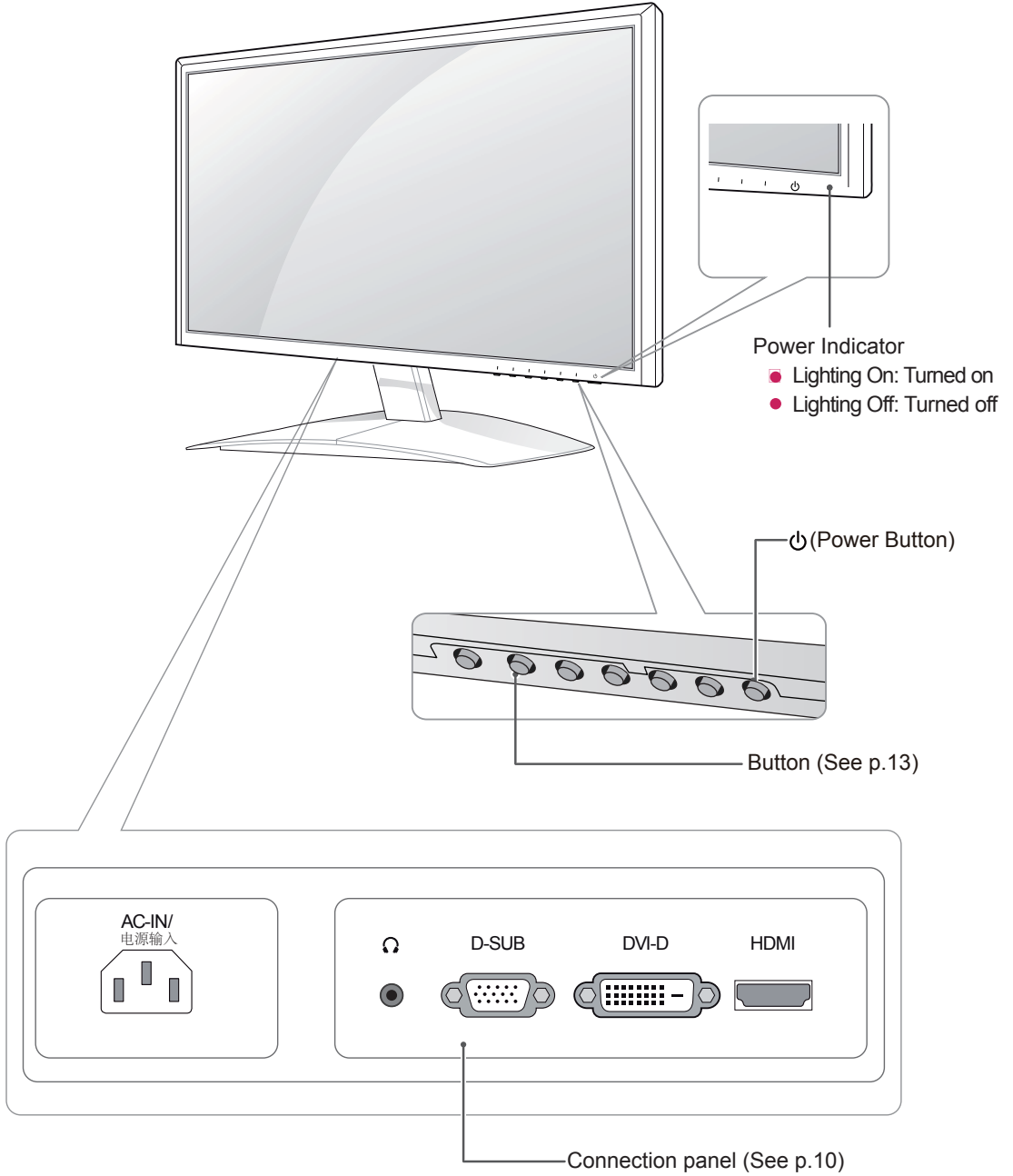

Button	Description		
MENU	<p>Accesses the main menus.(See p.13)</p> <table border="1" data-bbox="385 247 1234 426"> <tr> <td data-bbox="385 247 632 426">OSD LOCKED/ UNLOCKED</td> <td data-bbox="632 247 1234 426"> <p>This function allows you to lock the current control settings, so that they cannot be inadvertently changed. Press and hold the MENU button for several seconds. The message "OSD LOCKED" should appear. You can unlock the OSD controls at any time by pushing the MENU button for several seconds. The message "OSD UNLOCKED" should appear.</p> </td> </tr> </table>	OSD LOCKED/ UNLOCKED	<p>This function allows you to lock the current control settings, so that they cannot be inadvertently changed. Press and hold the MENU button for several seconds. The message "OSD LOCKED" should appear. You can unlock the OSD controls at any time by pushing the MENU button for several seconds. The message "OSD UNLOCKED" should appear.</p>
OSD LOCKED/ UNLOCKED	<p>This function allows you to lock the current control settings, so that they cannot be inadvertently changed. Press and hold the MENU button for several seconds. The message "OSD LOCKED" should appear. You can unlock the OSD controls at any time by pushing the MENU button for several seconds. The message "OSD UNLOCKED" should appear.</p>		
MODE	Use this button to enter USER ,MOVE,TEXT, PHOTO,sRGB menus.(See p.18)		
DUAL	Use this button to enter DUAL MONITOR and DUAL WEB menus.(See p.19)		
AUTO	<p>When adjusting your display settings, always press the AUTO button on the MONITOR SETUP OSD. (Only supported in Analog Mode)</p> <table border="1" data-bbox="385 595 1234 629"> <tr> <td data-bbox="385 595 632 629">The best display mode</td> <td data-bbox="632 595 1234 629">1920 x 1080</td> </tr> </table>	The best display mode	1920 x 1080
The best display mode	1920 x 1080		
INPUT	<p>You can choose the input signal.</p> <ul style="list-style-type: none"> <input type="checkbox"/> When two input signals are connected, you can select the input signal (D-SUB/DVI/ HDMI) you want. <input type="checkbox"/> When only one signal is connected, it is automatically detected. The default setting is D-SUB. 		
EXIT	Exit the OSD(On Screen Display).		
 (Power Button)	<p>Turns the power on or off.</p> <table border="1" data-bbox="385 852 1234 933"> <tr> <td data-bbox="385 852 632 933">Power Indicator</td> <td data-bbox="632 852 1234 933"> <p>The power indicator stays blue if the display is running properly (On Mode). If the display is in Sleep Mode, the power indicator blinks blue.</p> </td> </tr> </table>	Power Indicator	<p>The power indicator stays blue if the display is running properly (On Mode). If the display is in Sleep Mode, the power indicator blinks blue.</p>
Power Indicator	<p>The power indicator stays blue if the display is running properly (On Mode). If the display is in Sleep Mode, the power indicator blinks blue.</p>		

Setting up the Monitor set

Attaching the Stand Base

- 1 Place the Monitor set with the screen side down on a flat and cushioned surface.



CAUTION

Lay a foam mat or soft protective cloth on the surface to protect the screen from damage.

- 2 Attach the **Stand Base** and then tighten the screw to the right with a **Coin**.

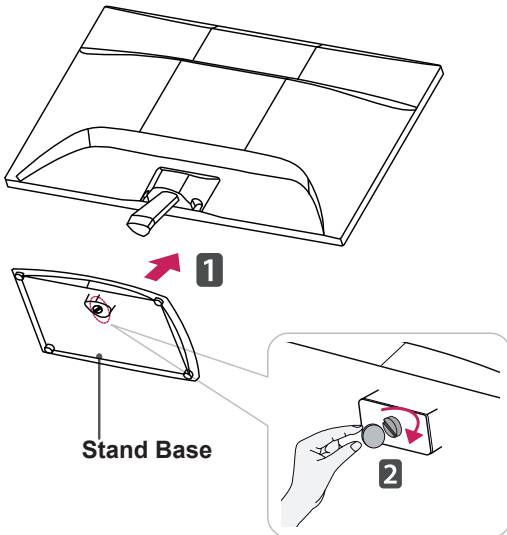

Detaching the Stand Base and Body

- 1 Place the Monitor set with the screen side down on a flat and cushioned surface.
- 2 Turn the screw to the left, and then pull out the **Stand Base** from the **Stand Body**.

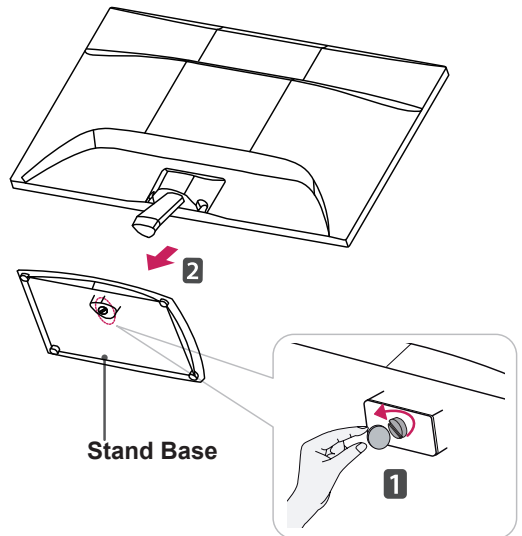

CAUTION

- This illustration depicts the general model of connection. Your monitor may differ from the items shown in the picture.
- Do not carry the product upside down holding only the stand base. The product may fall and get damaged or injure your foot.

Mounting on a table

- 1 Lift and tilt the Monitor set into its upright position on a table.
Leave a 10 cm (minimum) space from the wall for proper ventilation.

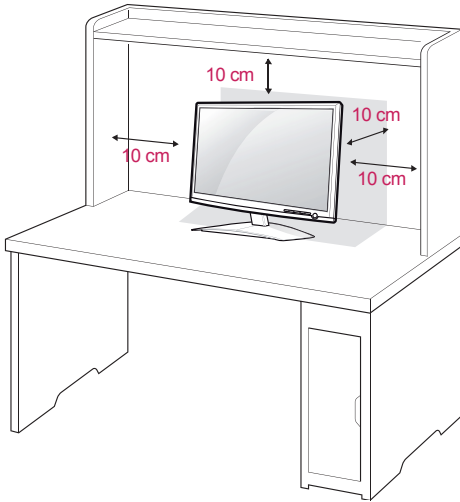

- 2 Connect the Power Cord to a wall outlet.

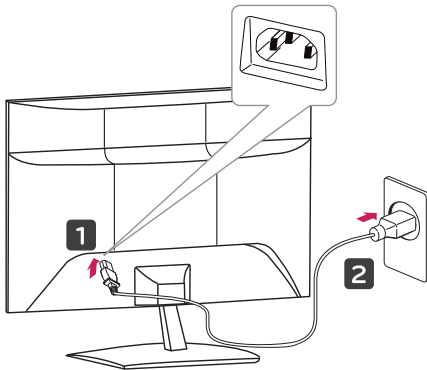

- 3 Press  (Power) button on the front switch panel to turn the power on.



CAUTION

Unplug the power cord before moving the Monitor to another location. Otherwise electric shock may occur.



WARNING

When you adjust the angle, do not hold the bottom of the Monitor set frame as shown on the following illustration, as may injure your fingers.

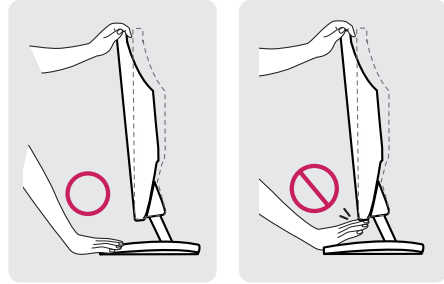

Do not touch or press the screen when adjusting the angle of the monitor.

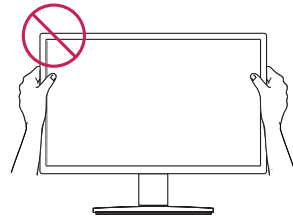

NOTE

Tilt from +15 to -5 degrees up or down to adjust the angle of the Monitor set to suit your view.

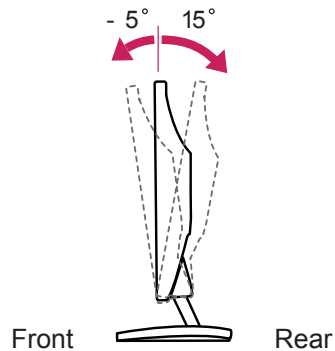

Using the Kensington security system

The Kensington security system connector is located at the back of the Monitor set. For more information of installation and using, refer to the manual supplied with the Kensington security system or visit <http://www.kensington.com>.

Connect the Kensington security system cable between the Monitor set and a table.

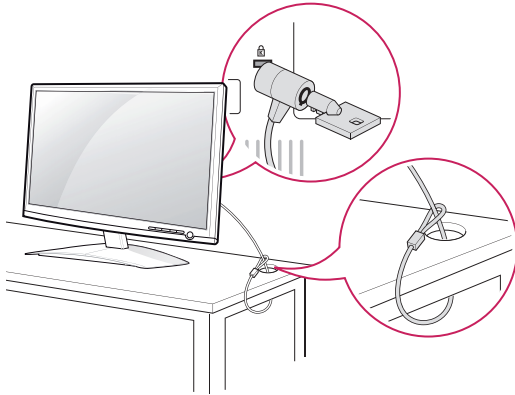

! NOTE

The Kensington security system is optional. You can obtain it from most electronics stores.

Mounting on a wall

For proper ventilation, allow a clearance of 10 cm on each side and from the wall. Detailed instructions are available from your dealer, see the optional Tilt Wall Mounting Bracket Installation and Setup Guide.

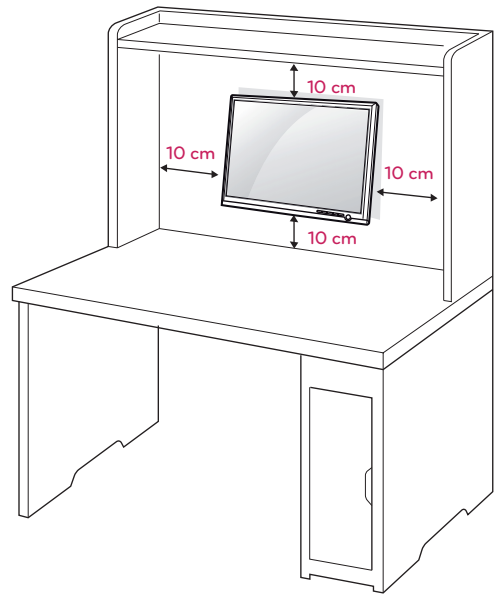

When you install the Monitor set using a wall mounting interface (optional parts), attach it carefully so it will not drop.

Please use VESA standard as below.

- 784.8 mm (30.9 inch) and under
 - * Wall Mount Pad Thickness : 2.6 mm
 - * Screw : Φ 4.0 mm x Pitch 0.7 mm x Length 10 mm
- 787.4 mm (31.0 inch) and above
 - * Please use VESA standard wall mount pad and screws.

Model	IPS225V//IPS235V
VESA (A x B)	100 x 100
Standard screw	M4
Number of screws	4

**CAUTION**

- Disconnect the power cord first, and then move or install the Monitor set. Otherwise electric shock may occur.
- If you install the Monitor set on a ceiling or slanted wall, it may fall and result in severe injury.
- Use only an authorized LG wall mount and contact the local dealer or qualified personnel.
- Do not over tighten the screws as this may cause damage to the Monitor set and void your warranty.
- Use only screws and wall mounts that meet the VESA standard. Any damages or injuries by misuse or using an improper accessory are not covered by the warranty.

**NOTE**

- Use the screws that are listed on the VESA standard screw specifications.
- The wall mount kit will include an installation manual and necessary parts.
- The wall mount bracket is optional. You can obtain additional accessories from your local dealer.
- The length of screws may differ depending on the wall mount. Be sure to use the proper length.
- For more information, refer to the instructions supplied with the wall mount.

USING THE MONITOR SET

Connecting to a PC

- Your Monitor set supports Plug & Play*.
- *Plug & Play: A PC recognizes a connected device that users connect to a PC and turn on, without device configuration or user intervention.

D-SUB connection

Transmits analog video from your PC to the Monitor set. Connect the PC and the Monitor set with the supplied D-sub 15 pin signal cable as shown in the following illustrations.

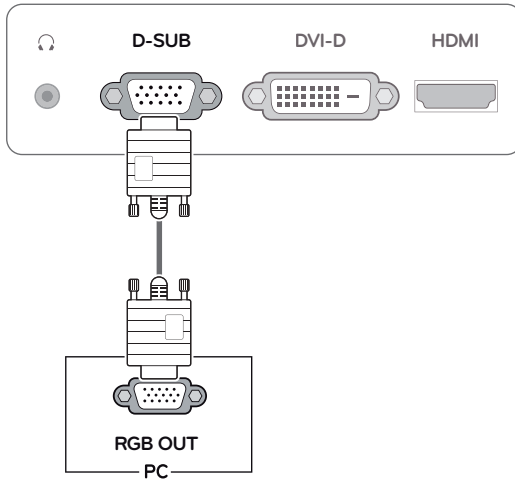

NOTE

- When using a D-Sub signal input cable connector for Macintosh

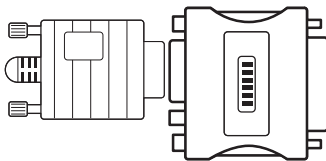

Mac adapter

For Apple Macintosh use, a separate plug adapter is needed to change the 15 pin high density (3 row) D-SUB VGA connector on the supplied cable to a 15 pin 2 row connector.

DVI-D connection

Transmits a digital video signal from your PC to the Monitor set. Connect the PC and the Monitor set with a DVI cable as shown in the following illustrations.

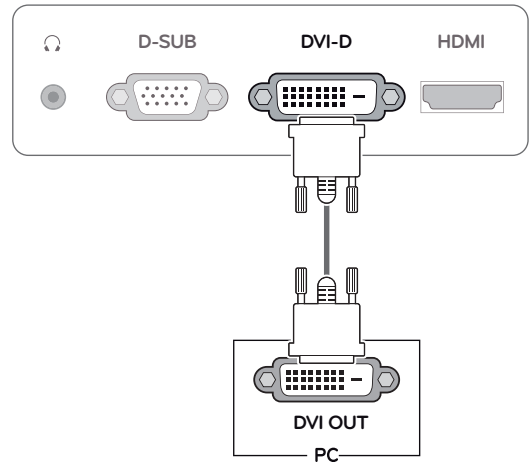

HDMI connection

Transmits the digital video and audio signals from your PC or A/V to the Monitor set. Connect the PC or A/V and the Monitor set with the HDMI cable as shown in the following illustrations.

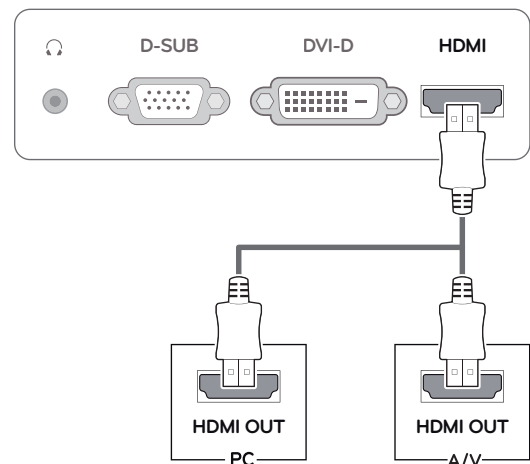

NOTE

- If you use HDMI PC, it can cause compatibility problem.

CAUTION

- Connect the signal input cable and tighten it by turning the screws clockwise.

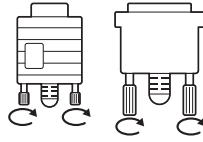

- Do not press the screen with your finger for a long time as this may result in temporary distortion on the screen.
- Avoid displaying a fixed image on the screen for a long period of time to prevent image burn. Use a screensaver if possible.

Self Image Setting Function

Press the power button on the front panel to turn the power on. When monitor power is turned on, the "Self Image Setting" Function is executed automatically. (Only supported in Analog Mode)

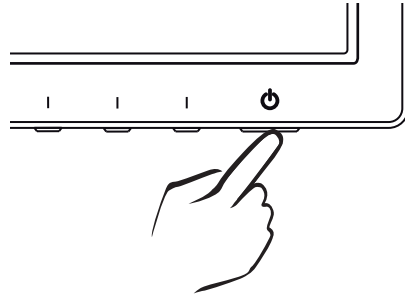

NOTE

- When you want to use two PC in our Monitor, please connect the signal cable(D-SUB/ DVI-D/HDMI) respectively in Monitor set.
- If you turn the Monitor set on while it is cold, the screen may flicker. This is normal.
- Some red, green, or blue spots may appear on the screen. This is normal.

NOTE

- "Self Image Setting" Function.
This function provides the user with optimal display settings. When the user connects the monitor for the first time, this function automatically adjusts the display to optimal settings for individual input signals. (Only supported in Analog Mode)
- 'AUTO' Function.
When you encounter problems such as blurry screen, blurred letters, screen flicker or tilted screen while using the device or after changing screen resolution, press the AUTO function button to improve resolution. (Only supported in Analog Mode)

CUSTOMIZING SETTINGS

Accessing The Main Menu

- 1 Press any button on the front of the Monitor set to display the **MONITOR SETUP** OSD menu.
- 2 Press the desired menu item.
- 3 Change the value of the menu item by pressing the buttons on the front of the Monitor set.
To return to the upper menu or set other menu items, use the up arrow (↑) button.
- 4 Select **EXIT** to leave the OSD menu.

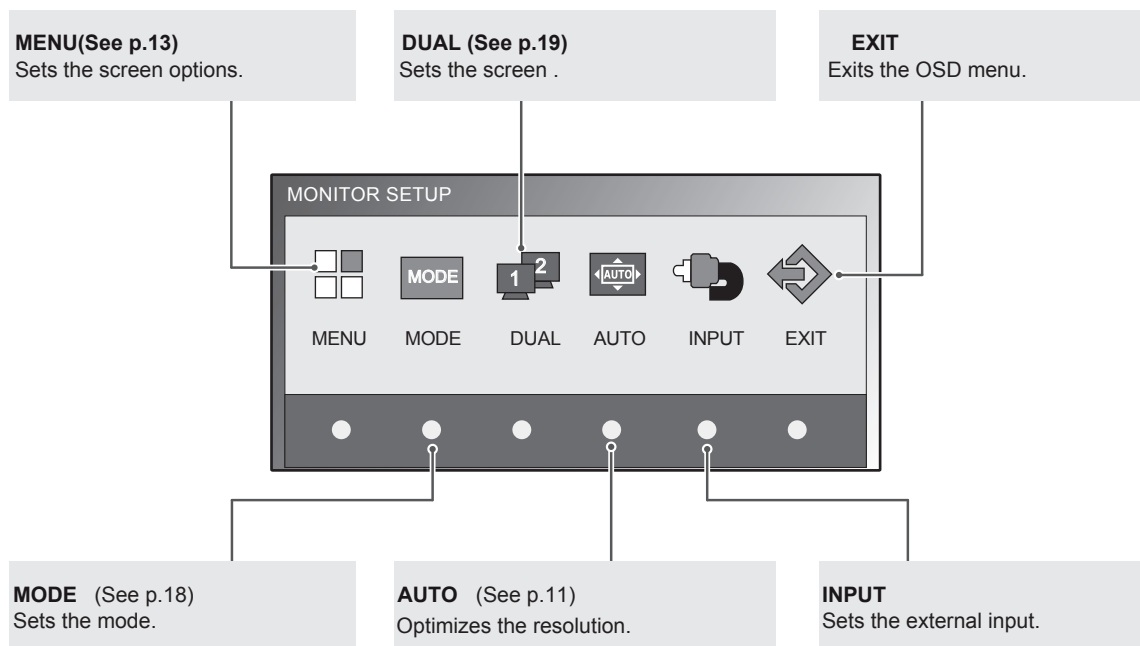
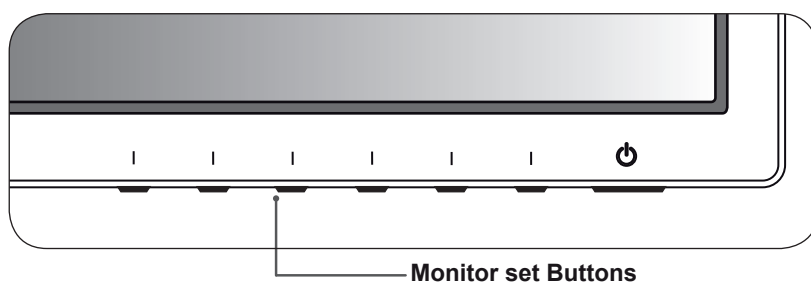

NOTE

Different menu items are enabled depending on the type of input signal.

- **D-SUB / DVI Mode:** MENU, MODE, DUAL, AUTO, INPUT, EXIT

Customizing Settings

Menu Settings

- 1 Press any button on the front of the Monitor set to display the MONITOR SETUP OSD menu.
- 2 Press the MENU button to display the options in the OSD menu.
- 3 Set the options by pressing the buttons on the front of the Monitor set.
- 4 Select EXIT to leave the OSD menu.
To return to the upper menu or set other menu items, use the up arrow (↑) button.

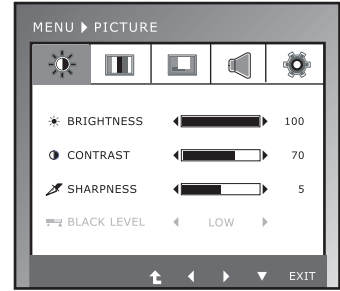

The available program settings are described below.

Menu	Sub-menu	Analog	Digital	HDMI	Description
PICTURE	BRIGHTNESS	•	•	•	To adjust the brightness, contrast and sharpness of the screen
	CONTRAST				
	SHARPNESS				
	BLACK LEVEL				
COLOR	COLOR TEMP (PRESET/USER)	•	•	•	To customize the color of the screen.
	GAMMA				
	COLOR RESET				
DISPLAY	HORIZONTAL	•			To adjust the position of the screen
	VERTICAL				
	CLOCK PHASE	•			To improve the clarity and stability of the screen
	OVERSCAN			•	
VOLUME				•	To adjust the volume
OTHERS	LANGUAGE	•	•	•	To customize the screen status for a user's operating environment
	POWER INDICATOR				
	WHITE BALANCE				
	ORIGINAL RATIO				
	SUPER ENERGY SAVING				
	FACTORY RESET	•	•	•	

- Analog: D-SUB(Analog signal) input.
- Digital: DVI-D(Digital signal) input.
- HDMI: HDMI(Digital signal) input.

PICTURE

- 1 Press any button on the front of the Monitor set to display the MONITOR SETUP OSD menu.
- 2 Press the MENU button to display the options in the OSD menu.
- 3 Select PICTURE by pressing the buttons on the front of the Monitor set and set the options.
- 4 Select EXIT to leave the OSD menu.
To return to the upper menu or set other menu items, use the up arrow (↑) button.

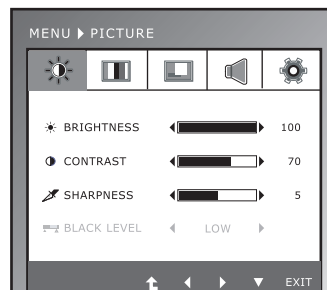

The available picture settings are described below.

Menu	Description
BRIGHTNESS	To adjust the brightness of the screen.
CONTRAST	To adjust the contrast of the screen.
SHARPNESS	To adjust the clearness of the screen.
BLACK LEVEL	You can set the offset level. If you select 'HIGH', the screen will be bright and if you select 'LOW', the screen will be dark. (only for HDMI input) * Offset? As the criteria for video signal, it is the darkest screen the monitor can show.

COLOR

- 1 Press any button on the front of the Monitor set to display the MONITOR SETUP OSD menu.
- 2 Press the MENU button to display the options in the OSD menu.
- 3 Select COLOR by pressing the buttons on the front of the Monitor set and set the options.
- 4 Select EXIT to leave the OSD menu.
To return to the upper menu or set other menu items, use the up arrow (↑) button.

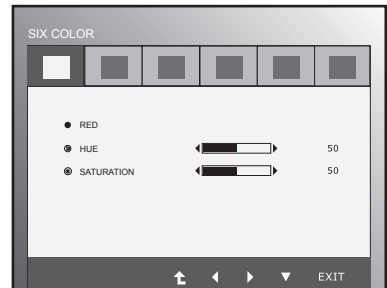
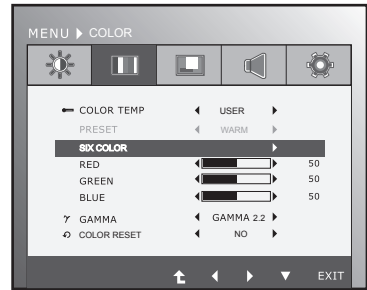

The available picture settings are described below.

Menu	Description				
COLOR TEMP	PRESET Select the screen color. <ul style="list-style-type: none"> ● WARM: Set the screen to warm color temperature (more red). ● MEDIUM: Set the screen to medium color temperature. ● COOL: Set the screen to cool color temperature (More blue). 				
	USER <ul style="list-style-type: none"> ● SIX COLOUR: Sets and stores the hue and saturation for six colors (RED/GREEN/BLUE/CYAN/MAGENTA/YELLOW) to satisfy the color requirements of a user. <table border="1" style="width: 100%; border-collapse: collapse;"> <tr> <td style="width: 30%;">HUE</td> <td>Adjusts the screen hue.</td> </tr> <tr> <td>SATURATION</td> <td>Adjusts the color sharpness on the screen. Lower values make the color sharpness weaker and colors lighter while sharpness stronger and colors darker.</td> </tr> </table> ● RED: Set your own red color levels. ● GREEN: Set your own green color levels. ● BLUE: Set your own blue color levels. 	HUE	Adjusts the screen hue.	SATURATION	Adjusts the color sharpness on the screen. Lower values make the color sharpness weaker and colors lighter while sharpness stronger and colors darker.
HUE	Adjusts the screen hue.				
SATURATION	Adjusts the color sharpness on the screen. Lower values make the color sharpness weaker and colors lighter while sharpness stronger and colors darker.				
GAMMA	Set your own gamma value. : 1.8/2.0/2.2/2.4/2.6 On the monitor, high gamma values display whitish images and low gamma values display blackish images.				
COLOR RESEST	Resets the color settings to the factory default settings for the current input device.				

DISPLAY

- 1 Press any button on the front of the Monitor set to display the MONITOR SETUP OSD menu.
- 2 Press the MENU button to display the options in the OSD menu.
- 3 Select DISPLAY by pressing the buttons on the front of the Monitor set and set the options.
- 4 Select EXIT to leave the OSD menu.
To return to the upper menu or set other menu items, use the up arrow (↑) button.

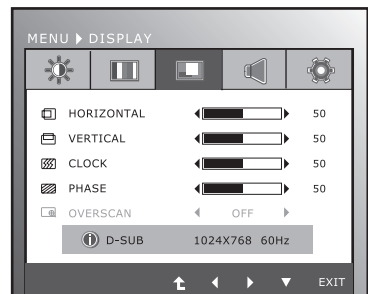

The available picture settings are described below.

Menu	Description
HORIZONTAL	To move image left and right.
VERTICAL	To move image up and down.
CLOCK	To minimize any vertical bars or stripes visible on the screen background. The horizontal screen size will also change.
PHASE	To adjust the focus of the display. This item allows you to remove any horizontal noise and clear or sharpen the image of characters.
OVERSCAN	To select the range of output image for DTV timing in HDMI input. (only for HDMI input) Recommend overscan function to turn on when connect AV equipment.

VOLUME

- 1 Press any button on the front of the Monitor set to display the MONITOR SETUP OSD menu.
- 2 Press the MENU button to display the options in the OSD menu.
- 3 Select VOLUME by pressing the buttons on the front of the Monitor set and set the options.
- 4 Select EXIT to leave the OSD menu.
To return to the upper menu or set other menu items, use the up arrow (↑) button.



The available picture settings are described below.

Menu	Description
VOLUME	To adjust the volume of headphone/ Earphone. (Only for HDMI input)

OTHER

- 1 Press any button on the front of the Monitor set to display the MONITOR SETUP OSD menu.
- 2 Press the MENU button to display the options in the OSD menu.
- 3 Select OTHERS by pressing the buttons on the front of the Monitor set and set the options.
- 4 Select EXIT to leave the OSD menu.
To return to the upper menu or set other menu items, use the up arrow (↑) button.

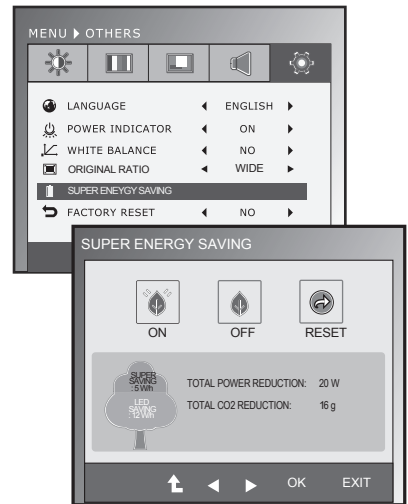

The available picture settings are described below.

Menu	Description						
LANGUAGE	To choose the language in which the control names are displayed.						
POWER INDICATOR	Use this function to set the power indicator on the front side of the monitor to ON or OFF. If you set OFF, it will go off. If you set ON at any time, the power indicator will automatically be turned on.						
WHITE BALANCE	If the output of the video card is different the required specifications, the color level may deteriorate due to video signal distortion. Using this function, the signal level is adjusted to fit into the standard output level of the video card in order to provide the optimal image. Activate this function when white and black colors are present in the screen.						
ORIGINAL RATIO	<p>WIDE</p> <p>Switch to full screen mode according to input image signal.</p> <p>ORIGINAL</p> <p>Change the input image signal ratio to original. * This function works only if input resolution is lower than Monitor set ratio (16:9).</p>						
SUPER ENEGY SAVING	<p>Sets the SUPER ENERGY SAVING function.</p> <table border="1"> <tr> <td>ON</td> <td>Enables SUPER ENERGY SAVING you can save energy with this energy-efficient function.</td> </tr> <tr> <td>OFF</td> <td>Disables SUPER ENERGY SAVING.</td> </tr> <tr> <td>RESET</td> <td>Resets the values of total energy consumption reduction and CO2 emission reduction estimates.</td> </tr> </table>	ON	Enables SUPER ENERGY SAVING you can save energy with this energy-efficient function.	OFF	Disables SUPER ENERGY SAVING.	RESET	Resets the values of total energy consumption reduction and CO2 emission reduction estimates.
ON	Enables SUPER ENERGY SAVING you can save energy with this energy-efficient function.						
OFF	Disables SUPER ENERGY SAVING.						
RESET	Resets the values of total energy consumption reduction and CO2 emission reduction estimates.						
FACTORY RESET	Restore all factory default settings except "LANGUAGE." Press the ◀ ▶ buttons to reset immediately.						

! NOTE

- TOTAL POWER REDUCTION: How much power is saved while using the monitor.
- TOTAL CO2 REDUCTION: Change the TOTAL POWER REDUCTION to CO2.
- SAVING DATA(W/h)

	545 mm (22 inch)	584 mm (23 inch)
SUPER SAVING	4 W/h	5 W/h
LED SAVING	15 W/h	12 W/h

- Saving Data depends on the Panel. So, those values should be different from each panel and panel vendor.
- LG calculated these values by using "broadcast video signal".
- LED Saving refers to how much power can be saved using a WLED Panel instead of CCFL panel.
- SUPER SAVING refers to how much power can be saved using the SUPER ENERGY SAVING function.

MODE Setting

- 1 Press any button on the front of the Monitor set to display the MONITOR SETUP OSD menu.
- 2 Press the MODE button to display the options in the OSD menu.
- 3 Set the options by pressing the buttons on the front of the Monitor set.
- 4 Select EXIT to leave the OSD menu. To return to the upper menu or set other menu items, use the up arrow (↑) button.

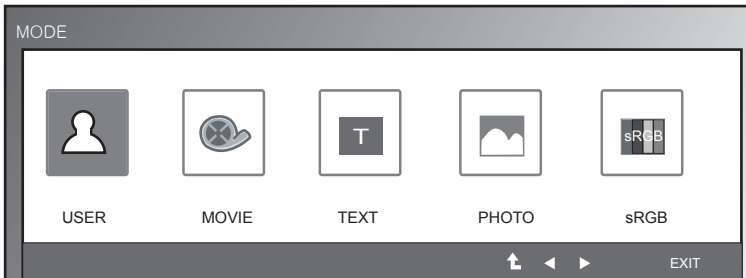

The available picture settings are described below.

Menu	Description
USER	It is a mode that the user can adjust each element. It can adjust the color mode of the Main Menu.
MOVIE	It is a mode that the screen is adjusted to the best to view the videos.
TEXT	It is a mode that the screen is adjusted to the best for the text works.
PHOTO	It is a mode that the screen is adjusted to the best to view pictures.
sRGB	It is a mode that the screen is adjusted to the standard sRGB.

DUAL PACKAGE Setting

- * Before using below functions, please install DUAL PACKAGE programme.
- * Only for D-SUB/DVI-D input.

- 1 Press any button on the front of the Monitor set to display the MONITOR SETUP OSD menu.
- 2 Press the DUAL button to display the options in the OSD menu.
- 3 Set the options by pressing the buttons on the front of the Monitor set.
- 4 Select EXIT to leave the OSD menu.
To return to the upper menu or set other menu items, use the up arrow (↑) button.

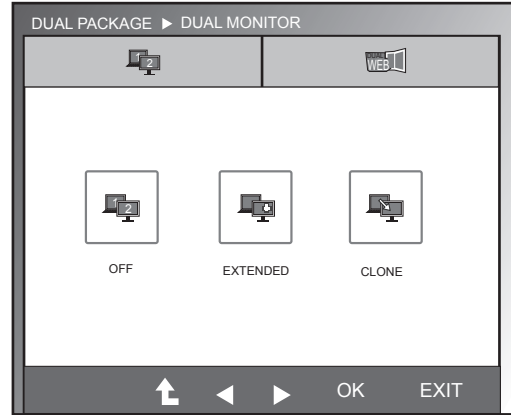

The available picture settings are described below.

Menu	Description	
DUAL MONTOR	OFF	If select OFF,DUALMONITOR off
	EXTENDED	By selecting EXETNDED,user can use secondary monitor as extended mode of primary monitor.
	CLONE	By selecting CLONE,user can use secondary monitor as done mode of primary monitor.
DUAL WEB	ON	Make the eye comfortable by reducing the background brightness in the web page.
	OFF	If select OFF,CINEMA MODE is off.

NOTE

When monitor goes to Power Saving Mode, on pressing any buttons user can bring back monitor to normal mode

TROUBLESHOOTING

Check the following before calling for service.

No image appears	
Is the power cord of the display connected?	<ul style="list-style-type: none"> • Check and see if the power cord is connected properly to the power outlet.
Is the power indicator light on?	<ul style="list-style-type: none"> • Press the Power button.
Is the power on and the power indicator blue or green?	<ul style="list-style-type: none"> • Adjust the brightness and the contrast.
Is the power indicator flickering?	<ul style="list-style-type: none"> • If the display is in power saving mode, try moving the mouse or pressing any key on the keyboard to bring up the screen. • Try to turn on the PC.
Do you see an "OUT OF RANGE" message on the screen?	<ul style="list-style-type: none"> • This message appears when the signal from the PC (video card) is out of horizontal or vertical frequency range of the display. See the 'Specifications' section of this manual and configure your display again.
Do you see a "CHECK SIGNAL CABLE" message on the screen?	<ul style="list-style-type: none"> • This message appears when the signal cable between your PC and your display is not connected. Check the signal cable and try again.

Do you see a "OSD LOCKED" message on the screen?	
Do you see "OSD LOCKED" when you push MENU button?	<ul style="list-style-type: none"> • You can secure the current control settings, so that they cannot be inadvertently changed. You can unlock the OSD controls at any time by pushing the MENU button for several seconds: the message "OSD UNLOCKED" will appear.

Display image is incorrect	
Display Position is incorrect.	<ul style="list-style-type: none"> • Press the AUTO button to automatically adjust your display image to the ideal setting.
On the screen background, vertical bars or stripes are visible.	<ul style="list-style-type: none"> • Press the AUTO button to automatically adjust your display image to the ideal setting.
Any horizontal noise appearing in any image or characters are not clearly portrayed.	<ul style="list-style-type: none"> • Press the AUTO button to automatically adjust your display image to the ideal setting. • Check Control Panel ► Display ► Settings and adjust the display to the recommended resolution or adjust the display image to the ideal setting. Set the color setting higher than 24 bits (true color).

**CAUTION**

- Check **Control Panel ► Display ► Settings** and see if the frequency or the resolution were changed. If yes, readjust the video card to the recommend resolution.
- If the recommended resolution (optimal resolution) is not selected, letters may be blurred and the screen may be dimmed, truncated or biased. Make sure to select the recommend resolution.
- The setting method can differ by computer and O/S (Operation System), and resolution mentioned above may not be supported by the video card performance. In this case, please ask to the computer or the video card manufacturer.

Display image is incorrect

The screen color is mono or abnormal.	<ul style="list-style-type: none"> • Check if the signal cable is properly connected and use a screwdriver to fasten if necessary. • Make sure the video card is properly inserted in the slot. • Set the color setting higher than 24 bits (true color) at Control Panel ► Settings.
The screen blinks.	<ul style="list-style-type: none"> • Check if the screen is set to interlace mode and if yes, change it to the recommend resolution.

Do you see an "Unrecognized monitor, Plug&Play (VESA DDC) monitor found" message?

Have you installed the display driver?	<ul style="list-style-type: none"> • Be sure to install the display driver from the display driver CD (or diskette) that comes with your display. Or, you can also download the driver from our web site: http://www.lg.com. • Make sure to check if the video card supports Plug&Play function.
--	--

SPECIFICATIONS

IPS225V

Display	Screen Type	54.5 cm (22 inch) Flat Panel Active matrix-TFT LCD Anti-Glare coating Visible diagonal size: 54.5 cm
	Pixel Pitch	0.247 mm x 0.247 mm (Pixel Pitch)
Sync Input	Horizontal Frequency	30 kHz to 83 kHz (Automatic)
	Vertical Frequency	56Hz to 75Hz (D-SUB, DVI-D) 56Hz to 61Hz (HDMI)
	Input Form	Separate Sync. Digital
Video Input	Signal Input	15 pin D-SUB Connector /DVI-D Connector (Digital) HDMI Connector
	Input Form	RGB Analog (0.7 Vp-p/ 75 ohm), Digital
Resolution	Max	D-SUB(Analog) : 1920 x 1080 @ 60 Hz DVI / HDMI (Digital) : 1920 x 1080 @ 60 Hz
	Recommend	VESA 1920 x 1080 @ 60 Hz
Plug & Play	DDC 2B(Analog,Digital)	
Power Consumption	On Mode : 31 W(Typ.) Sleep Mode ≤ 0.3W Off Mode ≤ 0.3 W	
Power Input	AC 100-240 V~ 50 / 60 Hz 1.2A	
Dimensions (Width x Height x Depth)	With Stand	51.3 cm x 39.8 cm x 19.1 cm
	Without Stand	51.3 cm x 31.2 cm x 5.9 cm
Weight	3.28 kg	
Tilt Range	-5° to 15°	
Environmental conditions	Operating Temperature	10°C to 35 °C
	Operating Humidity	20 % to 80 %
	Storage Temperature	-10°C to 60 °C
	Storage Humidity	5 % to 90 % non-Condensing
Stand Base	Attached (), Detached (O)	
Power cord	Wall-outlet type	

Product specifications shown above may be changed without prior notice due to upgrade of product functions.

SPECIFICATIONS

IPS235V

Display	Screen Type	58.4 cm (23 inch) Flat Panel Active matrix-TFT LCD Anti-Glare coating Visible diagonal size: 58.4 cm
	Pixel Pitch	0.265 mm x 0.265 mm (Pixel Pitch)
Sync Input	Horizontal Frequency	30 kHz to 83 kHz (Automatic)
	Vertical Frequency	56Hz to 75Hz (D-SUB, DVI-D) 56Hz to 61Hz (HDMI)
	Input Form	Separate Sync. Digital
Video Input	Signal Input	15 pin D-SUB Connector /DVI-D Connector (Digital) HDMI Connector
	Input Form	RGB Analog (0.7 Vp-p/ 75 ohm), Digital
Resolution	Max	D-SUB(Analog) : 1920 x 1080 @ 60 Hz DVI / HDMI (Digital) : 1920 x 1080 @ 60 Hz
	Recommend	VESA 1920 x 1080 @ 60 Hz
Plug & Play	DDC 2B(Analog,Digital)	
Power Consumption	On Mode : 35W(Typ.) Sleep Mode ≤ 0.3 W Off Mode ≤ 0.3 W	
Power Input	AC 100-240 V~ 50 / 60 Hz 1.2A	
Dimensions (Width x Height x Depth)	With Stand	54.7 cm x 41.7 cm x 19.1 cm
	Without Stand	54.7 cm x 33.1 cm x 5.9 cm
Weight	3.57 kg	
Tilt Range	-5° to 15°	
Environmental conditions	Operating Temperature	10°C to 35 °C
	Operating Humidity	20 % to 80 %
	Storage Temperature	-10°C to 60 °C
	Storage Humidity	5 % to 90 % non-Condensing
Stand Base	Attached (), Detached (O)	
Power cord	Wall-outlet type	

Product specifications shown above may be changed without prior notice due to upgrade of product functions.

Preset Modes (Resolution)

Display Modes (Resolution)	Horizontal Frequency(kHz)	Vertical Frequency(Hz)	Polarity(H/V)	
720 x 400	31.468	70	-/+	
640 x 480	31.469	60	-/-	
640 x 480	37.500	75	-/-	
800 x 600	37.879	60	+/+	
800 x 600	46.875	75	+/+	
1024 x 768	48.363	60	-/-	
1024 x 768	60.123	75	+/+	
1152 x 864	67.500	75	+/+	
1280 x 1024	63.981	60	+/+	
1280 x 1024	79.976	75	+/+	
1680 x 1050	65.290	60	-/+	
1920 x 1080	67.500	60	+/+	Recommend Mode

HDMI TIMING

Display Modes (Resolution)	Horizontal Frequency(kHz)	Vertical Frequency(Hz)	
480P	31.50	60	
576P	31.25	50	
720P	37.50	50	
720P	45.00	60	
1080i	28.12	50	
1080i	33.75	60	
1080P	56.25	50	
1080P	67.50	60	Recommend Mode

Indicator

Mode	LED Color
On Mode	Blue
Sleep Mode	Blinking Blue
Off Mode	Off



Make sure to read the Safety Precautions before using the product.

Keep the Owner's Manual (CD) in an accessible place for future reference.

The model and serial number of the SET is located on the back and one side of the SET. Record it below should you ever need service.

MODEL _____

SERIAL _____

ENERGY STAR is a set of power-saving guidelines issued by the U.S. Environmental Protection Agency (EPA).



As an ENERGY STAR Partner LGE U. S. A., Inc. has determined that this product meets the ENERGY STAR guidelines for energy efficiency.