

USER GUIDE

**LG**

LG-K330



# About this user guide

ENGLISH

Thank you for choosing LG. Please carefully read this user guide before using the device for the first time to ensure safe and proper use.

- Always use genuine LG accessories. The supplied items are designed only for this device and may not be compatible with other devices.
- This device is not suitable for people who have a visual impairment due to the touchscreen keyboard.
- Descriptions are based on the device default settings.
- Default apps on the device are subject to updates and support for these apps may be withdrawn without prior notice. If you have any questions about an app provided with the device, please contact a LG Service Center. For user-installed apps, please contact the relevant service provider.
- Modifying the device's operating system or installing software from unofficial sources may damage the device and lead to data corruption or data loss. Such actions will violate your LG licence agreement and void your warranty.
- Some contents and illustrations may differ from your device depending on the region, service provider, software version, or OS version, and are subject to change without prior notice.
- Software, audio, wallpaper, images, and other media supplied with your device are licensed for limited use. If you extract and use these materials for commercial or other purposes, you may be infringing copyright laws. As a user, you are fully and entirely responsible for the illegal use of media.
- Additional charges may apply for data services, such as messaging, uploading, downloading, auto-syncing and location services. To avoid additional charges, select a data plan suitable to your needs. Contact your service provider to obtain additional details.

## Instructional notices

 <b>WARNING</b>	Situations that could cause injury to yourself or others.
 <b>CAUTION</b>	Situations that could cause damage to the device or other equipment.
 <b>NOTE</b>	Notices or additional information.

# LIMITED WARRANTY STATEMENT

ARBITRATION NOTICE: THIS LIMITED WARRANTY CONTAINS AN ARBITRATION PROVISION THAT REQUIRES YOU AND LG TO RESOLVE DISPUTES BY BINDING ARBITRATION INSTEAD OF IN COURT, UNLESS YOU CHOOSE TO OPT OUT. IN ARBITRATION, CLASS ACTIONS AND JURY TRIALS ARE NOT PERMITTED. PLEASE SEE THE SECTION TITLED “PROCEDURE FOR RESOLVING DISPUTES” BELOW.

## Warranty Laws

The following laws govern warranties that arise in retail sales of consumer goods:

- The California Song-Beverly Consumer Warranty Act [CC §§1790 et seq],
  - The California Uniform Commercial Code, Division Two [Com C §§2101 et seq], and
  - The federal Magnuson-Moss Warranty Federal Trade Commission Improvement Act [15 USC §§2301 et seq; 16 CFR Parts 701– 703].
- A typical Magnuson-Moss Act warranty is a written promise that the product is free of defects or a written promise to refund, repair, or replace defective goods. [See 15 USC §2301(6).] Remedies include damages for failing to honor a written warranty or service contract or for violating disclosure provisions. [See 15 USC §2310(d).] Except for some labeling and disclosure requirements, the federal Act does not preempt state law. [See 15 USC §2311.]

### 1. WHAT THIS WARRANTY COVERS:

LG offers you a limited warranty that the enclosed subscriber unit and its enclosed accessories will be free from defects in material and workmanship, according to the following terms and conditions:

- (1) The limited warranty for the product extends for TWELVE (12) MONTHS beginning on the date of purchase of the product with valid proof of purchase, or absent valid proof of purchase, FIFTEEN (15) MONTHS from date of manufacture as determined by the unit's manufacture date code.

- (2) The limited warranty extends only to the original purchaser of the product and is not assignable or transferable to any subsequent purchaser/end user.
- (3) This warranty is good only to the original purchaser of the product during the warranty period as long as it is in the U.S., including Alaska, Hawaii, U.S. Territories and Canada.
- (4) The external housing and cosmetic parts shall be free of defects at the time of shipment and, therefore, shall not be covered under these limited warranty terms.
- (5) Upon request from LG, the consumer must provide information to reasonably prove the date of purchase.
- (6) The customer shall bear the cost of shipping the product to the Customer Service Department of LG. LG shall bear the cost of shipping the product back to the consumer after the completion of service under this limited warranty.

## **2. WHAT THIS WARRANTY DOES NOT COVER:**

- (1) Defects or damages resulting from use of the product in other than its normal and customary manner.
- (2) Defects or damages from abnormal use, abnormal conditions, improper storage, exposure to moisture or dampness, unauthorized modifications, unauthorized connections, unauthorized repair, misuse, neglect, abuse, accident, alteration, improper installation, or other acts which are not the fault of LG, including damage caused by shipping, blown fuses, spills of food or liquid.
- (3) Breakage or damage to antennas unless caused directly by defects in material or workmanship.
- (4) That the Customer Service Department at LG was not notified by consumer of the alleged defect or malfunction of the product during the applicable limited warranty period.
- (5) Products which have had the serial number removed or made illegible.
- (6) This limited warranty is in lieu of all other warranties, express or implied either in fact or by operations of law, statutory or otherwise, including, but not limited to any implied warranty of marketability or fitness for a particular use.

- (7) Damage resulting from use of non LG approved accessories.
- (8) All plastic surfaces and all other externally exposed parts that are scratched or damaged due to normal customer use.
- (9) Products operated outside published maximum ratings.
- (10) Products used or obtained in a rental program.
- (11) Consumables (such as fuses).

### **3. WHAT LG WILL DO:**

LG will, at its sole option, either repair, replace or refund the purchase price of any unit that is covered under this limited warranty. LG may choose at its option to use functionally equivalent re-conditioned, refurbished or new units or parts or any units. In addition, LG will not re-install or back-up any data, applications or software that you have added to your phone. It is therefore recommended that you back-up any such data or information prior to sending the unit to LG to avoid the permanent loss of such information.

### **4. STATE LAW RIGHTS:**

No other express warranty is applicable to this product. THE DURATION OF ANY IMPLIED WARRANTIES, INCLUDING THE IMPLIED WARRANTY OF MARKETABILITY OR MERCHANTABILITY OR FITNESS FOR A PARTICULAR PURPOSE, IS LIMITED TO THE DURATION OF THE EXPRESS WARRANTY HEREIN. LG SHALL NOT BE LIABLE FOR THE LOSS OF THE USE OF THE PRODUCT, INCONVENIENCE, LOSS OR ANY OTHER DAMAGES, DIRECT OR CONSEQUENTIAL, ARISING OUT OF THE USE OF, OR INABILITY TO USE, THIS PRODUCT OR FOR ANY BREACH OF ANY EXPRESS OR IMPLIED WARRANTY, INCLUDING THE IMPLIED WARRANTY OF MARKETABILITY OR MERCHANTABILITY OR FITNESS FOR A PARTICULAR PURPOSE APPLICABLE TO THIS PRODUCT.

Some states do not allow the exclusive limitation of incidental or consequential damages or limitations on how long an implied warranty lasts; so these limitations or exclusions may not apply to you. This warranty gives you specific legal rights and you may also have other rights which vary from state to state.

## 5. HOW TO GET WARRANTY SERVICE:

To obtain warranty service, please call or fax to the following telephone numbers from anywhere in the continental United States:

**Tel. 1-800-793-8896 or Fax. 1-800-448-4026**

Or visit <http://www.lg.com/us/support>. Correspondence may also be mailed to:

LG Electronics Service- Mobile Handsets, P.O. Box 240007, Huntsville, AL 35824

**DO NOT RETURN YOUR PRODUCT TO THE ABOVE ADDRESS.** Please call or write for the location of the LG authorized service center nearest you and for the procedures for obtaining warranty claims.

### **PROCEDURE FOR RESOLVING DISPUTES:**

ALL DISPUTES BETWEEN YOU AND LG ARISING OUT OF OR RELATING IN ANY WAY TO THIS LIMITED WARRANTY OR THE PRODUCT SHALL BE RESOLVED EXCLUSIVELY THROUGH BINDING ARBITRATION, AND NOT IN A COURT OF GENERAL JURISDICTION. BINDING ARBITRATION MEANS THAT YOU AND LG ARE EACH WAIVING THE RIGHT TO A JURY TRIAL AND TO BRING OR PARTICIPATE IN A CLASS ACTION.

Definitions. For the purposes of this section, references to "LG" mean LG Electronics MobileComm U.S.A., Inc., its parents, subsidiaries and affiliates, and each of their officers, directors, employees, agents, beneficiaries, predecessors in interest, successors, assigns and suppliers; references to "dispute" or "claim" shall include any dispute, claim or controversy of any kind whatsoever (whether based in contract, tort, statute, regulation, ordinance, fraud, misrepresentation or any other legal or equitable theory) arising out of or relating in any way to the sale, condition or performance of the product or this Limited Warranty.

Agreement to Binding Arbitration and Class Action Waiver. You and LG agree to resolve any claims between us only by binding arbitration on an individual basis, unless you opt out as provided below. Any dispute between you and LG shall not be combined or consolidated with a dispute involving any other person's or entity's product or claim. More specifically, without limitation of the foregoing, any dispute between you and LG shall not under any circumstances proceed as part of a class or representative

action. Instead of arbitration, either party may bring an individual action in small claims court, but that small claims court action may not be brought on a class or representative basis.

Arbitration Rules and Procedures. To begin arbitration of a claim, either you or LG must make a written demand for arbitration. The arbitration will be administered by the American Arbitration Association (AAA) and will be conducted before a single arbitrator under the AAA's Consumer Arbitration Rules that are in effect at the time the arbitration is initiated (referred to as the "AAA Rules") and under the procedures set forth in this section. The AAA Rules are available online at [www.adr.org/consumer](http://www.adr.org/consumer). Send a copy of your written demand for arbitration, as well as a copy of this provision, to the AAA in the manner described in the AAA Rules. You must also send a copy of your written demand to LG at LG Electronics, USA, Inc. Attn: Legal Department-Arbitration 1000 Sylvan Avenue Englewood Cliffs, NJ 07632. If there is a conflict between the AAA Rules and the rules set forth in this section, the rules set forth in this section will govern. This arbitration provision is governed by the Federal Arbitration Act. Judgment may be entered on the arbitrator's award in any court of competent jurisdiction. All issues are for the arbitrator to decide, except that issues relating to the scope and enforceability of the arbitration provision and to the arbitrability of the dispute are for the court to decide. The arbitrator is bound by the terms of this provision.

Governing Law: The law of the state of your residence shall govern this Limited Warranty and any disputes between us except to the extent that such law is preempted by or inconsistent with applicable federal law.

Fees/Costs. You do not need to pay any fee to begin an arbitration. Upon receipt of your written demand for arbitration, LG will promptly pay all arbitration filing fees to the AAA unless you seek more than \$25,000 in damages, in which case the payment of these fees will be governed by the AAA Rules. Except as otherwise provided for herein, LG will pay all AAA filing, administration and arbitrator fees for any arbitration initiated in accordance with the AAA Rules and this arbitration provision. If you prevail in the arbitration, LG will pay your reasonable attorneys' fees and

expenses to the extent required by applicable law. If the arbitrator finds either the substance of your claim or the relief sought in the demand is frivolous or brought for an improper purpose (as measured by the standards set forth in Federal Rule of Civil Procedure 11(b)), then the payment of all arbitration fees will be governed by the AAA Rules. In such a situation, you agree to reimburse LG for all monies previously disbursed by it that are otherwise your obligation to pay under the AAA Rules. Except as otherwise provided for, LG waives any rights it may have to seek attorneys' fees and expenses from you if LG prevails in the arbitration.

Hearings and Location. If your claim is for \$25,000 or less, you may choose to have the arbitration conducted solely on the basis of (1) documents submitted to the arbitrator, (2) through a telephonic hearing, or (3) by an in-person hearing as established by the AAA Rules. If your claim exceeds \$25,000, the right to a hearing will be determined by the AAA Rules. Any in-person arbitration hearings will be held at a location within the federal judicial district in which you reside unless we both agree to another location or we agree to a telephonic arbitration.

Opt Out. You may opt out of this dispute resolution procedure. If you opt out, neither you nor LG can require the other to participate in an arbitration proceeding. To opt out, you must send notice to LG no later than 30 calendar days from the date of the first consumer purchaser's purchase of the product by either: (i) sending an e-mail to [optout@lge.com](mailto:optout@lge.com), with the subject line: "Arbitration Opt Out" or (ii) calling 1-800-980-2973. You must include in the opt out e-mail or provide by telephone: (a) your name and address; (b) the date on which the product was purchased; (c) the product model name or model number, and (d) the IMEI or MEID or Serial Number, as applicable (the IMEI or MEID or Serial Number can be found (i) on the product box; (ii) on a label on the back of the product beneath the battery, if the batter is removable; or (iii) from the settings menu via the following path: Settings → General → About phone → Status). You may only opt out of the dispute resolution procedure in the manner described above (that is, by e-mail or telephone); no other form of notice will be effective to opt out of this dispute resolution procedure. Opting out of this dispute resolution procedure will not affect the coverage of



the Limited Warranty in any way, and you will continue to enjoy the full benefits of the Limited Warranty. If you keep this product and do not opt out, then you accept all terms and conditions of the arbitration provision described above.

# Table of contents

<b>Features you will love</b> .....	12	Getting to Know the Home Screen.....	28
<b>Capture+</b> .....	13	Returning to recently-used applications .....	30
Using Capture+ .....	13	Customizing the Home screen.....	30
Viewing the saved memo.....	13	Notifications panel.....	31
<b>Basics</b> .....	14	<b>Capturing a screenshot</b> .....	<b>33</b>
<b>Accessories</b> .....	15	<b>On-screen keyboard</b> .....	<b>34</b>
<b>Phone layout</b> .....	16	<b>Transferring data between a PC and the device</b> .....	<b>35</b>
<b>Turning Your Phone On and Off</b> .....	18	<b>Apps</b> .....	<b>36</b>
<b>Installing the Nano SIM card and battery</b> .....	18	<b>Installing or uninstalling apps</b> .....	<b>37</b>
<b>Charging the battery</b> .....	20	<b>Calls</b> .....	<b>38</b>
Optimizing battery life.....	20	Making a call.....	38
<b>Inserting the memory card</b> .....	21	Calling your contacts.....	38
<b>Removing the memory card</b> .....	22	Answering and rejecting a call .....	38
<b>Touch screen tips</b> .....	22	Making a second call.....	39
Tap or touch .....	22	Viewing your call logs.....	39
Touch and hold.....	23	Change your call settings .....	39
Drag.....	23	<b>Contacts</b> .....	<b>40</b>
Swipe or slide.....	23	Searching for a contact.....	40
Double-tap.....	24	Adding a new contact.....	40
Pinch-to-Zoom.....	24	Favorites contacts.....	41
<b>Google account setup</b> .....	25	Creating a group.....	41
Creating your Google account.....	25	<b>Messaging</b> .....	<b>42</b>
Signing into your Google account.....	25	Sending a message.....	42
<b>Locking and unlocking the device</b> .....	26	Conversation view.....	42
KnockON.....	26	Changing your messaging settings.....	42
Knock Code .....	27	<b>Camera</b> .....	<b>43</b>
Changing the screen lock method.....	27	Taking a photo .....	43
Smart Lock.....	28	Camera options on the viewfinder.....	43
<b>Home screen</b> .....	28	Interval shot.....	44
		Burst shot.....	45

Gesture shot.....	45	<b>Settings.....</b>	<b>60</b>
Multi-point Auto-focus.....	45	<b>Access the Settings menu .....</b>	<b>61</b>
Once you have taken a photo.....	46	<b>Networks Settings.....</b>	<b>61</b>
Recording a video.....	46	Airplane mode.....	61
After recording a video.....	47	Wi-Fi.....	61
<b>Gallery .....</b>	<b>48</b>	Wi-Fi Direct.....	62
Viewing pictures.....	48	Bluetooth.....	62
Editing photos.....	48	Mobile data.....	64
Setting wallpaper.....	48	Call.....	64
Zooming in and out.....	49	Printing.....	65
Playing a video.....	49	USB tethering.....	66
Deleting photos/videos.....	50	Mobile HotSpot.....	66
<b>Email.....</b>	<b>51</b>	Wi-Fi Calling.....	66
Adding an account.....	51	Mobile networks.....	66
Working with account folders.....	51	VPN.....	66
Composing and sending email.....	51	<b>Sound &amp; notification settings.....</b>	<b>67</b>
Changing the Email app general settings....	52	<b>Display settings .....</b>	<b>68</b>
Deleting an email account.....	52	Home screen.....	68
<b>Music.....</b>	<b>53</b>	Lock screen.....	68
Playing a song.....	53	Home touch buttons.....	69
Music player options.....	53	More display settings.....	69
<b>Clock.....</b>	<b>55</b>	<b>General settings.....</b>	<b>70</b>
Alarms.....	55	Language & keyboard.....	70
Timer.....	55	Location.....	70
World clock.....	55	Accounts & sync.....	71
Stopwatch.....	56	Accessibility.....	71
<b>Calculator.....</b>	<b>56</b>	Shortcut key.....	73
<b>Calendar.....</b>	<b>56</b>	Security.....	73
<b>Voice Recorder.....</b>	<b>57</b>	Date & time.....	74
Recording a sound or voice.....	57	Storage.....	74
<b>Downloads.....</b>	<b>57</b>	Battery & power saving.....	74
<b>LG Backup.....</b>	<b>57</b>	Apps.....	75
About backing up and restoring device data....	57	Default message app.....	75
		Backup & reset.....	75
		About phone.....	75
<b>Google apps.....</b>	<b>58</b>	<b>Appendix .....</b>	<b>76</b>

<b>Phone software update .....</b>	<b>77</b>
<b>FAQ.....</b>	<b>78</b>
<b>Anti-Theft Guide .....</b>	<b>81</b>
<b>More information .....</b>	<b>82</b>
Open Source Software Notice Information	82
Trademarks.....	82
<b>For Your Safety .....</b>	<b>83</b>



**Features you will love**









# Capture+

The Capture+ feature allows you to create memos.

## Using Capture+

You can use Capture+ function to easily and efficiently create memos during a call, with a saved picture or on the current phone screen.

- 1 Touch and slide the status bar downward and tap .
- 2 Create a memo using the following options:

	Tap to save the memo you've created.
	Tap to redo the most recently deleted action.
	Tap to insert text into your memo.
	Tap to select the pen type and color.
	Tap to use the eraser to erase the pen marks on the memo.
	Tap to crop the image of memo.
	Tap to select the share or paper style.
	Tap to hide or display the toolbar.

### NOTE



- Please use a fingertip while using the Capture+ feature. Do not use your fingernail.

- 3 Tap  to save the current memo to the **QuickMemo+** or the **Gallery**.

## Viewing the saved memo

Tap  >  >  and select the **Capture+** album.

OR

Tap  >  >  and select the desired memo.



**Basics**

# Accessories

These accessories are available for use with the your phone.

- Travel Adaptor
- Quick Start Guide
- Stereo Headset
- USB Cable
- Battery

## NOTE

- Items described below may be optional.
- Always use genuine LG accessories. The supplied items are designed only for this device and may not be compatible with other devices.
- The items supplied with the device and any available accessories may vary depending on the region or service provider.



# Phone layout

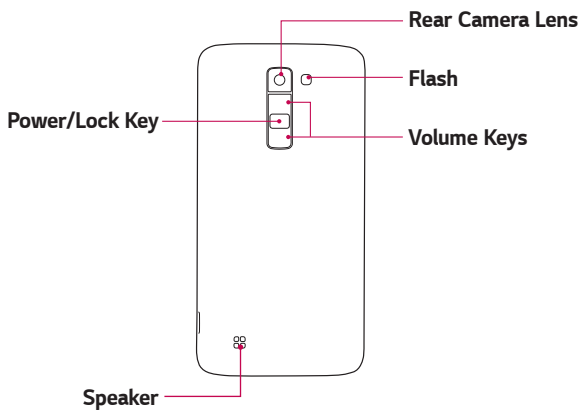
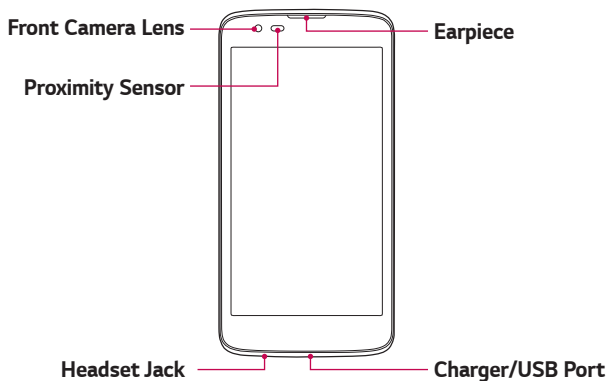

<b>Power/Lock Key</b>	<ul style="list-style-type: none"> <li>· Turn your phone on/off by pressing and holding this key.</li> <li>· Press once to turn the screen on/off.</li> </ul>
<b>Volume Keys</b>	<p><b>While the screen is off:</b></p> <ul style="list-style-type: none"> <li>· Press the <b>Volume Up Key</b> twice to launch Capture+.</li> <li>· Press the <b>Volume Down Key</b> twice to launch the Camera.</li> </ul> <p><b>On the Home screen:</b></p> <ul style="list-style-type: none"> <li>· Control ringer volume.</li> </ul> <p><b>During a call:</b></p> <ul style="list-style-type: none"> <li>· Control your earpiece volume.</li> </ul> <p><b>When playing audio/video:</b></p> <ul style="list-style-type: none"> <li>· Control volume continuously.</li> </ul>

 **NOTE : Proximity Sensor**

- When receiving and making calls, the proximity sensor automatically turns the backlight off and locks the touch screen by sensing when the phone is near your ear. This extends battery life and prevents you from unintentionally activating the touch screen during calls.

 **WARNING**

- Placing a heavy object on the phone or sitting on it can damage the display and touch screen functions. Do not cover the proximity sensor with screen protectors or any other type of protective film. This could cause the sensor to malfunction.

# Turning Your Phone On and Off

## Turning your phone on

Press and hold the **Power/Lock Key** on the back of the phone for a couple of seconds until the screen turns on.

## Turning your phone off

- 1 Press and hold the **Power/Lock Key** on the back of the phone until the Phone options menu appears.
- 2 Tap **Power off** in the Phone options menu.
- 3 Tap **OK** to confirm that you want to turn off the phone.

# Installing the Nano SIM card and battery

Insert the Nano SIM card provided by the mobile telephone service provider, and the included battery.

## WARNING

- Do not insert a memory card into the Nano SIM card slot. If a memory card happens to be lodged in the Nano SIM card slot, take the device to a LG Service Center to remove the memory card.
- 1 To remove the back cover, hold the phone firmly in one hand. With your other hand, lift off the back cover with your thumbnail as shown in the figure below.

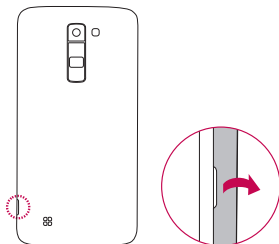

- 2 Slide the Nano SIM card into the Nano SIM card slot as shown in the figure. Make sure the gold contact area on the card is facing downward.

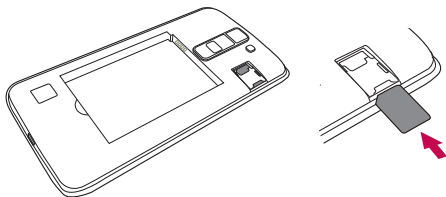

- 3 Insert the battery.

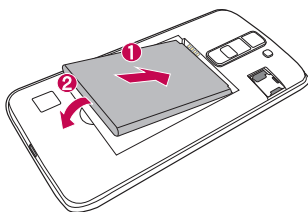

- 4 To replace the cover onto the device, align the back cover over the battery compartment and press it down until it clicks into place.

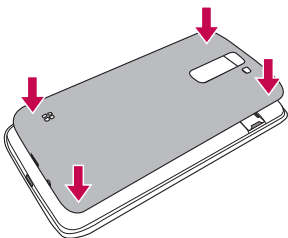

# Charging the battery

Charge the battery before using it for first time. Use the charger to charge the battery. A computer can also be used to charge the battery by connecting the phone to it using the USB cable.

## WARNING

- Use only LG-approved chargers, batteries and cables. If you use unapproved chargers, batteries or cables, it may cause battery charging delay. Or this can cause the battery to explode or damage the device, which are not covered by the warranty.

The charger connector is located at the bottom of the phone. Insert the charger and plug it into a power outlet.

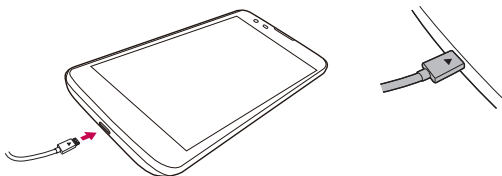

## NOTE

- Do not open the back cover while your phone is charging.

## Optimizing battery life

Extend your battery's power by turning off features that you do not need to run constantly in the background. You can monitor how applications and system resources consume battery power.

### Extending your phone's battery life:

- Turn off radio communications when you are not using. If you are not using Wi-Fi, Bluetooth® or GPS, turn them off.
- Reduce screen brightness and set a shorter screen timeout.
- Turn off automatic syncing for Gmail, Calendar, Contacts and other applications.

- Some applications you download may consume battery power.
- While using downloaded applications, check the battery charge level.

## Inserting the memory card

Your device supports up to a 2TB microSD card. Depending on the memory card manufacturer and type, some memory cards may not be compatible with your device.

### **WARNING**

- Some memory cards may not be fully compatible with the device. Using an incompatible card may damage the device or the memory card, or corrupt the data stored in it.

### **NOTE**

- Frequent writing and erasing of data shortens the lifespan of memory cards.

- 1 Remove the back cover.
- 2 Insert a memory card with the gold-colored contacts facing downwards.

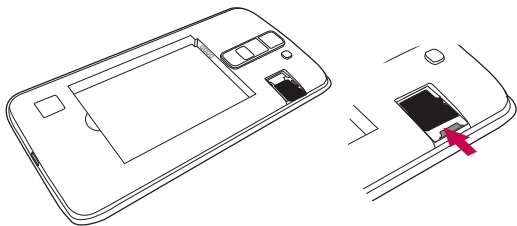

- 3 Replace the back cover.

# Removing the memory card

Before removing the memory card, first unmount it for safe removal.

1 Tap  >  >  > **General tab** > **Storage** > **Unmount SD card**.

2 Remove the back cover and pull out the memory card.

## **WARNING**

- Do not remove the memory card while the device is transferring or accessing information. Doing so can cause data to be lost or corrupted or damage to the memory card or device. It is not responsible for losses that result from the misuse of damaged memory cards, including the loss of data.

# Touch screen tips

Here are some tips on how to navigate on your phone.

## **NOTE**

- Do not press too hard; the tap screen is sensitive enough to pick up a light, yet firm tap.
- Use the tip of your finger to tap the option you want. Be careful not to tap any other buttons.

## Tap or touch

A single finger tap selects items, links, shortcuts and letters on the on-screen keyboard.

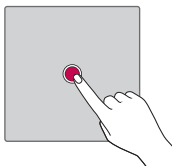

## Touch and hold

Touch and hold an item on the screen by tapping it and not lifting your finger until an action occurs.

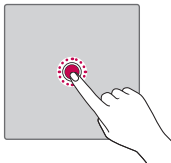

## Drag

Touch and hold an item for a moment and then, without lifting your finger, move your finger on the screen until you reach the target position. You can drag items on the Home screen to reposition them.

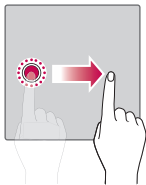

## Swipe or slide

To swipe or slide, quickly move your finger across the surface of the screen, without pausing when you first tap it (so you don't drag an item instead).

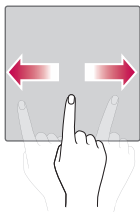



## Double-tap

Double-tap to zoom on a webpage or a map.

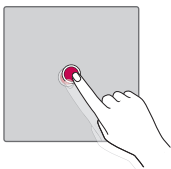

## Pinch-to-Zoom

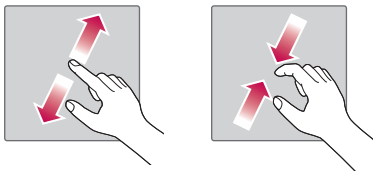

Use your index finger and thumb in a pinching or spreading motion to zoom in or out when using the browser, Maps, or when viewing pictures.





# Google account setup

The first time you open a Google application on your phone, you will be required to sign in with your existing Google account. If you do not have a Google account, you will be prompted to create one.

## Creating your Google account

- 1 Tap  >  >  > **General tab** > **Accounts & sync**.
- 2 Tap **ADD ACCOUNT** > **Google** > **Or create a new account**.
- 3 Enter your first and last name, then tap **NEXT**.
- 4 Enter your phone number for security tap **NEXT**.
- 5 Follow the instructions and enter the required and optional information about the account. Wait while the server creates your account.

## Signing into your Google account

- 1 Tap  >  >  > **General tab** > **Accounts & sync**.
- 2 Tap **ADD ACCOUNT** > **Google**.
- 3 Enter your email address and tap **NEXT**.
- 4 Enter your password and tap **NEXT**.
- 5 After signing in, you can use Gmail and take advantage of Google services on your phone.
- 6 Once you have set up your Google account, your phone will automatically synchronize with your Google account on the web (if a data connection is available).

After signing in, your phone will sync with your Google services, such as Gmail, Contacts, and Google Calendar. You can also use Maps, download applications from Play Store, back up your settings to Google servers, and take advantage of other Google services on your phone.

# Locking and unlocking the device

Pressing the Power/Lock Key turns off the screen and puts the device into lock mode. The device automatically gets locked if it is not used for a specified period. This helps to prevent accidental taps and saves battery power.

To unlock the device, press the Power/Lock Key and swipe the screen in any direction.

## KnockON

The KnockON feature allows you to double-tap the screen to easily turn it on or off.

### Turning the screen on

- 1 Double-tap the center of the Lock screen to turn the screen on.
- 2 Unlock the screen or access any of the available shortcuts or widgets.

### Turning the screen off

- 1 Double-tap an empty area of the Home screen or the status bar.
- 2 The screen will turn off.

#### NOTE

- Tap on the center area of the screen. If you tap on the bottom or the top area, the recognition rate may decrease.



## Knock Code

The Knock Code feature allows you to create your own unlock code using a combination of knocks on the screen. You can access the Home screen directly when the screen is off by tapping the same sequence on the screen.

### NOTE

- If you enter the wrong Knock Code 6 times, you will be required to enter your Google account login info/backup PIN.
- Use the fingertip instead of finger nail to tap the screen for turning it on or off.

## Setting up the Knock Code feature



- 1 Tap  >  >  > **Display** tab > **Lock screen** > **Select screen lock** > **Knock Code**.
- 2 Tap the squares in a pattern to set your Knock Code. Your Knock Code pattern can be 6 to 8 taps.

## Unlocking the screen using the Knock Code

You can unlock the screen by tapping the Knock Code pattern you already set, when the screen turns off.

## Changing the screen lock method

You can change the way that you lock the screen to prevent others accessing your personal information.

- 1 Tap  >  >  > **Display** tab > **Lock screen** > **Select screen lock**.
- 2 Select a desired screen lock from **None**, **Swipe**, **Knock Code**, **Pattern**, **PIN** and **Password**.

### NOTE

- Create a Google account before setting an unlock pattern and remember the Backup PIN you created when creating your pattern lock.

## Smart Lock

You can use Smart Lock to make unlocking your phone easier. You can set it to keep your phone unlocked when you have a trusted Bluetooth device connected to it, when it's in a familiar location like your home or work, or when it recognizes your face.

### Setting up Smart Lock feature

- 1 Tap **○** > **☰** > **⚙️** > **Display** tab > **Lock screen** > **Smart Lock**.
- 2 Before you add any trusted devices, trusted places, or trusted face, you need to set up a screen lock (Knock Code, Pattern, PIN or Password).

## Home screen

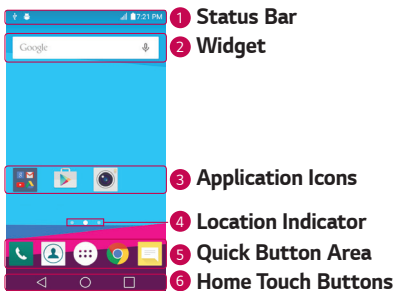

The Home screen is the starting point for many applications and functions. It allows you to add items like app shortcuts and Google widgets to give you instant access to information and applications. This is the default canvas and accessible from any menu by tapping **○**.

### Getting to Know the Home Screen



- 1 **Status Bar** - Shows the phone's status information, including the time, signal strength, battery status and notification icons.

- 2 **Widget** - Widgets are self-contained applications that can be accessed through the Apps drawer or on the Home screen. Unlike a shortcut, a Widget can function as an on-screen application.
- 3 **Application Icons** - Tap an icon (application, folder, etc.) to open and use it.
- 4 **Location Indicator** - Indicates which Home screen canvas you are currently viewing.
- 5 **Quick Button Area** - Provides one-touch access to the function in any Home screen canvas.
- 6 **Home Touch Buttons**

 <b>Back Button</b>	Returns to the previous screen. Also closes pop-up items, such as menus, dialog boxes and the on-screen keyboard.
 <b>Home Button</b>	Return to the Home screen from any screen.
 <b>Overview Button</b>	Displays recently used applications. If you touch and hold this button, it opens a menu of available options.

## To view other Home screen panels

The operating system provides multiple Home screen canvases to provide more space for adding icons, widgets and more.

- Slide your finger left or right across the Home screen to access additional canvases.

## Returning to recently-used applications

Multitasking is easy with Android; you can keep more than one application running at the same time. There is no need to quit an application before opening another. Use and switch between several open applications.

Android manages each application, stopping and starting them as needed to make sure that idle applications don't consume resources unnecessarily.

- 1 Tap . A list of recently used applications will be displayed.
- 2 Tap the application you want to access. This does not stop the previous app from running in the background. Make sure to tap to back out of an app after using it.
  - To close an app from the recent apps list, swipe the app preview to the left or right. To clear all apps, tap **Clear all**.

## Customizing the Home screen

You can customize your Home screen by adding apps and widgets and changing wallpapers.

### Adding items on your Home screen

- 1 Touch and hold the empty part of the Home screen.
- 2 In the Add Mode menu, select the item you want to add. You then see this added item on the Home screen.
- 3 Drag it to the desired location and lift your finger.

#### NOTE

- To add an application icon to the Home screen from the Apps screen, touch and hold the application you want to add.

### Removing an item from the Home screen

While on the Home screen, touch and hold the icon you want to remove > drag it to .

### Adding an app to the Quick Button Area

From the Apps screen or on the Home screen, touch and hold an application icon and drag it to the Quick Button Area. Then release it in the desired location.

## Removing an app from the Quick Button Area

Touch and hold the desired Quick Button, drag it to .

### NOTE

- The **Apps Button**  cannot be removed.

## Customizing app icons on the Home screen

- 1 Touch and hold an application icon until it unlocks from its current position, then release it. The editing icon  appears in the upper-right corner of the application.
- 2 Tap the application icon again and select the desired icon design and size.
- 3 Tap **OK** to save the change.

## Notifications panel

Notifications alert you to the arrival of new messages, calendar events and alarms, as well as ongoing events, such as when you are on a call.

### Opening the notifications panel

Swipe down from the status bar to open the notifications panel. To close the notifications panel, swipe the screen upwards or tap .

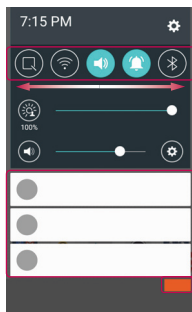
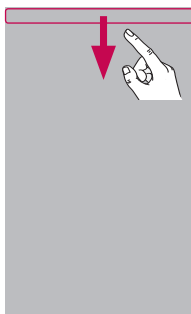

**1** Quick Settings Area

**2** Notifications

**3** CLEAR



- 1 Tap each quick setting button to toggle it on/off. Touch and hold the desired button to directly access the settings menu for the function. To see more toggle buttons, swipe left or right. Tap  to remove, add or rearrange quick setting buttons.
- 2 Current notifications are listed, each with a brief description. Tap a notification to view it.
- 3 Tap to clear all the notifications.













When a notification arrives, its icon appears at the top of the screen. Icons for pending notifications appear on the left, and system icons, such as Wi-Fi and battery strength are shown on the right.













## Indicator icons on the Status Bar

Indicator icons appear on the status bar at the top of the screen to report missed calls, new messages, calendar events, device status and more.



The icons displayed at the top of the screen provide information about the status of the device. The icons listed in the table below are some of the most common ones.



Icon	Description	Icon	Description
	No SIM card inserted		A song is currently playing
	No network signal available		No interruptions, not even alarms
	Airplane mode is on		Vibrate mode is on
	Connected to a Wi-Fi network		Battery fully charged
	Wired headset connected		Battery is charging
	Call in progress		The phone is connected to a PC via a USB cable

	Missed call		Downloading data
	Bluetooth is on		Uploading data
	System warning		GPS is on
	An alarm is set		Data is synchronizing
	New voicemail available		Choose input method
	New text or multimedia message		Mobile HotSpot is active

### NOTE

- The icon's location in the status bar may differ according to the function or service.
- The available options may vary depending on the region or service provider.





## Capturing a screenshot

Press and hold the **Volume Down Key** and the **Power/Lock Key** at the same time for 2 seconds to capture a screenshot of the current screen. To view the captured image, tap the  >  >  > the **Screenshots** folder.

# On-screen keyboard

You can enter text using the on-screen keyboard. The on-screen keyboard appears on the screen when you tap an available text entry field.

## Using the keypad and entering text

Icon	Description
	Tap once to capitalize the next letter you type. Double-tap for all caps.
	Tap to enter text by voice. Touch and hold to access clip tray, and keyboard settings.
	Tap to enter a space.
	Tap to create a new line.
	Tap to delete the previous character.

## Entering special characters

The on-screen keyboard allows you to enter special characters.



For example, to input "á", touch and hold the "a" button until the pop-up appears and displays related special characters. Without lifting the finger, drag your finger to the desired special character. Once it's highlighted, lift your finger.

### NOTE

- A symbol at the top right corner of a key indicates that additional characters are available for that key.

## To split or merge the keyboard

You can split the keyboard in half by spreading two fingers horizontally on the landscape keyboard. This makes it easier to type using your thumbs. Make sure the Split keyboard setting is enabled to use this feature.

- Tap  >  >  > **General** tab > **Language & keyboard** > **LG Keyboard** > **Keyboard height and layout** > **Split keyboard**.



## Transferring data between a PC and the device

You can copy or move data between a PC and the device.

### Transferring data using USB connection

- 1 Connect your device to a PC using the USB cable that came with your phone.
- 2 Open the Notifications panel, tap the current connection type, and select **Media device (MTP)**.
- 3 A window will pop-up on your PC, allowing you to transfer the desired data.

#### **NOTE**

- The LG Android Platform Driver is required to be installed on your PC to be able to detect the phone.
- Check the requirements for using **Media device (MTP)**.

Items	Requirement
OS	Microsoft Windows XP SP3, Vista or higher
Window Media Player version	Windows Media Player 10 or higher

\_\_\_\_\_

\_\_\_\_\_

\_\_\_\_\_

\_\_\_\_\_

\_\_\_\_\_

\_\_\_\_\_

**Apps**

# Installing or uninstalling apps

Play Store allows you to browse and search for free and paid applications.

## To open the Play Store app



Tap  >  > .

## To open a screen with details about an app

At any time while browsing in Play Store, tap an app to open its details screen.

The App details screen includes a description, ratings, comments, and related information about the app. From this screen, you can download, install, uninstall, rate the app, and more.





## To uninstall applications

- 1 Tap  >  >  > **General** tab > **Apps**.
- 2 Once all applications appear, scroll to and select the application you want to uninstall.
- 3 Tap **Uninstall**.

# Calls

You can enjoy clear calling across the region.



## Making a call

- 1 Tap  > .
- 2 Enter the number using the dialer. To delete a digit, tap .
- 3 After entering the desired number, tap  to place the call.
- 4 To end the call, tap .



### NOTE

- To enter "+" to make international calls, touch and hold .

## Calling your contacts

- 1 Tap  > .
- 2 Scroll through the contact list. You can also enter the contact's name in the Search field or scroll along the alphabet letters on the right edge of the screen.
- 3 In the list that is displayed, tap the contact you want to call.





## Answering and rejecting a call

- Swipe  in any direction to answer an incoming call.
- Swipe  in any direction to decline an incoming call.

### NOTE

- Swipe  if you want to decline a call and send a message to the caller.



## Making a second call

- 1 During your first call, tap  > **Add call** and enter the number.
- 2 Tap .
- 3 Both calls are displayed on the call screen. Your initial call is locked and put on hold.
- 4 Tap the displayed number to toggle between calls. Or tap  to start a conference call.
- 5 To end all calls, tap .

### NOTE

- You are charged for each call you make.

## Viewing your call logs



- 1 Tap  >  > **Call logs** tab.
- 2 View a list of all dialed, received and missed calls.

### NOTE

- Tap any call log entry to view the date, time and duration of the call.
- Tap  > **Clear all** to delete all of the recorded items.

## Change your call settings

You can configure phone call settings, such as call forwarding, as well as other special features offered by your carrier.



- 1 Tap  > .
- 2 Tap  > **Call settings** and configure the desired options.





# Contacts

You can add contacts on your phone and synchronize them with the contacts in your Google Account or other accounts that support syncing contacts.

## Searching for a contact

- 1 Tap  > .
- 2 Tap **Search contacts** and enter the contact name using the keyboard. Matches are displayed as you begin to type.



## Adding a new contact

- 1 Tap  > .
- 2 Enter the new contact's number.
- 3 Tap  > **Add to Contacts** > **New contact**.
- 4 If you want to add a picture to the new contact, tap the image icon. Choose **Take photo** or **Select from Gallery**.
- 5 Enter the desired information for the contact.
- 6 Tap **SAVE**.



## Favorites contacts

You can classify frequently called contacts as favorites.



### Adding a contact to your favorites

- 1 Tap  > .
- 2 Tap a contact to view its details.
- 3 Tap the star at the top right of the screen. The star turns yellow.

### Removing a contact from your favorites list

- 1 Tap  >  > **Favorites** tab.
- 2 Choose a contact to view its details.
- 3 Tap the yellow star at the top right of the screen. The star turns a dark color and the contact is removed from your favorites.

## Creating a group

- 1 Tap  >  > **Groups** tab.
- 2 Tap  > **New group**.
- 3 Enter a name for the new group. You can also set a distinct ringtone for the newly created group.
- 4 Tap **Add members** to add contacts to the group and tap **ADD**.
- 5 Tap **SAVE** to save the group.

### **NOTE**

- If you delete a group, the contacts assigned to that group will not be lost. They will remain in your contact list.

# Messaging

Your phone combines text and multimedia messaging into one intuitive, easy to use menu.

## NOTE

- You may be charged for each message you send. Please consult with your service provider.

## Sending a message

1 Tap  >  > .

2 Tap , then select one or more entries from your Contacts list.

OR

Enter a contact name or contact number into the **To** field. As you enter the contact name, matching contacts appear. You can tap a suggested recipient and add more than one contact.

3 Tap the text field and start entering your message.

4 Tap  to open the options menu. Choose from any of the available options.

5 Tap  to attach the file that you want to share with message.

6 Tap **Send** to send your message.

## Conversation view

Messages exchanged with another party are displayed in chronological order so that you can conveniently see and find your conversations.



## Changing your messaging settings

Your phone's messaging settings are predefined to allow you to send messages immediately. You can change the settings based on your preferences.

- Tap  >  >  > **Settings**.

# Camera

You can use the camera or camcorder to take and share pictures and videos.





- Tap  >  > .

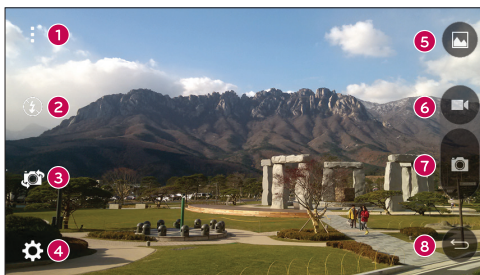

## Taking a photo

- 1 Frame your subject on the screen.
- 2 A square around the subject indicates that the camera has focused.
- 3 Tap  to take a photo. Your picture will be automatically saved to the Gallery.

## Camera options on the viewfinder



1		Tap to hide/display the camera options on the viewfinder.
2		Allows you to manage the camera's flash.
3		Tap to swap between the rear camera lens and the front camera lens.
4		Tap this icon to open the camera settings menu.
5		Tap to view the last photo or video you recorded.







6		Tap to start recording.
7		Tap to take a photo.
8		Tap to exit the camera.

## NOTE

- Be sure to clean the protective lens cover with a microfiber cloth before taking pictures. A lens cover with smudges from fingers can cause blurry pictures with a "halo" effect.

## Using the advanced settings



In the camera viewfinder, tap  to show the advanced options. Tap each icon to adjust the following camera settings.

	Set the ratio of your picture and the quality of video.
	Allows you to take pictures with voice commands. When on, you just say " <b>Cheese</b> ", " <b>Smile</b> ", " <b>LG</b> ", etc. to take a picture.
	Set your camera's timer. This is ideal if you want to be a part of the picture or video.
	Allows you to take better pictures and record better videos by displaying a grid line for help with alignment.
	Set the storage location for your pictures and videos. Choose from <b>IN</b> (internal memory) and <b>SD</b> (memory card). This menu appears only when the SD card is inserted.
	Allows you to learn how a function works. This icon will provide you with a help guide.

## Interval shot

You can take Interval shots from the Auto mode using the front camera lens. Touch and hold  to automatically take 4 selfies in a row.

## Burst shot

You can take Burst shots from the Auto camera mode using the rear camera lens. Touch and hold  to take a barrage of photos in a row until the Capture button is released. The viewfinder displays the number of shots taken. When viewing Burst shots in the Gallery, tap  to display each shot in sequence (similar to a viewing flipbook).

## Gesture shot

The Gesture shot feature allows you to take a picture with a hand gesture using the front camera.

### Taking the photos with a gesture

There are two methods for using the Gesture shot feature.

- Raise your hand, with an open palm, until the front camera detects it and a box appears on the screen. Then close your hand into a fist to start the timer, allowing you time to get ready.

OR

- Raise your hand, in a clenched fist, until the front camera detects it and a box appears on the screen. Then unclench your fist to start the timer, allowing you time to get ready.

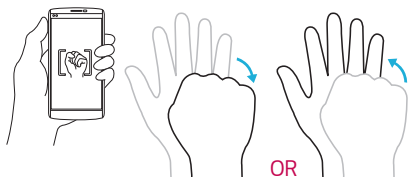







## Multi-point Auto-focus





When you take a picture, the Multi-point Auto-focus (AF) function operates automatically and will allow you to see a clear image.

## Once you have taken a photo





Tap the image thumbnail on the screen to view the last photo you took.

	Tap to edit the photo.
	Tap to take another photo immediately.
	Tap to open the available sharing options.
	Tap to delete the photo.
	Tap to access additional options.
	Tap to add the photo to your favorites.

## Recording a video





- 1 Tap  >  > .
- 2 Frame your subject on the screen.
- 3 Tap  to start recording the video.
- 4 The length of the recording is displayed on the top of the screen.

### NOTE

- Tap  to take pictures while recording video.
- 5 Tap  to pause recording video. You can resume recording again by tapping .
- OR
- Tap  to stop recording. Your video will be automatically saved to the Gallery.

## After recording a video



Tap the video thumbnail on the screen to view the last video you recorded.

	Tap to record another video immediately.
	Tap to open the available sharing options (such as Messaging or Bluetooth) to share.
	Tap to delete the video.
	Tap to access additional options.
	Tap to add the video to your favorites



# Gallery

The Gallery application presents the pictures and videos in your storage, including those you've taken with the Camera application and those you downloaded from the web or other locations.

- 1 Tap  >  > .
- 2 Tap an album to open it and view its contents. (The pictures and videos in the album are displayed in chronological order.)
- 3 Tap a picture in an album to view it.

## NOTE

- Depending on the software installed, some file formats may not be supported.
- Some files may not play properly due to their encoding.

## Viewing pictures

The Gallery displays your pictures in folders. When an application, such as E-mail, saves a picture, the download folder is automatically created to contain the picture.

Pictures are displayed by the date they were created. Select a picture to view it full screen. Scroll left or right to view the next or previous image.

## Editing photos

While viewing a photo, tap .

## Setting wallpaper

While viewing a photo, tap  > **Set image as** to set the image as wallpaper or assign it to a contact.

## NOTE

- Depending on the software installed, some file formats may not be supported.
- If the file size exceeds the available memory, an error can occur when you open files.

## Zooming in and out

Use one of the following methods to zoom in on an image:





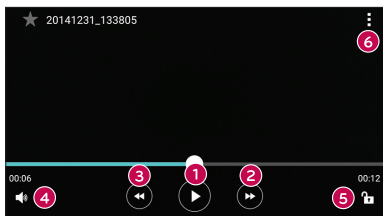

- Double-tap anywhere to zoom in.
- Spread two fingers apart on any place in the picture zoom in. Pinch in or double-tap the image to zoom out.

## Playing a video

- 1 Tap  >  > .
- 2 Select the video you want to watch.

## Video options





1		Tap to pause/resume video playback.
2		Touch and hold to fast-forward in 3 second increments. Tap to fast-forward 10 seconds.
3		Touch and hold to rewind in 3 second increments. Tap to rewind 10 seconds.
4		Tap to adjust the video volume.
5		Tap to lock/unlock the screen.
6		Tap to access additional options.

## NOTE

- While playing a video, slide the right side of the screen up or down to adjust the sound.
- While playing a video, slide the left side of the screen up or down to adjust the brightness.
- While playing a video, slide your finger from left to right (or vice versa) to fast-forward and rewind.



## Deleting photos/videos

Use one of the following methods:

- While in a folder, tap , select the photos/videos and then tap **DELETE**.
- While viewing a photo, tap .

# Email

You can use the Email application to read email from providers other than Gmail. The Email application supports the following account types: POP3, IMAP, Microsoft Exchange (for Enterprise users) and other accounts.

- Tap  >  > .

## Adding an account

The first time you open the Email application, a setup wizard opens to help you add an email account. You can also add your email account using the **Settings** app.



- Tap  > **Settings** > .

## Working with account folders

- Tap  > **Show all folders**.

Each account has Inbox, VIP, Sent, and Drafts. Depending on the features supported by your account's service provider, you may have additional folders.



## Composing and sending email

- 1 Tap .
- 2 Enter an address for the message's intended recipient. As you enter text, matching addresses will be offered from your contacts. Separate multiple addresses with semicolons.
- 3 Tap the **Cc/Bcc** field to copy or blind copy to other contacts/email addresses.
- 4 Tap the text field and enter your message.
- 5 Touch and hold the text field to edit selected words (Bold/Italic/Underline/Color)
- 6 Tap  to attach the file you want to send with your message.
- 7 Tap  to send the message.

## Changing the Email app general settings

- Tap  > **Settings** > **General settings**.

## Deleting an email account

- Tap  > **Settings** >  > **Remove account** > Select the account to delete > **REMOVE** > **YES**.



# Music

Your phone has a music player that lets you play all your favorite tracks.

## NOTE









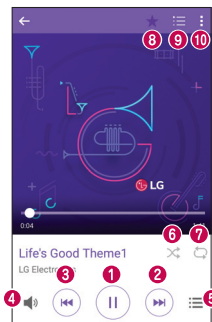

- Depending on the software installed, some file formats may not be supported.
- If the file size exceeds the available memory, an error can occur when you open files.
- Music file copyrights may be protected by international treaties and national copyright laws. Therefore, it may be necessary to obtain permission or a licence to reproduce or copy music. In some countries, national laws prohibit private copying of copyrighted material. Before downloading or copying the file, please check the national laws of the relevant country concerning the use of such material.

## Playing a song

- 1 Tap  >  > .
- 2 Tap the **Songs** tab.
- 3 Select the song you want to play.
- 4 The following options are available.

## Music player options



1		Tap to pause playback.
		Tap to resume playback.
2		Tap to skip to the next track in the album, playlist or shuffle list. Touch and hold to fast-forward.
3		Tap to restart the current track or skip to the previous track in the album, playlist or shuffle list. Touch and hold to rewind.
4		Tap to adjust the volume.
5		Tap to see all song list.
6		Tap to play the current playlist in shuffle mode (tracks are played in random order).
7		Tap to toggle through repeat all songs, repeat current song and repeat off.
8		Tap to add the song to your favorites.
9		Tap to open the current playlist.
10		Tap to access additional options.

# Clock

The Clock app gives you access to the Alarms, Timer, World clock and Stopwatch functions. Access these functions by tapping the tabs across the top of the screen or swiping horizontally across the screen.

- Tap  >  > .

## Alarms

The Alarms tab allows you to set alarms.

- 1 Tap the **Alarms** tab.
- 2 Tap  to add a new alarm.
- 3 Adjust the settings as necessary and tap **SAVE**.

### NOTE

- You can also tap an existing alarm to edit it.

## Timer

The Timer tab can alert you with an audible signal when a set amount of time has passed.

- 1 Tap the **Timer** tab.
- 2 Set the desired time on the timer.
- 3 Tap **Start** to start the timer.
- 4 Tap **Stop** to stop the timer.

## World clock

The World clock tab allows you to easily check the current time in other cities around the world.

- 1 Tap the **World clock** tab.
- 2 Tap  and select the desired city.





## Stopwatch

The Stopwatch tab allows you to use your phone as a stopwatch.

- 1 Tap the **Stopwatch** tab.
- 2 Tap **Start** to initiate the stopwatch.
  - Tap **Lap** to record lap times.
- 3 Tap **Stop** to stop stopwatch.

## Calculator

The Calculator app allows you to perform mathematical calculations using a standard or scientific calculator.





- 1 Tap  >  > .
- 2 Tap the number buttons to enter numbers.
- 3 For simple calculations, tap the function you want to perform (+, -, x or ÷) followed by =.

### NOTE

- For more complex calculations, tap  > **Scientific calculator**.

## Calendar







The Calendar app allows you to track your schedule of events.

- 1 Tap  >  > .
- 2 Tap the date you want to add an event to. Then tap .

# Voice Recorder

The Voice Recorder app records audible files for you to use in a variety of ways.

## Recording a sound or voice



- 1 Tap  >  > .
- 2 Tap  to begin recording.
- 3 Tap  to end the recording.
- 4 Tap  to listen to the recording.

### NOTE

- Tap  to access your recordings. You can listen to your saved recordings.

# Downloads

Use this application to see what files have been downloaded through the applications.

- Tap  >  > .

# LG Backup

## About backing up and restoring device data

It is recommended that you regularly create and save a backup file on the internal storage, especially before updating any software. Maintaining a current backup file in storage memory may allow you to recover device data if your device is lost, stolen, or corrupted by an unforeseen issue. This LG Backup application is supported between LG smartphones and tablets, other software or operating system versions. As a result, when you buy the new LG smartphones and tablets, you can backup the current device data to your new device.

If you have the LG Backup application preloaded on your smartphones and tablets, you can backup and restore most of your data, including

downloaded and pre-installed applications, bookmarks, calendar entries, contacts, home screen settings, and system settings.

### **WARNING**

- To protect against an unexpected power off during backup or restore operations, due to insufficient battery power, you should always keep your battery fully charged.

### **NOTE**

- All files that are stored on your device are deleted before the backup file is restored. Make sure to copy the backup file to another location.
- Please note that your device data will be overwritten with the content of your backup.

## To backup your device data

1 Tap  >  >  > **General** tab > **Backup & reset** > **LG Backup**.

2 Select the desired options.

- **Copy data between devices** – Copy data from old device to new device.
- **Back up & restore** – Back up data or restore from backup.

## Google apps

Google provides entertainment, social network, and business apps. You may require a Google account to access some apps.

To view more app information, access each app's help menu.

### **NOTE**

- Some apps may not be available depending on the region or service provider.

## Google

Search quickly for items on the Internet or your device.

## Chrome

Search for information and browse webpages.

## Gmail

Send or receive emails via the Google Mail service.

## Maps

Find your location on the map, search for locations, and view location information for various places.

## YouTube

Watch or create videos and share them with others.

## Drive

Store your content on the cloud, access it from anywhere, and share it with others.

## Play Music

Discover, listen to, and share music on your device.

## Play Movies & TV

Watch videos stored on your device and download various content to watch from the Play Store.

## Hangouts

Chat with your friends individually or in groups and use images, emoticons, and video calls while you are chatting.

## Photos

Manage photos, albums, and videos that you have saved on the device and uploaded to Google+.

## Google Settings

Configure settings for some features provided by Google.

## Voice Search

Search quickly for items by saying a keyword or phrase.

A decorative graphic consisting of several groups of horizontal white lines of varying lengths, arranged in a descending staircase pattern from the top left towards the bottom right. The background is a solid red color.

# Settings



# Access the Settings menu

The Settings app allows you to customize and personalize your phone.

## Opening the settings app

- Tap  > touch and hold  > **System settings**.

OR

- Tap  >  > .

## Viewing settings

Tap  to switch the view mode.

- **List view** – Scroll up and down through the list.
- **Tab view** – Swipe left and right or tap the tab you want.

### NOTE

- The instructions to perform tasks in this guide are based on the default view setting.

# Networks Settings

## Airplane mode

Allows you to use many of your phone's features, such as games, and music, when you are in an area where making or receiving calls or data use is prohibited. When you set your phone to Airplane Mode, it cannot send or receive any calls or access online data.

On the **Settings** screen, tap the **Networks** tab > **Airplane mode**.

## Wi-Fi

You can use high-speed Internet access while within the coverage of the wireless access point (AP).

On the **Settings** screen, tap the **Networks** tab > **Wi-Fi**.

- 1 Tap  to turn Wi-Fi on and start scanning for available Wi-Fi networks.

- 2 Tap a network to connect to it.
  - If the network is secured with a lock icon, you will need to enter a security key or password.
- 3 The status bar displays icons that indicate Wi-Fi status.

#### **NOTE**

- If you are out of the Wi-Fi zone or have set Wi-Fi to Off, the device may automatically connect to the Web using mobile data, which may incur data charges.

## Wi-Fi Direct

Wi-Fi Direct provides a direct connection between Wi-Fi enabled devices without requiring an access point.

- From the Wi-Fi menu, tap  > **Advanced Wi-Fi** > **Wi-Fi Direct**.

#### **NOTE**

- When in this menu, your device is visible to other visible Wi-Fi Direct devices nearby.

## Bluetooth

Bluetooth is a short-range communications technology that allows you to connect wirelessly to a number of Bluetooth devices, such as headsets and hands-free car kits, and Bluetooth-enabled handhelds, computers, printers, and wireless devices.

#### **NOTE**

- LG is not responsible for the loss, interception or misuse of data sent or received via the Bluetooth feature.
- Always make sure that you share and receive data with devices that are trusted and properly secured.
- If there are obstacles between the devices, the operating distance may be reduced.
- Some devices, especially those that are not tested or approved by Bluetooth SIG, may be incompatible with your device.

## Pairing your phone with another Bluetooth device

- 1 On the **Settings** screen, tap the **Networks** tab > **Bluetooth**.
- 2 Tap  to turn Bluetooth on and start scanning for available Bluetooth devices.
  - If you want to detect the visible devices in range additionally, tap **SEARCH**.
- 3 Choose the device you want to pair with from the list. Once the pairing is successful, your phone connects to the other device.

### **NOTE**

- Pairing between two Bluetooth devices is a one-time process. Once a pairing has been created, the devices will continue to recognize their partnership and exchange information.
- Please consult documentation included with Bluetooth device for information on pairing mode and passcode (typically 0 0 0 0 – four zeroes).

## Sending data via Bluetooth

- 1 Select a file or item, such as a contact or media file.
- 2 Select the option for sending data via Bluetooth.
- 3 Search for and pair with a Bluetooth-enabled device.

### **NOTE**

- Due to different specifications and features of other Bluetooth-compatible devices, display and operations may be different, and functions such as transfer or exchange may not be possible with all Bluetooth compatible devices.

## Receiving data via Bluetooth

- 1 On the **Settings** screen, tap the **Networks** tab > **Bluetooth**.
- 2 Tap  to turn Bluetooth on.
- 3 You will receive a request to accept data from the sending device. Be sure to select **ACCEPT**.



## Mobile data

Displays the data usage and mobile data usage limit.

- 1 On the **Settings** screen, tap the **Networks** tab > **Mobile data**.
- 2 Tap  to toggle your mobile data connection On or Off. This allows you to manage your mobile data usage. You can use a Wi-Fi network connection for data instead.

## Call

Allows you to configure various call settings.

On the **Settings** screen, tap the **Networks** tab > **Call**.

- **Voice mail** – Allows you to select your carrier's voicemail service.
- **VoLTE** – Allows you to turn the VoLTE feature on and off.
- **Wi-Fi Calling** – Wi-Fi Calling can improve your coverage and allows you to make phone calls over a Wi-Fi network (when a Wi-Fi network is available).

### Important

- Wi-Fi Calling requires that you use the SIM card that is shipped with your phone. Also, you must register your address for 9-1-1. Wi-Fi Calling will not work until you have registered for 9-1-1 by logging into your account at **www.metropcs.com**. Go to your profile and click **Customer Info** and continue on to enter your address.
- **Fixed dialing numbers** – Allows you to manage and compile a list of numbers that can be called from your phone. You need your PIN2, which is available from your operator. If activated, only numbers in the fixed dial list can be called from your phone.
- **Incoming voice call pop-up** – Displays a pop-up for an incoming call when an app is in use.
- **Call reject** – Allows you to set the call decline function.
- **Decline with message** – When you want to decline a call, you can send a quick message using this function. This is useful if you need to decline a call during a meeting.
- **Call forwarding** – Allows you to set call forwarding options.

- **Auto answer** – Set the time before a connected hands-free device automatically answers an incoming call.
- **Connection vibration** – Vibrates your phone when the other party answers the call.
- **TTY mode** – Allows you to activate TTY mode.
- **Hearing aids** – Allows you to turn on hearing aid compatibility.
- **Noise suppression** – Suppress background noise on my end during a call.
- **Power key ends call** – Allows you to use the Power key to end calls.
- **Silence incoming calls** – Enable to allow you to flip the device to silence incoming calls.
- **Call barring** – Locks incoming, outgoing or international calls.
- **Call duration** – Allows you to view the call duration for various types of calls.
- **Additional settings** – Allows you to change additional calling settings.

## Printing

Allows you to print the content of certain screens (such as web pages displayed in Chrome) to a printer connected to the same Wi-Fi network as your Android device.

On the **Settings** screen, tap the **Networks** tab > **Share & connect** > **Printing**.

### Printing via wireless printer

- 1 Select a file or item, such as a contact or media file.
- 2 Select the option for sending data via Bluetooth.
- 3 Search for and pair with a Bluetooth-enabled device.

#### NOTE

- Due to different specifications and features of other Bluetooth-compatible devices, display and operations may be different, and functions such as transfer or exchange may not be possible with all Bluetooth compatible devices.

## USB tethering

Allows you to share the internet connection with your computer via a USB cable.

- 1 Connect your phone to your PC with a USB cable.
- 2 On the **Settings** screen, tap the **Networks** tab > **Tethering**.
- 3 Tap  next to **USB tethering** to turn the feature on.

## Mobile HotSpot

You can also use your phone to provide a mobile data connection. Create a hotspot and share your connection.

- 1 On the **Settings** screen, tap the **Networks** tab > **Tethering** > **Mobile HotSpot**.
- 2 Tap  to turn Mobile HotSpot on.
- 3 Tap **Configure Mobile HotSpot** to change the SSID, security type, password, and other hotspot options.

## Wi-Fi Calling

Wi-Fi Calling can improve your coverage and allows you to make phone calls over a Wi-Fi network (when a Wi-Fi network is available).

On the **Settings** screen, tap the **Networks** tab > **More** > **Wi-Fi Calling**.

## Mobile networks

This menu allows you to configure various mobile network settings, such as **Mobile data**, **Data roaming**, etc.

On the **Settings** screen, tap the **Networks** tab > **More** > **Mobile networks**.

## VPN

From your phone, you can add, set up, and manage virtual private networks (VPNs) that allow you to connect and access resources inside a secured local network, such as your corporate network.

On the **Settings** screen, tap the **Networks** tab > **More** > **VPN**.

# Sound & notification settings

Allows you to change settings for various sounds on the device.

On the **Settings** screen, tap the **Sounds & notification** tab.

- **Sound profile** – Allows you to set your phone's sound profile.
- **Volume** – Adjust the phone's volume settings to suit your needs and environment.
- **Ringtone** – Allows you to set the ringtones for calls. You can also add and delete ringtones.
- **Sound with vibration** – Enable to set the phone to vibrate in addition to the ringtone when you receive calls.
- **Vibration type** – Allows you to choose the type of vibration.
- **Interruptions** – Allows you to set a schedule when to prevent interruptions from notifications. You can set to allow certain features to interrupt when Priority only is set.
- **Lock screen** – Allows you to choose if you want to show or hide notifications on the lock screen.
- **Apps** – Allows you to set notifications for individual apps including preventing them from displaying notifications and setting priority.
- **Notification sound** – Allows you to set the notification sound. You can also add and delete notification sounds.
- **Vibrate on tap** – Enable to vibrate when tapping the Home touch buttons and during other UI interactions.
- **Sound effects** – This menu lets you select whether you hear tones when tapping numbers on the dial pad, selecting on-screen options, and more.
- **Message/call voice notifications** – Allows your device to read out incoming calls and message events automatically.

# Display settings

## Home screen

Allows you to set your home screen settings.

On the **Settings** screen, tap the **Display** tab > **Home screen**.

- **Select Home** – Select the desired Home theme.
- **Theme** – Sets the screen theme for your device. You can download new themes from LG SmartWorld.
- **Wallpaper** – Sets the wallpaper to use on your Home screen.
- **Screen swipe effect** – Choose the desired type of effect to display when you swipe from one Home screen canvas to the next.
- **Allow Home screen looping** – Enable to allow continuous Home screen scrolling (loop back to first screen after last screen).
- **Help** – Displays help information for the Home screen.

## Lock screen

Allows you to set your lock screen settings.

On the **Settings** screen, tap the **Display** tab > **Lock screen**.

- **Select screen lock** – Allows you to set a screen lock type to secure your phone.
- **Smart Lock** – Sets to keep your phone unlocked with trusted device or a place. If you need more information, please refer to the **Smart Lock** section in **Basics**.
- **Screen swipe effect** – Sets the effect used when swiping the lock screen.
- **Wallpaper** – Select the wallpaper to display for your lock screen.
- **Shortcuts** – Allows you to choose the shortcuts available on the lock screen.
- **Contact info for lost phone** – Allows you to display the owner information on the lock screen in case the phone is lost.
- **Lock timer** – Allows you to set the amount of time before the screen automatically locks after the screen has timed-out.

- **Power button instantly locks** – Checkmark to instantly lock the screen when the Power/Lock Key is pressed. This setting overrides the lock timer setting.

## Home touch buttons

Set the Home touch buttons displayed at the bottom of all screens. Set which buttons are displayed, their position on the bar and what they look like.

On the **Settings** screen, tap the **Display** tab > **Home touch buttons**.

## More display settings

Allows you to set other display settings.

On the **Settings** screen, tap the **Display** tab.

- **Font type** – Select the desired font type.
- **Font size** – Select the desired font size.
- **Brightness** – Adjust the screen brightness by using the slider.
- **Auto-rotate screen** – Set to switch orientation automatically when you rotate the phone.
- **Screen timeout** – Set the time delay before the screen automatically turns off.
- **Daydream** – Select the screen saver to be displayed when the phone is sleeping while docked and/or charging.
- **Motion sensor calibration** – Allows you to improve the accuracy of the tilt and speed of the sensor.

# General settings

## Language & keyboard

Allows you to change the text input settings.

On the **Settings** screen, tap the **General** tab > **Language & keyboard**.

Select the language for the text on your phone and for configuring the on-screen keyboard.

- **Language** – Choose a language to use on your phone.
- **Current keyboard** – Allows you to select the other keyboard type.
- **LG Keyboard** – Tap to change the LG Keyboard settings.
- **Google voice typing** – Tap to change the Google voice settings.
- **Voice Search** – Tap to configure the Voice Search settings.
- **Text-to-speech output** – Tap to set the preferred engine or general settings for text-to-speech output.
- **Pointer speed** – Adjust the pointer speed.
- **Reverse buttons** – Reverse the mouse buttons to use the primary button on the right side.

## Location

Turn on location service, your phone determines your approximate location using Wi-Fi and mobile networks. When you select this option, you're asked whether you consent to allowing Google to use your location when providing these services.

On the **Settings** screen, tap the **General** tab > **Location**.

- **Mode** – Sets the how your current location information is determined.
- **Camera** – Enable to tag photos or videos with their locations.
- **Google Location History** – Allows you to choose your location information settings as accessed by Google and its products.

## Accounts & sync

Use this menu to add, remove, and manage your Google and other supported accounts. You also use these settings to control how and whether all applications send, receive, and sync data on their own schedules and whether all applications can synchronize user data automatically.

On the **Settings** screen, tap the **General** tab > **Accounts & sync**. Gmail™, Calendar, and other applications may also have their own settings to control how they synchronize data; see the sections on those applications for details.

- **Auto-sync data** – Enable this option to automatically sync all accounts you've added on your phone.
- **ACCOUNTS** – Displays all of your added accounts. Tap one to view and/ or manage it.
- **ADD ACCOUNT** – Tap to add new account.

## Accessibility

Use the Accessibility settings to configure accessibility plug-ins you have installed on your phone.

On the **Settings** screen, tap the **General** tab > **Accessibility**.

- **Vision** – Sets options for people with impaired sight.
  - **TalkBack** – Allows you to set up the TalkBack function which assists people with impaired vision by providing verbal feedback.
  - **Message/call voice notifications** – Enable to allows you to hear automatic spoken alerts for incoming calls and messages.
  - **Screen shade** – Enable to set the screen to a darker contrast.
  - **Font size** – Sets the font size.
  - **Touch zoom** – Allows you to zoom in and out by triple-tapping the screen.
  - **Screen color inversion** – Enable to invert the color of the screen and content.
  - **Screen color adjustment** – Allows you to adjust the color of screen and content.



- **Screen color filter** – Allows you to change the colors of screen and content.
- **Power key ends call** – Enable so that you can end voice calls by pressing the Power/Lock Key.
- **Hearing** – Sets options for people with impaired hearing.
  - **Captions** – Allows you to customize caption settings for those with hearing impairments.
  - **Flash alerts** – Enable to set the flash to blink for incoming calls and notifications.
  - **Turn off all sounds** – Enable to turn off all device sounds.
  - **Audio type** – Sets the audio type.
  - **Sound balance** – Sets the audio route. Move the slider on the slide bar to set it.
- **Motor & cognition** – Sets options for people with impaired motor skills.
  - **Touch feedback time** – Sets the touch feedback time.
  - **Touch assistant** – Show a touch board with easy access to common actions.
  - **Screen timeout** – Sets the amount of time before the backlight turns off automatically.
  - **Touch control areas** – Allows you to select an area of the screen to limit touch activation to just that area of the screen.
- **Accessibility features shortcut** – Allow you to access selected features quickly when triple-tapping the Home button.
- **Auto-rotate screen** – Enable to allow the phone to rotate the screen depending on the physical phone orientation (portrait or landscape).
- **Switch Access** – Allows you to interact with your device using one or more switches that work like keyboard keys. This menu can be helpful for users with mobility limitations that prevent them from interacting directly with the your device.

## Shortcut key

Get quick access to apps by pressing the **Volume Keys** twice when the screen is off or locked.

On the **Settings** screen, tap the **General** tab > **Shortcut key**.

- Press the **Volume Up Key** twice to open the Capture+ app.
- Press the **Volume Down Key** twice to launch the Camera app.

## Security

Use this menu to configure how to help secure your phone and its data.

On the **Settings** screen, tap the **General** tab > **Security**.

- **Content lock** – Select lock types to lock files for QuickMemo+ and Gallery.
- **Encrypt phone** – Allows you to encrypt data on the phone for security. You will be required to enter a PIN or password to decrypt your phone each time you power it on.
- **Encrypt SD card storage** – Encrypt SD card storage and keep data unavailable for other devices.
- **Set up SIM card lock** – Sets the PIN to lock your SIM card and allows you to change the PIN.
- **Password typing visible** – Enable to briefly show each character of passwords as you enter them so that you can see what you enter.
- **Phone administrators** – View or deactivate phone administrators.
- **Unknown sources** – Allow installation of non-Play Store applications.
- **Verify apps** – Disallow or warn before installation of apps that may cause harm.
- **Storage type** – Displays the current storage type.
- **Certificate management** – Allows you to manage your security certificates.
- **Trust agents** – Select apps to use without unlocking screen.
- **Screen pin** – You can enable your device to only show a certain app's screen using screen pin.
- **App usage access** – Allows you to view usage information of apps on your phone.

## Date & time

Set your preferences for how the date and time is displayed.

On the **Settings** screen, tap the **General** tab > **Date & time**.

## Storage

You can monitor the used and available internal memory in the device.

On the **Settings** screen, tap the **General** tab > **Storage**.

### INTERNAL STORAGE

- **Total space** – Displays the total amount of space and the available space in your phone's internal memory in text and with a color-coded bar graph (unused space is gray). Corresponding apps and the amount of space they use is listed under each device user.

### SD CARD

- **Total space** – Displays the total amount of space and the remaining available space in your memory card. This option is displayed only when a memory card is inserted.
- **Mount/Unmount SD card** – Allows you to mount or unmount your SD card.
- **Erase SD card** – Allows you to erase all of the data on your SD card.

## Battery & power saving

Displays the current battery status including the percentage of remaining charge and charging state.

On the **Settings** screen, tap the **General** tab > **Battery & power saving**.

- **Battery usage** – Displays the battery usage level and battery use details. Tap one of the items to see more detailed information.
- **Battery percentage on status bar** – Checkmark to display the battery level percentage on the Status Bar next to the Battery icon.
- **Battery saver** – Tap the Battery Saver switch to toggle it on or off. Sets the battery charge percent level that automatically turns on Battery Saver.
- **Help** – Displays help information for the Battery saver feature.

## Apps

Allows you to view details about the apps installed on your phone, manage their data, and force them to stop.

On the **Settings** screen, tap the **General** tab > **Apps**.

## Default message app

This menu allows you to set your default messaging app as desired.

On the **Settings** screen, tap the **General** tab > **Default message app**.

## Backup & reset

Change the settings for managing your settings and data.

On the **Settings** screen, tap the **General** tab > **Backup & reset**.

- **LG Backup** – Backs up all information on the device and restores it in the event of data loss or replacement. If you need more information, please refer to the **LG Backup** section in **Apps**.
- **Back up my data** – Back up app data, Wi-Fi passwords, and other settings to Google servers.
- **Backup account** – Displays the account that is currently being used to back up information.
- **Automatic restore** – When reinstalling an app, restore backed up settings and data.
- **Factory data reset** – Reset your settings to the factory default values and delete all your data. If you reset the phone this way, you are prompted to re-enter the same information as when you first started Android.

## About phone

View legal information, check phone status and software versions, and perform a software update.

On the **Settings** screen, tap the **General** tab > **About phone**.

\_\_\_\_\_

\_\_\_\_\_

\_\_\_\_\_

\_\_\_\_\_

\_\_\_\_\_

\_\_\_\_\_

# Appendix

# Phone software update

## LG Mobile phone software update from the Internet

For more information about using this function, please visit <http://www.lg.com/common/index.jsp> → select your country and language.

This feature allows you to conveniently update the firmware on your phone to a newer version from the Internet without needing to visit a service center. This feature will only be available if and when LG makes a newer firmware version available for your device.

Because the mobile phone firmware update requires the user's full attention for the duration of the update process, please make sure you check all instructions and notes that appear at each step before proceeding. Please note that removing the USB data cable during the upgrade may seriously damage your mobile phone.

### NOTE

- LG reserves the right to make firmware updates available only for selected models at its own discretion and does not guarantee the availability of the newer version of the firmware for all handset models.

## LG Mobile Phone software update via Over-the-Air (OTA)

This feature allows you to conveniently update your phone's software to a newer version via OTA, without connecting using a USB data cable. This feature will only be available if and when LG makes a newer firmware version available for your device.

You should first check the software version on your mobile phone:

**Settings > General tab > About phone > Update Center > System updates > CHECK FOR UPDATE.**



 **NOTE**

- Your personal data from internal phone storage—including information about your Google account and any other accounts, your system/application data and settings, any downloaded applications and your DRM licence—might be lost in the process of updating your phone's software. Therefore, LG recommends that you backup your personal data before updating your phone's software. LG does not take responsibility for any loss of personal data.
- This feature depends on your network service provider, region and country.

## FAQ

This chapter lists some problems you might encounter when using your phone. Some problems require you to call your service provider, but most are easy to fix yourself.

Message	Possible causes	Possible corrective measures
SIM card error	There is no SIM card in the phone or it is inserted incorrectly.	Make sure that the SIM card is correctly inserted.
No network connection/ Dropped network	Signal is weak or you are outside the carrier network.	Move toward a window or into an open area. Check the network operator coverage map.
	Operator applied new services.	Check whether the SIM card is more than 6-12 months old. If so, change your SIM or USIM card at your network provider's nearest branch. Contact your service provider.

Message	Possible causes	Possible corrective measures
Codes do not match	To change a security code, must need to confirm the new code by re-entering it.	If you forget the code, contact your service provider.
	The two codes you entered do not match.	
No applications can be set	Not supported by service provider or registration required.	Contact your service provider.
Downloaded application causes a lot of errors.	Remove the application.	<ol style="list-style-type: none"> <li>1 Tap  &gt;  &gt; .</li> <li>2 Tap the <b>General</b> tab &gt; <b>Apps</b>.</li> <li>3 Tap the app &gt; <b>Uninstall</b>.</li> </ol>
Calls not available	Dialing error	New network not authorised.
	New SIM card inserted.	Check for new restrictions.
	Pre-paid charge limit reached.	Contact service provider or reset limit with PIN2.
Phone cannot be turned on	On/Off key pressed too briefly.	Press the On/Off key for at least two seconds.
	Battery is not charged.	Charge battery. Check the charging indicator on the display.



<b>Message</b>	<b>Possible causes</b>	<b>Possible corrective measures</b>
Charging error	Battery is not charged.	Charge battery.
	Outside temperature is too hot or cold.	Make sure phone is charging at a normal temperature.
	Contact problem	Check the charger and its connection to the phone.
	No voltage	Plug the charger into a different outlet.
	Charger defective	Replace the charger.
	Wrong charger	Use only original LG accessories.
Number not allowed.	The Fixed dialling number function is on.	Check the Settings menu and turn the function off.
Impossible to receive/send SMS & photos	Memory full	Delete some data, such as applications or messages from your phone to make more memory available.
Files do not open	Unsupported file format	Check the supported file formats.
The screen does not turn on when I receive a call.	Proximity sensor problem	If you use a protection tape or case, make sure it has not covered the area around the proximity sensor. Make sure that the area around the proximity sensor is clean.
No sound	Vibration mode	Check the settings status in the sound menu to make sure you are not in vibration or no interruptions mode.

Message	Possible causes	Possible corrective measures
Hangs up or freezes	Intermittent software problem	<p>If the screen freezes or the phone does not respond when you try to operate it, remove the battery and reinsert it. Then power the phone back on.</p> <p>OR</p> <p>Try to perform a software update through the website.</p>

## Anti-Theft Guide

You can set up your device to prevent other people from using it if it's been reset to factory settings without your permission. For example, if your device is lost, stolen, or wiped, only someone with your Google account or screen lock information can use the device.

All you need to make sure your device is protected is:

- **Set a screen lock:** If your device is lost or stolen but you have a screen lock set, the device can't be erased using the Settings menu unless your screen is unlocked.
- **Add your Google account on your device:** If your device is wiped but you have your Google account on it, the device can't finish the setup process until your Google account information is entered again.

After your device is protected, you'll need to either unlock your screen or enter your Google account password if you need to do a factory reset. This ensures that you or someone you trust is doing the reset.

### NOTE

- Do not forget your Google account and password you had added to your device prior to performing a factory reset. If you can't provide the account information during the setup process, you won't be able to use the device at all after performing the factory reset.

# More information

## Open Source Software Notice Information

To obtain the source code under GPL, LGPL, MPL, and other open source licenses, that is contained in this product, please visit

<http://opensource.lge.com>.

In addition to the source code, all referred license terms, warranty disclaimers and copyright notices are available for download.

LG Electronics will also provide open source code to you on CD-ROM for a charge covering the cost of performing such distribution (such as the cost of media, shipping, and handling) upon email request to [opensource@lge.com](mailto:opensource@lge.com). This offer is valid for three (3) years from the date on which you purchased the product.

## Trademarks

- Copyright ©2015 LG Electronics, Inc. All rights reserved. LG and the LG logo are registered trademarks of LG Group and its related entities.
- Google™, Google Maps™, Gmail™, YouTube™, Hangouts™ and Play Store™ are trademarks of Google, Inc.
- Bluetooth® is a registered trademark of Bluetooth SIG, Inc. worldwide.
- Wi-Fi® and the Wi-Fi logo are registered trademarks of the Wi-Fi Alliance.
- All other trademarks and copyrights are the property of their respective owners.



**For Your Safety**

## Important Information

This user guide contains important information on the use and operation of this phone. Please read all the information carefully for optimal performance and to prevent any damage to or misuse of the phone. Any changes or modifications not expressly approved in this user guide could void your warranty for this equipment. Any changes or modifications not expressly approved by the manufacturer could void the user's authority to operate the equipment.

## Before You Start

**Warning** Violation of the instructions may cause serious injury or death.

**WARNING:** This product contains chemicals known to the State of California to cause cancer and birth defects or other reproductive harm.

**Wash hands after handling.**



- Never place your phone in a microwave oven as it will cause the battery to explode.



- When riding in a car, do not leave your phone or set up the hands-free kit near the air bag. If wireless equipment is improperly installed and the air bag is deployed, you may be seriously injured.



- Your phone contains an internal battery. Do not dispose of your phone near fire or with hazardous or flammable waste. You should dispose of your phone in accordance with all applicable laws.
- Do not use the phone in areas where its use is prohibited. (For example: aircraft)



- Do not expose the battery charger or adapter to direct sunlight or use it in places with high humidity, such as a bathroom.



- Do not use harsh chemicals (such as alcohol, benzene, thinners, etc.) or detergents to clean your phone. This could cause a fire.



- Do not drop, strike, or shake your phone severely. It may harm the internal circuit boards of the phone.



- Do not use your phone in high explosive areas as the phone may generate sparks.



- Do not damage the power cord by bending, twisting, pulling, or heating. Do not use the plug if it is loose as it may cause electric shock or fire.



- Do not place any heavy items on the power cord. Do not allow the power cord to be crimped as it may cause electric shock or fire.
- Do not handle the phone with wet hands while it is being charged. It may cause an electric shock or seriously damage your phone.
- Do not disassemble the phone.
- Do not place or answer calls while charging the phone as it may short-circuit the phone and/or cause electric shock or fire.
- Do not attempt to repair or modify the device yourself. Your device is equipped with an internal rechargeable battery which should be replaced only by LG or an authorized LG repair center.

You should never attempt to open or disassemble this device yourself and doing so may cause damage that voids your warranty.



- Make sure that no sharp-edged items, such as animal's teeth or nails, come into contact with the battery. This could cause a fire.



- Be careful that children do not swallow any parts (such as earphone, connection parts of the phone, etc.) This could cause asphyxiation or suffocation resulting in serious injury or death.



- Unplug the power cord and charger during lightning storms to avoid electric shock or fire.



- Only use chargers provided by LG. The warranty will not be applied to products provided by other suppliers.
- Only authorized personnel should service the phone and its accessories. Faulty installation or service may result in accidents and consequently invalidate the warranty.



- An emergency call can be made only within a service area. For an emergency call, make sure that you are within a service area and that the phone is turned on.

- Your phone is an electronic device that generates heat during normal operation. Extremely prolonged, direct skin contact in the absence of adequate ventilation may result in discomfort or minor burns. Therefore, use care when handling your phone during or immediately after operation.
- Use and store your phone in temperatures between 0°C/32°F and 45°C/113°F, if possible. Exposing your phone to extremely low or high temperatures may result in damage, malfunction, or even explosion.

## HAC statement

This phone has been tested and rated for use with hearing aids for some of the wireless technologies that it uses. However, there may be some newer wireless technologies used in this phone that have not been tested yet for use with hearing aids. It is important to try the different features of this phone thoroughly and in different locations, using your hearing aid or cochlear implant, to determine if you hear any interfering noise. Consult your service provider or the manufacturer of this phone for information on hearing aid compatibility. If you have questions about return or exchange policies, consult your service provider or phone retailer.

This mobile phone has a Hearing Aid Mode that, when activated, may reduce interference with some hearing aid models.

## FCC RF Exposure Information

**WARNING! Read this information before operating the phone.**

In August 1996, the Federal Communications Commission (FCC) of the United States, with its action in Report and Order FCC 96-326, adopted an updated safety standard for human exposure to Radio Frequency (RF) electromagnetic energy emitted by FCC regulated transmitters. Those guidelines are consistent with the safety standard previously set by both U.S. and international standards bodies. The design of this phone complies with the FCC guidelines and these international standards.

## Body-worn Operation

This device was tested for typical use with the back of the phone kept 0.39 inches (1.0 cm) from the body. To comply with FCC RF exposure requirements, a minimum separation distance of 0.39 inches (1.0 cm) must be maintained between the user's body and the back of the phone.

Any belt-clips, holsters, and similar accessories containing metallic components may not be used. Avoid the use of accessories that cannot maintain 0.39 inches (1.0 cm) distance between the user's body and the back of the phone and have not been tested for compliance with FCC RF exposure limits.

## Consumer Information About Radio Frequency Emissions

**Your wireless phone, which contains a radio transmitter and receiver, emits radio frequency energy during use. The following consumer information addresses commonly asked questions about the health effects of wireless phones.**

### **Are wireless phones safe?**

Scientific research on the subject of wireless phones and radio frequency ("RF") energy has been conducted worldwide for many years, and continues. In the United States, the Food and Drug Administration ("FDA") and the Federal Communications Commission ("FCC") set policies and procedures for wireless phones. The FDA issued a website publication on health issues related to cell phone usage where it states, "The scientific community at large ... believes that the weight of scientific evidence does not show an association between exposure to radiofrequency (RF) from cell phones and adverse health outcomes. Still the scientific community does recommend conducting additional research to address gaps in knowledge. That research is being conducted around the world and FDA continues to monitor developments in this field. You can access the joint FDA/FCC website at <http://www.fda.gov> (under "c" in the subject index,



select Cell Phones > Research). You can also contact the FDA toll-free at (888) 463-6332 or (888) INFO-FDA. In June 2000, the FDA entered into a cooperative research and development agreement through which additional scientific research is being conducted. The FCC issued its own website publication stating that “there is no scientific evidence that proves that wireless phone usage can lead to cancer or a variety of other problems, including headaches, dizziness or memory loss.” This publication is available at <http://www.fcc.gov/cgb/cellular.html> or through the FCC at (888) 225-5322 or (888) CALL-FCC.

### **What does “SAR” mean?**

In 1996, the FCC, working with the FDA, the U.S. Environmental Protection Agency, and other agencies, established RF exposure safety guidelines for wireless phones in the United States. Before a wireless phone model is available for sale to the public, it must be tested by the manufacturer and certified to the FCC that it does not exceed limits established by the FCC. One of these limits is expressed as a Specific Absorption Rate, or “SAR.” SAR is a measure of the rate of absorption of RF energy in the body. Tests for SAR are conducted with the phone transmitting at its highest power level in all tested frequency bands. Since 1996, the FCC has required that the SAR of handheld wireless phones not exceed 1.6 watts per kilogram, averaged over one gram of tissue. Although the SAR is determined at the highest power level, the actual SAR value of a wireless phone while operating can be less than the reported SAR value. This is because the SAR value may vary from call to call, depending on factors such as proximity to a cell site, the proximity of the phone to the body while in use, and the use of hands-free devices. For more information about SARs, see the FCC’s OET Bulletins 56 and 65 at [http://www.fcc.gov/Bureaus/Engineering\\_Technology/Documents/bulletins](http://www.fcc.gov/Bureaus/Engineering_Technology/Documents/bulletins) or visit the Cellular Telecommunications Industry Association website at [http://www.ctia.org/consumer\\_info/index.cfm/AID/10371](http://www.ctia.org/consumer_info/index.cfm/AID/10371). You may also wish to contact the manufacturer of your phone.

### **Can I minimize my RF exposure?**

If you are concerned about RF, there are several simple steps you can take to minimize your RF exposure. You can, of course, reduce your talk time.

You can place more distance between your body and the source of the RF, as the exposure level drops off dramatically with distance. The FDA/FCC website states that “hands-free kits can be used with wireless phones for convenience and comfort. These systems reduce the absorption of RF energy in the head because the phone, which is the source of the RF emissions, will not be placed against the head. On the other hand, if the phone is mounted against the waist or other part of the body during use, then that part of the body will absorb more RF energy. Wireless phones marketed in the U.S. are required to meet safety requirements regardless of whether they are used against the head or against the body. Either configuration should result in compliance with the safety limit.” Also, if you use your wireless phone while in a car, you can use a phone with an antenna on the outside of the vehicle. You should also read and follow your wireless phone manufacturer’s instructions for the safe operation of your phone.

### **Do wireless phones pose any special risks to children?**

The FDA/FCC website states that “the scientific evidence does not show a danger to users of wireless communication devices, including children.” The FDA/FCC website further states that “some groups sponsored by other national governments have advised that children be discouraged from using wireless phones at all.” For example, the Stewart Report from the United Kingdom [“UK”] made such a recommendation in December 2000. In this report a group of independent experts noted that no evidence exists that using a cell phone causes brain tumors or other ill effects. [The UK’s] recommendation to limit cell phone use by children was strictly precautionary; it was not based on scientific evidence that any health hazard exists. A copy of the UK’s leaflet is available at <http://www.dh.gov.uk> (search “mobile”), or you can write to: NRPB, Chilton, Didcot, Oxon OX11 0RQ, United Kingdom. Copies of the UK’s annual reports on mobile phones and RF are available online at [www.iegmp.org.uk](http://www.iegmp.org.uk) and <http://www.hpa.org.uk/radiation/> (search “mobile”). Parents who wish to reduce their children’s RF exposure may choose to restrict their children’s wireless phone use.

## **Where can I get further information about RF emissions?**

For further information, see the following additional resources (websites current as of April 2005):

### **U.S. Food and Drug Administration**

FDA Consumer magazine

November-December 2000

Telephone: (888) INFO-FDA

<http://www.fda.gov> (Under "c" in the subject index, select Cell Phones > Research.)

### **U.S. Federal Communications Commission**

445 12th Street, S.W.

Washington, D.C. 20554

Telephone: (888) 225-5322

<http://www.fcc.gov/oet/rfsafety>

### **Independent Expert Group on Mobile Phones**

<http://www.iegmp.org.uk>

### **Royal Society of Canada Expert Panels on Potential Health Risks of Radio Frequency Fields from Wireless Telecommunication Devices**

283 Sparks Street

Ottawa, Ontario K1R 7X9

Canada

Telephone: (613) 991-6990

[http://www.rsc.ca/index.php?page=Expert\\_Panels\\_RF&Lang\\_id=120](http://www.rsc.ca/index.php?page=Expert_Panels_RF&Lang_id=120)

### **World Health Organization**

Avenue Appia 20

1211 Geneva 27

Switzerland

Telephone: 011 41 22 791 21 11

<http://www.who.int/mediacentre/factsheets/fs193/en/>

### **International Commission on Non-ionizing Radiation Protection**

c/o Bundesamt für Strahlenschutz

Ingolstaedter Landstr. 1

85764 Oberschleissheim

Germany

For Your Safety

Telephone: 011 49 1888 333 2156

<http://www.icnirp.de>

### **American National Standards Institute**

1819 L Street, N.W., 6th Floor

Washington, D.C. 20036

Telephone: (202) 293-8020

<http://www.ansi.org>

### **National Council on Radiation Protection and Measurements**

7910 Woodmont Avenue, Suite 800

Bethesda, MD 20814-3095

Telephone: (301) 657-2652

<http://www.ncrponline.org>

### **Engineering in Medicine and Biology Society, Committee on Man and Radiation (COMAR) of the Institute of Electrical and Electronics Engineers**

<http://ewh.ieee.org/soc/embs/comar/>

## **Consumer Information on SAR (Specific Absorption Rate)**

This model phone meets the government's requirements for exposure to radio waves. Your wireless phone is a radio transmitter and receiver. It is designed and manufactured not to exceed the emission limits for exposure to Radio Frequency (RF) energy set by the Federal Communications Commission of the U.S. Government. These limits are part of comprehensive guidelines and establish permitted levels of RF energy for the general population. The guidelines are based on standards that were developed by independent scientific organizations through periodic and thorough evaluation of scientific studies. The standards include a substantial safety margin designed to assure the safety of all persons, regardless of age and health.

The exposure standard for wireless mobile phones employs a unit of measurement known as the Specific Absorption Rate, or SAR. The SAR limit set by the FCC is 1.6 W/kg. Tests for SAR are conducted using standard operating positions specified by the FCC with the phone

transmitting at its highest certified power level in all tested frequency bands. Although SAR is determined at the highest certified power level, the actual SAR level of the phone while operating can be well below the maximum value. Because the phone is designed to operate at multiple power levels to use only the power required to reach the network, in general, the closer you are to a wireless base station antenna, the lower the power output.

Before a phone model is available for sale to the public, it must be tested and certified to the FCC that it does not exceed the limit established by the government-adopted requirement for safe exposure. The tests are performed in positions and locations (e.g., at the ear and worn on the body) as required by the FCC for each model.

(Body measurements differ among phone models, depending upon available accessories and FCC requirements).

While there may be differences between SAR levels of various phones and at various positions, they all meet the government requirement for safe exposure.

The FCC has granted an Equipment Authorization for this model phone with all reported SAR levels evaluated as in compliance with the FCC RF emission guidelines. SAR information on this model phone is on file with the FCC and can be found under the Display Grant section of <http://www.fcc.gov/oet/fccid> after searching on FCC ID ZNFK330. Additional information on Specific Absorption Rates (SAR) can be found on the Cellular Telecommunications Industry Association (CTIA) website at <http://www.ctia.org/>.

\* In the United States and Canada, the SAR limit for mobile phones used by the public is 1.6 watts/kg (W/kg) averaged over one gram of tissue. The standard incorporates a substantial margin of safety to give additional protection for the public and to account for any variations in measurements.

## FCC Hearing-Aid Compatibility (HAC) Regulations for Wireless Devices

On July 10, 2003, the U.S. Federal Communications Commission (FCC) Report and Order in WT Docket 01-309 modified the exception of wireless phones under the Hearing Aid Compatibility Act of 1988 (HAC Act) to require digital wireless phones be compatible with hearing-aids. The intent of the HAC Act is to ensure reasonable access to telecommunications services for persons with hearing disabilities.

While some wireless phones are used near some hearing devices (hearing aids and cochlear implants), users may detect a buzzing, humming, or whining noise. Some hearing devices are more immune than others to this interference noise, and phones also vary in the amount of interference they generate.

The wireless telephone industry has developed a rating system for wireless phones, to assist hearing device users to find phones that may be compatible with their hearing devices. Not all phones have been rated. Phones that are rated have the rating on their box or a label located on the box.

The ratings are not guarantees. Results will vary depending on the user's hearing device and hearing loss. If your hearing device happens to be vulnerable to interference, you may not be able to use a rated phone successfully. Trying out the phone with your hearing device is the best way to evaluate it for your personal needs.

**M-Ratings:** Phones rated M3 or M4 meet FCC requirements and are likely to generate less interference to hearing devices than phones that are not labeled. M4 is the better/higher of the two ratings.

**T-Ratings:** Phones rated T3 or T4 meet FCC requirements and are likely to generate less interference to hearing devices than phones that are not labeled. T4 is the better/ higher of the two ratings.

Hearing devices may also be rated. Your hearing device manufacturer or hearing health professional may help you find this rating. Higher ratings mean that the hearing device is relatively immune to interference noise. The hearing aid and wireless phone rating values are then added together.

A sum of 5 is considered acceptable for normal use. A sum of 6 is considered for best use.

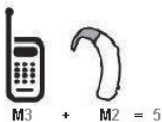

In the above example, if a hearing aid meets the M2 level rating and the wireless phone meets the M3 level rating, the sum of the two values equal M5. This should provide the hearing aid user with “normal usage” while using their hearing aid with the particular wireless phone. “Normal usage” in this context is defined as a signal quality that’s acceptable for normal operation.

The M mark is intended to be synonymous with the U mark. The T mark is intended to be synonymous with the UT mark. The M and T marks are recommended by the Alliance for Telecommunications Industries Solutions (ATIS). The U and UT marks are referenced in Section 20.19 of the FCC Rules. The HAC rating and measurement procedure are described in the American National Standards Institute (ANSI) C63.19 standard.

To ensure that the Hearing Aid Compatibility rating for your phone is maintained, secondary transmitters such as Bluetooth® and WLAN components must be disabled during a call.

**For information about hearing aids and digital wireless phones**

**Wireless Phones and Hearing Aid Accessibility**

<http://www.accesswireless.org/>

**Gallaudet University, RERC**

<http://tap.gallaudet.edu/Voice/>

**FCC Hearing Aid Compatibility and Volume Control**

<http://www.fcc.gov/cgb/dro/hearing.html>

**The Hearing Aid Compatibility FCC Order**

[http://hraunfoss.fcc.gov/edocs\\_public/attachmatch/FCC-03-168A1.pdf](http://hraunfoss.fcc.gov/edocs_public/attachmatch/FCC-03-168A1.pdf)

**Hearing Loss Association of America [HLAA]**

<http://hearingloss.org/content/telephones-and-mobile-devices>

## Caution:

### Avoid potential hearing loss.

Prolonged exposure to loud sounds (including music) is the most common cause of preventable hearing loss. Some scientific research suggests that using portable audio devices, such as portable music players and cellular telephones, at high volume settings for long durations may lead to permanent noise-induced hearing loss. This includes the use of headphones (including headsets, earbuds and Bluetooth® or other wireless devices). Exposure to very loud sound has also been associated in some studies with tinnitus (a ringing in the ear), hypersensitivity to sound and distorted hearing. Individual susceptibility to noise-induced hearing loss and other potential hearing problems varies.

The amount of sound produced by a portable audio device varies depending on the nature of the sound, the device, the device settings and the headphones. You should follow some commonsense recommendations when using any portable audio device:

- Set the volume in a quiet environment and select the lowest volume at which you can hear adequately.
- When using headphones, turn the volume down if you cannot hear the people speaking near you or if the person sitting next to you can hear what you are listening to.
- Do not turn the volume up to block out noisy surroundings. If you choose to listen to your portable device in a noisy environment, use noise-cancelling headphones to block out background environmental noise.
- Limit the amount of time you listen. As the volume increases, less time is required before your hearing could be affected.
- Avoid using headphones after exposure to extremely loud noises, such as rock concerts, that might cause temporary hearing loss. Temporary hearing loss might cause unsafe volumes to sound normal.



- Do not listen at any volume that causes you discomfort. If you experience ringing in your ears, hear muffled speech or experience any temporary hearing difficulty after listening to your portable audio device, discontinue use and consult your doctor.

## TIA Safety Information

The following is the complete TIA Safety Information for wireless handheld phones.

## Exposure to Radio Frequency Signal

Your wireless handheld portable phone is a low power radio transmitter and receiver. When ON, it receives and sends out Radio Frequency (RF) signals.

In August, 1996, the Federal Communications Commissions (FCC) adopted RF exposure guidelines with safety levels for handheld wireless phones. Those guidelines are consistent with the safety standards previously set by both U.S. and international standards bodies:

ANSI C95.1 (1992) \*

NCRP Report 86 (1986)

ICNIRP (1996)

\* American National Standards Institute; National Council on Radiation Protection and Measurements; International Commission on Non-Ionizing Radiation Protection

Those standards were based on comprehensive and periodic evaluations of the relevant scientific literature. For example, over 120 scientists, engineers, and physicians from universities, government health agencies, and industry reviewed the available body of research to develop the ANSI Standard (C95.1).

The design of your phone complies with the FCC guidelines (and those standards).

## Tips on Efficient Operation

For your phone to operate most efficiently:

Don't touch the antenna unnecessarily when the phone is in use. Contact with the antenna affects call quality and may cause the phone to operate at a higher power level than otherwise needed.

## Electronic Devices

Most modern electronic equipment is shielded from RF signals. However, certain electronic equipment may not be shielded against the RF signals from your wireless phone.

## Pacemakers

The Health Industry Manufacturers Association recommends that a minimum separation of six (6) inches be maintained between a handheld wireless phone and a pacemaker to avoid potential interference with the pacemaker. These recommendations are consistent with the independent research by and recommendations of Wireless Technology Research.

Persons with pacemakers:

- Should ALWAYS keep the phone more than six (6) inches from their pacemaker when the phone is turned ON;
- Should not carry the phone in a breast pocket;
- Should use the ear opposite the pacemaker to minimize the potential for interference;
- Should turn the phone OFF immediately if there is any reason to suspect that interference is taking place.

## Hearing Aids

Some digital wireless phones may interfere with some hearing aids. In the event of such interference, you may want to consult your service provider (or call the customer service line to discuss alternatives).

## Other Medical Devices

If you use any other personal medical device, consult the manufacturer of your device to determine if it is adequately shielded from external RF energy. Your physician may be able to assist you in obtaining this information.

## Health Care Facilities

Turn your phone OFF in health care facilities when any regulations posted in these areas instruct you to do so. Hospitals or health care facilities may use equipment that could be sensitive to external RF energy.

## Vehicles

RF signals may affect improperly installed or inadequately shielded electronic systems in motor vehicles. Check with the manufacturer or its representative regarding your vehicle. You should also consult the manufacturer of any equipment that has been added to your vehicle.

## Posted Facilities

Turn your phone OFF in any facility where posted notices so require.

## Aircraft

FCC regulations prohibit using your phone while in the air. Switch OFF your phone before boarding an aircraft.

## Blasting Areas

To avoid interfering with blasting operations, turn your phone OFF when in a "blasting area" or in areas posted: "Turn off two-way radio". Obey all signs and instructions.

## Potentially Explosive Atmosphere

Turn your phone OFF when in any area with a potentially explosive atmosphere and obey all signs and instructions. Sparks in such areas could cause an explosion or fire resulting in bodily injury or even death.

Areas with a potentially explosive atmosphere are often, but not always marked clearly. Potential areas may include: fueling areas (such as gasoline stations); below deck on boats; fuel or chemical transfer or storage facilities; vehicles using liquefied petroleum gas (such as propane or butane); areas where the air contains chemicals or particles (such as grain, dust, or metal powders); and any other area where you would normally be advised to turn off your vehicle engine.

## For Vehicles Equipped with an Air Bag

An air bag inflates with great force. DO NOT place objects, including either installed or portable wireless equipment, in the area over the air bag or in the air bag deployment area. If in-vehicle wireless equipment is improperly installed and the air bag inflates, serious injury could result.

## Part 15.19 statement

This device complies with part 15 of the FCC rules. Operation is subject to the following two conditions:

- (1) This device may not cause harmful interference, and
- (2) This device must accept any interference received, including interference that may cause undesired operation.

## Part 15.21 statement

Changes or modifications that are not expressly approved by the manufacturer for compliance could void the user's authority to operate the equipment.

## Part 15.105 statement

This equipment has been tested and found to comply with the limits for a class B digital device, pursuant to Part 15 of the FCC rules. These limits are designed to provide reasonable protection against harmful

interference in a residential installation. This equipment generates, uses, and can radiate radio frequency energy and, if not installed and used in accordance with the instructions, may cause harmful interference to radio communications. However, there is no guarantee that interference will not occur in a particular installation. If this equipment does cause harmful interference to radio or television reception, which can be determined by turning the equipment off and on, the user is encouraged to try to correct the interference by one or more of the following measures:

- Reorient or relocate the receiving antenna.
- Increase the separation between the equipment and receiver.
- Connect the equipment into an outlet on a circuit different from that to which the receiver is connected.
- Consult the dealer or an experienced radio/TV technician for help.

## Safety Information

Please read and observe the following information for safe and proper use of your phone and to prevent damage.

### Caution

**Violation of the instructions may cause minor or serious damage to the product.**

- Do not disassemble or open crush, bend or deform, puncture or shred.
- Do not modify or remanufacture, attempt to insert foreign objects into the battery, immerse or expose to water or other liquids, expose to fire, explosion or other hazard. Such conditions may present the risk of fire or explosion.
- Only use the battery for the system for which it is specified.
- Only use the battery with a charging system that has been LG-approved and qualified with the system per IEEE-Std-1725. Use of an unqualified and non- LG-approved battery or charger may present a risk of fire, explosion, leakage, or other hazard.
- Do not short circuit a battery or allow metallic conductive objects to contact battery terminals.

- Replace the battery only with another battery that has been LG-approved and qualified with the system per this standard, IEEE-Std-1725. Use of an unqualified and non-LG-approved battery may present a risk of fire, explosion, leakage or other hazard. Only authorized service providers shall replace battery. (If the battery is non-user replaceable.)
- Promptly dispose of used batteries in accordance with local regulations.
- Battery usage by children should be supervised.
- Avoid dropping the phone or battery. If the phone or battery is dropped, especially on a hard surface, and the user suspects damage, take it to a service center for inspection.
- Improper battery use may result in a fire, explosion or other hazard.
- At least, one of the Authentication methods may be implemented. (e.g. H/W, S/W, Mechanical, Hologram, etc.)

## Charger and Adapter Safety

- The charger and adapter are intended for indoor use only.
- Insert the battery charger vertically into the wall power socket.
- Only use the LG-approved battery charger. Otherwise, you may cause serious damage to your phone.
- Use the correct adapter for your phone when using the battery charger abroad.

## Battery Information and Care

- Always unplug the charger from the wall socket after the phone is fully charged to save unnecessary power consumption of the charger.
- Please read the manual of specified charger about charging method.
- Do not damage the power cord by bending, twisting, or heating. Do not use the plug if it is loose as it may cause electric shock or fire.
- Do not place any heavy items on the power cord. Do not allow the power cord to be crimped as it may cause electric shock or fire.
- Unplug the power cord prior to cleaning your phone, and clean the

power plug pin when it's dirty. When using the power plug, ensure that it's firmly connected. If not, it may cause excessive heat or fire. If you put your phone in a pocket or bag without covering the receptacle of the phone (power plug pin), metallic articles (such as a coin, paperclip or pen) may short-circuit the phone. Always cover the receptacle when not in use.

- Recharge the battery after long periods of non-use to maximize battery life. Battery life will vary due to usage pattern and environmental conditions.
- Please use only an approved charging accessory to charge your LG phone. Improper handling of the charging port, as well as the use of an incompatible charger, may cause damage to your phone and void the warranty.
- Charging temperature range is regulated between 0°C/32°F and 45°C/113°F. Do not charge the battery out of recommended temperature range. Charging out of recommended range might cause the generating heat or serious damage of battery. And also, it might cause the deterioration of battery's characteristics and cycle life.
- Do not use or leave the battery under the blazing sun or in heated car by sunshine. The battery may generate heat, smoke or flame. And also, it might cause the deterioration of battery's characteristics or cycle life.
- The battery pack has protection circuit to avoid the danger. Do not use nearby the place where generates static electricity more than 100V which gives damage to the protection circuit. If the protection circuit were broken, the battery would generate smoke, rupture or flame.
- If the skin or cloth is smeared with liquid from the battery, wash with fresh water. It may cause the skin inflammation.
- Please take your phone to an authorized service center immediately if this occurs.
- Do not handle the phone with wet hands while it is being charged. It may cause an electric shock or seriously damage your phone.
- Do not place or answer calls while charging the phone as it may

short-circuit the phone and/or cause electric shock or fire.

- The charger and adapter are intended for indoor use only.
- Talking on your phone for a long period of time may reduce call quality due to heat generated during use.

## Explosion, Shock, and Fire Hazards

- Do not put your phone in a place subject to excessive dust and keep the minimum required distance between the power cord and heat sources.
- Unplug the power cord prior to cleaning your phone, and clean the power plug pin when it's dirty.
- When using the power plug, ensure that it's firmly connected. If not, it may cause excessive heat or fire.
- If you put your phone in a pocket or bag without covering the receptacle of the phone (power plug pin), metallic articles (such as a coin, paperclip or pen) may short-circuit the phone and may cause an explosion. Always cover the receptacle when not in use.

## General Notice

- Do not place items containing magnetic components such as a credit card, phone card, bank book, or subway ticket near your phone. The magnetism of the phone may damage the data stored in the magnetic strip.
- Talking on your phone for a long period of time may reduce call quality due to heat generated during use.
- When the phone is not used for a long period time, store it in a safe place with the power cord unplugged.
- Using the phone in proximity to receiving equipment (i.e., TV or radio) may cause interference to the phone.
- Do not use the phone if the antenna is damaged. If a damaged antenna contacts skin, it may cause a slight burn. Please contact an LG Authorized Service Center to replace the damaged antenna.



- Do not immerse your phone in water, liquid, or expose to high humidity. Immediately, take it to an LG Authorized Service Center.
- Do not paint your phone.
- The data saved in your phone might be deleted due to careless use, repair of the phone, or upgrade of the software. Please backup your important phone numbers. (Ringtones, text messages, voice messages, pictures, and videos could also be deleted.) The manufacturer is not liable for damage due to the loss of data.
- When you use the phone in public places, set the ringtone to vibration so you don't disturb others.
- Do not turn your phone on or off when putting it to your ear.
- Use accessories, such as earphones and headsets, with caution. Ensure that cables are tucked away safely and do not touch the antenna unnecessarily.

## FDA Consumer Update



The U.S. Food and Drug Administration's Center for Devices and Radiological Health Consumer Update on Mobile Phones:

### **1. Do wireless phones pose a health hazard?**

The available scientific evidence does not show that any health problems are associated with using wireless phones. There is no proof, however, that wireless phones are absolutely safe. Wireless phones emit low levels of Radio Frequency (RF) energy in the microwave range while being used. They also emit very low levels of RF when in standby mode. Whereas high levels of RF can produce health effects (by heating tissue), exposure to low level RF that does not produce heating effects causes no known adverse health effects. Many studies of low level RF exposures have not found any biological effects. Some studies have suggested that some biological effects may occur, but such findings have not been confirmed by additional research. In some cases, other researchers have had difficulty in reproducing those studies, or in determining the reasons for inconsistent results.

## **2. What is the FDA's role concerning the safety of wireless phones?**

Under the law, the FDA does not review the safety of radiation-emitting consumer products such as wireless phones before they can be sold, as it does with new drugs or medical devices. However, the agency has authority to take action if wireless phones are shown to emit Radio Frequency (RF) energy at a level that is hazardous to the user. In such a case, the FDA could require the manufacturers of wireless phones to notify users of the health hazard and to repair, replace, or recall the phones so that the hazard no longer exists.

Although the existing scientific data do not justify FDA regulatory actions, the FDA has urged the wireless phone industry to take a number of steps, including the following:

- Support needed research into possible biological effects of RF of the type emitted by wireless phones;
- Design wireless phones in a way that minimizes any RF exposure to the user that is not necessary for device function; and
- Cooperate in providing users of wireless phones with the best possible information on possible effects of wireless phone use on human health.

The FDA belongs to an interagency working group of the federal agencies that have responsibility for different aspects of RF safety to ensure coordinated efforts at the federal level. The following agencies belong to this working group:

- National Institute for Occupational Safety and Health
- Environmental Protection Agency
- Occupational Safety and Health Administration
- National Telecommunications and Information Administration

The National Institutes of Health participates in some interagency working group activities, as well.

The FDA shares regulatory responsibilities for wireless phones with the Federal Communications Commission (FCC). All phones that are sold in the United States must comply with FCC safety guidelines that limit RF exposure. The FCC relies on the FDA and other health agencies for safety questions about wireless phones.

The FCC also regulates the base stations that the wireless phone networks rely upon. While these base stations operate at higher power than do the wireless phones themselves, the RF exposures that people get from these base stations are typically thousands of times lower than those they can get from wireless phones. Base stations are thus not the subject of the safety questions discussed in this document.

### **3. What kinds of phones are the subject of this update?**

The term “wireless phone” refers here to handheld wireless phones with built-in antennas, often called “cell”, “mobile”, or “PCS” phones. These types of wireless phones can expose the user to measurable Radio Frequency (RF) energy because of the short distance between the phone and the user’s head.

These RF exposures are limited by FCC safety guidelines that were developed with the advice of the FDA and other federal health and safety agencies. When the phone is located at greater distances from the user, the exposure to RF is drastically lower because a person's RF exposure decreases rapidly with increasing distance from the source. The so-called “cordless phones,” which have a base unit connected to the telephone wiring in a house, typically operate at far lower power levels, and thus produce RF exposures far below the FCC safety limits.

### **4. What are the results of the research done already?**

The research done thus far has produced conflicting results, and many studies have suffered from flaws in their research methods. Animal experiments investigating the effects of Radio Frequency (RF) energy exposures characteristic of wireless phones have yielded conflicting results that often cannot be repeated in other laboratories. A few animal studies, however, have suggested that low levels of RF could accelerate the development of cancer in laboratory animals. However, many of the studies that showed increased tumor development used animals that had been genetically engineered or treated with cancer-causing chemicals so as to be pre-disposed to develop cancer in the absence of RF exposure. Other studies exposed the animals to RF for up to 22 hours per day. These conditions are not similar to the conditions under which people use wireless phones, so we do not know with certainty what the results

of such studies mean for human health. Three large epidemiology studies have been published since December 2000. Between them, the studies investigated any possible association between the use of wireless phones and primary brain cancer, glioma, meningioma, or acoustic neuroma, tumors of the brain or salivary gland, leukemia, or other cancers. None of the studies demonstrated the existence of any harmful health effects from wireless phone RF exposures. However, none of the studies can answer questions about long-term exposures, since the average period of phone use in these studies was around three years.

### **5. What research is needed to decide whether RF exposure from wireless phones poses a health risk?**

A combination of laboratory studies and epidemiological studies of people actually using wireless phones would provide some of the data that are needed. Lifetime animal exposure studies could be completed in a few years. However, very large numbers of animals would be needed to provide reliable proof of a cancer promoting effect if one exists. Epidemiological studies can provide data that is directly applicable to human populations, but ten or more years follow-up may be needed to provide answers about some health effects, such as cancer. This is because the interval between the time of exposure to a cancer-causing agent and the time tumors develop — if they do — may be many, many years. The interpretation of epidemiological studies is hampered by difficulties in measuring actual RF exposure during day-to-day use of wireless phones. Many factors affect this measurement, such as the angle at which the phone is held, or which model of phone is used.

### **6. What is the FDA doing to find out more about the possible health effects of wireless phone RF?**

The FDA is working with the U.S. National Toxicology Program and with groups of investigators around the world to ensure that high priority animal studies are conducted to address important questions about the effects of exposure to Radio Frequency (RF) energy.

The FDA has been a leading participant in the World Health Organization International Electro Magnetic Fields (EMF) Project since its inception in 1996. An influential result of this work has been the development of a

detailed agenda of research needs that has driven the establishment of new research programs around the world. The project has also helped develop a series of public information documents on EMF issues.

The FDA and the Cellular Telecommunications & Internet Association (CTIA) have a formal Cooperative Research And Development Agreement (CRADA) to do research on wireless phone safety. The FDA provides the scientific oversight, obtaining input from experts in government, industry, and academic organizations. CTIA-funded research is conducted through contracts with independent investigators. The initial research will include both laboratory studies and studies of wireless phone users. The CRADA will also include a broad assessment of additional research needs in the context of the latest research developments around the world.

### **7. How can I find out how much Radio Frequency energy exposure I can get by using my wireless phone?**

All phones sold in the United States must comply with Federal Communications Commission (FCC) guidelines that limit Radio Frequency (RF) energy exposures. The FCC established these guidelines in consultation with the FDA and the other federal health and safety agencies. The FCC limit for RF exposure from wireless phones is set at a Specific Absorption Rate (SAR) of 1.6 watts per kilogram (1.6 W/kg). The FCC limit is consistent with the safety standards developed by the Institute of Electrical and Electronic Engineering (IEEE) and the National Council on Radiation Protection and Measurement. The exposure limit takes into consideration the body's ability to remove heat from the tissues that absorb energy from the wireless phone and is set well below levels known to have effects. Manufacturers of wireless phones must report the RF exposure level for each model of phone to the FCC. The FCC website (<http://www.fcc.gov/oet/rfsafety>) gives directions for locating the FCC identification number on your phone so you can find your phone's RF exposure level in the online listing.

### **8. What has the FDA done to measure the Radio Frequency energy coming from wireless phones?**

The Institute of Electrical and Electronic Engineers (IEEE) is developing a technical standard for measuring the Radio Frequency (RF) energy

exposure from wireless phones and other wireless handsets with the participation and leadership of FDA scientists and engineers. The standard, “Recommended Practice for Determining the Spatial-Peak Specific Absorption Rate (SAR) in the Human Body Due to Wireless Communications Devices: Experimental Techniques”, sets forth the first consistent test methodology for measuring the rate at which RF is deposited in the heads of wireless phone users. The test method uses a tissue-simulating model of the human head. Standardized SAR test methodology is expected to greatly improve the consistency of measurements made at different laboratories on the same phone. SAR is the measurement of the amount of energy absorbed in tissue, either by the whole body or a small part of the body. It is measured in watts/kg (or milliwatts/g) of matter. This measurement is used to determine whether a wireless phone complies with safety guidelines.

### **9. What steps can I take to reduce my exposure to Radio Frequency energy from my wireless phone?**

If there is a risk from these products — and at this point we do not know that there is — it is probably very small. But if you are concerned about avoiding even potential risks, you can take a few simple steps to minimize your exposure to Radio Frequency (RF) energy. Since time is a key factor in how much exposure a person receives, reducing the amount of time spent using a wireless phone will reduce RF exposure. If you must conduct extended conversations by wireless phone every day, you could place more distance between your body and the source of the RF, since the exposure level drops off dramatically with distance. For example, you could use a headset and carry the wireless phone away from your body or use a wireless phone connected to a remote antenna. Again, the scientific data does not demonstrate that wireless phones are harmful. But if you are concerned about the RF exposure from these products, you can use measures like those described above to reduce your RF exposure from wireless phone use.

### **10. What about children using wireless phones?**

The scientific evidence does not show a danger to users of wireless phones, including children and teenagers. If you want to take steps to

lower exposure to Radio Frequency (RF) energy, the measures described above would apply to children and teenagers using wireless phones. Reducing the time of wireless phone use and increasing the distance between the user and the RF source will reduce RF exposure.

Some groups sponsored by other national governments have advised that children be discouraged from using wireless phones at all. For example, the government in the United Kingdom distributed leaflets containing such a recommendation in December 2000. They noted that no evidence exists that using a wireless phone causes brain tumors or other ill effects. Their recommendation to limit wireless phone use by children was strictly precautionary; it was not based on scientific evidence that any health hazard exists.

### **11. What about wireless phone interference with medical equipment?**

Radio Frequency (RF) energy from wireless phones can interact with some electronic devices. For this reason, the FDA helped develop a detailed test method to measure Electro Magnetic Interference (EMI) of implanted cardiac pacemakers and defibrillators from wireless telephones. This test method is now part of a standard sponsored by the Association for the Advancement of Medical Instrumentation (AAMI). The final draft, a joint effort by the FDA, medical device manufacturers, and many other groups, was completed in late 2000. This standard will allow manufacturers to ensure that cardiac pacemakers and defibrillators are safe from wireless phone EMI.

The FDA has tested hearing aids for interference from handheld wireless phones and helped develop a voluntary standard sponsored by the Institute of Electrical and Electronic Engineers (IEEE). This standard specifies test methods and performance requirements for hearing aids and wireless phones so that no interference occurs when a person uses a "compatible" phone and a "compatible" hearing aid at the same time. This standard was approved by the IEEE in 2000.

The FDA continues to monitor the use of wireless phones for possible interactions with other medical devices. Should harmful interference be found to occur, the FDA will conduct testing to assess the interference and work to resolve the problem.

## 12. Where can I find additional information?

For additional information, please refer to the following resources:

FDA web page on wireless phones

(<http://www.fda.gov/cellphones/>)

Federal Communications Commission (FCC) RF Safety Program

(<http://www.fcc.gov/oet/rfsafety>)

International Commission on Non-Ionizing Radiation Protection

(<http://www.icnirp.de>)

World Health Organization (WHO) International EMF Project

(<http://www.who.int/emf>)

National Radiological Protection Board (UK)

(<http://www.hpa.org.uk/radiation/>)

## Driving

Check the laws and regulations on the use of wireless phones in the areas where you drive and always obey them. Also, if using your phone while driving, please observe the following:

- Give full attention to driving -- driving safely is your first responsibility;
- Use hands-free operation, if available;
- Pull off the road and park before making or answering a call if driving conditions or the law require it.

## 10 Driver Safety Tips

Your wireless phone gives you the powerful ability to communicate by voice almost anywhere, anytime. An important responsibility accompanies the benefits of wireless phones, one that every user must uphold.

When operating a car, driving is your first responsibility. When using your wireless phone behind the wheel of a car, practice good common sense and remember the following tips:

1. Get to know your wireless phone and its features such as speed dial and redial. Carefully read your instruction manual and learn to take advantage of valuable features most phones offer, including automatic redial and memory. Also, work to memorize the phone keypad so you



can use the speed dial function without taking your attention off the road.

2. When available, use a hands-free device. A number of hands-free wireless phone accessories are readily available today. Whether you choose an installed mounted device for your wireless phone or a speaker phone accessory, take advantage of these devices if available to you.
3. Make sure you place your wireless phone within easy reach and where you can reach it without removing your eyes from the road. If you get an incoming call at an inconvenient time, if possible, let your voicemail answer it for you.
4. Suspend conversations during hazardous driving conditions or situations. Let the person you are speaking with know you are driving; if necessary, suspend the call in heavy traffic or hazardous weather conditions. Rain, sleet, snow, and ice can be hazardous, but so is heavy traffic. As a driver, your first responsibility is to pay attention to the road.
5. Don't take notes or look up phone numbers while driving. If you are reading an address book or business card, or writing a "to-do" list while driving a car, you are not watching where you are going. It is common sense. Do not get caught in a dangerous situation because you are reading or writing and not paying attention to the road or nearby vehicles.
6. Dial sensibly and assess the traffic; if possible, place calls when you are not moving or before pulling into traffic. Try to plan your calls before you begin your trip or attempt to coincide your calls with times you may be stopped at a stop sign, red light, or otherwise stationary. But if you need to dial while driving, follow this simple tip -- dial only a few numbers, check the road and your mirrors, then continue.
7. Do not engage in stressful or emotional conversations that may be distracting. Stressful or emotional conversations and driving do not mix; they are distracting and even dangerous when you are behind the wheel of a car. Make people you are talking with aware you are driving and if necessary, suspend conversations which have the potential to

divert your attention from the road.

8. Use your wireless phone to call for help. Your wireless phone is one of the greatest tools you can own to protect yourself and your family in dangerous situations -- with your phone at your side, help is only three numbers away. Dial 911 or other local emergency number in the case of fire, traffic accident, road hazard, or medical emergency. Remember, it's a free call on your wireless phone!
9. Use your wireless phone to help others in emergencies. Your wireless phone provides you a perfect opportunity to be a "Good Samaritan" in your community. If you see an auto accident, crime in progress or other serious emergency where lives are in danger, call 911 or other local emergency number, as you would want others to do for you.
10. Call roadside assistance or a special wireless non-emergency assistance number when necessary. Certain situations you encounter while driving may require attention, but are not urgent enough to merit a call for emergency services. But you can still use your wireless phone to lend a hand. If you see a broken-down vehicle posing no serious hazard, a broken traffic signal, a minor traffic accident where no one appears injured or a vehicle you know to be stolen, call roadside assistance or other special non-emergency wireless number.

The above tips are meant as general guidelines. Before deciding to use your mobile device while operating a vehicle, it is recommended that you consult your applicable jurisdiction's local laws or other regulations regarding such use. Such laws or other regulations may prohibit or otherwise restrict the manner in which a driver may use his or her phone while operating a vehicle.

