



Some of contents in this manual may differ from your phone depending on the software of the phone or your service provider.

KM555R User Guide

Part 15.21 statement

" Change or Modifications that are not expressly approved by the manufacturer could void the user's authority to operate the equipment. "

Part 15.105 statement

This equipment has been tested and found to comply with the limits for a class B digital device, pursuant to Part 15 of the FCC Rules.

These limits are designed to provide reasonable protection against harmful interference in a residential installation. This equipment generates uses and can radiate radio frequency energy and, if not installed and used in accordance with the instructions, may cause harmful interference to radio communications. However, there is no guarantee that interference will not occur in a particular installation. If this equipment does cause harmful interference or television reception, which can be determined by turning the equipment off and on, the user is encouraged to try to correct the interference by one or more of the following measures:

- Reorient or relocate the receiving antenna.
- Increase the separation between the equipment and receiver.
- Connect the equipment into an outlet on a circuit different from that to which the receiver is connected.
- Consult the dealer or an experienced radio/TV technician for help.

Part 15 Class B Compliance

This device and its accessories comply with part15 of FCC rules.

Operation is subject to the following two conditions:

- (1) This device & its accessories may not cause harmful interference.
- (2) This device & its accessories must accept any interference received,
including interference that may cause undesired operation.

Body-worn Operation

This device has been tested for typical body-worn operations

with the distance of 0.79inches (2.0cm) from the user's body.

To comply with FCC RF exposure requirements, a minimum separation distance of 0.79inches(2.0cm) must be maintained from the user's body.

Additionally, Belt clips, holsters & other body-worn accessories may not contain metallic components.

Getting to know your phone

Power key

Turns the phone on/off.

Earpiece

Proximity Sensor



WARNING: Moisture on the proximity sensor may cause it to malfunction. Please wipe any moisture off the sensor surface.

End key

- Rejects a call.
- Press once to return to the home screen.

Call key

Dials a phone number and answers incoming calls.

Multitasking key



WARNING: Putting a heavy object on the phone or sitting on it can damage its LCD and touch screen functionality. Do not cover the protection film on proximity sensor of LCD. It can be caused the malfunction of sensor.

• — Music key

- — Camera key
 - Go to the camera menu directly by pressing and holding the key.

Volume keys

- When the screen is idle: key tone volume.
- During a call: earpiece volume.
- When playing a track: controls volume continuously.

- — Charger, Data cable (USB cable)

TIP: Before connecting the USB cable, wait until the phone has powered up and has registered on the network.

Open view

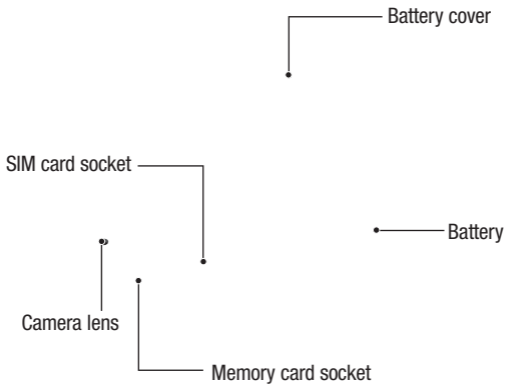

Installing the SIM and battery

1 Remove the battery cover

Press and hold down the battery release button on the top of the phone and lift off the battery cover.

 **WARNING:** Do not remove the battery when the phone is switched on, as this may damage the phone.

3 Install the SIM card

Slide the SIM card into the SIM card holder. Make sure the gold contact area on the card is facing downwards. To remove the SIM card, pull it gently in the outwards.

2 Remove the battery

Hold the top edge of the battery and lift it away from the battery compartment.

Installing the SIM and battery

4 Install the battery

First insert the top of the battery into the top edge of the battery compartment. Ensure that the battery contacts align with the phone's terminals. Press the bottom of the battery down until it clips into place.

Charging your phone

- 1 Ensure the battery is fully charged before using the phone for the first time.
- 2 With the arrow facing you as shown in the diagram push the plug on the travel adapter into the socket on the side of the phone until it clicks into place.
- 3 Connect the other end of the travel adapter to the main socket. Use only the charger included in the box.
- 4 The moving bars of battery icon will stop after charging is complete.

NOTE: The battery must be fully charged initially to improve battery lifetime. Disregard the first “Battery full” message and keep the phone on charge overnight.

Memory card

Installing a memory card

You can expand the available memory space on your phone by using a memory card.

NOTE: A memory card is an optional accessory.

Slide the memory card into the slot at the top, until it clicks into place. Make sure the gold contact area is facing downwards.

Your home screen

From this screen you can access menu options, make a call, view the status of your phone and much more.

- Whenever your KM555R is not in use, it will return to the lock screen.

Touch screen tips

The home screen is also a great place to get used to using the touch screen.

To select an item, touch the centre of the icon.

- Do not to press too hard; the touchscreen is sensitive enough to pick up on a light, firm touch.
- Use the tip of your finger to touch the option you require. Be careful not to touch any other keys.
- When the screen light is off, either press the power key or hold down the Unlock/Lock key on the touch screen to return the home screen.

Customising the home screen

1. Widget home screen (active) 3. Contact home screen
2. Livesquare screen
- 

Quick keys

The quick keys on your home screen provide easy, one-touch access to the functions you use the most.



Touch to bring up the touch dialling pad, which lets you make a call. Enter the number using the normal key pad and touch **call** icon.



Touch to open your contacts. To search for the number you want to call: Enter the name of the contact using the touchpad. You can also create new contacts and edit existing ones.



Touch to access the **Messaging** menu. From here you can create a new SMS.









Touch to open the full Top menu which is divided into four categories.







Your standby screen

The status bar

The status bar uses various icons to indicate things like signal strength, new messages and battery life.

Below is a table which explains the meaning of the icons you're most likely to see in the status bar.

Icon	Description
	Multitasking
	Network signal strength (number of bars will vary)
	No network signal
	Remaining battery life
	Battery empty
	New text message
	New voice message
	Message inbox is full
	Message sending failed
	An alarm is set
	My Profile in use
	Normal profile in use
	Outdoor profile in use
	Silent profile in use
	Headset profile in use

Icon	Description
	Calls are diverted
	EDGE in use
	Roaming
	Flight mode is on
	Bluetooth is active
	BGM play
	BGM pause

Changing your Status from the status bar



Touch the status bar to open the Status Summary. It shows the current Time, Network, SVC ID, Battery, Handset memory, External Memory, Profile, MP3 and Bluetooth status.

Using the Multitasking function

Press the multitasking hard key  to open the Multitasking menu. From here you can view all the applications you have running and access them with one touch.

Calls

Making a call

- 1 Touch  to open the keypad.
- 2 Key in the number using the keypad. To delete a digit touch the clear key.
- 3 Press the  hard key to initiate the call.
- 4 To end the call press the  hard key.

TIP! To enter + for making an international call, press and hold  .

TIP! To bring up the keypad during a call, press the .

Making a call from your contacts

- 1 From the standby screen touch  to open the contacts.
- 2 Enter the first few letters of the contact you would like to call.

- 3 From the filtered list, touch the contact you'd like to call and select the number to use if you have more than one saved.
- 4 Touch .

In-call options

 **Hold** - Touch this icon to put a call on hold.

 **Mute** - Touch this icon to turn off the microphone so the person you are talking to cannot hear you.

 **Speaker** - Touch this icon to turn on the speaker phone.

 **Options** - Choose from a list of further in-call options, including **Go to messages**, so you can check your messages, **Go to contacts** to add or search contacts during a call. You can also end the call from here by touching **End call**.

Calls

 - Choose to open a numerical keypad for navigating menus with numbered options. For example, when dialling call centres or other automated telephone services.

 - Choose to add another person to the call.



 - Choose to search your contacts during a call.

Adjusting the call volume

To adjust the volume during a call, use the up and down button on the left edge of the phone.

Speed dialling

You can assign a frequently-called contact to a speed dial number.

- 1 From the standby screen touch  and select .
- 2 Your Voicemail is already set to speed dial 1. You cannot change this. Touch any other number to assign it a speed dial contact.

- 3 Your contacts will open. Select the contact you'd like to assign to that number by touching their phone number once. To find a contact tap the **Name** field box and enter the first letter of the name of the contact required.

Turning off DTMF

DTMF allows you to use numerical commands to navigate menus within automated calls. DTMF is switched on as default.

To turn it off during a call (to make a note of a number for example) touch  and select **DTMF off**.

Viewing your call logs

TIP! To scroll through a list of options, touch the last item visible and slide your finger up the screen. The list will move up so more items are visible.

Touch  and select .
Choose to view:

All - View a complete list of all your dialled, received and missed calls.

Dialled - View a list of all the numbers you have called.



Received - View a list of all the numbers that have called you.

Missed - View a list of all the calls you have missed.

TIP! From any call log touch  and **Delete all** to delete all the recorded items.

TIP! Touch any single call log entry to view the date, time and duration of the call.

Using call divert



- 1 Touch , select .
- 2 Touch **Call divert**.
- 3 Choose whether to divert all calls, when the line is busy, when there is no answer or when you are not reachable.
- 4 Touch "To voice mail centre" OR "To other number"
- 5 Input the number you'd like to divert to.
- 6 Touch **Request** to activate.

NOTE: Charges are incurred for diverting calls. Please contact your network provider for details.

TIP! To turn off all call diverts, choose **Deactivate all** from the **Call divert** menu.



Calls

Using call barring

- 1 Touch , select .
- 2 Touch **Call barring**.
- 3 Choose any or all of the six options:
 - All outgoing
 - Outgoing international
 - Outgoing international calls except home country
 - All incoming
 - Incoming when abroad
 - Deactivate all
- 4 Enter the call barring password. Please check with your network operator for this service.

TIP! Select **Fixed dial number** to turn on and compile a list of numbers which can be called from your phone. You'll need your PIN2 code from your operator. Only numbers included in the fixed dial list can be called from your phone.

Changing the common call setting

- 1 Touch , select .
- 2 Touch **Common settings**. From here you can amend the settings for:
 - Call reject** - Slide the switch to **On** to highlight the Reject list. You can touch the text box to choose from all calls, contacts or groups, or those from unregistered numbers (those not in your contacts). Touch **Save** to change the setting.

Send my number - Choose whether your number will be displayed when you call someone.

Auto redial - Slide the switch left for **On** or right for **Off**.

Minute minder - Slide the switch left to **On** to hear a tone every minute during a call.

BT answer mode - Select **Hands-free** to be able to answer a call using a Bluetooth headset, or select **Handset** to press a key on the handset to answer a call.

Save new number - Select **Yes** to save a new number.



TIP! To scroll through a list of options, touch the last item visible and slide your finger up the screen. The list will move up so more items are visible.

Contacts



Searching for a contact

There are two ways to search for a contact:

From the standby screen

- 1 From the standby screen touch  to open the contacts. Select the contact from the list that you want to make a call.
- 2 Touch the  hard key to initiate the call.

From the main menu

- 1 Touch , select .
- 2 Select **Search**.
- 3 You see a list of contacts, typing in the first letter of a contact's name will jump the menu to that alphabetical area of the list.

TIP! The alphabetical keypad is displayed once you tap the blank square.

TIP! To scroll through your list of contacts, touch the last item visible and slide your finger up the screen. The list will move up so more items are visible.

Adding a new contact

- 1 From the standby screen touch  and touch  and select **Add contact**.
- 2 Choose whether to save the contact to your **Handset** or **SIM**.
- 3 Enter the first and last name of your new contact. You do not have to enter both, but you must enter one or the other.

- 4 You can enter up to five different numbers per contact. Each entry has a preset type **Mobile, Home, Office, Pager, Fax, and General**. When you have finished, touch **Close**.
- 5 Add an email address.
- 6 Assign the contact to one or more groups. Choose from **No group, Family, Friends, Colleagues, School or VIP**.
- 7 You can also add other informations.
- 8 Touch **Save** to save the contact.

Contact options

There are many things you can do when viewing a contact. Here's how to access and use the options menu:

- 1 Open the contact you'd like to use.
- 2 You can call or send a message directly from here.
- 3 Press  to open the list of options.

Edit - Change any of the contact's details.

Delete - Delete the contact. Touch **Yes** if you are sure.

Copy or Move to SIM / Handset - Choose to move or copy to the SIM card or handset (depending on where you originally saved the contact).



Contacts

Send business card - Send the contact's details to another person as a business card. Choose to send as a **Text message**, **Multimedia message**, **Email** or via **Bluetooth**.

TIP! Send message

- Send a message to the contact. If the contact has an email address, select whether you'd like to send an email or Message.

Creating a group

- 1 Touch  and select .
- 2 Select **Groups**.
- 3 Touch .
- 4 Select **Add group**.
- 5 Enter a name for your new group. You can also assign a ringtone to the group.
- 6 Touch **Save**.



NOTE: If you delete a group, the contacts which were assigned to that group will not be lost. They will remain in your contacts.

TIP! You can edit an existing group by highlighting it and touching . Choose **Add members** to the group from your contacts, assign a Group ringtone, Rename the group or Delete a group.

Changing your contact settings

You can adapt your contact settings so that your address book suits your own preferences.

TIP! To scroll through a list of options, touch the last item visible and slide your finger up the screen. The list will move up so more items are visible.

- 1 From the standby screen touch .
- 2 Touch  and select **Settings**.
- 3 From here you can adjust the following settings:

Contact list settings - Choose whether to view contacts saved to both your **Handset & SIM**, Handset only or SIM only.

You can also choose to show the first name or last name of a contact first.

Copy - Copy your contacts from your SIM to your handset or from your handset to your SIM. Choose to do this one at a time, or all at once. If you select one at a time, you'll need to select each contact to copy one by one.

Move - This works in the same way as Copy, but the contact will only be saved to the location you've moved it to. So if you move a contact from the SIM to the handset it will be deleted from the SIM memory.

Send all contacts via Bluetooth - Send all of your contacts to another device using Bluetooth. You will be prompted to turn on Bluetooth if you select this option.

Backup and Restore contacts - Backup and restore contacts to the Memory Card.



Clear contacts - Delete all your contacts. Touch **Yes** if you are sure you want to wipe your contacts.

Messaging

Messaging

Your KM555R combines SMS, MMS and email into one intuitive and easy to use menu.

There are two ways to enter the messaging centre:

- 1 Touch  from the standby screen.
- 2 Or Touch  from the standby screen, then select .

Sending a message

- 1 Touch **New message** to open a blank message.
- 2 From here you can send an SMS or MMS. To send an email, touch  from the standby screen, then select .

 **WARNING:** You will be charged per per 1 page text message for each person that you send the message to.

 **WARNING:** If an image, video or sound is added to an SMS it will be automatically convert to an MMS and you will be charged accordingly.

TIP! Quick reply - Send a reply promptly to the selected message using a template.

Entering text

Keypad, Keyboard, Handwriting-Screen, Handwriting-Box, Handwriting-Double Box.

You can choose your input method by tapping  and **Input method**.

Tap the screen once, the keyboard appears.

 Touch to turn on T9 predictive text.

 You can choose writing languages.

 Tap to change numbers, symbols and text keypad.

Use  to scroll through the different keyboard types in each text entry mode (for example, capitals or lowercase).

T9 predictive

In T9 mode you will see .

T9 mode uses a built-in dictionary to recognise words you're writing based on the key sequences you touch. Simply touch the number key associated with the letter you want to enter, and the dictionary will predict the word you want to use.

For example, press 8, 3, 5, 3, 7, 4, 6, 6, 3 to write 'telephone'.

Abc manual

In Abc mode you will see .

In Abc mode you must touch the key repeatedly to enter a letter.

For example, to write 'hello', touch 4 twice, 3 twice, 5 three times, 5 three times again, then 6 three times.

Messaging

Keyboard

In Keyboard mode the screen flips to landscape and a full keyboard appears on screen.

TIP! Keyboard mode predicts and shows what you will type in next. These words are predicted based on the sentences you have typed in so far. If you do not wish to use the suggested words, keep typing in new words. If you wish to use the suggested words, press the space bar to confirm them.

TIP! You may find it easier to use the stylus in this mode, please remember to press lightly to protect your screen from damage.

Handwriting recognition translates stylus gestures into letters, numbers or other character, and displays these characters as text. Handwriting recognition is only active where text can be entered.

Note: Most letters can be written using different stroke styles. See the tables below. The position on the screen decides case, not the style.

Handwriting recognition

In Handwriting mode you simply write on the screen and your KM555R will convert your handwriting into your message. Select Handwriting **Screen** or **Box** or **Double box** depending on your preferred view.

Alphabet

If you select capital letter mode (ABC), letters you type will be inserted as capital letters even if you write in small letters, and vice versa.

Letter	Strokes
A	A A' a a'
B	B B' b b'
C	C C'
D	D D' d d'
E	E E' e e'
F	F F' f f'
G	G G' g g'
H	H H' h h'
I	I I' i i'
J	J J' j j'
K	K K' k k'
L	L L' l l'

Letter	Strokes
M	M M' m m'
N	N N' n n'
O	O O' o o'
P	P P' p p'
Q	Q Q' q q'
R	R R' r r'
S	S S'
T	T T' t t'
U	U U' u u'
V	V V'
W	W W' w w'
X	X X'
Y	Y Y' y y'
Z	Z Z'
B	B

Messaging

Numbers



Numbers are written above the arrow.

Number	Strokes
0	0 0
1	1 1 ₁ 1 1 1
2	2 2 2
3	3 3
4	4 4 4 4
5	5 5 ₁ 5 ₂ 5
6	6
7	7 7 7 ₂ 7
8	8 8 8 8
9	9 9 9 9

Changing your email settings

You can change your email settings according to your own preferences.

TIP! To scroll through a list of options, touch the last item visible and slide your finger up the screen. The list will move up so more items are visible.

- 1 Touch  then select .
- 2 Touch Email settings from options and select **Email** accounts to set up a new account then you can adapt the following settings.

Allow reply Email - Choose to allow the sending of 'read, confirmation' messages.

Request reply Email - Choose whether to request read confirmation messages.

Retrieve interval - Choose how often your KM555R checks for new email messages.

Retrieve amount - Choose the number of emails to be retrieved at any one time.

Include message in Fwd & Reply - Choose to include the original message in your reply.

Include attachment - Choose to include the original attachment in any reply.

Auto Retrieval in Roaming - Choose whether to retrieve your messages automatically when abroad (roaming).

TIP! Costs for retrieving email may be higher when roaming. Check with your network supplier.

New email notification - Choose whether to be alerted to new emails.

Signature - Switch this feature on and Create an email signature.

Priority - Choose the priority level of your email messages.

Mail sending size - Set the maximum size of sending mail.

E-mail counter - Input the date you want. You can check emails you sent during that period.

Message folders

You'll recognise the folder structure used on your KM555R, which is fairly self-explanatory.

Inbox - All the messages you receive are placed into your inbox. From here you can view, delete and more, see **Managing your messages** below for details.

Drafts - If you don't have time to finish writing a message, you can save what you've done so far here.

Messaging

Outbox - This is a temporary storage folder while messages are being sent or failed messages are stored here.



Sent items - All the messages you have sent are placed in this folder.

My Folders - Create folders to store your messages.

Managing your messages

You can use your Inbox to manage your messages.

TIP! To scroll through a list of options, touch the last item visible and slide your finger up the screen. The list will move up so more items are visible.

- 1 Touch  then select .
- 2 Select **Inbox**.
- 3 Touch  and then choose to:

Delete - Delete marked messages.

Threaded view - Displays all the messages received from a particular number in one screen.

Create new message - Open a new blank message.

Move to my folders - Move the marked messages to My folders.

Filter - View your message by type. This will group SMS separately from MMS.



Delete all - Delete all of the messages.

If you see the message **No space for SIM messages** you should delete some messages on the SIM.

If you see the message **No space for messages** you should delete some messages to free up memory space.

Using templates

Create templates for the SMS and MMS messages you send most frequently. You'll find some templates already on your phone, you can edit these if you wish.

- 1 Touch  then choose **Templates**.
- 2 Choose **Text templates** or **Multimedia templates**. You can then touch  to **Add new**, **Delete** or **Delete all** templates.
- 3 Touch **Add template** to create a new template.
- 4 You can view the template by selecting it on the list and edit it by touching on the view screen.

Using emoticons

Liven up your messages using emoticons. You'll find some commonly used emoticons already on your phone.

- 1 Touch  then choose **Emoticons**.
- 2 Touch  to **Add new**, **Delete** or **Delete all** emoticons.

Changing your text message settings

Your KM555R message settings are pre-defined so that you can send messages immediately. These settings can be changed according to your preferences.

TIP! To scroll through a list of options, touch the last item visible and slide your finger up the screen. The list will move up so more items are visible.

Messaging

Touch  then choose **Settings** on the **Communication** menu. Select **Text message**. You can make changes to:

Text message centre - Enter the details of your message centre.

Delivery report - Slide the switch left to receive confirmation that your messages have been delivered.

Validity period - Choose how long your messages are stored at the message centre.

Message types - Convert your text into **Text, Voice, Fax, X.400** or **Email**.

Character encoding - Choose how your characters are encoded. This impacts the size of your messages and therefore data charges.

Send long text as - Choose to send long messages as **Multiple SMS** or as **MMS**.

Changing your multimedia message settings

Your KM555R message settings are pre-defined so that you can send messages immediately. These settings can be changed according to your preferences.

Touch . Choose **Settings** and **Multimedia message**. You can make changes to:

Retrieval mode - Choose **Home** or **Roaming network**. If you then choose **Manual** you will receive only notifications of MMS and you can then decide whether to download them in full.

Delivery report - Choose to allow and/or request a delivery report.

Read report - Choose to allow and/or request a reply report.

Priority - Choose the priority level of your MMS.

Validity period - Choose how long your message is stored at the message centre.

Slide duration - Choose how long your slides appear on screen.

Creation mode - Choose your message mode.

Delivery time - Choose how long before a message is delivered.

Multi msg centre - Enter the details of your message centre.

Changing your other settings

Touch , choose **Settings** on the **Communication** menu:



Voicemail - Touch  to add a new Voicemail service. Contact your network operator for more information on the service they provide.

Service message - Choose to receive or block service messages. You can also set your Service security by creating trusted and untrusted lists of senders.

Info service - Choose your reception status, language and other settings.

Taking Photo

Taking a quick photo

- 1 Press and hold the  key on the right side of the phone.
- 2 The viewfinder will appear on screen.
- 3 Holding the phone horizontally, point the lens towards the subject of the photo.
- 4 Position the phone so you can see the subject of your photo in the preview screen.
- 5 When the camera has focused on your subject, press the  on the side of the phone firmly.

After you've taken your photo

Your captured photo will appear on screen. The name of the image runs along the bottom of the screen.

 Touch to send the photo as a message, e-mail or Bluetooth or Blogger.

 Touch to use the picture you have taken as Home screen, Contacts image, Start-up image and Shut down image.

 Touch to edit the photo.

TIP! You can bring up the options by tapping the screen. They auto turn off after a few seconds.

Adjusting the Zoom

- 1 Touch .
- 2 Slide the zoom indicator along the bar.

Adjusting the exposure

Exposure defines the difference between light and dark (contrast) in an image. A low contrast image will appear foggy, whereas a high contrast image will appear much sharper.

- 1 Touch .
- 2 Slide the contrast indicator along the bar - left for a lower exposure, hazier image or right for a higher exposure, sharper image.

Camera

Choosing a shot type

- 1 Touch  to open the available shot types.
- 2 Choose from two options:

Normal shot - This is the default shot type, the photo will be taken in the normal way, as outlined in taking a quick photo.

Three / Six / Nine - This enables you to take 3/6/9 shots automatically in very quick succession.

Selecting view mode

- 1 Touch .
- 2 Choose from **Full screen** or **Full image**. In Full screen some clipping of the image may occur.

Using the advanced settings

From the viewfinder touch  to open all the advanced settings options.

Preview settings

Size - Change the size of the photo to save on memory space.

Colour Effect - Choose a colour tone to apply to the photo you're taking.

White balance - Choose from Auto, Incandescent, Sunny, Fluorescent or Cloudy.

Night mode - Useful to use at dark place.

Camera

Self-timer - The self-timer allows you to set a delay after the capture button is pressed before the camera takes the picture. Choose from **3 seconds**, **5 seconds** or **10 seconds**. Great for that group photo you want to be part of.

Quality - Choose between **Super fine**, **Fine** and **Normal**. The finer the quality the sharper a photo will be, but the file size will increase. This means you'll be able to store fewer photos in your memory.

Memory - Choose whether to save your photos to the Handset memory or to the External memory.

Show captured image - Select ON/OFF for showing the captured image.

Hide icons - Select how to display the icons.

Shutter sound - Select one of the three shutter sounds.

Grid screen - Choose from Off, Simple cross or Trisection.



Noise reduction - Use this feature to reduce the noise.

Reset settings - Reset all the camera settings.

TIP! When you exit the camera all your settings will return to default, except image size and image quality. Any non-default settings you require will need to be reset, for example colour tone. Check them before you shoot your next photo.



Video camera

Shooting a quick video

- 1 Press the camera key on the right side of the phone.
- 2 On the Camera preview mode touch and hold down the camera icon in the view finder to switch to video mode. The video camera's viewfinder will appear on screen.
- 3 Holding the phone horizontally, point the lens towards the subject of the video.
- 4 Press the capture button once to start recording. Or press the red dot at the bottom right of the screen.
- 5 **Rec** will appear at the top of the viewfinder and a timer at the bottom showing the length of your video.
- 6 To pause the video touch  and resume by selecting .
- 7 Touch  on screen or press the capture button a second time to stop recording.

After you've shot your video

A still image representing your captured video will appear on screen.

-  Touch to play the video.
-  Touch to send the video as a **message, e-mail or Bluetooth or YouTube.**
-  Touch to edit the video.

TIP! You can close all the shortcut options for a clearer viewfinder screen. Simply touch the centre of the viewfinder once. To recall the options touch the screen again.

Video camera

Adjusting the Zoom

- 1 Touch .
- 2 Slide the zoom indicator along the bar.

Adjusting the Exposure

Exposure defines the difference between light and dark (contrast) in an image. A low contrast image will appear foggy, whereas a high contrast image will appear much sharper.

- 1 Touch .
- 2 Slide the exposure indicator along the bar, left for a lower exposure, hazier image, or right for a higher contrast, sharper image.

Changing the video image size

The more pixels, the larger the file size, which in turn means they take up more memory. If you want to fit more videos on to your phone you can alter the pixel number to make the file size smaller.

- 1 Select  from the Preview menu.
- 2 Select a pixel value from the two options:

 **320x240** - Large image size, therefore larger file size. Up to 24 fps are available for video play back, up to 12 fps are available for video recording.

 **176x144** - Small image size and therefore smaller file size. Up to 15 fps are available for video play back.

- 3 Select the size option you'd like to use.

Selecting view mode

- 1 Touch .
- 2 Choose from Full screen or Full image. In Full screen some clipping of the image may occur.

Using the advanced settings

From the viewfinder touch  to open the settings options.

Preview settings

Colour Effect - Choose a colour tone to apply to the video you're taking.

White balance - The white balance ensures that any white in your videos is realistic. In order for your camera to correctly adjust the white balance you may need to determine the light conditions.

Quality - Choose between **Super fine**, **Fine** and **Normal**. The finer the quality the sharper a video will be, but the file size will increase as a result, which means you'll be able to store fewer videos in the phone's memory.

Set time - Set a duration limit for your video. Choose from **No limit**, or **MMS** to limit the size so that you can send the video as an MMS.

Memory - Choose whether to save your videos to the **Handset memory** or to the **External memory**.

TIP! If you choose MMS duration, try choosing a lower image quality to enable you to shoot a longer video.



Voice - Choose Mute to record a video without sound.

Hide icons - Select how to display the icons.

Reset settings - Reset all the video camera settings.

Multimedia

You can store any multimedia files into your phone's memory so that you have easy access to all of your pictures, sounds, videos and games. You can also save your files to a memory card. The advantage of using a memory card is that you can free up space on your phone's memory.

To access the Multimedia menu, touch  then  to open a list of folders storing all of your multimedia files.

Pictures

Images contains a list of pictures including default images pre-loaded onto your phone, images downloaded by you and images taken on your phone's camera.

Touch  then select List view to change the view from thumbnail image to list.

Images option menus

The options which are available to you in **Images** depend on what type of image you have selected. All of the options will be available for pictures you have taken on the phone's camera, but only the **Sort by, phone's camera, but only the Sort by, Search, Folder info.** options are available for default images.

Send - Send the image to a friend.

Move - Move an image from the phone memory to a memory card or vice versa.

Copy - Copy an image from the phone memory to a memory card or vice versa.

Delete - Delete an image.

Rename - Rename an image.

Print - Print the selected image using a printer.

Create new folder - Create a new folder.



Slide show - Start a slide show.

List/Grid view - Grid view to List view or vice versa.

Folder info. - View the Name, Size, Date details of the folder and number of files and sub-folders inside the folder.



Delete all - Delete all of your images.

Sending a photo

- 1 Touch .
- 2 Touch  then choose **Images**.
- 3 Touch **Send** and choose from **Message**, **Email** or **Bluetooth**.
- 4 If you choose **Message** or **Email**, your photo will be attached to a message and you can write and send the message as normal. If you choose **Bluetooth**, you will be prompted to turn Bluetooth on and your phone will search for a device to send the picture to.

Using an image

You can choose images to use as wallpapers, contact image, start up image or shut down image.

- 1 Touch .
- 2 Touch  then **Images**.
- 3 Select an image and touch .
- 4 Touch **Use as** and choose from:

Wallpaper - Set a wallpaper for the standby screen.



Contacts image - Allocate an image to a particular person in your contacts list so that their picture shows when they call you.

Start-up image - Set an image to appear when you switch the phone on.

Shut down image - Set an image to appear when you switch the phone off.

Multimedia

Printing an image



- 1 Touch .
- 2 Touch  then **Images**.
- 3 Select an image and touch .
- 4 Touch **Print** then choose between **Bluetooth** and **PictBridge**.

TIP! You can to print via bluetooth or by connecting to a PictBridge compatible printer.

Sounds

The **Sounds** folder contains the Downloaded sounds, **Default sounds** and **Voice recordings**. From here you can manage, send or set sounds as ringtones.



Using a sound

- 1 Touch .
- 2 Touch  then **Sounds**.
- 3 Select a sound and and it will begin to play.
- 4 Touch  and select **Use as**.
- 5 Choose from **Ringtone**, **Message tone**, **Start-up** or **Shut down**.

Videos

The **Videos** folder shows a list of downloaded videos and videos you have recorded on your phone.

Watching a video

- 1 Touch .
- 2 Touch  then **Videos**.
- 3 Select a video to play.

Using options while video is paused

Touch  while in pause mode and choose from:

Capture - Capture the frozen frame as a picture.

Send - Send the video in a message, E-mail, Bluetooth or via Youtube.

Delete - Delete the video.

Edit - Edit the video.

File info. - View the Name, Size, Date, Time, Type, Duration, Protection and Copyright details.

Editing a video clip

1 Select a video.

2 Touch  then.

3 Touch **Edit** and choose from:

Trim - Cut the video down to only the part you want.

Video merge - Merge the video with another video clip.

Image merge - Merge the video with an image from your Images folder.

Text overlay - Add text to the video.

Image overlay - Add an image to the video.

Audio dubbing - Choose to add sound from the **Defaults folder** or from your own **Voice recordings**.

Voice recording - Add a voice recording

Time scaling - Use this feature to increase / decrease the playing speed of the video.

Multimedia

Sending a video clip

- 1 Select a video and touch .
- 2 Touch Send and choose from Message, Email, Bluetooth or YouTube.
- 3 If you choose **Message** or **Email**, your video clip will be attached to the message and you can write and send the message as normal. If you choose **Bluetooth**, you will be prompted to turn Bluetooth on and your phone will search for a device to send the video to.

Using the video options menu

From the **Videos** folder, you can choose from the following options:

Send - Send a video to a friend.

Move - Move a video clip from the phone memory to a memory card or vice versa.

Copy - Copy a video clip from the phone memory to a memory card or vice versa.

Delete - Delete a video.

Rename - Rename a video.

Create new folder - Create a new folder within the **Videos** folder.

Sort by - Sort videos into order by Date, Type or Name.

List/Grid view - Grid view to List view or vice versa.

Folder info - View the Name, Size, Date details of the folder and number of files and sub-folders inside the folder.

Delete all - Delete all videos.

Games and Applications

You can install new games and applications to your phone to keep you amused when you have time to spare.

TIP! To Enter the Facebook, MySpace, Twitter application, touch  and select **Games & Apps** then choose **Applications** and **Social Networking**.



Documents

Select mystuff then select Documents. From the Documents menu, you can view all of your document files.



Transferring a file to your phone

Bluetooth is probably the easiest way to transfer a file from your computer to your phone.

To transfer using Bluetooth:



- 1 Make sure your phone and computer have Bluetooth switched on and are visible to one another.
- 2 Use your computer to send the file via Bluetooth.
- 3 When the file is sent you will have to accept it on your phone by touching **Yes**.
- 4 The file should appear in your **Documents** or **Others** folder.

Viewing a file

- 1 Touch .
- 2 Touch  then **Documents**.
- 3 Select a document and touch **View**.

Multimedia

Music

Your LG KM555R has a built-in music player so you can play all your favourite tracks. To access the music player, touch  then .

Transferring music onto your phone

The easiest way to transfer music onto your phone is via Bluetooth or your sync cable.

You can also use LG PC Suite. To transfer using Bluetooth:

- 1 Make sure both devices have Bluetooth switched on and are visible to one another.
- 2 Select the music file on the other device and choose to send it via Bluetooth.
- 3 When the file is ready to be sent you should accept it on your phone by touching **Yes**.
- 4 The file should appear in **Music > All tracks**.

Playing a song

- 1 Touch .
- 2 Touch , then **All tracks**.
- 3 Select the song you want to play.
- 4 Touch  to pause the song.
- 5 Touch  to skip to the next song.
- 6 Touch  to skip to the previous song.
- 7 Touch  to return to the **Music** menu.

Using the radio



Your LG KM555R has an FM radio feature so you can tune into your favourite stations to listen to on the move.





NOTE: You will need to insert your headphones in order to listen to the radio. Insert them into the headphone socket.

Searching for stations



You can tune radio stations into your phone by searching for them either manually or automatically. They will then be saved to specific channel numbers so you don't have to keep re-tuning. You can save up to 50 channels in your phone. You must first attach the headset to the phone as this acts as the antenna.

To auto tune:



- 1 Touch .
- 2 Touch  then .
- 3 Touch Auto scan. Then the stations will be automatically found and allocated to a channel in your phone.

NOTE: You can also manually tune into a station by using  and  displayed next to the radio frequency. If you press and hold  and , the stations will be automatically found.

Resetting channels

- 1 Touch .
- 2 Touch  then .
- 3 Choose Reset channel to reset the current channel or choose Reset all to reset all of the channels. Each channel will return to the starting 87.5Mhz frequency.



Listening to the radio

- 1 Touch .
- 2 Touch  then touch the channel number of the station you would like to listen to.

TIP! To improve the radio reception, extend the headset cord, which functions as the radio antenna.

Organiser

Adding an event to your calendar

- 1 From the standby screen select , then touch . Select **Calendar**.
- 2 Select the date you would like to add an event to.
- 3 Touch  then **Add event**.
- 4 Touch **Category** then choose from **Appointment**, **Anniversary** or **Birthday**. Check the date and enter the time you would like your event to begin.
- 5 For appointments and anniversaries enter the time and date your event finishes in the lower two time and date boxes.



6 IF you would like to add a subject to your event, touch **Subject** and type in your note, followed by **Save**.

7 Set **Alarm** and **Repeat**.



8 Select **Save** and your event will be saved in the calendar. A square cursor will mark the day that any events have been saved to and a bell will ring at the start time of your event, so that you can stay organised.

TIP! You can set a holiday in your calendar. Touch each day you are on holiday one at time, then touch  and select **Set holiday**.

Changing your default calendar view



- 1 From the standby screen select , then touch .
Select **Settings**.
- 2 Touch **Calendar Settings** and choose either **Monthly view** or **Week view**.
- 3 Set **week starts on**.
- 4 Touch **Save** to confirm your choice.

Adding an item to your to do list

- 1 From the standby screen select , then touch .
- 2 Select **To do** and touch **Add to do**.
- 3 Set the date for the to do item, add notes and select a priority level: **High**, **Medium** or **Low**.
- 4 Save your to do list item by selecting **Save**.

TIP! You can edit a item by selecting it, and touch the tab and input. Confirm your amends by selecting **Save**.

Setting your alarm

- 1 From the standby screen select , then touch .
- 2 Touch **Add alarm**.
- 3 Set the time you would like the alarm to sound and touch **Save**.
- 4 Choose whether you would like your alarm to repeat **Once**, **Daily**, **Mon - Fri**, **Mon - Sat**, **Sat - Sun**, **Except holiday** or **Choose weekday**.
The icons indicate the weekday you select.
- 5 Select **Alarm type** to select a type for your alarm.
- 6 Touch **Alarm bell** then choose. To listen to sounds touch the sound, followed by .



Organiser

- 7 Add a memo for the alarm.
Touch **Save** when you have finished typing the memo.
- 8 Finally you can set the snooze interval at 5, 10, 20, 30 minutes, 1 hour or off.
- 9 Once you have set your alarm, touch **Save**.

TIP! Touch on/off icon on the right hand side of the alarm to set.

Voice recorder

Use your voice recorder to record voice memos or other sounds.

- 1 Touch .
- 2 Touch  then  and **Settings** choose from:



Duration – Set the recording duration. Choose from **No limit**, **MMS** or **1 minute**.

Quality – Select the sound quality. Choose from **Super Fine**, **Fine** or **Normal**.

Recording a sound or voice

- 1 Touch .
- 2 Touch .
- 3 Touch  to begin recording.
- 4 Touch  to end recording.
- 5 Touch  to listen to your recording.

Using your calculator

- 1 From the standby screen select , then touch .
- 2 Touch the numeric keys to input numbers.
- 3 For simple calculations, touch the function you require (+, -, *, /), followed by =.
- 4 For more complex calculations, touch  and choose from **sin**, **cos**, **tan**, **log**, **ln**, **exp**, **sqrt**, **deg** or **rad** etc..

Settings

Within this folder you can adapt your settings to make your KM555R personal to you.

Changing your screen settings

1 Touch  then choose .

2 Select from:

Wallpaper - Choose the theme for your standby screen.

Top Menu - Choose the style of the top menu.

Dialing - Adjust the colour.

Font - Adjust the font size.

Backlight - Choose how long the backlight remains on for.

NOTE: The longer the backlight is on for, the more battery power is used and you may need to charge your phone more often.

Brightness - Adjust the screen brightness.

Greeting message - Choose on or off and fill in the greeting message.

Start-up/Shut down - Choose the image for your start-up/shut down screen.



3 Touch **Save** to save your settings.

Changing your phone settings

Enjoy the freedom of adapting how your KM555R works to your own style.

TIP! To scroll through a list of options, touch the last item visible and slide your finger up the screen. The list will move up so more items are visible.

Settings

- 1 Touch .
- 2 Touch  then choose from the list below.

Date & Time - Adjust your date and time settings or choose to auto update the time when you travel or for daylight saving.

Power save - Choose to switch the factory set power saving settings **Off**, **Night only** and **Always on**.

Languages - Change the language of your KM555R's display.

Auto key lock - Lock the keypad automatically in standby screen.

Security - Adjust your security settings, including PIN code request, Change codes, ATMT and handset lock.

Memory info - See the memory status.

Reset settings - Reset all the settings to their factory definitions.

Information - View the technical information for your KM555R.

Using memory information

Your KM555R has three memories available: the phone, the SIM Card and an external memory card (you may need to purchase the memory card separately).

You can use memory information to determine how each memory is used and see how much space is available.

Touch . Select  then **Memory info**.

Handset common memory

- View the memory available on your KM555R for Pictures, Sounds, Video, Flash, MMS, Email, Java and others.

Handset reserved memory

- View the memory available on your handset for SMS, Contacts, Calendar, To do list, Memo, Alarm, Call history, Bookmarks and Miscellaneous items.

SIM memory - View the memory available on your SIM Card.

External memory - View the memory available on your external memory card (you may need to purchase the memory card separately).

Primary storage settings - Choose the location you prefer items to be saved to.

Sending and receiving your files using Bluetooth

Bluetooth is a great way to send and receive files as no wires are needed and connection is quick and easy. You can also connect to a Bluetooth headset to make and receive calls.

To send a file:

- 1 Open the file you want to send, typically this will be a photo, video or music file.
- 2 Choose **Send**.
Choose **Bluetooth**.

- 3 If you have already paired the Bluetooth device, your KM555R will not automatically search for other Bluetooth devices. If not, your KM555R will search for other Bluetooth enabled devices within range.
- 4 Choose the device you want to send the file to.
- 5 Your file will be sent.

TIP! Keep an eye on the progress bar to make sure your file is sent.

To receive a file:

- 1 To receive files your Bluetooth must be both **On** and **Visible**. See Changing your Bluetooth settings on the right for more information.
- 2 A message will prompt you to accept the file from the sender. Touch **Yes** to receive the file.

Settings

- 3 You will see where the file has been saved and you can choose to **View** the file or **Use as wallpaper**. Files will usually be saved to the appropriate folder in your My stuff.

Changing your bluebooth settings:

- 1 Touch .
- 2 Choose  then touch  and choose **Settings**.

Make your changes to:

My device visibility - Choose to be **Visible** or **Hidden** or **Visible for 1 min**.

My device name - Enter a name for your KM555R.

Supported services - Choose how to use Bluetooth in association with different services.

Remote SIM Mode - Turn on or off.



My address - Show your Bluetooth address.

Pairing with another Bluetooth device

By pairing your KM555R and another device, you can set up a passcode protected connection. This means your pairing is more secure.

- 1 Check your Bluetooth is **On** and **Visible**. You can change your visibility in the **Settings** menu.
- 2 Touch **Search**.
- 3 Your KM555R will search for devices. When the search is completed **Refresh** will appear on screen.
- 4 Choose the device you want to pair with and enter the passcode, then touch **OK**.
- 5 Your phone will then connect to the other device, on which you should enter the same passcode.
- 6 You passcode protected Bluetooth connection is now ready.



Installing LG PC Suite on your computer

- 1 From the standby screen press  and choose .
- 2 Select **USB connection mode** and choose.
PC internet
Mass storage
PC suite
Music sync
Always ask
- 3 Click on the **LG PC Suite Installer** which will appear on your screen.
- 4 Select the language you would like the installer to run in and click **OK**.
- 5 Follow the instructions on the screen to complete the LG PC Suite Installer wizard.
- 6 Once installation is complete, the LG PC Suite icon will appear on your desktop.

Using your phone as Music Sync device

Your Phone can be used as Music Sync device to Sync Music Files only.

Music Sync can be done using Windows Media Player 10 / 11 and supports both Handset Memory and External Memory Card.

- 1 Disconnect your phone from your PC.
- 2 From the standby screen touch .
- 3 Select  and then **USB connection mode**.
- 4 Touch **Music sync**.
- 5 Connect your phone to your PC. Your phone will read: Connecting as Music Sync ... followed by Disconnect Cable to Stop Music Sync.

Wi-Fi

Wireless Manager allows you to manage Internet connections per Wi-Fi (Wireless LAN) on your device.

It allows the phone to connect to local wireless networks or access the Internet wirelessly. Wi-Fi is faster and has a greater range than Bluetooth wireless technology and can be used for fast emailing and Internet browsing.

NOTE: The KM555R supports WEP, WPA and WPA2 encryption, and not EAP, WPS encryption. If your Wi-Fi service provider or network administrator sets encryption for network security, fill in the key in the pop-up window. If encryption is not set, this popup window will not be shown.

You can obtain the key from your Wi-Fi service provider or network administrator.

Phone Software update

LG Mobile Phone Software Update Program

For more information on installing and using this program, please visit <http://update.lgmobile.com>.

This feature allows you to update your software to the latest version quickly and conveniently.

The mobile phone software update program requires the user's undivided attention for the duration of the update process. Please be sure to check any instructions and notes that appear at each step before proceeding. Also note that removing the USB data communication cable or batteries during the update may seriously damage your mobile phone. The manufacturer takes no responsibility for loss of data during the update process. You are advised to record any important information in advance for safekeeping.

Quick guide for phone software update



Download LG mobile support Tool to PC and execution



* Click 'Start upgrading' (If USB Driver is installed, connect your phone to PC via USB cable.)



* After selecting phone model, Install USB Drive



Connect Phone via USB cable to PC

Preparation and Remarks

- Fully charge the battery.
- Saved user information through PC Sync before upgrading your firmware.
- Close PC Sync/applications before proceeding with the update.
- Calling and messaging functions are not available during the update process.
- Remove the SD card.
- Do not disconnect the USB cable until the update is completed.
- The handset is automatically reset during this process.