

This device is not intended for sale in the USA.

Part 15.21 statement

" Change or Modifications that are not expressly approved by the manufacturer could void the user's authority to operate the equipment. "

Part 15.105 statement

This equipment has been tested and found to comply with the limits for a class B digital device, pursuant to Part 15 of the FCC Rules.

These limits are designed to provide reasonable protection against harmful interference in a residential installation. This equipment generates uses and can radiate radio frequency energy and, if not installed and used in accordance with the instructions, may cause harmful interference to radio communications. However, there is no guarantee that interference will not occur in a particular installation. If this equipment does cause harmful interference or television reception, which can be determined by turning the equipment off and on, the user is encouraged to try to correct the interference by one or more of the following measures:

- Reorient or relocate the receiving antenna.
- Increase the separation between the equipment and receiver.
- Connect the equipment into an outlet on a circuit different from that to which the receiver is connected.
- Consult the dealer or an experienced radio/TV technician for help.

Part 15 Class B Compliance

This device and its accessories comply with part 15 of FCC rules.

Operation is subject to the following two conditions:

- (1) This device & its accessories may not cause harmful interference.
- (2) This device & its accessories must accept any interference received, including interference that may cause undesired operation.

Body-worn Operation

This Mobile Broadband USB Modem, model L-05A, is approved for use in normal size laptop computers only (typically with 12" or larger display screens). To comply with FCC RF exposure requirements, this modem should not be used in configurations that cannot maintain at least 5mm (approximately 0.2 inches) from users and bystanders, and 12mm (approximately 0.47 inches) from the top of the USB modem.

This USB modem has been tested for compliance with FCC/IC RF exposure limits in the laptop computer(s) configurations with horizontal and vertical USB slots and can be used in laptop computers with substantially similar physical dimensions, construction, and electrical and RF characteristics. When using this USB modem in your computer, it must not be co-located or simultaneously transmit with any other radio (for example, Bluetooth or Wifi radios) in the computer. If the USB modem will be used with the mounting folder and extension cable combination, the modem must not be co-located or simultaneously transmit with any active antenna that may be located on your computer screen. □□

DOCOMO W-CDMA • GSM/GPRS System

Thank You for Purchasing the [Data Communication Device L-05A]

Before or while using the L-05A, be sure to thoroughly read this manual and the individual manual for other operation devices to ensure its correct use. For further information, contact the "docomo Information Center" on the back of this manual. The L-05A is designed to be your close partner. Treat it carefully at all times to ensure longterm performance.

Before Using the FOMA Terminal

- Because the FOMA terminal uses radio waves, it may not function in locations where it is difficult for radio waves to penetrate, such as tunnels, underground passages and some buildings in areas where radio wave signals are weak or out of the service area. Even when you are on a higher floor of a tall building or condominium and nothing blocks your view outside, the FOMA terminal may not be able to receive or transmit signals. Also communication may be interrupted even when the Antenna Indication Lamp on the FOMA terminal lights green indicating a strong signal reception with 3 antenna indication bar.
- Use the FOMA terminal in ways that do not disturb others in public places, crowded locations, or quiet locations.
- The FOMA terminal communicates via radio waves by converting voices into digital signals. If you move into an area where signal reception is poor, the digital signals may not be accurately decoded and what you hear may differ slightly from what was actually said.

- DOCOMO is not responsible for any economic losses incurred through lost communication opportunities caused by external factors such as malfunction or failure of the FOMA terminal, or electrical outage.
- The FOMA terminal can be operated in FOMA Plus-Areas and FOMA HIGH-SPEED Areas.
- The FOMA terminal can be used only via the FOMA network provided by DOCOMO and DOCOMO's roaming area.
- This FOMA terminal does not support i-mode functions (i-mode mail, connection to official i-mode sites or i-appli, etc.)

For Those Who Use the FOMA Terminal for the First Time

If this is the first time for you to use the FOMA terminal, it is recommended that you read this manual in the following order to learn basic operations.

1. Learning the precautions. P7
2. Learning the names of parts and functions of the FOMA terminal. P18
3. Inserting the FOMA terminal into a PC. P24
4. Having the FOMA terminal recognized by your PC. . . P24
5. Setting up the FOMA terminal for communication. . . P66

The latest version of this manual can be downloaded from the DOCOMO web site.

■ The URL of PDF for Instruction Manual
<http://www.nttdocomo.co.jp/english/support/manual/index.html>

※ The URL and the information contained in the manual are subject to change without prior notice.

How to Read/Refer to This Manual

Contents

L-05A Manual is composed of 『L-05A Instruction Manual~Connection Guide~』 and 『L-05A INSTRUCTION MANUAL (included CD-ROM)』 (this manual) recorded in CD-ROM.

■ 『L-05A Instruction Manual~Connection Guide~』

The following contents such as connection to computer, troubleshooting methods, specifications of L-05A are written.

- Contents/Precautions
- Before Using the FOMA Terminal
- Setting up
- Appendix/Troubleshooting

■ 『L-05A INSTRUCTION MANUAL (included CD-ROM)』 (this manual)

Besides the above contents described in 『L-05A Instruction Manual~Connection Guide~』, the contents of configuring communication through special application are also written.

This manual is supplied with PDF. To view this manual, Adobe Reader (Version 6.0 or later is recommended) is necessary.

- L-05A Connection Software
- DOCOMO Connection Manager
- Configuring Network Manually
- Overseas Use

How to Refer to This Manual

This manual offers you the following methods to easily find a page describing functions or services you want to know about.

From the Index

→ P141

Search from the index when you know the names of functions or services.

From the Tabs on the Cover

→ Front cover

Search functions or services from the index tabs printed on the front cover.

From the Contents

→ P5

Search from the contents that categorize functions.

From the Main Features

→ P6

Search from the features when you want to use specific functions.



See next page for detailed descriptions

- Please understand that [L-05A Manual] refers to the [L-05A] as the [FOMA Terminal] .
- This manual describes, some steps and screens may differ depending on your operating environment.
- Reprinting all or parts of this manual is prohibited.
- Information contained in this manual is subject to change without prior notice.

A way to find a destination page is explained with an example of installing L-05A connection software on Windows (including a driver).

From the Index

► P141

Search for a function name or a service name as shown below.

From the Index Tabs on the Front Cover

► Front cover

Search for the function in the order of "Front cover" → "Chapter title page" → "Target page" as shown below.

Modifying PIN1 code.....	64
Unlocking a locked PIN1	63
Form factor	130

Install	
DCCOMO Connection Manager on Macintosh	77
DCCOMO Connection Manager on Windows.....	73
L-02A Connection Software on Macintosh (including a driver) ..	36
L-02A Connection Software on Windows (including a driver).....	31
International Roaming Service	108
Internet Option	61

Contents/Precautions	
Before Using the FOMA Terminal	
Setting Up	
L-02A Connection Software	
DCCOMO Connection Manager	
Configuring Network Manually	

Setting up

Setting up	28
Installing L-02A Connection Software on Windows (including a driver)	31
Installing L-02A Connection Software on Macintosh (including a driver)	36
Uninstalling L-02A Connection Software (including a driver)	39

P35
The page describing installation of L-05A connection software on Windows (including a driver)"

Displays a section title.

Useful Information or suggestions relating to an operation.

Installing L-02A Connection Software on Windows (including a driver)

The L-02A connection software only need to be installed when you connect the FOMA terminal to your PC for the first time.

Note

- Do not remove the FOMA terminal wire installing.
- Installation may take several minutes depending on the PC you use.
- Do not install or uninstall during data communication.
- When installing, make sure to install from the account with PC supervisor privileges. An error will occur during installation if you install from the account without these privileges.
- For details on setting up PC supervisor privileges, contact your computer manufacturer or Microsoft Corporation.

Installing

For Windows Vista

1 Connect the FOMA terminal with a PC

The setup screen of L-02A connection software is automatically displayed by zero installation.

"ソフトウェア"画面 will be displayed depending on setting. If the screen is displayed, check "ソフトウェアをインストールする" and select "Launcher.exe" file.

※ When the Setting up screen of L-02A connection software is not automatically displayed, install off the included CD-ROM (PC-2).

Setting up 31

Explains Operation steps

A key screen for an operation step. This is an image of a screen seen on the PC. Numbers, settings or characters entered are for reference only.

Index: Searching each chapter is available.

- ※ : The above page is an example.
- ※ : Screen images and illustrations contained in this manual are for reference only. They may differ from those seen for the actual product.

Contents

How to Read/Refer to This Manual	1
Contents	5
Features of the L-05A	6
Safety Precautions (ALWAYS FOLLOW THESE PRECAUTIONS)	7
Handling and Care	12
Purchased Product and Accessories	15

Before Using the FOMA Terminal 17	Names of Parts and Functions Using FOMA Card Available Communications Connecting FOMA Terminal with a PC
Setting Up 31	Setting Up Windows version Macintosh version
L-05A Connection Software 49	L-05A Connection Software Using Packet Communication Using SMS Using Phonebook Using Application Option
DOCOMO Connection Manager 77	DOCOMO Connection Manager Windows version Macintosh version

Configuring Network Manually 89	Configuring Dial-up Network Manually Conducting Communication (Connecting Dial-up)
Overseas Use 111	International Roaming Service (WORLD WING) Services Available Overseas Confirming before Using Overseas Setting the Searching Method for Available Networks Configuring Network
Appendix/ Troubleshooting 119	AT Commands AT Command List Troubleshooting Error Messages Warranty and After-Sales Service Software update Main Specifications Export Controls of the Product and Accessories Intellectual Property Rights Index

Features of the L-05A

FOMA (Freedom Of Mobile multimedia Access) is the name of a service provided by DOCOMO based on the W-CDMA system, which is certified as one of the global standards of 3rd generation mobile communication systems (IMT-2000).

■ Correspondence with the FOMA HIGH-SPEED Area

You can enjoy high speed communication (Best effort system) at a maximum of 7.2Mbps for receiving and 5.7Mbps for sending.

- The maximum speed of 7.2Mbps for receiving and 5.7Mbps for sending are theoretical values and they do not show the actual performance.
- Out of High-Speed area, the maximum communication speed for receiving and sending is 384kbps.
- The actual communication speed varies depending on surrounding communication conditions and network condition.
- DOCOMO offers Internet connection services, such as [mopera U] . For details, visit the mopera U web site <http://www.mopera.net/> (Japanese only)
- ※ The packet communication in FOMA HIGHSPEED area, the amount of send/receive data is expected to increase. Note that the communication fees may become high.

■ International Roaming Service

Communications are available from a PC even in foreign countries that have adapted the W-CDMA (3G) network system or GPRS network.▶P112

- ※ If you subscribed to the FOMA service after September 1, 2005, a separate subscription is not required. However, if you unsubscribed to the FOMA service subscription or canceled the service, a separate subscription is required.
- ※ If you initially subscribed to the FOMA service before August 31, 2005, and have not subscribed to "WORLD WING", a separate subscription is required.
- ※ This service is not available with some billing plans.

■ FOMA Card Interchangeability



The same FOMA card can be used in more than one FOMA terminal.▶P19

■ SMS Feature





Allows you to send and receive SMS by using L-05A Connection Software ▶P54

Safety Precautions (ALWAYS FOLLOW THESE PRECAUTIONS)

- Before using your FOMA terminal, read these " Safety Precautions" carefully so that you can use it properly. After reading the safety precautions, keep this manual in a safe place for later reference.
- These precautions are intended to protect you and others around you. Read and follow them carefully to avoid injury, damage to the product or damage to property.
- The signs below indicate the levels of danger or damage that may occur if the particular precautions are not observed .

 DANGER	This sign indicates that incorrect handling has a high possibility of causing death or serious injury.
 WARNING	This sign indicates that incorrect handling poses a risk of causing death or serious injury.
 CAUTION	This sign indicates that incorrect handling poses a risk of causing injury or damage to the product or property.

- The following symbols indicate special warnings regarding product usage.

 Don't	Denotes things not to do (prohibition).
 No disassembly	Denotes not to disassemble.
 Not liquids	Denotes not to use where it could get wet.
 Do	Denotes mandatory instructions (matters that must be complied with).

- "Safety Precautions" are explained in the following 4 sections.

General Precautions for the FOMA Terminal and FOMA Card	8
Precautions for the FOMA Terminal	9
Precautions for the FOMA Card	10
Notes on Using near Electronic Medical Equipment	11

General Precautions for the FOMA Terminal and FOMA Card



Don't

Do not use or leave the FOMA terminal and FOMA card in places with a high temperature such as in cars under the blazing sun.

Deformation, malfunction heating or the deterioration of performance may result. Also, part of the case could get heated, causing bare skin burns.



Not disassembly

Do not disassemble. Do not disassemble, remodel or solder the terminal and FOMA card.

Fire, injury, electric shock or malfunction may result.



Not liquids

Do not let FOMA terminal and FOMA card get wet.

Contact with water or other liquids may cause heating, electric shock, fire, malfunction or injury. Take care not to use the terminal and FOMA card in areas where they could get wet.



WARNING



Don't

Do not put the FOMA terminal or FOMA card in microwave ovens or other heating. The FOMA terminal may over heat, smoke or catch fire, or its circuit parts may burst.



Don't

Do not throw the FOMA terminal or FOMA card, or subject them to severe shocks. Malfunction or fire may result.



Don't

Be careful not to let electro conductive materials (metal pieces, pencil leads etc.) contact with the connector terminal. Also, make sure that these are not entered into the inside of the FOMA terminal. Fire or other malfunctions may result from a short circuit.



Do

Make sure you have the power of the computer which is connected with FOMA terminal switched off before you go near a flammable gas such as gasoline fumes. Using the terminal in such an environment may result in a fire.



CAUTION



Don't

Do not place the FOMA terminal or FOMA card on unstable locations such as wobbly tables or slanted locations.

The FOMA terminal or FOMA card may fall, resulting in injury or malfunction.



Don't

Do not store the FOMA terminal or FOMA card in humid or dusty places, or in hot areas.

Malfunction may result.



Do

If children use the FOMA terminal or FOMA card, a guardian should explain the precautions and correct operations. The guardian should also make sure that the instructions are followed during use.

Injury may result.



Keep out of reach of babies and infants. Accidental swallowing or injury may result.

Precautions for the FOMA Terminal



WARNING



Don't

Do not put the FOMA terminal in the place where it could be affected by an expanded airbag, e.g. on the dashboard.

If the airbag expands, the FOMA terminal could hit you and others, causing accidents such as injury and the FOMA terminal could get malfunction or damaged.



Don't

Do not place the terminal in breast or inner pocket when electronic medical equipment is near by.

Using FOMA terminal closed to electronic medical equipment may result malfunction.



Don't

Do not allow liquids such as water, or foreign materials such as metal pieces or flammable materials to get into the FOMA card opening in the FOMA terminal.

Fire, electronic shock or malfunction may result.



Turn off the FOMA terminal in places where use is prohibited such as airplanes or hospitals.

Electronic and electronic medical appliances may be adversely affected. For use inside medical facilities, make sure that you comply with their regulations.



Remove FOMA terminal from the USB port in places near high-precision electronic devices or devices using weak electronic signals.

The FOMA terminal may possibly cause these devices to malfunction.

※ Electronic devices that may be affected
Hearing aids, implanted cardiac pacemakers, implanted defibrillators, other medical electronic devices, fire alarms, automatic doors and other automatically controlled devices.

If you are using an implanted cardiac pace maker, implanted defibrillator or any other electronic medical device, consult the manufacturer or retailer of the device for advice regarding possible effects from radio waves.



CAUTION



Electronic devices in some types of cars can be affected by use of the FOMA terminal.

For safety's sake, do not use the FOMA terminal inside such cars.



Itching, rash or eczema may be caused depending on your physical conditions or predisposition.

If an abnormality occurs, stop using the FOMA terminal immediately, and then seek medical attention.

Metal(chrome plating) is used to the following parts.

Parts that are used: USB connector

Precautions for the FOMA Card



CAUTION



Be careful when removing the FOMA card(IC portion).

Your hands or fingers may be injured.

Notes on Using near Electronic Medical Equipment

- The description below meets “ Guideline on the Use of Radio-communication Equipment such as Cellular Telephones - Safeguards for Electronic Medical Equipment” by the Electromagnetic Compatibility Conference.



WARNING



Do

Be sure to adhere to the following regulations inside medical facilities.

- Keep the FOMA terminal out of operating rooms, intensive care units (ICUs) or coronary care units (CCUs).
- Turn off the PC in hospital wards.
- Turn off the PC in hospital lobbies and corridors if electrical medical devices could be nearby.
- If the medical facility has specific zones where use or possession of mobile terminals is prohibited, follow those regulations.
- If the function which automatically turns on the power is set, cancel the setting before turning off your PC.



Do

Turn off the PC in crowded trains or other public places where implanted cardiac pacemaker or defibrillator wearers could be nearby.

Signals from the FOMA terminal may affect the operation of implanted cardiac pacemakers or defibrillators.



Do

If you use an implanted cardiac pacemaker or implanted defibrillator, use the mobile terminal 22cm or more away from the implanted cardiac pacemaker or implanted defibrillator.

Operation of an implanted cardiac pacemaker or implanted defibrillator may be affected by radio waves.



Do

Patients using electronic medical equipment other than implanted cardiac pacemakers or implanted defibrillators (using outside medical facilities for treatment at home, etc.) should check the influence of radio waves upon the equipment by consulting the manufacturer.

Operation of electronic medical equipment may be affected by radio waves.

Handling and Care

General Usage Guidelines

■ **Keep the FOMA terminal away from water.**

The FOMA terminal and FOMA card are not waterproof. Do not use the terminal in places with high humidity such as a bath or where rain may get it wet. If you carry the card close to your body, moisture from sweat may corrode the internal parts causing a malfunction. Note that malfunctions deemed to be caused by water are not covered by the warranty, and may be impossible to repair. Since these malfunctions are not under warranty, even when repair is possible, it will be done at the user's expense.

■ **Clean the FOMA terminal with a dry, soft cloth (Lens cleaning cloth).**

If the FOMA terminal is wiped with alcohol, paint thinner, benzine or detergent, the printing may disappear or color may fade.

■ **Keep the connector contacts clean with a dry, soft cloth.**

Dirty contacts can result in intermittent connections.

■ **Do not place the equipment near air conditioner outlets.**

Condensation may form due to rapid changes in temperature, and this may corrode internal parts and cause malfunction.

■ **Do not place the FOMA terminal where excessive force will be applied to it.**

If FOMA terminal is inserted to a full bag, or placed in a pocket and sat on, its internal PCBs may be damaged or malfunction. Such damage is not covered by warranty.

■ **Read the individual manual attached to the FOMA terminal.**

FOMA Terminal

■ **Avoid using in extremely high or low temperatures.**

The FOMA terminal should be used within a temperature range from 5 °C to 35 °C and a humidity range from 45 % to 85 %.

■ **FOMA terminal may affect fixed phones, televisions or radios in use nearby. Use as far as possible from such appliances.**

■ **Keep a separate record of any information stored on the FOMA terminal and store the copies in a safe location.**

DOCOMO assumes no responsibility for the loss of any of your data.

- **Remove the FOMA terminal from the PC when transporting.**
Malfunction or damage may result.
- **It is normal for the FOMA terminal to become warm during use. You can continue to use it even when it is warm.**
- **Take care not to drop the FOMA terminal when removing the FOMA terminal from the carrying case.**
- **When it is not in use, keep the FOMA terminal in its carrying case to keep the connector contacts clean.**
Dirty contacts may result in intermittent connections.
- **When putting the FOMA terminal in carrying case, keep it away from wet or high temperature place. Pay attention not to put excessive force on the FOMA terminal.**
Transformation, tarnish, color staining may result.

FOMA Card

- **Do not put excessive force on the FOMA card when inserting or removing it into the FOMA terminal.**
- **It is normal for the FOMA card to become warm during use. You can continue to use it even when it is warm.**
- **Always keep the IC portion of the FOMA card clean.**
- **Clean the FOMA card with a soft, dry cloth (Lens cleaning cloth).**
- **Be sure to keep a separate note of the information registered to the FOMA terminal.**
DOCOMO is not responsible for any losses of registered information.
- **Visit DOCOMO shop to return the FOMA card for the environmental purpose.**
- **Avoid extreme temperature.**
- **Do not scratch, touch carelessly or short circuit the IC portion.**
Data loss or malfunction may result.
- **Do not drop or give shock to the FOMA card .**
Malfunction may result.
- **Do not bend or put heavy things on the FOMA card.**
Malfunction may result.
- **Do not insert UIM into the FOMA terminal with labels or stickers attached on.**

CAUTION

- **Do not use the modified FOMA terminal. Using modified FOMA terminal result in violating the law of Electromagnetic Compatibility.**

FOMA terminal has been complied with technical standard of wireless equipment stipulated by law of Electromagnetic Compatibility. As for the proof, the technical standard compliance mark, is indicated in the inscription seal. If FOMA terminal is modified by turning the screw to the left to disassemble, technical standard compliance becomes invalid.

Please do not use FOMA terminal during the time when technical standard compliance is being invalid, since you are in violation of the law of Electromagnetic Compatibility.

Purchased Product and Accessories

■ L-05A Terminal (With Rear Cover L13, Warranty)

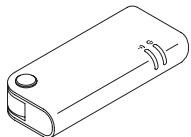

■ L-05A Instruction Manual~Connection Guide~

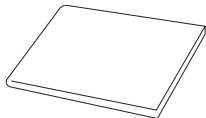

■ Carrying Case (Sample)

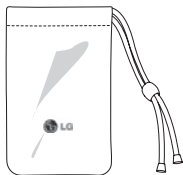

■ L-05A CD-ROM

- L-05A Connection Software (For Windows/Macintosh)
- DOCOMO Connection Manager (For Windows/Macintosh)
- L-05A INSTRUCTION MANUAL (PDF)



※ Software specifications are subject to change without prior notice.

■ USB Extension Cable (Sample)

Use when "USB Extension Cable" is written in this manual.

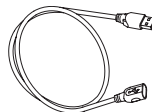

■ Mounting folder (Sample)

Use when "A mounting Folder" is written in this manual.



Before Using the FOMA Terminal

Names of Parts and Functions	18
Using a FOMA Card	19
Available Communications	23
Connecting FOMA Terminal to a PC	24

Names of Parts and Functions

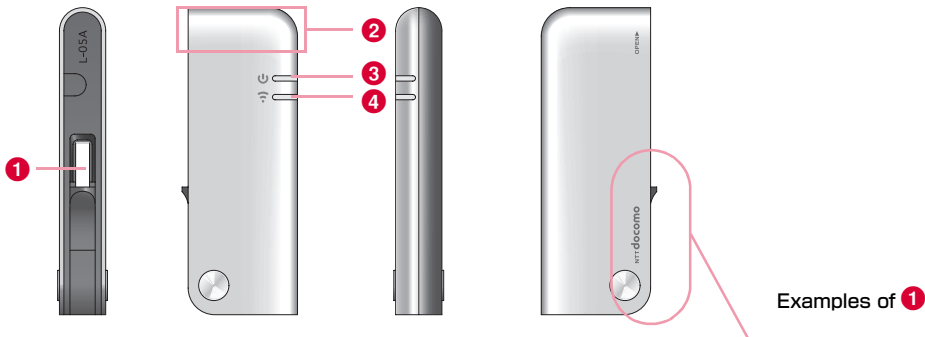

1 USB Connector→P25

Connection contacts to a PC.

※ Pull out from the FOMA terminal and use.

The tip part of the USB connector is able to turn 90 degree.
However, only one direction is available to turn.

2 Antenna Part

The antenna is inside the FOMA terminal.

3 PWR Lamp→P19

Indicates the power supply conditions.

4 IDLE/BUSY Lamp→P19

Indicates the FOMA terminal status.

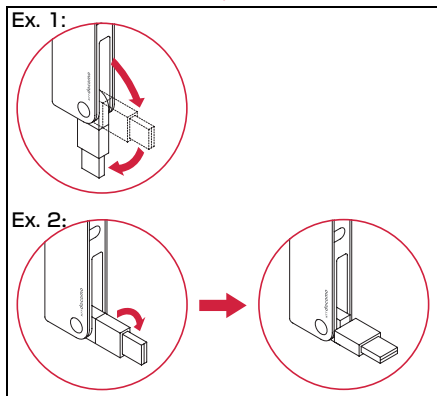

Mode Indication Lamp

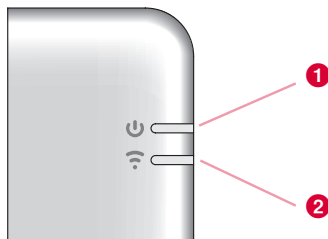

※ Operation indicating lamp

FOMA Terminal Status		① Power Indication Lamp	② Mode Indication Lamp
When powered on		-	-
Waiting to connect to the FOMA network		Green	Green
Packet communication	Attempting to communicate	Green	Blue (Flash)
	Communicating	Green	Blue
SMS	While receiving	Green (Flash)	Green
	Opening SMS	Green	Green
	Sending SMS	Green	Green
PIN	PIN Lock	Green	-
	Waiting to unlock PIN1	Green	-

Using a FOMA Card

The FOMA card is an IC card that stores personal information such as your phone number. Without a FOMA card installed in the FOMA terminal, you cannot use data communication. For detailed information, refer to FOMA Card Manual.

Inserting/Removing

Inserting

Inserting the UIM with two hands.

- 1 While pushing the cover in the direction of ①, slide the rear cover in the direction of ②. Lift the cover as shown by ③.

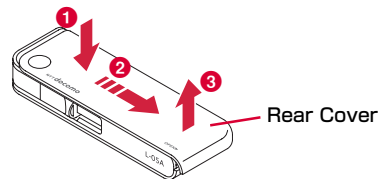

- 2** Insert the UIM into slot at the direction of arrow with the IC chip side down

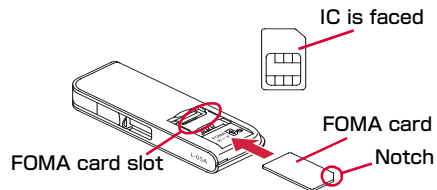

- 3** Fit the rear cover to the ditch of FOMA terminal at approximately 3mm from the top tip of the FOMA terminal. While pressing along direction **2**, slide the rear cover along direction **1** till hear rear cover clicked.

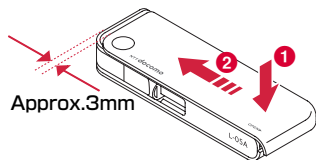

Removing

Remove the UIM with two hands.

- 1** While pushing the cover in the direction of **1**, slide the rear cover in the direction of **2**. Lift the cover as shown by **3**.

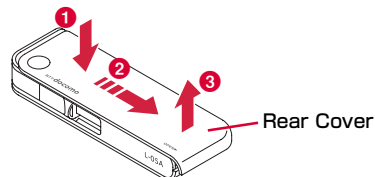

- 2** Slide the UIM in the direction of arrow and remove it from the FOMA Card slot.

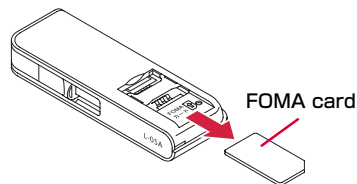

- 3** Fit the rear cover to the ditch of FOMA terminal at approximately 3mm from the top tip of the FOMA terminal. While pressing along direction **2**, slide the rear cover along direction **1** till hear rear cover clicked.

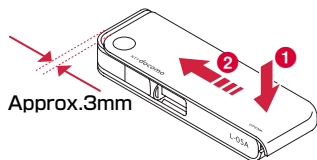

Note

- Make sure not lose the removed FOMA card.
- Make sure to check the direction of FOMA card.

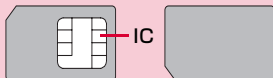

- Be careful not to scratch FOMA card's IC parts.
- Inserting FOMA card in the reverse direction may cause malfunction.
- Inserting and removing FOMA card with an excessive force may cause damage to your FOMA card.
- Do not remove FOMA card while FOMA terminal is inserted to a PC, it may causes damage to your FOMA card.

PIN1 Code

You can set PIN codes (Personal Identification Number) for FOMA Card. The default setting for the PIN1 code is "0000". The PIN1 code is a 4 to 8-digit security code to be entered every time the FOMA terminal is turned on for user verification to prevent any unauthorized use by others.

If your FOMA card is set to require a PIN1 code, data communication cannot be performed until the PIN1 is entered. Start the L-05A High Speed Utility and verify the PIN1 code, or set (P69)not to verify the PIN1 code in advance.

■ Changing the PIN1 Code

You can change the PIN1 code to any number. To prevent any unauthorized use by third parties, change it to your own number. If you improperly enter the PIN1 code 3 times in a row, further entry is locked automatically (PIN lock), so be sure to keep a separate note of the numbers you set.

- Entering PIN1 Code/ Changing PIN1 code→P70

■ PIN Unblocking Code

The PIN Unblocking Code is the number used to unblock the PIN1 code. You are notified of your PIN Unblocking Code when you purchase your FOMA terminal. Entering the Unblocking Code (8-digit) unblocks the PIN lock. If you improperly enter the Unblocking Code 10 times in a row, the FOMA card locks automatically, so be sure to keep a separate note of the number.

Start up L-05A Connection Software
The PIN1 code Verification screen appears



Enter PIN1 Code
Incorrect entry 3 times in a row



Enter Unblocking PIN Code
OK Incorrect entry 10 times in a row



You can set a new
PIN1 code



Contact a DOCOMO shop

FOMA Card Types

Please be aware that the FOMA card (Blue) has different functions from the FOMA card (Green/White) as follows:

Function	FOMA card (Blue)	FOMA card (Green/White)
The number of digits of a phone number that can be saved to the FOMA card Phonebook	Up to 20 digits	Up to 26 digits This terminal allows up to 20 digits.
WORLD WING	Not available	Available

WORLD WING

WORLD WING is DOCOMO's FOMA international roaming service that provides telephone and other types of mobile communications. It allows the subscriber to use the same phone number overseas as in Japan by inserting a FOMA card (green/white) into a FOMA terminal or a mobile phone designed for overseas use.

- If you subscribed to the FOMA service after September 1, 2005, a separate subscription is not required. However, if you unsubscribed to the FOMA service subscription or canceled the service, a separate subscription is required.
- If you initially subscribed to the FOMA service before August 31, 2005 and have not subscribed to "WORLD WING", a separate subscription is required.
- This service is not available with some billing plans.
- Your FOMA card (green/white) is lost or stolen overseas, contact DOCOMO immediately and temporarily suspend your subscription. For contact information, see "docomo Information Center" on the back of this manual. Call and communication charges after the terminal was lost or stolen are still charged to you.

Available Communications

Packet Communication

Fees for this communication method are based on the amount of exchanged data. You can perform data communication at a maximum of 7.2Mbps for receiving and 5.7Mbps for transmitting by using a connection that allows FOMA communication such as [mopera U] , one of DOCOMO's Internet connection services.

- ※ The maximum speed of 7.2Mbps for receiving and 5.7Mbps for sending is theoretical values and does not show the actual ones. The actual communication speed depends on communication environment and network congestion.
- You can perform communication using international roaming under [mopera U]
- Out of High-Speed area, the maximum communication speed for receiving and sending is 384kbps.
- The communication speed varies depending on the access point and radio wave status.
- The communication speed varies depending on the access point under international roaming.
- Use the [DOCOMO Connection Manager] in the CD-ROM to check the approximate number of transmission bytes and charges under the communication.

Note

- Communication fees become high when performing communications with large amount of data such as browsing websites with many graphics or downloading data.
- Data communication fees under international roaming differ from those in Japan.
- FOMA terminal does not support 64K data communication.
- This FOMA terminal does not support Remote Wakeup.
- This FOMA terminal does not support FAX communication.

Usage Notes

■ Internet service provider fees

Fees to an Internet service provider may be required to connect to the Internet. These fees are added to the FOMA service fees and are paid to your Internet service provider directly. For details on connection fees, contact your Internet service provider.

You can subscribe to such as [mopera U], one of DOCOMO's Internet connection services. Charge for subscribing [mopera U] is required.

For service and connection/settings of [mopera], visit the [mopera] web site.

<http://www.mopera.net/mopera/index.html> (Japanese only)

■ User authentication to access networks

Depending on the access point, user authentication (ID and password) may be required to connect. If required, enter the ID and password from the dial-up network. The ID and password will be provided by the network administrator of your Internet service provider or the access point. For details, contact your provider or access point network administrator.

■ Requirements for packet communication

The following conditions must be met to perform communications using the FOMA terminal. However, a connection may not be established if traffic is heavy at the base station or if radio signals are weak.

- The FOMA terminal must be in a FOMA network or DOCOMO's roaming service area.
- The access point corresponds to the FOMA packet communication.

Connecting FOMA Terminal to a PC

When connecting FOMA terminal with computer for the first time, it is required to install L-05A connection software (including a driver).

For installing L-05A connection software, refer to the followings.

- For Windows: "Preparation for using L-05A" (P35)
- For Macintosh: "Preparation for using L-05A" (P42)

Inserting

1 Turn on a PC

2 Connecting the FOMA terminal with a PC

- When using a mounting folder and a USB extension cable
 - Use a mounting folder and a USB extension cable to fix on the top of a PC

- 1 Pull out the projection part of USB connector 180 degree by fingertip

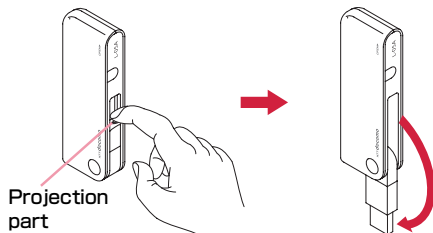

- 2 Hold the connector part of USB extension cable and insert into the USB connector near the FOMA terminal along arrow direction

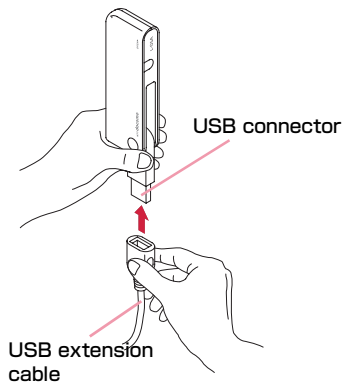

- 3 Put the FOMA terminal between the mounting folder and fix on the top of the PC

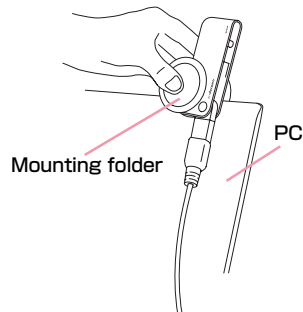

- 4 Hold the connector part of USB cable and insert into PC USB port along arrow direction

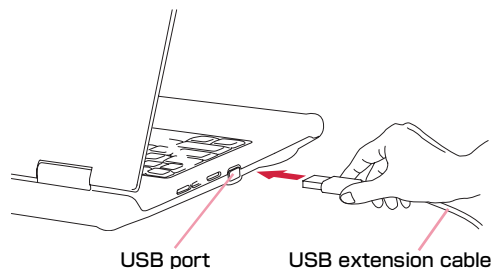

■ **When connecting with a PC directly**

- Insert the FOMA terminal into a PC USB port and use it directly.
- The USB connector of FOMA terminal is able to turn 90 degree complying to directions of USB port

❶ **Pull out the projection part of USB connector 90 degree by fingertip**

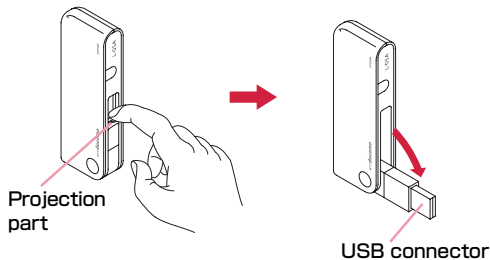

❷ **The FOMA terminal body turn the tip part of USB connector 90 degree as shown in the illustration**

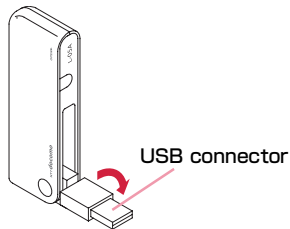

❸ **Insert the USB connector of FOMA terminal into a PC USB port**

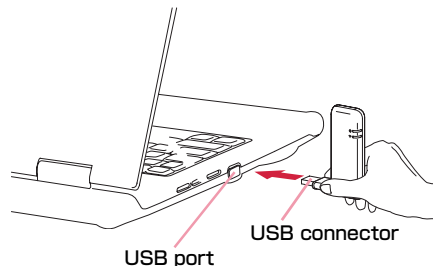

- It is available to use without turning USB connector 90 degree as the above-mentioned procedure ❷.

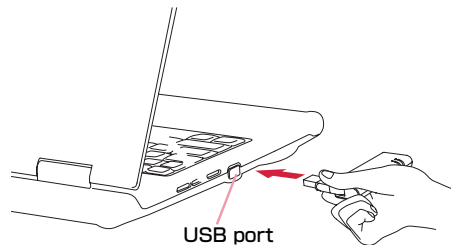

Note

- Refrain from turning the FOMA terminal after inserting USB connector into PC USB port. Malfunction or damage may result when subject the FOMA terminal to severe shocks due to carelessness.

3 Start communication connecting

Note



Power Indication lamp
Mode Indication Lamp

- Confirm whether power indication lamp changes to red and mode indication lamp changes to green.
- Using "L-05A connection software"→P49
- Using "DOCOMO connection manager"→P77
- Configuring manually (OS Standard)→P89

Removing

1 End data communication

- If the L-05A connection software/DOCOMO connection manager is already running, exit the L-05A connection software/DOCOMO connection manager. Verify that data connection is disconnected.

2 Remove the FOMA terminal

- When using a mounting folder and a USB extension cable

- 1 Hold the connector part of a USB extension cable and pull out the FOMA terminal from PC USB port along arrow direction

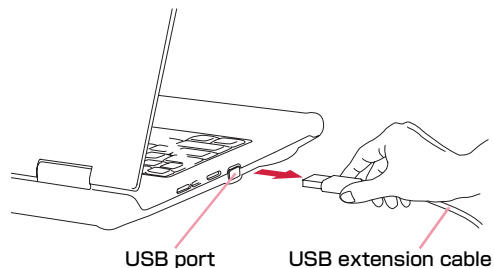

- 2 Remove the FOMA terminal along with the mounting folder from the top of the PC. Remove the mounting folder from the FOMA terminal

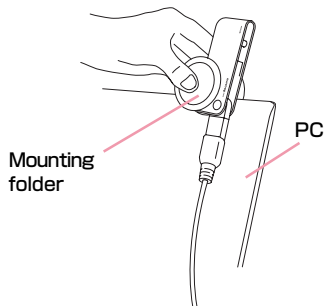

- 3 Hold the connector part of the USB extension cable and pull out from the USB connector near the FOMA terminal along arrow direction

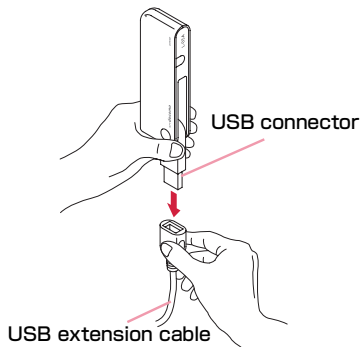

- 4 Pack the USB connector into the FOMA terminal

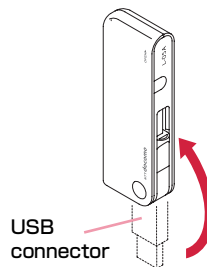

■ When connecting to a PC directly

- 1 Hold the USB connector part of FOMA terminal. Pull out the FOMA terminal straightly from PC USB port

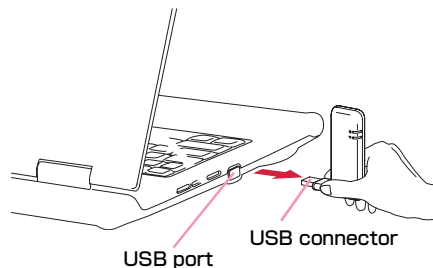

- 2 Turn the tip part of the USB connector 90 degree as shown in the illustration

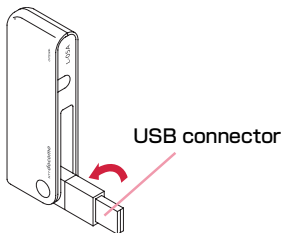

- 3 Pack the USB connector into FOMA terminal

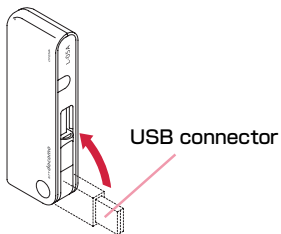

Caution

- If you force to remove FOMA terminal and pull out the USB extension cable, this may result malfunction.
- Removing FOMA terminal from USB connector during data communication may suspend data communication and result malfunction or data losses.

Setting up

Setting up	32
Windows Version	35
Macintosh Version	42

Setting up

■ Data communication with L-05A

"Communication configuration file (Driver)" and "L-05A connection software" are required to install for a PC to recognize the FOMA terminal. "Communication configuration file (Driver)" will be installed along with "L-05A connection software".

Although data communication is available with only L-05A connection software, if necessary using it after installing DOCOMO connection manager in addition is also available.

Data communication is also available based on configuring manually after installing L-05A connection software.

■ Installation of L-05A connection software

Since L-05A has zero installation, when connecting the FOMA terminal to a PC for the first time, "L-05A connection software" installation screen appears automatically. "Zero installation" is supported by the PC with Windows OS in it. If zero installation works improperly, install L-05A connection software with the included CD-ROM.

In addition, although Macintosh does not support the zero installation feature, installation continues through the CD-ROM icon appears when connecting the FOMA terminal to a PC.

The procedure of setting up is described on the next page.

Work Flow of Setting up

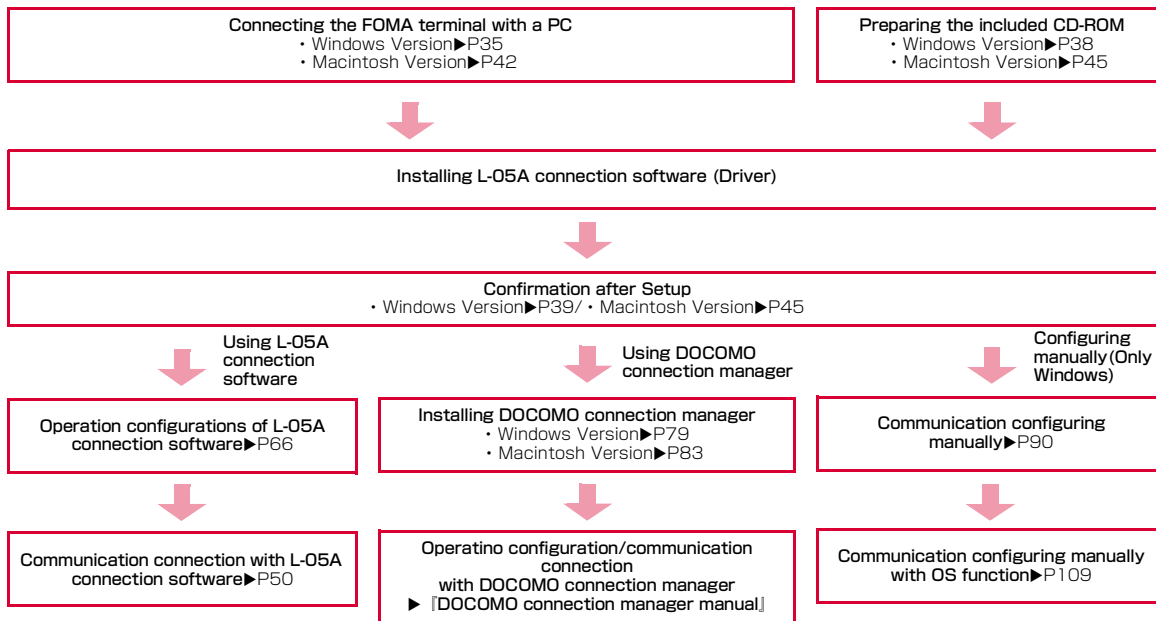

Operating Environments

Using this FOMA terminal under the following operational environments.

Item	Requirement
PC Main Unit	<ul style="list-style-type: none">• Available CD-ROM drive to use from PC-AT compatible.• USB port (Comply with Universal Serial Bus Specification Rev1.1/2.0)• DOCOMO is not responsible for any incompatibility of the operation performed through the USB Hub (including USB port available from the monitor, keyboard, etc.)• Display resolution of 800×600 pixels, High Color (65.536) or higher is recommended.
OS*1	Windows 2000 SP4 or later (Japanese versions) Windows XP SP2 or later (Japanese versions) Windows Vista SP1 or later (Japanese versions) Mac OS X 10.4.11 (Japanese versions)*3 Mac OS X 10.5.6 (Japanese versions)*3
Required Memory*2	Windows 2000 : 64Mbytes or more Windows XP : 128Mbytes or more Windows Vista : 512Mbytes or more Mac OS X 10.4.11 : 512Mbytes or more Mac OS X 10.5.6 : 512Mbytes or more
Hard Disk Space*2	50Mbytes or more available space

- ※1 DOCOMO does not guarantee the operation under the supported OS of the OS is changed through update.
- ※2 Required memory or available hard disk space may vary depending on the system environment of a PC.
- ※3 Only Mac with CPU made by Intel Corporation is available.

For latest information of operation environment, visit DOCOMO's "international web site"

Note

- The software may not work depending on the operating system environment. DOCOMO does not guarantee any operation other than the environment operation described on the left side.

Windows Version

The L-05A connection software only need to be installed when you connect the FOMA terminal to your PC for the first time.

Note

- Do not remove the FOMA terminal while installing.
- Installation may take several minutes depending on the PC you use.
- Do not install or uninstall during data communication.
- When installing, make sure to install from the account with PC supervisor privileges. An error will occur during installation if you install from the account without these privileges.
- For details on setting up PC supervisor privileges, contact your computer manufacturer or Microsoft Corporation.

Preparation for Using L-05A

Setting Zero Installation (Auto)

■ For Windows Vista

1 Connect the FOMA terminal with a PC

The setup screen of L-05A connection software is automatically displayed by zero installation.

"自動再生" screen will be displayed depending on setting. If the screen is displayed, check "ソフトウェアとゲームに対しては常に次の動作を行う" and select "Launcher.exeの実行"



- ※ When the Setting up screen of L-05A connection software is not automatically displayed, install with the included CD-ROM (P38)

2 Click "許可 (Allow)" on "ユーザーアカウント制御 (User account control)" screen

■ For Windows XP/2000

- Because "ユーザーアカウント制御 (User account control)" screen is not displayed, follow the next step

3 Click "次へ (Next)"



4 Click "同意する (I Agree)"

Installation starts.

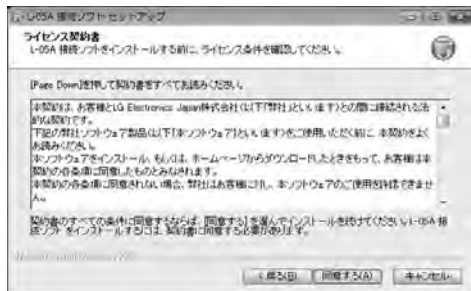

5 Click "次へ (Next)"



6 Click [OK]



7 Click "完了(Finish)"



Installation of L-05A communication configuration file (Driver) continues.

8 Confirm whether the FOMA terminal is recognized by PC

On the lower right side of task tray, "デバイスドライバソフトウェアをインストールしています (Device driver software is being installed)" message is displayed, and the FOMA terminal is recognized automatically.



If the FOMA terminal is recognized properly, "デバイスを使用する準備ができました (The device is ready for use)" message is displayed.

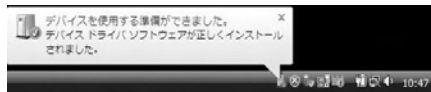

■ For Windows XP

- On the lower right side of task tray, "新しいハードウェアが見つかりました。(A new hardware has been found.)" message is displayed, and the FOMA terminal is recognized automatically.

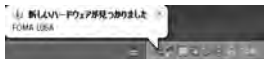

- If the FOMA terminal is recognized properly, "新しいハードウェアがインストールされ、使用準備ができました。(A new hardware has been installed and ready for use.)" message is displayed.

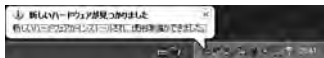

■ For Windows 2000

- The warning screen of removing device is displayed which has nothing to do with using continually.
- "新しいハードウェアが見つかりました(A new hardware has been found.)" message is displayed, and the FOMA terminal is recognized automatically.



Setting Manually (CD)

■ For Windows Vista

- 1 After starting a PC▶Insert the included CD-ROM into the PC
- 2 "スタート(Start)"▶"すべてのプログラム(All programs)"▶"アクセサリ(Accessory)"▶Click "ファイル名を指定して実行(Specify a file name and run)"

■ For Windows XP/2000

Click [スタート(Start)] ▶ 「ファイル名を指定して実行 (Specify a file)」

- 3 Enter "<CD-ROMドライブ名>:\¥Windows¥L-05A 接続ソフト¥StartCD.exe" in "名前 (Name)" ▶ Click "OK"

"自動再生" screen will be displayed depending on setting.If the screen is displayed, check "ソフトウェアとゲームに対しては常に次の動作を行う" and select "Launcher.exeの実行"

- 4 Perform the same operations as those after step 2 or later on "Setting Zero Installation (Auto) (→P36)"

Confirmation after Installation

Confirming L-05A Connection Software

1 Double click L-05A connection software icon

When the following screen is displayed, the confirmation of installation finishes.



Confirming the Installed L-05A Configuration File (Drivers)

Confirm whether L-05A Communication Configuration File (Drivers) is set in a PC.

■ For Windows Vista

1 Click [Start] ▶ [コントロールパネル (Control panel)] ▶ [システムとメンテナンス (System and maintenance)] ▶ [デバイス マネージャ (Device manager)] ▶ [続行 (Continue)]

■ For Windows XP

Click [スタート(Start)] ▶ [コントロールパネル(Control panel)] ▶ [パフォーマンスとメンテナンス(Performance and maintenance)] ▶ [システム(System)] ▶ [デバイス マネージャ(Device manager)] of [ハードウェア(Hardware)] tab

■ For Windows 2000

Click [スタート(Start)] ▶ [設定(Settings)] ▶ [コントロールパネル(Control panel)] ▶ [システム(System)] ▶ [デバイス マネージャ(Device manager)] of [ハードウェア(Hardware)] tab

2 Click each device display to confirm the driver name installed

- Confirm whether the driver name is displayed below "ポート (COM と LPT)(Port (COM and LPT))", "モデム (Modem)"

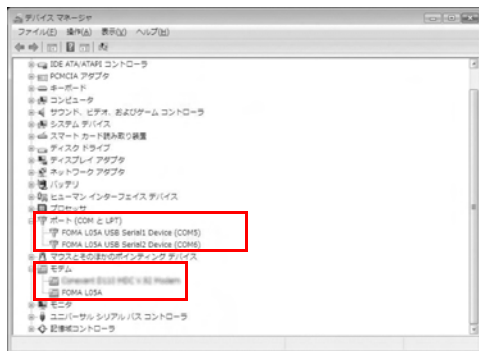

- COM port number differs depending on user and PC.

Device name	Driver name
Port (COM and LPT)	FOMA L05A USB Serial1 Device FOMA L05A USB Serial2 Device
Modem	FOMA L05A

Note

- If FOMA terminal is not recognized through the PC's USB port, try other available USB port. FOMA terminal may not be recognized properly with some USB port of PC.
- When communicating data with L-05A connection software, application operation of L-05A is required. →P66
- When communicating data with DOCOMO connection manager without L-05A connection software, installation of DOCOMO connection manager is required. →P79
- When communicating data with neither L-05A connection software nor DOCOMO connection manager, configure it manually. →P90

Uninstalling L-05A Connection Software (including a driver)

- Before uninstalling, remove the FOMA terminal from the PC.
- When uninstalling, make sure to install from the account with PC supervisor privileges.
- Make sure to save important data in FOMA card. Uninstallation will result in data loss when Phonebook or SMS data is saved in PC.

■ For Windows Vista

1 "スタート(Start)"▶"すべてのプログラム (All programs)"▶"L-05A接続ソフト (L-05A connection software)"▶Click "Uninstall"

■ For Windows XP

- "スタート(Start)"▶"すべてのプログラム (All programs)"▶"L-05A 接続ソフト(L-05A connection software)"▶Click "Uninstall"

■ For Windows 2000

- "スタート(Start)"▶"プログラム (Program)"▶"L-05A 接続ソフト(L-05A connection software)"▶Click "Uninstall"



2 Click "許可(Allow)" on "ユーザーアカウント制御 (User account control)" screen

If "キャンセル(Cancel)" is clicked, uninstallation will be stopped.

■ For Windows XP/2000

- Since "ユーザーアカウント制御 (User account control)" screen is not displayed, follow the next procedure.

3 Click "アンインストール (Uninstall)"



4 Click [OK]



5 Click [OK]



6 Click "完了 (Finish)"



Uninstallation finishes.

Macintosh Version

When installing L-05A connection software, make sure to finish "ドコモ コネクションマネージャ (DOCOMO connection manager)" first.

Note

- Do not remove the FOMA terminal while installing.
- When installing, make sure to install from the account with PC supervisor privileges.

Preparation for Using L-05A

Setting Zero Installation (Auto)

- 1 Connect the FOMA terminal with a Mac
CD-ROM icon is displayed on the desktop.
- 2 Double click the CD-ROM icon

- 3 Double click "L-05A 接続ソフト インストーラ .mpkg (L-05A connection software installer.mpkg)"



- 4 Click "続ける (Continue)"



- 5 Click "続ける (Continue)"



- 6 Confirm "使用許諾契約 (The license agreement)". If agree with the content, click "同意する (I Agree)"



7 Click "インストール (Install)"



8 Enter administrator password ▶ Click "OK"



9 Click "インストールを続ける (Continue installing)"



10 Click "再起動 (Restart)"

Mac restarts. Installation finishes.



Setting Manually (CD)

- 1 Start Mac▶Insert the CD-ROM into Mac
CD-ROM icon on desktop appears.
- 2 Double click CD-ROM icon▶"Mac"▶"L-05A
connection software"
- 3 For subsequent steps, operate the same
procedures as those after procedure 3 in "Set
Zero Installation (Auto)" (→P43)

Confirmation after Installation

Confirming L-05A Connection Software

- 1 Double click L-05A connection software icon
When the following screen is displayed, the confirmation of
installation finishes.



Note

- When communicating data with L-05A connection software, setting application operations of L-05A is required.→P66
- When communicating data with DOCOMO connection manager without L-05A connection software, installation of DOCOMO connection manager is required.→P79

Uninstalling L-05A Connection Software (including a driver)

- Before uninstalling, remove the FOMA terminal from the Mac.
- When uninstalling, make sure to install from the account with PC supervisor privileges.
- Make sure to save important data in FOMA card. Uninstallation will result in data loss when Phonebook or SMS data is saved in PC.
- End "DOCOMO connection manager" when uninstalling L-05A connection software.

1 Insert the included CD-ROM into a Mac

CD-ROM icon is displayed on the desktop.

2 Double click the CD-ROM icon

3 Double click "Mac"



4 Double click "L-05A接続ソフト (L-05A connection software)"



5 Double click "アンインストーラ.app (Uninstaller.app)"



6 Click "アンインストール(Uninstall)"



7 Enter administrator password ► Click "OK"

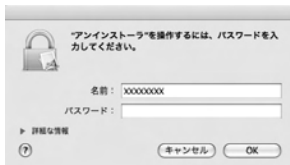

8 Confirm whether the FOMA terminal is connected to USB port before restarting

9 Click "再起動(Restart)"

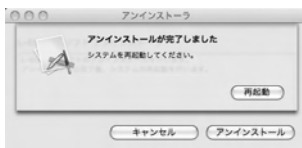

Mac restarts. Uninstallation finishes.

L-05A Connection Software

L-05A Connection Software	50
Using Packet Communication	53
Using SMS	54
Using Phonebook	63
Using Application Option.....	66

L-05A connection software is available to use on either Windows or Macintosh. Despite the display images of Windows version and Macintosh version are a little different, icons on the screen and available functions are same. Please note that in this chapter the descriptions are based on screen images of Windows.

L-05A Connection Software

The L-05A connection software allows you to use packet communication/SMS/Phonebook.

• Using Packet Communication→P53

Allows you to easily use packet communication.

• Using SMS→P54

Features of composing messages, Inbox, Outbox, Drafts box and Saving to FOMA card are available.

• Using Phonebook→P63

Features of composing messages, adding and deleting new group, transferring group, adding new item, modifying user, deletion are available.

• Using Application Option→P66

Confirm the amount of packet communication data usage, configure internet option, configure FOMA card, enter PIN1 code, configure the connection type (PDP), reset FOMA terminal, configure network are available.

Note

- Data of L-05A connection software will be saved in PC if no destination is specified.

Launching and Exiting Connection Software (For Windows)

Launching

- Double click  created on the desktop.

Exiting

- Click  located on the top of main application screen.

Launching and Exiting Connection Software (For Macintosh)

If connect with L-05A, it will be recognized as a CD-ROM first. For recognizing as a modem, drag the CD-ROM icon into trash.

Launching

- Launch "Finder" ▶"アプリケーション(Application)" ▶"L-05A 接続ソフト.app (L-05A connection software.app)"

Exiting

- Menu bar ▶"L-05A 接続ソフト(L-05A connection software)" ▶"L-05A 接続ソフトを終了(Quit L-05A connection software)"

Main Application Screen

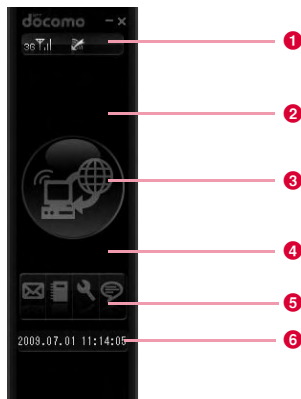

1 List of icon indicating FOMA terminal status

Signal reception level	
Strong	← → Weak
Network type	
W-CDMA*1,	HSDPA*2,
HSUPA*2,	GSM*3/GPRS*4



(Out of service area) In no signal reception area



Internet Connection



International Roaming



Unopened message found

※ 1 W-CDMA (3G)

A third generation mobile communication network complying with 3GPP Global standards. 3Gpp means 3rd Generation Partnership Project. The local standardization organization established for the development of common technical specifications related to 3rd Generation Mobile Communication Systems (IMT-2000).

※ 2 HSDPA (Short for High Speed Downlink Packet Access) HSUPA (Short for High Speed Uplink Packet Access)

A high speed type of W-CDMA data communication. It is called "3.5G" since it is the improvement version of 3rd generation (3G) cell phone (W-CDMA).

※ 3 GSM (Short for Global System for Mobile Communication)

The second generation mobile communication network in a digital communication system that is most widely used around the world.

※ 4 GPRS (Short for General Packet Radio Service)

GPRS is the 2.5 generation mobile communication system that enables highspeed packet communication using GSM.

2 Status/Message display area

- FOMA terminal, warning messages, operation status, network name.
- The information of currently accessed network operator is displayed when "network information" is set to "display"→P116

3 Buttons for connecting and disconnecting to Internet

- Click this button when connecting or disconnecting Internet.

4 Data communication information display area

- During connecting to Internet, connection time and amount of loaded data are displayed.



5 Operation button

- Buttons are available for SMS, Phonebook, Settings and Information.



: SMS (P54)



: 電話帳 (Phonebook) (P63)



: 設定 (Settings) (P66)



: インフォメーション (Information)
(P51)

6 Current time/data display area

- Current date and time are displayed.
- Time is set conformable to PC time.

Confirming My Number

Click  from the main application screen, and then you will see the following messages displayed.



Version information

My number

Using Packet Communication

You can use packet communication if click  from the main application screen.

Start Packet Communication

1 Click  from the main application screen

- Displays connection time, amount of downloaded data connection status icon .



Disconnecting to Packet Communication

1 Click  from the main application screen

- Packet communication will be disconnected after the messages displayed "切断しています。(Connection is being disconnected)".

Note

- The packet communication may be automatically disconnected depending on the network status or location.
- In packet communication, fees apply on the amount of sent/received data. Note that the communication fees may become high if you perform heavy communications such as by browsing websites which include large multimedia contents or if you download a lot of data.
- Data communication fees under international roaming differ from those in Japan.

Using SMS

Allows you to use various SMS features if click  from the main application screen.

- Maximum number of SMS stored in PC is 1000. Depending on PC's available hard disk space, number may differ. (Excluding FOMA card SMS box)

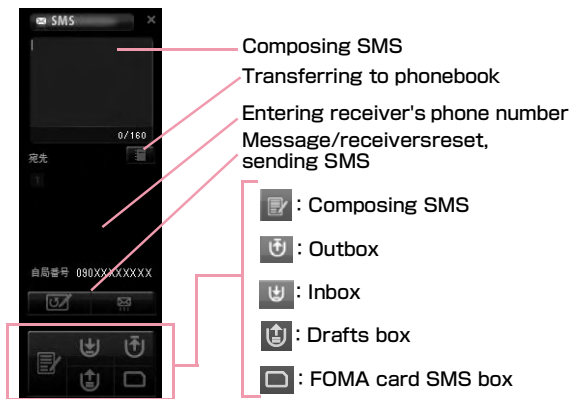

When Receiving SMS

The following screen appears when receiving SMS.

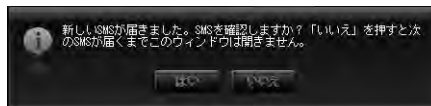

- 1 Click 

Composing SMS

- 1 Click  from the SMS application screen
- 2 Enter the SMS from the SMS composing screen
 - SMS can be entered up to 70 characters (English alphabet & numeric characters can be entered up to 160 characters)



3 Enter the receiver's phone number

- Enter the receiver's phone number by clicking the input or click  to display phonebook and decide a receiver.
- If you edit SMS or receiver, enter directly in SMS edit screen or phone number field to modify.



4 Click

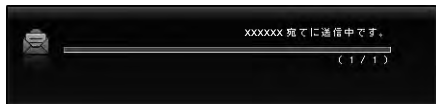

- SMS are being sent.



- Result of sending SMS.



Note

- You will be prompted whether you want to save the SMS to Drafts box or not, when moving to other applications or when failure incurred in transmission. If you click , the SMS will be saved to Drafts box. If you click , the SMS will not be saved to Drafts box.

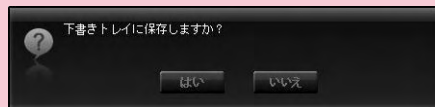

- Setting "SMS一括拒否(Multi-refuse SMS)"
By using the following AT command, SMS is set in terminal software.
For details of terminal software, refer to "通信の手动設定 (Configuring Network Manually)" P90
SMS refuse: AT+CUSD=1,"*141*1#",15
Unlock SMS refuse: AT+CUSD=1,"*141#",15

Inbox

- Allows you to store SMS to Inbox.

Confirming SMS from Inbox

- 1 Click  from the SMS application screen
 - Displays the list of received SMS.
- 2 Select and confirm the SMS from the SMS list



: SMS opened

: SMS unopened

Receiver phone number

Browse phonebook application screen → P64

Note

- The SMS status becomes opened once you click the received SMS.

Replying and Forwarding SMS from Inbox

- 1 Click  from SMS application screen
- 2 Select the reply/forward from Inbox list▶
Click 

"返信(Reply)/転送(Forward)" menu is displayed



- "返信(Reply)" : Receiver phone number is automatically entered and move to the SMS composing screen.
- "転送(Forward)" : SMS to be sent are automatically entered, and move to the SMS composing screen. The receiver phone number is required to enter.

- 3 Click 

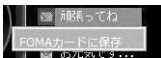

Copying Inbox SMS to FOMA Card

- 1 Click  from SMS application screen
- 2 Select the SMS and right-click▶Click "FOMAカードに保存(Save to FOMA card)"



- "FOMAカードに保存(Save to FOMA card)": Copy the received SMS of PC to FOMA card.
- You can copy 20 SMS in total including sent and received to your FOMA card.

Deleting SMS from Inbox

- 1 Click  from SMS application screen
- 2 Select the SMS to delete from the list of Inbox▶Click 

"削除(Delete)" "全削除(Delete all)" menu displayed



- "削除(Delete)" : Delete the selected SMS.
- "全削除(Delete all)" : Delete all SMS

The message for confirming is displayed.

- 3 Click 

Outbox

- Allows you to store SMS in Outbox.

Confirming SMS from Outbox

- 1 Click  from SMS application screen
 - Displays the list of sent SMS.
- 2 Select and confirm the SMS from the list





 : Sent SMS

Receiver's phone number

Browse phonebook application screen → P64

Editing SMS from Outbox

- 1 Click  from SMS application screen
- 2 Select the SMS to send from the list of Outbox▶Click 
 - SMS composing screen



- You will be prompted with SMS composing screen as soon as the receiver phone number and SMS are entered.
 - You can add or edit SMS and receiver phone number.
- 3 Click 

Copying SMS from Inbox to FOMA Card

- 1 Click  from SMS application screen
- 2 Select the SMS and right click▶Click "FOMAカードに保存(Save to FOMA card)"





- "FOMAカードに保存(Save to FOMA card)" : Copy sent SMS stored in a PC to FOMA card.
- Up to 20 received and sent SMS can be stored in FOMA card.

Note

- The information of time will not be saved when SMS are copied from Inbox to FOMA card.

Deleting SMS from Outbox

- 1 Click  from SMS application screen
- 2 Select the SMS to delete from the list of Inbox▶Click 

"削除(Delete)" "全削除(Delete all)" menu is displayed.



- "削除(Delete)" : Delete the selected SMS.
- "全削除(Delete all)" : Delete all SMS.

The message for confirming is displayed.

- 3 Click 

Drafts Box



- Allows you store temporary SMS in Drafts box.

Confirming SMS from Drafts box

- 1 Click  from SMS application screen
 - The list of SMS from Drafts box will be displayed.
- 2 Select and confirm the SMS from the list of Drafts box



Editing from Drafts Box

- 1 Click  from SMS application screen
- 2 Select the SMS to edit from the list of drafts box▶Click 
 - You will be prompted with SMS composing screen as soon as the receiver's phone number and SMS are entered.
 - You can add or edit SMS and receiver's phone number.
- 3 Click 

Deleting SMS from Drafts box

- 1 Click  from SMS application screen
- 2 Select the SMS to delete from the list of drafts box▶Click 

"削除(Delete)" and "全削除 (Delete all)" menu is displayed.



- "削除(Delete)" : Delete the selected SMS.
- "全削除(Delete all)" : Delete all SMS.

The message for confirming is displayed.

- 3 Click 



FOMA Card SMS Box

- Allows you to save SMS copied from Inbox or Outbox are to FOMA card SMS box.
- Up to 20 received and sent SMS can be stored in FOMA card.



Confirming SMS from FOMA Card SMS Box

- 1 Click  from SMS application screen
 - The list of SMS from Drafts box will be displayed.
- 2 Select and confirm the SMS from the FOMA card SMS box



-  :Received SMS (SMS unopened)
-  :Received SMS (SMS opened)
-  :Sent SMS

Replying and Forwarding SMS from FOMA Card SMS Box



- 1 Click  from SMS application screen
- 2 Select the SMS to reply/forward from the list of FOMA card SMS box▶Click 

"返信(Reply)" "転送(Forward)" menu is displayed.



- "返信(Reply)" : You will be prompted with SMS composing screen as soon as the receptor's phone number and SMS are entered.
 - "転送(Forward)" : The SMS to be sent will be automatically entered, and move to SMS composing screen. The receiver's phone number is required to enter.
- 3 Click 

Deleting SMS from FOMA Card SMS box

- 1 Click  from SMS application screen
- 2 Select the SMS to delete from the list of FOMA card SMS box▶Click 

"削除(Delete)" "全削除(Delete all)" menu is displayed.



- "削除(Delete)" : Delete the selected SMS.
- "全削除(Delete all)" : Delete all SMS.

The message for confirming is displayed.

- 3 Click 

Saving SMS in FOMA Card SMS Box to PC

- 1 Click  from SMS application screen
- 2 Select the SMS to save from the list of FOMA card SMS box▶Right click
- 3 Click "パソコンに保存(Save to PC)"



- 4 Click 



Sending SMS from Phonebook

- 1 Select the phonebook record to send
- 2 Click  from the phonebook application
 - Receiver's phone number is automatically entered and move to the SMS composing screen.



- 3 Click 
- 4 Click 



Note

- Refert to "SMS作成する (Composing SMS)" to enter the SMS. (P54)

Sending SMS from Japan to Overseas

■ SMS



- You can use the same mobile phone number overseas as is used in Japan.
- If receptor's terminal is FOMA terminal Enter "+", and "country code", in front of receptor's phone number, if receptor is subscribed to overseas carrier other than NTT DOCOMO. Also, enter the "010" "Country code" "Receptor's mobile phone number" in order. (If receptor's phone number starts with "0", enter the phone number without "0")
- If the receptor received unsupported characters of SMS from the sender who subscribed to other overseas carrier, the message may not be displayed properly.





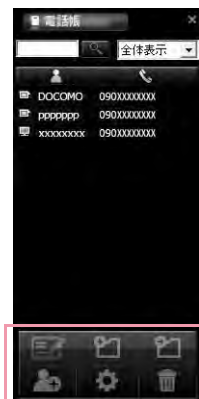

Using Phonebook

Click  allows you to use various features of phonebook. The list of stored phonebook records are displayed when Phonebook records are stored in FOMA card.

- Total number of phonebook records to be stored may be different depending on PC's available hard disk space. Total number of phonebook records stored in FOMA card is maximum 50.



-  :Phonebook record stored in FOMA card
-  :Phone number stored in PC

-  :Composing SMS
-  :Adding and deleting new group
-  :Transferring group
-  :New record
-  :Editing record
-  :Delete

Adding Phonebook Record

- Follow the steps to add new phonebook record

1 Click  from the Phonebook application

2 Start the following operations

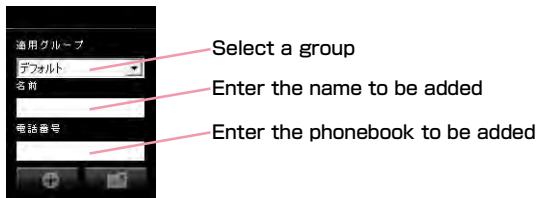



The screenshot shows a form with the following fields and annotations:

- 適用グループ** (Applicable Group): A dropdown menu with "デフォルト" (Default) selected. Annotation: "Select a group".
- 名前** (Name): A text input field. Annotation: "Enter the name to be added".
- 電話番号** (Phone Number): A text input field. Annotation: "Enter the phonebook to be added".

At the bottom of the form are two buttons: a plus sign (+) and a close (X) button.

- You can enter Kanji, Hiragana, Katakana, English, number, character. (Full-width 10 character. Half-width 21 character). You can enter the 20 character length.

3 Click 

-  : Save entered information to phonebook.
-  : Not save entered information to phonebook.

4 Click 



Searching Phonebook Record

1 Enter the name to be searched

- You can search phonebook record by entering phone number.



2 Click 

Editing Phonebook Record



1 Select the phonebook record to be edited



2 Click  from the phonebook application

- Edit phonebook record number if editing screen appears.

3 Click 

-  : Save entered information to phonebook.
-  : Not save entered information to phonebook.



4 Click 

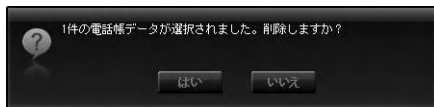

Deleting Phonebook Record

- 1 Select phonebook record to delete
- 2 Click  from the phonebook application



-  : Delete phonebook record.
-  : Cancel deleting phonebook record.

Note

- If you have many phonebook record to delete, multi-select phonebook records by using shift or Ctrl keys from key board and then click delete button to delete the selected phonebook record.

Adding New Group



- 1 Click  from the phonebook application
- 2 Enter the group name to be added
 - You can enter Kanji, Hiragana, Katakana, English, number, character. (Full-width 20character , Half-width 20character).



- 3 Click 
- 4 Click 





Deleting Group Name

- 1 Click  from the phonebook application
- 2 Select the group name to be deleted
- 3 Click 
- 4 Click 

Note

- "デフォルト(Default)" group and "FOMAカード (FOMA card)" group can not be deleted.

Phonebook Record Transferring Other Group







- 1 Select the phonebook record to be transferred
- 2 Click  from the phonebook application
- 3 Select the group name to be transferred
- 4 Click 
 - Transfer the selected phonebook record to the group you want to transfer to.

Note

- If selecting two or more record, select records by using Shift or Ctrl keys and then click "起動(Transfer)" to collectively transfer.

Using Application Option

Click  allows you to use various features of application option by clicking from the main application screen.

-  : Amount of downloaded data
-  : Internet option
-  : FOMA card
-  : Connection configuration
-  : FOMA terminal reset
-  : Network setup

The following s are required to connect Internet with L-05A connection software.

- 1 **The setting of provider information**
Register APN with other registration number (<cid>) on "接続方式設定(Connection type configuration)" screen. (→P72)
- 2 **Basic setting**
Configure "*99***<cid>#" as a dial number during packet communication on "Basic setting (Internet Option)" screen. Also configure "User name", "Passward" provided by provider if required.
Based on the above preparations, the APN with registration number entered in <cid> will be connected to.

Confirming Packet Communication Volume

- Confirms that the amount of data transmission used in packet communication

1 Click  from the application option screen.



全体使用量 (Total usage) Accumulated total data usage

 : Initialize total usage to zero

1ヶ月使用量 (Monthly usage) Monthly usage

 : Initialize monthly usage to zero

前回の使用量 data usage of current session

Note

- The data usage displayed on the screen may differ from the actual volume of packet communication.

Configuring Internet Option

- Allows you to configure basic settings for connecting to Internet.

1 Click  from the application option screen

2 Start the following operations

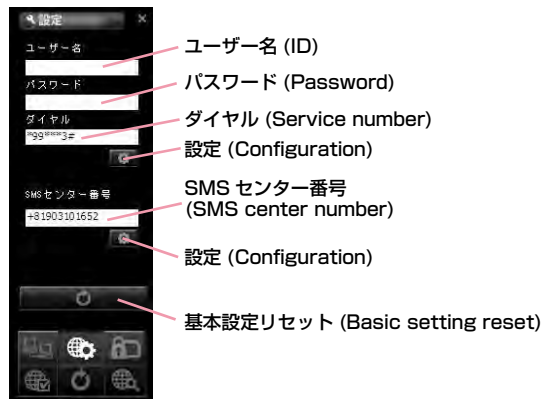

ユーザー名(ID) ID supplied from service provider
パスワード(Password) The password supplied from service provider

ダイヤル(Service number) number of service provider
※ For packet communication, enter *99***<cid>. Enter the registration number of APN set in <cid>(P72).

SMSセンター番号(SMS center number)
※ Normally, change in setting is not necessary. Enter SMS center number when using SMS from the network operator other than DOCOMO.

 **設定(Configuration)** Click to change setting

 **基本設定リセット(Basic setting reset)**
Click to return to basic setting

3 Click the applicable

Note

- Click  "設定(Configuration)" to renew the setting. Always remember to click when setting is changed.
- You will not connect to Internet if ID, password and service number are incorrect.
- SMS may not be sent or received when SMS service number has been improperly entered.
- In Macintosh, input any character in user name and password.

Configuring FOMA Card

- Allows you to configure "PIN1ロック(PIN1 lock)", "PIN1解除(PIN1 unblocking)", "PIN1暗証番号変更 (PIN1 code change)"

1 Click from the application option

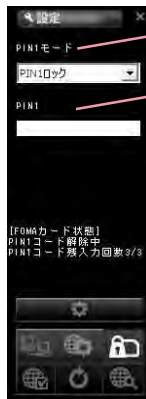

PIN1 モード (PIN1 Mode)

PIN1

Locking PIN1

- Set security to FOMA card.

- 1 Select "PIN1ロック(PIN1 locking)" from PIN1 mode
- 2 Enter the PIN1 code configured in FOMA card to "PIN1"



- 3 Click 
- 4 Click 



Note

- When starting L-05A connection software with PIN1 locked, you need to enter PIN1 code from the screen of entering PIN1 code. You can not use FOMA terminal properly unless you enter correct PIN1 code.

Unlocking PIN1

- 1 Select "PIN1解除(Unlocking PIN1)" from PIN mode
- 2 Enter the PIN1 code configured in FOMA card to "PIN1"



- 3 Click 
- 4 Click 



Note

- If PIN1 unlocking code is set, you can use FOMA card information from FOMA terminal without verifying PIN1 code.

Modifying PIN1 Code

- Set the password required when unlocking or locking PIN1.
- Changing PIN1 code is only available when PIN is locked.

1 Select "PIN1 暗証番号変更 (Changing password of PIN1)" from PIN1 mode

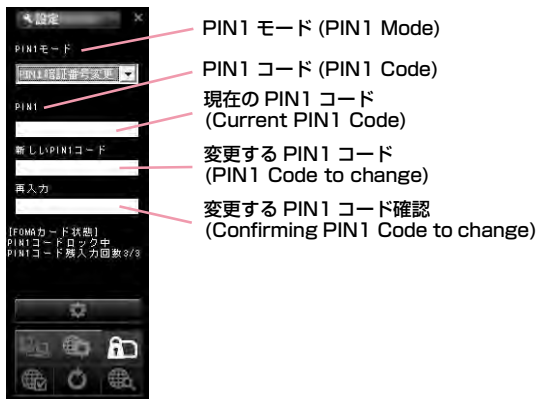

- 2 Enter the FOMA card PIN1 code to "PIN1"
- 3 Enter the PIN1 code change in "新しいPIN1 コード(New PIN1 code)"

4 Enter the PIN1 code entered in "新しいPIN1 コード (New PIN1 code)" code in "再入力 (Confirming New PIN 1 code)" again to verify

5 Click

6 Click



Entering PIN1 Code

- When L-05A connection software is started after setting PIN1 Lock, PIN1 code input screen will appear or it is restart to reset FOMA terminal.

1 Enter PIN1 code

Enter the 4 to 8 PIN1 code

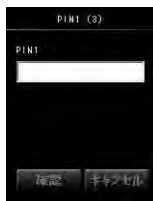

2 Verify the result after entering PIN1 code

Ex.1 : When PIN1 code has been successfully entered.



Ex.2 : When PIN1 code has been improperly entered.

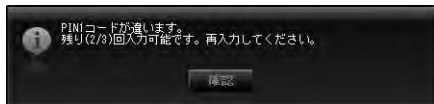

Ex.3 : When PIN1 code has been improperly entered 3 times in a row.

- If you improperly enter the PIN1 code 3 times in a row, the verification screen for unblocking PIN1 code will be displayed.

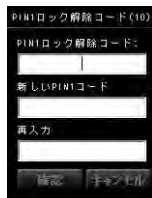

■ Unlocking locked PIN1 code

- Enter the unblocking PIN1 code to "PIN1ロック解除コード (Unblock)"
- Enter the PIN1 code to "新しいPIN1コード(New PIN1 code)" to change
- Enter the PIN1 entered in "新しいPIN1コード(New PIN1 code)" in "再入力(confirming New PIN1 code)" to confirm
- Click 

Caution

- Be careful not to lose FOMA card. DOCOMO is not responsible for the lost or stolen device.
- Do not transfer FOMA card to others.
- Treat it carefully as the data stored in FOMA card can be easily damaged from scratching or bending.
- When connecting FOMA terminal to a PC for the first time, you are required to enter PIN1 code to use FOMA card.
- If an incorrect PIN1 code is entered 3 times in a row, the service will be suspended. To use it again, you must enter unblocking PIN1 code.
- If an incorrect unblocking PIN1 code is entered 10 times in a row, FOMA card locks automatically, so be sure to keep a separate note of the number. Contact a DOCOMO shop if you are not able to unblock the locked PIN 1.

Configuring Connection type (PDP Type)

- Configure connection type.

1 Click  from Internet Option screen

2 Start the following operations



① 登録番号 (Registration number (cid))

② 接続方式 (Connection type)

③ 接続先 (Access Point Name (APN))

④ 接続方式登録
(Connection type registration)



⑤ 接続方式設定リセット
(Connection type setting reset)

1 登録番号 (Registration Number (cid))

The registration numbers are available from cid1 to cid10 in FOMA terminal. To connect to a provider other than 「mopera U」 or 「mopera」, you can set the access point name (APN) to any of cid2 or cid4 to cid10.

2 接続方式 (Connection type)

PDP type IP and PDP type PPP are available for Internet connection type. You can select the Internet connection type you want to use or check the currently configured internet connection type.

- 3 接続先(Access Point Name (APN))
Configure APN for packet communication. You can configure APN of provider you want to use or check the currently configured APN.
- 4  (Connection type registration)
Save the modified information to FOMA terminal.
- 5  (Connection type setting reset)
Reset all PDP configurations.

Saving and Editing the Provider Information

- Save or edit the provider information you want to use.

1 Select cid▶Select the registration number to save/edit



■ cid

- The registration numbers are available from cid1 to cid 10 in FOMA terminal.
- To connect to a provider other than 「mopera U」 or 「mopera」, you can set the access point name (APN) to any of cid2 or cid4 to cid10.

Registration number (cid)	Access Point name (APN)
1	mopera.ne.jp 「mopera」
2	Unassigned
3	mopera.net 「mopera U」
4~10	Unassigned

2 Select the Internet connection type supporting Access Point.



3 Enter APN

- When "cid=3" selected "PDP type IP" Configure mopera.net
This service provides a maximum data speed of 7.2Mbps for receiving and 5.7Mbps for sending.
- When "cid=1" selected "PDP type PPP" onfigure mopera.ne.jp This service provides a maximum data speed of 384kbps for receiving and 384kbps for sending.

Note

■ Configuring sender ID

You can configure to display sender ID or not by adding 186/184 before APN.

- Add "186." before APN if you want to display sender ID.
- Add "184." before APN if you don't want to display sender.

Registration	APN
Display sender ID	186.mopera.net
Not display Sender ID	184.mopera.net

4 Click Click



Retrieving Provider Information

① If select the cid of the "登録番号(Registration Number(cid))" ② "接続方式(connection type)" and ③ "接続先(Access Point Name (APN))" will be displayed.

Resetting FOMA Terminal

- Allows you to reset FOMA terminal.

1 Click from the application option



FOMA 端末リセット
(FOMA terminal reset)

■ FOMA端末リセット(FOMA terminal reset)

Reset FOMA terminal for the following cases

- When FOMA terminal is operating improperly.
- When FOMA card is reinserted while inserting the FOMA terminal to a PC.

2 Click

- FOMA terminal is restarting.



DOCOMO Connection Manager

DOCOMO Connection Manager	78
Windows Version	79
Macintosh Version	83

DOCOMO Connection Manager

DOCOMO connection manager is a software packets the necessary connection software to operate "定額データプラン接続ソフト (Flat-rate data plan connection software)" and measured data communication which are necessary when using flat-rate data plan.

[DOCOMO connection manager] is a software to connect data communication terminal by data communication corresponding terminal. Subscribing [mopera U] or configuring a PC operates easily.

Also, confirming amount of data communication and charges through charge counter feature is available.

Charge counter

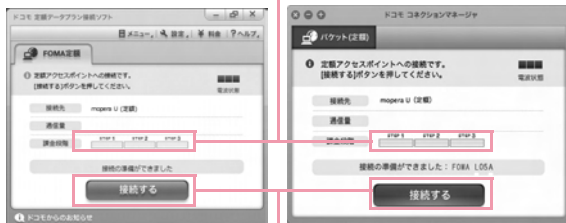

Windows version

Macintosh version

Connect/disconnect

This manual introduces the installation method of DOCOMO connection manager.

For connecting the terminal with Internet, agreement with the Internet service provider ([mopera U] etc.) supporting service and data communication is required.

View DOCOMO web site for detailed information (Japanese only).

Note

■ Using a flat-rate data plan

- For using a flat-rate data plan, the agreement with the charge plan corresponding to the flat-rate data communication and internet service provider is required. View DOCOMO web site for further information.

■ Using measured-rate data communication

- Note that the communication fees may come high if you perform heavy packet communications such as viewing home page with pictures inside, downloading data (Ex. : Application/Music/Data/OS/anti-virus software update) etc.

Note that when performing data communication after connecting this FOMA terminal with a PC by a USB cable, 「パケ・ホーダイ (Pake-hodai)」、 「パケ・ホーダイフル (Pake-hodaiful)」、 「Biz・ホーダイ (Biz-hodai)」 and 「Biz・ホーダイダブル (Biz-hodai double)」 are not included in the FOMA packet Flat-rate service.

■ Using mopera

- For connection configuration, view mopera web site. <http://www.mopera.net/mopera/support/index.html> (Japanese only)

Windows Version

Before Installing DOCOMO Connection Manager

■ Setting Internet Explorer

Before installing this software, set connection setting to "ダイヤルしない (Do not dial)" in Internet Option of Internet Explorer.



- 1 Start Internet Explorer▶Select "ツール (Tool)"-"インターネットオプション (Internet Option)"
- 2 Select "接続 (Connection)" tab▶Select "ダイヤルしない (Do not dial)"
- 3 Click "OK"

Note

■ Use other connection software besides DOCOMO connection manager

This software has equate features with the following software. Therefore, it is not necessary to use the following software at the same time.

- ※ If required, change the setting to not start or uninstall.
 - mopera U start up tools
 - mopera U connection & setting tool
 - FOMA PC configuration software
 - FOMA byte counter

Also, when using Mzone (Public Wireless LAN Connection) in this software, uninstall the following public wireless LAN connection software.

- ※ When the following software are installed at the same time, the Mzone connection of this software is not available.
 - U Public Wireless LAN Utility Software
 - DOCOMO Public Wireless LAN Utility Software
 - DOCOMO Public Wireless LAN Utility Program

1 Log on by DOCOMO connection manager user

■ For Windows Vista

An administrator is required. When logged on by other people than the administrator, entering user name and password will be asked.

■ For Windows XP/2000

The user belongs to administrators group or the user of "コンピュータの管理者 (Administrator of computer)" operates log-on.

2 Exiting all the applications launched

Besides anti-virus software, programs resident in Windows are also finished.

- Ex: Right click the icon shown on task bar, and select "閉じる (Close)" or "終了 (Finish)".

Installing DOCOMO Connection Manager

1 Launch the installer of DOCOMO connection manager using the included CD-ROM

Select "付属CD-ROM (the included CD-ROM)" ▶ "Windows" ▶ "dcm_connect_manager" ▶ "dcm_connect_full_setup.exe"

Note

- When Windows XP does not contain MSXML6 and Wireless LAN API, installation is required before installing DOCOMO connection manager. Press "Install" when the confirmation screen is displayed.
- After finishing installing MSXML6 and Wireless LAN API, if reboot Windows, the installation of DOCOMO connection manager starts automatically.

2 Click "続行 (Continue)"

For Windows XP/2000, "ユーザーアカウント制御 (User account control)" screen is not displayed. Setup program starts right away.



3 Click "次へ (Next)"



4 Make sure to confirm the caution and then click "次へ (Next)"

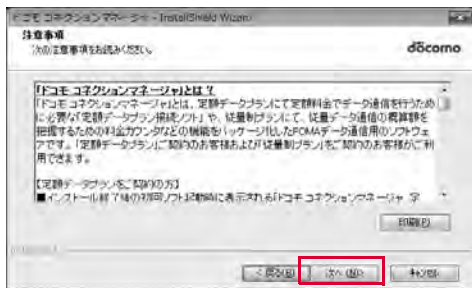

5 Confirm the content of the license agreement. When agree with the content, select "使用許諾契約の全条項に同意します (I agree with the license agreement stipulations)" and click "次へ (Next)"

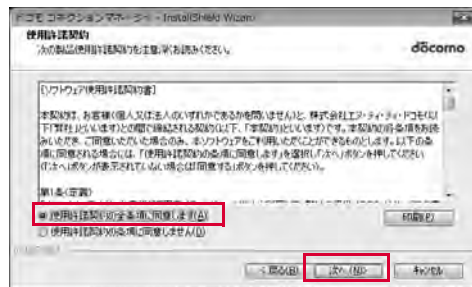

6 Confirm the destination folder and click "次へ (Next)"



7 Click "インストール (Install)"

Installing starts.



8 Click "完了 (Finish)"

Installing finishes.

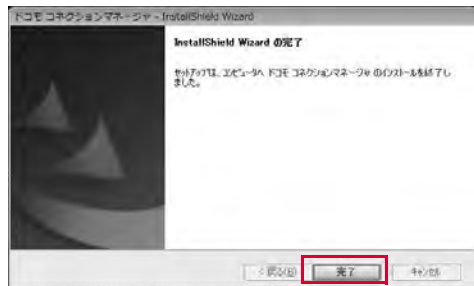

Launching DOCOMO Connection Manager

- 1 "スタート (Start)"▶"すべてのプログラム(All programs)"▶"NTT DOCOMO"▶"ドコモ コネクションマネージャ (DOCOMO connection manager)"▶"ドコモ コネクションマネージャ (DOCOMO connection manager)"

DOCOMO connection manager starts.

- 2 For the first launching, the wizard is displayed automatically.

The connection with Internet gets prepared when operating or setting following the instruction of software. Refer to 『ドコモ コネクションマネージャ操作マニュアル (DOCOMO connection manager operation manual).pdf』 for detailed information.



Note

- Just exiting the Internet browser or mail software does not disconnect the connection. When do not use communication, make sure to press "切断する (Disconnect)" button to disconnect the connection.
For OS update, if auto update is set, the software will be updated automatically. Note that the packet communication fee may come high.

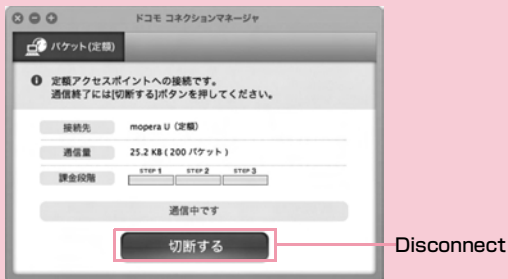

Macintosh Version

Installing DOCOMO Connection Manager

Note

- Use Ver. 1.00.0003 or later for "DOCOMO connection manager for Mac".

1 Launch the installer of DOCOMO connection manager from the included CD-ROM

- Select "付属CD-ROM (included CD-ROM)" ▶ "Mac" ▶ "dcm_connect_manager" ▶ "dcm_for_Mac" ▶ "インストール (Install)" ▶ Select "ドコモ コネクションマネージャをインストールします (Install DOCOMO connection manager)" and click "OK"

2 Click "続ける (Continue)"



3 Make sure to confirm "大切な情報 (Important information)", and click "続ける (Continue)"

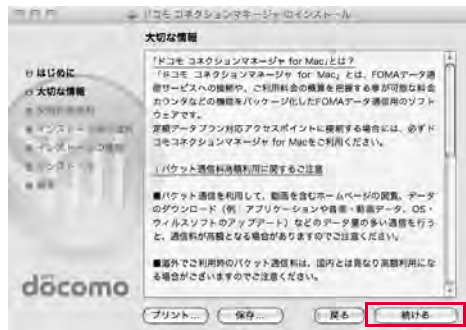

4 Click "続ける (Continue)"

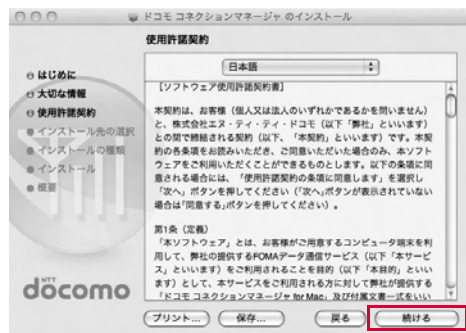

- 5 Confirm "使用許諾契約 (The license agreement)", when agree with the content, click "同意する (I Agree)"▶Click "続行 (Continue)"

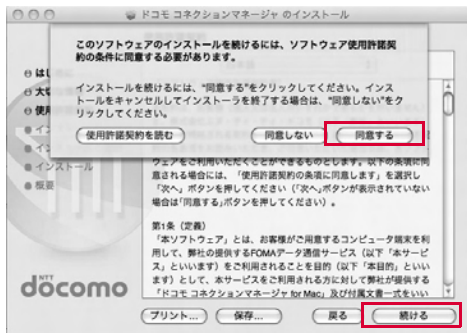

- 6 Confirming the destination folder to install and click "インストール (Install)"



- 7 Enter administrator name and password▶Click "OK"

The user account created after Mac OS X is set becomes the administrator of PC. Enter the used name and password.



8 Click "インストールを続ける (Continue installing)"

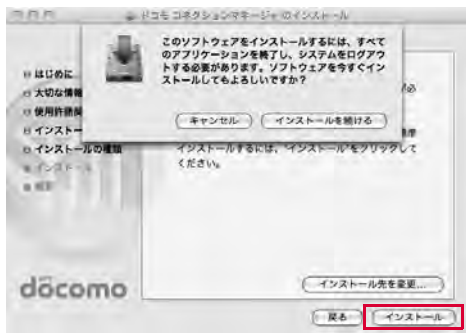

9 Click "ログアウト (Log out)"

Installing finishes.



Note

- If click "ログアウト (Log out)", setting assistant screen is displayed.
The connection with Internet gets prepared when operating or setting following the instruction of software.
Refer to 『ドコモ コネクションマネージャ操作マニュアル (DOCOMO connection manager operation manual)』 for detailed information.

Launching DOCOMO Connection Manager

1 "アプリケーション (Application)" ▶ "ドコモ コネクションマネージャ (DOCOMO connection manager)" ▶ "ドコモ コネクションマネージャ (DOCOMO connection manager)"

- DOCOMO connection manager starts.

2 For the first launching, the wizard setting is displayed automatically

The connection with Internet gets prepared when operating or setting following the instruction of software. Refer to 『ドコモ コネクションマネージャ操作マニュアル (DOCOMO connection manager operation manual.pdf)』 for detailed information.



Note

- Just exiting the Internet browser or mail software does not disconnect the connection. When do not use communication, make sure to press "切断する (Disconnect)" button to disconnect the connection. For OS update, if auto update is set, the software will be updated automatically. Note that the packet communication fee may come high.

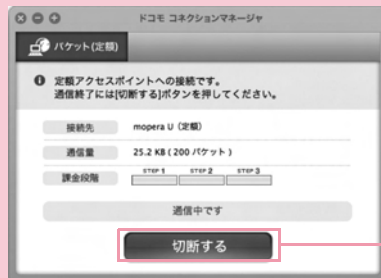

Disconnect

Configuring Network Manually

Configuring a Dial-up Network Manually	90
Communicating (Connecting by Dial-up)	109

Configuring a Dial-up Network Manually

This section describes the steps to configure settings for packet communication without using L-05A connection software or DOCOMO connection manager.

Setting APN

Set the access point (APN) in packet communication. Up to 10 APN can be set up and they are managed with cid's. Communication software is required to enter AT commands. This section describes the steps necessary for using the "ハイパーターミナル(Hyper Terminal)" that comes with Windows.

- The registration number (cid) 1 is set to mopera.ne.jp and the registration number 3 is set to mopera.net by default. Use cid 2 or from 4 to 10 when setting another access point.
- "ハイパーターミナル(Hyper Terminal)" does not come with Windows Vista. To configure the settings in Windows Vista, use communication software compatible with Windows Vista. For the setting procedures, refer to the instruction manual and other documentation that came with the software to be used.
- For a connection (APN) other than 「mopera U」 or 「mopera」, contact your ISP or network administrator.

For Windows XP

- 1 Connect the FOMA terminal with a PC
 - Connecting method→P24
- 2 Click "スタート(Start)" ▶ "すべてのプログラム (All programs)" ▶ "アクセサリ (Accessories)" ▶ "通信(Communication)" ▶ "ハイパーターミナル (Hyper Terminal)"
Hyper Terminal starts.
 - For Windows 2000
Click "スタート(Start)" ▶ "プログラム (Programs)" ▶ "アクセサリ(Accessories)" ▶ "通信(Communication)" ▶ "ハイパーターミナル(Hyper Terminal)".
- 3 Enter a connection name in the "名前 (Name)" field ▶ Click "OK"



4 Enter a non-existing phone number (such as "0") in the "電話番号(Phone Number)" field ▶ Check that "FOMA L05A" is displayed for "接続方法(Connection Method)" ▶ Click "OK"

- If more than one modem name are displayed in the "接続方法(Connection Method)" field, check the FOMA terminal modem name and select the proper one.→P40

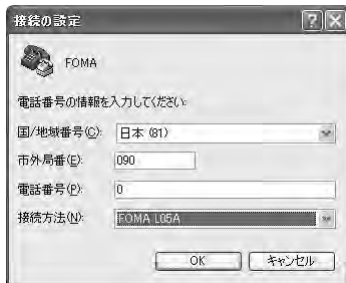

5 Click "キャンセル(Cancel)" on the connection screen

The Hyper Terminal screen opens.

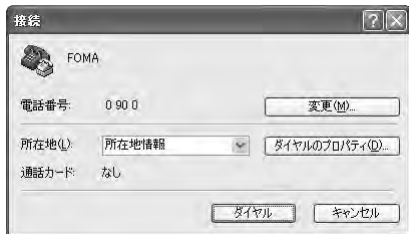

6 Enter the APN in the following format▶Press

Enter AT+CGDCONT=<cid>,"<PDP type>","<APN>"
Enter the following information in the corresponding <cid>, <PDP type> and <APN> sections.
If "OK" appears after you enter the information, the APN has been setup.

cid : Enter any number from 2, and from 4 to 10.
※ Keep in mind that the old setting information will be overwritten if you select a cid number which has already been set.

PDP type : Select either PPP or IP for the connection method supported by the access point, and then enter the information enclosed in quotation marks ("").

APN : Enter the connection (APN) enclose it in quotation marks " ".

- If the entered characters do not appear, enter ATE1.

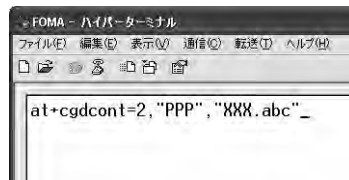

If register an access point with PPP in the PDP type and XXX.com in the APN of cid2

■ **To reset the specified APN settings**

Enter AT+CGDCONT=<cid>

■ **To view the registered APN**

Enter AT+CGDCONT

7 Check if "OK" is displayed



8 Click "ファイル(File)" ▶ "ハイパーターミナルの終了(Exit Hyper Terminal)"

9 Click "はい(Yes)" on the confirming disconnection screen ▶ Click "いいえ(No)" on the confirming to save screen

Hyper Terminal will quit, and the setting of the APN completes.

Note

- The APN information is saved in the FOMA terminal. If you connect a different FOMA terminal, save the APN information again.
- If you want to use the APN information registered on the PC, register the same APN in the same cid of the FOMA terminal.

Configuring Dial-up Network

Set up the dial-up network on the PC.

- For setting up a connection to other than 「mopera U」 or 「mopera」, contact your ISP or network administrator.

Example: Connecting to the DOCOMO Internet connection service 「mopera U」, which is registered to <cid>=3

For Windows Vista

- 1 Click  "スタート(Start)" ▶ "接続先(Connection)"
- 2 Click "接続またはネットワークをセットアップします(Set up connection or network)"

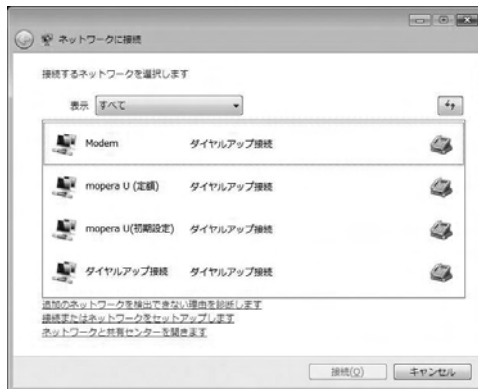

- 3** Select "ダイヤルアップ接続をセットアップします (Set up dial-up connection)" ► Click "次へ (Next)"



- 4** When the modem selection screen appears, click "FOMA L05A"

The modem selection screen opens only when the PC has more than one modem.



5 Configure various settings, then click "接続 (Connect)"

- Enter the APN number in the "ダイヤルアップの電話番号 (Phone number to a dial-up connection)".
- Enter the user name and password specified by your ISP or network administrator in the "ユーザー名(User name)" and "パスワード(Password)" fields.
- You can leave the user name and password fields unfilled when connecting to 「mopera U」 / 「mopera」 .
- Enter a connection name in the "接続名 (Connection Name)" field.

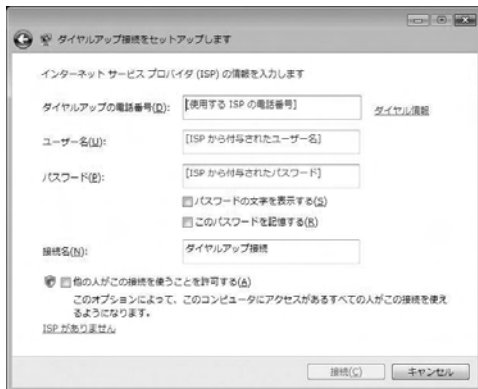

6 Click "スキップ(Skip)" on the "(接続名)に接続中..." (Connecting to (APN))" screen

The connection test will not be performed. Only the settings will be checked.

- If you do not click "スキップ(Skip)", the connection to the Internet will be established.



- 7 Click "接続をセットアップします(Set up the connection)" ▶ "閉じる(Close)"



- 8 Click "スタート(Start)" ▶ "接続先(Connection)"

- 9 Select the created dial-up connection icon ▶ Right click "プロパティ (Properties)"

- 10 Check the settings on the "全般(General)" tab window

If two or more modems are connected to a PC, enable only "モデム - FOMA L05A (Modem - FOMA L05A)" in the "接続方法 (Connection Method)" field.

- Disable "ダイヤル情報を使う (Use dialing information)".



11 Click "ネットワーク(Networking)" tab ► Configure each setting

Place a checkmark next to the "インターネットプロトコルバージョン4 (TCP/IPv4) (Internet Protocol 4 (TCP/IPv4))" checkbox in the "この接続は次の項目を使用します(This connection uses the following items)" field. Obtain the settings for "QoSパケットスケジューラ(QoS Packet Scheduler)" from your ISP or network administrator.

- To set up TCP/IP, click "プロパティ (Properties)". Contact your ISP or network administrator for setting up.



12 Click the "オプション (Option)" tab ► Click "PPP設定 (PPP Settings)"

13 Remove checkmarks from all items ► Click "OK"

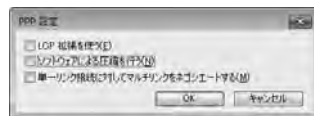

14 On the "オプション (Option)" tab window, click "OK"

1 Click "スタート(Start)" ▶ "すべてのプログラム (All programs)" ▶ "アクセサリ (Accessories)" ▶ "通信 (Communication)" ▶ "新しい接続ウィザード (New Connection Wizard)"

2 On the New connection wizard screen, click "次へ (Next)"

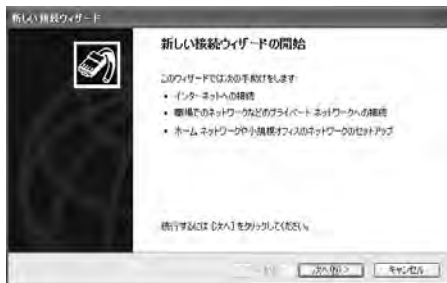

3 Select "インターネットに接続する (Connect to the Internet)" ▶ Click "次へ (Next)"



4 Select "接続を手動でセットアップする (Set up the connection manually)" ▶ Click "次へ (Next)"

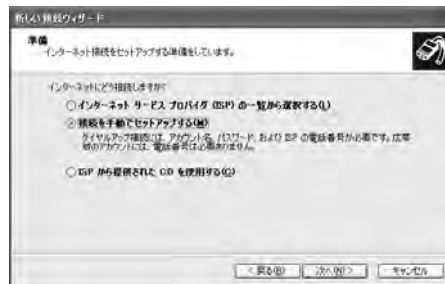

- 5 Select "ダイヤルアップモデムを使用して接続する (Use a dial-up modem to connect)" ▶ Click "次へ (Next)"



- 6 If "デバイスの選択 (Select a device)" screen appears, check in "モデム - FOMA L05A (COM4) (Modem - FOMA L05A (COM4))" checkbox ▶ Click "次へ (Next)"

The "デバイスの選択 (Select a device)" screen appears only when the PC has more than one modem.



- 7 Enter a name in the "ISP名 (ISP Name)" field ▶ Click "次へ (Next)"



- 8 Enter the APN phone number in the "電話番号 (Phone Number)" field ▶ Click "次へ (Next)"



- For packet communication
Enter "*99**<cid>#". Enter the registered number of APN in <cid>. (P73)

9 Select the connection usage range ▶ Click "次へ(Next)"

Select a user.

- Depending on the PC settings, this screen may not appear.

10 Fill in the "ユーザー名(User Name)", "パスワード(Password)", and "パスワードの確認入力(Confirm password)" fields ▶ Click "次へ(Next)"

Enter the information provided by your ISP or network administrator.

- Enter "ユーザー名(User name)" and "パスワード(Password)" correctly according to the instruction from the provider. Pay attention to the capital characters.
- To connect to 「mopera U」 or 「mopera」, these fields can be left unfilled.



11 Click "完了(Finish)"

The new connection wizard appears.



12 Click "スタート(Start)" ▶ "すべてのプログラム(All programs)" ▶ "アクセサリ(Accessories)" ▶ "通信(Communication)" ▶ "ネットワーク接続(Network Connection)"

13 Select the created dial-up connection icon Right click ▶Click "プロパティ (Properties)"



14 Check the settings on the "全般 (General)" tab window

- If more than one modem is connected to a PC, enable only "モデム - FOMA L05A (COM4) (Modem - FOMA L05A (COM4))" in the "接続方法 (Connection Method)" field.
- Disable "ダイヤル情報を使う (Use dialing information)".



15 Click the "ネットワーク(Networking)" tab▶Confirm each item▶Click "設定(Settings)"

- Select "PPP:Windows 95/98/NT4/2000, Internet" in the "呼び出すダイヤルアップサーバーの種類(Dial-up server type to call)" field
- Enable "インターネットプロトコル(Internet Protocol) (TCP/IP)" in the "この接続は次の項目を使用します(This connection uses the following items)" field. You cannot change the settings of "QoSパケットスケジューラ (QoS Packet Scheduler)". Use it as usual.
- When connecting to provider, to confirm the TCP/IP setting contact the provider or network administrator.



16 Click "設定(Settings)"

17 Remove checkmarks from all items ▶ Click "OK"

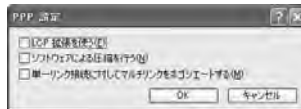

18 click "OK" on the "ネットワーク(Networking)" tab window

For Windows 2000

1 Click "スタート(Start)" ▶ "プログラム(Programs)" ▶ "アクセサリ(Accessories)" ▶ "通信(Communication)" ▶ "ネットワークとダイヤルアップ接続(Network and Dialup Connections)"

2 On the Network and Dial-up connection screen, double-click the "新しい接続の作成(Create new connection)" icon

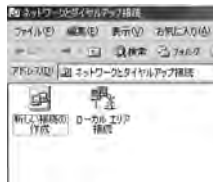

- 3** If the location information screen appears, enter "市外局番(City code)" ► Click "OK"

This appears only when "新しい接続の作成 (Create new connection)" is launched for the first time. Go to Step 5 when launching this for the second time or later.

- 4** On the phone and modem option screen, click "OK"

- 5** On the Network connection wizard screen, click "次へ (Next)"



- 6** Select "インターネットにダイヤルアップ接続する (Connect to Internet via dial-up)" ► Click "次へ (Next)"

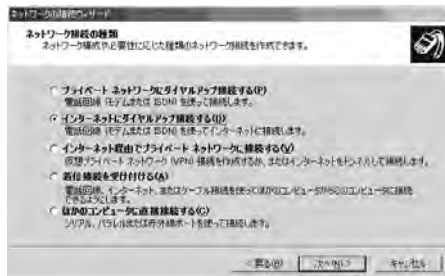

- 7** Select "インターネット接続を手動で設定するか、またはローカルエリアネットワーク(LAN)を使って接続します(Set up the Internet connection manually, or connect to the Internet using LAN)" ▶ Click "次へ(Next)"

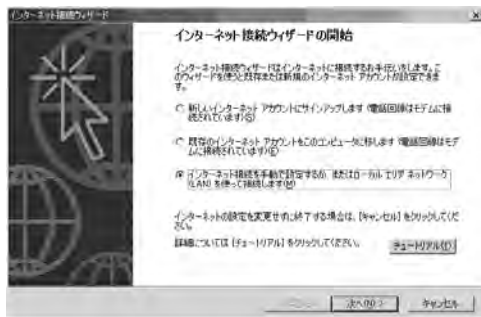

- 8** Select "電話回線とモデムを使ってインターネットに接続します(Connect to the Internet using a telephone line and a modem)" ▶ Click "次へ(Next)"



9 If the modem selection screen opens, select "FOMA L05A" ▶ Click "次へ (Next)"

The modem selection screen opens only when the PC has more than one modem.

- If "FOMA L05A" is not displayed, click "インターネットへの接続に使うモデムを選択する" (Select the modem used to connect to the Internet)" field and then select "FOMA L05A".



10 Enter the APN phone number in the "電話番号 (Phone Number)" field ▶ Click "詳細設定 (Advanced settings)"

- Do not enter anything in "市外局番(City code)" field
- Disable "市外局番とダイヤル情報を使う(Use the city code and dialing information)".



■ Packet communication information

Enter "*99**<cid>#". Enter registration number of APN in <cid>.

11 Configure the settings on the "接続 (Connection)" tab window according to the examples on the screen.

- If you are connecting to other than 「mopera U」 or 「mopera」, fill in the "接続の種類 (Connection type)" and "ログオン手続き (Log on procedures)" fields according to the information provided by your ISP or network administrator.

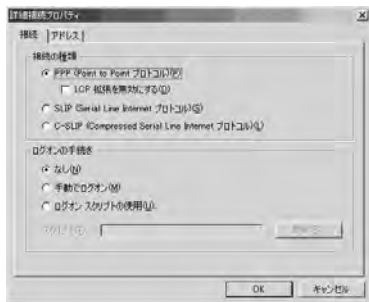

12 Click the "アドレス (Address)" tab▶Set each item▶Click "OK"

- If you are connecting to other than 「mopera U」 or 「mopera」, fill in the "IPアドレス (IP address)" and "ISPによるDNS (ドメインネームサービス) アドレスの自動割り当て (Assign DNS address automatically by ISP)" fields according to the information provided by your ISP, and follow the instruction from provider.

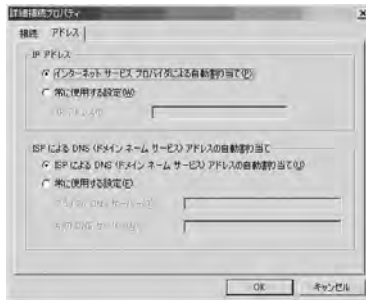

13 On the "インターネットアカウントの接続情報 (Internet account connection information)" screen, click "次へ(NEXT)"

14 Enter "ユーザー名(User Name)" and "パスワード (Password)" ► Click "次へ(NEXT)"

- Enter "ユーザ名(User name)" and "パスワード(Password)" correctly according to the instruction from the provider. Pay attention to the capital characters.



Note

- For 「mopera U」 or 「mopera」, connection is operated even when "ユーザー名(User name)" field and "パスワード (Password)" field are empty. The screen "ユーザー名を空白のままにしておきますか？ (Is it OK to enter nothing in User name?)" is displayed in this case. Click "はい(OK)" in each screen.

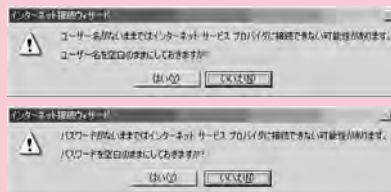

15 Enter a connection name in the "接続名 (Connection Name)" field ▶ Click "次へ (Next)"



16 Select "いいえ (No)" ▶ Click "次へ (Next)"

- When setting Internet mail, select "はい (OK)". Contact the provider for detailed information of setting.

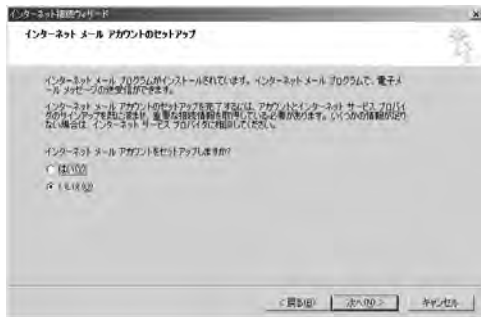

17 Click "完了 (Finish)"

- If "今すぐインターネットに接続するにはここを選び完了をクリックしてください (Select this to connect to the Internet now and click Finish)" appears, disable the option.



18 Select the created dial-up connection icon ▶ Click "ファイル (File)" ▶ "プロパティ (Properties)"

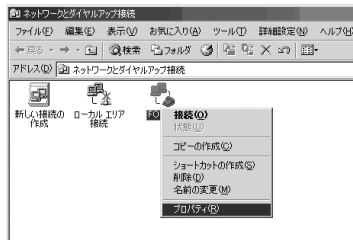

19 Check the settings on the "全般 (General)" tab window

- If more than one modem is connected to a PC, enable only "モデム - FOMA L05A (COM3) (Modem - FOMA L05A (COM3))" in the "接続の方法 (Connection Method)" field
- Disable "ダイヤル情報を使う (Use dialing information)".



20 Click the "ネットワーク (Networking)" tab ► Confirm each item ► Click "設定 (Settings)"

- Select "PPP:Windows 95/98/NT4/2000, Internet" in the "呼び出すダイヤルアップサーバーの種類 (Dial-up server type to call)" field.
- Enable only "インターネットプロトコル (Internet protocol) (TCP/IP)" in the "コンポーネント (Components)" field.



21 Click "設定 (Settings)"

22 Remove checkmarks from all items ► Click "OK"

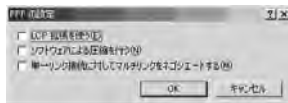

23 Click "OK" on the "ネットワーク (Networking)" tab window

Communicating (Connecting by Dial-up)

This section describes steps to start and terminate communication without using L-05A connection software or DOCOMO connection manager.

- Check whether the FOMA terminal and the PC are connected properly before starting communication.→P24
- When performing communication, connect the FOMA terminal you used to configure the settings. If a different FOMA terminal is connected, L-05A Communication Configuration Files (Drivers) may need to be reinstalled.

For Windows Vista

1 Click  "スタート(Start)" ▶ "接続先 (Connect to)" ▶ Select the access point that has been set up ▶ Click "接続 (Connect)."

■ For Windows XP

Click "スタート(Start)" ▶ "すべてのプログラム(All programs)" ▶ "アクセサリ (Accessories)" ▶ "通信 (Communication)" ▶ "ネットワーク接続(Network connection)" ▶ Double click the APN that has been set up

■ For Windows 2000

Click "スタート(Start)" ▶ "プログラム (Programs)" ▶ "アクセサリ(Accessories)" ▶ "通信(Communication)" ▶ "ネットワークとダイヤルアップ接続(Network and Dialup Connections)" ▶ Double-click the APN icon that has been set up.

2 Enter "ユーザー名(User Name)" and "パスワード (Password)" ▶ Click "ダイヤル(Dial)"

The APN will be connected.

- To connect to 「mopera U」 or 「mopera」, you can leave the "ユーザー名(User Name)" and "パスワード(Password)" fields unfilled and click "ダイヤル(Dial)". If another ISP or dialup connection is selected, fill in the "ユーザー名(User Name)" and "パスワード (Password)" fields and click "ダイヤル (Dial)".
- You can save the user name and password or just the password to skip entering them next time.
- Depending on the operating system, a connection completion screen may appear when the dial-up connection is established. However, the connection completion screen does not appear if you previously set the completion message not to appear.



Disconnecting Communication

Exiting the Internet browser may not terminate the connection. Perform the following steps to terminate the connection securely.

For Windows Vista

1 Click  the dial-up icon in the task tray of the PC

A screen indicating the connection status appears.

2 Click "接続または切断(Connect or disconnect)"



■ For Window XP/2000

The above screen will not be displayed. Follow the next procedure.

3 Click "切断(Disconnect)"

The communication will be terminated.



Note

- The communication speed shown on the PC screen may be different from the actual communication speed.

Overseas Use

International Roaming Service (WORLD WING) ..	112
Services Available Overseas	112
Before Using Overseas	113
Setting the Searching Method for Available Networks	115
Configuring Network	116

International Roaming Service (WORLD WING)

WORLD WING is DOCOMO's international roaming service that provides telephone and other types of communication services overseas out of the service area of FOMA network, using affiliated overseas network.

- The following 3 types of communication are included in overseas network.

■3G network

A third generation mobile communication network complying with 3GPP Global standards. (3rd Generation Partnership Project)※

- ※ The local standardization organization established for the development of common technical specifications related to 3rd Generation Mobile Communication Systems (IMT-2000)

■GSM (Global System for Mobile Communication) network

The second generation mobile communication network in a digital communication system that is most widely used around the world.

■GPRS (3General Packet Radio Service) network

GPRS is the 2.5 generation mobile communication system that enables high speed packet communication using GSM.

- It is available to use 3G network or GSM/GPRS network service within service area. For countries/areas support 3G850MHz/GSM850MHz, it is also available to use.
- Before using the FOMA terminal overseas, refer to the followings.
 - "Mobile Phone User's Guide [International Services]"
 - DOCOMO "International Service Web site"

Services Available Overseas

Available communication services may vary depending on the overseas carrier or network.

Available Communication Services

Service	Description
Data Communication	Available for data communication using packets communication.

- ※ Sending and receiving SMS may be available in overseas. Please understand that communication fee is counted when sending SMS.
- ※ Packet communication is not available for GSM network communication type.

Note

- For details on available communication services while using international roaming, refer to Mobile Phone User's Guide [International Services] or visit DOCOMO "International Service Web site".
- Voice call or video telephony features are not supported by L-05A.

Before Using Overseas

STEP1 : Before Leaving Japan

STEP2 : While Overseas

STEP3 : After Coming Back to Japan

Before Leaving Japan

Before using the FOMA terminal overseas, refer to the followings.

- "Mobile Phone User's Guide [International Services]"
- "Mobile Phone User's Guide [Network Services]"
- DOCOMO "International Service Web site"

■ Subscription

- If you subscribed to the FOMA service after September 1, 2005, no separate subscription is required to use "WORLD WING". If you subscribed to the FOMA service on or before August 31, 2005 and have not subscribed to "WORLD WING", a separate subscription is required to use it.
- A FOMA card (green/white) made available for WORLD WING must be inserted in the FOMA terminal.

■ Power source and voltage in the country or region of stay

- Countries and regions may have different power sources, voltages or power outlet shapes. Check these in the instruction manual for your PC or web sites of the PC manufacturer in advance.

■ Network setup

- You can change network setup from overseas.→P116

■ Internet access

- For overseas access points or settings for using the Internet overseas, contact your Internet service provider.

- If you subscribe to mopera U, visit the mopera U web site.
<http://www.mopera.net/> (Japanese only)

While Overseas

■ Switching networks

Searching for and connecting to an access point are performed automatically by default. No special settings are required.

■ Main screen display area

The name of the connected carrier can be viewed in the display area of the Main screen.→P116



Note

- You can manually switch networks if you want to connect to a particular network. See procedure 3 of "ネットワークを設定する (Configuring Networks)" (P116)

Inquiries overseas

If your FOMA card (green/white) is lost or stolen overseas, contact DOCOMO immediately and temporarily suspend your subscription. For inquiry information, see "docomo Information Center" on the back of this manual. Call or data communication charge will still on you after the terminal was lost or stolen.

■ Country Codes for Major Countries

Area	Code	Area	Code
U.S.A	1	Germany	49
U.K.	44	Turkey	90
Italy	39	Japan	81
India	91	New Caledonia	687
Indonesia	62	New Zealand	64
Egypt	20	Norway	47
Australia	61	Hungary	36
Austria	43	Fiji	679
Netherlands	31	Philippines	63
Canada	1	Finland	358
Korea	82	France	33
Greece	30	Brazil	55
Singapore	65	Vietnam	84
Switzerland	41	Peru	51
Sweden	46	Belgium	32
Spain	34	Hong Kong	852
Thailand	66	Macau	853
Taiwan	886	Malaysia	60
Tahiti	689	Maldives	960
Czech	420	Russia	7
China	86		

※ For country code or detailed information, refer to "Mobile Phone User's Guide [International Services]" or DOCOMO "International Service Web site".

■ International Access Codes for Major Countries (Table 1)

Area	Code	Area	Code
Ireland	00	Germany	00
U.S.A.	011	Turkey	00
U.A.E.	00	New Zealand	00
U.K.	00	Norway	00
Italy	00	Hungary	00
India	00	Philippines	00
Indonesia	001	Finland	00
Australia	0011	France	00
Netherlands	00	Brazil	0021
Canada	011		0014
Korea	001	Vietnam	00
Greece	00	Belgium	00
Singapore	001	Poland	00
Switzerland	00	Portugal	00
Sweden	00	Hong Kong	001
Spain	00	Macau	00
Thailand	001	Malaysia	00
Taiwan	002	Monaco	00
Czech	00	Luxembourg	00
China	00	Russia	810
Denmark	00		

※ For codes of other countries or details, visit DOCOMO "International Service Web site".

■ International Phone Codes for Universal Number (Table 2)

Area	Code	Area	Code
Ireland	00	Taiwan	00
U.S.A.	011	China	00
Argentina	00	Denmark	00
U.K.	00	Germany	00
Israel	014	New Zealand	00
Italy	00	Norway	00
Australia	0011	Hungary	00
Austria	00	Philippines	00
Netherlands	00	Finland	990
Canada	011	France	00
Korea	001	Brazil	0021
Colombia	009	Belgium	00
Singapore	001	Portugal	00
Switzerland	00	Hong Kong	001
Sweden	00	Malaysia	00
Spain	00	South Africa	09
Thailand	001	Luxembourg	00

※ For codes of other countries or details, visit DOCOMO "International Service Web site".

After Coming Back to Japan

After coming back to Japan, the FOMA network will be connected automatically.

■ If connection can not be established

Set to "自動検索(Auto)" from "ネットワーク検索(Search Network)" of "ネットワークを設定する(Configuring network)" (P116)

Setting the Searching Method for Available Networks

Switching Carriers Manually

The FOMA terminal is set to automatically find and switch to an available network in the country of stay by default. However, if you have a preferred network in the area or network cannot be found automatically, you can set to a network manually. For details, see "Configuring Networks" (P116).

Configuring Network

- Allow you to configure network by L-05A connection software.

1 Click  from the application option screen

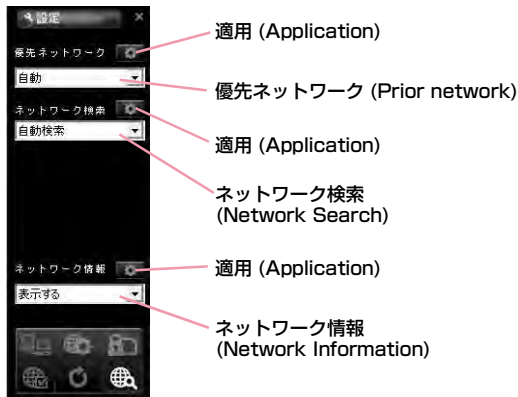

2 Specify a "優先ネットワーク(Prior network)"
(Network priority order selection setting)

3 Searching network

■ 自動検索(Auto)

Network can be searched automatically.

■ 手動検索(Manual)

Connect to the listed networks manually.

※ If network search mode is set to "manual" overseas,
reset to "Auto" after coming back to Japan.

4 Specify if display or hide the network information

■ 表示する(Display)

The name of the network receiving current service is
displayed on the screen.

■ 表示しない(Hide)

The name of the network receiving current service is
not displayed on the screen.

5 Click the applicable

- The information entered will not be set without clicking the
applicable 

6 Click

Note

- How to manually configure network
 - Select "手動選択(Manual)"
 - The available network list will be displayed after searching.
 - Select one from the available networks.
 - Click 
- Network is not displayed in FOMA area when even if "display" is set in network information.
- Connecting to Internet or sending SMS may not be able to operate properly when network setting is changed manually.
- While using Oversea→P111
 - When you are in roaming area and set FOMA terminal to automatically find and you can have automatic roaming service. If network can not be found automatically, select the available network service manually.
 - Some communication services may not available depending on the overseas carrier or network.

Appendix/Troubleshooting

AT Commands	120
AT Command List	121
Troubleshooting	130
Error Messages	132
Warranty and After-Sales Service	134
Updating software	135
Main specifications	136
Export Controls of the Product and Accessories	137
Intellectual Property Rights	139
Index	141

AT Commands

AT commands are used to check the FOMA terminal function settings or status by using a PC. Usually, the communication software issues AT commands so you do not need to be concerned about them. Use AT commands if you want to control the FOMA terminal in your own way.

Form of AT Commands

AT commands should be entered on the Terminal Mode screen of the communication software. Use only single-byte alphanumeric characters.

<Example>

ATD * 99 * * * 3# 

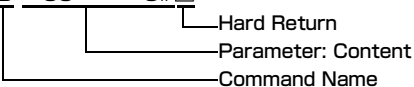

Hard Return
Parameter: Content
Command Name

- An AT command must be entered on a single line including parameters (numbers and symbols) following the command. On the Terminal Mode screen of the communication software, "one line" is from the first character to the character before .

Note

- In the Terminal mode, a PC functions as a communication terminal. Characters entered from the keyboard are sent to a line connected to a communication port.

AT Command List

The following AT commands can be used on the " L-05A" modem port.

- [&F] : A command to initialize settings used as AT&F command.
- [?][=?]: The current settings appear when adding " ?" at the end of the command, and the effective range of the current settings appears when adding " =?" at the end of the command.

Command	Overview	Parameters/Description	Comments Examples
AT&C<n>	Select the operating conditions of the circuit CD for DTE	n=0: Always keeps CD signal ON n=1 (default): CD changes depending on the other party's modem status.	AT&C1 OK
AT&F<n>	Reset the FOMA terminal AT command set values to factory defaults. If executed during a communication, the line is disconnected.	Only n=0 can be set (Skippable)	-
AT+CGDCONT [?] [=?]	Set APN when sending Packet communication.	Refer to P128	Refer to P128
AT+CGEQMIN [?] [=?]	Register criteria value for determining if QoS (Quality of Service) sent from network when PPP Packet communication is established, is acceptable or not.	Refer to P128	Refer to P128
AT+CGEQREQ [?] [=?]	Set QoS(Quality of Service) to request for the network when PPP Packet communication is established.	Refer to P128	Refer to P128
AT+CGMR	Display the version of the AT+CGMR FOMA terminal.	-	AT+CGMR 1234567890123 456 OK

Command	Overview	Parameters/Description	Comments Examples
AT+CGREG=<n> [&F] [?] [=?]	Set whether to be notified of the network registration status.	<n> n=0(default): Do not note. n=1: Notify when outside and inside the service area is changed. Execute [AT+CGREG?] then appears as [+CGREG:<n>,<state>] <state> 0:Not registered 1:Registered Home Network 4: Unknown 5: Registered (while roaming)	AT+CGREG? +CGREG: 0,1 OK AT+CGREG=? +CGREG: (0-2) OK
AT+CGSN	Display the serial number of the FOMA terminal.	-	AT+CGSN 12345678901 2345 OK
AT+CMEE=<n> [&F] [?] [=?]	Set the error report form of the FOMA terminal.	n=0: Display [ERROR] n=1: Display in the form of [+CMEE ERROR: xxxx] (where xxxx are numbers) n=2(default): Display in the form of [+CMEE ERROR: xxxx] (where xxxx are text) ※ If using ATZ or AT&F command to default, "0" is setup. Note that when connecting L-05A to power, the value of ATZ or AT&F command differs.	AT+CMEE=0 OK AT+CMEE? +CMEE: 0 OK AT+CMEE=? +CMEE: (0, 1, 2) OK

Command	Overview	Parameters/Description	Comments Examples
AT+ CNUM	Display the own number of the FOMA terminal	Executing [AT+CNUM] displays in the form of [+CNUM: <number>, <type>] number: phone number type=129: Excluding the international access code+ type=145: Including the international access code+	AT+CNUM +CNUM: "09080189242",129 OK
AT+COPS= [<mode> [,<format> [,<oper> [,<stat>]]] [?] [=?]	Select and set carrier's name/Plmn Number.	<mode> 0 : Auto (Searching network automatically and then change communication service) 1 : Manual (to connect <oper> communication service) 2 : Disconnection communication service ※Not supported 3 : Mapping don't excute. 4 : Auto manual (In case, to disconnect <oper>communication service that excute automatically) ※Not supported <format> 2 : Fixed number <oper> represents country code(MCC) plus network code(MNC). "44010" is displayed for MCC=440 and MNC=10	AT+COPS? +COPS: 0,0,"" ,2 OK AT+COPS=? +COPS: (2,"" ," " , " 44010" ,2) , (3,"" ," " , 44020" ,2) , (0,1,2,3,4) , (0,1,2) OK

Command	Overview	Parameters/Description	Comments Examples
AT+CPAS [=?]	Display FOMA terminal state	Displays in the form of [+CPAS : <n>] . n=0: Available to set AT commands. n=3: Available and receiving n=4: Available and receiving	AT+CPAS +CPAS:0 OK AT+CPAS=? +CPAS : (0,3,4) OK
AT+CPIN=" PIN" / AT+CPIN=" PUK" " PIN" [?]	Command to enter the PIN code or unblocking PIN code for FOMA card.	Enter the PIN1 code for " PIN" , and enter unblocking PIN code for " PUK" . Executing [AT+CPIN?] displays [+CPIN: <n>] . n=READY: Authenticated n=SIM PIN: Waiting for entry n=SIM PUK: Waiting for unblocking PIN1 code entry n=ERROR: Locked	(+CPIN:SIM PIN status) AT+CPIN=" 1234" OK (+CPIN:SIM PUK status) AT+CPIN=" 12345678" ," 1234" OK
AT+CUSD [&F]	Inquire the change or setting contents of Internet configuration related to the extra service.	Form : AT+CUSD=<n>,"<str>"[,0] n=0 : middle result Do not send <m>[<str>,<dcs>] (default) n=1 : middle result Send <m>[<str>,<dcs>] Middle result : m=0 : setting finishes m=1 : information requirement from network exists. str :0~9、#、*のみ使用可能。 <str>は""で囲む	AT+CUSD=0. "xxxxxxxx" OK AT+CUSD=1,"* 148*1* 0000#,0 +CUSD:0,"148* 7#,0 OK AT+CUSD=? +CUSD: 0 OK AT+CUSD=? +CUSD:(0-2) OK

Command	Overview	Parameters/Description	Comments Examples
AT*DANTE	Display the signal strength (number of antenna bars) of the FOMA terminal.	Result format: *DANTE:<m> m=0 : Out of the service area m=1 : State of 0 or 1 antenna bar displayed m=2 : State of 2 antenna bars displayed m=3 : State of 3 antenna bars displayed	AT*DANTE *DANTE:3 OK
AT+GCAP	Display the capability list of the FOMA terminal.	-	AT+GCAP +GCAP: +CGSM,+DS,+ES OK
AT+GMI	Display the manufacturer of the FOMA terminal.	-	AT+GMI LG Electronics Inc. OK
AT+GMM	Display the name of the FOMA terminal.	-	AT+GMM FOMA L05A OK
AT+GMR	Display the s/w version of the FOMA terminal.	-	AT+GMR L05A-01-Vxxx- 440-10 OK

Command	Overview	Parameters/Description	Comments Examples
AT+IFC=<n>.<m> [&F] [?] [=?]	Set the local flow control method between the PC and the FOMA terminal.	n : DCE by DTE control n=0 : No flow control. n=1 : Perform XON/XOFF control. n=2 (default): Perform RS/CS (RTS/CTS) flow control. m : DTE by DCE control. m=0 : Perform No flow control. m=1 : XON/XOFF control. m=2(default) : Perform RS/CS (RTS/CTS) flow control	AT+IFC=2, 2 OK AT+IFC? +IFC: 2,2 OK
AT+WS46=<n> [&F] [?] [=?]	Set the wireless network to be used by the FOMA terminal when dialing.	12: GSM 22: 3G (WCDMA) 25: GSM+3G (WCDMA)	AT+WS46? 25 OK
A/	Retry a command just before performing	 is not needed after entering command.	A/ OK
ATD	Sending packet	Sending packet : ATD*99*** <cid># <cid>1~10 : + Display the APN that configured +CGDCONT	ATD*99***3# CONNECT 7200000
ATE<n> [&F]	Set whether to echo back the text sent from a PC.	n=0 : Not echo back. n=1 (default) : Echo back.	ATE1 OK
ATI<n>	Display the recognition code	n=0 : Display [NTT DOCOMO] n=1 : Display the name of the FOMA terminal (Same as +GMM) n=2 : Display the FOMA terminal version (same as +GMR) n=3 : Display OK n=4 : Display the details of communication functions of the FOMA terminal.	ATIO NTT DoCoMo OK

Command	Overview	Parameters/Description	Comments Examples
ATS3=<n> [&F] [?]	Set the return character (CR) to recognize the end of AT command text string.	n=13 (default) : only n=13 can be specified.	ATS3=13 OK
ATS4=<n> [&F] [?]	Set the line feed (LF) character. It is positioned next to the return character (CR) if displaying the result code in alphanumeric characters.	Only n=10 (default) can be specified.	ATS4=10 OK
ATS5=<n> [&F] [?]	Set the back space (BS) character to delete the last character in the input buffer while AT commands are entered.	Only n=8 (default) can be specified.	ATS5=8 OK
ATV<n> [&F]	Set the display method of the result code.	n=0 :Display in numeric characters. n=1 (default): Display in text.	ATV1 OK
ATZ	Reset the settings on the FOMA terminal with the nonvolatile memory contents. If performed during a communication, the line is disconnected.	-	ATZ OK

Supplementary Explanation of AT Commands

■ Command name : +CGDCONT

- Overview
Set APN when sending packet connection.
- Form
+CGDCONT=[<cid>[," <PDP type>" [, " <APN>"]]]
- Parameter descriptions
Set the destination (APN) when sending packets. See the following examples for command operations.
<cid>*1 : 1~10
<PDP type>*2 : PPP or IP
<APN>*3 : Optional
※1 <cid> is the number used to control the destination (APN) for the packet communication to be registered in FOMA terminal. 1 to 10 can be registered. The default value of <cid>=1 is 「mopera.ne.jp」 and <cid>=3 is 「mopera.net」. Set cid to 2 or a number between 4 and 10.
※2 <PDP type> is a protocol for packet communication.
※3 <APN> is optional string that indicates each destination.
- Command examples
Command to register an APN with the name of abc (When PDP type is PPP, cid is 3)
AT+CGDCONT=2," IP" ," abc"
OK
- Operations without a parameter
AT+CGDCONT=
: Clear all the settings of <cid>.
However, the setting of <cid>=1 or <cid>=3 is reset to the value when purchasing.
AT+CGDCONT? : Display the current settings.

■ Command name: +CGEQMIN=[Parameter]

- Overview
Register the threshold to accept the QoS (Quality of Service) sent from the network when packet communication is established.
- Format
+CGEQMIN=<cid>[.,<Maximum bitrateUL>[,<Maximum bitrate DL>]]
- Parameter description
<cid>*1 : 1~10
<Maximum bitrate UL>*2 : None (default)
<Maximum bitrate DL>*2 : None (default)
※1 <cid> is a number used to manage the access point (APN) for the packet communication registered in the FOMA terminal.
※2 <Maximum bitrate UL> and <Maximum bitrate DL> indicate the minimum communication speed [kbps] of upload and download traffic respectively between the FOMA terminal and the base station. If these are set to None (default), all speeds are permissible. Be aware that a packet communication may not be established because any other speed than this is not permissible.
- Command examples
(1) Command to permit all speeds for both upload and download (When cid=2)
AT+CGEQMIN=2
OK
(2) Command to permit only 5,700kbps for upload and 7,232kbps for download (When cid=2)
AT+CGEQMIN=2,.5700,7232
OK
(3) Command to permit 5,700kbps for upload and all speeds for download (When cid=2)
AT+CGEQMIN=2,.5700
OK

(4) Command to permit all speeds for upload and only 7,232kbps for download (When cid=4)
 AT+CGEQMIN=4,...7232
 OK

- Operations without a parameter
 AT+CGEQMIN= : Reset all <cid> to their defaults.
 AT+CGEQMIN=<cid> : Reset the specified <cid> to its default.

■ **Command name: +CGEQREQ=[Parameter]**

- Overview
 Set the QoS (Quality of Service) requested to the network when packet communication is dialed.
- Format
 +CGEQREQ=[<cid>[,<Maximum bitrate UL>[,<Maximum bitrate DL>]]]
- Parameter description
 <cid>*1 : 1~10
 <Maximum bitrate UL>*2 : None (default)
 <Maximum bitrate DL>*2 : None (default)
 *1 <cid> is a number used to manage the access point (APN) for the packet communication registered in the FOMA terminal.
 *2 <Maximum bitrate UL> and <Maximum bitrate DL> indicate the minimum communication speed [kbps] of upload and download traffic respectively between the FOMA terminal and the base station. If these are set to None (default), all speeds are permissible. Be aware that a packet communication may not be established because any other speed than this is not permissible.
- Command example
 Command to require 5,700kbps for upload and 7,232kbps for download (When cid=2)
 AT+CGEQREQ=2,2,5700,7232
 OK

- Operations without a parameter
 AT+CGEQREQ= : Reset all <cid> to their defaults
 AT+CGEQREQ=<cid> : Set the specified <cid> as default.

Note

- This command, (+CGDCONT, +CGEQMIN, + CGEQREQ) is not reset by [G] and [Z], either.

Result Codes

■ **List of result codes**

Numeric display	Text display	Description
0	OK	Operation performed properly
1	CONNECT	Connected to other party
3	NO CARRIER	Line disconnected
4	ERROR	Unable to accept command

Troubleshooting

First, check whether software is required to update. Update software if necessary. (Updating Software⇒P135) Contact General Inquiries specified by DOCOMO located in "Repairs" at the last page of the manual if the symptom is not improved after confirming the check box.

- The FOMA terminal is not recognized

Symptom	Check
FOMA terminal is not recognized	Reinsert the FOMA terminal all the way into the USB port securely.
	Verify the L-05A Communication Configuration Files (Drivers) for the FOMA terminal functioning properly.→P35, P42
	Communication may fail and the FOMA terminal cannot be properly recognized and functioned, if the PC is started up or restarted with the FOMA terminal FOMA terminal left inserted in it. In this case, remove and reinsert the FOMA terminal. If communication fails even after the FOMA terminal is inserted again, remove it once, restart the PC, then insert the FOMA terminal into the PC again.
	When connecting the FOMA terminal with a USB port, if data communication is not available without being recognized, double click the "DOCOMO" icon recognized as a CD drive or start "L-05A connection software" or "DOCOMO connection manager" to recognize the FOMA terminal as a modem.
	The FOMA card will not be able to use if PIN1 unlock code is wrongly entered 10 times in a row. For further information, visit DOCOMO shop.

■ Communication problems

Symptom	Check
Communications are not possible	Verify that signals are received in the service area.
	In the setting of Send Caller ID does not conform to the provider's instructions, communication may not be performed.→ P74, P90
	Check if you set the FOMA Card Setting to " PIN1 unblocking" .→P69 If set to (PIN1 Lock), launch the L-05A connection software, then change FOMA card setting to " PIN1 unblocking" .→P71
	Check the property settings of the modem and the registration of the destination (APN)

■ Problems with AT Commands

Symptom	Check
[ERROR] appears when a command is entered	Verify that you entered a correct ATcommand.
	Check the properties of the terminal software to see whether a device other than the FOMA terminal is selected
[OK] does not appear after an AT command is entered.	Check the L-05A Communication Configuration Files (Drivers) have been installed and functioned properly.
	Verify that the commands start with "AT" or "at".

■ Other problems

Symptom	Check
The terminal stopped working suddenly	Verify that the FOMA CARD is properly inserted to FOMA terminal.→P19
	Your PC operating environments may have changed because a new peripheral or software was installed. Make a confirmation with manufacturer or maker of accessory or software.
The FOMA terminal is not detected if it is inserted into a USB port while installing the L-05A Communication Configuration Files (Drivers).	Please confirm the followings. <ul style="list-style-type: none"> • Whether the PC or OS you are using is in the latest condition? (If required, apply revision program of OS or a maker.) • Whether the FOMA terminal recognizes normally when other USB devices are inserted into the USB port? • Whether the FOMA terminal operates normally when being inserted into another PC? • Whether the FOMA terminal operates normally when being reset to its default? ※ : For inquiries related to OS or PC, contact Microsoft or PC manufactures.
	Internet connection speed decreased significantly

Error Messages

Error Messages	Description
圏外	You are out of service area or available network.
サービス地域ではありません。ネットワークを再検索しますか?	You may be out of service area or available network, or network error. Please do network setting again.
端末の認証に失敗しました。顧客センターまたは代理店にお問い合わせください。	Communication may fail and the FOMA terminal cannot be properly recognized if the PC is started up or restarted with the FOMA terminal left inserted in it. In this case, remove and reinsert the FOMA terminal. If communication fails even after the FOMA terminal is inserted again, remove it once, restart the PC, then insert the FOMA terminal into the PC again. Contact DOCOMO shop if the same problems persist.
データ通信中には設定できません。終了後に設定してください。	You cannot customize setting during data communication. Try again after closing data communication.
変更するPIN1コードと確認用のPIN1コードが異なります。	Two of new PIN1 are not identical each other. New PIN1 you want to change is not matched to the PIN1 you entered for verification purpose. Enter correct PIN1.
FOMAカードが挿入されているか確認してください。	Make sure to insert FOMA card into FOMA terminal before inserting to a PC.
FOMA端末が取り外されました。	Do not remove FOMA card while using FOMA terminal.
FOMA端末が取り付けられていません。	Verify the FOMA terminal is properly inserted into a PC. Verify that the FOMA terminal is properly recognized by the PC.
PIN1を複数回間違えたため使用できなくなりました。(PIN1 blocked) PIN1コードがロックされています。	An incorrect PIN1 was improperly entered 3 times in a row. Available functions will be limited. Enter PIN unblocking code to unlock.
PIN1コードが違います。残り(○/3)再入力可能です。再入力してください。	An incorrect PIN1 code has been entered. Enter the correct PIN1 code again
PIN1コードが間違えます。(PIN1コードは0123456789のみ使用できます。)	You can use 0,1,2,3,4,5,6,7,8,9 as a valid PIN1 code. Others are invalid.
PIN1コードは4~8文字です。	Valid PIN1 code is from 4 to 8 digit.

Error Messages	Description
PIN1コードの変更はPINロックが設定されているときに可能です。	To change the PIN1, PIN must be locked. Switch PIN unblocking to PIN blocking.
PINロック解除コードが違います。残り (〇/10) 回入力可能です。再入力してください。	An incorrect PIN was improperly entered 10 times in a row. Available functions will be limited. Please enter the contact unblocking PIN code
SMS送信に失敗しました。	You may be out of service or available network.You may encounter problems due to the network error.
PIN1ロック解除コードがブロックされているためFOMAカードを使用できません。顧客センターにお問い合わせください。	You are no longer able to use FOMA card that PIN unblocking code has been improperly entered 10 times in a row. Please contact DOCOMO shop.
FOMA端末の初期化に失敗しました。FOMA端末をリセットしてください。	Communication may fail and the FOMA terminal cannot be properly recognized, if the PC is started up or restarted with the FOMA terminal left inserted in it. In this case, remove and reinsert the FOMA terminal. If communication fails even after the FOMA terminal is inserted again, remove it once, restart the PC, then insert the FOMA terminal into the PC again.
送受信データなし。待ち受けモードに入ります。	When no data transmission has been incurred for a certain period of time. Communication will be resumed when data transmission is incurred, so stay as it is.

■ Replacement parts

Basically, replacement parts (parts required to maintain product function) will be kept in stock for at least 4 years after termination of production. Please note that the product may not be repaired even during this period, depending on the malfunctioning parts due to a shortage of those parts. Depending on the nature of the required repairs, it may still be possible to repair your terminal even after this period. Contact "Repairs" listed on the back of this manual.

Pay attention

- Do not modify the FOMA terminal, the FOMA card or its accessories.
 - Fire, injury or damage may result.
 - If the FOMA terminal is modified (part replacement, modification, painting, etc.), it will be repaired only after the modified parts have been restored to the condition at the time of purchase. However, repair may be refused depending on the nature of modification.
 - Using sticker to decorate the FOMA terminal.
 - Exchanging the packing with those other than DOCOMO product.
 - Repair of failures or damage caused by modification are charged even during the warranty period.
- Do not remove any inscription stickers attached to the FOMA terminal. The inscription stickers certify that the FOMA terminal satisfies specific technical standards. If stickers are removed intentionally or are reattached in such a way that confirmation of the sticker's contents is impossible, repair or servicing may be refused because confirmation of whether or not the device conforms to relevant technical standards cannot be made.

Updating software

Download the modification file of FOMA terminal from download site on the Internet and then update the software. If software update is necessary, you will be informed at the DOCOMO web site with "お知らせ (Information)".

Note

- Do not unplug the FOMA terminal with the computer during software update.
- Software update (downloading and rewriting) may take a while.
- If software update fails, all operations become unavailable. In this case, bring your FOMA terminal to a DOCOMO service center.

Main specifications

■ Operation system

Windows 2000 Professional Japanese version
(Service Pack 4 or later)
Windows XP Home Edition Japanese version
(Service Pack 2 or later)
Windows XP Professional Japanese version
(Service Pack 2 or later)
Windows Vista 32 bit Japanese version (Service Pack 1
or later)
Windows Vista 64 bit Japanese version (Service Pack 1
or later)
Mac OS X 10.4.11 Japanese version
Mac OS X 10.5.6 Japanese version

■ Communication Speed

Packet Communication:

Maximum receiving: 7.2Mbps (Best effort)

Maximum sending: 5.7Mbps (Best effort)

- ※ The maximum speed of 7.2Mbps for receiving and 5.7Mbps for sending is theoretical values and does not show the actual ones. The actual communication speed depends on communication environment and network congestion.
- ※ Out of High-Speed area, the maximum communication speed for receiving and sending is 384kbps

■ Operating environment

Temperature : 5°C~35°C

Humidity : 45%~85%

■ Power source

Power voltage

DC5V±5%(Supplied from PC)

Max Current consumption

Max Current consumption while communicating

3G: Approx. 550mA or below

GSM/GPRS: Approx. 300mA or below

Average Current consumption while communicating

3G: Approx. 180mA or below

GSM/GPRS: Approx. 170mA or below

Average Current consumption while Standby:

3G: Approx. 90mA or below

GSM/GPRS: Approx. 90mA or below

- ※ Depending on the usage, power consumption fluctuates.

■ Form factor

USB connection type

■ Dimensions

Height: approx. 80mm

Width: approx. 32mm

Depth: approx. 13mm

■ Weight

Approx. 37g

Export Controls of the Product and Accessories

Japan Export Control Regulations (“ Foreign Exchange and Foreign Trade Law” and relevant laws and regulations) and U.S. Reexport Regulations (Export Administration Regulations: EAR) apply to this product and its accessories. If you export or re-export this product or its accessories, please follow the necessary procedures at your own risk and expense. For details on the procedures, contact the Ministry of Economy, Trade and Industry or the U.S. Department of Commerce.

European Union Directives Conformance Statement



Hereby, LG Electronics, Inc. declares that this product is in compliance with:

- The essential requirements and other relevant provisions of Directive 1999/5/EC
- All other relevant EU Directives



The above gives an example of a typical Product Approval Number.

FCC Regulations

Statement

This equipment has been tested and found to comply with the limits for a class B digital device, pursuant to Part 15 of the FCC Rules. These limits are designed to provide reasonable protection against harmful interference in a residential installation. This equipment generates uses and can radiate radio frequency energy and, if not installed and used in accordance with the instructions, may cause harmful interference to radio communications. However, there is no guarantee that interference will not occur in a particular installation. If this equipment does cause harmful interference or television reception, which can be determined by turning the equipment off and on, the user is encouraged to try to correct the interference by one or more of the following measures:

- Reorient or relocate the receiving antenna.
- Increase the separation between the equipment and receiver.
- Connect the equipment into an outlet on a circuit different from that to which the receiver is connected.
- Consult the dealer or an experienced radio/TV technician for help.

Change or Modifications that are not expressly approved by the manufacturer could void the user's authority to operate the equipment.

Class B Compliance

This device and its accessories comply with part 15 of FCC rules.

Operation is subject to the following two conditions:

- This device & its accessories may not cause harmful interference.
- This device & its accessories must accept any interference received, including interference that may cause undesired operation.

Body-worn Operation

This Mobile Broadband USB Modem, model L-05A, is approved for use in normal size laptop computers only (typically with 12" or larger display screens). To comply with FCC RF exposure requirements, this modem should not be used in configurations that cannot maintain at least 5mm (approximately 0.2 inches) from users and bystanders, and 12mm (approximately 0.47 inches) from the top of the USB modem. This USB modem has been tested for compliance with FCC/IC RF exposure limits in the laptop computer(s) configurations with horizontal and vertical USB slots and can be used in laptop computers with substantially similar physical dimensions, construction, and electrical and RF characteristics. This USB modem must not be used with any other antenna or transmitter that has not been approved to operate in conjunction with this modem.

Consumer Information on SAR (Specific Absorption Rate)

THIS DEVICE MEETS THE GOVERNMENT'S REQUIREMENTS FOR EXPOSURE TO RADIO WAVES.

Your wireless device is a radio transmitter and receiver. It is designed and manufactured not to exceed the emission limits for exposure to radiofrequency (RF) energy set by the Federal Communications Commission of the U.S. Government. These limits are part of comprehensive guidelines and establish permitted levels of RF energy for the general population. The guidelines are based on standards that were developed by independent scientific organizations through periodic and thorough evaluation of scientific studies.

The standards include a substantial safety margin designed to assure the safety of all persons, regardless of age and health. The exposure standard for wireless devices employs a unit of measurement known as the Specific Absorption Rate, or SAR.

The SAR limit set by the FCC is 1.6W/kg.

- ※ Tests for SAR are conducted using standard operating positions specified by the FCC with the device transmitting at its highest certified power level, the actual SAR level of the device while operating can be well below the maximum value. This is because the device is designed to operate at multiple power levels so as to use only the power required to reach the network. In general, the closer you are to a wireless base station antenna, the lower the power output.

Before a device is available for sale to the public, it must be tested and certified to the FCC that it does not exceed the limit established by the government-adopted requirement for safe exposure. The tests are performed in positions and locations (e.g., worn on the body) as required by the FCC for each model.

The highest SAR value for this device when worn on the body is 1.3W/kg.

The FCC has granted an Equipment Authorization for this device with all reported SAR levels evaluated as in compliance with the FCC RF emission guidelines. SAR information on this device is on file with the FCC and can be found under the Display Gant section of <http://www.fcc.gov/> after searching on FCC ID BEJL05A. Additional information about Specific Absorption Rates (SAR) can be found on the Cellular Telecommunications Industry Association (CTIA) web-site at <http://www.wow-com.com>.

Intellectual Property Rights

Copyrights and Rights of Portrait

Without permission of the copyright owner you may not duplicate, modify, transmit over public communication lines, etc. any document, image, music, software, or other content owned by a third party that you have used this product to download from an Internet web site, etc., except for private uses such as duplication and indexing that are allowed by copyright law.