

User precautions	GB.3
General information	GB.5
General description	GB.5
Introduction to the controls	GB.8
Switch on/off	GB.13
Operate and use	GB.14
Volume	GB.17
Radio/AUX	GB.18
Listen to the radio	GB.18
Auxiliary audio sources	GB.22
Audio setting	GB.25
Navigation	GB.27
The navigation system	GB.27
Reading a map	GB.28
Enter a destination	GB.31
Guidance	GB.37
Map settings	GB.43
Managing the favourites	GB.44
Navigation settings	GB.46
Eco ² driving	GB.50
Bluetooth® device	GB.51
Pairing/unpairing Bluetooth® devices	GB.51
Connecting/disconnecting Bluetooth® devices	GB.54
Using voice recognition	GB.56
Phonebook	GB.60
Making, receiving a call	GB.61
Remote engine start-up	GB.64
Reversing camera	GB.67
System settings	GB.69
Updating the system	GB.72

PRECAUTIONS DURING USE (1/2)

It is essential to follow the precautions below when using the system, both in the interest of safety and to prevent material damage. You must always comply with the laws of the country in which you are travelling.



Precautions when operating the system

- Operate the controls (on the dash or near the steering wheel) and read the information on the screen only when road conditions allow.
- Set the volume to a reasonable level so that outside noise can be heard.

Precautions regarding navigation

- Use of the navigation system does not in any way replace the responsibility or vigilance of the driver when driving the vehicle.
- Depending on the geographical area, the map may not have the latest information on new roads. Be alert. In all cases, Road Traffic Regulations and road signs always take precedence over the directions of the navigation system.

Precautions concerning the equipment

- Do not attempt to dismantle or modify the system, as there is a risk of damage to equipment and fire.
- Contact a representative of the manufacturer in the event of malfunction and for all operations involving disassembly.
- Do not insert foreign bodies into the player.
- Do not use products containing alcohol and/or spray fluids on the area.

Precautions when using the phone

- There are laws which govern the use of phones in vehicles. They do not necessarily authorise the use of hands-free phone systems under all driving conditions: drivers must be in control of their vehicles at all times;
- Using a phone whilst driving is a significant distraction and risk factor during all stages of use (dialling, communicating, searching for a number in the handset memory, etc.).

PRECAUTIONS DURING USE (2/2)

The description of the models given in this manual is based on the specifications at the time of writing. **This manual covers all existing functions for the models described. Whether or not they are fitted depends on the equipment model, options selected and the country where they are sold. This manual may also contain information about functions to be introduced later in the model year.**

Depending on the make and model of your telephone, some functions may be partially or completely incompatible with your vehicle's multimedia system.

For more details, please consult an Authorised Dealer.

GENERAL DESCRIPTION (1/3)

Introduction

Your vehicle's multimedia system performs the following functions:

- RDS radio;
- DAB radio;
- management of auxiliary audio sources;
- Hands-free phone;
- voice recognition;
- navigation assistance;
- road traffic information (TMC);
- information on areas for particular care;
- parking distance control (reversing camera);
- remote engine start-up programming;
- information on your driving style and driving advice in order to optimise your fuel consumption.

Radio functions

The multimedia system can be used to listen to FM (frequency modulation), DAB (digital audio) and AM(amplitude modulation) radio.

The DAB system allows better sound reproduction and access to text information about the current programme etc.

The RDS system makes it possible to display the name of some stations or messages sent by FM stations to be displayed:

- general traffic information (TA);
- emergency message(s).

Auxiliary audio function

You can listen to your personal stereo directly through your vehicle's speakers. There are several ways of connecting your personal stereo, depending on the type of device you have:

- 3.5 mm Jack socket;
- USB audio;
- Bluetooth® connection.

For more information on the list of compatible devices, please contact an authorised dealer or visit the manufacturer's website if available.

GENERAL DESCRIPTION (2/3)

Hands-free phone function

The Bluetooth® hands-free system provides the following features without having to handle your phone:

- send/receive/suspend a call;
- consult the list of contacts from the phone memory;
- access the call logs for calls which have come through the system;
- dial emergency numbers.

Telephone compatibility

Some phones are not compatible with the hands-free system, and do not enable you to use all of the available functions or do not provide the best possible sound quality.

For more information on compatible phones, contact an authorised dealer or visit the manufacturer's website if available.

Remote engine start-up function

When fitted, this function lets you programme the engine to start remotely, in order to heat or ventilate the passenger compartment up to 24 hours before using the vehicle.

Driving eco2

The "Driving eco2" menu displays a real-time overall score that reflects your driving style.

Navigation assistance function

The navigation system automatically calculates the geographical position of the vehicle by receiving GPS signals. It suggests a route to your chosen destination using its road map. Finally, it indicates the route to take, step by step, using the display screen and voice messages.

TMC traffic information

This function keeps you informed about traffic conditions in real time.

Road safety alerts or alert points

This service allows you to receive alerts in real time, such as excess speed alerts or the position of road safety alert areas.



Your hands-free phone system is only intended to facilitate communication by reducing the risk factors, without removing them completely. You must always comply with the laws of the country in which you are travelling.

GENERAL DESCRIPTION (3/3)

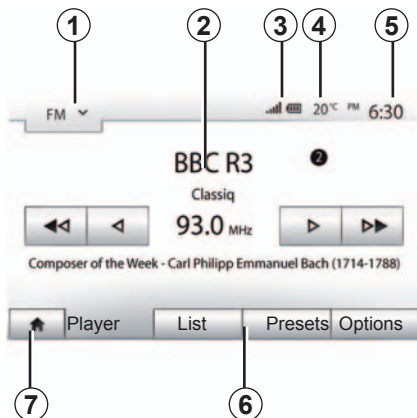

Displays

Menu screen

- 1** Mode selection area:
- displays the selected mode;
 - when the mode selection area is touched, a drop-down menu will appear.
- 2** Area Table of Contents:
- shows the contents of a menu item and related information.
- 3** Telephone information area:
- if the Bluetooth® system is activated, the reception and battery level of the connected device will be displayed.

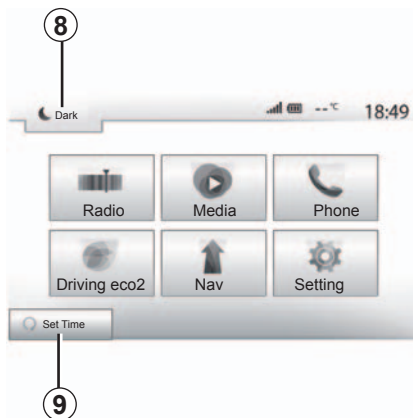

4 Exterior temperature.

5 Time area.

6 Menu area:

- display subordinate menu of mode;
- shows current menu as highlighted.

7 Area Home or return to navigation.

- Depending on the mode you are in, this area displays:
- the Home button: returns you to the welcome screen;
 - the Back button: goes back to the previous screen;
 - the Flag button: goes back to the navigation screen.

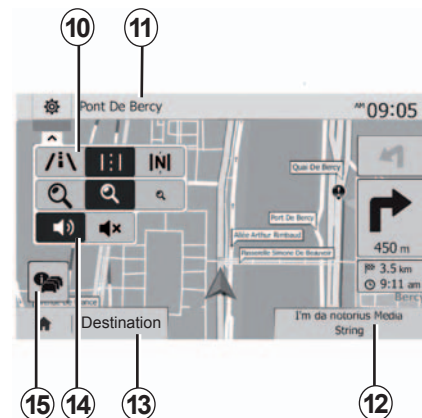

8 Mode standby and clock display

9 Area for selecting programmed engine start-up

Navigation screen

10 Map mode (2D/3D and 2D North).

11 Name of the next street to take on your route.

12 Current audio information.

13 Options for route and map setting.

14 Voice guidance On/Off.

15 Traffic information (TMC).

INTRODUCTION TO THE CONTROLS (1/5)

System panels

Screen selections are made by touching the desired selection on the screen.

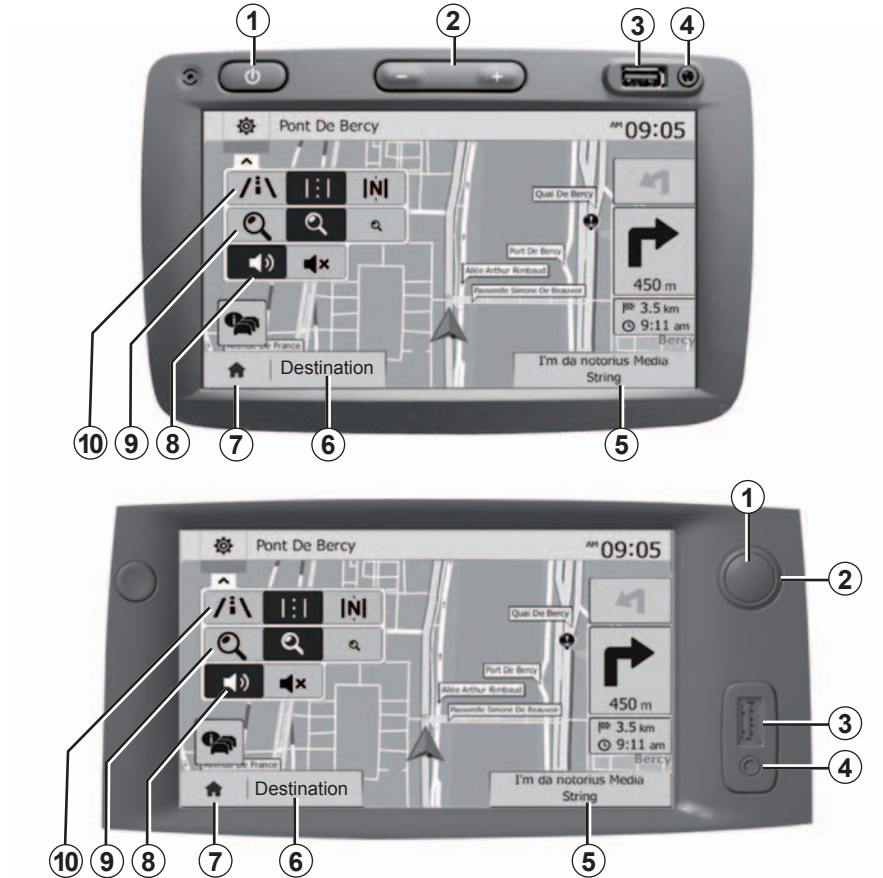

INTRODUCTION TO THE CONTROLS (2/5)

Steering column controls

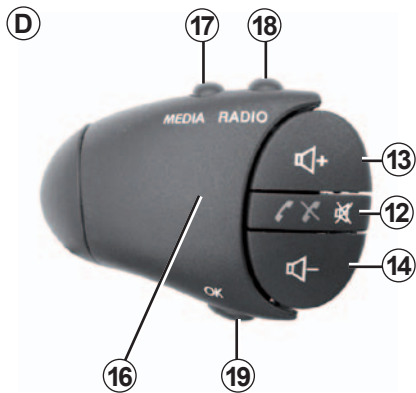
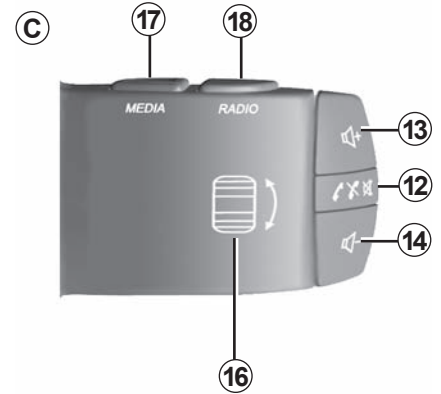
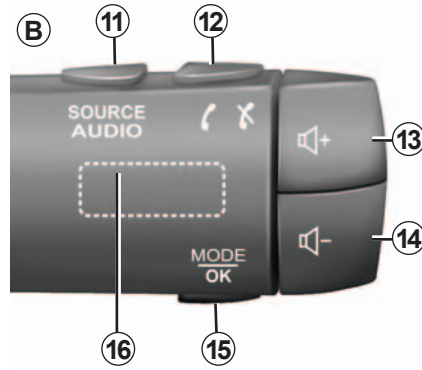
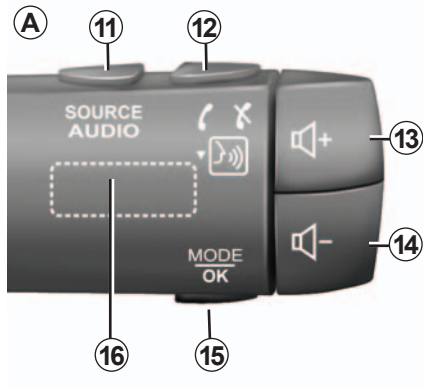

INTRODUCTION TO THE CONTROLS (3/5)

Steering wheel controls

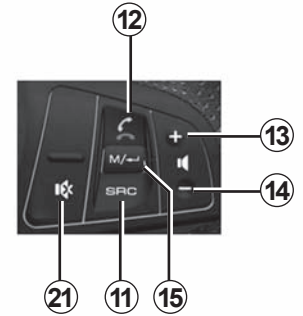
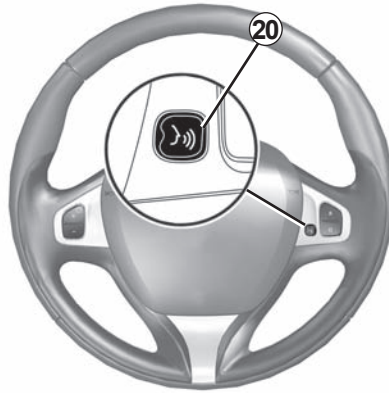

INTRODUCTION TO THE CONTROLS (4/5)

	Function
1	Brief press: standby screen ON/OFF.
2, 13, 14	Adjust the volume.
3	USB. connection
4	3.5 mm Jack socket.
5	Access the media currently playing (FM/AM/DAB/USB/iPod®/Bluetooth®/AUX).
6	Access the “Navigation” menu.
7	Access the “Home” menu.
	Telephones or auxiliary sources: exit the current window to return to the navigation screen (current) or to the previous screen.
8	Mute/unmute the voice guidance.
9	Change the map zoom.
10	Change the map view mode (2D/3D/2D North).
11	Choose audio source (FM/AM/DAB/USB/iPod®/Bluetooth®/AUX).

INTRODUCTION TO THE CONTROLS (5/5)

	Function
12	<p>When receiving a call:</p> <ul style="list-style-type: none"> – Brief press: answer the call; – Long press: reject the call. <p>Brief press during a call: end call.</p> <p>Listening to an audio source: mute/unmute (only for controls C, D and E).</p> <p>Brief press: access “Phone” menu (only for controls A and B).</p> <p>Long press: activate/deactivate multimedia system voice recognition (only for control A).</p>
13+14	Mute/unmute (only for controls A and B).
15, 19	<p>Radio: change radio station play mode (“Main”, “List”, “Presets”).</p> <p>Media (USB / iPod): change play mode for the media currently playing (“Main” or “List”).</p>
16	<p>Rear dial:</p> <ul style="list-style-type: none"> – Radio: change radio mode (preset/list/frequency). – Media: previous/next track. <p>Brief press: confirm an action (only for control C)</p>
17	Change media (CD/USB/AUX).
18	<ul style="list-style-type: none"> – Change radio mode (FM/AM/DAB); – long press: activate/deactivate multimedia system voice recognition.
20	<p>Brief press: activate/deactivate multimedia system voice recognition.</p> <p>Long press: activate/deactivate voice recognition for your phone if it is connected to the multimedia system.</p>
21	Listening to an audio source: mute/unmute.

ON/OFF SWITCH



Switching on

The multimedia system switches on automatically when the ignition is switched on.

In other cases, press button **A** to switch on the multimedia system.

With the ignition off, you can use the system for twenty minutes.

Press **A** to make the multimedia system operate for around a further twenty minutes.



Switching off

The system switches off automatically when the vehicle's ignition is switched off.



Standby screen

The standby clock mode allows the display screen to be switched off.

When in standby clock mode, the radio or guidance system does not operate.

The standby screen displays the time and exterior temperature.

Briefly press **A** to activate/deactivate the standby screen.

OPERATE AND USE (1/3)



Touchscreen 1

Tap (short press):

- Item selection;
- Item execution (Media playing screen).

From the “Media” > “Player” menu, pressing the next button switches to the next title.



Press and Hold (long press):

- saving an item (radio station for example).

From the “Radio” > “Main” menu, pressing and holding the preset number stores the radio station currently playing.

- Fast scroll.

When touching with long presses the list down buttons, scroll (per page) with acceleration.

- fast-forward or rewind (Media playing screen).

From the “Media” > “Player” menu, pressing and holding the “Fast forward/rewind” button fast forwards/rewinds the track playing.

OPERATE AND USE (2/3)

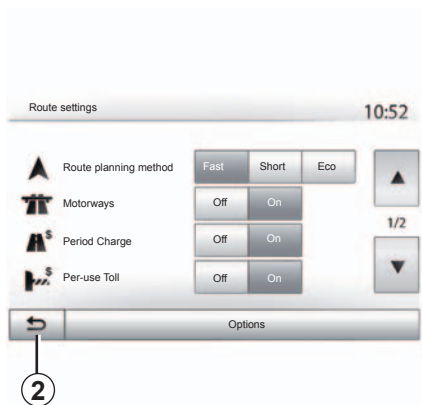

Return to the “Home” menu.

The system goes directly to the “Home” menu if you press and hold **2** or briefly press **3** wherever you are in the system.

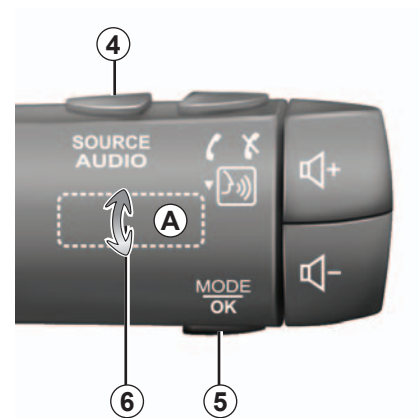

Audio: using the steering column controls

Press button **5** to change the radio station search mode.

Rotate wheel **6** to change the station (movement **A**).

Press **4** to change the source (USB, AUX, AM, FM, DAB, iPod® and Bluetooth®).

OPERATE AND USE (3/3)

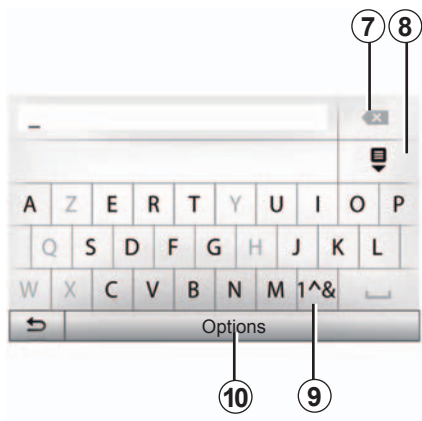

Using an alphabetical keyboard

When entering a heading using an alphabetical keyboard, choose each letter using the keypad.

When choosing each letter, the system will remove the brightness of certain letters to help entering them.

Press **7** to delete the last character entered.

Press **8** to display the list of results.

Press **9** to use numbers or symbols.

Press **10** to change the keyboard configuration.

VOLUME

Volume

Adjust the sound level when listening to the different sources, messages, ringtones and phone communications:

- by turning or pressing button **1** on the front panel of the multimedia system;
- by pressing control **13** or **14** on the steering column control.

To adjust this function, please refer to the information on “Audio preferences” in the section on “Audio settings”.

The radio source being listened to is interrupted when “TA” traffic information, news bulletins or a warning message is received.



Set the volume to a reasonable level so that outside noise can be heard.

Mute

To mute the sound, briefly press button **21** on the steering wheel control or **12** on the steering column control (only for controls **C**, **D** and **E**) or simultaneously press buttons **13** and **14** on the steering column control (only for controls **A** and **B**).

The “MUTE” icon is displayed at the top of the screen to indicate that the sound is switched off.

To continue listening to the current audio source, briefly press button **21** on the steering wheel control or **12** on the steering column control (only for controls **C**, **D** and **E**) or simultaneously press buttons **13** and **14** on the steering column control (only for controls **A** and **B**).

This function is deactivated automatically when the volume control is used or when a news or road traffic bulletin is broadcast.

Volume adjustment according to speed

When this function is activated, the audio and navigation volume will vary according to the vehicle speed.

To activate and adjust this function, please refer to the information on “Speed dependent volume control” of the section on “Audio settings”.

LISTENING TO THE RADIO (1/4)

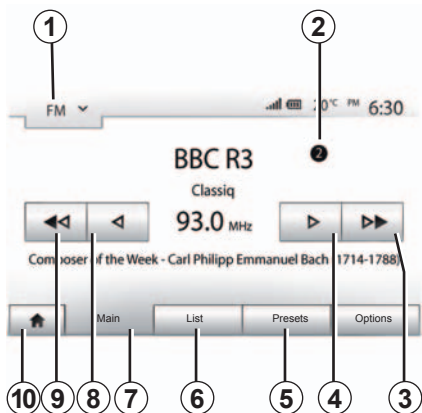

Selecting a wavelength

To choose a waveband:

- press **1**;
- choose the waveband “FM”, “AM” or “DAB” by pressing on the required band.

Choose a radio station “FM”, “AM” or “DAB”.

There are different modes for choosing a radio station.

After having selected the wavelength, select the mode by pressing tabs **5**, **6** or **7**.

Three search modes are available:

- “Main” mode (tab **7**);
- “List” mode (tab **6**);
- “Presets” mode (tab **5**).

These modes can be changed using the steering column control.

Note: the **2** marker indicates the position in your saved list of the radio station currently playing.

“Main” mode

This mode allows stations to be searched for either manually or automatically by scanning the selected range of frequencies. Select “Frequency” mode by pressing **7**.

To scan the frequency range:

- manually run through the frequencies in steps by repeatedly pressing **4** or **8**;
- automatically go to the next station by pressing **3** or **9**;

Repeat the operation each time the search stops if necessary.

You can also move the control knob on the steering column control to move to the next station.

Note: to go back to the welcome screen, press the **10** button.

LISTENING TO THE RADIO (2/4)

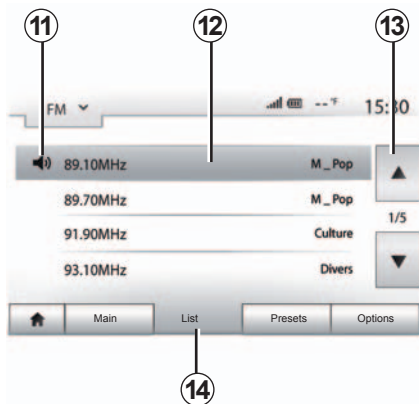

“List” mode

Select “List” mode by pressing **14**.

This operating mode allows you to find a station easily by name from an alphabetical list (on “FM” and “DAB” only).

Select the station required by pressing zone **12**.

Press **13** to scroll through all the stations.

Note: the **11** symbol indicates the station you are currently listening to.

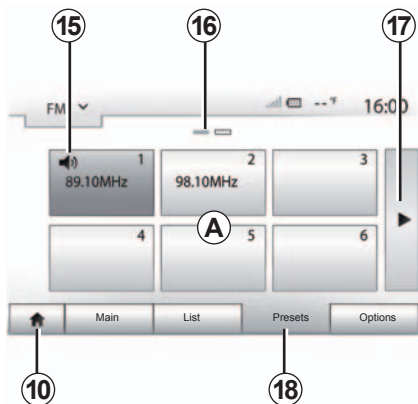

The names of the radio stations that do not use RDS will not appear on the screen. Only their frequency is displayed and sorted at the end of the list.

“Presets” mode

Select “Presets” mode by pressing **18**.

This mode allows you to recall on demand those stations which you have already stored (refer to information on “Saving a station” in this section).

Press one of the buttons in zone **A** to choose the saved stations.

Note: to go back to the welcome screen, press the **10** button.

Storing a station

Select a radio station by using one of the modes described above. Press and hold one of the buttons on the zone **A**.

You can save up to twelve stations per waveband.

Note: the **15** symbol indicates the station you are currently listening to.

Marker **16** indicates the number of pages in this section.

To move to the next page, press button **17**.

LISTENING TO THE RADIO (3/4)



Radio settings

Display the settings menu by pressing **19**. You can activate or deactivate functions by pressing “On” or “Off” (the setting menu varies depending on the waveband).

The available functions are as follows:

- “RDS”;
- “TA” (traffic information);
- “Region”;
- “News”;
- “AM”;
- “DLS”;
- “Announcement”;
- “Update List”.

“RDS”

Some “FM” and “DAB” radio stations broadcast text information relating to the programme being listened to (the name of a track, for example).

Note: This information is only available for certain radio stations.

“TA” (traffic information)

When this feature is activated, your multimedia system looks for and plays traffic bulletins automatically as new reports are issued by some radio stations “FM” and “DAB”.

Note: The automatic broadcasting of traffic information is deactivated when the audio system is set to the “AM” band.

Traffic information is broadcast automatically and has priority over the source being listened to at the time.

Select “On” to activate this function or “Off” to deactivate it.

LISTENING TO THE RADIO (4/4)

“Region”

The frequency of an “FM” radio station may change depending on the geographical area.

In order to keep listening to the same radio station when changing region, activate the “Region” function so that your multimedia system can automatically retune the frequency.

Note: this is only available for certain radio stations.

Note: “Region” is available only if the “RDS” function is activated.

Poor reception can sometimes cause erratic and annoying changes in frequency. In this case you should deactivate this function.

Select “On” to activate this function or “Off” to deactivate it.

“News”

When this function is activated, it is possible to automatically listen to news as it is broadcast by certain “FM” or “DAB” radio stations.

If you then select the other sources, when a broadcast of the selected programme type is made, it will interrupt the other sources.

Select “On” to activate this function or “Off” to deactivate it.

“AM”

You can activate or deactivate the “AM” band.

Select “On” to activate this function or “Off” to deactivate it.

“DLS”

Some radio stations broadcast text information relating to the programme being aired (the title of a track, for example).

“Update List”

To update the list of stations and obtain the most recent ones, press “Start”.

Note: preferably update the “DAB” list as soon as your system is switched on.

AUXILIARY AUDIO SOURCES (1/3)

Your system has two types of auxiliary inputs:

- for connecting an external audio source (MP3 player, portable music player, USB key, phone, etc).
- with Bluetooth® (Bluetooth® audio player, Bluetooth® phone).

To find the input position, please refer to the section on “Introduction to the controls”.

Operating and connection principles

There are two types of connections:

- a USB socket;
- a Jack socket.

Connect your portable audio player, depending on the type of device.

Once you have connected a USB socket or jack, the system automatically detects the auxiliary source.

Note: The USB key used must be formatted to FAT32 format and have a maximum capacity of 32Gb.



Selecting an auxiliary source

To select an input source, press **1**.

A list of available input sources is displayed instantly:

- USB: USB key, MP3 reader, phone, etc.;
- iPod®: device with integrated iPod®;
- BT: Bluetooth® devices;

- AUX: 3.5 mm jack.

In navigation mode or when listening to the radio, select your auxiliary audio source by pressing “Home”, then “Media”.

The system starts playing the last audio track played.



Only handle the portable audio player when traffic conditions permit.

Store the portable audio player safely while driving (risk of being thrown in the event of sudden braking).

AUXILIARY AUDIO SOURCES (2/3)

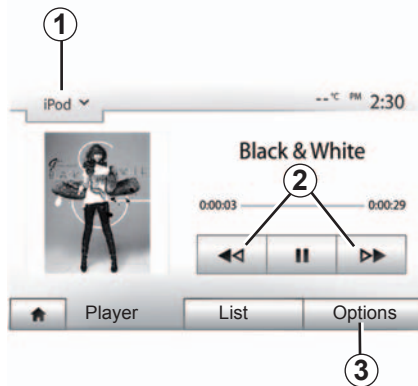

Audio formats

Auxiliary audio source formats can be MP3 and WMA.

Fast winding

Long press **2** to fast forward or rewind. Playback resumes when the button is released.

Repeat

This function enables you to repeat one or all tracks. Press **3**, then "Off", "Track", "Folder" or "All".

Shuffle

This function lets you play all songs in shuffle mode. Press **3** and then press "On" or "Off".

Auxiliary input: USB socket, Bluetooth®

Connection: USB and portable digital audio player

Connect the socket of your portable audio player to the USB input on the unit.

Once the USB socket of the digital portable audio player is connected, the "USB" menu is displayed.

Note: Some types of portable digital player may not be able to be connected.

Charging with the USB port

Once your player's USB socket is connected to the USB port of the unit, you can charge or maintain the battery during use.

Note: some devices do not recharge or maintain battery charge level when they are connected to the USB port on the multimedia system.

Connection: iPod®

Connect the socket of your iPod® to the USB input on the unit. Once the USB socket of your iPod® is connected, the "iPod" menu is displayed.

Use

Select "iPod" from the drop-down list **1**, then press on the playback list or the desired audio track on the multimedia system screen.

All audio tracks on your "iPod" can be selected directly on the multimedia system screen.

Note: Once connected, you will no longer be able to control the audio directly from your "iPod". You must use the keys on the system's front panel.

Note: Use the iPod® cable for exclusive use of an iPod® when connecting an iPod® to the USB socket.

AUXILIARY AUDIO SOURCES (3/3)

Connection: Bluetooth®

Refer to the section on “Connecting/disconnecting Bluetooth® devices”. Once the Bluetooth® is connected, the “BT” menu is displayed.

Use

Select “BT” from the drop-down list **4**, then press on the playback list or the desired audio track on the multimedia system screen.

All the audio tracks on your Bluetooth® device can be selected directly from the multimedia system screen.

Note: Once connected, you can no longer directly control your portable digital audio player. You must use the keys on the system’s front panel.

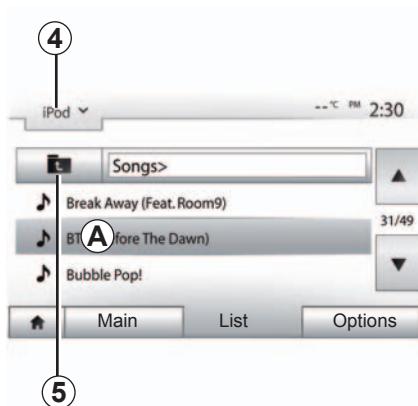

Selecting a track

To select an audio track within a folder, press “List”, then select a track **A** from this list.

To go back to the previous level in the folder hierarchy, press **5**.

By default, albums are listed in alphabetical order.

Depending on the type of digital portable audio player, you can refine your selection by using folders or files.

Note: Use a USB connection in preference for easier music searches.

Auxiliary input: jack

Connection

Connect the jack of your portable audio player to the jack input.

Use

Select “AUX” from the drop-down list **4**, then select the desired track on your music player. No indication of the name of the artist or the track is displayed on the system’s screen.

Select tracks directly on your portable player when the vehicle is stationary.

The sound quality from the analogue input (AUX) will usually be lower than the sound quality from digital inputs (USB, Bluetooth®).

AUDIO SETTINGS (1/2)

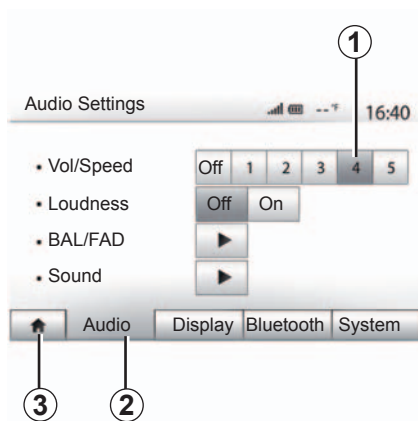

Display the settings menu by pressing “Home” > “Setting”. Press **2** to access the audio settings.

You can leave the settings menu and return to the welcome page by pressing **3**.

Volume adjustment according to speed (“Vol/Speed”)

When the speed of your vehicle is more than (40 km/h) 25 mph, the volume level outputs higher than original volume level.

Adjust the volume/speed ratio by pressing one of the buttons in zone **1**.

You can deactivate this function by pressing “Off”.

“Loudness”

Press “On” or “Off” to activate/deactivate the loudness function, which accentuates the bass and treble.

AUDIO SETTINGS (2/2)

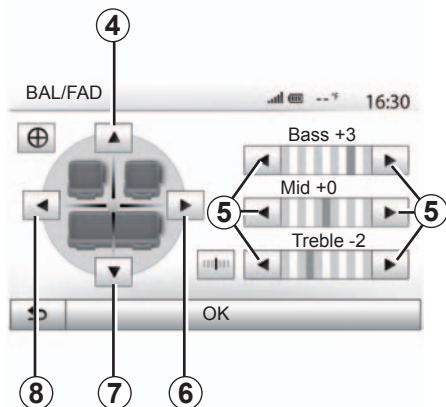

Right/left and front/rear balance

Tap **6** or **8** to adjust the sound the left/right balance.

Tap **4** or **7** to adjust the sound the front/rear balance.

After setting balance, press “OK” to confirm.

Bass, Mid, Treble

Press the **5** arrows to adjust the bass, medium and treble.

Once the adjustments have been made, press “OK” to confirm.

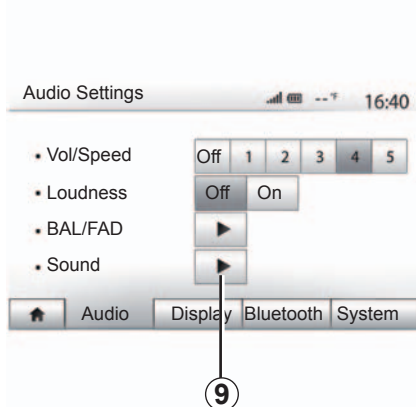

Audio preferences

Display the audio preferences menu by pressing **9**.

You can adjust the volume of each sound independently.

- “Audio”;
- “TA”;
- “Navigation”;
- “Phone”;
- “Ring” (telephone).

To do this, press “+” or “-”.

Press **11** to reset all the audio preferences.

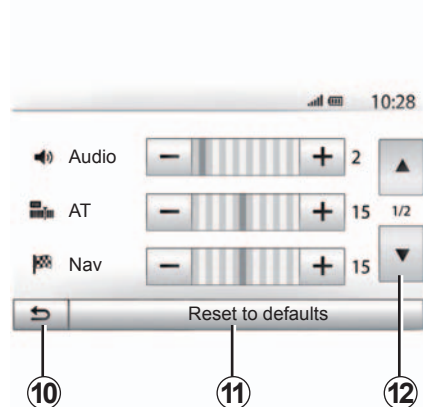

Press **12** to move to the next page.

Tap **10** to go back to previous screen.

THE NAVIGATION SYSTEM

The navigation system

The navigation system calculates your position and guides you by using data:

- of the GPS receiver;
- from the digital map.

GPS receiver

The navigation system uses GPS (Global Positioning System) and GLONASS satellites orbiting the Earth. The GPS receiver receives signals transmitted from several satellites. The system can then locate the position of the vehicle.

Note: After moving a long distance without driving (ferry, rail freight), the system may take several minutes to adjust before retuning to normal operation.

Updates (especially of maps) are published regularly. In some cases, it is possible that roads alter and that the mapping is not yet up to date.

Note: we recommend installing Naviextras Toolbox software on your computer and updating your system regularly.

The digital map

The digital map contains the road maps and town maps that the system requires.

USB key “Map”

To install the most recent version, please refer to the section on “Map updates”.

Note: The USB key is not provided with the system.

Note: The USB key used must be formatted to FAT32 format and have a maximum capacity of 32Gb.

If possible, always use the most recent version.

Insert USB key

Insert the USB key into the port USB **1** on the front panel of the multimedia system.



READ A MAP (1/3)

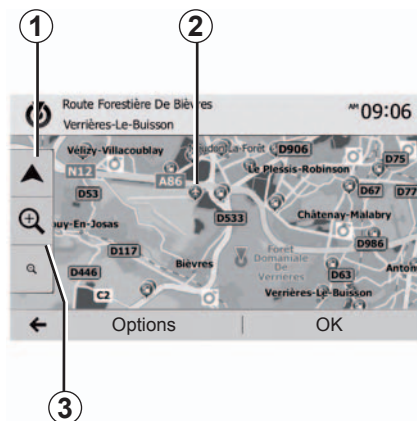

Displaying the map

To display the map around the current vehicle position, press “Home” > “Nav”.

Touch the map screen.

To move around the navigation map, drag the desired direction on the screen. Press **1** to return to your current position.

Press **3** to zoom in or out.

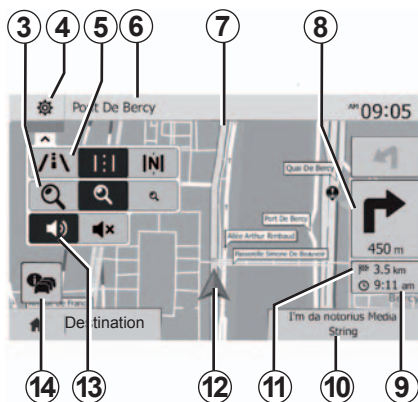

Map key

- 4** Navigation display options.
- 5** Access different display modes:
 - 3D mode;
 - 2D mode;
 - 2D North mode (the top of the map always faces north).
- 6** Name of the next major road or road sign information.
- 7** Route calculated by the navigation system.
- 8** Distance to and direction of next change of direction.

- 9** Estimated time of arrival.
- 10** Media currently playing.
- 11** Distance remaining to the destination.
- 12** Location of the vehicle on the navigation map.
- 13** Mute/unmute the voice guidance.
- 14** Traffic information. Press this area to find out about the different incidents present on your route.

Position GPS

This function makes it possible to find out the geographical location of the selected position (Address/latitude/longitude).

Touch desired position on the screen. Press “Options” and then press “News” to find out the exact location of the selected position.

Map icons

The navigation system uses symbols **2** to display points of interest (POI). Refer to the information on “Displaying points of interest” in the section on “Map settings”.

READ A MAP (2/3)

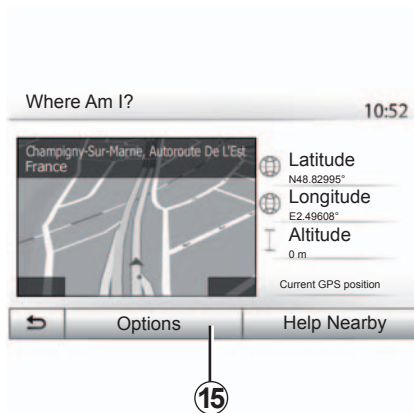

“Where Am I?”

This function allows you to check information about the current position and to search for POI nearby. It operates when GPS is activated.

Press “Options” on the map screen then “Where Am I?”.

This screen includes the following information:

- Latitude;
- Longitude;
- Altitude;
- house number;
- Current address.



Country information

Press **15** then “Country Info”.

This function allows you to view country information depending on your current position.

This screen includes the following information:

- speed limit.

Speed limits are displayed for major roads. Displayed unit depends on active regional settings. If no data is available, then “--” is shown instead of table and number.

- Phone country code;
- emergency number;
- legal Restrictions effective in the country:
 - maximum permitted blood alcohol level;
 - high-visibility vest required;
 - fire extinguisher required;
 - headlights must be on at all times;
 - spare bulbs required;
 - first aid kit required;
 - warning triangle required;
 - helmets required for motorcyclists;
 - snow chains required in winter;
 - snow chains recommended in winter;
 - winter tyres required in winter;
 - winter tyres recommended in winter.

READ A MAP (3/3)



« Help Nearby »

This function allows you to search for assistance near your current position.

Press **16** to open a new screen for the quick search.

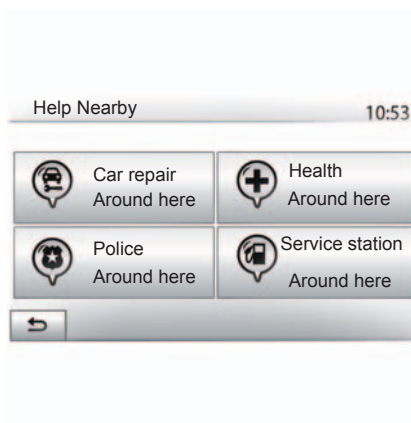

Information on this screen:

- car repair services;
- medical and emergency services;
- police stations;
- petrol stations.

To search for a destination from this screen, please refer to the section on “Entering a destination” and the information on “Selecting points of interest (POI)”.

ENTERING A DESTINATION (1/6)

Destination menu

Press “Home” > “Nav” > “Destination” to access the destination menu.

The destination menu offers several methods to enter a destination:

- enter an address (complete or partial);
- select an address from “Points of interest”;
- select a destination from the previous destinations;
- select an address from the Favourites;
- select for destination by using the map;
- select a latitude and longitude.

Entering an address

To enter an address, press **1**.

This item allows you to enter all or part of the address: country, town, street and house number.

Note: only addresses known to the system through the digital map are authorised.

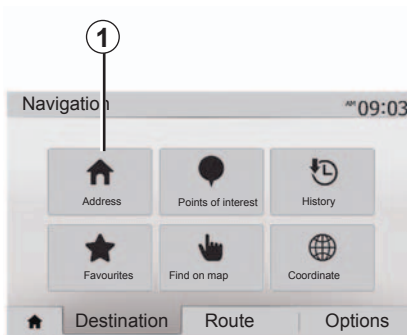

When using for the first time:

- press “Country”;
- enter the name of the country required using the keypad.

When entering the address the system will remove the brightness of certain letters to help enter the address.

The system may suggest several country lists by pressing **2**. Select the required country in the lists.

- Do the same for “Town/Area”, “Street”, “Cross street” and “Street number”.

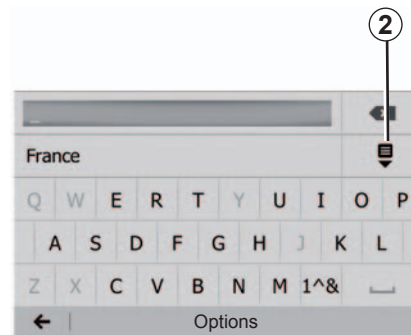

Note: “Cross street” and “Street number” can be activated after selecting “Street”.

Note: when entering the street, it is not necessary to specify the type of road (street, avenue, boulevard, etc.).

Note: The system stores previous addresses in its memory. Once you have entered a destination by address, that address will be displayed when the device is next used.

ENTERING A DESTINATION (2/6)



Select from the “Points of interest” (POI)

You can select your destination from the points of interest.

You can find a place in different ways:

- with the quick search feature, you can quickly find a nearby place by its name;
- with the preset search feature, you can find frequently searched types of places with only a few touches of the screen;
- you can search for a place by its category.

Quick search for points of interest

The quick search feature lets you quickly find a place.

Press the map somewhere to search for points of interest. Depending on your position, one or more **3** points will be displayed on the screen.

Press **4** and then “Points of interest around cursor” to show the list of points of interest with names and distance from the place selected.

Searching for points of interest using preset categories

The preset search feature lets you quickly find the most frequently selected types of places.

Press “Home” > “Nav” > “Destination” > “Points of interest” to access preset categories.

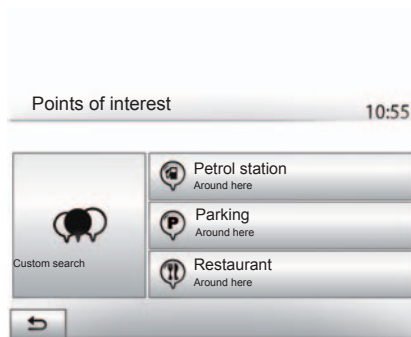

Categories (petrol station/parking/restaurant)

- If an active route exists, the points of interest “Petrol station” and “Restaurant” are searched for along the route. Point of interest “Parking” is searched around the destination.
- If there is no active route (destination is not selected), they are searched around the current position.
- If the current position is not available either (no GPS signal), they are searched around the last known position.

ENTERING A DESTINATION (3/6)

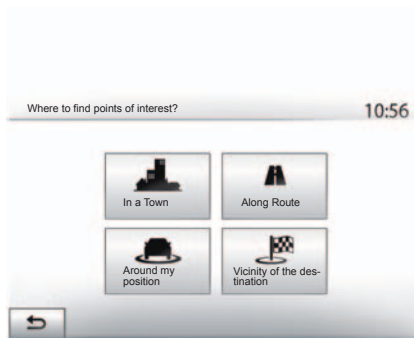

Searching for Points of Interest by category

You can search for points of interest by their categories and subcategories.

Press "Home" > "Nav" > "Destination" > "Points of interest" > "Custom search".

Select the area around which the place should be searched for:

- Press "In a Town" to search for a place within a selected town/suburb (the result list will be ordered by the distance from the centre of the selected city/town).

- Press "Along Route" to search along the active route, and not around a given point. This is useful when you search for a later stopover that results in a minimal detour only, such as searching for nearby petrol stations or restaurants (the result list will be ranked by the length of the necessary detour).
- Press "Around my position" to search around the current position or if it is not available, around the last known position (the result list will be ordered by the distance from this position).
- Press "Vicinity of the destination" to search for a place around the destination of the active route (the result list will be ordered by the distance from the destination).

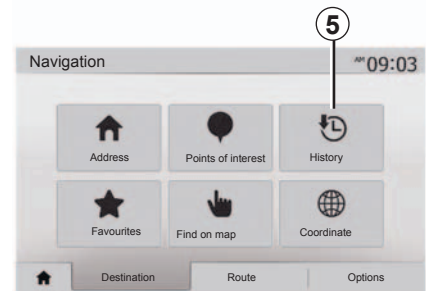

Selecting a destination from the previous destinations

Press **5** to find a destination you have previously defined.

ENTERING A DESTINATION (4/6)

Selecting an address from the Favourites

You can find the destination to a location stored in the Favourites. To utilize this function more effectively, we recommend that you save destinations to which you often travel in advance.

Firstly, save the favourite destinations by searching for the address. Please refer to the section on “Managing favourites”.

Press “Home” > “Nav” > “Destination” > “Favourites” to display the list of favourite destinations.

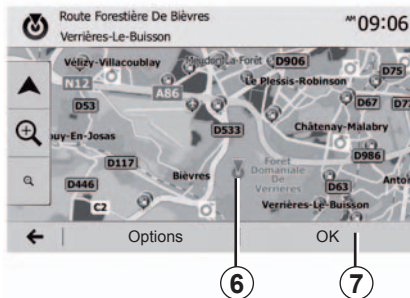

Selecting for destination by using the map

This allows you search for a destination by scrolling the map.

- Press “Home” > “Nav” > “Destination” > “Find on map” to select the destination on the map.
- Then press on the location on the map that you want to select as your destination. Point **6** is displayed;
- press **7** to confirm.

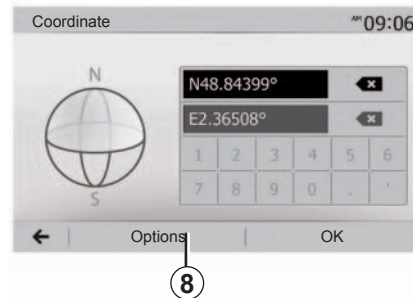

Entering the coordinate of the destination

This allows you search for a destination by entering its coordinate.

Press “Home” > “Nav” > “Destination” > “Coordinate”.

You can enter the latitude and longitude values in any of the following formats: decimal degrees; degrees and decimal minutes; or degrees, minutes and decimal seconds.

Press **8** and then UTM to enter the coordinates in UTM format.

ENTERING A DESTINATION (5/6)

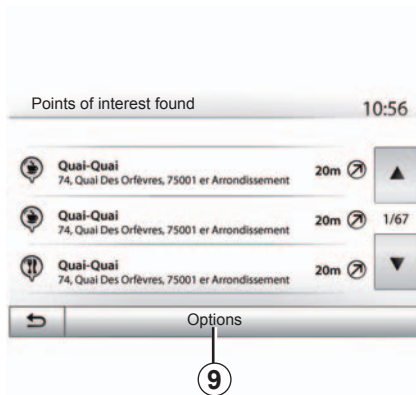

Sorting the list

The result of searching a destination by point of interest, history and favourites can be sorted by name and distance. If an active route exists, they can be sorted by detour. Press **9** to display the map on the screen.

Finding a destination by names

In case of selecting a destination by point of interest, history or favourites, you can search for destination in the list by their names. Press "Find" and enter the name using the keypad.

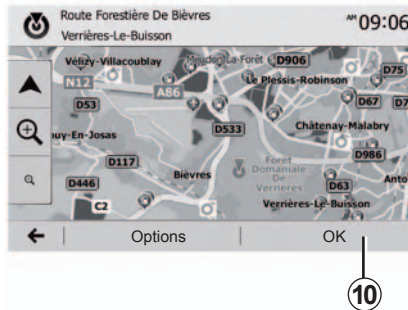

Confirming the destination

There are several possible options before confirming a destination:

- "OK";
- "Options".

A 10 second countdown will start. If you perform no action during this time, guidance will begin automatically.

"OK"

- If there is no active route (destination is not selected), press **10** to confirm the destination as a new route.

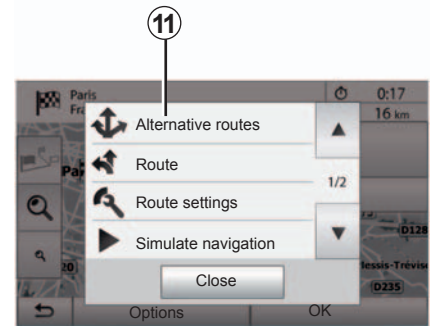

- If an active route exists, you can select the destination as a new route or stage. Press **10** and then press "New route" or "Waypoint".

"Options"

Before the 10 second countdown ends, the following choices will appear on the screen:

"Alternative routes"

Press **11** to change or modify the route.

ENTERING A DESTINATION (6/6)

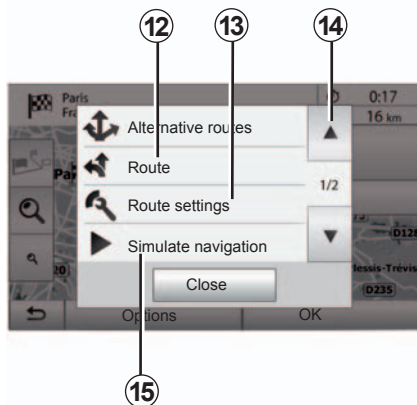

“Route”

Press **12** to view a breakdown of your route. Please refer to the section on “Guidance”.

“Route settings”

Press **13** to adjust your route depending on the desired roads and route mode.

“Simulate navigation”

Press **15** to view of simulation of the route you have selected. Please refer to the section on “Guidance”.

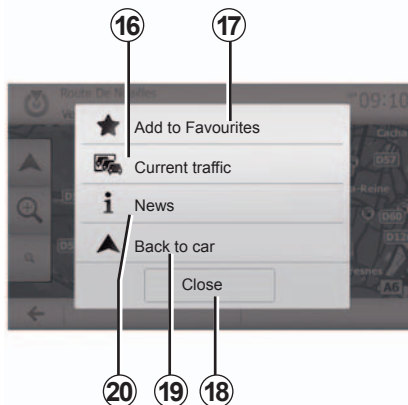

“Current traffic”

This function enables you to obtain information on traffic incidents over the course of your trip, or in your immediate vicinity. To access this, press **14** then select “Current traffic”.

“Options”

At the end of the 10 second countdown, the following choices appear on the screen:

“Add to favourites”

Press **17** to save the selected destination in your favourite destinations.

“Current traffic”

Press **16** to obtain information about traffic incidents flagged on your route or in your immediate vicinity.

“News”

Press **20** to view the address, latitude, longitude and telephone number of a point of interest (only activated after selecting a point of interest).

“Back to car”

Press **19** to return to the current vehicle position.

Note: To close the “Options” window, press **18**.

GUIDANCE (1/6)

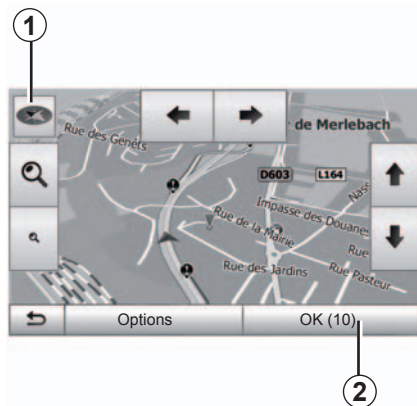

Activating guidance

Press **2** or wait 10 seconds after entering a destination. Guidance will begin.

Note: You can interact with the map at any time by sliding it in the desired direction or by pressing the screen.



Guidance screens

The system will offer several different navigation maps.

Press **3** to change the map display and open the drop-down menu. Then select one of the different displays:

- 2D;
- 3D;
- 2D North.

You can also change the map display by pressing the compass **1** on the map.

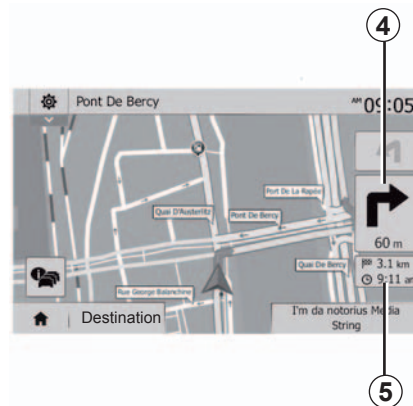

Full-screen mode (2D, 3D or 2D North)

This mode allows you to view the navigation map on the entire screen.

The information on the arrival time and the distance remaining to the destination are indicated in **5**.

The indication for the next change of direction is located in **4**.

GUIDANCE (2/6)

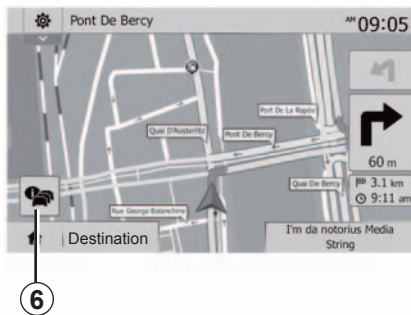

Intersection map

During guidance, before each change of direction.

Alternative route

The system offers an alternative route in the event of an accident or heavy traffic along the planned route. Press “Yes” or “No” as required.

Traffic summary

During guidance, you can get traffic information at any time by pressing **6**.

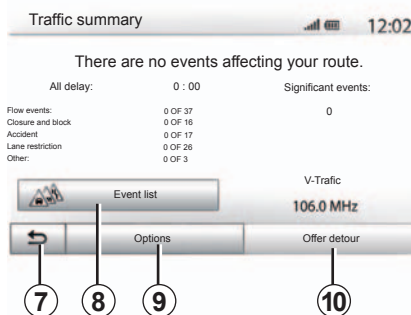

The screen gives you various events appearing on your route. The system will let you know the length of the delays caused by these incidents on your trip. Press **8** to change the event display settings. Press **10** to make a detour, **9** to access traffic options (please refer to the section on “Navigation settings”) or **7** to return to navigation.

Note: traffic information depends on your subscription and on signal reception.



Motorway junction view

During guidance, before each motorway junction, the system will display a three-dimensional view of the junction.

Note: for some junctions, only a small turn arrow will appear on the map. The system will switch back to normal mode after you have passed the junction.

GUIDANCE (3/6)

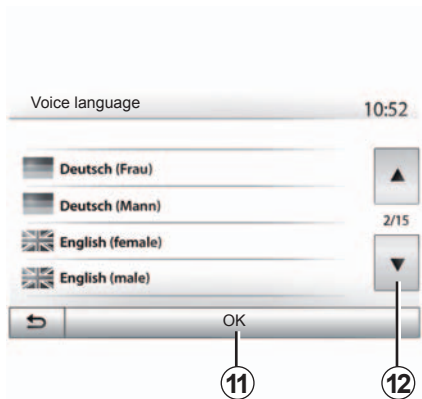

Changing voice guidance language

Press “Home” > “Nav” > “Options” > “Setting” to change the language of the voice guidance.

Scroll the language list by pressing **12**. Select the desired language and press **11** to confirm.

To set the voice guidance sound, please refer to the information on “Audio preferences” in the section on “Audio settings”.



Listening to the radio during voice guidance

While listening to a radio station during voice guidance and before each change of direction, the system will temporarily cut the sound of the radio until you pass the junction.

You can access the radio station listening screen during navigation by pressing **13**. To return to the navigation screen, press **14**. To return to the main menu, keep **14** pressed down for around three seconds.



Route information

This function allows you to view your route.

Press “Home” > “Nav” > “Route” after entering a destination.

Six choices will be given:

- “Edit route”;
- “To avoid”;
- “Overview”;
- “Cancel Route”;
- “Alternative routes”;
- “Route”.

GUIDANCE (4/6)



Route overview

Press “Home” > “Nav” > “Route” > “Overview” to get a map with an overview of the active route.

The following information will be given:

- the name and/or address of the destination;
- The total time of the route;
- The total distance of the route;

- the special points and sections of the route (e.g. toll gates, toll roads, motorways, etc.);

- alternative routes (e.g.: “Short”, “Fast”, “Economical”).

Press **15** to display the following options:

- “Warnings”;
- “Route settings”;
- “Map settings”;
- “Voice settings”;
- “Coordinate format”;
- “GPS”;
- “Map Update”;
- “Traffic”.

NB: for further information, please see overleaf.

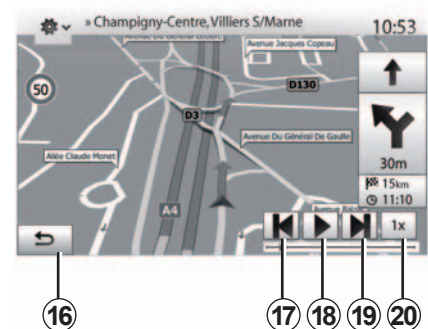

“Simulate navigation”

Press “Home” > “Nav” > “Route” > “Overview” > “Options” > “Simulate navigation” to simulate the route you will take to the destination.

- Start or pause the simulation by pressing **18**.
- Press **20** to increase the speed of the simulation.
- You can leave the route simulation at any given moment by pressing **16**.
- To move to the previous/next manoeuvre, press **17** or **19**.

GUIDANCE (5/6)

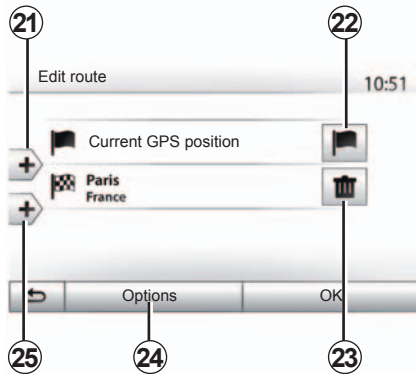

Edit route

Press “Home” > “Nav” > “Route” > “Edit route” to change the route by adding, modifying or deleting steps.

Press **21** to add steps and **25** to add a new destination. It offers several methods to enter a destination. see the “Entering a destination” section.

- Press **23** to delete a destination.
- Press **24** to reorder the list.
- Press **22** to change the route departure address.

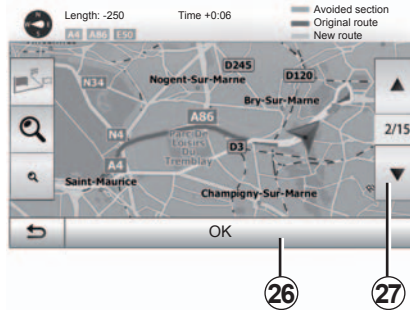

Avoidances

Press “Home” > “Nav” > “Route” > “To avoid” to make a detour. Press an area of the list depending on the desired detour.

To change the area, press **27**.

Confirm the new route by pressing **26**.

Cancel the route

At any given moment, you can stop the guidance.

Press “Home” > “Nav” > “Route” > “Cancel Route” to cancel the active route.



Route Alternatives

This section enables you to change the route planning method. Three modes are available, enabling you to change the route planning method.

- « Fast » ;
- “Economical”;
- « Short ».

Please refer to the information on “Route settings” in the section entitled “Navigation settings”.

Press “Home” > “Nav” > “Route” > “Alternative routes” then **A**, **B** or **C** to confirm the new route. Tap **28** to go back to previous screen.

GUIDANCE (6/6)



« Route »

This function makes it possible to view the route plan. Several details of the route will appear:

- direction-change arrows;
- road number;
- distance before a fork.

Press **29** to sort the route details:

- by summary.

Only showing the main elements of the trip (start, destination) the total distance, remaining time and arrival time.

- By standard description.

It shows all the manoeuvres and their signpost information, route numbers, street name and distance. Also showing information and warnings, such as route section names entered by the driver, restrictions (access and manoeuvre restrictions), ignored user preferences, etc.

- By road list.

Detail of the route by road names and numbers. It also shows their length, average direction and travel time information. Elements of the trip are not shown in this mode.

« Route settings »

This item enables you to choose your route settings. Please refer to the information on “Route settings” in the section entitled “Navigation settings”.

MAP SETTINGS

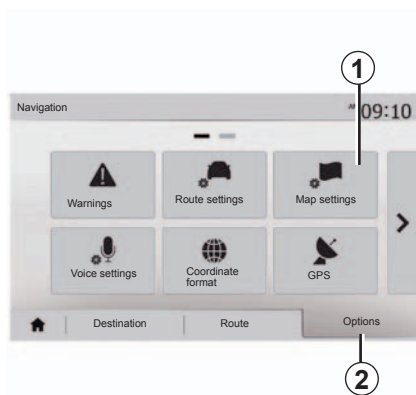

From the navigation menu, press **2** then **1** to access the map adjustment menu.

Adjusting view mode

This function allows you to switch the map view between a 3D, view and a 2D top-down view, and a view with north always facing upwards.

Press “3D”, “2D” or “2D North”.

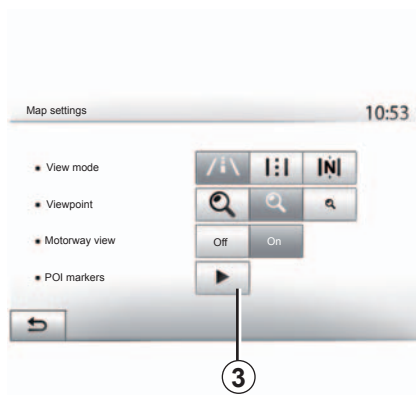

Adjusting viewpoint

This function allows you to adjust the basic zoom and tilt levels to your needs. Press the required zoom from three available levels.

Motorway View

This function allows you to activate or deactivate motorway view.

Press “On” to activate the function or “Off” to deactivate it.

Display points of interest

You can select certain points of interest (visible at 100 m scale) to be displayed on the map.

To access this function directly, press **3** to display the points of interest on the map:

- accommodation;
- airport;
- automobile;
- business;
- café or bar;
- etc.

Press “On” or “Off” to show or hide the points of interest.

Tap the name of the point of interest to open the list of its subcategories.

Note: in countries for which maps are not available, you can deactivate the navigation function. In “Home” > “Setting” > “System”, press “Off” opposite “Navigation” to deactivate the navigation function.

MANAGING THE FAVOURITES (1/2)

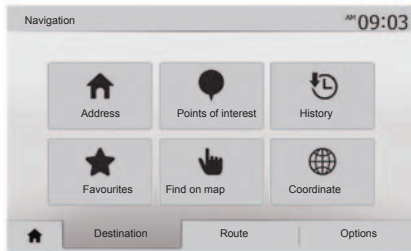

Creating an entry

Press "Home" > "Destination" to access the destination menu. You have a number of methods available to enter a destination:

- "Address": please refer to the information on "Entering an address" in the section on "Entering a destination".
- "Points of interest": please refer to the information on "Selecting a point of interest (POI)" in the section entitled "Entering a destination".

- "History": please refer to the information on "Select a destination from previous destinations" in the section entitled "Entering a destination".
- "Favourites": access destinations you have saved.
- "Find on map": please refer to the information on "Selecting a destination on the map" in the section on "Entering a destination".
- "Coordinate": please refer to the information on "Entering destination coordinates" in the section on "Entering a destination".

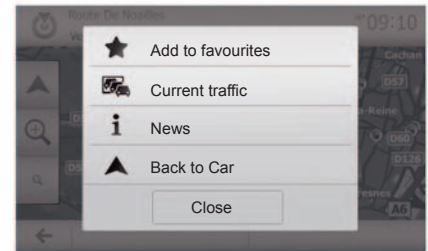

In all cases, once the address is confirmed, the system will locate it on the map. Press "Options" and then press "Add to favourites" to add the destination to Favourites.

Before saving a favourite destination, you can change its name using the digital keypad.

MANAGING THE FAVOURITES (2/2)

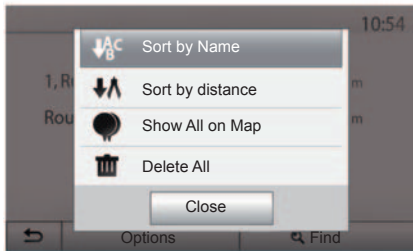

Sorting the list

The result of saved favourites can be sorted by name, distance, or all shown on a map. Press “Options”.

Deleting the favourites

Press the favourite you want to delete. Press “Options”, “Delete favourite” and confirm the deletion by pressing Remove.

To delete all favourites, press “Options” and then press “Delete all”. Confirm this deletion by pressing “Delete all”.

Searching the favourite

This function allows you to search the favourite destination in the list by name.

Press “Find” and enter the name of the favourite destination using the digital keypad.

NAVIGATION SETTINGS (1/4)



The “Options” tab at the bottom of the “Navigation” menu enables you to change the map display or the navigation settings.

« Warnings »

This item allows you to set up warnings.

Warning in the event of excess speed

Maps may contain information about the speed limits of the road segments. The system is able to warn you if you exceed the current limit.

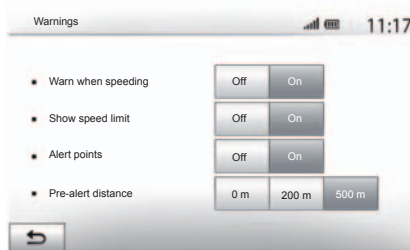

This information may not be available for your region, or may not be fully correct for all roads on the map.

The following warning types are available:

- audio warning: you receive a non-verbal warning when you exceed the speed limit;
- visual warning: the current speed limit is shown flashing in red on the map when you exceed it.

Press “On” or “Off” to activate or deactivate the warning.

Speed limit always visible

Activate or deactivate the speed limit display for the section of road taken by pressing “On” or “Off”.

Alert point warnings

When the driver crosses the increased care area, a visual warning signal appears on the screen, along with a beep. These hazardous areas are sections of road on which drivers should take extra care. They can be permanent or temporary. You can activate or deactivate this function.

Pre-alert distance

You can choose a distance from a number of choices, to give the distance at which you wish to be notified of a hazardous area.

In certain countries it is illegal to download and activate the warning areas and this could lead to prosecution.

NAVIGATION SETTINGS (2/4)



“Route settings”

This function allows you to set how routes will be calculated.

“Route planning method”

This system offers three criteria for calculating a route:

- “Fast”: gives a quick route if you can travel at or near the speed limit on all roads;
- “Short”: gives a short route to minimise the distance to travel;

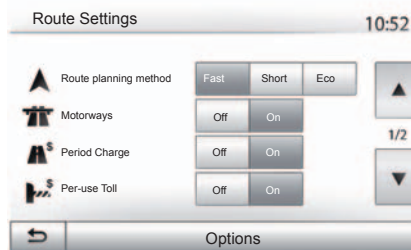

- “Eco”: this mode produces a compromise between fast and short routing modes. If you can save a certain distance by travelling for slightly longer time in exchange, it will do just that. The resulting route might be shorter than the fast variant, but not significantly slower.

“Motorways”

You might need to avoid motorways when you are driving a slow car or you are towing another vehicle.

“Period charge”

You can authorise or refuse authorisation for roads requiring the purchase of special authorisation for a certain period.

“Per-use toll”

You can authorise or refuse authorisation for the use of toll roads.

“Ferries”

You can authorise or refuse authorisation for all types of ferries, boats and trains.

“Carpool/HOV”

This function enables you to view roads only intended for two drivers sharing.

“Unpaved roads”

You can authorise or refuse authorisation for the use of off-road tracks.

NAVIGATION SETTINGS (3/4)

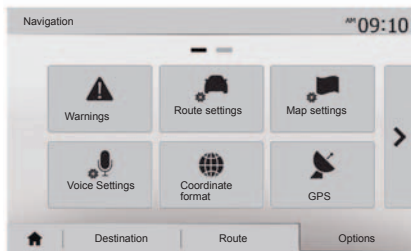

“Map settings”

Refer to the information in the section on “Map settings”.

“Voice settings”

This function allows you to change the language of voice guidance. Please refer to the section on “Guidance” in this manual.

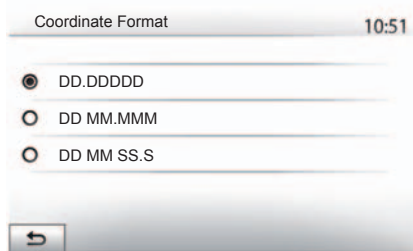

“Coordinate format”

This function allows you to change the format of coordinate.

This system offers three types of format.

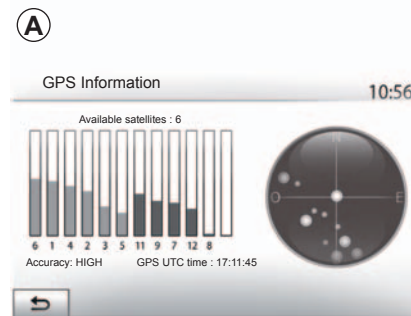

GPS

This function allows you to check the status of GPS satellites.

Press “GPS” to see the GPS information (screen **A**).

NAVIGATION SETTINGS (4/4)



“Map Update”

This function enables you to check the dates of your last updates.

“Traffic”

This function enables you to activate or deactivate “Traffic info”, the flagging of different events and to manage alternative routes in the event of accidents or traffic jams.

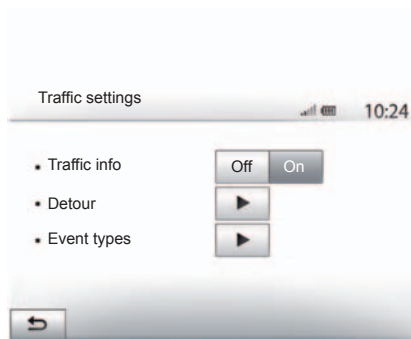

“Traffic info”

You can activate or deactivate warnings for different incidents occurring along your route.

“Detour”

This function allows you to save time when an incident occurs on your trip, by offering you an alternative route.

The multimedia system will offer you to choose a time after which a new route is suggested to you with a detour to save time.

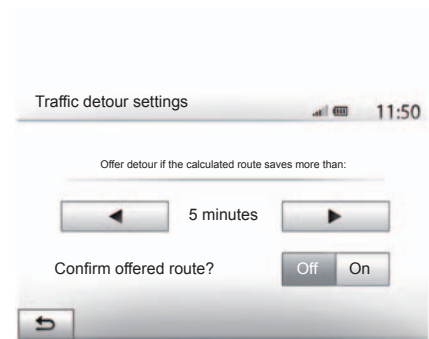

“Event types”

This function enables you to choose the types of events to be displayed during navigation:

- “All events”;
- “Flow events”;
- “Closure and block”;
- “Accident”;
- ...

DRIVING ECO²

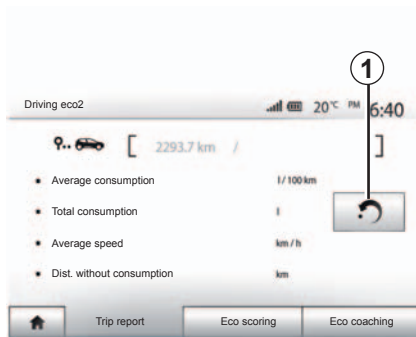

Access the Driving eco² menu

From the main menu, press “Vehicle”, then “Driving eco²”.

The “Driving eco²” menu grants access to the following information:

- “Trip report”;
- “Eco scoring”;
- “Eco coaching”.

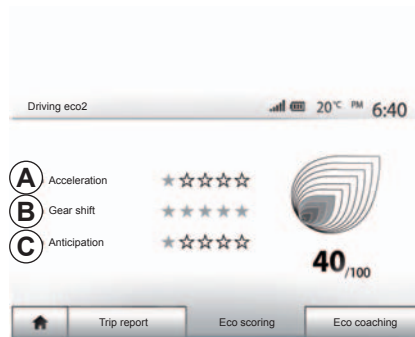

“Trip report”

This menu shows you the data saved from your last journey:

- “Average consumption”;
- “Total consumption”;
- “Average speed”;
- “Dist. without consumption”.

Note: You can reset the data by pressing **1**.

“Eco scoring”

This menu gives you an overall mark out of 100. The higher the score, the better your eco-driving performance.

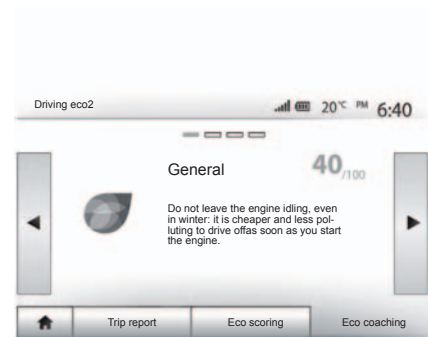

- Average acceleration performance (zone **A**);
- average gear change performance (zone **B**);
- average braking anticipation performance (zone **C**).

“Eco coaching”

This menu assesses your driving style and gives you the best possible advice to optimise your fuel consumption.

PAIRING, UNPAIRING BLUETOOTH® DEVICES (1/3)

Pairing another phone Bluetooth®

To use your hands-free phone system, you must pair your Bluetooth® mobile to your vehicle before using it for the first time.

Pairing will enable the system to recognise and store a Bluetooth® phone. You can pair up to five phones, but only one can be connected at a time to the hands-free system.

Pairing is carried out directly via the multimedia system or via your phone. The system and your phone must be switched on and make sure that the Bluetooth® on your mobile is activated, visible and identifiable to other devices (please refer to the instructions for your phone for further information).

Depending on the brand and model of your phone, the hands-free functions may be partially or fully incompatible with your vehicle system.

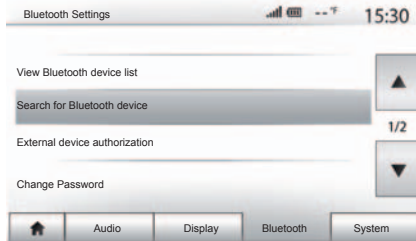

Pairing a Bluetooth® telephone from the multimedia system

- Activate your phone's Bluetooth® connection;
- press "Setting" > "Bluetooth" > "Search for Bluetooth device";
- make sure your phone is activated and visible on the Bluetooth® link;
- select your phone from the list of devices found by the system;
- A message is displayed on your phone screen.

Depending on the phone, press "Twin", "Pair" or "Connect" to authorise the pairing.

- Depending on the phone, enter the code displayed on the multimedia system screen on your telephone keypad;
- A second message appears on your phone screen offering to automatically pair to the multimedia system for future uses. Accept this authorisation to avoid the need to redo all these steps.

Depending on the phone, the system may prompt you to confirm the transfer of the phonebook and call log to the multimedia system during pairing. Accept sharing to find this information on your multimedia system. You can also authorise automatic sharing of the phonebook and call logs for the system to transfer them automatically during your next pairings.

Note: your multimedia system memory is restricted and it is possible that all your contacts may not be imported.

PAIRING, UNPAIRING BLUETOOTH® DEVICES (2/3)

Your phone is now paired to your multimedia system.

Note: the pairing time varies based on the brand and model of your phone.

If pairing fails, redo the operation. If your phone is not visible by the system while searching for Bluetooth® devices, please consult your telephone manual.

Pairing a Bluetooth® telephone to the multimedia system from the phone

- Activate the Bluetooth® connection of your phone and the system;
- on the Media Nav Evolution, from the main menu, press “Setting” > “Bluetooth” > “External device authorization”. You thereby make the system visible to other Bluetooth® phones;
- a message appears on the screen displaying a password and the time left during which the system remains visible;
- from your telephone, display a list of available Bluetooth® devices;

When switching on the “Media Nav Evolution” system, the last paired device will be automatically connected to the system.

- select the multimedia system “Media Nav Evolution ” from the available devices during the time given, and -- depending on the phone - enter the password displayed on the system screen on your telephone keypad.

A message appears on your telephone screen to notify you that it is now paired with the Media Nav Evolution multimedia system.

Note: the pairing time varies based on the brand and model of your phone.

If pairing fails, redo the operation.



Your hands-free system is only intended to facilitate communication by reducing the risk factors, without removing them completely. You must always comply with the laws of the country in which you are travelling.

PAIRING, UNPAIRING BLUETOOTH® DEVICES (3/3)

Unpairing a Bluetooth® phone from the Media Nav Evolution system

Unpairing erases a phone from the hands-free system memory.

From the main menu, press “Setting” > “Bluetooth”, then “View Bluetooth device list”. Press the “recycle bin” icon **2** opposite the name of the phone you wish to delete from the list. Confirm your choice by pressing “OK”.

Unpairing all Bluetooth® phones from the Media Nav Evolution system

You can also delete all phones previously paired from the hands-free system memory. From the main menu, press “Setting” > “Bluetooth” > “View Bluetooth device list” then “Options” and “Delete all”. Confirm the deletion of all paired phones by pressing “OK”.

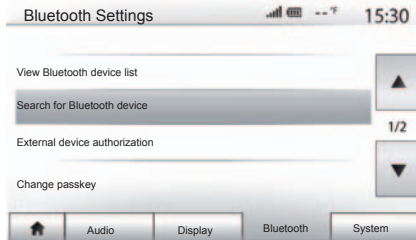

“Change passkey”

You can customise the four-digit password for the system authorising the pairing of Bluetooth® phones.

From the main menu, press “Setting” > “Bluetooth” > “Change passkey”.

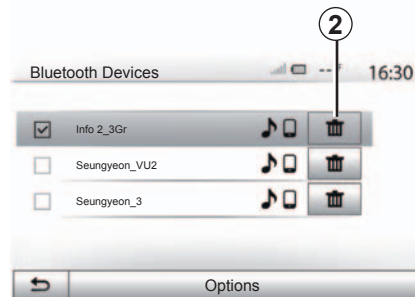

“Smartphone”

This function available on the second page of the “Bluetooth” menu enables you to access assistance with activating and operating voice controls (please refer to the section on “Using voice controls”).

CONNECTING, DISCONNECTING BLUETOOTH® DEVICES (1/2)

Connecting a Bluetooth® paired phone

No phone can be connected to the hands-free phone system if it has not first been paired. Please refer to the section entitled “Pairing/unpairing Bluetooth® devices”.

Your phone must be connected to the hands-free phone system in order to use all its functions.

Automatic connection

Once the system is switched on, the hands-free phone system will search for any paired phones present in the vicinity (the search may take a minute). It automatically connects to the last connected phone if:

- the Bluetooth® connection of the telephone has been activated;
- at the time of pairing, you previously authorised automatic connection for your telephone to the system.

Note: If a call is in progress at the time the connection is made, it is automatically transferred to the vehicle speakers.

Note: you are recommended to accept and authorise all messages which appear on your telephone while pairing with the system so that the automatic device recognition operates smoothly.

Manual connection

From the main menu, carry out the following operations:

- press “Phone”;
- press “View Bluetooth device list”;
- select the name of the telephone to which you wish to connect.

Your telephone is connected to the multimedia system.

Connection failure

If connection fails, check that:

- your device is switched on;
- the device is configured to accept the system’s automatic connection request;
- your device battery is not flat;
- your device has been paired to the hands-free system;
- the Bluetooth® for your device and the system are activated.

Note: Using your hands-free system for prolonged periods of time will discharge your device’s battery more quickly.

CONNECTING, DISCONNECTING BLUETOOTH® DEVICES (2/2)

Changing a connected telephone

You can connect or disconnect a Bluetooth® device at any time.

From the main menu, press “Media device”, then “Settings” and “List of devices”.

Select the device to be connected and confirm by pressing “OK”.

A small marker **1** will appear opposite your telephone name to indicate that the connection has been made.

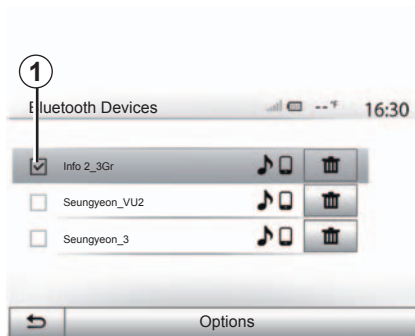

Disconnecting a connected telephone

To disconnect a telephone from Media Nav Evolution, press the name of your device. The small marker **1** will disappear.

If a call is in progress when the phone is disconnected, the call will automatically switch to your phone.

USING VOICE RECOGNITION (1/4)

Introduction

Your multimedia system has a voice recognition system which allows voice control of some functions and applications of the multimedia system and your phone. This enables you to use your multimedia system or your phone while keeping your hands on the steering wheel.

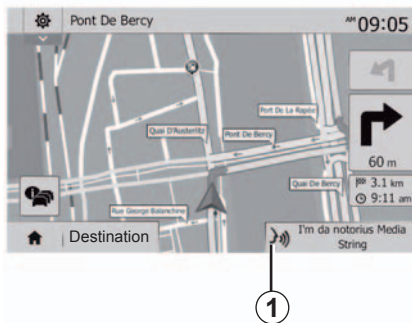

Note: the position of the voice recognition button varies depending on the vehicle (steering wheel or column controls).

Note: When using voice recognition, the language set on your telephone will be the language used by your system.



Activation of the multimedia system's voice recognition

You can use voice control to call a contact in your phonebook, enter a destination, change radio station etc without touching the screen.

Briefly press voice recognition button  on the steering wheel control or press and hold voice recognition button  on the steering column control and follow the audio and visual instructions provided by the multimedia system.

Usage during navigation

You can use voice recognition during navigation. Location **1** indicates that voice recognition is activated.

Note: when you use voice controls during navigation, the audio source currently being played is substituted by voice recognition for the length of its usage.

Deactivation

Briefly press the voice recognition button on the steering wheel control or press and hold the voice recognition button on the steering column control. An audible signal indicates that voice recognition is deactivated.

USING VOICE RECOGNITION (2/4)

Activating the phone's voice recognition with the multimedia system

To activate your phone's voice recognition system you should:

- get a 3G, 4G or Wifi connection with your smartphone;
- activate Bluetooth® on your smartphone and make it visible to other devices (please refer to your telephone manual for instructions);
- pair and connect your smartphone to the multimedia system (please refer to the section on “Pairing, unpairing Bluetooth® devices”);

Note: the symbol **2** in the “Settings” > “Bluetooth” > “View Bluetooth device list” menu indicates that voice recognition on your smartphone is compatible with your multimedia system.

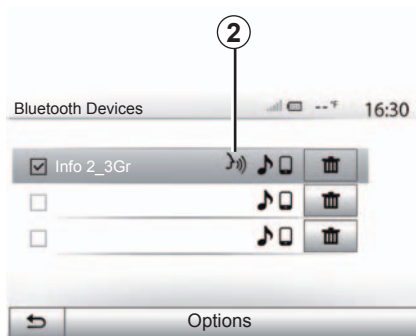

- Press and hold voice recognition button  on the steering wheel control

A beep sounds and the display on screen **A** indicates that voice recognition is activated.

Speak loudly and clearly.



Note: your smartphone's voice recognition system only enables you to use certain functions of your telephone. It does not enable you to interact with the other functions of your multimedia system such as the radio, the Driving eco2 etc.

USING VOICE RECOGNITION (3/4)

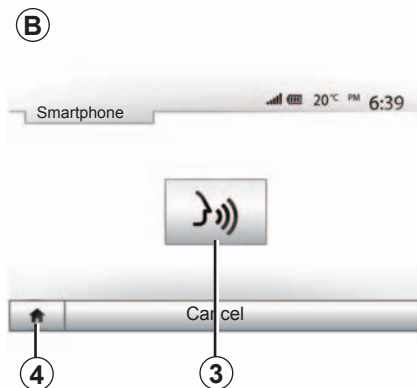

Use

Once activated, to restart the voice recognition system, briefly press button on the steering wheel or steering column of your vehicle, or briefly press button **3** on the touchscreen of your multimedia system.

You can go back to the main menu at any time by pressing **4**.

Note: when using voice recognition, the “Media” and “Radio” functions will not be available or accessible from the main menu of your multimedia system.

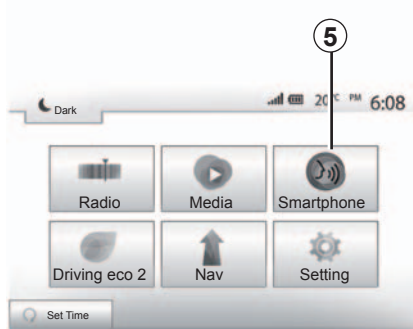

To return to screen **B** press **5** in the main menu of your multimedia system.

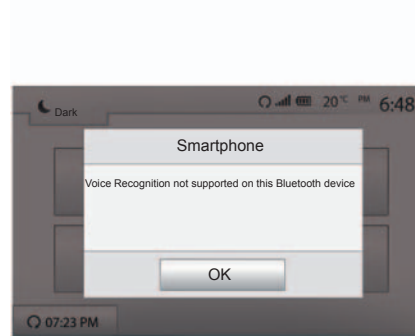

Deactivation

Press and hold button **3** on the **B** screen or press and hold voice recognition button  on the steering wheel control. An audible signal indicates that voice recognition is deactivated.

Note: a message is displayed on the multimedia system using if your smartphone does not have voice recognition.

USING VOICE RECOGNITION (4/4)

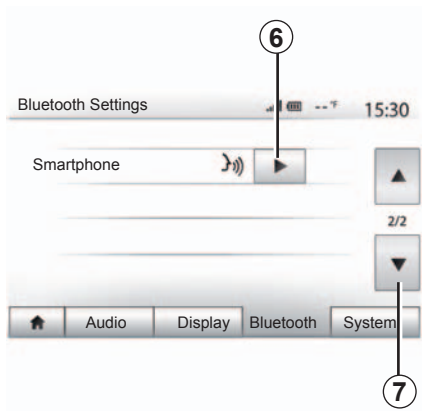

Help

You can get additional help on the operation and usage conditions of the voice recognition system. To do this, press “Home” > “Setting” > “Bluetooth”. Select the second page by pressing **7**, then press **6**.

This function is presented in the form of screens explaining how to use voice recognition, alongside the:

- conditions of use;
- compatible telephones;

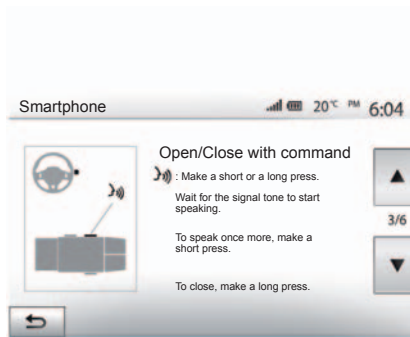

- activation and deactivation of the function using the steering wheel/column controls;
- method for interacting with the screen;
- available functions;
- extent of the functions.

PHONE BOOK

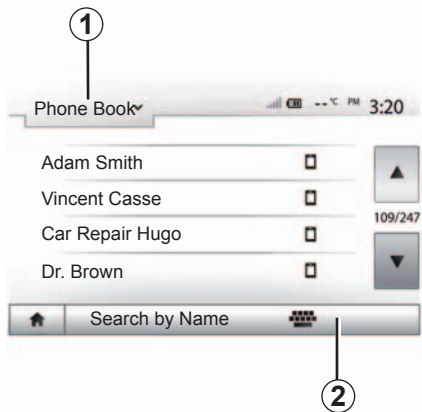

From the “Phone device” menu, press **1** to scroll through the list of menus and then “Phone Book” to access the system telephone directory.

Using your Phone Book

You can use the Phone Book entries stored on the memory of phone.

After connecting your system and your Bluetooth® phone using Bluetooth® wireless technology, your phonebook numbers are automatically transferred into the system if the contacts are stored in the telephone memory of your device.

Note: On some phones, the system may ask you to confirm the transfer of the phonebook to the system during pairing.

Calling a number in the Phone Book

After finding the contact in the phonebook you want to call, select the number to place the call.

Searching for a contact in the phonebook

Press **2** then enter the surname or first name of the contact you are seeking, using the digital keypad.

Depending on the make and model of your phone, transferring your contacts to the multimedia system may not work.



It is recommended that you stop your vehicle before entering a number or searching for a contact.

MAKING, RECEIVING A CALL (1/3)

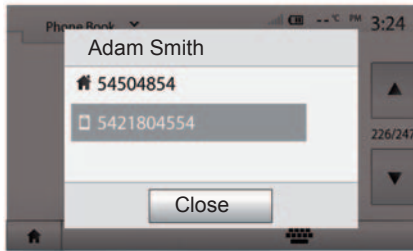

Making a call from the phonebook

With the telephone connected, from the "Phone device" menu, select "Phone Book" from drop-down menu "1".

Select the contact (or the suitable number of the contact has more than one). The call is made automatically by pressing the contact's number.

Note: you can make a call from the multimedia system using the voice recognition from your smartphone. Refer to the Section entitled "Using voice recognition".

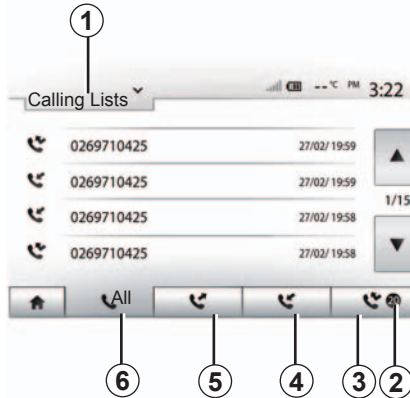

Dialling a number from the call history

You can use the call list stored on the phone memory to make a call.

After connecting your unit and Bluetooth® phone via Bluetooth® wireless technology, the numbers in your phone's "All Calls", "Outgoing Calls", "Incoming Calls", and "Missed Calls" lists are transferred automatically into the call list on your multimedia system.

Press **1** to scroll the list and then press "Calling Lists".

Press **6** to access to the list of All Calls.

Press **5** to access the list of Outgoing Calls.

Press **4** to access the list of Incoming Calls.

Press **3** to access the list of Missed Calls.

Note: The marker **2** indicates the number of missed calls.

For each list, the contacts are listed from the most recent to the oldest. Select a contact to make the call.

MAKING, RECEIVING A CALL (2/3)

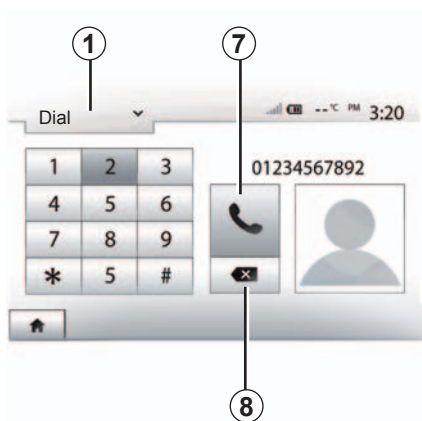

Entering a number

Press **1** to scroll through the list, then “Dial” for the call number.

Press the numbered buttons to dial the number, then press **7** to place the call.

To delete a number, press **8**. Press and hold **8** to delete all the numbers at once.



It is recommended that you stop your vehicle before entering a number or searching for a contact.

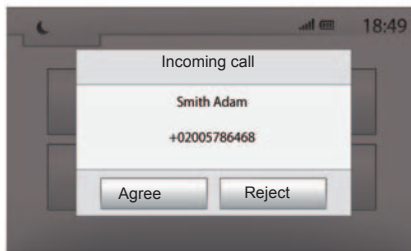

Receiving a call

When receiving a call, a message is displayed on the multimedia system screen with the following information on the caller:

- the name of the contact (if the number is present in the phonebook list);
- caller's number;
- “Unknown Number” (if the number cannot be viewed).

Note: when the incoming call message appears on the screen during navigation, accept or reject the call to return to the navigation screen.

Note: you can answer or reject an incoming call using your vehicle's remote control.

MAKING, RECEIVING A CALL (3/3)

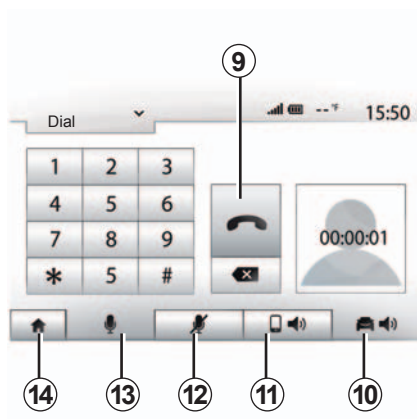

- hear sound through the vehicle speaker by pressing **10**;
- press **14** to return to the previous screen (the navigation screen, for example) or the welcome screen.

During a call

During a call you can:

- switch the microphone off by pressing **12**;
- switch the microphone on by pressing **13**;
- hang up by pressing **9**;
- hear sound through the phone speaker by pressing **11**;

REMOTE ENGINE START-UP (1/3)



When fitted, this function lets you programme the engine to start remotely, in order to heat or ventilate the passenger compartment up to 24 hours before using the vehicle.

Adjust the heating level required (temperature, de-icing) before programming the function. Configuration and programming are done via the multimedia display.

Setting the start time for the function

- Switch on the ignition, then press **1** from the main menu. Screen **A** is displayed;

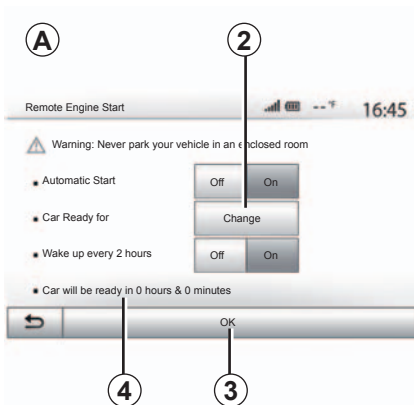

- select the “On” button on the “Automatic Start” line to activate the function;
- set the start time when you wish to use your vehicle by pressing button **2**;
- press on the “up” and “down” arrows to scroll through the hours and minutes until you get the desired time;
- press “OK” to confirm. The **4** marker shows you the time left before the time you wished to use the vehicle;
- press “OK” **3** to confirm and finalise the programming;



- adjust the air-conditioning controls to the desired temperature in the passenger compartment when starting up the engine, then set to de-icing mode (please see Section 2 of the vehicle manual);

To activate remote start-up by programming, you must select a time at least fifteen minutes later than the time displayed by the multimedia system.

REMOTE ENGINE START-UP (2/3)

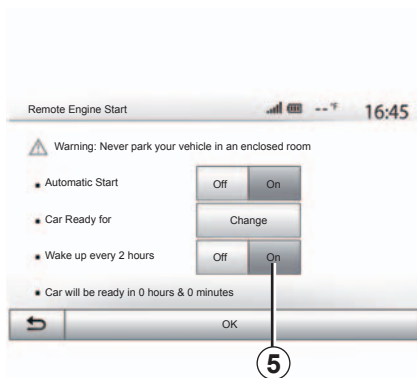

- turn off the ignition.

When locking your vehicle, two flashes, then the hazard warning lights and indicator lights switching on for approximately three seconds indicate that the programming has been taken into account.

The remote engine start-up operates if:

- the lever is in neutral for vehicles with a manual or sequential gearbox;
- the lever is in position **P** for vehicles with an automatic gearbox;



- the ignition is switched off;
- all the opening elements (bonnet, doors, boot) are closed and locked when you leave the vehicle.

Note: you must switch off your multi-media system when you leave your vehicle for remote engine start-up to work.

“Wake up every 2 hours”

This function enables your vehicle to start automatically every two hours depending on the engine temperature.

To activate this function, press the “On” button **5**.

Note: the ventilation system must be off for the “Wake up every 2 hours” function to activate.

When this function is activated, the ventilation system will not activate during the first four start-ups, if they happen.

In very cold conditions, the vehicle will start automatically and will stay on for approximately ten minutes before switching off.

If the engine temperature does not require a restart, the vehicle will not start automatically during the first four reactivation times and will return to standby for two hours. The engine will be restarted if the engine temperature is too low.

In all cases, the last start-up will happen.

Approximately fifteen minutes before the programmed time, the engine starts and remains on for about ten minutes.

Note: the marker **6** reminds you of the vehicle start time that you have already set.

REMOTE ENGINE START-UP (3/3)

Depending on the vehicle, please ensure that consumers such as the wipers, exterior lights, radio, heated seats, heated steering wheel, etc. are disabled and all accessories are disconnected before leaving the vehicle.

In extreme conditions, the remote start-up by programming may not work.



Do not park the vehicle or run the engine in locations where combustible substances or materials such as grass or leaves can come into contact with the hot exhaust system.



Driver's responsibility when parking or stopping the vehicle

Never leave an animal, child or adult who is not self-sufficient alone on your vehicle, even for a short time. They may put themselves or others at risk, for example by starting the engine, switching on equipment such as the electric windows or by locking the doors etc. Also, in hot and/or sunny weather, please remember that the temperature inside the passenger compartment increases very quickly.

RISK OF DEATH OR SERIOUS INJURY.

Special feature on vehicles equipped with the "Wake up every 2 hours" function.

It is imperative that the vehicle is driven for at least 10 minutes between each use of the function. Risk of engine oil wear.



Do not use the engine remote start-up function or its programming when:

– the vehicle is in a garage or in a confined space.

Risk of poisoning or suffocation by exhaust gas emissions.

– the vehicle is covered with a protective cover.

Fire hazard.

– the bonnet is open or before it opens.

Risk of burns or serious injury.

Depending on the country, the use of the remote starting function or its programming can be prohibited by the legislation and/or the regulations in force.

Before using this function, check the legislation and/or the regulations for the country in force.

REVERSING CAMERA (1/2)

Operation

Shifting into reverse gear (and up to approximately five seconds after shifting to another gear), a view of the surroundings to the rear of the vehicle is displayed on the multimedia system screen accompanied by the guide, a silhouette of the vehicle and beeps.

Ultrasonic sensors installed in your vehicle “measure” the distance between the vehicle and an obstacle.

When the red zone is reached, use the bumper image to stop accurately.

Note: for more information on using parking assistance, please see your owner’s handbook.

Note: Make sure that the reversing camera is not obscured (by dirt, mud, snow, etc.).

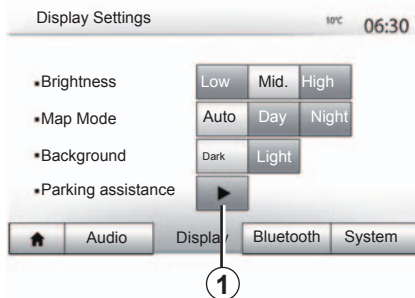

Activation/deactivation

Reversing camera

You can activate/deactivate the reversing camera. To do this, from the main menu, select “Setting” > “Display”, then press button **1**. Select “On” to activate the function or “Off” to deactivate it.

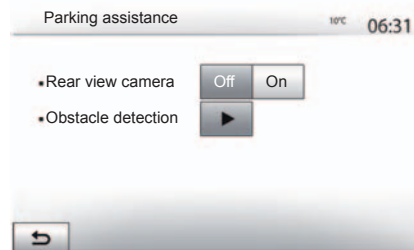

Obstacle detection sensors

You can independently activate or deactivate the front and/or rear the sensors of your vehicle. To do this, from the main menu select “Setting” > “Display” > “Parking assistance” > “Obstacle detection”. Select “On” to activate the desired sensor(s) or “Off” to deactivate it/ them.

REVERSING CAMERA (2/2)

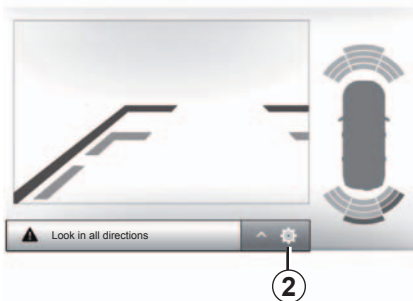

Settings

Press **2** to display a list of settings.

You can activate or deactivate the guide display by pressing **3** or **4**.

Press "+" or "-" to set the contrast **5**, brightness **6** and colours **7**.

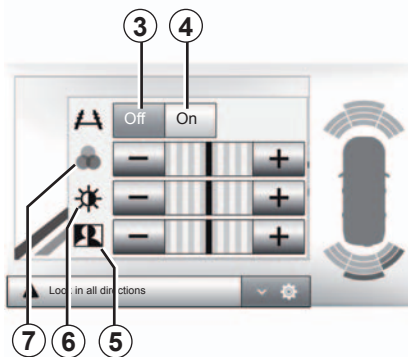

This function is an additional aid. It cannot, therefore, under any circumstances replace the vigilance or the responsibility of the driver.

The driver should always look out for sudden hazards during driving: always ensure that there are no moving obstacles (such as a child, animal, pram, bicycle, etc.) or small, narrow objects such as stones or posts in your path when manoeuvring.

The screen shows a reverse image.

The gauges are a representation projected onto flat ground. This information must not be taken into account when superimposed on a vertical object or an object on the ground.

Objects which appear on the edge of the screen may be deformed.

In very bright light (snow, vehicle in sunshine etc.), the camera vision may be adversely affected.

SYSTEM SETTINGS (1/3)

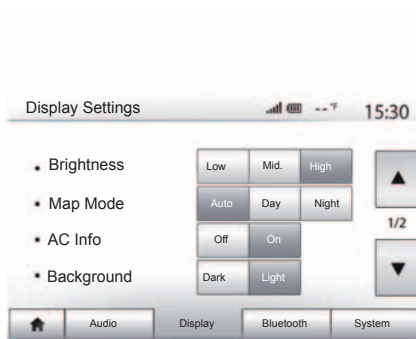

To access the multimedia system settings from the welcome screen, press “Setting”, then select a section at the bottom of the screen.

Audio settings

Please refer to the section on “Audio settings”.

Display settings

“Brightness”

You can set the brightness of the screen to your liking. You have the option of three modes:

- “Low”;
- “Mid.” (Medium);
- “High”.

“Map Mode”

To improve the visibility of the navigation screen between day and night, you can change the combination of the colours of the map.

- “Auto”: the map screen is displayed by GPS. The switch to daytime or night-time running lights is automatic, depending on whether the headlights are on.
- “Day”: The map screen is always displayed with bright colours.
- “Night”: the map screen is always displayed using darker colours.

«AC Info»

This function activates/deactivates the display of air conditioning information when adjusting settings.

«Background»

This function enables you to choose between a dark or light display mode.

“Parking assistance”

This function allows you to activate/disable the reversing camera, as well as the front and/or rear sensors.

Bluetooth® settings

Refer to the section entitled “Pairing/unpairing Bluetooth® devices”.

SYSTEM SETTINGS (2/3)

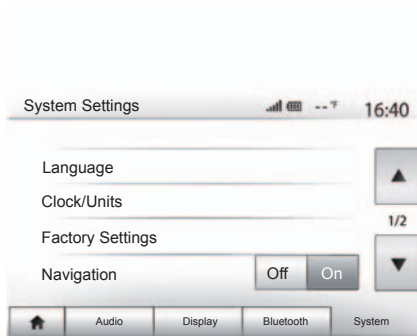

System setting

“Language”

This function allows you to change the language used in the system and voice guidance language.

To change the language, select the desired language and confirm your choice by pressing “OK”.

“Clock”

This function allows you to set the time format between the “12h” and “24h” clocks.

Note: The time is set automatically by GPS. You will need the maps for the country in which you are currently located to get the local time.

To change the time manually, press “Clock/Units”, then select “Time Setting”.

“Units”

This function allows you to set the unit of distance displayed on your multimedia system. You can change the unit between the “km” and “mils”.

“Factory Settings”

This function allows you to reset various settings to the default settings.

- All: resets all “Factory Settings” to default settings.
- Phone: Initializes all the settings related with phone.
- Navigation: Initializes all the settings related with navigation.
- Audio/Media/Radio/System: Initialises all the settings related with Audio, Media and Radio.

“Navigation”

This function enables you to activate or deactivate the system navigation.

“System Version”

This function allows you to check the version of system.

SYSTEM SETTINGS (3/3)

Security code

Your audio system is protected by a security code (supplied by the Approved Dealer). This is used to electronically lock the audio system when the power is cut (battery disconnected, system disconnected, fuse blown etc.).

To operate the audio system, you must enter the secret four-digit code.

Make a note of the code and keep it in a safe place. Contact one of the manufacturer's agents if you lose it.

Entering the code

The message "CODE" followed by four empty spaces and a numerical keypad are displayed.

Enter the corresponding code using the digital keypad, then press "OK" to confirm.

Entering the code incorrectly

If the code is entered incorrectly, the message "Incorrect PIN The system is locked" is displayed.

Wait one minute and then re-enter the code.

Each time the code is entered incorrectly, the time required before the code can be re-entered is doubled.

UPDATING THE SYSTEM (1/4)



Using the USB key and a computer with an Internet connection, you can:

- update your map content;
- update the multimedia system;
- purchase new maps;
- upgrade the POI content.

In certain countries it is illegal to download and activate the warning areas and this can lead to prosecution.

GB.72

Installing the software

Install the Naviextras Toolbox in a few clicks on your computer. The Toolbox can be downloaded from the manufacturer's website.

After downloading the installation file from the website Naviextras.com, simply double-click the file to start the installation.

Follow the instructions shown on the screen.

Creating an internet account

To log in, click on the “Not logged in” icon in the toolbar at the top of the page or click the “Log in” button on the main screen of the Toolbox. If you are not registered on the website Naviextras.com, you can do this from the Toolbox by clicking on “Register” on the log-in page.



Latest map guarantee

Once your new vehicle has been delivered, you will have a maximum of 90 days in which to update the map for free. Once this time has elapsed, you will need to pay for updates.

The screens shown in the user manual are not contractual.

UPDATING THE SYSTEM (2/4)

Registering the multimedia system with the Toolbox

To register your multimedia system on your user profile, first insert an empty USB key into the multimedia system.

Note: to insert the USB key into your multimedia system, refer to the information on “Inserting the USB key” in the “Navigation system” section.

Note: the USB key is not provided with the system.

Note: The USB key used must be formatted to FAT32 format and have a minimum capacity of 4GB and a maximum capacity of 32GB.

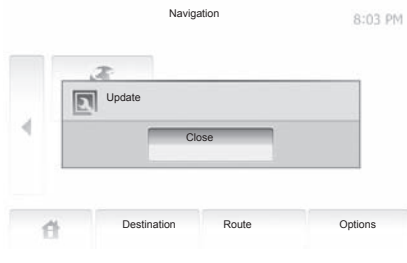

Saving the system on a USB key

When the USB key is inserted into the multimedia system's USB port, select “Nav” > “Options” > “Map Update” > “Options” > “Update” on the second page.

This creates a fingerprint of your navigation system on the USB key which will be used by the Toolbox to register your system on your user profile and to let the Toolbox determine which updates are available for your navigation system.

When the process of data recording is finished, you may remove the USB key from the multimedia system.

Insert your USB key in your computer (the computer must be connected to the internet). If your subscription allows and the Toolbox finds your system in the list of supported systems, the name of your system will appear at the top of the Toolbox window.

Your system is saved on your user profile.

Note: to register the system data on the USB key, start the vehicle and do not switch off the engine while data is loading.

Note: do not use any of the multimedia system functions during the procedure.

UPDATING THE SYSTEM (3/4)

Downloading updates from the Toolbox to the USB key

If you purchased any free or pay contents, please click on the updates button in the menu bar on the left side of Toolbox.

The updates button will open a screen which shows all available updates, including:

- items that you have purchased but not yet installed (updates or extras);
- free updates and extras that you added to the installation file from the catalogue;
- system updates (if a newer version available);
- and special free updates.

The list shows all available updates by region in a list and on a world map.

By default, all items belonging to all regions are selected for installation. If you decide to skip a region for now, uncheck the checkbox at the beginning of its table row. After reviewing the table, click “Install” at the bottom of the screen to start the installation process.

The Toolbox starts to download and install the selected updates. Please wait until you see the message indicating the update has finished.

The Toolbox warns you if the selected items exceed the maximum capacity of the multimedia system. In this case, you can select which items can be installed or removed in the system so that it does not exceed the storage limit.

Even if items are removed in the system, you still have ownership of items and can install them later for free.

Please neither remove the USB key from the system, nor shut the system down while update is in progress.



In certain countries it is illegal to download and activate the speed camera warnings and this could lead to prosecution.

UPDATING THE SYSTEM (4/4)

Updating the system and map

When the process of downloading is completed, the USB key can be removed from the computer. Insert the USB key into the USB port of the vehicle's multimedia system.

Note: to update maps, start the vehicle and do not switch off the engine while data is loading.

When the multimedia system is turned on, it automatically identifies the available updates on the USB key, and offers to update the system or map from the updates found on the USB key. Do not switch off your multimedia system while the update is being installed.

Note: downloading and installing a system update is only possible if there is a newer version available.

A

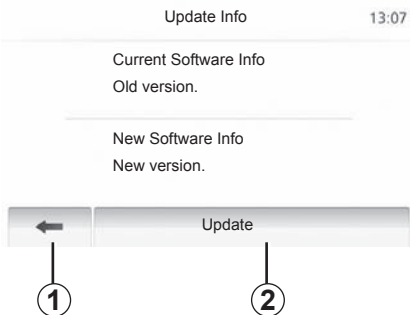

- The screen **A** is displayed automatically once the USB key is connected;
- press **2** to run the update;
- previous **1** to go back to the previous screen.

When you press the button **2**, the update procedure is launched. Do not use any of the system functions during the update procedure.

When the update is completed, the multimedia system restarts with all new and up-to-date functionality.

Licence

To obtain the GPL, LGPL, MPL and other open source licence source codes in this product, please visit the <http://opensource.lge.com> website.

As well as the source code all the terms of the licence, warranty exclusions and copyright details are available for download.

LG Electronics will also provide you with Open Source code on a CD-ROM against payment of distribution costs (such as media, shipping and handling costs) on request by post to opensource@lge.com.

This offer is valid for three years as of the date on which you purchased the product.

The multimedia system might restart automatically during the update process. Please wait for the radio screen to be displayed.

If the update is accidentally interrupted, restart the process from the beginning.

OPERATING FAULTS (1/3)

System		
Description	Causes	Solutions
No image is displayed.	The screen is on standby.	Ensure that the screen is not on standby.
	The system is deactivated.	The interior temperature of the vehicle is too low or too high.
No sound can be heard.	The volume is set to minimum or mute.	Increase the volume or deactivate mute.
	The selected system source is not correct.	Check the selected system source and make sure the output source is the multi-media system.
No sound comes from the left, right, front or rear speakers.	The balance or fader settings are incorrect.	Adjust the sound balance or fader correctly.
The displayed time is not correct.	The time setting is set to "Auto" and the system is no longer receiving a GPS signal.	Move the vehicle until you receive a GPS signal.

Media		
Description	Causes	Solutions
No sound can be heard.	The volume is set to minimum or mute.	Increase the volume or deactivate mute.

OPERATING FAULTS (2/3)

Navigation		
Description	Causes	Solutions
No sound can be heard.	The volume on the “Nav” menu is set to minimum or mute.	Increase the volume (“Options” in the “Nav” menu) or deactivate the mute function. The volume in GPS mode can be adjusted during voice guidance.
The location of the vehicle on the screen does not correspond to its actual location.	Incorrect positioning of the vehicle caused by GPS reception.	Move the vehicle until reception of the GPS signal is improved.
The directions on the screen do not correspond to the actual road.	The version of system is out of date.	Obtain the latest version of the system.
Certain items on the menu are not available.	Depending on the current command, some items will be unavailable.	
Voice guidance is unavailable.	The navigation system does not include the intersection. Voice guidance is deactivated.	Increase the volume. Ensure voice guidance is activated.
The directions of the voice guidance do not correspond to your exact location.	The voice guidance may vary according to the environment.	Drive according to the actual conditions.
The suggested route does not start or end at the required destination.	The destination is not yet recognised by the system.	Enter a road near to the required destination.

OPERATING FAULTS (3/3)

Phone		
Description	Causes	Solutions
No sounds or ringtone can be heard.	The mobile phone is not connected to the system. The volume is set to minimum or mute.	Ensure that the mobile phone is connected to the system. Increase the ringtone volume or deactivate the mute function.
Impossible to make a call.	The mobile phone is not connected to the system. The phone keypad has been locked.	Ensure that the mobile phone is connected to the system. Unlock the phone keypad.

ALPHABETICAL INDEX (1/3)

A

address book.....GB.34, GB.44 – GB.45
answering a call.....GB.12, GB.62
ARTIST.....GB.23
AUX.....GB.22 → GB.24
auxiliary source.....GB.22 → GB.24

B

BALANCE.....GB.25
BASS.....GB.25
bass.....GB.26
Bluetooth connection.....GB.54
Bluetooth®.....GB.51, GB.54, GB.60
Bluetooth® portable audio player
 pairing.....GB.23
 unpairing.....GB.23

C

call.....GB.60 – GB.61
call history.....GB.61
call volume.....GB.17
clock.....GB.70
 display.....GB.70
confirm a destination.....GB.35 – GB.36
connect a telephone.....GB.54
contacts list.....GB.60
controls.....GB.8 → GB.12, GB.15

D

destination... GB.31 → GB.36, GB.34, GB.41, GB.44 – GB.45
destination menu.....GB.31 → GB.36
detailed route.....GB.36, GB.39, GB.42
detour.....GB.41, GB.49
dialling.....GB.62
dialling a number.....GB.62
disconnect a telephone.....GB.55

GB.80

distance units.....GB.70

E

ECO driving.....GB.50
ending a call.....GB.12
entering an address.....GB.31

F

fascias and steering wheel controls.....GB.8 → GB.12
fast winding.....GB.22
favourite
 delete.....GB.45
functions.....GB.5 → GB.7

G

GPS
 receiver.....GB.27, GB.48
 reception.....GB.27
guidance
 activation.....GB.37
 map.....GB.37 → GB.42
 voice.....GB.37 → GB.42

J

Jack socket.....GB.11, GB.24

L

language
 change.....GB.70
languages.....GB.70
LIST mode.....GB.19

M

MANU mode.....GB.18
map
 digitised map.....GB.27

ALPHABETICAL INDEX (2/3)

display..... GB.28, GB.43
scale..... GB.28
settings..... GB.43, GB.46
map symbols..... GB.28
MEMO mode..... GB.19
MENU..... GB.11
MP3..... GB.22
mute..... GB.17

N

numeric keypad..... GB.16

O

operating faults..... GB.76 → GB.78
operation..... GB.13

P

pairing a telephone..... GB.51
POI..... GB.30, GB.32 – GB.33, GB.43
point of interest..... GB.29, GB.32 – GB.33, GB.43

R

radio station..... GB.18 → GB.21
range of wavelengths..... GB.18 → GB.21
RDS..... GB.5
rear view camera..... GB.67 – GB.68
receiving a call..... GB.62
remote engine start-up..... GB.64 → GB.66
reversing camera
 parameters..... GB.69
ringtone volume..... GB.26

S

screen
 menu..... GB.7
 monitor..... GB.11, GB.13

navigation display..... GB.7, GB.37 → GB.42
navigation screen..... GB.37 → GB.42
settings..... GB.43
security code..... GB.71
select
 track..... GB.24
setting..... GB.42
settings..... GB.47 → GB.49, GB.69 → GB.71
 audio..... GB.25 – GB.26, GB.69
 balance..... GB.26
 brightness..... GB.69
 fader..... GB.26
stage..... GB.41
storing a radio station..... GB.19
switching off..... GB.13
system
 update..... GB.72 → GB.75

T

3D/2D mode..... GB.37
TMC Traffic Information..... GB.36
traffic information..... GB.20, GB.49
treble..... GB.25 – GB.26

U

unpairing a telephone..... GB.52
USB..... GB.72 → GB.75
USB key..... GB.72 → GB.75
USB socket..... GB.11, GB.23, GB.72 → GB.75

V

vehicle position..... GB.28
voice control..... GB.10, GB.56 → GB.59
voice recognition..... GB.12, GB.56 → GB.59
volume..... GB.17
volume: adapted to speed..... GB.17, GB.25

ALPHABETICAL INDEX (3/3)

W

WMA..... GB.22

WARNING STATEMENT

Part 15.19 statement

This device complies with Part 15 of the FCC Rules. Operation is subject to the following two conditions: (1) this device may not cause harmful interference, and (2) this device must accept any interference received, including interference that may cause undesired operation.

Part 15.21 statement

Changes or modifications not expressly approved by the manufacturer (or party responsible) for compliance could void the user's authority to operate the equipment.

Part 15.105 statement

This equipment has been tested and found to comply with the limits for a class B digital device, pursuant to Part 15 of the FCC Rules.

These limits are designed to provide reasonable protection against harmful interference in a residential installation. This equipment generates, uses, and can radiate radio frequency energy and, if not installed and used in accordance with the instructions, may cause harmful interference to radio communications. However, there is no guarantee that interference will not occur in a particular installation. If this equipment does cause harmful interference or television reception, which can be determined by turning the equipment off and on, the user is encouraged to try to correct the interference by one or more of the following measures:

- Reorient or relocate the receiving antenna.
- Increase the separation between the equipment and receiver.
- Connect the equipment into an outlet on a circuit different from that to which the receiver is connected.
- Consult the dealer or an experienced radio/TV technician for help.

FCC Radiation Exposure Statement

FCC Radiation Exposure Statement: This equipment complies with FCC Radiation exposure limits set forth for an uncontrolled environment. This device and its antenna must not be co-located or operating in conjunction with any other antenna or transmitter.

This equipment should be installed and operated with a minimum distance of 20 centimeters between the radiator and your body.