

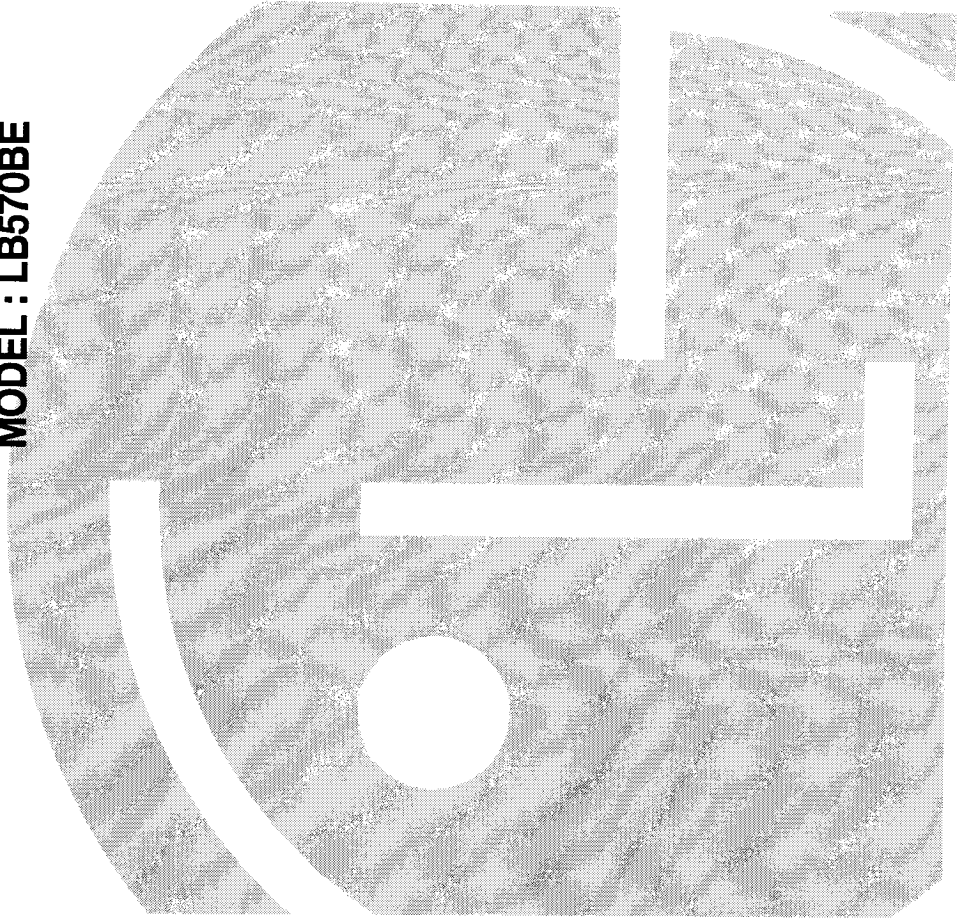

# Color Monitor

OWNER'S MANUAL

MODEL : LB570BE



## AGENCY REGULATORY NOTICE

### FCC Compliance Statement

This equipment has been tested and found to comply with the limits for a Class B digital device pursuant to Part 15 of the FCC Rules. These limits are designed to provide reasonable protection against harmful interference in a residential installation.

This equipment generates, uses, and can radiate radio frequency energy and if not installed and used in accordance with the instructions, may cause harmful interference to radio communications. However, there is no guarantee that interference will not occur in a particular installation.

If this equipment does cause harmful interference to radio or television reception (which can be determined by turning the equipment off and on), the user is encouraged to try to correct the interference by using one or more of the following measures:

- Reorient or relocate the receiving antenna.
- Increase the separation between the equipment and the receiver.
- Connect the equipment into an outlet on a circuit different from that to which the receiver is connected.
- Consult the dealer or an experienced radio/TV technician for help.

**Caution:** Changes or modifications not expressly approved by LG Electronics Inc. for compliance could void the user's (or your) authority to operate the equipment. Only peripherals (digital input/output devices, terminals, printers, etc.) certified to comply with the Class B limits may be attached to this monitor. Operation with non-certified peripherals is likely to result in interference to radio and TV reception.

Only shielded Signal Cables may be used with this System.

**Canadian D.O.C.  
Notice**

This Class B digital apparatus meets all requirements of the Canadian Interference-Causing Equipment Regulations.

Cet appareil numérique de la classe B respecte toutes les exigences du Règlement sur le matériel brouilleur du Canada.

**CE Conformity  
Notice**



Products with the CE Marking comply with the EMC Directive(89/336/EEC) and LOW VOLTAGE Directive (73/23/EEC) issued by the Commission of the European Community.

Compliance with these directives implies conformity to the following European Norms :

f <sup>U</sup> EN 55022	Radio Frequency Interference
f <sup>U</sup> EN 50082-1:1992	Electromagnetic Immunity
f <sup>U</sup> EN 60555-2	Power Line Harmonics
f <sup>U</sup> EN 60555-3	Voltage Fluctuations
f <sup>U</sup> EN 60950	Product Safety

# Environmental Labelling of Personal Computers



## **Congratulations!**

You have just purchased a TCO'99 approved and labelled product! Your choice has provided you with a product developed for professional use. Your purchase has also contributed to reducing the burden on the environment and also to the further development of environmentally adapted electronics products.

This product meets the requirements for the TCO'99 scheme which provides for an international environmental and quality labelling of personal computers. The labelling scheme was developed as a joint effort by the TCO (The Swedish Confederation of Professional Employees), Svenska Naturskyddsforeningen (The Swedish Society for Nature Conservation), Statens Energimyndighet (The Swedish National Energy Administration) and SEMKO AB.

The requirements cover a wide range of issues: environment, ergonomics, usability, reduction of electric and magnetic fields, energy consumption and electrical safety.

## **Why do we have environmentally labelled computers?**

In many countries, environmental labelling has become an established method for encouraging the adaptation of goods and services to the environment. The main problem, as far as computers and other electronics equipment are concerned, is that environmentally harmful substances are used both in the products and during their manufacture. Since it is not so far possible to satisfactorily recycle the majority of electronics equipment, most of these potentially damaging substances sooner or later enter nature.

There are also other characteristics of a computer, such as energy consumption levels, that are important from the viewpoints of both the work (internal) and natural (external) environments. Since all methods of electricity generation have a negative effect on the environment (e.g. acidic and climate-influencing emissions, radioactive waste), it is vital to save energy. Electronics equipment in offices is often left running continuously and thereby consumes a lot of energy.

### **What does the environmental labelling involve?**

The environmental demands has been developed by Svenska Naturskyddsforeningen (The Swedish Society for Nature Conservation). These demands impose restrictions on the presence and use of heavy metals, brominated and chlorinated flame retardants, CFCs (freons) and chlorinated solvents, among other things. The product must be prepared for recycling and the manufacturer is obliged to have an environmental policy which must be adhered to in each country where the company implements its operational policy.

The energy requirements include a demand that the computer and/or display, after a certain period of inactivity, shall reduce its power consumption to a lower level in one or more stages. The length of time to reactivate the computer shall be reasonable for the user.

Below you will find a brief summary of the environmental requirements met by this product. The complete environmental criteria document may be ordered from:

#### **TCO Development**

SE-114 94 Stockholm, Sweden

Fax: +46 8 782 92 07

Email (Internet): [development@tco.se](mailto:development@tco.se)

Current information regarding TCO'99 approved and labelled products may also be obtained via the Internet, using the address: <http://www.tco-info.com/>

### **Environmental requirements**

#### **Flame retardants**

Flame retardants are present in printed circuit boards, cables, wires, casings and housings. Their purpose is to prevent, or at least to delay the spread of fire. Up to 30% of the plastic in a computer casing can consist of flame retardant substances. Most flame retardants contain bromine or chloride, and those flame retardants are chemically related to another group of environmental toxins, PCBs. Both the flame retardants containing bromine or chloride and the PCBs are suspected of giving rise to severe health effects, including reproductive damage in fish-eating birds and mammals, due to the bio-accumulative\* processes. Flame retardants have been found in human blood and researchers fear that disturbances in foetus development may occur.

The relevant TCO'99 demand requires that plastic components weighing more than 25 grams must not contain flame retardants with organically bound bromine or chlorine. Flame retardants are allowed in the printed circuit boards since no substitutes are available.

**Cadmium\*\***

Cadmium is present in rechargeable batteries and in the colour-generating layers of certain computer displays. Cadmium damages the nervous system and is toxic in high doses. The relevant TCO'99 requirement states that batteries, the colour-generating layers of display screens and the electrical or electronics components must not contain any cadmium.

**Mercury\*\***

Mercury is sometimes found in batteries, relays and switches. It damages the nervous system and is toxic in high doses. The relevant TCO'99 requirement states that batteries may not contain any mercury. It also demands that mercury is not present in any of the electrical or electronics components associated with the labelled unit. There is however one exception. Mercury is, for the time being, permitted in the back light system of flat panel monitors as there today is no commercially available alternative. TCO aims on removing this exception when a mercury free alternative is available.

**CFCs (freons)**

The relevant TCO'99 requirement states that neither CFCs nor HCFCs may be used during the manufacture and assembly of the product. CFCs (freons) are sometimes used for washing printed circuit boards. CFCs break down ozone and thereby damage the ozone layer in the stratosphere, causing increased reception on earth of ultraviolet light with e.g. increased risks of skin cancer (malignant melanoma) as a consequence.

**Lead\*\***

Lead can be found in picture tubes, display screens, solders and capacitors. Lead damages the nervous system and in higher doses, causes lead poisoning. The relevant TCO'99 requirement permits the inclusion of lead since no replacement has yet been developed.

# Table of Contents

<b>Introduction</b>	
Features.....	A1
<b>Monitor Registration</b>	
Notice.....	A2
Trademark Acknowledgments .....	A2
<b>Important Precautions</b>	
On Safety.....	A3
On Installation.....	A4
On Cleaning.....	A4
On Repacking.....	A4
<b>Connecting the Monitor</b>	
Connect to any IBM PC .....	A5
Connect to an APPLE Macintosh System .....	A6
<b>Location and Function of Controls</b>	
Front View.....	A7
Rear View .....	A7
<b>On Screen Display (OSD) Control Adjustment .....</b>	<b>A8</b>
<b>Control Panel Function.....</b>	<b>A8</b>
<b>On Screen Display (OSD) Selection and Adjustment .....</b>	<b>A10</b>
<b>Video Memory Modes</b>	
Factory Preset Timing Signal Chart.....	A13
Factory Preset modes.....	A13
User Modes .....	A15
Recalling Display Modes .....	A15
<b>Power Management System</b>	
Power Consumption .....	A16
<b>MPR II, Self Diagnostics and DDC</b>	
Low Radiation Compliance (MPR II).....	A17
Self Diagnostics .....	A17
DDC (Display Data Channel).....	A17
<b>Troubleshooting and Service</b>	
Troubleshooting.....	A18
Service.....	A19
<b>Input Specifications</b>	
Specifications.....	A20
<b>LCD Monitor Limited Warranty.....</b>	<b>A22</b>

## Introduction

The LG **StudioWorks 570LE** Flat Panel Monitor has an active matrix TFT (Thin-Film Transistor) LCD (Liquid Crystal Display).

This monitor is designed for use in small working areas or for those who need more working space on the desk.

## Features

---

The **StudioWorks 570LE** is a 15.1-inch (15.1 inches viewable) intelligent microprocessor based monitor.

Digitally controlled auto-scanning is done with the microprocessor for horizontal scan frequencies between 31 and 69kHz, and vertical scan frequencies between 56 and 85Hz. The microprocessor-based intelligence allows the monitor to operate in each frequency mode with the precision of a fixed frequency monitor.

The microprocessor-based digital controls allow you to adjust conveniently a variety of image controls by using the OSD (On Screen Display).

It supports resolutions up to 1024x768, and has a wide viewing angle of  $\pm 60$  degrees horizontal and  $\pm 45$  degrees vertical.

The monitor is shipped with 16 factory pre-programmed video modes that are permanently resident. In addition, there are 10 user-storable modes, for a total of 26 memory modes.

For greater user health and safety, this monitor complies with the stringent Swedish TCO '99 requirements for low radiation emissions.



## Monitor Registration

The model and serial numbers are found on the rear of this unit. These numbers are unique to this unit and not available to others. You should record requested information here and retain this guide as a permanent record of your purchase. Staple your receipt here.

Date of Purchase : \_\_\_\_\_  
Dealer Purchased From : \_\_\_\_\_  
Dealer Address : \_\_\_\_\_  
Dealer Phone No. : \_\_\_\_\_  
Model No. : \_\_\_\_\_  
Serial No. : \_\_\_\_\_

### Notice

---

All rights reserved. Reproduction in any manner, in whole or in part, is strictly prohibited without the written permission of LG Electronics Inc.

### Trademark Acknowledgments

---

**LG** is a trademark of **LG Electronics Inc.**

**IBM** is a registered trademark and **VGA** is a trademark of International Business Machines Corporation.

**WARNING** : To reduce the risk of fire or electric shock, do not expose this appliance to rain or moisture.

**AVERTISSEMENT** : Ne pas placer cet appareil dans un endroit humide.  
Cela peut entraîner un incendie ou une décharge électrique.

## Important Precautions

This unit has been engineered and manufactured to assure your personal safety, but improper use can result in potential electrical shock or fire hazard. In order not to defeat the safeguards incorporated in this monitor, observe the following basic rules for its installation, use, and servicing. Also follow all warnings and instructions marked directly on your monitor.

### On Safety

---

1. Use only the power cord supplied with the unit. In case you use another power cord, make sure that it is certified by the applicable standards (UL/CSA or VDE) if not being provided by the supplier. Power cord must meet the requirements of the country where you use the monitor. For more information on power cord requirements, contact your LG authorized dealer, reseller, or service provider.
2. Operate the monitor only from a power source indicated in the specifications of this manual or listed on the monitor. If you are not sure what type of power supply you have in your home, consult your dealer.
3. Overloaded AC outlets and extension cords are dangerous. So are frayed power cords and broken plugs. They may result in a shock or fire hazard. Call your service technician for replacement.
4.  **DO NOT OPEN THE MONITOR.** There are no user-serviceable components inside. There are Dangerous High Voltages inside, even when the power is OFF. Contact your dealer if the monitor is not operating properly.
5. To avoid personal injury :
  - Do not place the monitor on a sloping shelf unless properly secured.
  - Use only a stand recommended by the manufacturer.
  - Do not try to roll a stand with small casters across thresholds or deep pile carpets.
6. To prevent Fire or Hazards:
  - Always turn the monitor OFF if you leave the room for more than a short period of time. Never leave the monitor ON when leaving the house or office.
  - Keep children from dropping or pushing objects into the monitor's cabinet openings. Some internal parts carry hazardous voltages.
  - Do not add accessories that have not been designed for this monitor.
  - During a lightning storm or when the monitor is to be left unattended for an extended period of time, unplug it from the wall outlet.
  - Do not bring magnetic devices such as magnets or motors near the picture tube.

## On Installation

---

1. Do not allow anything to rest upon or roll over the power cord, and do not place the monitor where the power cord is subject to damage.
2. Do not use this monitor near water such as near a bathtub, washbowl, kitchen sink, laundry tub, in a wet basement, or near a swimming pool.
3. Monitors are provided with ventilation openings in the cabinet to allow the release of heat generated during operation. If these openings are blocked, built-up heat can cause failures which may result in a fire hazard. Therefore, NEVER:
  - Block the bottom ventilation slots by placing the monitor on a bed, sofa, rug, etc.
  - Place the monitor in a built-in enclosure unless proper ventilation is provided.
  - Cover the openings with cloth or other material.
  - Place the monitor near or over a radiator or heat source.
4. Do not rub or strike the Active Matrix LCD with anything hard as this may scratch, mar, or damage the Active Matrix LCD permanently.
5. Do not press the LCD screen with your finger for a long time as this may incur some afterimages.
6. Some dot defects may appear on the screen, like Red, Green or Blue spots on the screen. However, this will have no impact or effect on the monitor performance.
7. If possible, use the VESA 1024x768 @60Hz video mode to obtain the best image quality for your LCD monitor. If used under any modes except the VESA 1024x768 @60Hz video mode, some scaled or processed images may appear on the screen. However, this is the characteristics of the LCD panel which has a fixed resolution of 1024x768 at 60Hz.

## On Cleaning

---

- Unplug the monitor before cleaning the face of the LCD Screen.
- Dust the monitor by wiping the screen and the cabinet with a soft, clean cloth. If the screen requires additional cleaning, use a clean, damp cloth.
- Do not use liquid cleaners or aerosol cleaners.

## On Repacking

---

- Do not throw away the carton and packing materials. They make an ideal container in which to transport the unit. When shipping the unit to another location, repack it in its original material.

## Connecting the Monitor

On the back of the monitor are two plug-in connections; one for the AC power cord, and the other is for the signal cable from the video card.

### Connect to any IBM PC

- 1 Power off both the monitor and PC.
- 2 Connect the 15-pin VGA connector of the supplied signal cable to the output VGA video connector on the PC and the matching input connector on the rear of the monitor. The connectors will mate only one way. If you cannot attach the cable easily, turn the connector upside down and try again. When mated, tighten the thumbscrews to secure the connection.
- 3 Connect the plug from the AC-DC adapter into the connector on the display unit. ① Connect one end of the AC power cord into the AC-DC adapter. ② Plug the other end into a properly grounded three-prong AC outlet. ③
- 4 Power ON the PC, then the monitor.
- 5 If you see the **Check Signal Cable** message, check the signal cable and connectors.
- 6 After using the system, power OFF the monitor, then the PC.

**Note :** If you see the "Outside Range Limits" message, check to make sure your system is set to one of the factory preset modes.(see page A14)

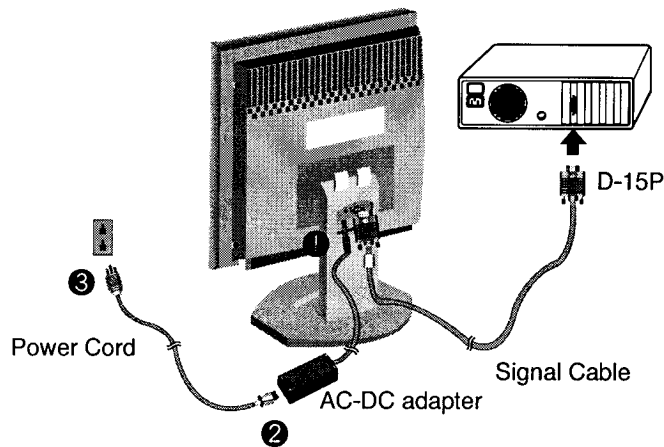

---

## Connect to an APPLE Macintosh System

---

Figure shows the connection to an Apple Macintosh, using a separately purchased adapter. For more information on adapter requirements, contact your LG authorized dealer, reseller, or service provider.

- 1** Power OFF both the monitor and the PC.
- 2** Locate the appropriate MAC to VGA adapter block at your local computer store. This adapter changes the high density 3 row 15 pin VGA connector to the correct 15 pin 2 row connection to mate with your MAC. Attach the other end of the signal cable to the side of the adapter block with 3 rows.
- 3** Connect the attached adapter block/signal cable to the video output on your MAC.
- 4** Connect the plug from the AC-DC adapter into the connector on the display unit.
  - 1** Connect one end of the AC power cord into the AC-DC adapter.
  - 2** Plug the other end into a properly grounded three-prong AC outlet.
  - 3**
- 5** Power ON the PC, then the monitor.
- 6** If you see the **Check Signal Cable** message, check the signal cable and connectors.
- 7** After using the system, power OFF the monitor, then the PC.

**Note :** If you see the "Outside Range Limits" message, check to make sure your system is set to one of the factory preset modes.(see page A14)

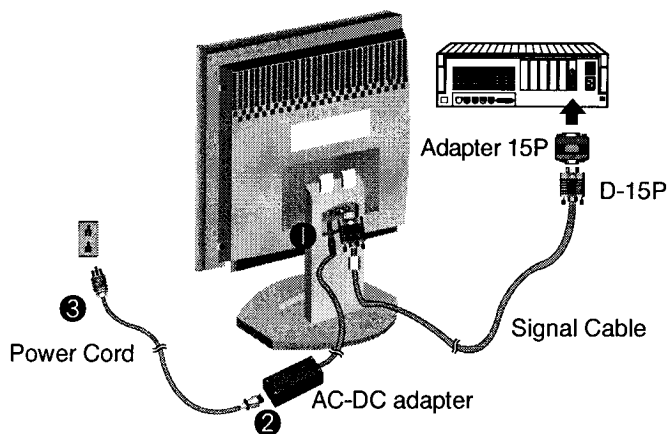

# Location and Function of Controls

## Front View

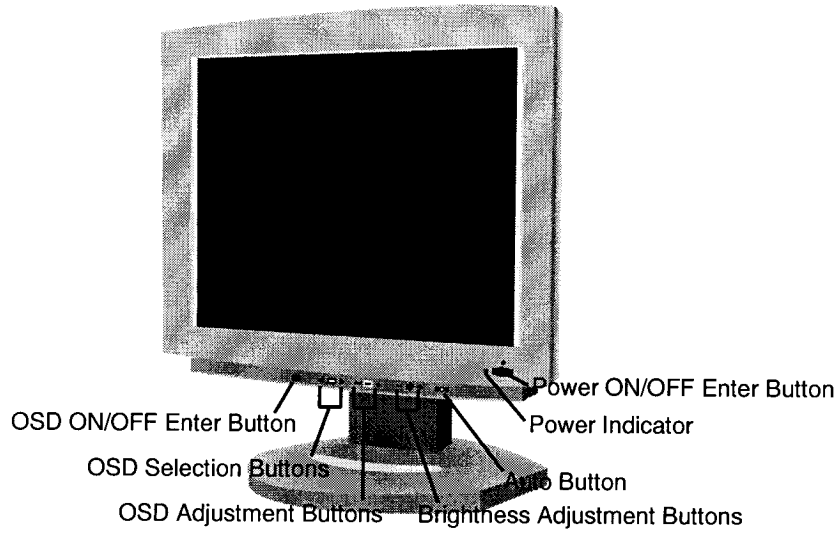

## Rear View

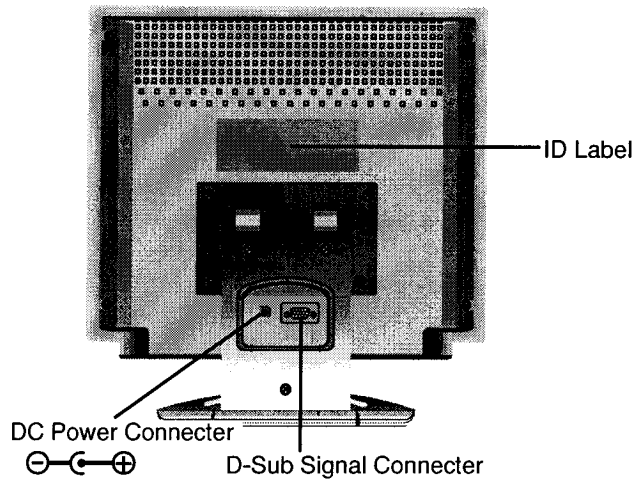

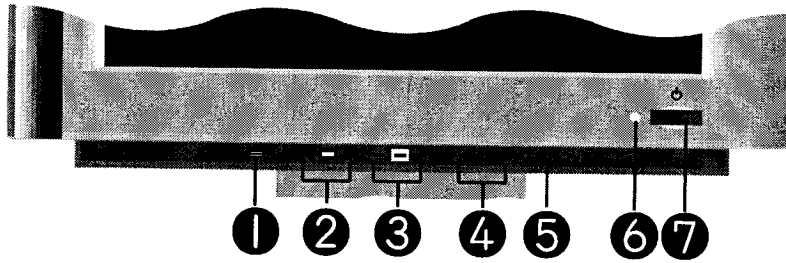

## On Screen Display(OSD) Control Adjustment

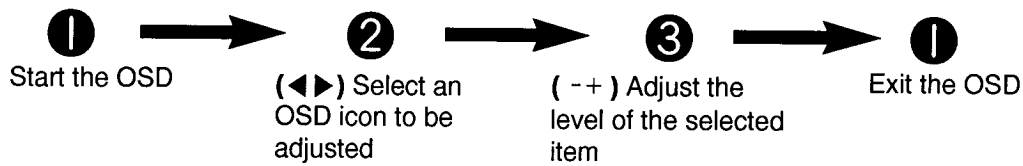

## Control Panel Function

Buttons on the underside of the monitor allow you to adjust the image easily through an OSD menu. As you choose controls, the selected icon shows you what the chosen control will do. These pictures give you immediate understanding of the controls. The following is a description of use for each button.

- 1** **OSD ON/OFF Enter Button (☰)**  
Use this button to start and exit from the On Screen Display (OSD).
- 2** **OSD Selection Buttons (◀▶)**  
Use these buttons for selecting (highlighting) an OSD icon to be adjusted.
- 3** **OSD Adjustment Buttons (-+)**  
Use these buttons for adjusting the level of the selected item.
- 4** **Brightness Adjustment Buttons (☀)**  
Use these buttons for adjusting the brightness of screen.



### 5 AUTO Button ( AUTO )

This button is for the automatic adjustment of the screen position, clock and clock phase. The displayed image will disappear for a few seconds while the Auto-configuration is in process.

**Note:** Some signal from some graphics boards may not function properly. **If the results are unsatisfactory**, adjust your monitor's Position, Clock and Clock Phase manually.

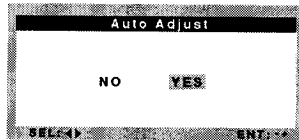

### 6 Power Indicator ( o )

This Indicator lights up green when the monitor operates normally.

If the monitor is in DPM (Energy Saving) mode (stand-by/ suspend/power off), this indicator color changes to amber.

### 7 Power ON/OFF Enter Button ( o )



This button is used to turn the monitor ON and OFF.





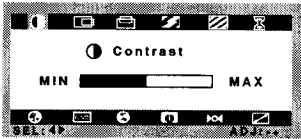
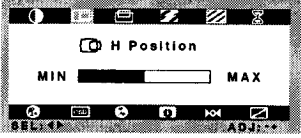
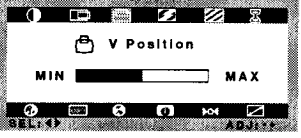
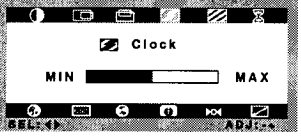

## On Screen Display (OSD) Selection and Adjustment





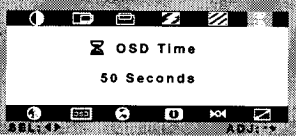

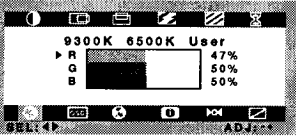
You were introduced to the procedure of selection and adjusting an item using the OSD system.

Listed below are the icons, icon names, and icon descriptions of the items that are shown on the Menu.

OSD Adjust	Description
 <p>The image shows the OSD menu for Contrast. It features a central horizontal slider bar with 'MIN' on the left and 'MAX' on the right. Above the slider is the text 'Contrast' and below it is a small icon of a circle with a vertical line. The background is dark with various icons at the top and bottom.</p>	<p>To adjust the display to the contrast desired.</p>
 <p>The image shows the OSD menu for H Position. It features a central horizontal slider bar with 'MIN' on the left and 'MAX' on the right. Above the slider is the text 'H Position' and below it is a small icon of a square with a horizontal line. The background is dark with various icons at the top and bottom.</p>	<p>To move picture image left and right.</p> <ul style="list-style-type: none"> <li>- Moves the screen image left.</li> <li>+ Moves the screen image right.</li> </ul>
 <p>The image shows the OSD menu for V Position. It features a central horizontal slider bar with 'MIN' on the left and 'MAX' on the right. Above the slider is the text 'V Position' and below it is a small icon of a square with a vertical line. The background is dark with various icons at the top and bottom.</p>	<p>To move image up and down.</p> <ul style="list-style-type: none"> <li>- Moves the screen image down.</li> <li>+ Moves the screen image up.</li> </ul>
 <p>The image shows the OSD menu for Clock. It features a central horizontal slider bar with 'MIN' on the left and 'MAX' on the right. Above the slider is the text 'Clock' and below it is a small icon of a square with a diagonal line. The background is dark with various icons at the top and bottom.</p>	<p>To adjust the horizontal size of the image.</p> <ul style="list-style-type: none"> <li>- Decrease the horizontal size of the image.</li> <li>+ Increase the horizontal size of the image.</li> </ul>
 <p>The image shows the OSD menu for Clock Phase. It features a central horizontal slider bar with 'MIN' on the left and 'MAX' on the right. Above the slider is the text 'Clock Phase' and below it is a small icon of a square with a diagonal line. The background is dark with various icons at the top and bottom.</p>	<p>To adjust the focus of the display. This item allows you to remove any horizontal noise and clear or sharpen the image of characters.</p>

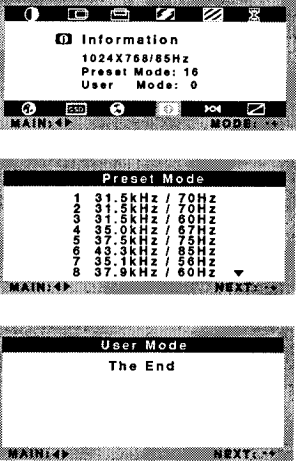
## On Screen Display (OSD) Selection and Adjustment

OSD Adjust	Description
<p> <b>OSD Time</b></p> 	<p>To select OSD display duration time. (5 - 100 seconds)</p>
<p> <b>Color Select</b></p>  	<p>To select color temperature, 9300K/ 6500K and USER.</p> <p><b>9300K</b> : Slightly bluish white.  <b>6500K</b> : Warm-white tone, similar to white paper or daylight. This temperature is good for video-image display. This is the default setting for your monitor.</p> <p>Select the desired color temperature or select user to set your own color levels.          To adjust <b>USER</b>, select the + button. Allow for specific adjustments to Red, Green, Blue (R/G/B) and (Color) Recall. Select the <b>Recall</b> to reset the color to the default setting.</p>
<p> <b>OSD Position</b></p> 	<p>This item gives access to 2 elements : Horizontal position and Vertical position.          Press the select button to select the desired item to change.          To correct OSD image's Horizontal position and Vertical position.  <b>Horizontal position</b> : To move image right and left.  <b>Vertical position</b> : To move image up and down.</p>

OSD Adjust	Description																											
<p> <b>Language Select</b></p> 	<p>To choose the language in which the control names are displayed. OSD Menus are available in five language : <b>English, German, French, Spanish, and Italian.</b></p>																											
<p> <b>Information</b></p>  <table border="1" data-bbox="354 863 651 989"> <thead> <tr> <th colspan="3">Preset Mode</th> </tr> </thead> <tbody> <tr> <td>1</td> <td>31.5kHz / 70Hz</td> <td></td> </tr> <tr> <td>2</td> <td>31.5kHz / 70Hz</td> <td></td> </tr> <tr> <td>3</td> <td>31.5kHz / 60Hz</td> <td></td> </tr> <tr> <td>4</td> <td>35.0kHz / 67Hz</td> <td></td> </tr> <tr> <td>5</td> <td>37.5kHz / 75Hz</td> <td></td> </tr> <tr> <td>6</td> <td>43.3kHz / 85Hz</td> <td></td> </tr> <tr> <td>7</td> <td>35.1kHz / 56Hz</td> <td></td> </tr> <tr> <td>8</td> <td>37.9kHz / 60Hz</td> <td></td> </tr> </tbody> </table> <p>User Mode The End</p>	Preset Mode			1	31.5kHz / 70Hz		2	31.5kHz / 70Hz		3	31.5kHz / 60Hz		4	35.0kHz / 67Hz		5	37.5kHz / 75Hz		6	43.3kHz / 85Hz		7	35.1kHz / 56Hz		8	37.9kHz / 60Hz		<p>To inform users of preset and user mode data.</p>
Preset Mode																												
1	31.5kHz / 70Hz																											
2	31.5kHz / 70Hz																											
3	31.5kHz / 60Hz																											
4	35.0kHz / 67Hz																											
5	37.5kHz / 75Hz																											
6	43.3kHz / 85Hz																											
7	35.1kHz / 56Hz																											
8	37.9kHz / 60Hz																											
<p> <b>Mode Recall</b></p> 	<p>If the monitor is operating in a factory preset mode, this control will reset the image to the factory preset mode. If the monitor is operating in a user mode, this control has no effect.</p>																											
<p> <b>Image Size</b></p> 	<p>This function displays the image in its original size or enlarged size so as to fit in the full screen of the LCD panel.</p>																											

# Video Memory Modes

The monitor has 26 memory locations for display modes, 16 of which are factory preset to popular video modes.

## Factory Preset Timing Signal Chart

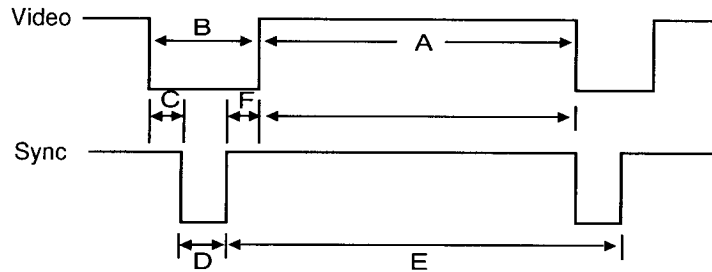

		Mode1	Mode2	Mode3	Mode4	Mode5	Mode6	Mode7	Mode8	Symbol	
H O R I Z O N T A L	Polarity	+	-	-	-	-	-	+	+		
	Frequency	kHz	31.468	31.468	31.469	35.00	37.50	43.27	35.156	37.879	
	Total Period	pixels	800	900	800	864	840	832	1024	1056	E
	Data Period	pixels	640	720	640	640	640	640	800	800	A
	Blanking	pixels	160	180	160	224	200	192	224	256	B
	Front Porch	pixels	16	17	16	64	16	56	24	40	C
	Pulse Width	pixels	96	108	96	64	64	56	72	128	D
	Back Porch	pixels	48	55	48	96	120	80	128	88	F
V E R T I C A L	Polarity	-	+	-	-	-	-	+	+		
	Frequency	Hz	70	70	60	66.67	75.0	85.0	56.25	60.3	
	Total Period	lines	449	449	525	525	500	509	625	628	E
	Data Period	lines	350	400	480	480	480	480	600	600	A
	Blanking	lines	99	49	45	45	20	29	25	28	B
	Front Porch	lines	12	13	10	3	1	1	1	1	C
	Pulse Width	lines	2	2	2	3	3	3	2	4	D
	Back Porch	lines	35	34	33	39	16	25	22	23	F
Resolution		640 x 350	720 x 400 (Text)	640 x 480	640 x 480	640 x 480	640 x 480	800 x 600	800 x 600		
Recall		YES	YES	YES	YES	YES	YES	YES	YES		

## Factory Preset Modes

		Mode9	Mode10	Mode11	Mode12	Mode13	Mode14	Mode15	Mode16	Symbol	
H O R I Z O N T A L	Polarity	+	+	+	-	-	-	+	-		
	Frequency	kHz	48.077	46.875	53.670	49.725	48.363	56.476	60.023	68.670	
	Total Period	pixels	1040	1056	1048	1152	1344	1328	1312	1376	E
	Data Period	pixels	800	800	800	832	1024	1024	1024	1024	A
	Blanking	pixels	240	256	248	320	320	304	288	352	B
	Front Porch	pixels	56	16	32	32	24	24	16	48	C
	Pulse Width	pixels	120	80	64	64	136	136	96	96	D
	Back Porch	pixels	64	160	152	224	160	144	176	208	F
V E R T I C A L	Polarity	+	+	+	-	-	-	+	-		
	Frequency	Hz	72.188	75.0	85.06	74.55	60.0	70.0	75.0	85	
	Total Period	lines	666	625	631	667	806	806	800	808	E
	Data Period	lines	600	600	600	624	768	768	768	768	A
	Blanking	lines	66	25	31	43	38	38	32	40	B
	Front Porch	lines	37	1	1	1	3	3	1	1	C
	Pulse Width	lines	6	3	3	3	6	6	3	3	D
	Back Porch	lines	23	21	27	39	29	29	28	36	F
Resolution		800 x 600	800 x 600	800 x 600	832 x 624 (MAC)	1024 x 768	1024 x 768	1024 x 768	1024 x 768		
Recall		YES	YES	YES	YES	YES	YES	YES	YES		

**Note :** This LCD monitor has been pre-adjusted to the video mode of VESA 1024x768 @60Hz.

## **User Modes**

---

Modes 17-26 are empty and can accept new video data. If the monitor detects a new video mode that has not been present before or is not one of the preset modes, it stores the new mode automatically in one of the empty modes starting with mode 17.

If you use the 4 blank modes and still have more new video modes, the monitor replaces the information in the user modes starting with mode 17.

## **Recalling Display Modes**

---

When your monitor detects a mode it has seen before, it automatically recalls the image settings you may have made the last time you used that mode.

You may, however, manually force a recall of each of the 16 preset modes by pressing the Recall button. All preset modes are automatically recalled as the monitor senses the incoming signal.

The ability to recall the preset modes is dependent on the signal coming from your PC's video card or system. If this signal does not match any of the factory modes, the monitor automatically sets itself to display the image.

## Power Management System

This monitor incorporates new circuitry for lowering energy usage during idle time, following the Display Power Management Signalling (DPMS) guide lines of the Video Electronics Standards Association (VESA), and is certified as exceeding the EPA's Energy Star program for reduced power usage.

For the power savings feature to operate, the monitor must be used with a PC having power saving circuitry. The monitor has three power-saving states, and the power saving operation is indicated by the power indicator on the front panel. When the power indicator is green, operation is normal. When the power indicator is amber, the monitor is in a power saving mode.

If the power indicator is amber, press the power button to turn on the monitor. If the power indicator is amber and you wish to use the PC again, move your mouse pointer or touch a keyboard button. When the monitor is not in use, save energy by turning it off.

### Power Consumption

Mode	H.Sync	V.Sync	Video	Power Consumption	LED Color
Normal(Max.)	On	On	Normal	≤ 40W	Green
Stand-by	Off	On	Off	≤ 5W	Amber
Suspend	On	Off	Off	≤ 5W	Amber
Power off	Off	Off	Off	≤ 5W	Amber

## Low Radiation Compliance (MPR II)

This monitor meets one of the strictest guidelines available today for low radiation emissions, offering the user extra shielding and an anti-static screen coating. These guidelines, set forth by a government agency in Sweden, limit the amount of emission allowed in the Extremely Low Frequency (ELF) and Very Low Frequency (VLF) electromagnetic range.

## Self Diagnostics

This monitor can sense when there is a possible problem present and informs you of this condition by presenting you with a **SELF DIAGNOSTICS** OSD. This OSD may pop up when it is **ON** but no signal is detected. In this case the message **Check Signal Cable** will be highlighted, alerting you to check the signal cable connections.



## DDC (Display Data Channel)

DDC is a communication channel over which the monitor automatically informs the host system (PC) about its capabilities. This monitor has two DDC functions; DDC1, DDC2B carries out uni-directional communication between the PC and the monitor. Under these situations, the PC sends display data to the monitor but not commands to control the monitor settings.

- NOTE :**
- PC must support DDC functions to do this.
  - Some older computer systems are not compatible with the DDC standard. If your monitor is displaying a monochrome image or the wrong resolution, you need to change to a DDC compatible VGA card.



## Troubleshooting

### Display Position is incorrect.

- Push the **AUTO** Button and select **YES**.
  - If the results are unsatisfactory, adjust the image position using the H position and V position icon in the on screen display.
- 

### On the screen background, vertical bars or stripes are visible.

- Push the **AUTO** Button and select **YES**.
  - If the results are unsatisfactory, decrease the vertical bars or stripes using the **Clock** icon in the on screen display.
- 

### Any horizontal noise appearing in any image or characters are not clearly portraided.

- Push the **AUTO** Button and select **YES**.
  - If the results are unsatisfactory, decrease the horizontal bars using the **Clock Phase** icon in the on screen display.
- 

### Check Signal Cable message.

- The signal cable is not connected, or is loose. Check and secure the connection.
- 

### Outside Range Limits message appears.

#### Picture is blank.

- The frequency of the signal from the video card is outside the operating range of the monitor.
    - Horizontal Frequency : 31kHz - 69kHz**
    - Vertical Frequency : 56kHz - 85kHz**
  - \* Use the graphics board's utility software to change the frequency setting (Refer to the manual for graphics board).
  - \* You can change the setup to the supported resolution using the **Safe Mode** (Press the F8 key during booting the system).
- 

### The power LED is illuminated amber.

- The monitor is in its display power management mode.
  - There is no active signal coming from the PC.
  - The signal cable is not fastened securely.
  - Check the computer power and graphics adapter configuration.
- 

### The monitor doesn't enter the power saving off mode (Amber).

- Computer video signal is not VESA DPMS standard. Either the PC or the video controller card is not using the VESA DPMS power management function.

## Service

1. Unplug the monitor from the wall outlet and refer servicing to qualified service personnel when:
  - The power cord or plug is damaged or frayed.
  - Liquid has been spilled into the monitor.
  - The monitor has been exposed to rain or water.
  - The monitor does not operate normally following the operating instructions. Adjust only those controls that are covered in the operating instructions. An improper adjustment of other controls may result in damage and often requires extensive work by a qualified technician to restore the monitor to normal operation.
  - The monitor has been dropped or the cabinet has been damaged.
  - The monitor exhibits a distinct change in performance.
  - Snapping or popping from the monitor is continuous or frequent while the monitor is operating. It is normal for some monitors to make occasional sounds when being turned on or off, or when changing video modes.
2. Do not attempt to service the monitor yourself, as opening or removing covers may expose you to dangerous voltage or other hazards. Refer all servicing to qualified service personnel.

# Specifications

## Sync Signal type

Type	H. sync	V. sync
Separate sync	H. sync	V. sync

## Signal Connector Pin Assignment

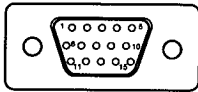

Pin	Separate Sync	Pin	Separate Sync
1	Red	9	NC
2	Green	10	Ground
3	Blue	11	Ground
4	Ground	12	SDA
5	Self-Test	13	Horizontal Sync
6	Red Ground	14	Vertical Sync
7	Green Ground	15	SCL
8	Blue Ground		

## AC-DC Adapter

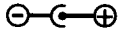
Input	AC 100-240V 50-60Hz 81-120VA 1.2A
Out put	DC 24V 1.9A 

Use only the AC-DC adapter supplied with the monitor.

## Specifications

<b>Display</b>		
Type	15.1inch (38.35cm) Flat Panel Active matrix-TFT LCD, Anti-Glare coating	
Viewable Size	15.1inch (38.35cm)	
Pixel pitch	0.3 x 0.3mm	
True color	16.7million	
<b>Sync Input</b>		
Horizontal Freq.	31kHz - 69kHz (Automatic)	
Vertical Freq.	56Hz - 85Hz (Automatic)	
Input form	Separate, TTL, Positive/Negative	
Signal input	15 pin D-Sub connector	
<b>Video Input</b>		
Display Area	307 x 230mm	
Input Form	Separate, RGB Analog, 0.714Vp-p/75ohm, Positive	
<b>Resolution</b>	<b>XGA 1024 x 768/ 85Hz max</b>	
<b>Power Input</b>	DC 24V 1.2A	
<b>Dimensions</b> (WxDxH)	15.95 x 7.18 x 14.24inch / 405.2 x 182.4 x 361.6mm	
<b>Weight ( net )</b>	5.2kg / 11.46lbs	
<b>Tilt Range</b>		
Down	5°	
Up	30°	
<b>Environment</b>		
Operating condition		
	Temperature	10°C to 35°C
	Humidity	10% to 80% non-condensing
Storage condition		
	Temperature	-20°C to 60°C
	Humidity	5% to 95% non-condensing

Information in this document is subject to change without notice and does not represent a commitment on the part of LG Electronics Inc.