

Car AVN User Manual

Model Name : LC10S-B

1. Overview and Specifications

(1) Overview

1) The Infotainment system provides Infotainment in your car, using the latest technology. See your dealer to have the system or software updated and upgraded.

2) The Infotainment system can play the USB storage device or iPod/iPhone products.

4) The Bluetooth phone connection function allows for the use of wireless hands-free

Phone calls, as well as a phone music player.

In addition, the WiFi function is provided.

5) Connect a portable music player to the auxiliary sound input to enjoy the rich sound of the Infotainment system.

(2) Specifications

*Product

Item	Categories	Specifications	
Specification	Product Name	Silverbox RADIO ASM-RECEIVER	
	Model	LC10S	
	Dimensions	Refer to image	
	Weight	Monitor+Key	: 1.3kg
		Silver box	: 0.887kg (DAB)
	Power source	DC 12V	
Operational temperature range	-30 ~ 80		

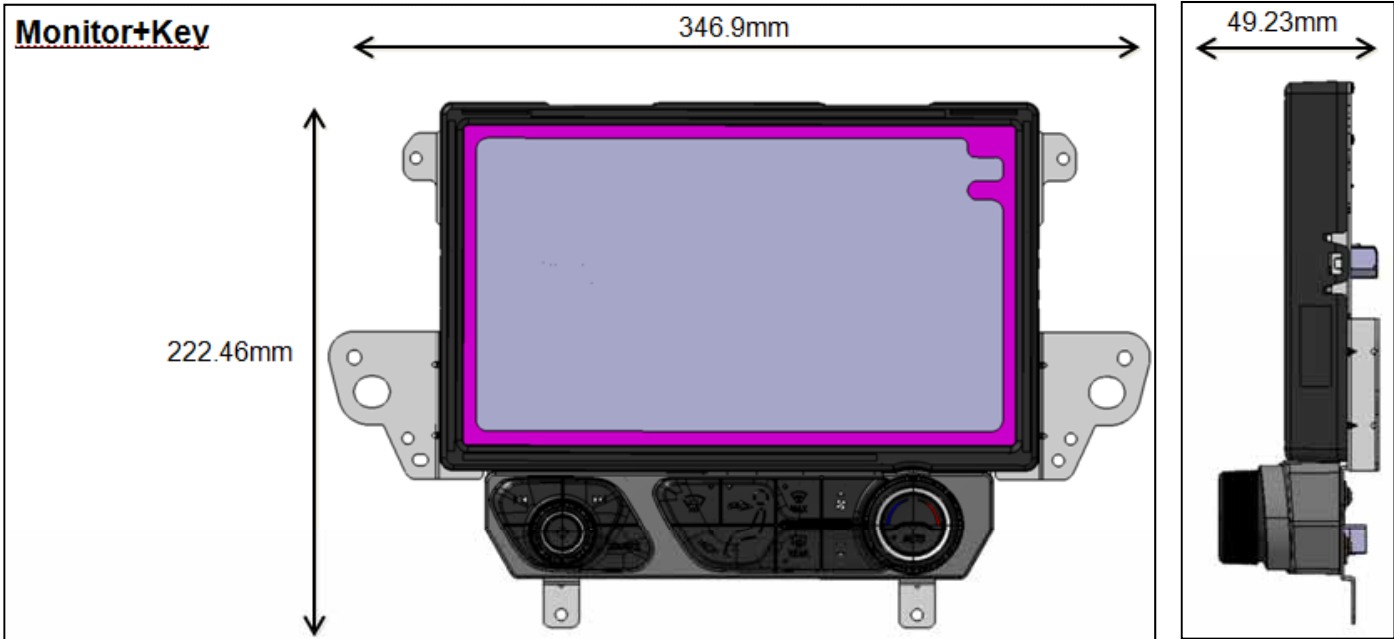

Silver Box

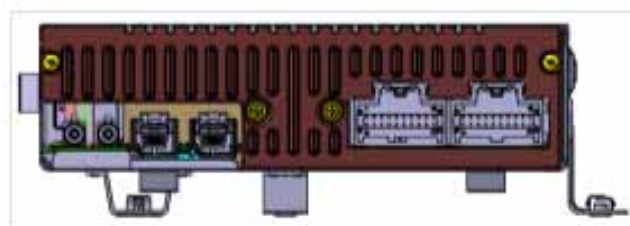
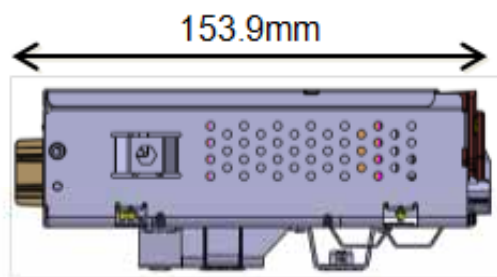
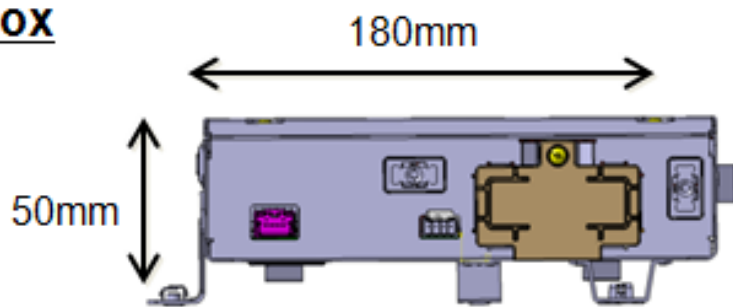

*RF specifications

[BT]

Item	Specifications	Unit
Frequency	2400 ~2483.5	MHz
Modulation Type	GFSK, $\pi/4$ -DQPSK, 8-DPSK	
BT Power	Power class 2	
Datarate	1 ~ 3	Mbps
channel spacing	1	MHz
BT version	BT 3.0	

[WiFi]

Item	Specifications	Unit	
Standard	IEEE 802.11 a/b/g/n		
Frequency	2.4G	2400 ~ 2484	MHz
	5G	5G~6G	GHz
Bandwidth	20	MHz	
Datarate	802.11 b	1, 2, 5.5, 11	Mbps
	802.11 g	6, 9, 12, 18, 24, 36, 48, 54	Mbps
	802.11 a (5G)	6, 9, 12, 18, 24, 36, 48, 54	Mbps
	802.11 n (2.4G / 5G)	6.5, 13, 19.5, 26, 39, 52, 58.5, 65	Mbps
Modulation	DSSS / OFDM		
Mode	AP, Station, Peer to Peer		

2. Component

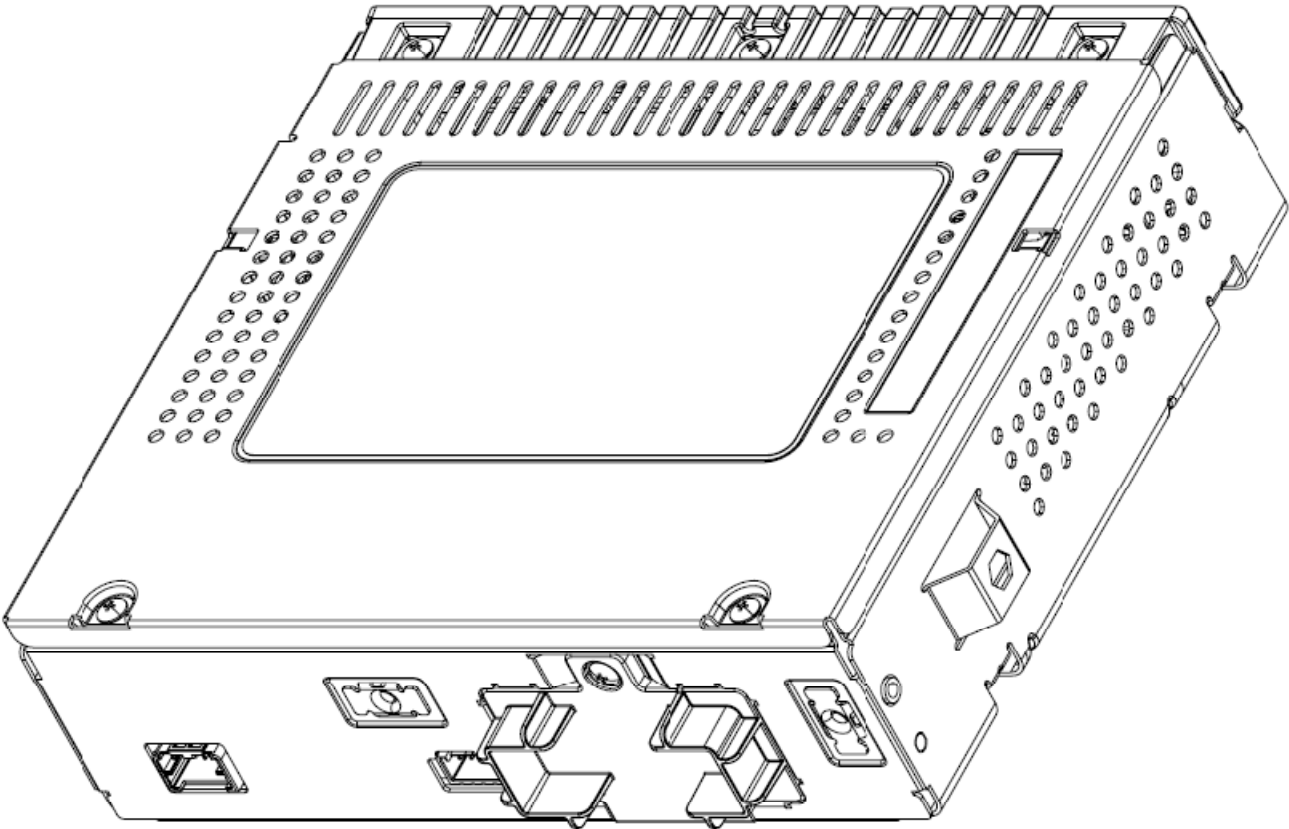

3. Operation

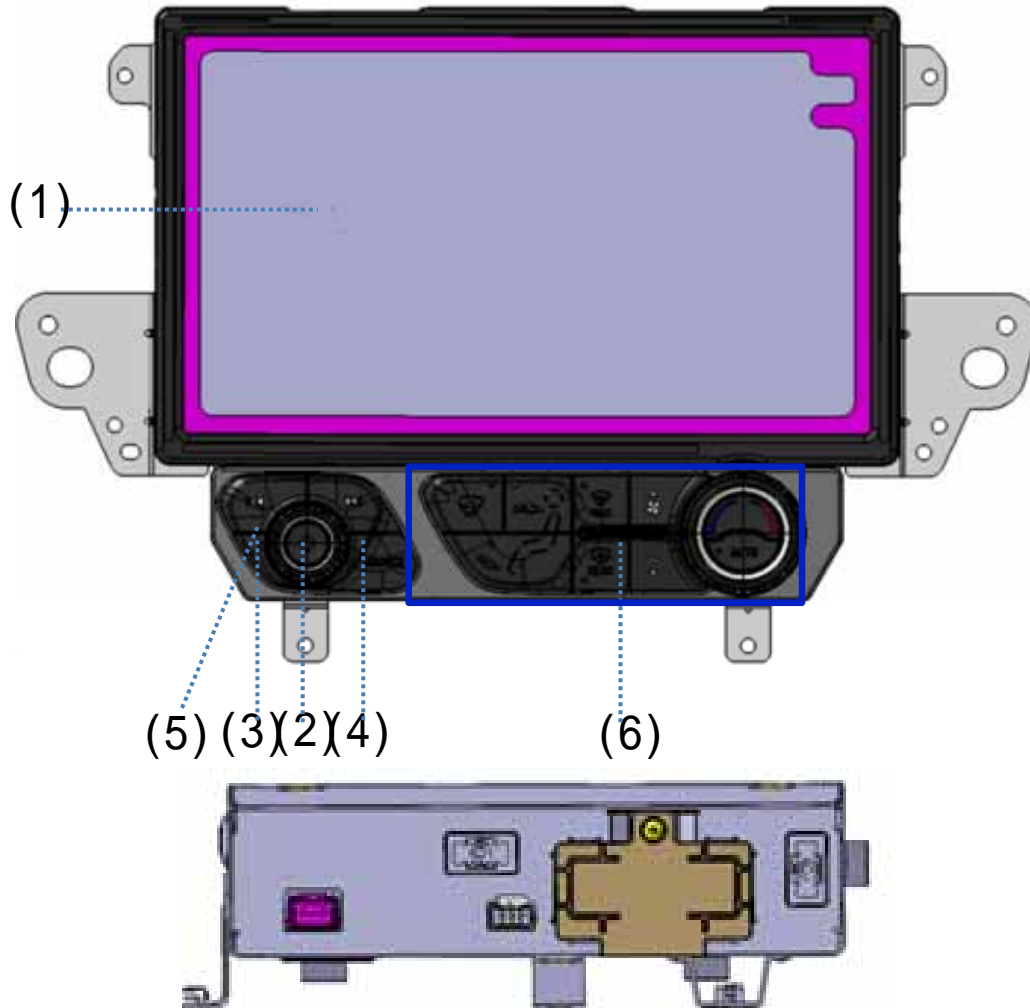

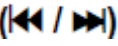

Item (#No.)	Descriptions
(1) Display	Display for Play/Reception/Menu state and information.
(2) POWER button 	Press and hold this button to turn the power on/off. Press this button to turn the mute function on/off.
(3)/(4) Seek button 	Press this button to seek the station or media contents.
(5) Volume knob	Rotate the Volume knob to adjust the volume.
(6) etc.	Control Heating System, Air Conditioning System, And Ventilation System

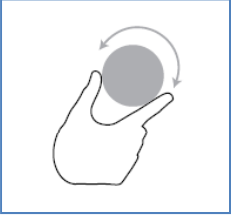
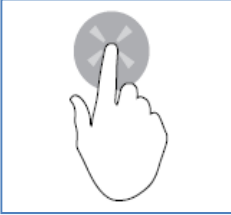
(7) Interactions | Rotary Knob

*Rotate Users can rotate the Volume knob on the faceplate.	*Push Users can press on the center of the rotary-push knob to mute volume.
	

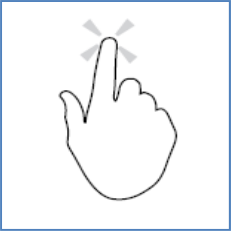
(8) Touch Gestures

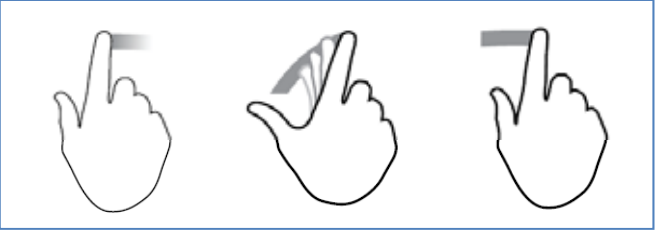
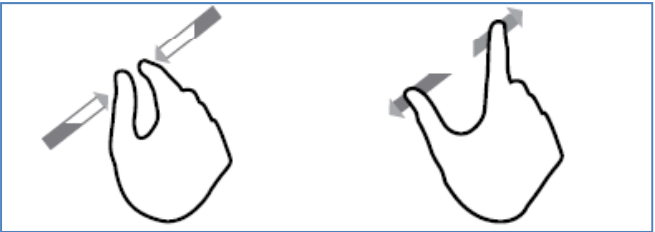
*Tap	*Press & Hold
	
*Fling/Swipe	
	
*Pinch & Spread	
	

4. Precautions

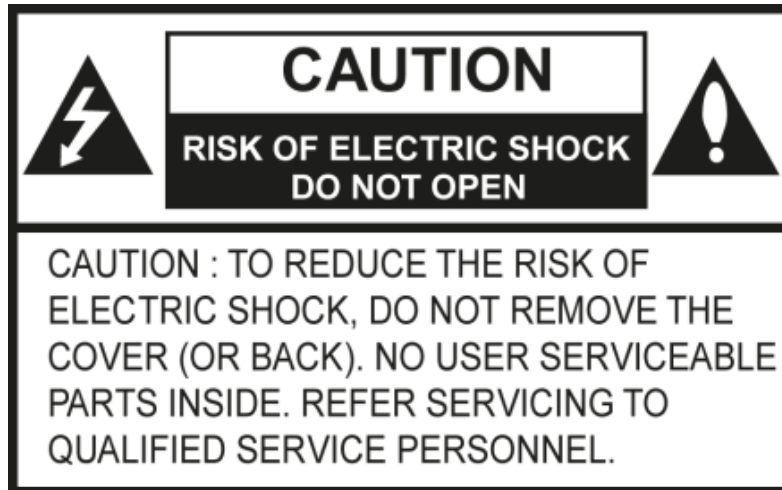

- 1) Always operate the vehicle in a safe manner. Do not become distracted by the vehicle while driving and always be fully aware of all driving conditions. Do not change settings or any functions. Pull over in a safe and legal manner before attempting such operations. To promote safety, certain functions are disabled unless the parking brake is on.
- 2) To reduce the risk of electric shock, do not remove the cover or back of this product. There are no user-serviceable parts inside. Refer servicing to qualified service personnel.
- 3) To reduce the risk of fire or electric shock, do not expose this product to dripping or splashing water, rain, or moisture.
- 4) When driving your vehicle, be sure to keep the volume of the unit low enough to allow you to hear sounds coming from the outside.
- 5) Do not drop it and avoid heavy impacts at anytime.
- 6) The driver should not watch the monitor while driving. If the driver watches the monitor while driving, it may lead to carelessness and cause an accident.

FEDERAL COMMUNICATIONS COMMISSION INTERFERENCE STATEMENT

This equipment has been tested and found to comply with the limits for a Class B digital device, pursuant to Part 15 of the FCC Rules. These limits are designed to provide reasonable protection against harmful interference in a residential installation. This equipment generates, uses and can radiate radio frequency energy and, if not installed and used in accordance with the instructions, may cause harmful interference to radio communications. However, there is no guarantee that interference will not occur in a particular installation. If this equipment does cause harmful interference to radio or television reception, which can be determined by turning the equipment off and on, the user is encouraged to try to correct the interference by one or more of the following measures:

- Reorient or relocate the receiving antenna.
- Increase the separation between the equipment and receiver.
- Connect the equipment into an outlet on a circuit different from that to which the receiver is connected.
- Consult the dealer or an experienced radio/TV technician for help.

CAUTION:

To assure continued FCC compliance:

Any changes or modifications not expressly approved by the grantee of this device could void the user's authority to operate the equipment.

FCC Label Compliance Statement:

This device complies with Part 15 of the FCC Rules. Operation is subject to the following two conditions: (1) this device may not cause harmful interference, and (2) this device must accept any interference received, including interference that may cause undesired operation.

IC Warning Statement

- English Warning Statement:

"This device complies with Industry Canada licence-exempt RSS standard(s). Operation is subject to the following two conditions: (1) this device may not cause interference, and (2) this device must accept any interference, including interference that may cause undesired operation of the device."

- French Warning Statement:

"Le présent appareil est conforme aux CNR d'Industrie Canada applicables aux appareils radio exempts de licence. L'exploitation est autorisée aux deux conditions suivantes : (1) l'appareil ne doit pas produire de brouillage, et (2) l'utilisateur de l'appareil doit accepter tout brouillage radioélectrique subi, même si le brouillage est susceptible d'en compromettre le fonctionnement."