

INSTALLING CALIBRATION SOFTWARE 68

- How to install.....68
- How to delete68

CONNECTION TYPES..... 69

X-ray Generator and Detector

Connection of Detector - PC

Mode of connecting Network

- Trigger Cable Instruction.....70
- Detector and PC(Wired mode).....72
- Detector and PC(Wireless mode).....75

CALIBRATION SOFTWARE ... 77

- Calibration Software77
 - Settings
 - Calibration
 - User BPM
 - Validation
 - Exposure Index
- Image Functions82
- Log.....84

USAGE..... 85

- Launching the Program85
- Checking IP Address and Ping Test86
- Checking Save Location87
- Apply88
- Checking and Changing Detector Settings. 89
- Checking and Changing Calibration Software Settings.....90
- Calibration.....92
- User BPM94
- Validation.....96
- EI (Exposure Index).....98
- Exit.....100
- About.....101
- General PopUp102

SERVICE MANUAL 104

- Detector Wired IP Address Setting..... 104
- Wireless AP configuration..... 106
- Detector Firmware Update 108
- Storage of installation date..... 110
- Power Options Setting 111
- Web monitoring..... 112
 - Internal Information
 - Web monitoring

MAINTENANCE..... 114

- Cleaning..... 114
- Inspection..... 114

TROUBLESHOOTING..... 115

SOLUTION FOR FIREWALL BLOCK..... 116

SUPPLEMENT. WIRELESS AP SET UP INSTRUCTION (MODEL : Cisco Linksys EA9200)..... 118

SAFETY INFORMATION

Preparation

- Be sure to connect the cables to the proper connectors. Otherwise, the detector may malfunction or may be damaged.
- The power supply provided by LG is designed for the detector from LG. Please contact supply, if any other type of power supply is needed to be used.
- Be sure to fully charge the battery before use. Charge the battery on the day of examination or on the previous day.
- Battery slowly discharges even when not in use. The battery may have expired if it discharges immediately after being fully charged. You can purchase an optional battery to replace an exhausted one.
- The battery charger provided by LG is designed for the dedicated battery.
- When the detector will not be used for some time, remove the battery.

Handling

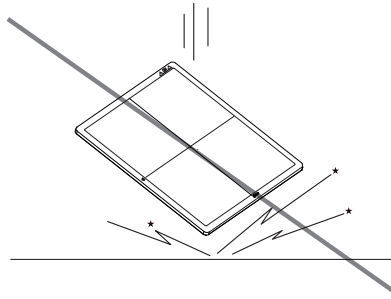

- Handle the detector carefully, as it may become damaged if it is hit, dropped, or receives a strong jolt.

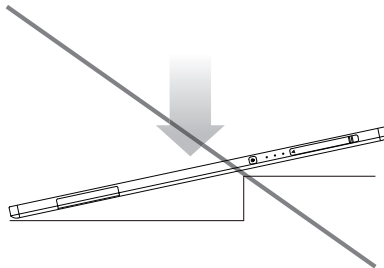

- Be sure to use the detector on a flat place so it will not bend. Otherwise, the detector may be damaged.
- Be sure to check the detector daily and confirm that it works properly. Sudden heating of the room in cold areas will cause condensation to form on the detector. In this case, wait until condensation disappears before performing exposure. If the detector is used with condensation formed on it, problems may occur in the quality of the detector. When an air-conditioner is going to be used, be sure to raise/lower the temperature gradually so that a difference in temperature in the room and in the detector does not occur, to prevent forming of condensation. Follow the

recommended proper Room temp.

- Do not use the detector near devices generating a strong magnetic field. Doing so may produce image noise or artifacts.
- Keep the connectors free from being in contact with the patient.
- Connectors are intended to be connected to an external device and must follow IEC standards.
- Do not apply excessive weight to the detector. Otherwise, the detector may be damaged.

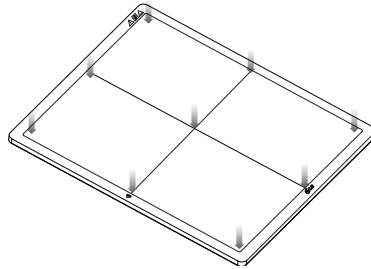

Overall Pressure: 150kg (330.6lb) over the whole area of detector window.

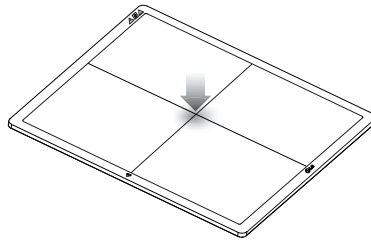

Partial Pressure: 100kg (220.4lb) on an area 40mm (1.5 inch) in diameter

Disinfection and Cleaning

- Do not spray disinfectants or detergents on the detector.
- When cleaning the detector, be sure to turn off the power; and unplug the power cable from the AC outlet.
- Do not use any flammable chemicals such as thinner, benzene for cleaning. Otherwise, fire or electric shock may result.
- Wear waterproof gloves to protect your hands from direct contact with disinfectants or detergents. General Description.

Overview

14HJ701D is wireless Flat Panel Digital X-ray Detector that can generate images of any part of the body, and designed for a faster approach to digital radiography systems.

This model utilize a combination a amorphous silicon TFT glass and high performance scintillator, along with a pixel pitch 127um and 3.9lp/mm of resolution, assure sharp and high contrast image quality.

14HJ701D is X-ray imaging acquisition device that is based on flat-panel. This device should be integrated with an operating PC and a X-ray generator. It can do to utilize as digitalizing X-ray images and transfer for radiography diagnostic. Data transmission between detector and PC is possible by wire (cable) and wireless (WIFI).

Product Component

- Detector: 14HJ701D
- Control Box : LG Control Box
 - AC power cord for Control Box
- Battery Charger : LG Battery Charger
 - 2 Battery packs
 - AC Power adapter for Charger : 65 W
 - AC Power cord for AC Power adapter
- Main Cable
 - Detector and Control Box link cable (Supply DC power, Ethernet data, control signals of X-ray generator)
 - Trigger Cable (X-ray generator to Control Box, transmit control signal between detector and X-ray generator)
 - LAN cable (Control Box to PC, exchanges Ethernet data between PC and detector)
- CD: User's manual, Calibration Software
- User's manual(book type), Inspection Report

Basic Accessories

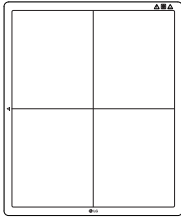

Detector 1 EA

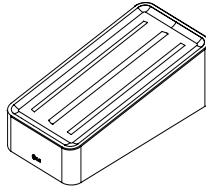

Charger 1 EA

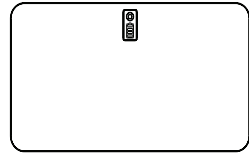

Battery 2 EA



Installation CD 1 EA

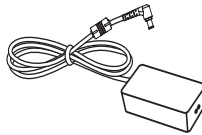

AC Power adapter 1 EA



AC Power cord for Control Box 1EA

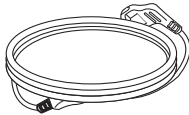

AC Power cord for AC Power adapter

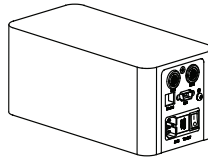

Control Box 1EA



Manual 1 EA

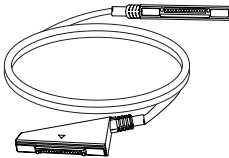

Main cable 1EA



Inspection Report 1EA

Optional Accessories

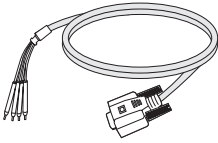

Trigger Cable 1EA

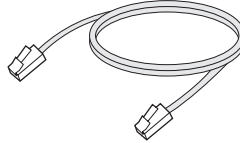

LAN cable 1EA

- Optional accessories can not be included in accordance with production suffix.



CAUTION

- Need to use the authorized components about the below accessories. Unauthorized components may be cause of the damage and malfunction of the product.

Component	Standard
LAN CABLE	More than CAT5E Standard
Power Cord	US – Approved Medical grade regulation Others – Approved country safety regulation

The AC/DC adaptors and etc. except the upper components need to be used only supplied by manufacturer.

PART NAME AND FUNCTION

Detector

FRONT

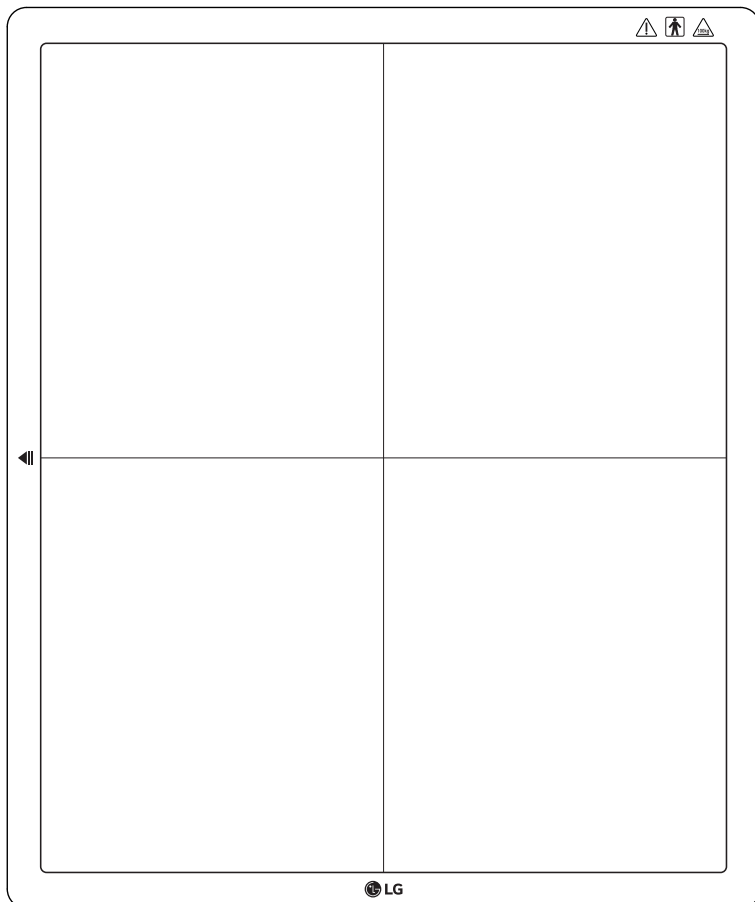

SIDE

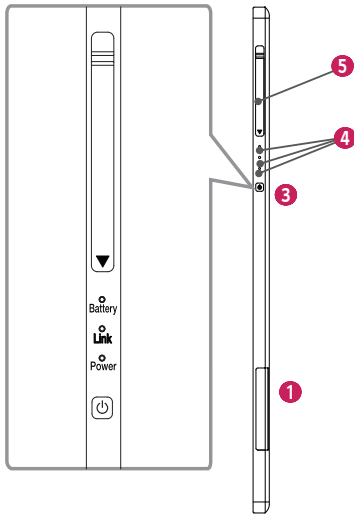

BACK

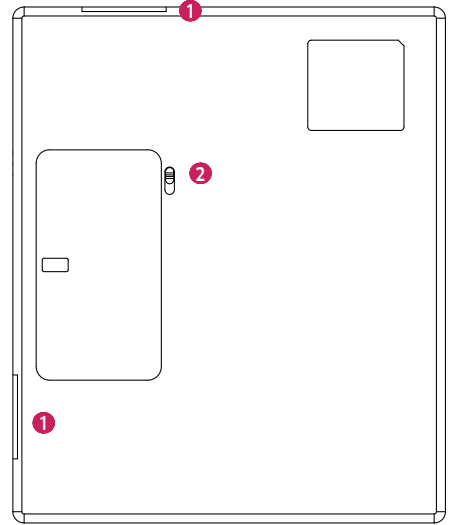

①	Wireless Antenna
②	Battery Unlock Lever: Unlock lever to remove battery
③	Power Button: Power on/off switch (On : press over 1 sec, Off : press over 5 sec)
④	LED Indicator: Indicating detector's status
⑤	Connection to main cable

LED	LED Color	Status
Battery	Green	Battery is more than 30% charged.
	Orange	Battery charging status is 10 ~ 30%.
	Orange Blinking	Battery is less than 10 % charged.
Link	Green	Ethernet/WIFI connection
	Off	Ethernet/WIFI no connection
Power	Green	Power On
	Green Blinking	Sleep mode
	Off	Power Off

If there is no communication during "Auto Sleep/Auto Power off" time, Detector will go to Sleep mode/Power off. This function only works when Detector is not connected with "Detector and Control Box link cable". If the Detector receives the communication message during Sleep mode, The Detector will wake up.

User can set the Sleep/Power off times using the Calibration Software.

Battery and Charger

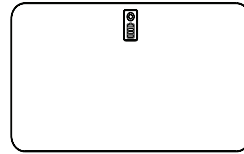
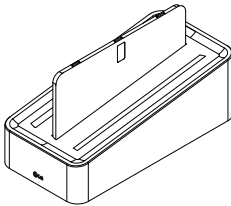

- 1 Battery: Li-ion polymer battery (Charging time - Typ. 4 Hrs)
- Battery pack itself shows the remaining battery percentage.

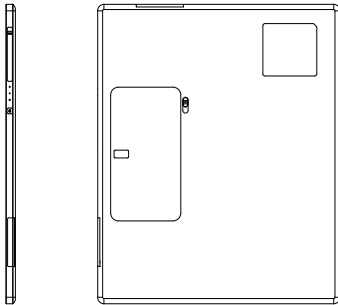

Battery Remain Indicator	Battery Level
	75 ~ 100%
	50 ~ 75%
	25 ~ 50%
	0 ~ 25%

- 2 Battery charger: 3 ports cradle type
- 3 LED Indicator: Following LEDs are located to each battery - 3 batteries.

LED	Green	Completion of charging
	Orange	On charging
	Orange Blinking	Error (Connection error, etc)

Control Box

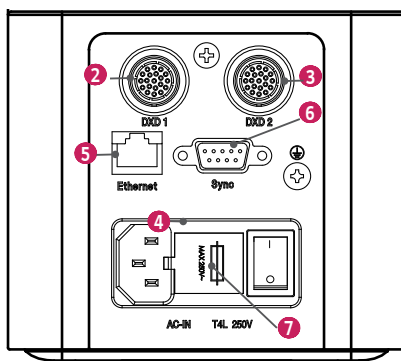
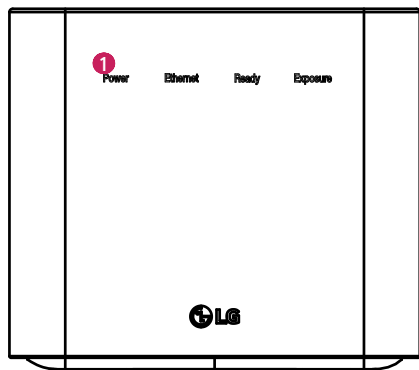

1	LED	POWER	Green	Power normal operation
			Off	Power off (AC power cord no connection or Power error.)
	Ethernet	Green	Ethernet normal operation	
		Off	Ethernet disconnected.	
	Ready	Green	Ready signal from X-ray generator is active.	
		Off	Ready signal from X-ray generator is inactive.	
		Orange blink	Error	
	Exposure	Orange	Exposure signal from X-ray generator is active.	
Off		Exposure signal from X-ray generator is inactive.		
Orange blink		Error		
2	DXD 1	Connecting the Control Box and the detector A. This connector supply power (24 V --- 2.1 A) to the detector; transmits X-ray synchronization signals and Ethernet image data.		
3	DXD 2	24 V --- 2.1 A, Trigger signals, Ethernet data for Detector B Control Box supports 2 Detector connection. Usage is, one is for bucky stand, the other is for table (bed). Generally, X-ray room of hospital installs 2 detectors, bucky stand and table type, it's for more convenient and efficient working environment. These 2 detectors are not operated simultaneously, control box selects the operating detector by AWS command.		
4	AC-IN	Connects AC power cord		
5	Ethernet	Ethernet port to transmit image/command between the detector and PC.		
6	Sync	This is to synchronize the detector and X-ray generator.		
7	Fuse	T4L 250V		

BATTERY INSTALLATION

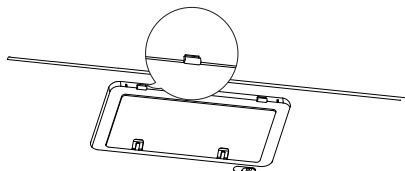

1 Check the battery mounting hole direction.

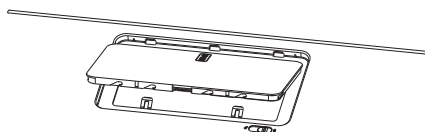

2 Insert into the hole on the side with the indicator.

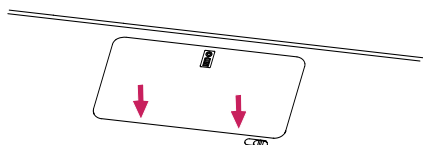

3 Press the opposite side to secure the battery indicator.

SPECIFICATION OF EACH PART

The product specifications are subject to change without prior notice for product improvements.

" - " refers to alternating current (AC), " --- " refers to direct current (DC).

Detector

Item	Specification	Units
Model	14HJ701D	
Sensor type	Amorphous Silicon with TFT	
Scintillator Type	CsI:TI	
Total Pixel Matrix	3328 x 2816	Pixels
Total Pixel Area	422.655 (16.63) x 357.632 (14.08)	mm (inch)
Pixel Pitch	127	um
Effective Pixel Matrix	3323 x 2751	pixels
A/D Conversion	16	bits
Data Transfer	802.11 a/g/n/ac Wireless LAN, typ. 200Mbps with 802.11 ac Gigabit Ethernet typ. 500Mbps	
Preview time	2	sec
Energy range	40 ~ 150	kVp
MTF	Typ. 85%, min. 70% at 0.5 lp/mm	%
DQE	Typ. 63%, min. 50% at 0.1 lp/mm	%
Defective lines	Less than 20	Lines
Defective pixels	Less than 9630	Pixels
Dimension	384.0 x 459.5 x 15.0 (15.1 x 18.0 x 0.5)	mm (inch)
Weight	Typ. 2.95 (6.5)	kg (lb)
Window material	Carbon Fiber	
Trigger mode	Manual Mode Auto Mode (Auto Exposure Detection)	
Power consumption	Typ. 26 (Charging & Operating) Typ. 16 (Operating only – no charging) Typ. 7 (Standby only – no charging)	W
Wireless	Standard: 802.11 a/g/n/ac compliance Peak mode: 866 Mbps Frequency: 2.4 GHz / 5 GHz Bandwidth: 20 MHz / 40 MHz / 80 MHz MIMO: 2X2	
Rating	24 V --- 2.1 A, 7.5 V 3850 mAh (Battery: LBQ7222L)	
Applied part	Type : BF Type, Location : Front of Detector (only for effective area)	

! NOTE

- Maximum wireless signal rate derived from IEEE standard specifications. Actual data throughput will vary. Network conditions and environmental factors, including volume of network traffic, building materials and construction, and network overhead, lower actual data throughput rate.
- Recommended Maximum operable distance: 2 m (From the Access Point)
- Wireless antennas: The module adopts the latest 802.11ac technology. The transmitter of the module is powered by host equipment (Detector). The antennas are 2 printed-dipole antennas.
- Wireless module: 802.11 a/b/g/n/ac USB2.0 module is implemented. It supports 2T2R (2 transmit 2 receive) MIMO technology, which delivers throughput up to 300 Mbps.

Battery

Item	Specification	Units
Model	LBQ7222L	
Rating	7.5 V, 3850 mAh, 30 Wh	
Size	204.1 x 10.5 x 7.8 (8.0 x 0.4 x 0.3)	mm (inch)
Weight	Typ. 240 (0.5)	g (ib)
Output Norminal voltage	7.5	VDC
Cycle time	Max. 800	Cycles
Operation Temp	10 - 35	°C
Charging time	Typ. 4	Hours
Capacity	Typ. 4000	mAh
Battery performance	1400 shots acquired for 3.2 hours (cycle time 8s , without sleep , with Full charged battery)	Images

Battery Charger

Item	Specification	Units
Model	LG Battery Charger	
Size	125 x 255.0 x 90.0 (4.9 x 10.0 x 3.5)	mm (inch)
Weight	Typ. 900 (1.9)	g (ib)
Input	19 V --- 3.42 A	
Output Norminal voltage	8.7	VDC

Battery Charger Adapter

Item	Spec	Units
Model	DA-65J19	
Manufacturer	Asian Power Devices Inc. (APD)	
Size	134.0 x 59.8 x 31 (5.2 x 2.3 x 1.2)	mm (inch)
Weight	Typ. 335	g (ib)
Input	100-240 V ~, 50-60 Hz, 1.5-0.7 A	
Output	19 V --- 3.42 A	
Class	I	
Cable length	1500 (59)	mm (inch)

Control Box

mm (inch)	Desc.	Specification	Units
Model	LG Control Box	LG Control Box	
Size		125.0 x 255.0 x 109.8 (4.9 x 10.0 x 4.3)	mm (inch)
Weight		Typ. 1.3 (2.86)	kg (lb)
Input	AC Power	100-240 V ~, 50/60 Hz, 1.4-0.7 A	
	AC Inlet Fuse 1	T4L 250V	
	AC Inlet Fuse 2	T4L 250V	
	Power Fuse 1 (F101)	T 3.15AH 250V	
	Power Fuse 2 (F102)	T 3.15AH 250V	
Output	DXD 1	24 V --- 2.1 A, Trigger signals, Ethernet data for Detector A	
	DXD 2	24 V --- 2.1 A, Trigger signals, Ethernet data for Detector B Control Box supports 2 Detector connection. Usage is, one is for bucky stand, the other is for table (bed). Generally, X-ray room of hospital installs 2 detectors, bucky stand and table type, it's for more convenient and efficient working environment. These 2 detectors are not operated simultaneously, control box selects the operating detector by AWS command.	
	Ethernet	Transmission image/command between the detector and PC	
	Sync	Transmission control signals between the detector and X-ray generator	

Cables

Item	Length	Unit	Qty
Main cable	1 (39.3)	m (inch)	1
LAN cable (optional)	10 (393.7)	m (inch)	1
Power cord (110 V or 220 V)	1.5 (59.0)	m (inch)	2
Trigger cable (Optional)	15 (590.5)	m (inch)	1

DIMENSION (UNIT: mm/inch)

Detector

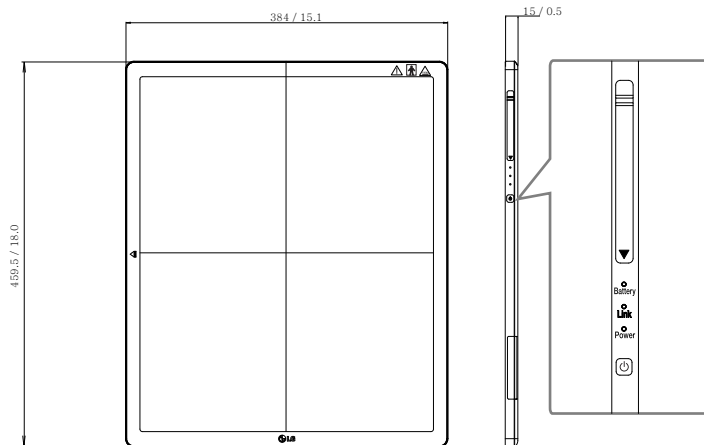

Control Box

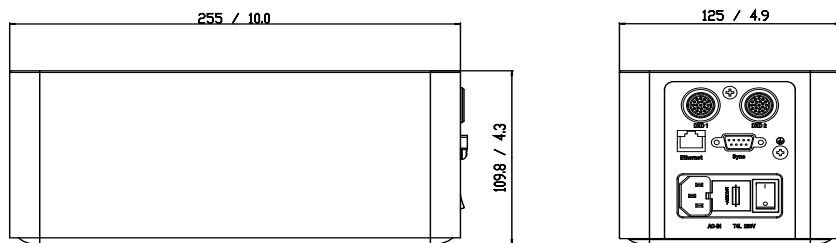

Battery

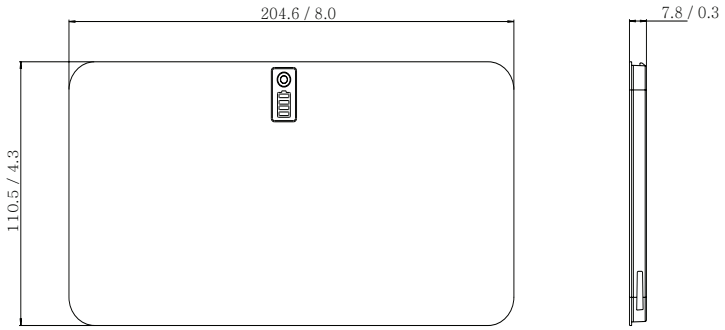

Battery Charger

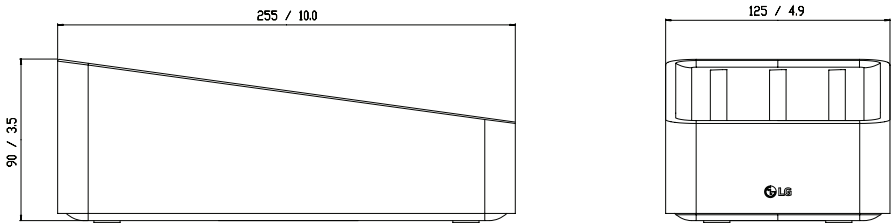

Battery Charger Adapter

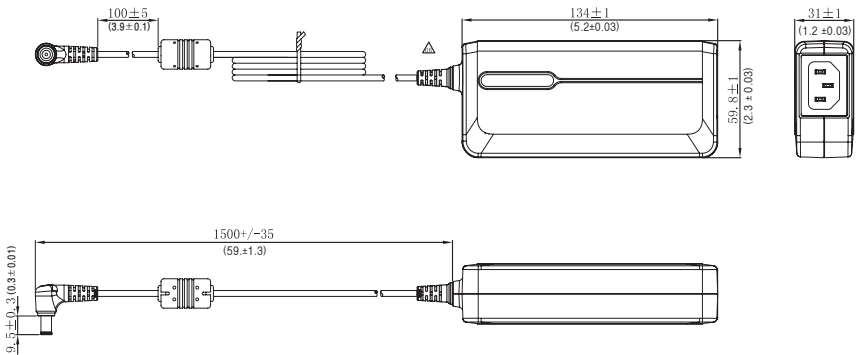

ENVIRONMENTAL REQUIREMENT

PC system requirement

PC Specification	
CPU	intel i5
Memory	4 GB
Disk capacity	At least 10 GB, 500 GB recommended
Network card	dual ethernet 100/1000 bps
OS	Windows 7/8.1/10(32bit, 64bit)
Monitor	Min. Resolution 1280x720
AP	Cisco model is recommended(ex : Linksys EA9200)
etc	

Environmental Requirements

Item	Min.	Typ	Max. (%)	Units
Temperature (Storage)	-20		60	°C
Temperature (Operation)	10		35	°C
Humidity (Storage)			85	Non-condensing, Relative
Humidity (Operation)			80	Humidity
Pressure (Storage)	50		106	kPa
Pressure (Operation)	70		106	kPa

INSTALLING CALIBRATION SOFTWARE

How to install

Run the calibration software installation file. Once the installation file has been executed, follow the installation instructions on the screen.

How to delete

You can delete the Calibration Software in the following ways:

Deleting from the Control Panel

- 1 Select Control Panel from the Start menu.
- 2 Select Programs and Features in Control Panel.
- 3 Select the LG DXD Calibration on the lists.
- 4 When the program installation and deletion screen appears on the screen, select the **Delete** button.
- 5 Follow the deletion instructions on the screen and click the **Next** button to proceed.

Deleting with the installation file

- 1 Run the calibration software installation file, then follow the deletion instructions on the screen.

NOTE

- When using the installation file to delete the program, the installation file must be the same version as the current software.

CONNECTION TYPES

X-ray Generator and Detector

Select Trigger Mode in accordance with the acquisition method.

- Auto Mode : Detector detects the image obtained after the X-ray
- Manual Mode : Detector acquires image by pressing generator exposure switch

Connection of Detector - PC

The connection mode used between the detector and PC.

- Wired Mode: Uses the Control Box to connect the detector to a PC.
- Wireless Mode: Uses a wireless AP to connect the detector to a PC.

Mode of connecting Network

Wired or wireless modes are set automatically depending on whether or not the main cable is connected when the detector is turned on.

- 1 If the main cable is connected when the power is turned on: Wired mode
- 2 If the main cable is not connected when the power is turned on: Wireless mode
- 3 If the cable is disconnected while in wired mode: Switches to wireless mode
- 4 If the cable is connected while in wireless mode: Maintains wireless mode (charging)

Mode	Generator - Detector	Detector - PC
Case 1	Auto Mode	Wired Mode
Case 2	Auto Mode	Wireless Mode
Case 3	Manual Mode	Wired Mode
Case 4	Manual Mode	Wireless Mode

Trigger Cable Instruction

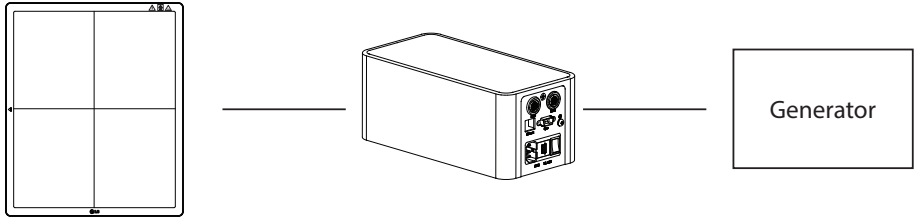

- Connects a Trigger cable to Port A of the Control Box when there is X-ray generator interface.

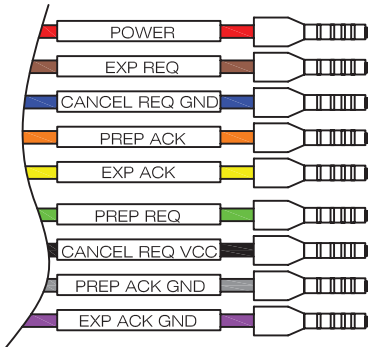
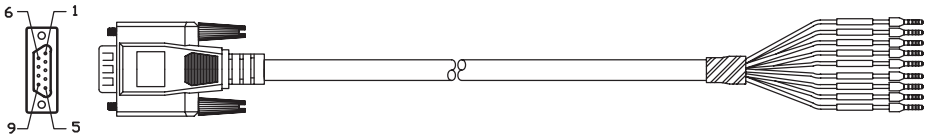

Label pin map

No.	COLOR	Description	
1	RED	POWER	Use
2	BRN	EXP REQ	Use
3	BLU	CANCEL REQ GND	NC
4	ORG	PREP ACK	NC
5	YEL	EXP ACK	Use
6	GRN	PREP REQ	Use
7	BOK	CANCEL REQ VCC	NC
8	GRY	PREP ACK GND	NC
9	VIO	EXP ACK GND	Use

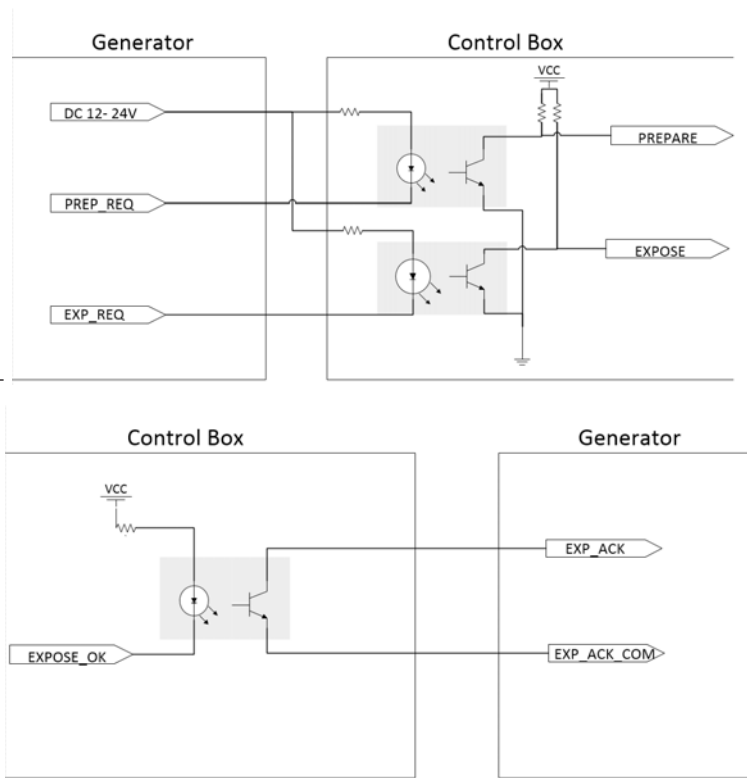

<Assembly Diagram>

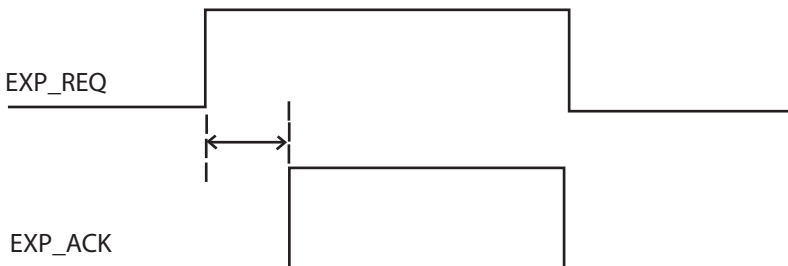

<Timing Chart>

Detector and PC(Wired mode)

Auto Mode

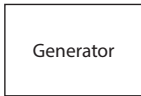
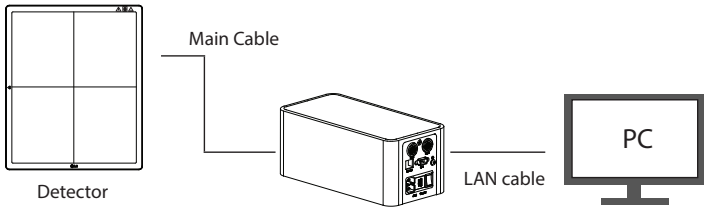

Manual Mode

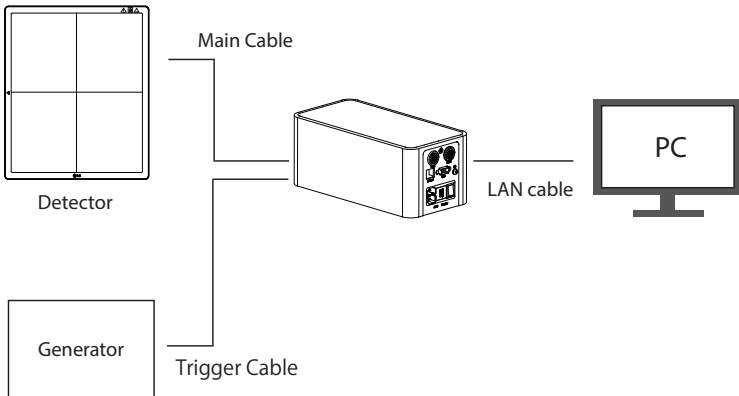

MAKING CONNECTIONS - Wired Connection

1 Connect the PC to the control box using a LAN cable. Connect the detector to the control box using a link cable.

2 Configure the PC settings as below:

① Open the **Network and Sharing Center**.

- (**Control Panel > Network and Internet > Network and Sharing Center**)

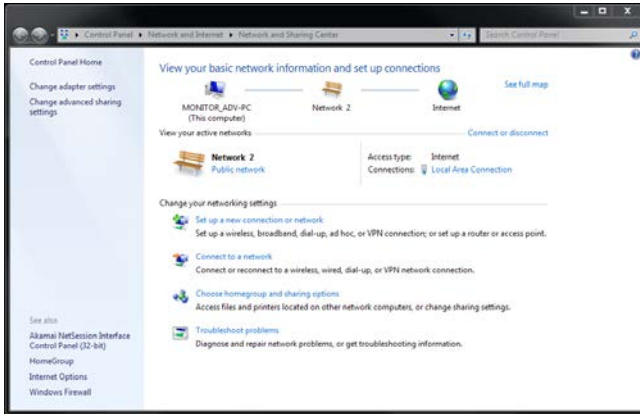

② Right-click on Local Area Connection and enter Properties.

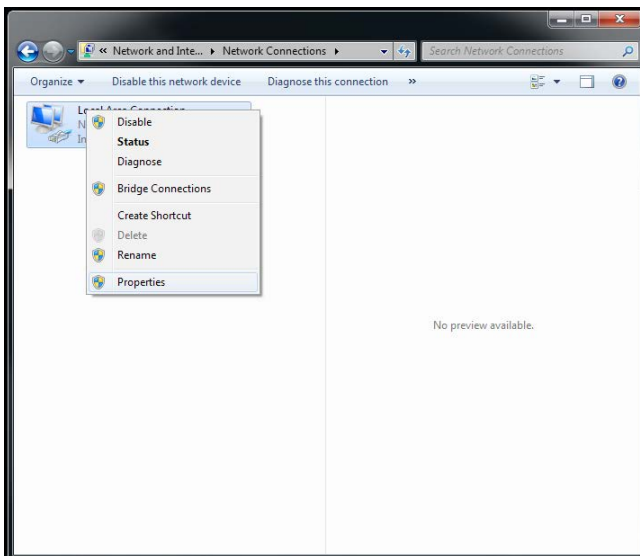

3 Select **Internet Protocol Version 4 (TCP/IPv4)**, then enter **Properties** to set the following IP address.

- IP address: 10.10.10.2 to 10.10.10.254 (Set it to an IP address other than 10.10.10.100.)
- Subnet mask: 255.255.255.0
- Gateway: 10.10.10.1

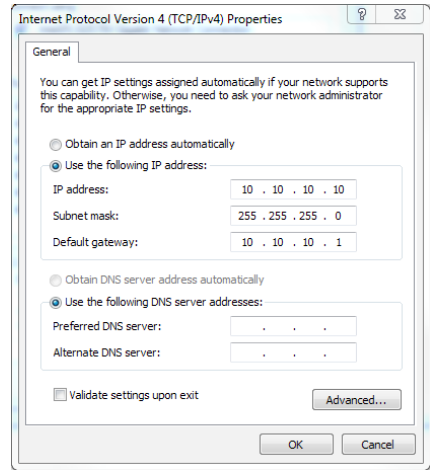
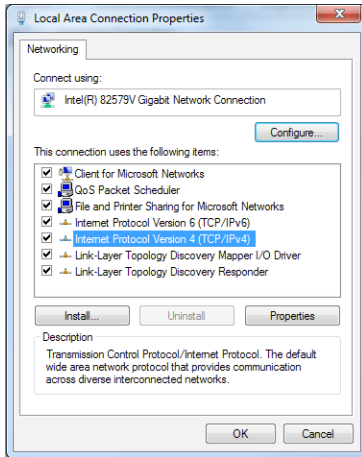

4 Run the LG DXD Calibration. Go to **Settings > DXD > Connection&File Save**, enter Detector IP (10.10.10.100), then run the Ping to check the connection.

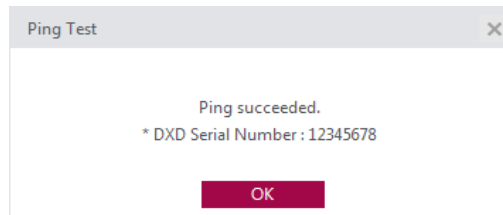
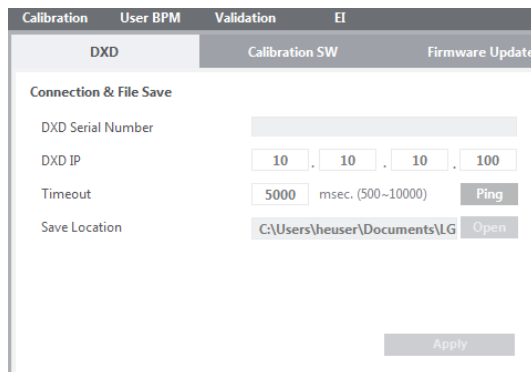

Detector and PC(Wireless mode)

Auto Mode

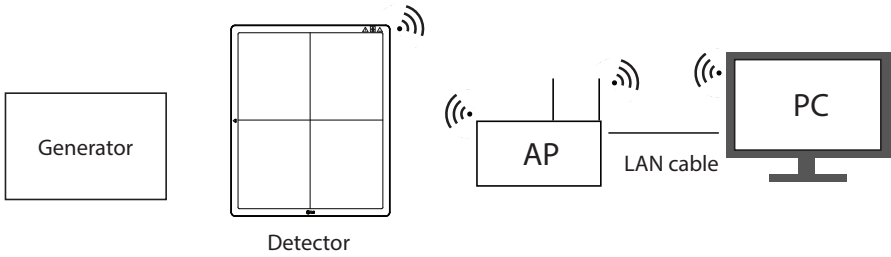

Manual Mode

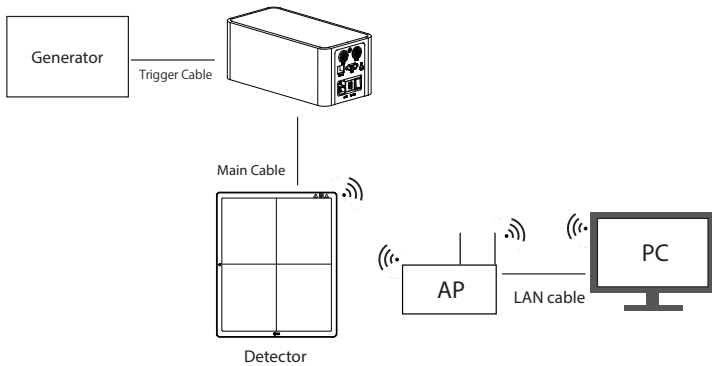

! NOTE

Please install the AP and Detector as near as possible without obstacles in between them.

MAKING CONNECTIONS-Wireless Connection

- 1 The Default Wireless Settings as below.
 - SSID : LGEDXD
 - Password : lgedxd2000
 - 2 It is possible to change the Wireless Settings using LG DXD Calibration Software.
 - Please see the Service manual (Wireless AP configuration) for details.
 - 3 Please reboot the Detector after removing the main cable on Detector.
(If the main cable is disconnected when the power is turned on: Wireless mode)
 - 4 PC settings and connection with Detector are same with wired Connection.
Please refer to the "MAKING CONNECTIONS - Wired Connection".
- Tip : Refer to Wireless AP Set Up Guide
 - "Supplement. Wireless AP Set Up Instruction
(Model : Cisco Linksys EA9200)"

CALIBRATION SOFTWARE

To ensure that optimal image quality is obtained from the detector, the detector must be calibrated. The Calibration Software generates and verifies the values necessary for calibration.

! NOTE

- To ensure optimal image quality, you should calibrate every month for the first three months after the purchase and half-yearly calibration thereafter.
- It is recommended that you leave the detector on for five minutes before calibrating.

Calibration Software

The features of the Calibration Software include **Settings**, **Calibration**, **User BPM**, **Validation** and **Exposure Index**.

Settings

Settings include DXD settings, Calibration SW settings and Firmware Update.

- **DXD**: Configures the settings required to obtain calibration images and detector settings.

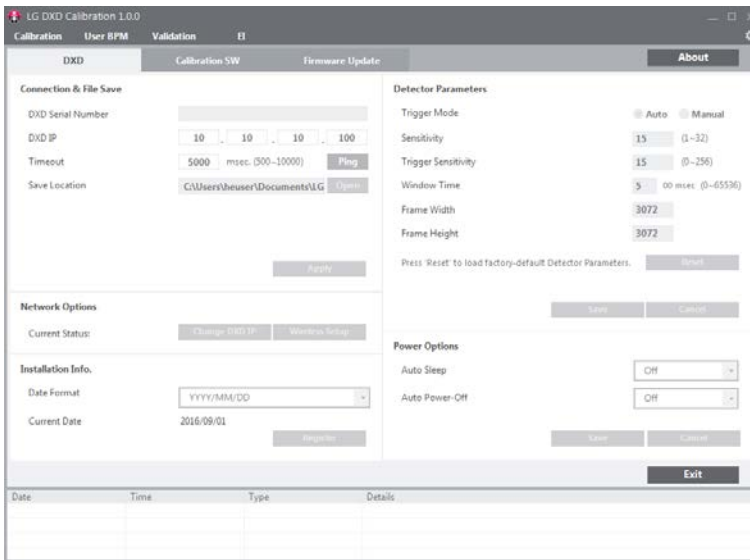

<Settings Screen: Detector>

- **Calibration SW:** Configures the settings required for to calibrate software algorithms.

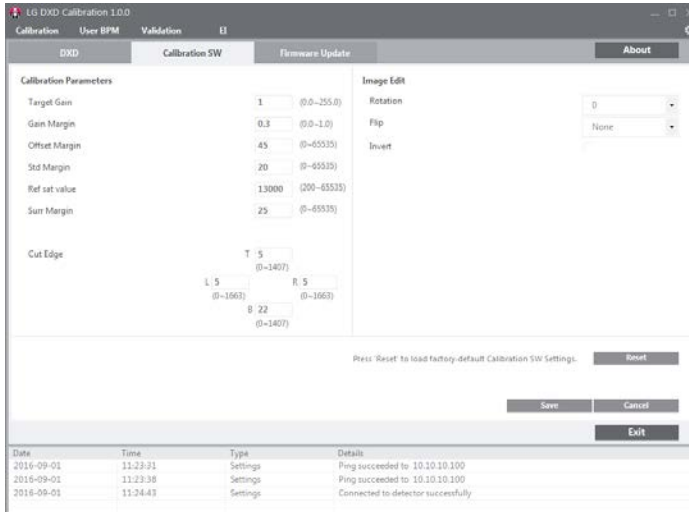

<Settings Screen: Calibration SW>

- **Firmware Update:** Checks the firmware version of the detector or performs the firmware update.

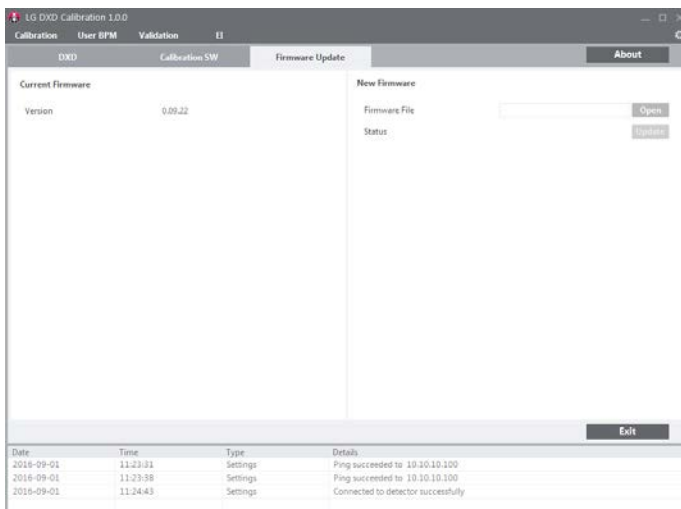

<Settings Screen: Firmware Update>

Calibration

Calibration involves the following procedures:

- Dark and Bright images are obtained from the detector.
 - Dark Image: An image obtained without generating X-rays.
 - Bright Image: An image obtained by generating X-rays without a phantom or any other object on the detector.
- Generate Avgdark, Offset, and Gain: Used for Corrected Image calculations.
 - Corrected Image: An image generated by applying calibration results to a raw image.
- Generate Bad Pixel Map: Bad pixel values are calibrated using surrounding pixel values.

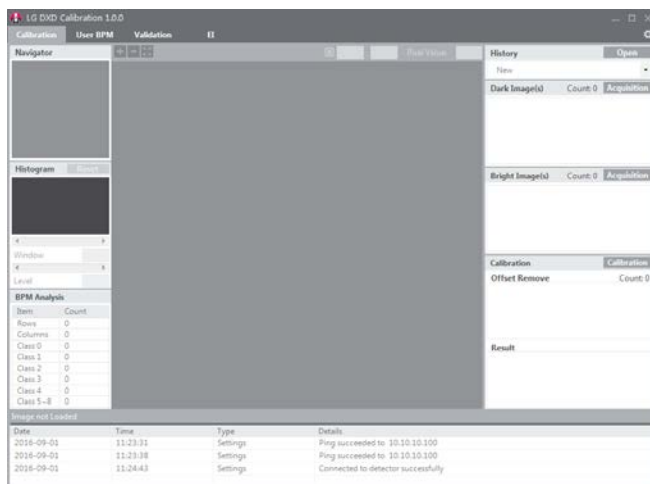

< Calibration Screen >

User BPM

This is used to assign additional bad pixels in BPM.raw after calibrating.

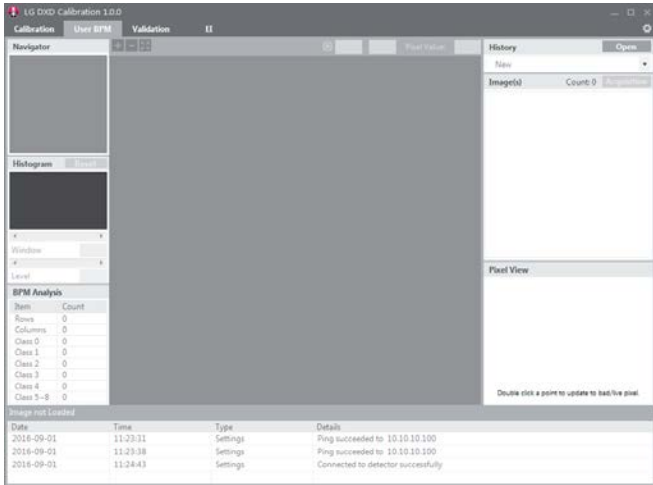

<User BPM Screen>

Validation

This is used to validate the final image by applying calibration results to the X-ray image.

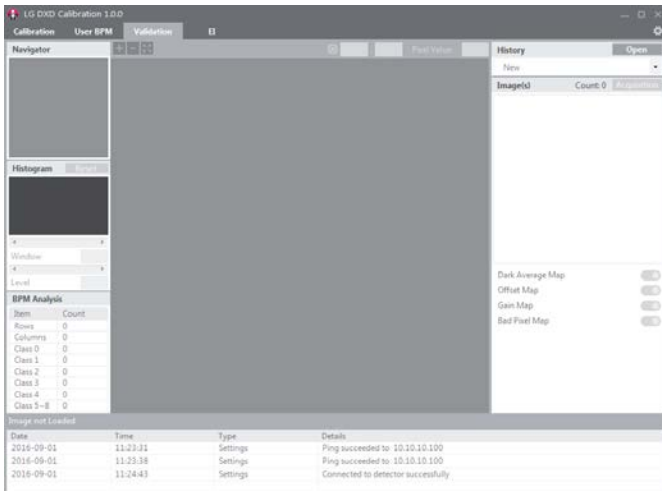

<Validation Screen>

Exposure Index

This calculates and saves median output value per input dose as a linear expression and a table.

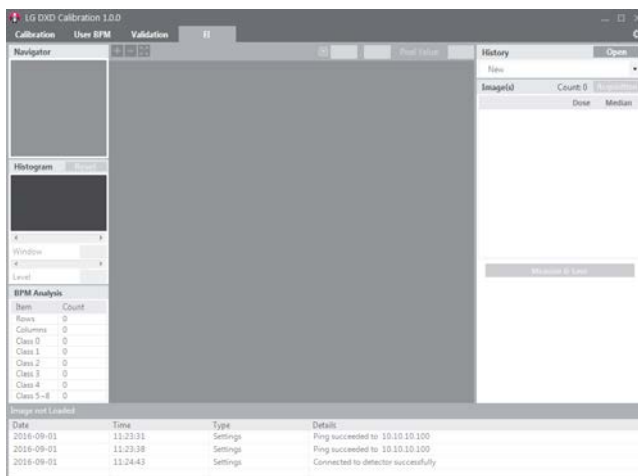

<Exposure Index Screen>

Image Functions

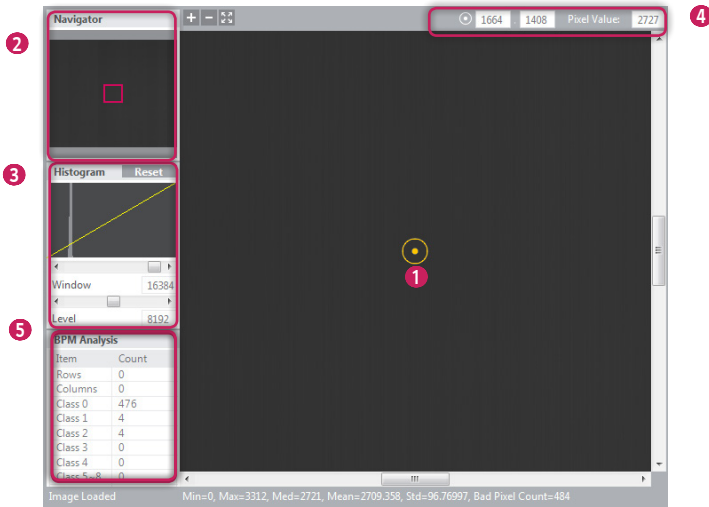

1 Image Viewer

- The **Calibration**, **User BPM**, **Validation**, and **EI** menus include an image viewer that lets you view the acquired images.
- An image is loaded and displayed when it is acquired or clicked.
- Information about the image is displayed in the following sections.
 - **Image Loaded:** Indicates whether an image is loaded in the image area.
 - * When an image is loaded: Image Loaded.
 - * When no image is loaded: Image not Loaded.
 - **Min:** Minimum pixel value within the image area.
 - **Max:** Maximum pixel value within the image area.
 - **Med:** Median value of the image.
 - **Mean:** Mean value of the image.
 - **Std:** Standard deviation value of the image.
 - **Bad Pixel Count:** Bad pixel count in the image area.
 - **14B = N, 8B = M:** Representation of the pixel value at (x,y) in bits.
 - **Bad Pixel Count:** Bad pixel count in the image area.
 - **100%:** Percentage of the image shown in the image area compared to the entire image size.
 - **(X x Y):** Size of the entire image.

Image Loaded Min=0, Max=3312, Med=2721, Mean=2709.358, Std=96.76997, Bad Pixel Count=484 (1443, 1412) 14B=2674 8B=41 100% 3328x2816

2 Navigator

- The Navigator shows the entire area of the acquired image and indicates the zoomed in/out area.
- The red rectangle in the Navigator indicates the area shown in the Image Viewer.
- Clicking a position in the Navigator moves the red rectangle to the position and displays the area in the Image Viewer.

3 Histogram

- Histogram of the acquired image is shown here.
- Window/Level can be adjusted for better image distinction.
- Use the < > buttons or the scroll bars below the Histogram graph to adjust window/level.
- Click the Reset button to restore the default values.

4 Reference Point

- When you click a position inside the Image Viewer, a reference point is specified, and the coordinates and pixel value of the reference point are shown at the top. You can also move the reference point by entering the X and Y values manually.
 - Since reference point coordinates are numbers, only numeric values can be entered.

5 Bad Pixel Map Analysis

- Displays the results of bad line and bad pixel class analysis based on the Bad Pixel Map after calibration.

Log

This shows the necessary information about the application execution process that is helpful to the user. It consists of the date, time, type and content, which are saved as a log file.

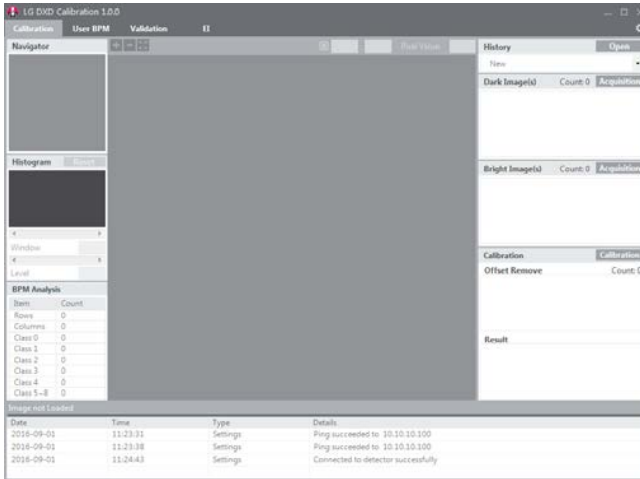

USAGE

Launching the Program

- Double-click the executable file installed on your PC to launch the calibration software.
- If launching for the first time, the Settings screen appears.

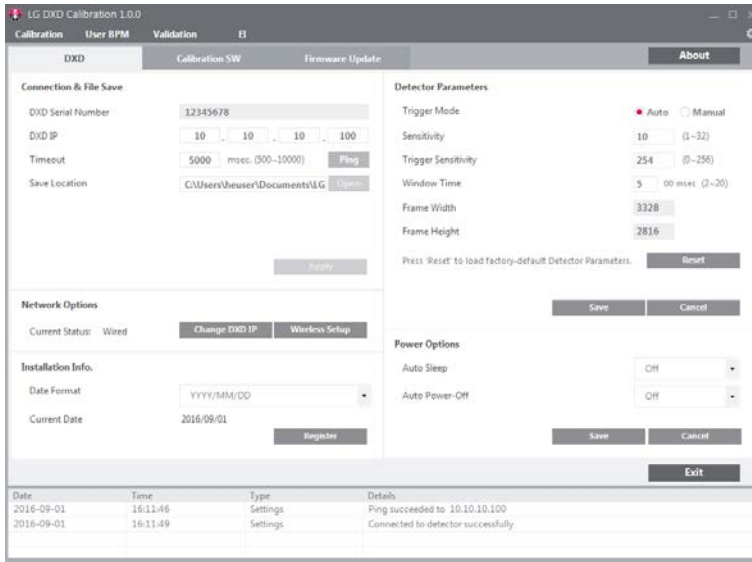

Checking IP Address and Ping Test

- A default IP address is entered for the detector.
- If you change the IP address of the detector, enter the new detector IP address in the detector IP field of the calibration tool.
- For instructions on changing the detector IP address, see "Detector and PC(Wired mode)".
- After entering the IP address, set a timeout value and click the **Ping** button to perform a ping test. A pop-up message appears if the ping test is successful.

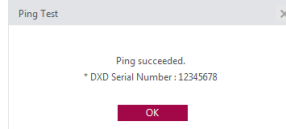

- The following pop-up window appears if the ping test is unsuccessful. If the pop-up window appears, check your PC's network settings, the connection between the detector and PC, the detector status, the Control Box status and the IP address, then perform the ping test again.

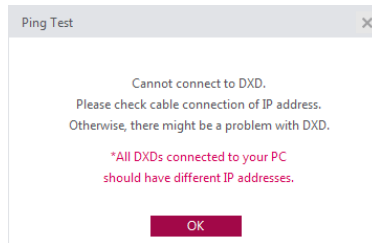

Checking Save Location

While the calibration software is run, the acquired images, logs, result files and factory-default calibration results are saved in the designated location.

You can change the storage path in the **Save location**.

Click the **Apply** button when a folder is created in the specified path.

! NOTE

- Default: C:\Users\heuser\Documents\LG DXD Calibration
- heuser: User name

Calibration	User BPM	Validation	EI
DXD		Calibration SW	
		Firmware Update	
Connection & File Save			
DXD Serial Number	<input type="text"/>		
DXD IP	<input type="text" value="10"/>	<input type="text" value="10"/>	<input type="text" value="100"/>
Timeout	<input type="text" value="5000"/>	msec. (500~10000) <input type="button" value="Ping"/>	
Save Location	<input type="text" value="C:\Users\heuser\Documents\LG"/> <input type="button" value="Open"/>		
<input type="button" value="Apply"/>			

Apply

After performing the ping test and verifying the save location, click the **Apply** button to perform the following procedures

- 1 Automatically create the necessary folders in the save location designated in the Checking **Save Location** stage.
- 2 Load from the detector and save the factory-default calibration results.
- 3 Load the detector's settings.

Dark Images	Automatic creation of the Serial Number folder (Created when Apply is complete) Condition: Created if the same Serial Number folder is not found in the custom folder	Creation of date/time folder (created when the Calibration button is clicked)	Avgdark.raw
			Gain.raw
			Offset.raw
			BPM.raw
			EI results (A folder is created for the date/time applied at the time of EI.)
			History file
	Log	Shows logfile including connections + bpm class	
	Image	Bright Images	
		Dark Images	
		User BPM images	
		Validation images	
		EI images	
	Factory calibration (Created when Apply is complete if the folder or files do not exist or if the files are abnormally small)	Raw images	
Avgdark.raw			
Gain.raw			
Offset.raw			
			BPM.raw

- 4 When **Apply** is successful, the detector's network status is displayed.

Current Status : Wired Connection.

Wireless Connection.

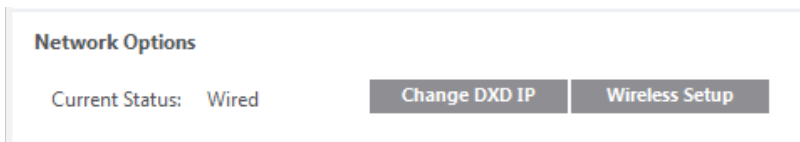

! NOTE

- Other menus remain inaccessible until you perform **Apply**. (**Calibration, User BPM, Validation, EI**)

Checking and Changing Detector Settings

Upon **Apply**, the current detector settings are loaded on the settings screen below.

The screenshot shows the 'LG DXD Calibration 1.0.0' software interface. The 'About' tab is selected, displaying various configuration sections:

- Connection & File Save:** DXD Serial Number (12345678), DXD IP (10.10.10.100), Timeout (5000 msec), Save Location (C:\Users\heuser\Documents\LG).
- Detector Parameters:** Trigger Mode (Auto), Sensitivity (10), Trigger Sensitivity (254), Window Time (5:00 msec), Frame Width (3328), Frame Height (2816). Includes a 'Reset' button to load factory defaults.
- Network Options:** Current Status (Wired), buttons for 'Change DXD IP' and 'Wireless Setup'.
- Installation Info:** Date Format (YYYY/MM/DD), Current Date (2016/09/01), and a 'Register' button.
- Power Options:** Auto Sleep (Off), Auto Power-Off (Off), with 'Save' and 'Cancel' buttons.
- Log Table:**

Date	Time	Type	Details
2016-09-01	16:11:46	Settings	Ping succeeded to 10.10.10.100
2016-09-01	16:11:49	Settings	Connected to detector successfully.

- Detector Parameters are parameters used when obtaining images from the detector.
- Click the **Save** button to apply the settings entered.
- Descriptions of the data are as follows:
 - **Trigger Mode** : This sets Trigger Mode.
 - * **Auto** : Enables the Auto Exposure Detection feature.
 - * **Manual** : Disables the Auto Exposure Detection feature.
 - **Sensitivity** : This is the panel sensitivity.
 - **Trigger Sensitivity** : This is the threshold at which the detector starts acquiring images.
 - **Gain** : This is the gain value to be saved in the Detector.
 - **Frame Width/Height** : This is the detector size.
 - **Window Time** : This sets the time taken to read the values after the x-ray exposure. (An input value of 5 means 500 ms.)
- Descriptions of the buttons are as follows.
 - **Save** : Applies the changes.
 - **Reset** : Loads the factory default settings.
 - **Cancel** : Loads the last saved values.

Checking and Changing Calibration Software Settings

The calibration parameters are updated when the **Calibration** Software tab is clicked.

Calibration Parameters

These settings are used to perform calibration.

- Descriptions of the data are as follows:
 - **Target Gain** : Amplification level within algorithms.
 Pixels with values that exceed the **Gain Margin** are specified as bad pixels.
 - **Offset Margin** : **Offset margin** value used within algorithms.
 - **Std Margin** : Pixels with values that exceed the **Std Margin** are specified as bad pixels.
 - **Ref Sat Value** : Maximum range of values during **Image acquisition**.
 - **Surr Margin** : In corrected bright images, if the difference between the standard pixel value and surrounding pixel value exceeds the **Surr Margin**, the standard pixel is specified as a bad pixel.
 - **Cut Edge** : This indicates the pixel values to cut off in the top, bottom, left or right directions of the frame. After acquiring an image in **Validation** or **EI**, the border of the image to cut off is indicated as dotted lines in the Image Viewer.

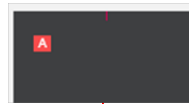

The screenshot shows the 'Calibration' tab selected in the software. The 'Ref Sat Value' is set to 5.75. The main image viewer shows a dark image with a yellow circle around a central pixel. The histogram shows a distribution of pixel values. The BFM Analysis table is as follows:

Item	Count
Rows	0
Columns	0
Class 0	478
Class 1	4
Class 2	4
Class 3	0
Class 4	0
Class 5-8	0

The History table at the bottom shows the following entries:

Image/Event	Time	User	Type	Details
2018-09-01	11:35:12	User: EPM	Image saved	
2018-09-01	11:35:13	User: EPM	Image opened	
2018-09-01	11:35:13	User: EPM	Acquisition end	

Image Edit

These are Image Viewer settings of the selected tool.

- **Rotation** : This sets the rotation angle of the image. (**0°, 90°, 180°, 270°**)
- **Flip** : Sets how the image shown in the Image Viewer is rotated. (**None, Horizontal, Vertical**)
- **Invert** : Inverts the image data shown in the Image Viewer.
- Click the **Save** button to apply the settings entered.
- Descriptions of the buttons are as follows.
 - **Save** : Applies the changes.
 - **Reset** : Loads the factory default settings.
 - **Cancel** : Loads the last saved values.
 - **Exit** : Return to the previous screen.

! NOTE

- The next stage will not be accessible until you perform **Apply**.

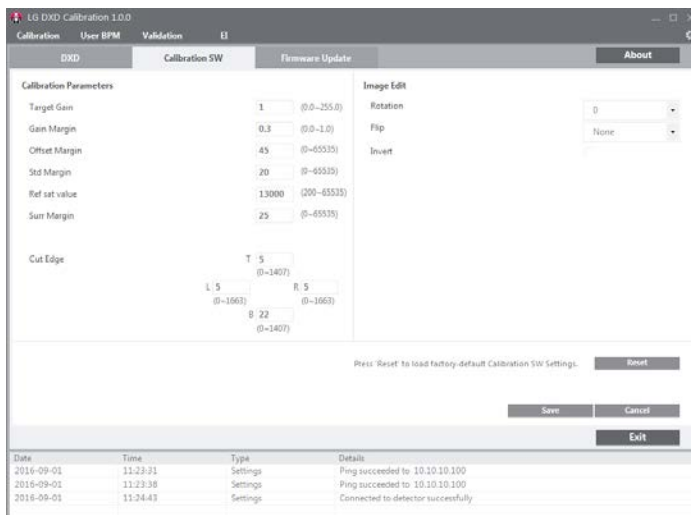

Calibration

After configuring all settings, click the **Calibration** tab to open the Calibration menu.

NOTE

- This tab cannot be accessed until the settings have been configured.

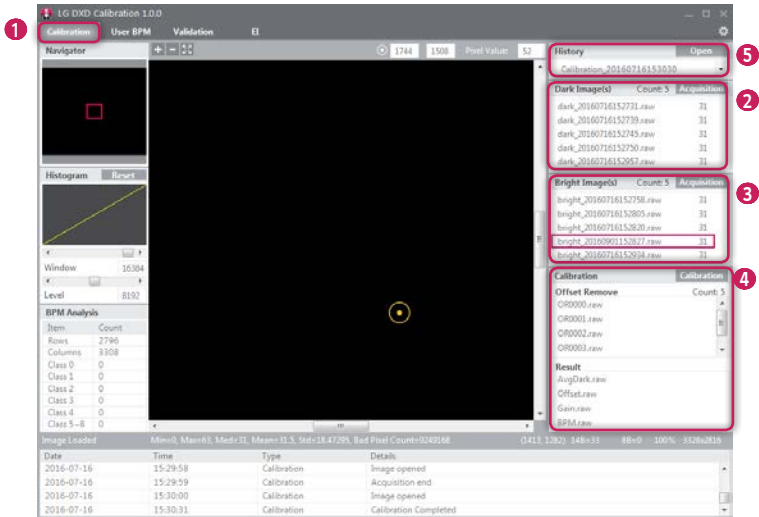

1 Open Calibration Menu

- Click the **Calibration** menu button to open the menu.

2 Get Dark

The menu is used to acquire dark images necessary for performing calibration.

- When a dark image is acquired, the image count increases and the image file is saved in the Image folder within the location specified in Settings.
- After acquiring an image, the mean value of the image is shown next to the file name.
- After comparing multiple images, you can delete any abnormal images by right-clicking them.
- When deleted, both the list entry and the file are deleted.

NOTE

- All the images are deleted when calibration ends. For backup, copy the images and paste them into another folder.
- Up to 10 images can be saved.
- Dark Image: An image obtained without generating X-rays.

3 Get Bright

The menu is used to acquire bright images necessary for performing calibration.

- When a bright image is acquired, the image count increases and the image file is saved in the Image folder within the location specified in **Settings**.
- After acquiring an image, the mean value of the image is shown next to the file name.
- After comparing multiple images, you can delete any abnormal images by right-clicking them.
- When deleted, both the list entry and the file are deleted.

! NOTE

- All the images are deleted when calibration ends. For backup, copy the images and paste them into another folder.
- Up to 10 images can be saved.
- Bright Image: An image obtained by generating X-rays without a phantom or any other object on the detector.

4 Calibration

This area is used for calibration.

- At least four dark images and four bright images are required for calibration.
- Calibration result files are saved in a folder that is created based on the date and time of the calibration.
- The **BPM Analysis** is updated when the calibration is complete.

! NOTE

- When calibration is performed more than five times, the oldest results are automatically replaced with new results.
- For backup, copy the results folder and paste the results into another folder.

5 History

- You can load previous calibration results. Click the **Open** button to load the previous calibration result files.

! NOTE

- Selecting any one of the files also loads other associated files. (Select any one of the Avgdark, Offset, Gain or BPM files, and all the four associated files will be loaded.)
- If there is a problem while loading the files, the following error popup window appears. If the popup window below appears, check the file sizes, path, file names and folder access permissions, and then try again.

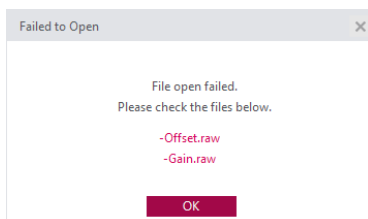

User BPM

The user can manually edit the Bad Pixel Map created during **Calibration** in this menu.

! NOTE

- You can skip the **User BPM** stage and proceed to **Validation**.

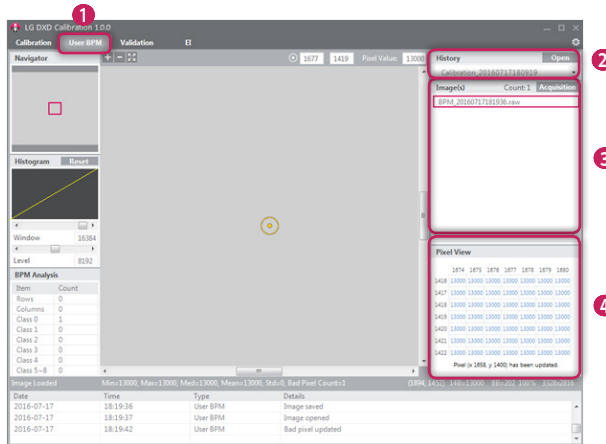

1 Open User BPM Menu

- Click the **User BPM** menu button to open the menu.

! NOTE

- The pop-up window below will appear if you open this menu without performing calibration.

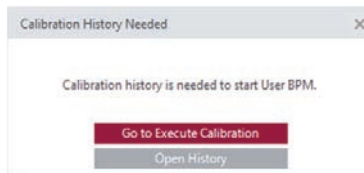

2 Check History File

- Check that the **History** name created during calibration matches the name shown in the current **History** window.
- The **User BPM** procedure is performed by applying the selected **History**.

3 Image Acquisition

- User BPM requires image acquisition as it involves a visual inspection of images with applied calibration results. When the **Acquisition** button is clicked and a bright image is acquired, the name of the image will appear in the image list.

4 Pixel View

- Check pixel values in **Pixel View**
 - Pixel values for the center of the Image Viewer are displayed in the **Pixel View** window.
 - The minimum value, maximum value and pixels estimated as bad pixels are shown as below.
 - * **Minimum value** : Indicated as a green number
 - * **Maximum value** : Indicated as a red number
 - * **Estimated bad pixels** : Indicated with gray background
 - The size of the **Pixel View** window can be adjusted using the **+** icon. The mouse pointer changes to a **+** icon when hovering over the border between the **Pixel View** and Image Viewer.

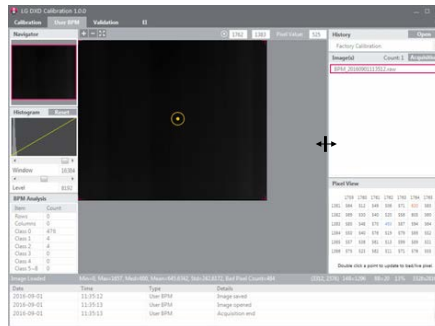

- Mark additional bad pixels in **Pixel View**
 - Double-click a pixel in **Pixel View** to mark it as a bad pixel. Double-click a bad pixel again to unmark it.
 - As you mark bad pixels, the values in Bad Pixel Analysis are updated in real time.
 - Also, pixels marked as bad pixels are replaced with calibrated pixel values.
- Saving Final User BPM
 - The result file is saved when a different menu is opened.
 - When you attempt to exit the current menu and open another menu, a popup window appears asking whether you want to save the data.
 - Select Save to add a calibration history entry and save an updated version of the BPM.raw file.

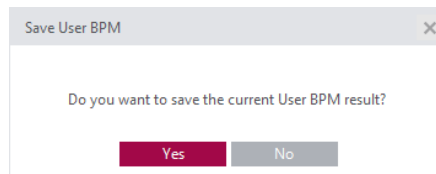

Validation

This procedure allows you to perform a visual inspection of the calibration results after completing calibration.

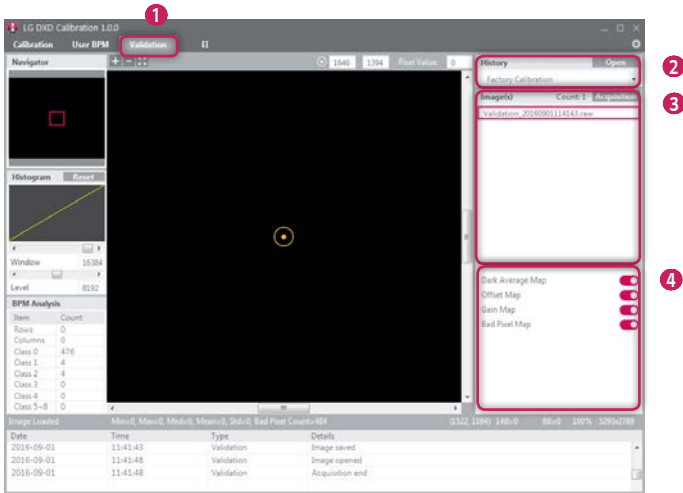

1 Open Validation Menu

- Click the **Validation** menu button to open the menu.

! NOTE

- The pop-up window below will appear if you open this menu without performing calibration.

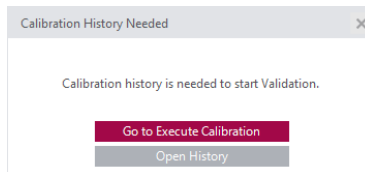

2 Check History File

- Please confirm whether the name of the History file created during calibration matches the name displayed in the **History** window.

3 Image Acquisition (Procedure matches that from the User BPM stage)

- When the **Acquisition** button is clicked and a bright image is acquired, the name of the image will appear in the image list.
- Information about the image is displayed below the Image Viewer.

4 Apply/Unapply Calibration Results

- You can apply/unapply calibration results (**Dark Average Map, Offset Map, Gain Map, Bad Pixel Map**) to the acquired image.

: Apply

: Unapply

! NOTE

- When an image is acquired and loaded for the first time, all results are applied by default.
- If no image has been acquired, the Apply/Unapply button is disabled.

EI (Exposure Index)

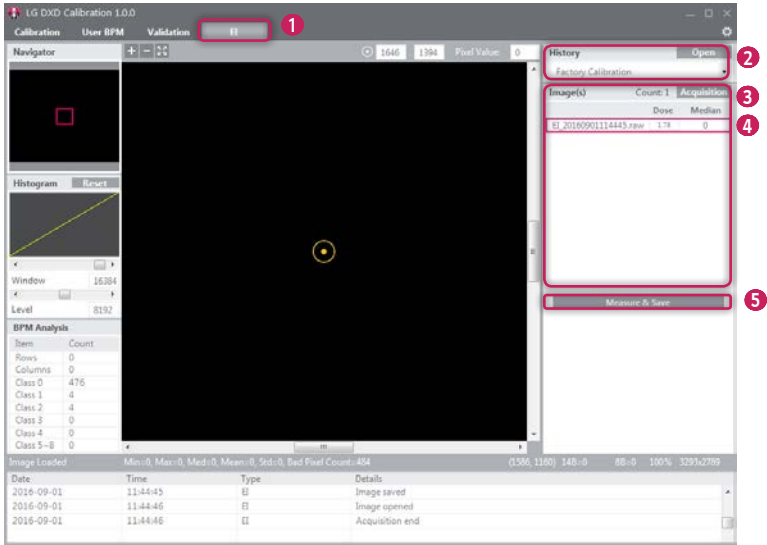

1 Open EI Menu

- Click the EI menu button to open the menu.

! NOTE

- The pop-up window below will appear if you open this menu without performing calibration.

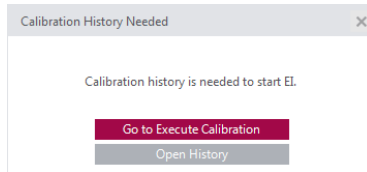

2 Check History File

- Please confirm whether the name of the History file created during calibration matches the name displayed in the History window.

3 Image Acquisition (same as User BPM and Validation)

- When the **Acquisition** button is clicked and a bright image is acquired, the name of the image will appear in the image list.
- Information about the image is displayed below the Image Viewer.

4 Enter Dose Value

- Enter an X-ray dose in the dose input field. (Unit: uGy)
- The EI value is calculated based on the input value.
- Because the dose value is a number, only numeric values can be entered. Non-number values cannot be entered automatically.

5 Measure & Save

- When you click the **Measure & Save** button after acquiring an image and entering a dose value, the popup notification below appears.

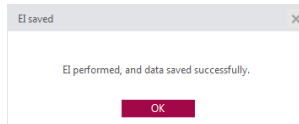

- The results are saved in the save location specified for EI calculation.
(Example: C:\Users\heuser\Documents\LG DXD Calibration\Serial Number\Calibration Results Folder (Time and Date)
heuser: Username)

! NOTE

- When Measure & Save is repeated, the results file in the folder is updated.
- The following pop-up window appears if the minimum number of images required (three) is not met.

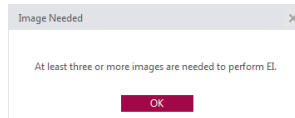

Exit

When you click the Quit button, the calibration tool quit popup window appears.

In the popup window below, click the **Yes** button to quit or click the **No** button to return to the previous screen.

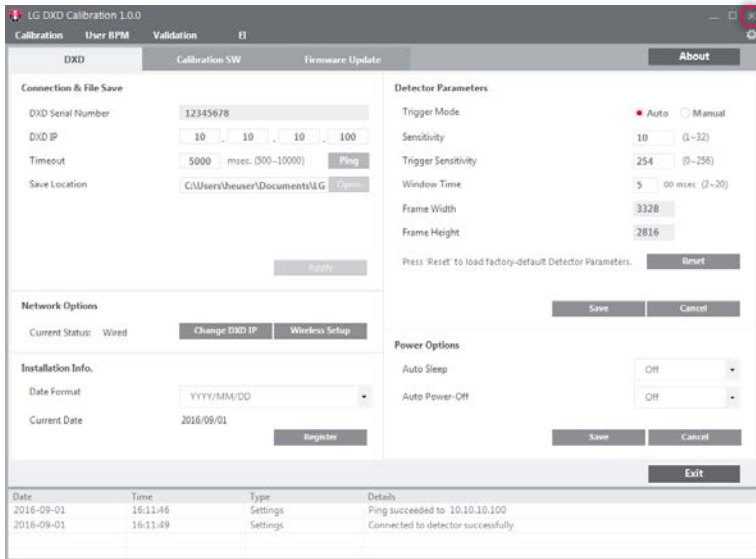

<Settings: Exit>

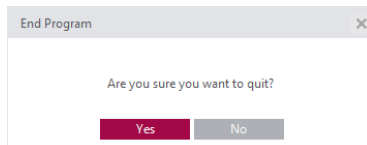

<Exit>

About

When you click the **About** button in Settings, the following popup window appears. It shows the information about the application.

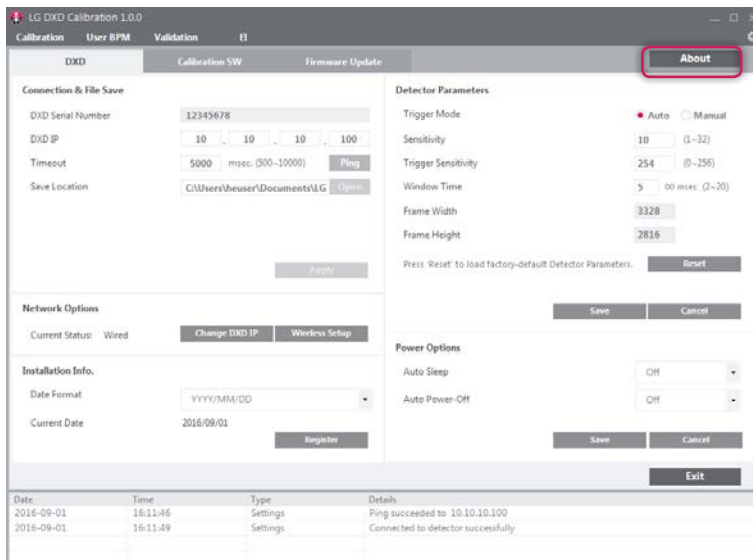

<Settings: About>

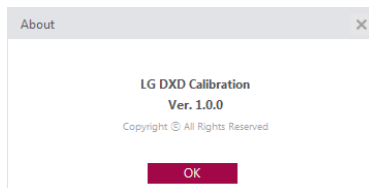

<About>

General PopUp

The following are descriptions of the general pop-up windows that may appear when the calibration software is being used.

Image Acquisition Cancellation

- When the **Acquisition** button is clicked for image **Acquisition**, it will be replaced with a **Cancel** button while the image is being acquired.
- Once image acquisition is complete, the button will revert to an **Acquisition** button.
- During image acquisition, you can cancel the process by clicking the **Cancel** button.

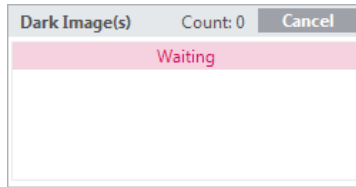

<Get Dark Image Cancel Button: Available in Calibration>

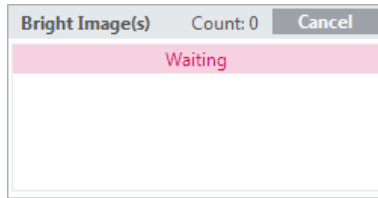

<Get Bright Image Cancel Button: Available in Calibration>

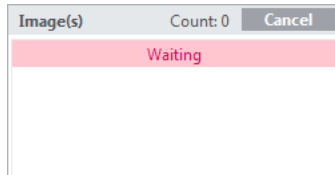

<Get Image Cancel Button: Available in User BPM, Validation, EI>

- The pop-up window below appears when the cancellation is complete.

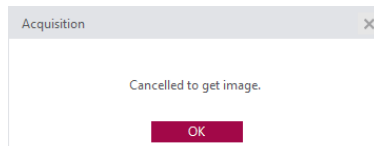

<Get Image Cancel Complete Popup Window>

Image Acquisition Failure

- The popup window below appears when image acquisition fails. Check the network and Detector status, then try again.

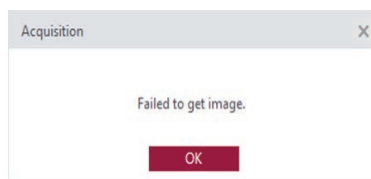

<Image Acquisition Failure Popup Window>

SERVICE MANUAL

Detector Wired IP Address Setting

- 1 From the Usage section, perform "Launching the Program", "Checking IP Address and Ping Test", "Checking Save Location" and "Apply".
- 2 Click the **Change DXD IP** button.

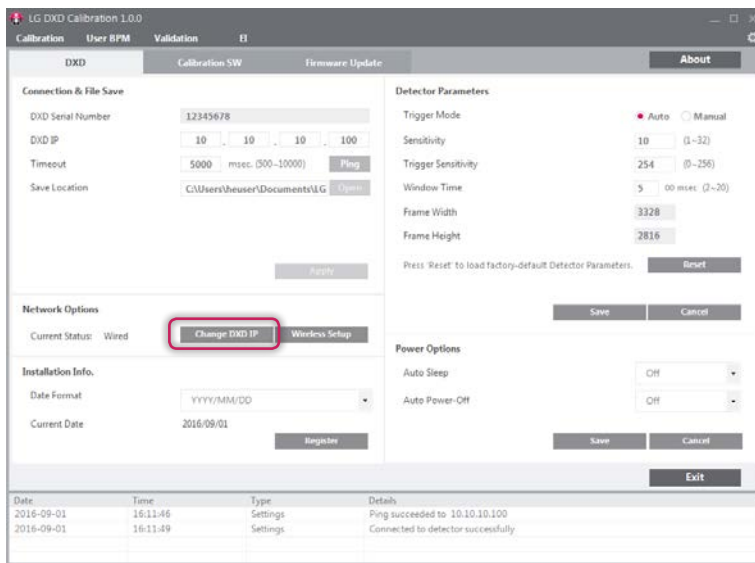

- 3 At the popup window, change the setting and click the **Apply** button.
 - When the **Apply** button is clicked, the system attempts to change the IP address.

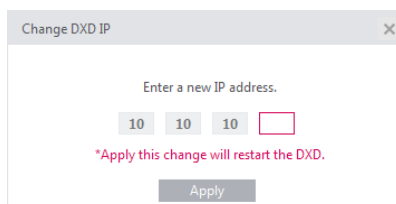

4 Check the result and restart the detector.

- The following popup windows appear, depending on the successful and failed.

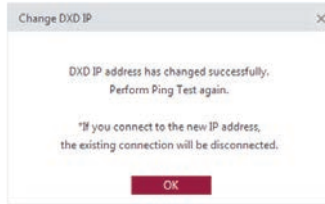

<Popup Window for Successful Configuration>

- Once the new IP address is applied, restart the detector so that the new setting takes effect.
- Restart the detector automatically using the program.
- Because the detector is disconnected when restarting, perform the Connection & File Save process again.

Wireless AP configuration

To have the Detector connect wirelessly to an AP, the AP information must be saved in the Detector in advance. Once the AP information is transferred and saved in the Detector, the Detector attempts to connect to the AP. The saved AP information can be viewed in the Web Monitoring feature.

- 1 From the Usage section, perform "Launching the Program", "Checking IP Address and Ping Test", "Checking Save Location" and "Apply".
- 2 After checking that wireless settings are enabled on the PC, click the **Wireless Setup** button.

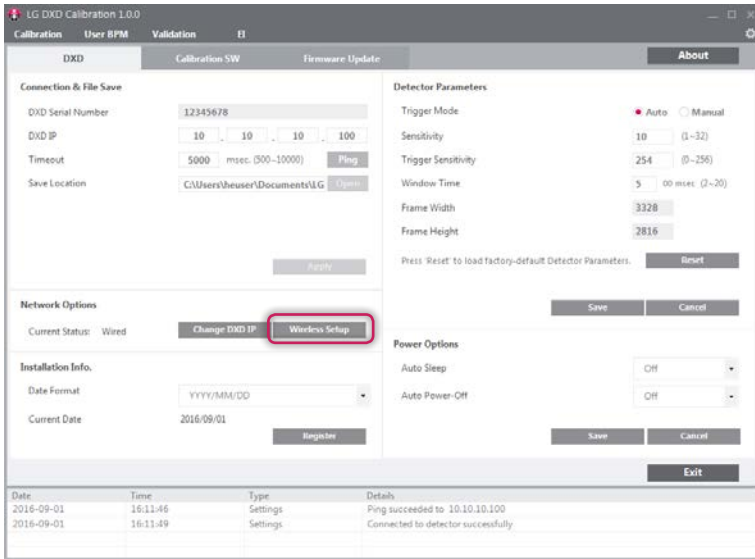

- If a pop-up appears, enter your SSID and password, then click **Apply**.

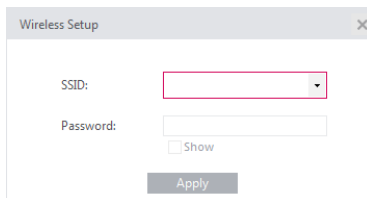

! NOTE

SSID can be appear garbled or as question marks or boxes and others because of encoding or compatibility.

3 Check results.

- The following popup windows appear, depending on the result.

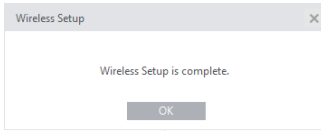

<Popup Window for Successful Configuration>

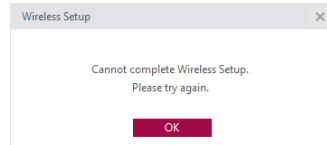

<Popup Window for Failed Configuration>

Detector Firmware Update

This menu allows you to check the firmware version of the detector or update the firmware.

- 1 From the Usage section, perform "Launching the Program", "Checking IP Address and Ping Test", "Checking Save Location" and "Apply".
- 2 Select the **Firmware Update** tab.

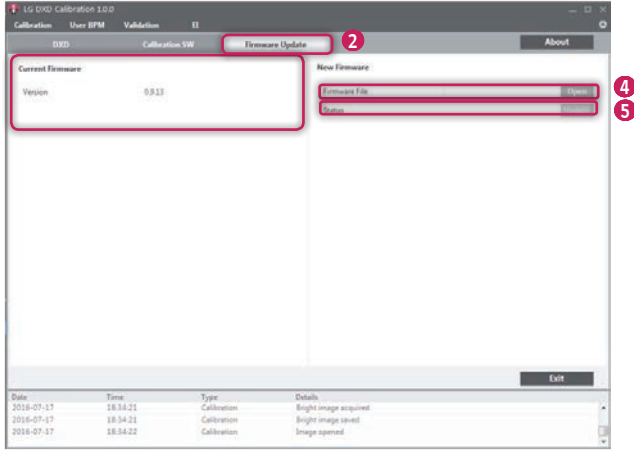

- 3 Check the current firmware version.
 - The current firmware version of the detector is shown here when the PC is connected to the detector.
- 4 Select a firmware file to update.
 - Click the **Open** button to open a file browser window. When you select a file to update, the system validates the file.
 - If the file is correct, the file name appears in the **Firmware File** section.
 - If the file is invalid, the following popup window appears.

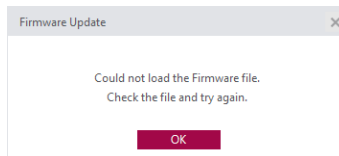

<Popup Window for File Loading Failure>

- 5 Perform the update.
 - Select a file, then click the Update button to start the **Update** process.
 - The progress status is shown in the Status field.

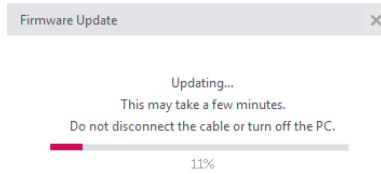

<File Updating Popup Window>

CAUTION

- Do not remove the power cable until the update is complete. The update may not be successful if the power is disconnected during the update process.
- 6 Check results.
 - When the update is complete, the result is shown in a popup window.

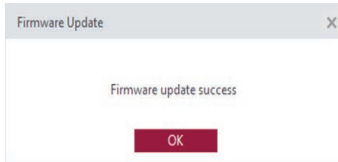

<File Update Successful Popup Window>

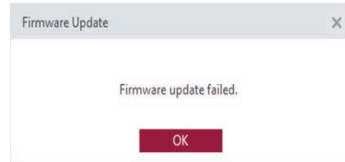

<File Update Failed Popup Window>

Storage of installation date

The date of the first calibration can be saved in the detector.

- 1 From the Usage section, perform "Launching the Program", "Checking IP Address and Ping Test", "Checking Save Location" and "Apply".
- 2 Select the **Settings** > **DXD** tab.
- 3 Check the installation date and select a date format.



- YYYY: Year
- MM: Month
- DD: Day

! NOTE

- The date is displayed based on the OS information.



- 4 Click the **Register** button to open a pop-up window. The installation date can be checked through the Web Monitoring feature.

! CAUTION

- Be careful, as this information is saved only once per detector and cannot be edited later.

- 5 Select the **Yes** button in the pop-up window to save the information in the detector. Once the information is saved, the **Register** button will be disabled.

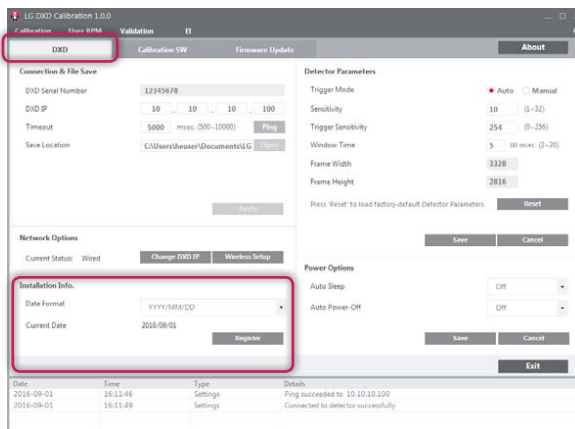

Power Options Setting

This menu allows you to save the Power Options of detector.

- 1 From the Usage section, perform "Launching the Program", "Checking IP Address and Ping Test", "Checking Save Location" and "Apply".
- 2 Select the **Settings > DXD** tab.
- 3 Select the options of **Auto Sleep** and **Auto Power-Off**.
- 4 Click the Save button to save the options on Detector.

! NOTE

- Calibration Software only saves the options.
- Detector enters the the Power Mode when there is no communication during the setting times.
- The Detector does not enter the Power Mode while the Calibration Software runs(from the "Apply" to exit) because the Calibration Software checks the Detector's status Periodically.
- This feature is only enabled wireless models

The screenshot shows the 'LG DXD Calibration 1.0.0' application window. The 'DXD' tab is selected, and the 'Power Options' section is highlighted with a red box. The 'Power Options' section contains two dropdown menus: 'Auto Sleep' and 'Auto Power-Off', both set to 'Off'. Below these are 'Save' and 'Cancel' buttons, and an 'Exit' button at the bottom right of the section.

Date	Time	Type	Details
2016-09-01	16:11:46	Settings	Ping succeeded to 10.10.10.100
2016-09-01	16:11:49	Settings	Connected to detector successfully

Web monitoring

This feature displays the detector's release date, installation date, software version and other internally managed information in a web browser.

Internal Information

Category	Content	Description
Product information	Software version	<ul style="list-style-type: none"> Currently installed detector firmware version
	Product release date	<ul style="list-style-type: none"> Product manufacture date
	Product installation date	<ul style="list-style-type: none"> Installation date as registered by the installer
	Model number	<ul style="list-style-type: none"> Product model number
	Serial No.	<ul style="list-style-type: none"> Product serial information
Network	Connection status	<ul style="list-style-type: none"> Network connection mode (wired/wireless)
	IP	<ul style="list-style-type: none"> Detector's IP address
	SSID of the wireless AP connected to the detector	<ul style="list-style-type: none"> ID of the wireless AP connected
	Detector netmask	
	Detector gateway	
	MAC address of the currently connected network	<ul style="list-style-type: none"> Product MAC information
Battery	Status	<ul style="list-style-type: none"> Battery level, charging status notification, Auto Sleep , Auto Power off
ETC	Bright image count	<ul style="list-style-type: none"> Number of times images were acquired by generating X-Rays
	Dark image count	<ul style="list-style-type: none"> Number of times images were acquired without generating X-Rays

Web monitoring

- 1 Establish a wired/wireless connection between the detector and the PC.
- Refer to the "Detector and PC(Wireless mode)" or "Detector and PC(Wireless mode)" sections for instructions.
- 2 Enter the IP address in the address input of the detector PC web browser.
- 3 The default IP address: 10.10.10.100 enter the page as below appears.

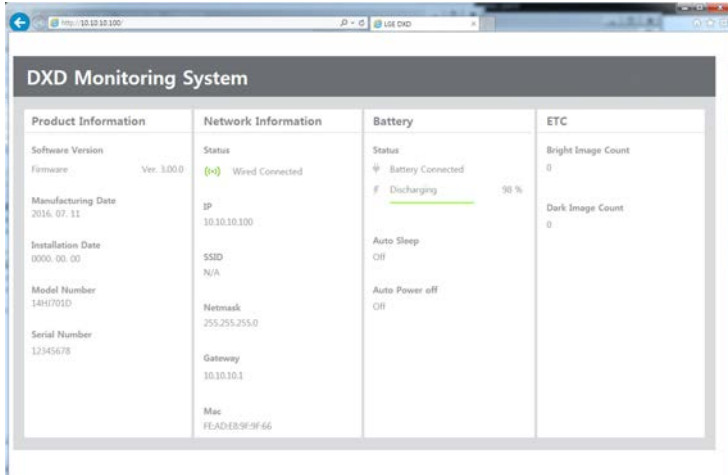

MAINTENANCE

Cleaning

- Make sure to turn the detector off and remove the battery before cleaning.

Inspection

- Check the detector regularly to ensure that it operates stably and properly. If a problem occurs, please contact the manufacture.
- Use the checklist below as a reference for checking the product.

Checklist	Inspector	Cycle
Is the cable damaged?	User	Daily
Is the plug or are the connectors loose or damaged?	User	Daily
Is the detector scratched or cracked on the surface?	User	Daily
Is the LED power working properly?	User	Daily
Is the battery charging properly?	User	Daily
Scheduled calibration	Vendor	3 to 6 months
Performance inspection	Vendor	Yearly

TROUBLESHOOTING

Problems that occur while using the detector can be solved by using the information on this page. If problems persist, please contact the manufacturer.

Problem	Action
The product does not turn on.	<ul style="list-style-type: none"> • Check that the power cord is properly connected. • After disconnecting and reconnecting the power cord, press the power button on the product.
The product was suddenly turned off during use.	<ul style="list-style-type: none"> • Check that the power cable is properly connected. • After turning the product on again, check the detector battery status using the battery LED. If flashing in orange, it means that the battery is low. Please charge before use.
The Control Box Ready/Exposure LED flashes in orange.	<ul style="list-style-type: none"> • Check the power cable connection of the control box. • Check that the control box is properly connected to the generator or the detector.
The PC and the detector are not connected.	<ul style="list-style-type: none"> • Check the power supply. If on, check the following: • Check that the connection is made as instructed in the manual. Try connecting again. • Perform the Ping Test in Settings > Connection & Save Location section of Calibration Software to check your connection. You can also check your connection by entering the IP address in the address bar of the Browser window and checking whether the page is properly loaded. • Check whether the network IP address of your PC is using the same IP address as the detector. • In some cases, especially Win 8 OS, it might be problem in connection because of firewall rule that blocks all incoming ICMP packets. Please refer to next page, "Solution for firewall block".
There is a problem with acquired images.	<ul style="list-style-type: none"> • Check whether the detector surface is soiled. • Images acquired immediately after turning the detector on may be incorrect due to instability of the panel. Open the Calibration menu of the Calibration Software. Acquire some dark images first or wait a while before proceeding. • If the images continue to be unstable, perform Calibration, apply the results, then continue.

SOLUTION FOR FIREWALL BLOCK



If **Calibration Software** connection doesn't work for firewall in Windows 8, refer to instructions as below.

- 1 Enter into control panel and click on the **System and Security** link



Adjust your computer's settings View by: [Category](#) ▾

 <p>System and Security Review your computer's status Back up your data Find and fix problems</p>	 <p>User Accounts and Family Safety Add or remove user accounts Set up parental controls for any user</p>
 <p>Network and Internet View network status and tasks Choose homegroup and sharing options</p>	 <p>Appearance and Personalization Change the theme Change desktop background Adjust screen resolution</p>
 <p>Hardware and Sound View devices and printers Add devices and printers</p>	 <p>Clock, Language, and Region Change display language Change keyboards or other input methods</p>
 <p>Programs Uninstall a program</p>	 <p>Ease of Access Let Windows suggest settings Optimize visual display</p>

- 2 Select the Windows Firewall link.





 **Action Center**
Review your computer's status and resolve issues |  Change User Account Control settings |
Troubleshoot common computer problems | Restore your computer to an earlier time

 **Windows Firewall**
[Check firewall status](#) | [Allow a program through Windows Firewall](#)

 **System**
View amount of RAM and processor speed | [Check the Windows Experience Index](#) |
 [Allow remote access](#) | [See the name of this computer](#) |  [Device Manager](#)

- 3 Click on the **Advanced settings** link situated in the pane on the left hand side.

Control Panel Home

- Allow a program or feature through Windows Firewall
-  [Change notification settings](#)
-  Turn Windows Firewall on or off
-  Restore defaults
-  [Advanced settings](#)
- Troubleshoot my network

- 4 Choose **Inbound rules** in Windows Firewall with Advanced Security. Scroll and find **File and Printer Sharing** rule to enable.

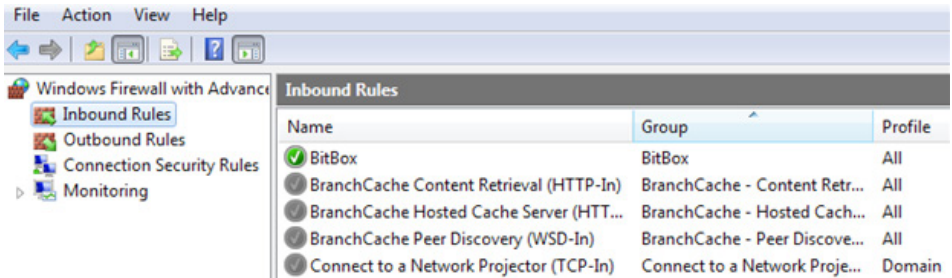

- 5 Click **Enable Rule**.

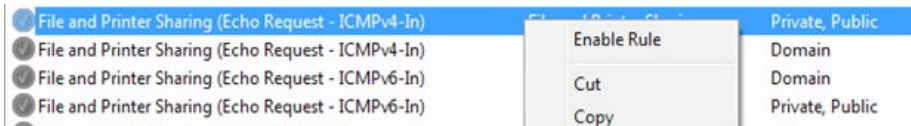

- 6 Check its status and try to connect detector again.



SUPPLEMENT. WIRELESS AP SET UP INSTRUCTION (MODEL : Cisco Linksys EA9200)

- 1 Connect the LAN Cable from the Ethernet port on the PC to the Ethernet port on the AP.
- 2 Launch your web browser and enter linksysmartwifi.com or http://192.168.1.1 in the Address bar then press **Enter**
(IP number address for the 1st access is 192.168.1.1. However, IP number address for accessing will be 10.10.10.1 after changing 10.10.10.1)

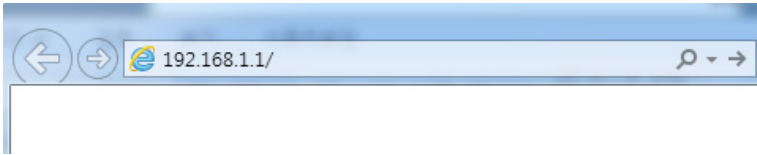

Enter into **Connectivity** > **Local Network**. Click **Edit** to change IP address to 10.10.10.1.

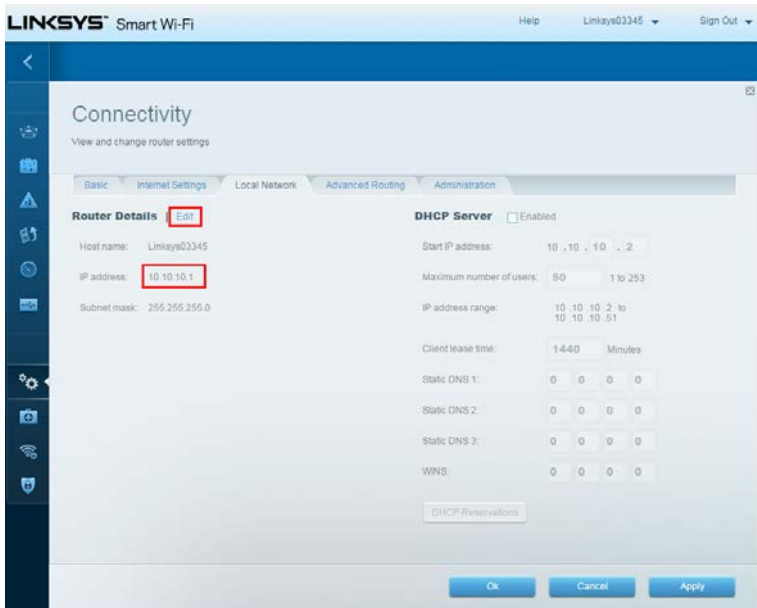

(You should click **Apply** button to apply current setting)

- 3 Enter into **Wireless**. You can change network name and password like below.

LINKSYS Smart Wi-Fi Help Linksys03345 Sign Out

Wireless

View and change router settings

Wireless MAC Filtering Wi-Fi Protected Setup

Smart Connect: 5 GHz band steering Off
5 GHz + 5 GHz Individual networks

Network name: 2.4 GHz Network: on

Password: Broadcast SSID: Channel:

Security mode: Network mode: Channel width:

Network name: 5 GHz + 5 GHz Network: on

Password: Broadcast SSID: Channel:

Security mode: Network mode: Channel width:

(You should click **Apply** button to apply current setting)

For more information, please visit the web site as below.

<http://www.linksys.com/sg/support-product?pid=01t80000003efNkAAI>



To obtain the source code under GPL, LGPL, MPL, and other open source licenses, that is contained in this product, please visit <http://opensource.lge.com>.

In addition to the source code, all referred license terms, warranty disclaimers and copyright notices are available for download.

LG Electronics will also provide open source code to you on CD-ROM for a charge covering the cost of performing such distribution (such as the cost of media, shipping, and handling) upon email request to opensource@lge.com. This offer is valid for three (3) years from the date on which you purchased the product.

Model _____
Serial No. _____



이 문서는 라이선스(저작권)에 따라 보호됩니다. 무단(복제, 배포)은 법적 제재를 받을 수 있습니다.
이 문서는 GPL, LGPL, MPL 등 다양한 라이선스
에 따라 배포될 수 있습니다,
<http://opensource.lge.com>을 참조하십시오.
이 문서는 저작권 보호를 위해 암호화되어 있습니다.
이 문서를 열려면 30일 내에 opensource@lge.com로
e-mail을 보내거나 전화로 문의하십시오. 문의 내용은
저작권 보호, 무단 배포, 무단 사용 등
관련된 사항에 대해 CD-ROM에 제공된 지침을 참조하십시오.



이 문서는 라이선스(저작권)에 따라 보호됩니다. 본 문서(본문, 삽입물)의 무단 배포, 복제, 수정, 변조, 또는 기타 형태의 무단 사용은 엄격히 금지됩니다. 이 문서는 GPL, LGPL, MPL 등 다양한 오픈소스 라이선스에 따라 배포되는 오픈소스 소프트웨어입니다. <http://opensource.lge.com>에서 자세한 정보를 보실 수 있습니다. 이 문서의 저작권은 © 2008 LG Electronics, Inc.에 있습니다. 무단 배포, 복제, 수정, 또는 기타 형태의 무단 사용은 엄격히 금지됩니다. 이 문서는 3월 31일 이전에 opensource@lge.com로 e-mail로 보내거나, 전화, 팩스, 또는 기타 방법으로 LG Electronics에 문의할 수 있습니다. 이 문서는 CD-ROM에 포함되어 있습니다.