

**ATTACHMENT K – USERS MANUAL**

---

# English

ENGLISH

---

## First Edition (August / 2001)

This publication could contain technical inaccuracies or typographical errors. Changes are made periodically to the information herein; these changes will be made in later editions. IBM may make improvements and/or changes in the product(s) and/or program(s) at any time.

It is possible that this publication may contain reference to, or information about, IBM products (machines and programs), programming, or services that are not announced in your country.

Requests for copies of this publication and for technical information about IBM products should be made to your IBM Authorized Dealer or IBM Retailer.

No part of this publication may be reproduced or distributed in any form or by any means without prior permission in writing from the International Business Machines Corporation.

© Copyright International Business Machines Corporation 2000. All rights reserved.

Note to U.S. Government users- - Documentation related to restricted rights- - use, duplication or disclosure is subject to restrictions set forth in GSA ADP Schedule Contract with IBM Corp.

---

## Notices

References in this publication to IBM products, programs, or services do not imply that IBM intends to make these available in all countries in which IBM operates. Any reference to an IBM product, program or service is not intended to state or imply that only IBM's product, program, or service may be used. Any functionally equivalent product, program, or service that does not infringe any of IBM's intellectual property rights or other legally protectable rights may be used instead of the IBM product, program, or service. Evaluation and verification of operation in conjunction with other products, programs, or services, except those expressly designated by IBM, are the user's responsibility.

IBM may have patents or pending patent applications covering subject matter in this document. The furnishing of this document does not give you any license to these patents.

---

## Trademarks

The following terms, used in this publication, are trademarks or service marks of the IBM Corporation in the United States, other countries, or both:

### HelpCenter IBM

ENERGY STAR is a U.S. registered mark.

Microsoft®, Window®, and Windows NT® are trademarks of Microsoft corporation in the United States, other countries, or both. Other company, product, and service name may be trademarks or service marks of others.

# Contents

<b>Setup</b> .....	<b>2</b>
Hardware Requirements .....	2
Handling Instructions .....	2
Workplace preparation.....	2
Working Practices .....	3
Connecting your Monitor.....	4
Switching on your Monitor.....	4
Adjusting the Monitor Position .....	5
Caring for your Monitor .....	5
<b>Configuring your Monitor</b> .....	<b>6</b>
Setup Diskette for Microsoft Windows95 or Microsoft Windows98.....	6
Setup Diskette for Microsoft Windows 2000 or Microsoft Windows ME .....	7
<b>Auto Setup</b> .....	<b>8</b>
Auto Setup .....	8
Auto Setup for DOS .....	9
Auto Setup for Microsoft Windows3.1, Microsoft Windows95, Microsoft Windows98, Microsoft Windows NT, Microsoft Windows2000 or Microsoft Windows ME .....	10
<b>Manual Setup</b> .....	<b>12</b>
<b>Adjusting Your LCD Monitor</b> .....	<b>13</b>
User controls.....	13
On-screen display (OSD) controls .....	15
<b>Further Information</b> .....	<b>18</b>
Display modes .....	18
Power Management.....	19
<b>Troubleshooting</b> .....	<b>20</b>
Further Help.....	22
<b>Specifications</b> .....	<b>24</b>
<b>Warranty</b> .....	<b>27</b>
<b>Compliances</b> .....	see at rear of manual
<b>Service Information</b> .....	see at rear of manual

# Setup

---

## Hardware Requirements

This monitor requires a computer with a suitable on-board sub-system or Video Adapter card that can support XGA 1024 x 768, SVGA 800 x 600, or VGA 640 x 480 at 60Hz.

---

## Handling Instructions

*Do not support the monitor within the screen area. The Liquid Crystal Display is glass and can be damaged by rough handling or excessive pressure.*

1. Lift the monitor by placing both hands under the lower part of the cover.

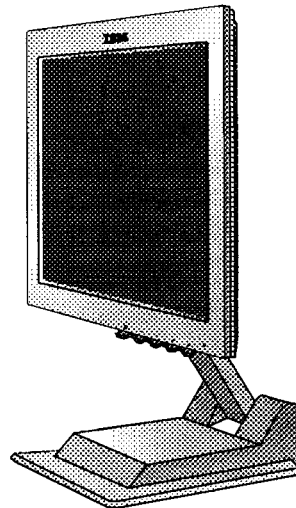

2. Before using your monitor for the first time, remove the clear protective film from the front of the screen.

---

## Workplace Preparation

**i** This section gives advice on what you should consider before you set up your monitor.

### Height

The monitor should be positioned so that the top of the screen is slightly below your eye level when you sit at your workstation.

### Orientation

- Choose a position that gives the least reflection from lights and windows, usually at a right angle to any windows.
- Position the monitor directly in front of you so that you do not have to twist your body to use it.
- Tilt the monitor to a comfortable viewing angle.

---

## Working Practices

**i** This section gives advice on how you can work comfortably and reduce fatigue.

### Rest

Take regular breaks. Vary your posture, stand up and stretch occasionally as prolonged use of computer workstations can be tiring.

### Back

You should sit back in your chair and use the backrest.

### Hands

Use a light touch on the keyboard, keeping your hands and fingers relaxed. Allow a space in front of the keyboard to rest your wrists when not typing. Consider using a wristpad.

### Eyesight

Working with monitors, in common with any prolonged close work, can be visually demanding. Look away from the screen periodically and have your eyesight checked regularly.

### Screen settings

Set the screen brightness and contrast to a comfortable level. You may have to adjust this as the lighting changes during the day. Many application programs let you select color combinations which can help you to view in comfort. See the **User controls** section on page 13 for more information.

---

## Connecting your Monitor

Be sure to read the **'Safety Information'** at the front of this User Guide before carrying out this procedure.

**i** If your system is equipped with a digital Video card using a DVI-D connector, change the signal cable to the DVI cable provided (See page 24 for details)

1. Turn off your computer and all attached devices.
2. Connect the signal cable.
  - When connecting the DVI signal cable (Figure A)  
Connect one end of the monitor signal cable to either of the connectors on the rear panel of the monitor. Connect the other end to the DVI port on the rear panel of the computer and tighten the screws.
  - When connecting the Dsub signal cable (Figure B)  
Connect one end of the monitor signal cable to either of the connectors on the rear panel of the monitor. Connect the other end to the Dsub port on the rear panel of the computer and tighten the screws.
3. Connect the power cord. Connect it to the power adapter first insert the plug into a properly grounded outlet.

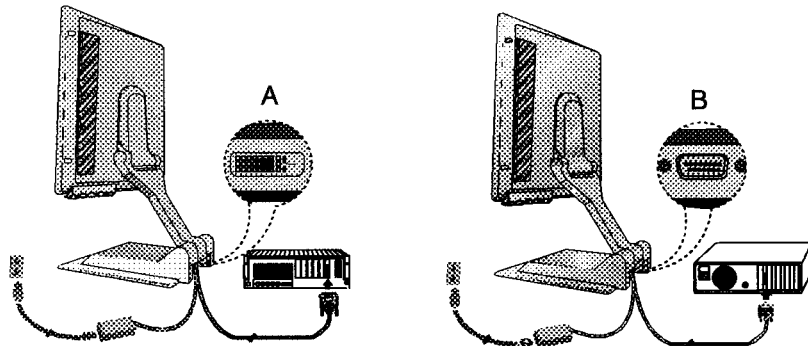

**i** The AC adapter and signal cable are connected to your monitor. If you wish to change these or to fit a different stand, see **Further Help** on page 22.

There should be a DVI port on the computer

---

## Switching on your Monitor

1. Switch on the power source to your monitor.
2. Switch on your monitor by pushing and releasing the power switch marked [⏻].  
[To switch off your monitor, push and release the power switch again.]
3. Switch on your computer.
4. Run AUTO SETUP by following the instructions in the **Auto Setup** section on page 8.

## Adjusting the Monitor Position

**i** With the IBM Flat Panel Monitor, you can adjust its position in various ways for maximum comfort and productivity as shown below.

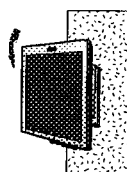
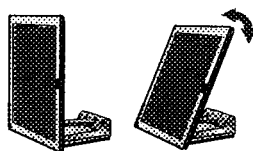
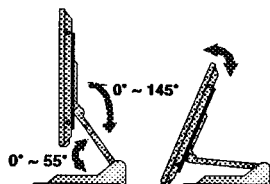

• VESA wall mounting  
(See page 22~23 for the details)

### Viewing Angle (0°~145°)

You can tilt the screen backward and forward as shown below (figure A).

### Height Angle (0°~55°)

You can adjust height of the screen (figure B).

### Landscape & Portrait

This monitor offers the ability to rotate between landscape and portrait modes (figure B). The monitor rotates from Landscape to Portrait through 90° clockwise and from Portrait to Landscape through 90° anti-clockwise.

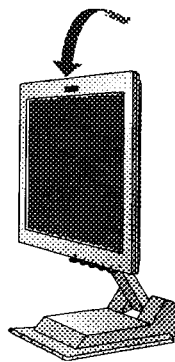

(A)

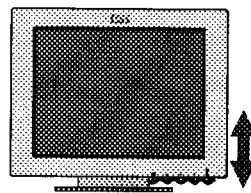

(B)

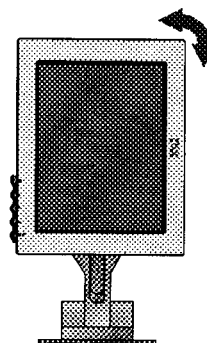

(C)

## Caring for your Monitor

Be sure to turn off the power before you perform any maintenance on the monitor. Clean your monitor as follows:

- Gently wipe the covers and the screen with a soft cloth.
- Remove finger marks and grease with a damp cloth and mild detergent.
- Never use flammable cleaning materials to clean your IBM monitor or any other electrical apparatus.



# Configuring your Monitor

---

## Setup Diskette for Microsoft®Windows®95 or Microsoft®Windows®98

*This section must be completed before continuing with the Microsoft Windows95 or Microsoft Windows98 Auto Setup on page 8.*

**i** On LCD monitors, unlike CRTs, a faster refresh rate does not improve display quality. IBM recommends using either 1024 x 768 at a refresh rate of 60Hz or 640 x 480 at a refresh rate of 60Hz.

To use the Plug and Play feature in Windows 95 or Windows 98, files should be loaded from the **IBM Monitor Installation diskette**.

1. Turn off the computer and all attached devices.
2. Ensure that the monitor is connected correctly.
3. Turn on the monitor and then the system unit. Allow the system to boot into Microsoft Windows95 or Microsoft Windows98.

Your computer's Plug and Play code may warn you that your system hardware has changed. This probably means that it has detected your new monitor for the first time.

4. Open the **DISPLAY PROPERTIES** window by clicking on **START, SETTINGS, CONTROL PANEL** and then double clicking on the **DISPLAY** icon.
5. Select the **SETTINGS** tab.

• **In case of Windows 95 :**

- 6 - 1. Select the **CHANGE DISPLAY TYPE** button.
2. Select the **CHANGE MONITOR TYPE** button.

• **In case of Windows 98 :**

- 6 - 1. Select the **ADVANCED** button.
2. Select the **MONITOR** tab.
3. Open the **UPGRADE DEVICE DRIVER WIZARD** window by clicking on **CHANGE** button and then select the **NEXT** button.  
If the **UPGRADE DEVICE DRIVER WIZARD** is open go to step 6-3. if not continue to step 4.
4. Select the "Display a list of the known drivers for this device so that I can choose a specific driver" and then select the **NEXT** button.
7. Insert the Setup diskette into drive A: and select the **HAVE DISK** button.
8. Select **OK**.
9. Choose **IBM T560** monitor and select **OK**. The files will be copied from the diskette to your hard drive.
10. Close all open windows and remove the diskette.
11. Reboot the system.

The system will automatically select the maximum refresh rate and corresponding Color Matching Profiles.

---

## Setup Diskette for Microsoft®Windows®2000 Professional Microsoft®Windows®ME

*This section must be completed before continuing with the Microsoft Windows2000, Microsoft Windows ME Auto Setup on page 8.*

***i** On LCD monitors, unlike CRTs, a faster refresh rate does not improve display quality. IBM recommends using either 1024 x 768 at a refresh rate of 60Hz or 640 x 480 at a refresh rate of 60Hz.*

To use the Plug and Play feature in Windows 2000 or Windows ME files should be loaded from the **IBM Monitor Installation diskette**.

1. Turn off the computer and all attached devices.
2. Ensure that the monitor is connected correctly.
3. Turn on the monitor and then the system unit. Allow the system to boot into Microsoft Windows2000 or Windows ME.
4. Open the **DISPLAY PROPERTIES** window by clicking on **START, SETTINGS, CONTROL PANEL** and then double clicking on the **DISPLAY** icon.
5. Select the **SETTINGS** tab.
6. Select the **ADVANCED** button.
7. Select the **MONITOR** tab.
8. Select the **PROPERTIES** button.
9. Select the **DRIVER** tab.
10. Open the **UPGRADE DEVICE DRIVER WIZARD** window by clicking on **UPDATE DRIVER** and then select the **NEXT** button.
11. Select the "Display a list of the known drivers for this device so that I can choose a specific driver" and then select the **NEXT** button.
12. Insert the Setup diskette into drive A: and select the **HAVE DISK** button.
13. Select **OK**.
14. Choose **IBM T560** monitor and select **OK**. The files will be copied from the diskette to your hard drive.
15. Close all open windows and remove the diskette.
16. Reboot the system.

The system will automatically select the maximum refresh rate and corresponding Color Matching Profiles.

# Auto Setup

## Auto Setup

**Before carrying out this section, it is very important that The Setup Diskette for Windows 95 or Windows 98 has been run.(see page6)**

**i** The Setup Utility included on the setup diskette is for displaying dot patterns. They do not replace or modify the display driver.

**i** The Auto Setup instructions require the monitor to be warmed up for 15 minutes. This is not required for normal operation.

**i** By pressing the ← and → keys simultaneously allows direct access to the auto set-up controls.

**i** If your computer does not run with the setup diskettes shipped with the monitor, refer to **Manual Setup** on page 12

**i** The AUTO SETUP process only applies to the current screen mode. When a new mode is selected, repeat this section to reset the monitor.

When you first use your monitor you must perform Auto Setup. This procedure sets up your monitor to process the video signals from your computer without image discoloration or smearing. After you perform Auto Setup, the settings are stored and used each time you turn on the monitor.

In order to optimise the displayed image a set-up utility is provided on the IBM Monitor Installation Diskette. Operation of this utility is dependent on the operating system on your computer. For correct operation locate the operating system on your computer from the table below and follow the appropriate instructions. You may choose to run AUTO SETUP for each operating system that you use. This means that if you sometimes use your monitor while running any version of Windows and sometimes also use it from within DOS (not a DOS window), you must run AUTO SETUP for both Windows and DOS. You may run versions of AUTO SETUP in any order.

Operating System	Corresponding Auto Setup procedure
DOS	<b>Auto Setup for DOS on page 9</b>
Microsoft Windows 3.1	<b>Auto Setup Microsoft Windows 3.1, Windows 95, Windows 98, Windows 2000, Microsoft Windows ME or Microsoft Windows NT 4.0 workstation on page 10</b>
Microsoft Windows 95	
Microsoft Windows 98	
Microsoft Windows 2000	
Microsoft Windows ME	
Microsoft Windows NT 4.0 workstation	

Before you begin AUTO SETUP for your computer:

1. Make a backup copy of the setup diskettes supplied with the monitor.
2. Make sure the computer video mode is set in the range of the supported screen resolution shown in the table on page18.

You should perform AUTO SETUP for each screen mode you use.

## Auto Setup for DOS

**i** If the monitor is in standby mode (**STANDBY ON**), it may automatically turn off while you are waiting for it to warm up. If this happens, switch off the monitor and switch it on again after a few seconds.

**i** If you are using PC-DOS/4, change to U.S. mode by typing '**CHEV US**' and pressing **ENTER** at the command prompt. You must use when you run **DOS Auto Setup**.

**i** The size and diversity of the dot pattern varies with the screen resolution.

**i** If the screen flickers, repeat the setup several times until the flicker is minimised, or adjust it manually by following **Manual Setup** on page 12.

1. Turn on the monitor first; then the computer.  
If the message **CHECK SIGNAL CABLE** is displayed, or if nothing is displayed check:
  - that the video interface cable is not connected properly.
  - the correct video adapter card is not installed.
2. Wait approximately 15 minutes, until the monitor warms up.
3. Insert the diskette labelled 'IBM Monitor Installation Disk' into the diskette drive.
4. Display the command prompt screen of the DOS full-screen display.
5. At the command prompt, type '**A**.' and press **ENTER**.
6. Type '**TESTPATD**' and press **ENTER**.
7. Select from the screen the number for the color or text mode you want to setup.
8. Select from the screen the number for the video mode you want to setup.  
You may repeat this process for as many of the color and video modes as you need.
9. When the dot pattern appears, press the OSD Enter button  $\rightarrow$  at the bottom of the monitor to display the initial OSD menu.
10. Use an Arrow button ( $\leftarrow$  or  $\rightarrow$ ), to select the **IMAGE SET-UP** icon  $\square$  and press the OSD Enter button  $\rightarrow$  to access the function.
11. Using an Arrow button ( $\leftarrow$  or  $\rightarrow$ ), select **AUTO** and press the OSD Enter button  $\rightarrow$ . This activates the **AUTO SETUP** procedure, which will optimize the display settings with the provided dot patterns.  
The image may be affected during this procedure and you may notice small changes to the test pattern.
12. When finished, the OSD main menu returns.  
Press the Exit button  $\square$  to exit from the OSD.
13. Press the **ESCAPE** key to exit the test pattern program.
14. Type '**Exit**' at the command prompt to return to Windows.

If you use other operating systems, perform the appropriate **AUTO SETUP** for those systems, also: see

**Auto Setup Microsoft Windows 3.1, Windows 95, Windows 98, Windows 2000, Windows ME or Microsoft Windows NT** on page 10.

## Auto Setup for Microsoft®Windows®3.1, Windows®95 or Microsoft®Windows®2000 or Microsoft®Windows®ME

**i** If the monitor is in standby mode (STANDBY ON), it may automatically turn off while you are waiting for it to warm up.

1. Turn on the monitor first; then the computer.  
If the message CHECK SIGNAL CABLE is displayed, or if nothing is displayed check:
  - that the video interface cable is not connected properly.
  - the correct video adapter card is not installed.
2. Wait approximately 15 minutes, until the monitor warms up.
3. Drag the icon bar and tool bar, if they are displayed, to the bottom of the screen.
4. Insert the diskette labelled 'IBM Monitor Installation Disk' into the diskette drive.
5. Check the operating system installed on your computer and follow the instructions from the table below.

**i** The size and diversity of the dot pattern varies with the screen resolution.

Operating System	Step1	Step2	Step3	Step4
Microsoft Windows 3.1	Open PROGRAM Manger	Open PROGRAM Manger	Select RUN	Type 'A:\TESTPAT' and press ENTER
Microsoft Windows 95				
Microsoft Windows 98	Select START	Select RUN		
Microsoft Windows 2000				
Microsoft Windows ME				
Microsoft Windows NT				

**i** Position the mouse pointer at the bottom center of the screen. This allows AUTO SETUP to run properly

6. When the test pattern appears, press the OSD Enter button  $\leftarrow$  at the bottom of the monitor to display the initial OSD menu.
7. Use an Arrow button ( $\leftarrow$  or  $\rightarrow$ ), to select the IMAGE SET-UP icon  $\square$  and press the OSD Enter button  $\leftarrow$  to access the function.
8. Using an Arrow button ( $\leftarrow$  or  $\rightarrow$ ), select AUTO and press the OSD Enter button  $\leftarrow$ . This activates the AUTO SETUP procedure, which will optimize the display settings with the provided test pattern. The image may be affected during this procedure and you may notice small changes to the test pattern.  
To abort the AUTO SETUP function, press the ESC key.
9. When finished, the OSD main menu returns. Press the Exit button  $\square$  once to exit from the OSD.

10. Press the ESC key to return to Windows.

You have completed the monitor setup for Windows. If you use other operating systems, perform the appropriate AUTO SETUP for those systems, also: see ***Auto Setup for DOS*** on page 9.

# Manual Setup

---

**i** If the monitor is in standby mode (STANDBY ON), it might automatically turn off while you are waiting for it to warm up.

Normally, you can complete the setup procedure using AUTO SETUP, however, if your screen image is still distorted after you perform AUTO SETUP or the setup diskette does not run on your system, perform MANUAL SETUP.

1. Have your monitor turned on for about 15 minutes, until the monitor warms up.
2. Display the image you most frequently use on the screen.
3. Press the OSD Enter button  $\downarrow$  at the bottom of the monitor to display the initial OSD menu.
4. Use an Arrow button (  $\leftarrow$  or  $\rightarrow$  ) to select the **IMAGE SET-UP** icon  $\boxtimes$  and press the OSD Enter button  $\downarrow$  to access the function.
5. Using an Arrow button (  $\leftarrow$  or  $\rightarrow$  ), select MANUAL, press  $\leftarrow$  and then press  $\rightarrow$  once to select COARSE. Left and right arrow adjustment indicators become illuminated (see page 18).
6. Use the Arrow buttons to manually adjust to correct (as much as possible) for noise in the video signal then press  $\boxrightarrow$  to save the changes.
7. Use an Arrow button to select FINE and press the  $\downarrow$  button.
8. Use the Arrow buttons again to tune the image to your liking.
9. When finished, press the Exit button  $\boxrightarrow$  four times to exit from the OSD.



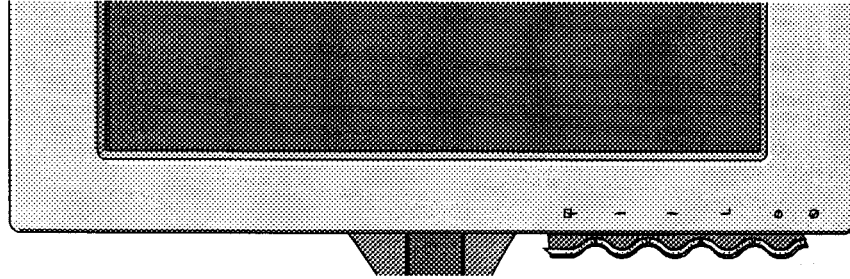

You have completed the monitor setup.

# Adjusting Your LCD Monitor

## User controls



### User control features

Icon	Direct Access Function	Function Using Menu Controls
	None	<ol style="list-style-type: none"> <li>1. Exits from menus, sub menus</li> <li>2. Exits from OSD</li> </ol>
	<ol style="list-style-type: none"> <li>1. Brings up Brightness control OSD</li> <li>2. Left and Right arrows pressed together bring up auto setup</li> </ol>	Moves the cursor to highlight icons or make adjustments.
	<ol style="list-style-type: none"> <li>1. Brings up Contrast control OSD</li> <li>2. Left and Right arrows pressed together bring up auto setup</li> </ol>	Moves the cursor to highlight icons or make adjustments.
	Control lock activated when pressed for 10 seconds	<ol style="list-style-type: none"> <li>1. Displays main OSD menu</li> <li>2. Enters highlighted menus and submenus</li> <li>3. Selects highlighted option</li> </ol>
	Switches the monitors on and off	

**i** The image is already optimized for many display modes, however the user controls can be used to adjust the image to your liking.

**i** The settings are saved after adjustment and when exiting the OSD and will be effective thereafter.



## **CONTROLS LOCK / UNLOCK**

This feature allows you to secure the current control settings, while allowing the user to adjust Brightness, Contrast and initiate Auto Setup, so that they cannot be inadvertently changed. Push and hold the enter button[↵] for 10 seconds; the message "Controls Locked" appears.

You can unlock the OSD controls at any time by pushing the enter button[↵] for 10 seconds; the message "Controls Unlocked" will appear.

## On-screen display (OSD) controls

**i** The LCD monitor needs time to become thermally stable the first time you turn it on each day. Thus, to achieve more accurate adjustments for parameters, allow the LCD monitor to warm up (be On) for at least 15 minutes before making any screen adjustment.

The settings adjustable with the user controls are viewed through the On - Screen Display (OSD). Press the enter button [↵] to display the main OSD menu.



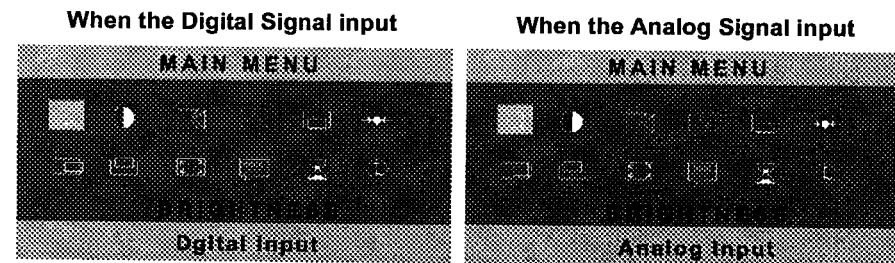

### Initial appearance of OSD main menu;

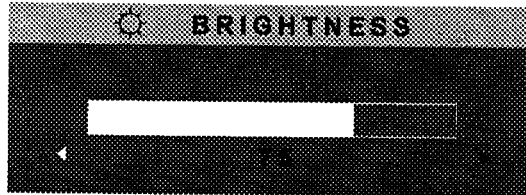



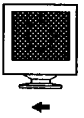
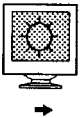











sub menu;

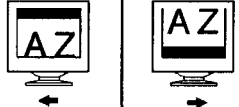

### OSD functions

OSD Icon	Description	sub-menu(s)	Control and Adjustments
 <b>BRIGHTNESS</b>	Adjusts brightness		 
 <b>CONTRAST</b>	Adjusts contrast		 
 <b>IMAGE SET-UP</b>	The IMAGE SET-UP function is used to adjust the level of noise in the video signal which causes horizontal lines or areas on the screen where the image appears to be unstable and jitters or shimmers. This can be done automatically or manually. • It is not available when the digital input	<b>Auto</b>	If AUTO is selected the image will automatically adjust

OSD Icon	Description	Sub-menu(s)	Controls and Adjustments	
	If manual is selected, the user will go to the manual adjustment screen.	<b>Manual SET-UP</b>  <ul style="list-style-type: none"> <li>• Fine</li> <li>• Coarse</li> </ul>	To adjust the focus of the display. This item allows you to remove any horizontal noise and clear or sharpen the image of characters. <b>Fine</b> adjustments should be can done after adjusting the <b>Coarse</b> .	
  <b>COLOR</b>	Select the Color Mode you find most comfortable and then fine tune the colors using the User Color Mode menu, if necessary.	<b>COLOR MODE</b>  <b>Preset 1</b> (Warm White)  <b>Preset 2</b> (Normal White)  <b>Preset 3</b> (Cool White)		
		<b>USER COLOR MODE-</b>  <ul style="list-style-type: none"> <li>• Red</li> <li>• Green</li> <li>• Blue</li> </ul>	Increases or decreases redness  Increases or decreases greenness  Increases or decreases blueness	
  <b>OSD Position</b>	Changes the position of the OSD on the screen.	<b>H-POSITION</b>		
		<b>V-POSITION</b>		

OSD Icon	Description	Sub-menu(S)	Controls and Adjustments
 <b>RESET</b>	Reset should return all available functions (apart from language which should not change unless adjusted via the LANGUAGE menu) to their factory presets.	<ul style="list-style-type: none"> <li>• YES</li> <li>• NO</li> </ul>	
 <b>H-POSITION</b>	Moves the screen left and right . <ul style="list-style-type: none"> <li>• It is not available when the digital input</li> </ul>		
 <b>V-POSITION</b>	Moves the screen up and down. <ul style="list-style-type: none"> <li>• It is not available when the digital input</li> </ul>		
 <b>OSD SIZE</b>	To select OSD size		<ul style="list-style-type: none"> <li>• SMALL</li> <li>• MID</li> <li>• BIG</li> </ul>
 <b>Language</b>	The language chosen affects only the language of the OSD. Select one of the five language to use for the OSD. It has no effect on any software running on the computer.		<ul style="list-style-type: none"> <li>• ENGLISH</li> <li>• FRANCAIS</li> <li>• DEUTSCH</li> <li>• ITALIANO</li> <li>• ESPANOL</li> </ul>
 <b>OSD time</b>	To select OSD display duration time. (5 - 60 seconds)		
 <b>Information</b>	<p>Display model name, serial number, year of manufacture and microcode level.</p> <p>Display all preset modes stored in the monitor.</p> <p>Display all user modes stored in the monitor.</p> <p>The current display mode will be shown at the base of all information screens.</p>		<ul style="list-style-type: none"> <li>• INFORMATION</li> <li>• PRESET MODES</li> <li>• USER MODES</li> </ul> <p>Use the ← and → buttons to move between information screens.</p>

# Further Information

---

## Display modes

The display mode the monitor uses is controlled by the computer. Therefore, you should refer to your computer documentation for details on how to change display modes.

The image size, position and shape may change when the display mode changes. This is normal and the image can be readjusted using AUTO SETUP and the monitor controls.

Unlike CRT monitors, which require a high refresh rate to minimize flicker, TFT technology is inherently flicker-free. If possible, configure your computer for 1024 x 768 addressability at 60Hz vertical refresh rate.

For the display modes listed below, the screen image has been optimized during manufacture.

### Factory Set Display Modes

Addressability	Refresh Rate	Horizontal Frequency
640 x 350	70 Hz	31.5 kHz
720 x 400	70 Hz	31.5 kHz
640 x 480	60 Hz	31.5 kHz
640 x 480	66 Hz	35.0 kHz
640 x 480	75 Hz	37.5 kHz
800 x 600	56 Hz	35.2 kHz
800 x 600	60 Hz	37.9 kHz
800 x 600	72 Hz	48.1 kHz
800 x 600	75 Hz	46.9 kHz
832 x 624	75 Hz	49.7 kHz
1024 x 768 †	60 Hz	48.4 kHz
1024 x 768	70 Hz	56.5 kHz
1024 x 768	75 Hz	60.0 kHz

† Recommended

**Note : VESA timings are as detailed in the VESA "Display Monitor Timing Specification". Version 1.0, Revision 0.8, Dated 09/17/98.**

## Power Management

**i** If your computer has previously been used with a CRT monitor and is currently configured to a display mode outside the range that the Flat Panel monitor can display, you may need to re-attach the CRT monitor temporarily until you have reconfigured the computer, preferably to 1024 x 768 at 60Hz.

To benefit from power management, the monitor must be used in conjunction with a computer that implements the Video Electronics Standards Association (VESA) Display Power Management Signalling (DPMS) Standard.

The power management feature is invoked when the computer recognizes that you have not used your mouse or keyboard for a user-definable period. There are several states as described in the table below.

As an ENERGY STAR 2000® Partner, **IBM** has determined that this product meets the ENERGY STAR 2000® guidelines for energy efficiency.

IBM recommends that you switch off your monitor at the end of each working day, or whenever you expect to leave it unused for long periods during the day.

State	Power Indicator	Screen	Restoring Operation	Compliance
On	Steady green	Normal		
DPMS Standby	Steady amber	Blank	Press a key or move the mouse.	ENERGY STAR 2000®
DPMS Suspend	Flashing amber (0.5 sec. interval)	Blank	Press a key or move the mouse.‡	ENERGY STAR 2000®
DPMS Off	Flashing amber (1 sec. interval)	Blank	Press a key or move the mouse.‡	ENERGY STAR 2000®

‡ There may be a slight delay before the picture reappears.

# Troubleshooting

---

If you have a problem setting up or using your monitor, you may be able to solve it yourself. Before calling your retailer or IBM, try the suggested actions that are appropriate to your problem.

Problem	Possible Cause	Suggested Action	Reference
Screen is blank and power indicator is off.	No power to monitor.	<ul style="list-style-type: none"> <li>• Ensure that the electrical outlet and the monitor are both switched on.</li> <li>• Check that the power cord is firmly plugged into the electrical outlet and the power supply unit.</li> <li>• If the power cord plug has a removable fuse, replace it.</li> <li>• Try another power cord.</li> <li>• Try another electrical outlet.</li> </ul>	<b>Connecting your Monitor</b> section on page 4.
Screen is blank and power indicator is steady green.	Brightness and Contrast may be too low.	<ul style="list-style-type: none"> <li>• Adjust brightness and contrast.</li> </ul>	<b>User controls</b> section on page 13.
Screen is blank and power indicator is steady amber.	The monitor is in the Power Management Standby state.	<ul style="list-style-type: none"> <li>• Press any key on the keyboard or move the mouse to restore operation.</li> <li>• Check the Power Management software on your computer.</li> <li>• Press the  to switch between analog and digital mode. If the panel is the wrong mode for the signal being provided, the monitor appears to go into sleep mode.</li> </ul>	<b>Power Management</b> section on page 19.

**i** For image problems, you may want to run **AUTO SETUP** again before consulting to this section. In most cases, **AUTO SETUP** can fix the problems. See **Auto Setup for the computer** on page 8 for details.

Problem	Possible Cause	Suggested Action	Reference
Screen is blank and power indicator is flashing green every 0.5 second	The monitor is not receiving a video signal	<ul style="list-style-type: none"> <li>• Check that the signal cable is firmly connected to the computer.</li> <li>• Check that no pins are bent in the signal cable connector.</li> </ul>	<b>Connecting your monitor</b> section on page 4
	Display mode of the computer is outside the range of the monitor	<ul style="list-style-type: none"> <li>• Reconfigure key on the computer to use a supported display mode.</li> </ul>	<b>Further Information</b> section on page 18
Screen is blank and power indicator is flashing green every 0.5 or 1 second	The monitor is in the Power Management Suspend or Off state.	<ul style="list-style-type: none"> <li>• Press any key on the keyboard or move the mouse to restore operation.</li> <li>• Check the Power management software on your computer.</li> </ul>	<b>Power Management</b> section on page 19
Image appears to be smeared	There are noises in the video signal	<ul style="list-style-type: none"> <li>• Select IMAGE SET-UP menu in the OSD. Then select MANUAL to adjust FINE / COARSE settings.</li> </ul>	<b>User Controls</b> section on page 13
Image appears to be discolored	The color setting may be incorrect.	<ul style="list-style-type: none"> <li>• Adjust the Color settings.</li> </ul>	<b>User Controls</b> section on page 13
A few dots are missing, discolored, or inappropriately lighted.	The LCD contains over 2,300,000 thin-film transistors (TFTs). A small number of missing, discolored, or lighted dots may be present on the screen, which is an intrinsic characteristic of the TFT LCD technology and is not an LCD defect.		



---

## Further Help

Machine Name – T560 Color Monitor

Warranty Period – Three (3) Years

See the IBM Statement of Limited Warranty included in this publication for IBM's warranty terms and conditions.

The IBM Machine Warranty worldwide Web site at [http://www-1.ibm.com/servers/support/machine\\_warranties/](http://www-1.ibm.com/servers/support/machine_warranties/) provides a worldwide overview of IBM's Limited Warranty for IBM Machines, a Glossary of IBM definitions, Frequently Asked Questions (FAQs) and Support by Product (Machine) with links to Product Support pages. **The IBM Statement of Limited Warranty is also available on this site in 29 languages via pdf files.**

**i** If possible, stay by your computer. Your Technical Support Representative may wish to go through the problem with you during the call.

### Service and support

With the original purchase of an IBM machine, you have access to extensive support coverage. During the IBM machine warranty period, you may call IBM or your reseller for problem determination assistance under the terms of the IBM Statement of Limited Warranty. You may seek help as follows:

**Call IBM HelpCenter® .**

**In the US call 1-800-772-2227**

**In Canada (Toronto only) call 416-383-3344**

**(all others) call 1-800-565-3344**

In other countries, contact your dealer, retailer, or other IBM authorized servicer. Before calling, please have available as much of the following information as possible:

1. Type, model and serial number from the label on the back of your monitor.
2. Purchase receipt.
3. Description of problem.
4. Computer type and model.
5. System configuration (hardware fitted etc.).
6. System BIOS version number.
7. Operating System and version number.
8. Display driver version number.

If possible, stay by your computer system. Your technical support representative might want to go through the problem with you during the call.

### VESA wall mounting

Alternative stands for your IBM Flat Panel Monitor may be available from specialist suppliers.

To attach the monitor to an arm or a surface of wall, please follow the instructions below:

1. Power off the monitor, and then disconnect the signal cable and the power cord from the monitor.

**i** More help, late-breaking news and details of the latest accessories for these products may be found on the worldwide web at:

<http://www.pc.ibm.com/us/accessories>

Information about the Video Electronics Standards Association can be found on the worldwide web at :

<http://www.vesa.org>

**i** Be sure to read the **Safety Information** at the front of this user guide before carrying out changes to stands.

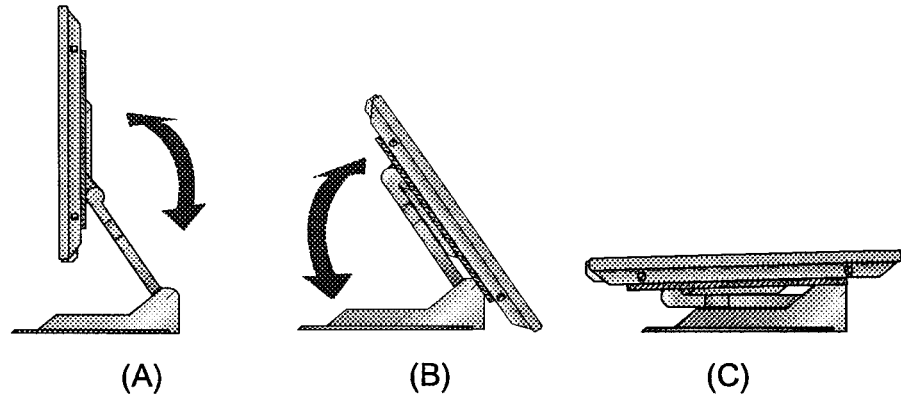

2. Fold the monitor arm in the order of Figure (A), (B) and (C) as shown above.
3. Place the monitor on a stable and shock-resistant floor, with the front of the monitor at the bottom.

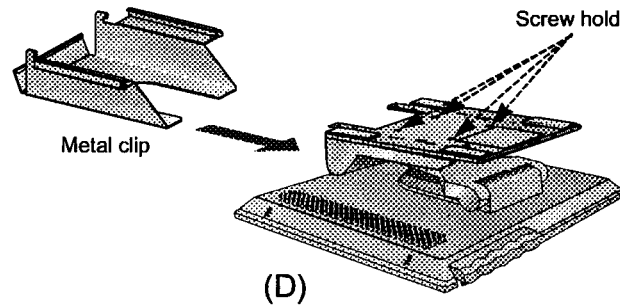

4. Hold the metal clip and push it carefully until it clamps both of the stand and the arm firmly, as shown in Figure (D) above. (The metal clip is used to keep the arm folded.)
5. You have to use the four screw holds on the bottom of the stand to attach the monitor to the surface of wall. For additional information, see the instructions supplied with the purchased arm.
6. Locate a place to which you want to attach the monitor. When locating the place, you have to consider the lengths of the signal cable and the power cord.
7. Attach the monitor to the place you selected in the step 6, and then connect the signal cable and the power cord to the monitor. (See page 4 for instructions on how to connect the signal cable and the power cord.)

To obtain the correct cables and/or to get further instructions on installing them, call the IBM HELPCENTER at the above numbers or contact your dealer, retailer, or other IBM authorized Servicer.

# Specifications

## DVI-D Connector (Digital)



**i** The DVI - D(Digital Visual Interface - integrated) port supports analog and digital signal inputs and also improves quality of the displayed image by eliminating poor video at the monitor source.

Pin	Signal(DVI-D)
1.	T. M. D. S. Data2-
2.	T. M. D. S. Data2+
3.	T. M. D. S. Data2/4 Shield
4.	T. M. D. S. Data4-
5.	T. M. D. S. Data4+
6.	DDC Clock
7.	DDC Data
8.	Analog Vertical Sync.
9.	T. M. D. S. Data1-
10.	T. M. D. S. Data1+
11.	T. M. D. S. Data1/3 Shield
12.	T. M. D. S. Data3-
13.	T. M. D. S. Data3+
14.	+5V Power
15.	Ground (return for +5V, H. Sync. and V. Sync.)

Pin	Signal(DVI-D)
16.	Hot Plug Detect
17.	T. M. D. S. Data0-
18.	T. M. D. S. Data0+
19.	T. M. D. S. Data0/5 Shield
20.	T. M. D. S. Data5-
21.	T. M. D. S. Data5+
22.	T. M. D. S. Clock Shield
23.	T. M. D. S. Clock+
24.	T. M. D. S. Clock-

This color monitor (Type-model 6656-Hxx) uses a 15.0-inch TFT LCD.

**i** Power consumption figures are for the monitor and the power supply combined.

Full Up Condition	Width: Depth: Height:	365.2 mm 235 mm 433 mm
Weight		4.5 kg (9.92 lbs)
Stand Range	Tilt Range : Height Range : Rotate :	0° ~ 145° (Head) 0° ~ 55°(Base) 90° clockwise (L → P)
Image	Viewable Image Size: Maximum Height: Maximum Width: Pixel Pitch:	15.0" (380.1 mm) 228.1mm 304.1 mm 0.297 mm (H) x 0.297 mm (V)
Power Input	Supply Voltage: Max Supply Current:	90 - 264 Vac 60/50 ± 3Hz 3 Arms at 90 Vac
Power Consumption	Normal Operation: DPMS Stand-by: DPMS Suspend: DPMS off:	< 30 W < 3 W < 3 W < 3 W
Video Input	Input Signal: Horiz. Addressability: Vert. Addressability: Clock Frequency:	Analog /Digital Direct Drive 75 ohm 0.7V 1024 pixels (max) 768 lines (max) 78 MHz
Sync Input	Type	Separate (TMDS)
Communications	VESA DDC:	2B
Supported Display Modes	Standard modes : Horiz / Vert Freq:	IBM, VESA, MAC See Factory Set Display Modes on page 18. See Display Mode Ranges on page 26.
Environment	Temperature: Operating: Storage: Shipping: Humidity: Operating: Storage: Shipping:	10 to 35° C - 20 to 60° C - 20 to 60° C 10 to 80% 5 to 95% 5 to 95%

---

### Display Mode Ranges

Addressability	Refresh Rate / Range ( + / - 3%)	Horizontal Frequency / Range ( + / - 3%)
640 x 350	67.9 ~ 72.1 Hz	30.56 ~ 31.45 kHz
720 x 400	67.9 ~ 72.1 Hz	30.56 ~ 31.45 kHz
640 x 480	58.2 ~ 61.8 Hz	30.56 ~ 31.45 kHz
640 x 480	64.0 ~ 68.0 Hz	34.95 ~ 36.05 kHz
640 x 480	72.8 ~ 77.3 Hz	36.38 ~ 38.63 kHz
800 x 600	54.3 ~ 57.7 Hz	34.14 ~ 36.26 kHz
800 x 600	58.2 ~ 61.8 Hz	36.76 ~ 39.04 kHz
800 x 600	69.8 ~ 74.2 Hz	46.66 ~ 49.54 kHz
800 x 600	72.8 ~ 77.3 Hz	45.49 ~ 48.31 kHz
832 x 624	72.8 ~ 77.3 Hz	48.21 ~ 51.19 kHz
1024 x 768	58.2 ~ 61.8 Hz	46.95 ~ 49.85 kHz
1024 x 768	67.9 ~ 72.1 Hz	54.81 ~ 58.20 kHz
1024 x 768	72.8 ~ 77.3 Hz	58.20 ~ 61.80 kHz

# Statement of Limited Warranty

## Part 1 - General Terms

*This Statement of Limited Warranty includes Part 1 - General Terms and Part 2 - Country-unique Terms. The terms of Part 2 replace or modify those of Part 1. The warranties provided by IBM in this Statement of Limited Warranty apply only to Machines you purchase for your use, and not for resale, from IBM or your reseller. The term "Machine" means an IBM machine, its features, conversions, upgrades, elements, or accessories, or any combination of them. The term "Machine" does not include any software programs, whether pre-loaded with the Machine, installed subsequently or otherwise. Unless IBM specifies otherwise, the following warranties apply only in the country where you acquire the Machine. Nothing in this Statement of Limited Warranty affects any statutory rights of consumers that cannot be waived or limited by contract. If you have any questions, contact IBM or your reseller.*

### The IBM Warranty for Machines

IBM warrants that each Machine 1) is free from defects in materials and workmanship and 2) conforms to IBM's Official Published Specifications ("Specifications"). The warranty period for a Machine is a specified, fixed period commencing on its Date of Installation. The date on your sales receipt is the Date of Installation unless IBM or your reseller informs you otherwise.

If a Machine does not function as warranted during the warranty period, and IBM or your reseller are unable to either 1) make it do so or 2) replace it with one that is at least functionally equivalent, you may return it to your place of purchase and your money will be refunded.

### Extent of Warranty

The warranty does not cover the repair or exchange of a Machine resulting from misuse, accident, modification, unsuitable physical or operating environment, improper maintenance by you, or failure caused by a product for which IBM is not responsible. The warranty is voided by removal or alteration of Machine or parts identification labels.

**THESE WARRANTIES ARE YOUR EXCLUSIVE WARRANTIES AND REPLACE ALL OTHER WARRANTIES OR CONDITIONS, EXPRESS OR IMPLIED, INCLUDING, BUT NOT LIMITED TO, THE IMPLIED WARRANTIES OR CONDITIONS OF MERCHANTABILITY AND FITNESS FOR A PARTICULAR PURPOSE. THESE WARRANTIES GIVE YOU SPECIFIC LEGAL RIGHTS AND YOU MAY ALSO HAVE OTHER RIGHTS WHICH VARY FROM JURISDICTION TO JURISDICTION. SOME JURISDICTIONS DO NOT ALLOW THE EXCLUSION OR LIMITATION OF EXPRESS OR IMPLIED WARRANTIES, SO THE ABOVE EXCLUSION OR LIMITATION MAY NOT APPLY TO YOU. IN THAT EVENT, SUCH WARRANTIES ARE LIMITED IN DURATION TO THE WARRANTY PERIOD. NO WARRANTIES APPLY AFTER THAT PERIOD.**

### Items Not Covered by Warranty

IBM does not warrant uninterrupted or error-free operation of a Machine.

Any technical or other support provided for a Machine under warranty, such as assistance via telephone with "how-to" questions and those regarding Machine set-up and installation, will be provided **WITHOUT WARRANTIES OF ANY KIND.**

### Warranty Service

To obtain warranty service for a Machine, contact IBM or your reseller. If you do not register your Machine with IBM, you may be required to present proof of purchase. During the warranty period, IBM or your reseller, if approved by IBM to provide warranty service, provides without charge certain types of repair and exchange service to keep Machines in, or restore them to, conformance with their Specifications. IBM or your reseller will inform you of the available types of service for a Machine based on its country of installation. At its discretion, IBM or your reseller will 1) either repair or exchange the failing Machine and 2) provide the service either at your location or a service center. IBM or your reseller will also manage and install selected engineering changes that apply to the Machine.

Some parts of IBM Machines are designated as Customer Replaceable Units (called "CRUs"), e.g., keyboards, memory, or hard disk drives. IBM ships CRUs to you for replacement by you. You must return all defective CRUs to IBM within 30 days of your receipt of the replacement CRU. You are responsible for downloading designated Machine Code and Licensed Internal Code updates from an IBM Internet Web site or from other electronic media, and following the instructions that IBM provides.

When warranty service involves the exchange of a Machine or part, the item IBM or your reseller replaces becomes its property and the replacement becomes yours. You represent that all removed items are genuine and unaltered. The replacement may not be new, but will be in good working order and at least functionally equivalent to the item replaced. The replacement assumes the warranty service status of the replaced item. Many features, conversions, or upgrades involve the removal of parts and their return to IBM. A part that replaces a removed part will assume the warranty service status of the removed part. Before IBM or your reseller exchanges a Machine or part, you agree to remove all features, parts, options, alterations, and attachments not under warranty service.

You also agree to

1. ensure that the Machine is free of any legal obligations or restrictions that prevent its exchange;
2. obtain authorization from the owner to have IBM or your reseller service a Machine that you do not own; and

3. where applicable, before service is provided:
  - a. follow the problem determination, problem analysis, and service request procedures that IBM or your reseller provides;
  - b. secure all programs, data, and funds contained in a Machine;
  - c. provide IBM or your reseller with sufficient, free, and safe access to your facilities to permit them to fulfill their obligations; and
  - d. inform IBM or your reseller of changes in a Machine's location.

IBM is responsible for loss of, or damage to, your Machine while it is 1) in IBM's possession or 2) in transit in those cases where IBM is responsible for the transportation charges.

Neither IBM nor your reseller is responsible for any of your confidential, proprietary or personal information contained in a Machine which you return to IBM or your reseller for any reason. You should remove all such information from the Machine prior to its return.

#### **Limitation of Liability**

Circumstances may arise where, because of a default on IBM's part or other liability, you are entitled to recover damages from IBM. In each such instance, regardless of the basis on which you are entitled to claim damages from IBM (including fundamental breach, negligence, misrepresentation, or other contract or tort claim), except for any liability that cannot be waived or limited by applicable laws, IBM is liable for no more than

1. damages for bodily injury (including death) and damage to real property and tangible personal property; and
2. the amount of any other actual direct damages, up to the charges (if recurring, 12 months' charges apply) for the Machine that is subject of the claim. For purposes of this item, the term "Machine" includes Machine Code and Licensed Internal Code.

This limit also applies to IBM's suppliers and your reseller. It is the maximum for which IBM, its suppliers, and your reseller are collectively responsible.

**UNDER NO CIRCUMSTANCES IS IBM LIABLE FOR ANY OF THE FOLLOWING: 1) THIRD-PARTY CLAIMS AGAINST YOU FOR DAMAGES (OTHER THAN THOSE UNDER THE FIRST ITEM LISTED ABOVE); 2) LOSS OF, OR DAMAGE TO, YOUR RECORDS OR DATA; OR 3) SPECIAL, INCIDENTAL, OR INDIRECT DAMAGES OR FOR ANY ECONOMIC CONSEQUENTIAL DAMAGES, LOST PROFITS OR LOST SAVINGS, EVEN IF IBM, ITS SUPPLIERS OR YOUR RESELLER IS INFORMED OF THEIR POSSIBILITY. SOME JURISDICTIONS DO NOT ALLOW THE EXCLUSION OR LIMITATION OF INCIDENTAL OR CONSEQUENTIAL DAMAGES, SO THE ABOVE LIMITATION OR EXCLUSION MAY NOT APPLY TO YOU.**

#### **GOVERNING LAW**

Both you and IBM consent to the application of the laws of the country in which you acquired the Machine to govern, interpret, and enforce all of your and IBM's rights, duties, and obligations arising from, or relating in any manner to, the subject matter of this Agreement, without regard to conflict of law principles.

## **Part 2 - Country-unique Terms**

### **AMERICAS**

#### **BRAZIL**

**Governing Law:** *The following is added after the first sentence:*

Any litigation arising from this Agreement will be settled exclusively by the court of Rio de Janeiro.

#### **NORTH AMERICA**

**Warranty Service:** *The following is added to this Section:*

To obtain warranty service from IBM in Canada or the United States, call 1-800-IBM-SERV (426-7378).

#### **CANADA**

**Governing Law:** *The following replaces "laws of the country in which you acquired the Machine" in the first sentence: laws in the Province of Ontario.*

#### **UNITED STATES**

**Governing Law:** *The following replaces "laws of the country in which you acquired the Machine" in the first sentence: laws of the State of New York.*

### **ASIA PACIFIC**

#### **AUSTRALIA**

**The IBM Warranty for Machines:** The following paragraph is added to this Section:

The warranties specified in this Section are in addition to any rights you may have under the Trade Practices Act 1974 or other similar legislation and are only limited to the extent permitted by the applicable legislation.

**Limitation of Liability:** The following is added to this Section:

Where IBM is in breach of a condition or warranty implied by the Trade Practices Act 1974 or other similar legislation, IBM's liability is limited to the repair or replacement of the goods or the supply of equivalent goods. Where that condition or warranty relates to right to sell, quiet possession or clear title, or the goods are of a kind ordinarily acquired for personal, domestic or household use or consumption, then none of the limitations in this paragraph apply.

**Governing Law:** The following replaces "laws of the country in which you acquired the Machine" in the first sentence: laws of the State or Territory.

**CAMBODIA, LAOS, AND VIETNAM**

**Governing Law:** The following replaces “laws of the country in which you acquired the Machine” in the first sentence: laws of the State of New York.

The following is added to this Section:

Disputes and differences arising out of or in connection with this Agreement shall be finally settled by arbitration which shall be held in Singapore in accordance with the rules of the International Chamber of Commerce (ICC). The arbitrator or arbitrators designated in conformity with those rules shall have the power to rule on their own competence and on the validity of the Agreement to submit to arbitration. The arbitration award shall be final and binding for the parties without appeal and the arbitral award shall be in writing and set forth the findings of fact and the conclusions of law.

All proceedings shall be conducted, including all documents presented in such proceedings, in the English language. The number of arbitrators shall be three, with each side to the dispute being entitled to appoint one arbitrator.

The two arbitrators appointed by the parties shall appoint a third arbitrator before proceeding upon the reference. The third arbitrator shall act as chairman of the proceedings. Vacancies in the post of chairman shall be filled by the president of the ICC. Other vacancies shall be filled by the respective nominating party. Proceedings shall continue from the stage they were at when the vacancy occurred.

If one of the parties refuses or otherwise fails to appoint an arbitrator within 30 days of the date the other party appoints its, the first appointed arbitrator shall be the sole arbitrator, provided that the arbitrator was validly and properly appointed. The English language version of this Agreement prevails over any other language version.

**HONG KONG AND MACAU**

**Governing Law:** The following replaces “laws of the country in which you acquired the Machine” in the first sentence: laws of Hong Kong Special Administrative Region

**INDIA**

**Limitation of Liability:** *The following replaces items 1 and 2 of this Section:*

1. liability for bodily injury (including death) or damage to real property and tangible personal property will be limited to that caused by IBM’s negligence;
2. as to any other actual damage arising in any situation involving nonperformance by IBM pursuant to, or in any way related to the subject of this Statement of Limited Warranty, IBM’s liability will be limited to the charge paid by you for the individual Machine that is the subject of the claim.

**JAPAN**

**Governing Law:** *The following sentence is added to this Section:*

Any doubts concerning this Agreement will be initially resolved between us in good faith and in accordance with the principle of mutual trust.

**NEW ZEALAND**

**The IBM Warranty for Machines:** *The following paragraph is added to this Section:*

The warranties specified in this Section are in addition to any rights you may have under the Consumer Guarantees Act 1993 or other legislation which cannot be excluded or limited. The Consumer Guarantees Act 1993 will not apply in respect of any goods which IBM provides, if you require the goods for the purposes of a business as defined in that Act.

**Limitation of Liability:** *The following is added to this Section:*

Where Machines are not acquired for the purposes of a business as defined in the Consumer Guarantees Act 1993, the limitations in this Section are subject to the limitations in that Act.

**PEOPLE’S REPUBLIC OF CHINA (PRC)**

**Governing Law:** *The following is replaces this Section:*

Both you and IBM consent to the application of the laws of the State of New York (except when local law requires otherwise) to govern, interpret, and enforce all your and IBM’s rights, duties, and obligations arising from, or relating in any manner to, the subject matter of this Agreement, without regard to conflict of law principles. Any disputes arising from or in connection with this Agreement will first be resolved by friendly negotiations, failing which either of us has the right to submit the dispute to the China International Economic and Trade Arbitration Commission in Beijing, the PRC, for arbitration in accordance with its arbitration rules in force at the time. The arbitration tribunal will consist of three arbitrators. The language to be used therein will be English and Chinese. An arbitral award will be final and binding on all the parties, and will be enforceable under the Convention on the Recognition and Enforcement of Foreign Arbitral Awards (1958). The arbitration fee will be borne by the losing party unless otherwise determined by the arbitral award. During the course of arbitration, this Agreement will continue to be performed except for the part which the parties are disputing and which is undergoing arbitration.

**EUROPE, MIDDLE EAST, AFRICA (EMEA)**

**THE FOLLOWING TERMS APPLY TO ALL EMEA COUNTRIES.**

The terms of this Statement of Limited Warranty apply to Machines purchased from IBM or an IBM reseller.

**Warranty Service:**

If you purchase an IBM Machine in Austria, Belgium, Denmark, Estonia, Finland, France, Germany, Greece, Iceland, Ireland, Italy, Latvia, Lithuania, Luxembourg, Netherlands, Norway, Portugal, Spain, Sweden, Switzerland or United Kingdom, you may obtain warranty service for that Machine in any of those countries from either (1) an IBM reseller approved to perform warranty service or (2) from IBM.



If you purchased an IBM Personal Computer Machine in Albania, Armenia, Belarus, Bosnia and Herzegovina, Bulgaria, Croatia, Czech Republic, Georgia, Hungary, Kazakhstan, Kirghizia, Federal Republic of Yugoslavia, Former Yugoslav Republic of Macedonia (FYROM), Moldova, Poland, Romania, Russia, Slovak Republic, Slovenia, or Ukraine, you may obtain warranty service for that Machine in any of those countries from either (1) an IBM reseller approved to perform warranty service or (2) from IBM. If you purchase an IBM Machine in a Middle Eastern or African country, you may obtain warranty service for that Machine from the IBM entity within the country of purchase, if that IBM entity provides warranty service in that country, or from an IBM reseller, approved by IBM to perform warranty service on that Machine in that country. Warranty service in Africa is available within 50 kilometers of an IBM authorized service provider. You are responsible for transportation costs for Machines located outside 50 kilometers of an IBM authorized service provider.

#### **Governing Law:**

The applicable laws, that govern, interpret and enforce rights, duties, and obligations of each of us arising from, or relating in any manner to, the subject matter of this Statement, without regard to conflict of laws principles, as well as Country-unique terms and competent court for this Statement are those of the country in which the warranty service is being provided, except that in 1) Albania, Bosnia-Herzegovina, Bulgaria, Croatia, Hungary, Former Yugoslav Republic of Macedonia, Romania, Slovakia, Slovenia, Armenia, Azerbaijan, Belarus, Georgia, Kazakhstan, Kyrgyzstan, Moldova, Russia, Tajikistan, Turkmenistan, Ukraine, and Uzbekistan, the laws of Austria apply; 2) Estonia, Latvia, and Lithuania, the laws of Finland apply; 3) Algeria, Benin, Burkina Faso, Cameroon, Cape Verde, Central African Republic, Chad, Congo, Djibouti, Democratic Republic of Congo, Equatorial Guinea, France, Gabon, Gambia, Guinea, Guinea-Bissau, Ivory Coast, Lebanon, Mali, Mauritania, Morocco, Niger, Senegal, Togo, and Tunisia, this Agreement will be construed and the legal relations between the parties will be determined in accordance with the French laws and all disputes arising out of this Agreement or related to its violation or execution, including summary proceedings, will be settled exclusively by the Commercial Court of Paris; 4) Angola, Bahrain, Botswana, Burundi, Egypt, Eritrea, Ethiopia, Ghana, Jordan, Kenya, Kuwait, Liberia, Malawi, Malta, Mozambique, Nigeria, Oman, Oman Pakistan, Qatar, Rwanda, Sao Tome, Saudi Arabia, Sierra Leone, Somalia, Tanzania, Uganda, United Arab Emirates, United Kingdom, West Bank/Gaza, Yemen, Zambia, and Zimbabwe, this Agreement will be governed by English Law and disputes relating to it will be submitted to the exclusive jurisdiction of the English courts; and 5) in Greece, Israel, Italy, Portugal, and Spain any legal claim arising out of this Statement will be brought before, and finally settled by, the competent court of Athens, Tel Aviv, Milan, Lisbon, and Madrid, respectively.

#### **THE FOLLOWING TERMS APPLY TO THE COUNTRY SPECIFIED:**

##### **AUSTRIA and GERMANY**

**The IBM Warranty for Machines:** *The following replaces the first sentence of the first paragraph of this Section:* The warranty for an IBM Machine covers the functionality of the Machine for its normal use and the Machine's conformity to its Specifications.

*The following paragraphs are added to this Section:*

The minimum warranty period for Machines is six months. In case IBM or your reseller is unable to repair an IBM Machine, you can alternatively ask for a partial refund as far as justified by the reduced value of the unrepaired Machine or ask for a cancellation of the respective agreement for such Machine and get your money refunded.

**Extent of Warranty:** *The second paragraph does not apply.*

**Warranty Service:** *The following is added to this Section:*

During the warranty period, transportation for delivery of the failing Machine to IBM will be at IBM's expense.

**Limitation of Liability:** *The following paragraph is added to this Section:*

The limitations and exclusions specified in the Statement of Limited Warranty will not apply to damages caused by IBM with fraud or gross negligence and for express warranty.

*The following sentence is added to the end of the first paragraph of item 2:*

IBM's liability under this item is limited to the violation of essential contractual terms in cases of ordinary negligence.

##### **EGYPT**

**Limitation of Liability:** *The following replaces item 2 in this Section:*

as to any other actual direct damages, IBM's liability will be limited to the total amount you paid for the Machine that is the subject of the claim. For purposes of this item, the term "Machine" includes Machine Code and Licensed Internal Code.

Applicability of suppliers and resellers (unchanged).

##### **FRANCE**

**Limitation of Liability:** *The following replaces the second sentence of the first paragraph of this Section:*

In such instances, regardless of the basis on which you are entitled to claim damages from IBM, IBM is liable for no more than: (items 1 and 2 unchanged).

##### **IRELAND**

**Extent of Warranty:** *The following is added to this Section:*

Except as expressly provided in these terms and conditions, all statutory conditions, including all warranties implied, but without prejudice to the generality of the foregoing all warranties implied by the Sale of Goods Act 1893 or the Sale of Goods and Supply of Services Act 1980 are hereby excluded.

**Limitation of Liability:** *The following replaces items one and two of the first paragraph of this Section:*

1. death or personal injury or physical damage to your real property solely caused by IBM's negligence; and

2. the amount of any other actual direct damages, up to 125 percent of the charges (if recurring, the 12 months' charges apply) for the Machine that is the subject of the claim or which otherwise gives rise to the claim.

*Applicability of suppliers and resellers (unchanged).*

The following paragraph is added at the end of this Section:

IBM's entire liability and your sole remedy, whether in contract or in tort, in respect of any default shall be limited to damages.

#### ITALY

**Limitation of Liability:** *The following replaces the second sentence in the first paragraph:*

In each such instance unless otherwise provided by mandatory law, IBM is liable for no more than:

1. (unchanged)
2. as to any other actual damage arising in all situations involving non-performance by IBM pursuant to, or in any way related to the subject matter of this Statement of Warranty, IBM's liability, will be limited to the total amount you paid for the Machine that is the subject of the claim.

*Applicability of suppliers and resellers (unchanged).*

The following replaces the second paragraph of this Section:

Unless otherwise provided by mandatory law, IBM and your reseller are not liable for any of the following: (items 1 and 2 unchanged) 3) indirect damages, even if IBM or your reseller is informed of their possibility.

#### SOUTH AFRICA, NAMIBIA, BOTSWANA, LESOTHO AND SWAZILAND

**Limitation of Liability:** *The following is added to this Section:*

IBM's entire liability to you for actual damages arising in all situations involving nonperformance by IBM in respect of the subject matter of this Statement of Warranty will be limited to the charge paid by you for the individual Machine that is the subject of your claim from IBM.

#### UNITED KINGDOM

**Limitation of Liability:** *The following replaces items 1 and 2 of the first paragraph of this Section:*

1. death or personal injury or physical damage to your real property solely caused by IBM's negligence;
2. the amount of any other actual direct damages, up to 125 percent of the charges (if recurring, the 12 months' charges apply) for the Machine that is the subject of the claim or which otherwise gives rise to the claim;

*The following item is added to this paragraph:*

3. breach of IBM's obligations implied by Section 12 of the Sale of Goods Act 1979 or Section 2 of the Supply of Goods and Services Act 1982.

*Applicability of suppliers and resellers (unchanged).*

*The following is added to the end of this Section:*

IBM's entire liability and your sole remedy, whether in contract or in tort, in respect of any default will be limited to damages.

# Environmental Labelling of Personal Computers

---

## **Congratulations!**



You have just purchased a TCO'95 approved and labelled product! Your choice has provided you with a product developed for professional use. Your purchase has also contributed to reducing the burden on the environment and to the further development of environmentally-adapted electronic products.

## **Why do we have environmentally labelled computers?**

In many countries, environmental labelling has become an established method for encouraging the adaptation of goods and services to the environment. The main problem as far as computers and other electronic equipment are concerned is that environmentally harmful substances are used both in the products and during their manufacture. Since it has not been possible so far for the majority of electronic equipment to be recycled in a satisfactory way, most of these potentially damaging substances sooner or later enter Nature.

There are also other characteristics of a computer, such as energy consumption levels, that are important from both the working and natural environment viewpoints. Since all types of conventional electricity generation have a negative effect on the environment (acidic- and climatic-influencing emissions, radioactive waste, etc.), it is vital to conserve energy. Electronic equipment in offices consumes an enormous amount of energy, since it is often routinely left running continuously.

## **What does the environmental labelling involve?**

This product meets the requirements for the TCO'95 scheme, which provides for international environmental labelling of personal computers. The labelling scheme was developed as a joint effort by the TCO (The Swedish Confederation of Professional Employees), Naturkyddsforeningen (The Swedish Society for Nature Conservation), and NUTEK (The National Board for Industrial and Technical Development in Sweden), and SEMKO AB (an international certification agency).

## **What does the environmental labelling involve?**

The requirements cover a wide range of issues: environment, ergonomics, usability, emission of electrical and magnetic fields, energy consumption and electrical and fire safety.

The environmental demands concern, among other things, restriction on the presence and use of heavy metals, brominated and chlorinated flame retardants, CFCs (freons), and chlorinated solvents. The product must be prepared for recycling, and the manufacturer is obliged to have an environmental plan, which must be adhered to in each country where the company implements its operational policy.

The energy requirements include a demand that the computer and/or display, after a certain period of inactivity, shall reduce its power consumption to a lower level, in one or more stages. The length of time to reactivate the computer shall be reasonable for the user.

Labelled products must meet strict environmental demands, for example, in respect of the reduction of electric and magnetic fields, along with physical and visual ergonomics and good usability.

The following is a brief summary of the environmental requirements met by this product. The complete environmental criteria document may be ordered from:

TCO Development Unit  
Linnegatan 14, S-11494 Stockholm, Sweden  
FAX +46-8 782 92 07  
E-mail (Internet): development@tco.se

Current information regarding TCO'95 approved and labelled products may also be obtained on the Internet using the address:  
<http://www.tco-info.com/>

TCO'95 is a co-operative project between:



Naturskydds  
föreningen



**NUTEK**

Närings- och teknikutvecklingsverket

**SEMKO**

## **Environmental requirements**

Brominated flame retardants are present in printed circuit boards, cabling, casings, and housings, and are added to delay the spread of fire. Up to 30% of the plastic in a computer casing can consist of flame-retardant substances. These are related to another group of environmental toxins, PCBs, and are suspected of giving rise to similar harm, including reproductive damage in fish-eating birds and mammals. Flame retardants have been found in human blood, and researchers fear that they can disturb fetus development.

Bio-accumulative<sup>1</sup> TCO'95 demands require that plastic components weighing more than 25 grams must not contain flame retardants with organically bound chlorine or bromine.

Lead can be found in picture tubes, display screens, solder, and capacitors. Lead damages the nervous system and in higher doses causes lead poisoning. The relevant bio-accumulative TCO'95 requirement permits the inclusion of lead, as no replacement has yet been developed.

Cadmium is present in rechargeable batteries and in the color-generating layers of certain computer displays. Cadmium damages the nervous system and is toxic in high doses. The relevant bio-accumulative TCO'95 requirement states that batteries may not contain more than 25 ppm (parts per million) of cadmium. The color-generating layers of display screens must not contain any cadmium.

Mercury is sometimes found in batteries, relays and switches. Mercury damages the nervous system and is toxic in high doses. TCO'95 requirement states that batteries may not contain more than 25 ppm (part oer million) of mercury. It also demands that no mercury is present in any of the electrical or electronics components concerned with the display unit. Mercury is, for the time being, permitted in the back light system of flat panel monitors as there today is no commercially available alternative. TCO aims on removing this exception when a mercury free alternative is available.

CFCs (freons) are sometimes used for washing printed circuit boards and in the manufacture of expanded foam for packaging. CFCs break down ozone and thereby damage the ozone layer in the atmosphere, causing increased reception on Earth of ultra-violet light with consequent increased risks of skin cancer (malignant melanoma). The relevant TCO'95 requirement: Neither CFCs nor HCFCs may be used during the manufacture of the product or its packaging.

**Shipping Package**

The packaging material can be recycled, or you can save it to return the monitor to a service center for repair or disposal.

**CFC Compounds in Distribution Packaging**

Cushioning material used for shipping finished monitors are not manufactured with nor do they contain any CFC compounds.

**Design for Disassembly/ Recycling**

These monitors have been designed for easy end-of-life disassembly and recycling. Fasteners are generally of the same type for efficient disassembly. Components made of different materials can be easily separated and plastics have been identified using international symbols to aid in recycling.

**Monitor Disposal**

————— ATTENTION —————

If you need to dispose of a monitor, ask a qualified service representative for the proper procedure. Improper disposal could result in personal injury from implosion.

—————

<sup>1</sup> Bio-accumulative means that the substance accumulates within living organisms.

# Environmental Labelling of Personal Computers

---

## **Congratulations!**



You have just purchased a TCO'99 approved and labelled product! Your choice has provided you with a product developed for professional use. Your purchase has also contributed to reducing the burden on the environment and also to the further development of environmentally adapted electronics products.

## **Why do we have environmentally labelled computers?**

In many countries, environmental labelling has become an established method for encouraging the adaptation of goods and services to the environment. The main problem, as far as computers and other electronics equipment are concerned, is that environmentally harmful substances are used both in the products and during their manufacture. Since it is not so far possible to satisfactorily recycle the majority of electronics equipment, most of these potentially damaging substances sooner or later enter nature.

There are also other characteristics of a computer, such as energy consumption levels, that are important from the viewpoints of both the work (internal) and natural (external) environments. Since all methods of electricity generation have a negative effect on the environment (e.g. acidic and climate-influencing emissions, radioactive waste), it is vital to save energy. Electronics equipment in offices is often left running continuously and thereby consumes a lot of energy.

## **What does labelling involve?**

This product meets the requirements for the TCO'99 scheme which provides for international and environmental labelling of personal computers. The labelling scheme was developed as a joint effort by the TCO (The Swedish Confederation of Professional Employees), Svenska Naturskyddsforeningen (The Swedish Society for Nature Conservation) and Statens Energimyndighet (The Swedish National Energy Administration).

Approval requirements cover a wide range of issues: environment, ergonomics, usability, emission of electric and magnetic fields, energy consumption and electrical and fire safety.

The environmental demands impose restrictions on the presence and use of heavy metals, brominated and chlorinated flame retardants, CFCs (freons) and chlorinated solvents, among other things. The product must be prepared for recycling and the manufacturer is obliged to have an environmental policy which must be adhered to in each country where the company implements its operational policy.

The energy requirements include a demand that the computer and/or display, after a certain period of inactivity, shall reduce its power consumption to a lower level in one or more stages. The length of time to reactivate the computer shall be reasonable for the user.

Labelled products must meet strict environmental demands, for example, in respect of the reduction of electric and magnetic fields, physical and visual ergonomics and good usability.

Below you will find a brief summary of the environmental requirements met by this product. The complete environmental criteria document may be ordered from:

**TCO Development**

SE-114 94 Stockholm, Sweden

Fax: +46 8 782 92 07

Email (Internet): [development@tco.se](mailto:development@tco.se)

Current information regarding TCO'99 approved and labelled products may also be obtained via the Internet, using the address:  
<http://www.tco-info.com/>

## **Environmental requirements**

### **Flame retardants**

Flame retardants are present in printed circuit boards, cables, wires, casings and housings. Their purpose is to prevent, or at least to delay the spread of fire. Up to 30% of the plastic in a computer casing can consist of flame retardant substances. Most flame retardants contain bromine or chloride, and those flame retardants are chemically related to another group of environmental toxins, PCBs. Both the flame retardants containing bromine or chloride and the PCBs are suspected of giving rise to severe health effects, including reproductive damage in fish-eating birds and mammals, due to the bio-accumulative\* processes. Flame retardants have been found in human blood and researchers fear that disturbances in foetus development may occur.

The relevant TCO'99 demand requires that plastic components weighing more than 25 grams must not contain flame retardants with organically bound bromine or chlorine. Flame retardants are allowed in the printed circuit boards since no substitutes are available.

### **Cadmium\*\***

Cadmium is present in rechargeable batteries and in the colour-generating layers of certain computer displays. Cadmium damages the nervous system and is toxic in high doses. The relevant TCO'99 requirement states that batteries, the colour-generating layers of display screens and the electrical or electronics components must not contain any cadmium.

### **Mercury\*\***

Mercury is sometimes found in batteries, relays and switches. Mercury damages the nervous system and is toxic in high doses. TCO'99 requirement states that batteries may not contain more than 25 ppm (part per million) of mercury. It also demands that no mercury is present in any of the electrical or electronics components concerned with the display unit. Mercury is, for the time being, permitted in the back light system of flat panel monitors as there today is no commercially available alternative. TCO aims on removing this exception when a mercury free alternative is available.

### **CFCs (freons)**

The relevant TCO'99 requirement states that neither CFCs nor HCFCs may be used during the manufacture and assembly of the product. CFCs (freons) are sometimes used for washing printed circuit boards. CFCs break down ozone and thereby damage the ozone layer in the stratosphere, causing increased reception on earth of ultraviolet light with e.g. increased risks of skin cancer (malignant melanoma) as a consequence.

### **Lead\*\***

Lead can be found in picture tubes, display screens, solders and capacitors. Lead damages the nervous system and in higher doses, causes lead poisoning. The relevant TCO'99 requirement permits the inclusion of lead since no replacement has yet been developed.

\* Bio-accumulative is defined as substances which accumulate within living organisms

\*\* Lead, Cadmium and Mercury are heavy metals which are Bio-accumulative.



# Compliances

---

## **Federal Communications Commission (FCC) Statement IBM T545H color monitor**

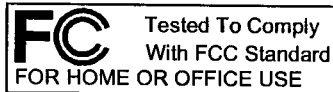

This equipment has been tested and found to comply with the limits for a Class B digital device, pursuant to Part 15 of the FCC Rules. These limits are designed to provide reasonable protection against harmful interference in a residential installation. This equipment generates, uses, and can radiate radio frequency energy and, if not installed and used in accordance with the instructions, may cause harmful interference to radio communications. However, there is no guarantee that interference will not occur in a particular installation. If this equipment does cause harmful interference to radio or television reception, which can be determined by turning the equipment off and on, the user is encouraged to try to correct the interference by one or more of the following measures:

- Reorient or relocate the receiving antenna.
- Increase the separation between the equipment and receiver.
- Connect the equipment into an outlet on a circuit different from that to which the receiver is connected.
- Consult an IBM authorized dealer or service representative for help.

Properly shielded and grounded cables and connectors must be used in order to meet FCC emission limits. Proper cables and connectors are available from IBM authorized dealers. IBM is not responsible for any radio or television interference caused by using other than recommended cables and connectors or by unauthorized changes or modifications to this equipment. Unauthorized changes or modifications could void the user's authority to operate the equipment.

### **Power Cords**

For your safety, IBM provides a power cord with a grounded attachment plug to use with this IBM product. To avoid electrical shock, always use the power cord and plug with a properly grounded power outlet.

IBM power cords used in the United States and Canada are listed by the Underwriter's Laboratories (UL) and certified by the Canadian Standards Association (CSA).

For units intended to be operated at 115 volts: Use a UL-listed and CSA-certified cord set consisting of a minimum 18 AWG, Type SVT or SJT, three-conductor cord, a maximum of 15 feet in length and a parallel blade, grounding-type attachment plug rated 15 amperes, 125 volts.

For units intended to be operated at 230 volts (U.S. use): Use a UL-listed and CSA-certified cord set consisting of a minimum 18 AWG, type SVT or SJT, three-conductor cord, a maximum of 15 feet in length and a tandem blade, grounding-type attachment plug rated 15 amperes, 250 volts.

For units intended to be operated at 230 volts (outside the U.S.): Use a cord set with a grounding-type attachment plug. The cord set should have the appropriate safety approvals for the country in which the equipment will be installed.

IBM power cords for a specific country or region are usually available only in that country or region.

IBM Fig. # (Plug Stnd.)	IBM P/N (1.8M)	Regions
4 (NEMA 5-15P) 125V	6952301	US, Canada, Mexico, Brazil, Costa Rica, Peru, Colombia, Ecuador, Venezuela, Bolivia, Panama, El Salvador, Honduras, Nicaragua, Dominican Republic, Guatemala, Taiwan, Saudi Arabia, Thailand, Phillipines, Japan
5 (NEMA 6-15P) 250V	1838576	US, Canada, Mexico, Brazil, Costa Rica, Peru, Colombia, Ecuador, Venezuela, Bolivia, Panama, El Salvador, Honduras, Nicaragua, Dominican Republic, Guatemala, Taiwan, Saudi Arabia, Thailand, Phillipines, Japan
6 (AS/NZS C112)	13F9939	Australia, New Zealand
18 (CEE 7 - VII)	13F9978	France, Germany, Sweden, Norway, Austria, Netherlands, Finland, Belgium, Bosnia, Croatia, Egypt, Greece, Hungary, Poland, Portugal, Romania, Slovenia, Spain, Sweden, Turkey, Iceland, Estonia, Latvia, Lithuania, Luxembourg, Andorra, Guadeloupe, French Guyana, Martinique, Monaco, New Caledonia, Madagascar, Mauritius, Greece, Turkey, Portugal, Albania, Armenia, Azerbaidjan, Belarus, Bosnia, Croatia, Czech Republic, Georgia, Hungary, Kazakhstan, Kyrgistan, Macedonia, Moldavia, Poland, Romania, Serbia, Slovakia, Slovenia, Tajikistan, Turkmenistan, Ukraine, Uzbekistan, Russia, Lebanon, Syria, Egypt, Iran, Algeria, Benin, Cape Verde, Burkina Faso, Cameroon, Central African Republic, Chad, Congo (Republic of), Congo (Democratic Republic of), Djibouti, Equatorial Guinea, Gabon, Guinea, Guinea Bissau, Ivory Coast, Mali, Mauritania, Morocco, Niger, Senegal, Togo, Tunisia, Angola, Burundi, Ethiopia, Mozambique, Rwanda, Somalia, Sao Tome, Eritrea, Mayotte, Comoros, Reunion, French Polynesia, Vanuatu, Wallis and Futuna, Korea, Vietnam, Indonesia

23 (BS 1363/A)	14F0032	UK, United Arab Emirate (Dubai), China (Hong Kong S.A.R.), Singapore, Malaysia, Ireland, Cyprus, Bahrain, Jordan, Kuwait, Oman, Qatar, Yemen, Gambia, Malta, Botswana, Seychelles, Nigeria, Ghana, Kenya, Liberia, Malawi, Sierra Leone, Sudan, Tanzania, Zambia, Zimbabwe
19 (DK2-5a)	13F9996	Denmark
25 (CEI 23-16)	14F0068	Italy, Chile
2 (IRSM 2073)	36L8879	Argentina, Uruguay, Paraguay,,
62 (GB 2099.1)	02K0545	China
32 (SI 32)	14F0086	Israel
22 (SABS 164)	14F0014	South Africa, India, Sri Lanka, Pakistan, Uganda, Lesotho, Namibia, Swaziland
24 (1011-S24507)	14F0050	Switzerland, Lichtenstein



**Industry Canada Class B emission compliance statement**

This Class B digital apparatus complies with Canadian ICES-003.

Cet appareil numérique de la classe B respecte toutes les exigences du Règlement sur le matériel brouilleur du Canada.

**Avis de conformité à la réglementation d'Industrie Canada**

Cet appareil numérique de classe B est conforme à la norme NMB-003 du Canada.

	As an ENERGY STAR Partner, IBM Corporation has determined that this product meets the ENERGY STAR guidelines for energy efficiency.
	Models 6656-HG2 comply with TCO '95 guidelines.
	Models 6656-HW2 comply with TCO '99 guidelines.

**Congratulations!**

You have just purchased a TCO99 approved and labeled product! Your choice has provided you with a product developed for professional use. Your purchase has also contributed to reducing the burden on the environment and also to the further development of environmentally adapted electronics products.

**Why do we have environmentally labeled computers?**

In many countries, environmental labeling has become an established method for encouraging the adaptation of goods and services to the environment. With the growing manufacture and usage of electronic equipment throughout the world, there is a recognized concern for the materials and substances used by electronic products with regards to their eventual recycling and disposal. By proper selection of these materials and substances, the impact on the environment can be minimized. There are also other characteristics of a computer, such as energy consumption levels, that are important from the viewpoints of both the work (internal) and natural (external) environments. Electronic equipment in offices is often left running continuously, resulting in unnecessary consumption of large amounts of energy and additional power generation. From the standpoint of carbon emissions alone, it is vital to save energy.

**What does labeling involve?**

This product meets the requirements for the TCO99 scheme which provides for international and environmental labeling of personal computers. The labeling scheme was developed as a joint effort by the TCO (The Swedish Confederation of Professional Employees), Svenska Naturskyddsforeningen (The Swedish Society for Nature Conservation) and Statens Energimyndighet (The Swedish National Energy Administration). Approval requirements cover a wide range of issues: environment, ergonomics, emission of electric and magnetic fields, energy consumption and electrical safety. Environmental criteria impose restrictions on the presence and use of heavy metals, brominated and chlorinated flame retardants, CFCs (freons) and chlorinated solvents, and other materials.

The product must be prepared for recycling and the manufacturer is obliged to have an environmental policy which must be adhered to in each country where the company implements its operational policy.

Energy requirements include a demand that the computer and/or display, after a certain period of inactivity, shall reduce its power consumption to a lower level in one or more stages. The length of time to reactivate the computer shall be reasonable for the user.

Labeled products must meet strict environmental demands, for example, in respect of the reduction of electric and magnetic fields as well as physical and visual ergonomics.

**Congratulations!**

You have just purchased a TCO95 approved and labeled product! Your choice has provided you with a product developed for professional use. Your purchase has also contributed to reducing the burden on the environment and also to the further development of environmentally adapted electronics products.

**Why do we have environmentally labeled computers?**

In many countries, environmental labeling has become an established method for encouraging the adaptation of goods and services to the environment. With the growing manufacture and usage of electronic equipment throughout the world, there is a recognized concern for the materials and substances used by electronic

products with regards to their eventual recycling and disposal. By proper selection of these materials and substances, the impact on the environment can be minimized. There are also other characteristics of a computer, such as energy consumption levels, that are important from the viewpoints of both the work (internal) and natural (external) environments. Electronic equipment in offices is often left running continuously, resulting in unnecessary consumption of large amounts of energy and additional power generation. From the standpoint of carbon emissions alone, it is vital to save energy.

### **What does labeling involve?**

This product meets the requirements for the TCO99 scheme which provides for international and environmental labeling of personal computers. The labeling scheme was developed as a joint effort by the TCO (The Swedish Confederation of Professional Employees), Svenska Naturskyddsforeningen (The Swedish Society for Nature Conservation) and Statens Energimyndighet (The Swedish National Energy Administration) Approval requirements cover a wide range of issues: environment, ergonomics, emission of electric and magnetic fields, energy consumption and electrical safety. Environmental criteria impose restrictions on the presence and use of heavy metals, brominated and chlorinated flame retardants, CFCs (freons) and chlorinated solvents, and other materials. The product must be prepared for recycling and the manufacturer is obliged to have an environmental policy which must be adhered to in each country where the company implements its operational policy. Energy requirements include a demand that the computer and/or display, after a certain period of inactivity, shall reduce its power consumption to a lower level in one or more stages. The length of time to reactivate the computer shall be reasonable for the user. Labeled products must meet strict environmental demands, for example, in respect of the reduction of electric and magnetic fields as well as physical and visual ergonomics.

### **MPRII**

This product complies with Swedish National Council for Metrology (MPR) standards issued in December 1999 (MPRII) for very low frequency (VLF) and Extremely low frequency (ELF) emissions.

### **Hinweise**

Gemäß der Amtsblätter des BMPT Nm. 61Ú1991 und 6Ú1992 wird der Betreiber darauf aufmerksam gemacht, daß die von ihm mit diesem Gerät zusammengestellte Anlage auch den technischen Bestimmungen dieser Amtsblätter genügen muß.

Aus ergonomischen Gründen wird empfohlen, die Grundfarbe Blau nicht auf dunklem Untergrund zu verwenden (schlechte Erkennbarkeit, Augenbelastung bei zu geringem Zeichenkontrast).

Aus ergonomischen Gründen sollten nur Darstellungen auf dunklem Hintergrund bei Vertikalfrequenzen ab 60 Hz (ohne Zeilensprung) benutzt werden.

Die Konvergenz des Bildes kann sich auf Grund des Magnetfeldes am Ort der Aufstellung aus der Korrekten Grundeinstellung verändern. Zur Korrektur empfiehlt es sich deshalb, die Regler an der Frontseite für H STAT und V STAT so einzustellen, daß die getrennt sichtbaren Farblinien für Rot, Grün und Blau bei z.B. der Darstellung eines Buchstabens zur Deckung (Konvergenz) gelangen. Siehe hierzu auch die Erklärungen zu H STAT und V STAT.

### **European Union (EU) Statement**

This product is in conformity with the protection requirements of the EU Council Directive 89/366/ECC on the approximation of the laws of the Member States relating to electromagnetic compatibility.

IBM can not accept responsibility for any failure to satisfy the protection requirements resulting from a non-recommended modification of the product, including the fitting of non-IBM option cards.

This product has been tested and found to comply with the limits for Class B Information Technology Equipment according to CISPR 22 Ú European Standard EN 55022. The limits for Class B equipment were derived for typical residential environments to provide reasonable protection against interference with licensed communication devices.

Properly shielded and grounded cables and connectors must be used in order to reduce the potential for causing interference to radio and TV communications and to other electrical or electronic equipment. Such cables and connectors are available from IBM authorised dealers.

In accordance with EN 50082-1 1992, Performance Criterion A., it should be noted that in the presence of certain electromagnetic fields, some screen jitter may be observed.

### **Spécifications de la CEE**

Ce produit est conforme aux exigences de protection de la directive 89/ 336/ EEC du Conseil de l'UE sur le rapprochement des lois des États membres en matière de compatibilité électromagnétique.

IBM ne peut accepter aucune responsabilité pour le manquement aux exigences de protection résultant d'une modification non recommandée du produit, y compris l'installation de cartes autres que les cartes IBM.

Ce produit a été testé et il satisfait les conditions de l'équipement informatique de Classe B en vertu de CISPR22 / Standard européen EN 55022. Les conditions pour l'équipement de Classe B ont été définies en fonction d'un contexte résidentiel ordinaire afin de fournir une protection raisonnable contre l'interférence d'appareils de communication autorisés.

Des câbles blindés et correctement reliés à la terre doivent être utilisés pour réduire les risques d'interférence avec des communications radio et télévisées, ainsi qu'avec des équipements électriques ou électroniques.

Ces câbles et connecteurs sont disponibles auprès de vos revendeurs IBM agréés.

Conformément à la norme EN 50082- 1 1992 (Critère de Performance A), l'utilisateur doit être conscient du fait qu'en présence de certains champs électromagnétiques, l'image peut être instable.

### **Erklärung für die Europäische Union (EU)**

Zulassungsbcheinigung laut dem Deutschen Gesetz über die elektromagnetische Vertraglichkeit von Geraten (EMVG) vom 30. August 1995 (bzw. der EMC EG Richtlinie 89/336):

Dieses Gerat ist berechtigt in Ubereinstimmung mit dem Deutschen EMVG das EG-Konformitatszeichen - CE - zu fuhren.

Verantwortlich fur die Konformitatserklarung nach Paragraph 5 des EMVG ist die:  
IBM Deutschland Informationssysteme GmbH, 70548 Stuttgart.

Informationen in Hinsicht EMVG Paragraph 3 Abs. (2) 2:

Das Gerat erfult die Schutzanforderungen nach EN 50082-1 und EN 55022 Klasse B.

EN 50082-1 Hinweis:

Wir dieses Gerat in einer industriellen Umgebung betrieben (wie in EN 50082-2 festgelegt), dann kann es dabei eventuell gestort werden. In solch einem Fall ist der Abstand bzw. die Abschirmung zu der industriellen Storquelle zu vergroern.

Anmerkung:

Um die Einhaltung des EMVG sicherzustellen sind die Gerate, wie in den IBM Handbuchern angegeben, zu installieren und zu betreiben.

#### **Declaración de la Unión Europea (UE)**

Este producto satisface los requisitos de protección del Consejo de la UE, Directiva 89/ 336/ CEE en lo que a la legislación de los Estados Miembros sobre compatibilidad electromagnética se refiere.

IBM no puede aceptar responsabilidad alguna si este producto deja de satisfacer dichos requisitos de protección como resultado de una modificación no recomendada del producto, incluyendo el ajuste de tarjetas de opción que no sean IBM.

Este producto ha sido probado y satisface los límites para Equipos Informáticos Clase B de conformidad con el Estándar CISPR22 y el Estándar Europeo EN 55022. Los límites para los equipos de Clase B se han establecido para entornos residenciales típicos a fin de proporcionar una protección razonable contra las interferencias con dispositivos de comunicación licenciados.

Se deben utilizar conectores y cables debidamente protegidos y conectados a tierra a fin de reducir las posibilidades de que se produzcan interferencias con comunicaciones por radio o televisión y otros equipos eléctricos o electrónicos. Este tipo de cables y conectores pueden adquirirse en concesionarios autorizados de IBM.

De acuerdo con la norma EN 50082- 1 1992, Performance Criterion A, habría que destacar que en presencia de determinados campos electromagnéticos, podría observarse una marcada inestabilidad e la imagen.

#### **Dichiarazione di conformità dell'Unione Europea (EU)**

Questo prodotto è conforme alle normative di protezione ai sensi della Direttiva del Consiglio dell'Unione Europea 89/ 336/ CEE sull'armonizzazione legislativa degli stati membri in materia di compatibilità elettromagnetica.

IBM non accetta responsabilità alcuna per la mancata conformità alle normative di protezione dovuta a modifiche non consigliate al prodotto, compresa l'installazione di schede e componenti di marca diversa da IBM.

Le prove effettuate sul presente prodotto hanno accertato che esso rientra nei limiti stabiliti per le apparecchiature di informatica Classe B ai sensi del CISPR 22 / Norma Europea EN 55022. I limiti delle apparecchiature della Classe B sono stati stabiliti al fine di fornire ragionevole protezione da interferenze mediante dispositivi di comunicazione in concessione in ambienti residenziali tipici.

Utilizzare cavi e connettori collegati a terra per ridurre il rischio potenziale di interferenza delle comunicazioni radiotelevisive e di altri apparecchi elettrici o elettronici. I cavi sono disponibili presso i rivenditori IBM.

In accordo con quanto previsto nel documento EN 50082- 1 1992, Performance Criterion A, è importante sottolineare che in presenza di determinati campi elettromagnetici è possibile che si verifichi un certo tremolio delle immagini.

#### **Europeiska unionen (EU)**

Denna produkt har testats och följer gränsvärdena för Klass B Information Technology Equipment enligt CISPR 22 och Europeisk standard EN 55022. Gränsvärden för Klass B-utstrålning utgår från vanliga bostadsområden för att ge ett rimligt skydd mot störningar i kommunikationsenheter.

Korrekt avskärmade och jordade kablar och kontakter måste användas för att minska risken för störningar i radio- och TV-kommunikationer och annan elektrisk utrustning. Sådana kablar och kontakter finns tillgängliga hos auktoriserade IBM-återförsäljare.

I enlighet med EN 50082-1 1992, Performance Criterion A påpekas följande: I närheten av en del elektromagnetiska fält kan vissa bildstörningar uppstå på skärmen.

#### **Deutsche EMV-Direktive (electromagnetische Verträglichkeit)**

Dieses Gerät ist berechtigt in Übereinstimmung mit dem deutschen EMVG vom 9.Nov.92 das EG-Konformitätszeichen zu führen.

Der Aussteller der Konformitätserklärung ist die IBM UK, Greenock.

Dieses Gerät erfüllt die Bedingungen der EN 55022 Klasse B.

이 기기는 가정용으로 전자파 적합등록을 기기로서  
주거지역에서는 물론 모든 지역에서 사용 할 수 있습니다



## VCCI Class B Notice (Japan Only)

This equipment complies with the limits for a Class B digital device (devices used in or adjacent to a residential environment) and conforms to the standards for information technology equipment that are set by the Voluntary Control Council for Interference for preventing radio frequency interference in residential areas.

この装置は、情報処理装置等電波障害自主規制協議会（VCCI）の基準に基づきクラスB情報技術装置です。この装置は、家庭環境で使用することを目的としていますが、この装置がラジオやテレビジョン受信機に近接して使用されると、受信障害を引き起こすことがあります。取扱説明書に従って正しい取り扱いをして下さい。

Japanese statement of compliance for products less than or equal to 20 A per phase:

高調波ガイドライン適合品

## Mercury Statements

The fluorescent lamp in the liquid crystal display contains mercury. Dispose of it as required by local ordinances and regulations.

# Service Information

---

The following parts are for use by IBM service, or IBM authorised dealers, to support the customer warranty. Parts are for service use only.

P/NO	Description	Video	Color	MTM
22P7473	FRU Monitor	Hybrid	Stealth Black	6656-HG2
22P7474	FRU Monitor	Hybrid	Pearl White	6656-HW2
22P7475	FRU Video Interface Cable	Analog	Black	
22P7476	FRU Video Interface Cable	Digital	Black	
22P7477	FRU Stand	Hybrid	Stealth Black	
22P7478	FRU Stand	Hybrid	Pearl White	
22P7479	FRU Power Supply	Hybrid		