

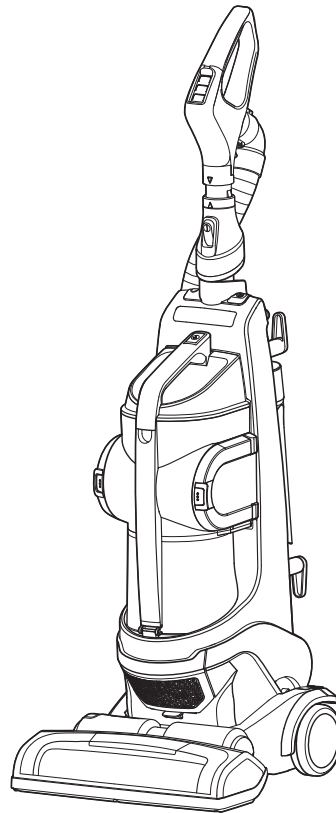

# Vacuum Cleaner Owner's Manual

**MODEL: LuV300**



**Read and follow all safety and operating  
instructions before first use of this product.**

P/No.: MFL62862401

## TABLE OF CONTENTS

<b>LG Vacuum Cleaner Warranty</b> .....	<b>3</b>
<b>Before Using Your New Vacuum Cleaner</b> .....	<b>4</b>
<b>Important Safety Instructions</b> .....	<b>4~5</b>
<b>Parts and Features</b> .....	<b>6</b>
<b>Assembly</b> .....	<b>7~9</b>
Unpacking the Vacuum Cleaner .....	7
Assembly Parts .....	7
Wand & Hose assembly .....	8
Attaching the Hose .....	8
Accessory Storage .....	9
Cord storage .....	9
<b>Operation</b> .....	<b>10~15</b>
Control Operation .....	10
Body Release Operation .....	10
Adjusting the Pile Height .....	11
Attachments .....	12
Attachment Use Chart .....	12
Using the Wand or Wand Handle .....	13
Installing Attachments .....	14
Tips and Tricks .....	14
Using the Pet hair tool .....	14
Stairways and Landings .....	14
Agitator Motor Overload Protection .....	15
Thermal Overload Protection .....	15
<b>Care &amp; Cleaning</b> .....	<b>16~22</b>
Storing the Vacuum Cleaner .....	16
Dust Tank Components .....	16
Emptying the Dust Tank .....	17
Cleaning the Dust Tank .....	17
Cleaning the Foam Pre-Filter .....	18
Replacing the HEPA Filter .....	18
Pet Hair tool .....	19
Agitator Maintenance .....	19
Replacing the Agitator Belt .....	20
Removing Clogs .....	21
Cleaning the Exterior of the Vacuum Cleaner .....	22
<b>Troubleshooting</b> .....	<b>23~24</b>

## LG VACUUM CLEANER WARRANTY

### FIVE YEAR LIMITED WARRANTY

When assembled, operated, and maintained according to all instructions supplied with this product, if the appliance fails due to a defect in material or workmanship within one year from the date of purchase, return it to any LGE service center.

If this appliance is used for other than personal household use this warranty applies for only 90 days from the date of purchase.

**This warranty covers only defects in material and workmanship.**

**LGE will NOT pay for:**

1. Expendable items that can wear out, including but not limited to filters, belts, light bulbs, and bags.
2. A service technician to instruct the user in correct product assembly, operation, or maintenance.
3. A service technician to clean or maintain this product.
4. Damage to or failure of this product if it is not assembled, operated, or maintained according to all instructions supplied with this product.
5. Damage to or failure of this product resulting from accident, abuse, misuse, or use for other than its intended purpose.
6. Damage to or failure of this product caused by the use of detergents, cleaners, chemicals, or utensils other than those recommended in all instructions supplied with this product.
7. Damage to or failure of parts or systems resulting from unauthorized modifications made to this product.

**Disclaimer of implied warranties; limitation of remedies:**

Customer's sole and exclusive remedy under this limited warranty shall be product repair as provided herein. Implied warranties of merchantability or fitness for a particular purpose are limited to one year or the shortest period allowed by law. Sears shall not be liable for incidental or consequential damages. Some states and provinces do not allow the exclusion or limitation of incidental or consequential damages, or limitations on the duration of implied warranties of merchantability or fitness, so these exclusions or limitations may not apply to you.

This warranty applies only while this appliance is used in the United States or Canada.

This warranty gives you specific legal rights, and you may also have other rights which vary from state to state or province to province.

## BEFORE USING YOUR NEW VACUUM CLEANER

Please read this guide. It will help you assemble and operate your new LGE vacuum cleaner in the safest and most effective way.

For more information about the care and operation, call your nearest LGE service center. You will need the complete model and serial numbers when requesting information.

Your vacuum cleaner's model and serial numbers are located on the Model and Serial Number Plate. Use the space below to record the model number and serial number of your new LGE vacuum cleaner.

Model No.: \_\_\_\_\_

Serial No.: \_\_\_\_\_

Date of Purchase: \_\_\_\_\_

Keep this Use and Care Guide and your sales receipt in a safe place here future reference.

**The number to call for service location : 800-243-0000**

## IMPORTANT SAFETY INSTRUCTIONS

The Federal Communications Commission Radio Frequency Interference Statement includes the following warning:

NOTE: This equipment has been tested and found to comply with the limits for a Class B digital device, pursuant to Part 15 of the FCC Rules. These limits are designed to provide reasonable protection against harmful interference in a residential installation.

This equipment generates, uses, and can radiate radio frequency energy and, if not installed and used in accordance with the instructions, may cause harmful interference to radio communications.

However, there is no guarantee that interference will not occur in a particular installation.

If this equipment does cause harmful interference to radio or television reception, which can be determined by turning the equipment off and on, the user is encouraged to try to correct the interference by one or more of the following measures:

- Reorient or relocate the receiving antenna.
- Increase the separation between the equipment and receiver.
- Connect the equipment into an outlet on a circuit different from that to which the receiver is connected.
- Consult the dealer or an experienced radio/TV technician for help.

This device complies with part 15 of the FCC Rules.

Operation is subject to the following two conditions:(1)This device may not cause harmful interference, and (2) this device must accept any interference received, including interference that may cause undesired operation.



### CAUTION

**Any changes or modifications in construction of this device which are not expressly approved by the party responsible for compliance could void the user's authority to operate the equipment.**

#### IMPORTANT NOTE:

##### FCC Radiation Exposure Statement

This equipment complies with FCC radiation exposure limits set forth an uncontrolled environment.

This equipment should be installed and operated with minimum distance 20cm between the radiator and your body. This transmitter must not be co-located or operating in conjunction with any other antenna or transmitter.

## IMPORTANT SAFETY INSTRUCTIONS



### WARNING

**Your safety is important to us. To reduce the risk of fire, electric shock, injury to persons, or damage when using your vacuum cleaner, follow basic safety precautions including the following:**

- READ THIS MANUAL BEFORE ASSEMBLING OR USING YOUR VACUUM CLEANER.
- Use your vacuum cleaner only as described in this manual. Use only with supplied attachments.
- To reduce the risk of electric shock, do NOT use outdoors or on wet surfaces.
- Disconnect electrical supply before servicing or cleaning out brush area. Failure to do so could result in electric shock or brush suddenly starting.
- Always turn vacuum cleaner off before connecting or disconnecting the hose.
- Always turn vacuum cleaner off before unplugging.
- Do not unplug by pulling on cord. To unplug, grasp the plug, not the cord.
- Do not use with damaged cord or plug.
  - If the vacuum cleaner is not working properly due to the unit being dropped, damaged, left outdoors or submerged in water do not use.
- Do not pull or carry the vacuum using the cord. Do not allow the cord to be caught underneath the vacuum while using. Keep the cord away from heated surfaces.
- Do not leave the vacuum plugged in when you are not using it.
- Do not allow to be used as a toy. Close attention is necessary when used by or near children.
- Do not operate or unplug the vacuum with wet hands.
- Do not put any object into openings.
- Do not use with any opening blocked; keep free of dust, lint, hair, and anything that may reduce air flow.
- Keep hair, loose clothing, fingers, and all parts of body away from openings and moving parts.
- Do not use the vacuum cleaner without the dust tank and filters properly placed.
- Always clean the dust tank and filters after using the vacuum on carpet cleaners, fresheners or fine dirt such as drywall dust. These products clog the filter, reduce airflow, and can cause damage to the vacuum cleaner. Failure to clean the dust tank could result in permanent damage to the vacuum cleaner.
- Do not use the vacuum cleaner to pick up sharp hard objects, such as small toys, thumbtacks, paper clips and other similar objects. These may damage the vacuum cleaner or other internal parts.
- Do not pick up anything that is burning or smoking, such as cigarettes, matches, or hot ashes.
- Do not use vacuum cleaner to pick up flammable or combustible liquids (gasoline, cleaning fluids, perfumes, etc.), or use in areas where they may be present. The fumes from these substances can create a fire hazard or explosion.
- Use extra care when cleaning stairs. Do not set the vacuum on chairs or tables, always keep the unit on the floor.
- You are responsible for making sure that your vacuum cleaner is not used by anyone unable to operate it properly.
- WARNING:** The cords, wires, and/or cables supplied with this product contain chemicals, including lead or lead compounds, known to the state of California to cause cancer and birth defects or other reproductive harm. Wash hands after using.

Proper assembly and safe use of your vacuum cleaner are your responsibilities.

Your vacuum cleaner is intended only for household use. Read this Use and Care Guide carefully for important use and safety information. This guide contains safety statements under **WARNING** and **CAUTION** symbols. Please pay special attention to these boxes and follow any instructions given.

**WARNING** statements alert you to such hazards as fire, electric shock, burns, and serious personal injury.

**CAUTION** statements alert you to such hazards as moderate personal injury and/or property damage.

– SAVE THESE INSTRUCTIONS –

# PARTS AND FEATURES

**It is important to know your vacuum cleaner's parts and features to assure its proper and safe use. Review these before using your vacuum cleaner.**

### Common Replacement Parts

HEPA Filter		ADQ72913001
Foam Pre Filter (ADV72987201)	Filter Frame	MDQ61918301
	Foam Filter	MDJ61980601
Agitator Belt		MAS61842501

To order these parts call  
1-800-243-0000.

### Accessory Tools

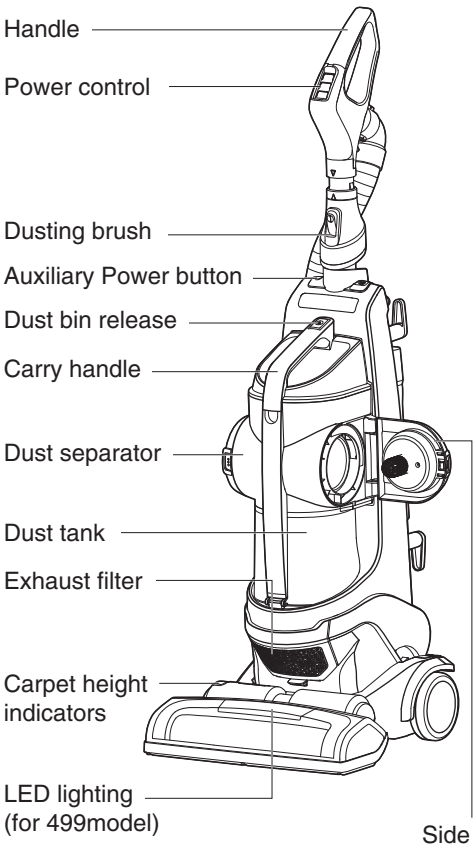
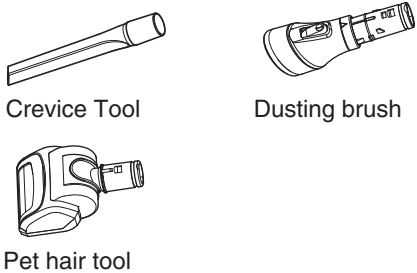

Side door

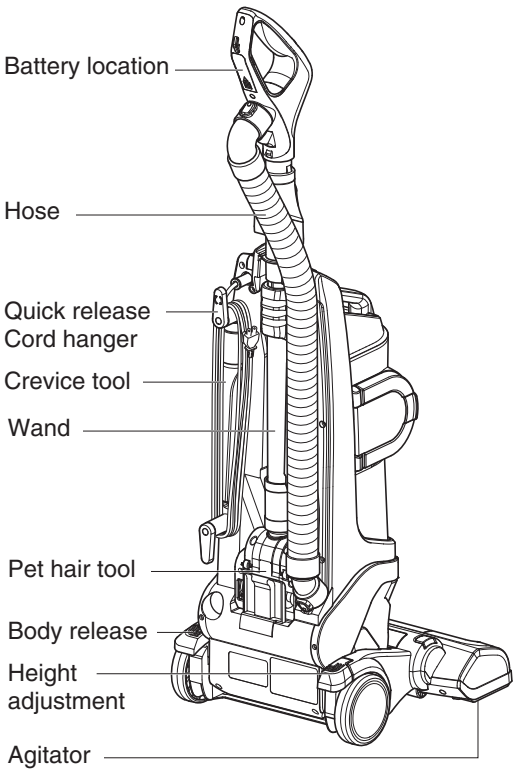

## ASSEMBLY

To reduce the risk of shipping damage, your vacuum cleaner is shipped partially unassembled.

### Unpacking the Vacuum Cleaner

Carefully unpack the vacuum cleaner and make sure that you have all parts before discarding of any packaging. Remove any tape, cardboard inserts, and protective film before assembly.

Items that are packed in the box:

1. Vacuum Cleaner Body
2. Crevice Tool (all ready installed)
3. Handle
4. Two "AAA" Batteries - See page 8 for installation instructions
5. Dusting Brush
6. Adjustable Wand
7. Hose
8. Pet Hair Tool
9. Additional Foam Filter

### Assembly Parts

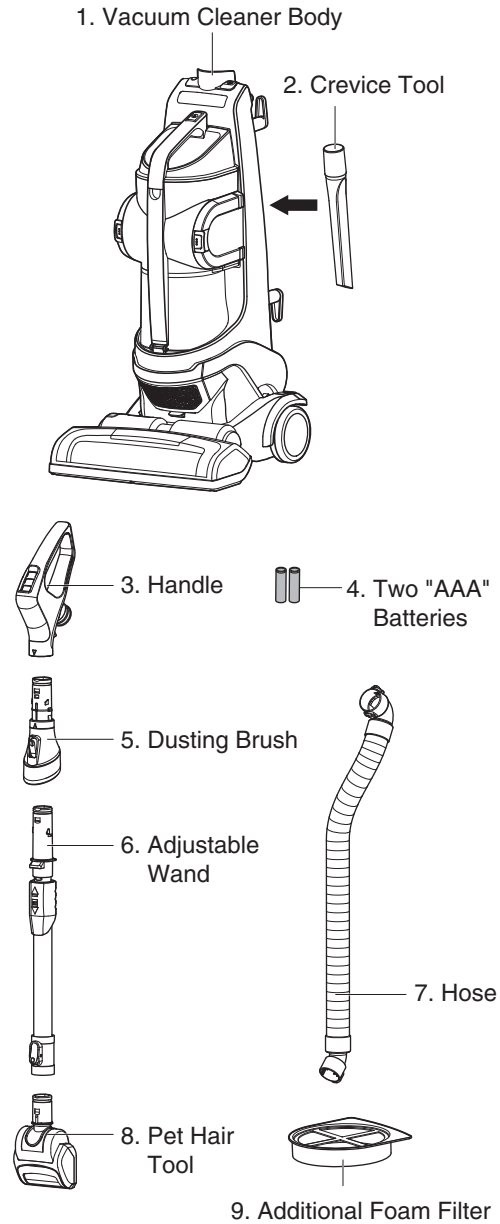

## Wand & Hose assembly

1. Remove Cover by sliding up.

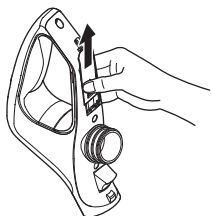

2. Insert the 2 "AAA" batteries.

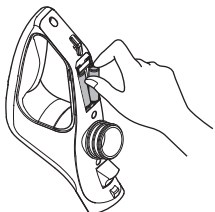

3. Insert the Pet hair tool into the bottom of the wand.

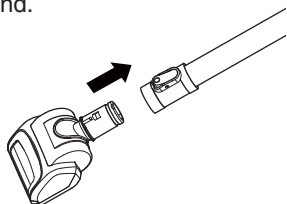

4. Insert the dusting brush onto the other side of the wand.

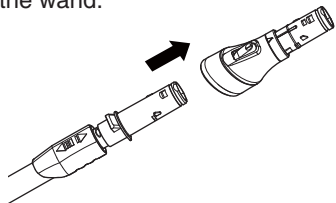

5. Insert the handle onto the open end of the dusting brush.

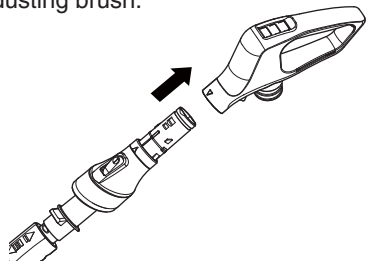

## Attaching the Hose

1. Attach the top side of the hose to the handle. The top side of the hose can be recognized because it has 2 clips for releasing.

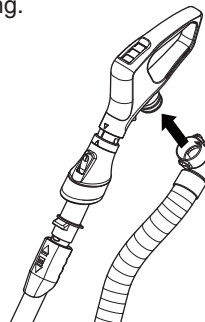

2. Insert the bottom side of the hose to the main body. The bottom side of the hose can be recognized because it only has 1 clip to release.

**Note:** When inserting the bottom of the hose to the main body the clip should be on the side closest to the floor and centered.

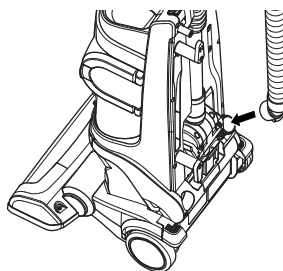

3. Insert the wand with all accessories attached into the main body of the vacuum cleaner.

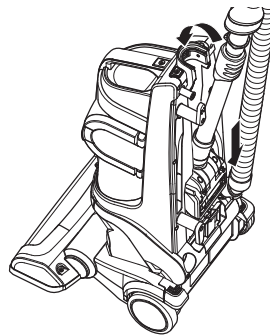





## WARNING

**Personal Injury and Product Damage Hazard!**

**DO NOT use outlets above counters. Damage to items in the surrounding area could occur.**

### Accessory Storage

Your vacuum cleaner features convenient on-board storage for the crevice tool.

- Put the wand & hose assembly on the back of body, and then push the wand & hose assembly to the body.

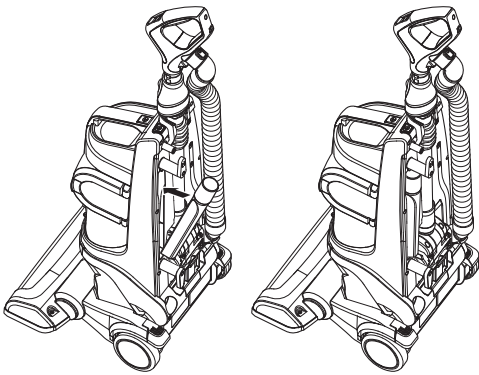

### Cord Storage

**To store the cord:**

1. Make sure the cord hanger is in the UP position.
2. Wrap the cord around the cord hanger and hook, then clip the plug onto the cord.

**NOTE:** To reduce the risk of electric shock, this vacuum cleaner has a polarized plug; one blade is wider than the other. This plug will fit in a polarized outlet only one way.

**To release the cord:**

1. Rotate the upper cord holder to the DOWN position.
2. Unclip the plug and extend the cord.

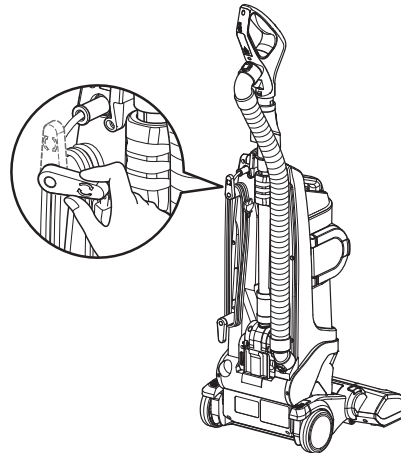

## OPERATION

### Control Operation

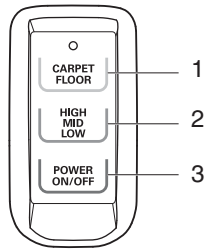

- 1. Carpet / Floor:** To toggle between the agitator being on or off.  
**Note:** If the vacuum is in the upright position the agitator will not run even if the vacuum power is on.
- 2. High Med Low:** To select the proper suction of the vacuum such as High, Medium or Low.
- 3. Power On/Off :** To turn the vacuum on and off.

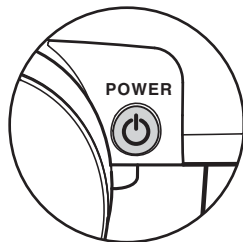

This power button is only needed when the batteries in the handle need to be changed. When pressing the handle controls a blue light at the top of control indicates the batteries are OK, if there is not blue light when pressing the batteries should be replaced. If you need to still vacuum and replacement batteries are not readily available the power button on the main body can be used to run the vacuum until the batteries are changed.

### Body Release Operation

- To begin vacuuming press the pedal on the left side of the vacuum and pull down.

**NOTE:** When the vacuum is in the upright position the agitator will not run.

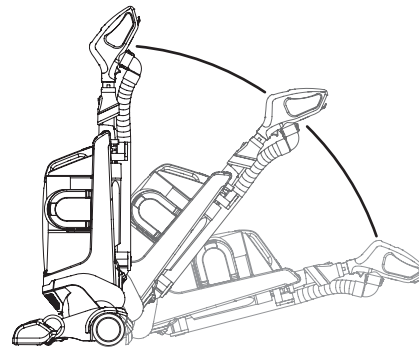
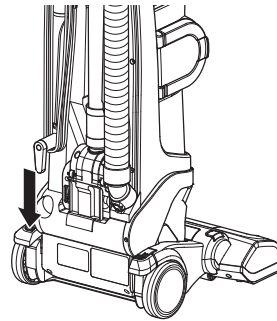

## Adjusting the Pile Height

### To adjust the pile height:

When it is necessary to raise and lower the front of the cleaner for various carpet pile heights, press the right foot pedal to adjust the pile height. Each press will raise the agitator one notch.

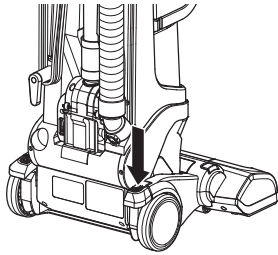

### Suggested pile height settings:

You may need to raise the height to make some jobs easier, such as vacuuming scatter rugs and longer pile rugs.

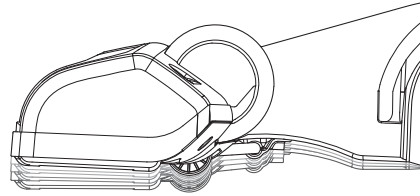

### Recommended settings:

- H** shag carpet, long pile, scatter rugs
- M** medium to long pile
- ML** short to medium pile
- L** very low pile, bare floors

**Attention:** Special care is required when vacuuming certain types of carpet or flooring. Always check the carpet or floor covering manufacturer's recommended cleaning instructions before vacuuming.



## WARNING

### Personal Injury Hazard

Do not set the vacuum on the stairs, always keep the unit on the floor.

## Attachments

### Pet Hair Tool

This air-turbine powered brush is great for stairs and vehicle interiors, as well as removing pet hair, lint, etc. from fabrics and carpets.



Do NOT use on pets.

### Dusting brush

Use the Dusting brush in place for cleaning furniture, walls, etc.

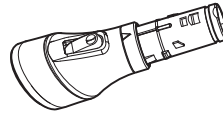

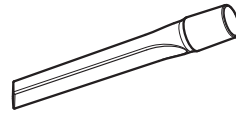

### Crevice Tool

The crevice tool can be used for tight corners, between cushion and various other hard to reach places.

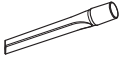

## Attachment Use Chart

ATTACHMENT	CLEANING AREA					
	Furniture and Hard Surfaces*	Between Cushions Upholstered Surfaces*	Drapes* (lower power level)	Stairs	Carpeted Floors/ Rugs	Walls
Pet Hair Tool 		●		●		
Dusting brush 	●	●	●		●	●
Crevice Tool 		●				

\* Always make sure attachments are clean before using on fabrics.

## Using the Wand or Wand Handle



### CAUTION

Never pull the vacuum cleaner by the hose.

If using any accessory on the end of the handle the entire wand must be removed from the body base.

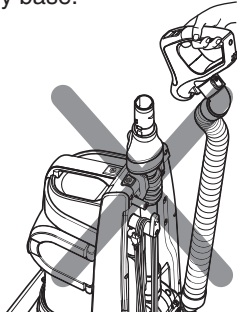

#### Release the wand and handle:

1. Make sure the vacuum cleaner is locked in the upright position and on a flat, stable surface.
2. Press the wand release button on the body and tilt the wand handle.
3. Lift the wand out and up.

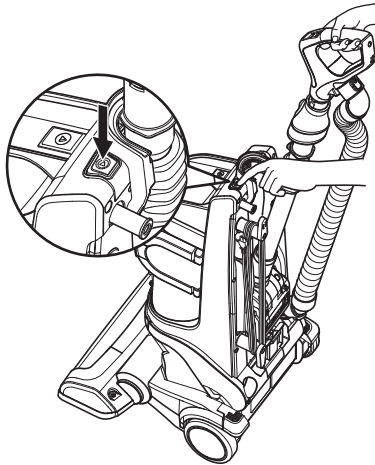

4. To use the handle only, press the release button on the bottom of the handle and pull the wand straight out of the handle.

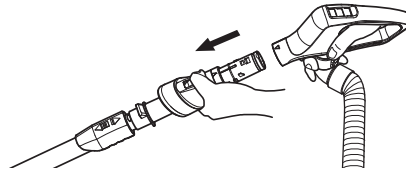

5. To use the dusting brush press the release button on the front of the dusting brush and pull the wand straight out of the dusting brush. Second, pull the dusting brush toward handle. After use, press the release button and pull out the dusting brush.

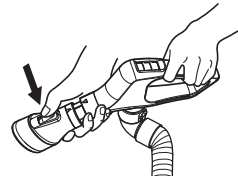
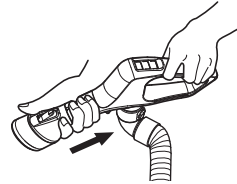
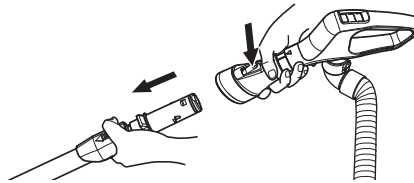

**Note:** The dusting brush is surrounded with a soft rubber coating to prevent damage to your furniture.

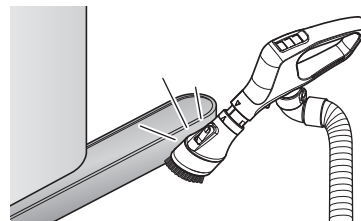

## Installing Attachments

### Using the crevice tool:

Slide the crevice tool over the end of the wand or fit it into the handle.

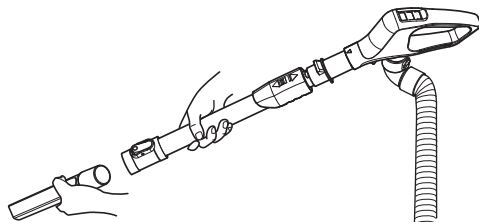

## Tips and Tricks

### Carpet Edges and Corners:

For tight corners, carpet edges, and along base boards, use the dusting/ upholstery tool. Use the crevice tool for especially hard to reach areas.

Use the crevice tool for hard to reach places such as tight corners and base boards.

## Using the Pet hair tool

The Pet hair tool attaches to the wand like the other attachments. It features a turbine-powered agitator to provide extra cleaning power on carpets and fabrics. It is great for cleaning stairs, cushions, and vehicle upholstery.

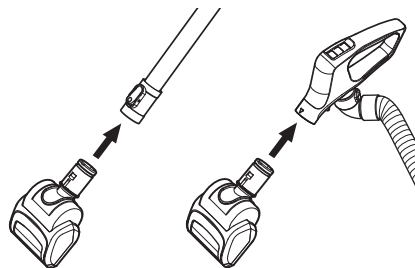

When using the Pet hair tool, check frequently for the buildup of hair, fibers, lint, and other debris in the brush area.

Excessive buildup can reduce performance and could damage the Pet hair tool. See the Care and Cleaning section for cleaning instructions.

## Stairways and Landings

Use the dusting/upholstery tool or Pet Handi Mate on stairs and landings. Make sure that the vacuum cleaner is placed so that it cannot tip or fall.

See below and page 11 for instructions on selecting and using attachments.

## Agitator Motor Overload Protection

The agitator has a built-in protection against motor damage should the agitator jam. If the agitator slows down or stops, the agitator overload protector shuts off the agitator motor. The suction motor will remain on at this time.

**To correct problem:** Turn off and unplug vacuum cleaner, remove obstruction, and press the reset button.

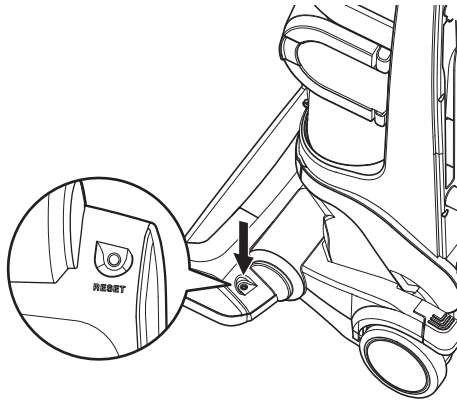

## Thermal Overload Protection

This vacuum cleaner has a thermal overload protector which automatically activates to protect the vacuum cleaner from overheating. If a clog prevents the normal flow of air to the motor, the thermal protector turns the motor off automatically to allow the motor to cool in order to prevent possible damage to the vacuum cleaner.

**To correct the problem:** Turn the vacuum cleaner off and unplug the power cord. Check for and remove clogs, if necessary. Also check and clean any dirty filters. Wait approximately 30 minutes and plug the vacuum cleaner in and turn back on to see if the motor protector has reset. The thermal protector system will not reset until the vacuum cleaner has completely cooled down.

## CARE & CLEANING

Always follow all safety precautions when cleaning and servicing the vacuum cleaner.

### Storing the Vacuum Cleaner

When not in use, wrap the cord around the cord hanger, as shown. Store the crevice tool in their proper places on the back of the vacuum cleaner.



### WARNING

Electrical shock and personal injury hazard.

Take care when wrapping the cord. Wrapping the cord too tightly puts stress on the cord and can cause cord damage. Do not criss-cross when wrapping the cord. A damaged cord is an electrical shock hazard and could cause personal injury or damage.

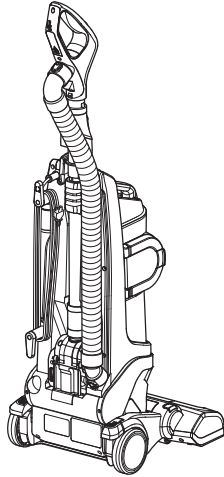

### Dust Tank Components

The dust tank consists of several key components. Always make sure that all parts are properly reinstalled after emptying the dust tank.

**NEVER operate the vacuum cleaner without all filters in place!**

**NEVER operate the vacuum cleaner with wet filters or components!**

#### Key components:

- 1~2. **Foam pre filter:** Captures medium to fine particles. It consists of Filter frame & Foam filter. These are washable.
3. **Dust tank lid:** Open to access Foam pre filter.
4. **Dust separator:** Capture dust and medium particles.
5. **Side door:** Open to remove dirt from dust separator.
6. **Emptying dirt release:** Press down to open the bottom plate.
7. **Dust tank:** where dirt is collected.
8. **Bottom plate:** Open to empty the dust tank.

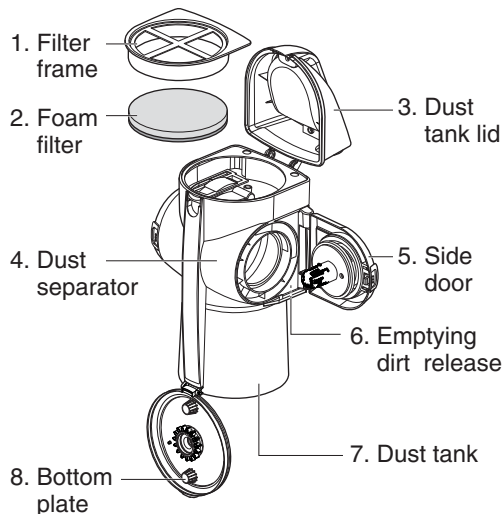



## Emptying the Dust Tank



### WARNING

Always unplug power cord from electrical outlet before performing any service on vacuum cleaner. Failure to do so could result in electrical shock or personal injury from vacuum cleaner suddenly starting.

For best performance, always empty the dust tank when the dirt level reaches the MAX line.



**Electrical shock and personal injury hazard.**

**TO REMOVE DUST TANK**, press the dust tank release button, tilt the dust tank back, then lift it out of the vacuum cleaner.

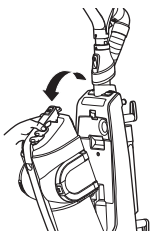

**TO EMPTY DUST TANK**, press the bottom plate release and open the bottom plate, as shown.



**TO REINSTALL THE DUST TANK**, place it in the holder, then tilt forward until it clicks into place. Make sure the dust tank is properly seated!

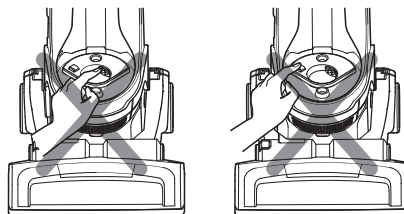

Don't touch the inner gear and button.

## Cleaning the Dust Tank

For optimal performance, check filters regularly and clean when necessary.

### To Clean the Dust Tank:

1. Remove the dust tank from the vacuum cleaner.
2. Press the bottom plate release and open the bottom plate.
3. Wipe out the dust tank with a damp cloth or paper towel.

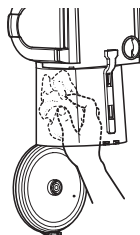

4. Release the latch on the Side door, on both the right and left sides.
5. Remove any hair, fibers or other debris from the dust separator.  
Do not remove the cones attached to the side door for cleaning.

**NEVER operate the vacuum cleaner with wet filters or components!**

## Cleaning the Foam Pre-Filter



### CAUTION

A wet filter can cause permanent damage to the vacuum cleaner. Be sure filters are completely dry before reinstalling.

For optimal performance, check the filters every 3 months and clean when necessary. Don't close the dust tank lid without pre-filter.

#### To Clean the Pre-Filter:

1. Remove the dust tank from the vacuum cleaner.
2. Lift up on the dust tank lid release and open the lid.



3. Lift out the foam pre-filter.

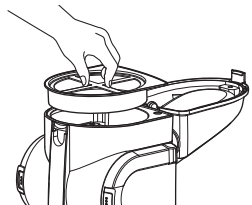

4. Separate the foam filter from the filter frame.



5. Shake out any excess dirt or debris, and rinse the foam filter & filter frame with clean water.



6. Dry completely under shadow place.

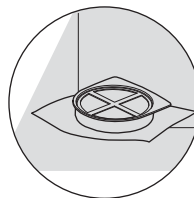

#### NEVER operate the vacuum cleaner with wet filters or components!

If you notice a loss of suction and cleaning the pre-filter does not help, you need to replace the pre-filter. You can purchase additional foam filters from LG by calling 800-243-0000 and asking for parts on page 6.

## Replacing the HEPA Filter

Your vacuum cleaner features a HEPA filter for optimal exhaust filtration. This filter cannot be cleaned and should be replaced annually for proper performance.

#### To Replace the HEPA Filter:

1. Remove the exhaust filter cover.
2. Lift out the filter by pressing the hook.
3. Insert a new filter, being sure to install it correctly.
4. Insert the exhaust filter cover.

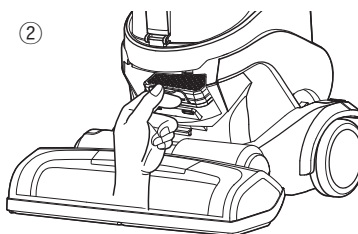
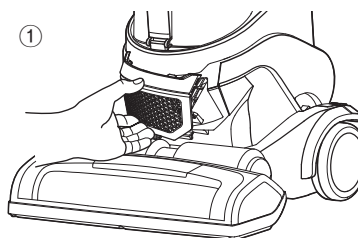

## Pet hair tool

### To clean the pet hair tool

1. Remove the four screws on the bottom of the pet hair tool.
2. Press in on the tabs and lift off the cover.
3. Remove any debris.

### To reassemble:

4. Carefully press cover onto tabs until they snap into place.
5. Insert and tighten screws removed in Step 1. **Do NOT overtighten the screws.**

**Do Not use the pet hair tool on any animal.**

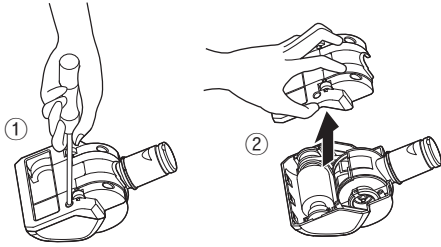

## Agitator Maintenance



### WARNING

**Electrical shock and personal injury hazard.**

**Always unplug the vacuum cleaner before servicing. Failure to do so could result in electrical shock or personal injury.**

Frequently check the agitator brush area for hair, string, and lint buildup.

### Remove the Agitator Brush Cover:

1. Unplug the vacuum cleaner. Press the left foot pedal to release the head. Lower the handle until the vacuum cleaner is lying flat on the floor.
2. Turn the vacuum cleaner over, so that the agitator is facing up.
3. Set the agitator on a cloth or a smooth surface. Remove the six screws on the bottom of the head and remove the cover.

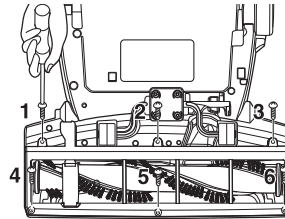

4. Carefully remove any accumulated string, hair, etc. from the agitator and the agitator area.

To reinstall the cover.

Reverse the steps above.

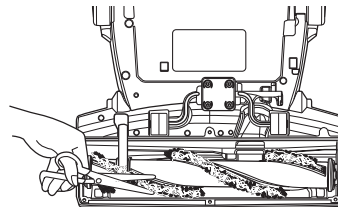

## Replacing the Agitator Belt



### WARNING

Electrical shock and personal injury hazard.

Always unplug the vacuum cleaner before servicing. Failure to do so could result in electrical shock or personal injury.

If the belt breaks, follow the steps below to replace the agitator belt.

#### To Replace the Belt:

1. Remove the agitator brush cover as described on page 19.
2. Lift the agitator straight out.

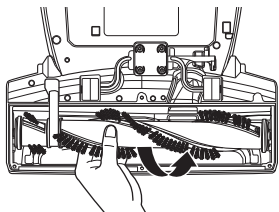

3. Unhook the old belt from the drive pulley. Make sure no pieces of the broken belt are trapped in the agitator or drive pulley area.

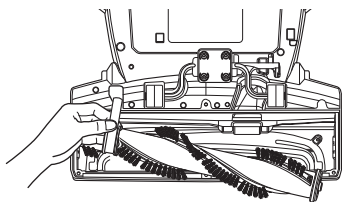

4. Hook the new belt over drive pulley.

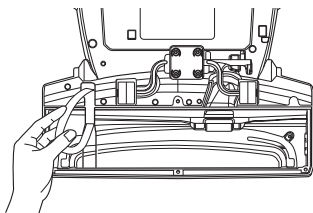

5. Fit the belt end of the agitator through the belt, making sure the belt is aligned with the pulley section of the agitator.

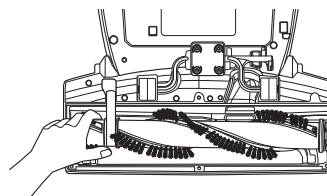

6. Lower the agitator into place, making sure the oval shaped tabs fit into the indents on the vacuum cleaner.

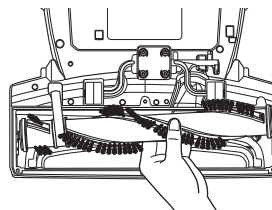

7. Reinstall the agitator brush cover as described above.

For a replacement belt, order LG service center belt part # MAS61842501.

#### Replacing the batteries

1. Slide the battery cover up and away from the hose.

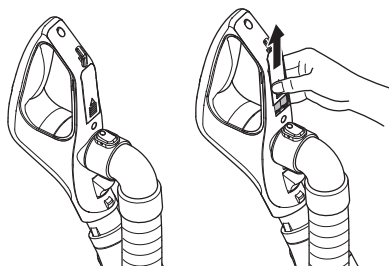

2. Replace the two batteries and reinstall the battery cover.

## Removing Clogs



### WARNING

Electrical shock and personal injury hazard.

Always unplug the vacuum cleaner before servicing. Failure to do so could result in electrical shock or personal injury.

If you notice a loss in suction, first check the filters as described on pages 17 and 18. If the filters are clean, there may be a clog. The arrows show areas where clogs are most likely to occur.

#### To check for clogs:

1. Check the hose where it connects to the handle by pressing the two release buttons on the top end of the hose.
2. Release the wand from the vacuum cleaner by pressing the wand release button. Separate the wand release button. Separate the wand and wand handle by pressing the button on the wand handle and check the wand and handle for clogs.

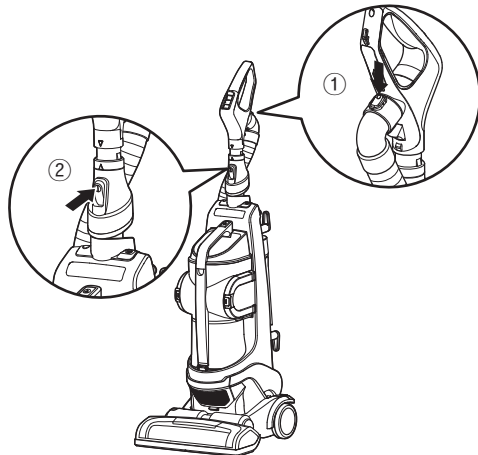

3. Remove the dust tank and check the dust tank inlet where it connects to the vacuum cleaner body.

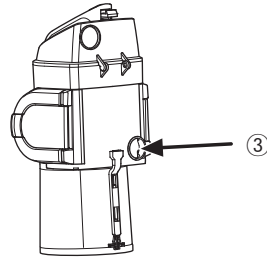

4. Check the hose where it connects to back of the body by pressing the release button on the top end of the hose.

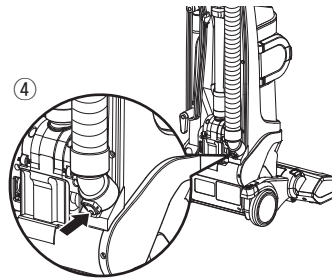

5. To check more thoroughly remove the screw by the port.

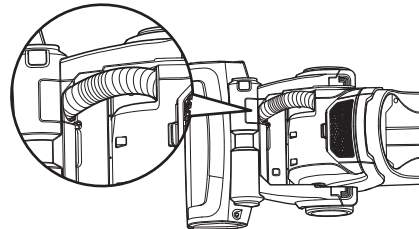
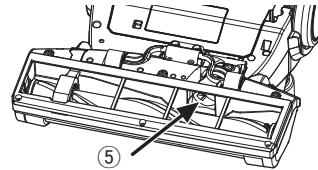

## Cleaning the Exterior of the Vacuum Cleaner



### **WARNING**

**Electrical shock and personal injury hazard.**

**Always unplug the vacuum cleaner before servicing. Failure to do so could result in electrical shock or personal injury.**

Wipe the exterior of the vacuum cleaner with a clean, soft cloth that has been dipped in water and wrung dry.

DO NOT allow water to enter any openings in the vacuum cleaner.

DO NOT clean tools in dishwasher or clothes washer. Wash tools in warm soapy water, rinse, and allow to air dry completely.

DO NOT use tools if they are wet.

## TROUBLESHOOTING

Review this chart to find do-it-yourself solutions for minor performance problems. Any service or repair needed, other than as described in this Use & Care Guide, should be performed through your local LGE service center.



### WARNING

**Electrical shock and personal injury hazard.**

**Always unplug the vacuum cleaner before servicing. Failure to do so could result in electrical shock or personal injury.**

PROBLEM	POSSIBLE CAUSE	POSSIBLE SOLUTION
<b>Vacuum cleaner will not run</b>	<ul style="list-style-type: none"> <li>• Unplugged at wall outlet</li> <li>• Batteries are dead</li> <li>• Thermal overload protection activated</li> </ul>	<ul style="list-style-type: none"> <li>• Make sure cord is plugged into a functioning outlet</li> <li>• Replace batteries see page 20</li> <li>• Allow the vacuum cleaner to cool down. See page 15</li> </ul>
<b>Agitator does not turn</b>	<ul style="list-style-type: none"> <li>• Switch is off (unit is in bare floor mode)</li> <li>• Cleaner is in upright position</li> <li>• Agitator Reset switch is tripped (brush is jammed)</li> <li>• Belt broken</li> </ul>	<ul style="list-style-type: none"> <li>• Turn on agitator power switch</li> <li>• Press handle release pedal and tilt unit back</li> <li>• Unplug the vacuum cleaner and check the agitator for obstructions and reset the unit. See Page 15</li> <li>• Replace belt. See page 20</li> </ul>
<b>Dust escapes the dust tank</b>	<ul style="list-style-type: none"> <li>• Dust tank improperly installed</li> <li>• Pre-filter cover not closed</li> <li>• Tank bottom is not latched</li> </ul>	<ul style="list-style-type: none"> <li>• Make sure all dust tank components and filters are installed correctly</li> <li>• Check pre-filter cover</li> <li>• Make sure tank bottom is closed and latched</li> </ul>
<b>Poor dirt pickup</b>	<ul style="list-style-type: none"> <li>• Full or clogged dust tank</li> <li>• Dust tank improperly installed</li> <li>• Wand not installed properly</li> <li>• Clogged hose or nozzle</li> <li>• Belt broken/not installed properly</li> <li>• Thermal protector activated</li> <li>• Agitator overload protector activated</li> <li>• Hole in hose</li> <li>• Worn agitator</li> </ul>	<ul style="list-style-type: none"> <li>• Empty dust tank and clean filters</li> <li>• Make sure all dust tank components and filters are installed correctly</li> <li>• Make sure the wand is installed correctly</li> <li>• Check for clogs. See page 21</li> <li>• Check belt, and replace if needed. See page 20</li> <li>• Allow the vacuum cleaner to cool down. See page 15</li> <li>• Unplug the vacuum cleaner and check the agitator for obstructions. Press the reset button</li> <li>• Inspect hose carefully. Replace if needed</li> <li>• Contact service</li> </ul>

<b>PROBLEM</b>	<b>POSSIBLE CAUSE</b>	<b>POSSIBLE SOLUTION</b>
<b>Cleaner picks up moveable rugs or is hard to push</b>	<ul style="list-style-type: none"> <li>• Wrong pile height setting</li> <li>• Use lower power level</li> </ul>	<ul style="list-style-type: none"> <li>• Adjust pile height</li> <li>• Reduce the power level</li> </ul>
<b>Brush on Pet hair tool will not run when attached</b>	<ul style="list-style-type: none"> <li>• Dirty brush or brush supports</li> <li>• Obstruction in turbine air path</li> <li>• Low suction from vacuum cleaner</li> </ul>	<ul style="list-style-type: none"> <li>• Clean the inside of the Pet hair tool. See page 19</li> <li>• Clean the inside of the Pet hair tool. See page 19</li> <li>• Check for clogs. See page 21</li> </ul>
<b>Accessory has no suction when using with the handle</b>	<ul style="list-style-type: none"> <li>• Main wand still connected to body base</li> </ul>	Remove wand see page 13 for wand removal
<b>Handle controls not working</b>	<ul style="list-style-type: none"> <li>• Batteries need replacement</li> </ul>	Replace batteries in handle see page 20





**LG Electronics Inc.**