

APPENDIX H
: USER'S MANUAL

Table of Contents

Installation and Connection

Safety Precautions	A1
Accessories	A4
Before connecting to the PC	A5
Name and Function of the Parts	A7
Connecting to External Devices	A11
When Connecting to your PC	A11
When Watching VCR/DVD	A13
When Watching D-Sub from the DVD/SET -TOP BOX	A15
When Watching TV	A16
To arrange cables in order	A17

Input Selection and Tracking

Selecting and Adjusting the Screen	A18
Name of the Buttons in the screen Adjustment Unit	A18
OSD (On Screen Display) Menu	A20
OSD (On Screen Display) Screen Tracking Order	A21
Set/Select the channel when using the TV	A22
Adjusting the picture function	A23
Adjusting the sound function	A25
Adjusting the time function	A26
Selecting the setup function	A27
Adjusting the screen function (RGB-PC, RGB-DTV only)	A33



Miscellaneous

Troubleshooting	A34
Specifications	A37

ENGLISH

Safety Precautions

Please read these safety precautions carefully before using the product.

-  **Warning** If you ignore the warning message, you may be seriously injured or there is a possibility of accident or death.
-  **Caution** If you ignore the caution message, you may be slightly injured or the product may be damaged

Precautions in installing the Product

Warning

- **Keep away from heat sources like electrical heaters.**
 - Electrical shock, fire, malfunction or deformation may occur.
- **Keep the packing anti-moisture material or vinyl packing out of the reach of children.**
 - Anti-moisture material is harmful if swallowed. If swallowed by mistake, force the patient to vomit and visit the nearest hospital. Additionally, vinyl packing can cause suffocation. Keep it out of the reach of children.
- **Do not put heavy objects on the product or sit upon it.**
 - If the product collapses or is dropped, you may be injured. Children must pay particular attention.
- **Do not leave the power or signal cable unattended on the pathway.**
 - The passerby can falter, which can cause electrical shock, fire, product breakdown or injury.
- **Install the product in a neat and dry place.**
 - Dust or moisture can cause electrical shock, fire or product damage.
- **If you can smell smoke or other odors or hear a strange sound unplug the power cord and contact the service center.**
 - If you continue to use without taking proper measures, electrical shock or fire can occur.
- **If you dropped the product or the case is broken, turn off the product and unplug the power cord.**
 - If you continue to use without taking proper measures, electrical shock or fire can occur. Contact the service center.
- **Do not drop metallic objects such as coins, hair pins, chopsticks or wire into the product, or inflammable objects such as paper and matches. Children must pay particular attention.**
 - Electrical shock, fire or injury can occur. If a foreign object is dropped into the product, unplug the power cord and contact the service center.

Caution

- **Make sure the product ventilation hole is not blocked. Install the product in a suitably wide place (more than 10cm from the wall)**
 - If you install the product too close to the wall, it may be deformed or fire can break out due to internal heat.
- **Do not block the ventilation hole of the product by a tablecloth or curtain.**
 - The product can be deformed or fire can break out due to overheating inside the product.
- **Install the product on a flat and stable place that has no risk of dropping the product.**
 - If the product is dropped, you may be injured or the product may be broken.
- **Install the product where no EMI occurs.**
- **Keep the product away from direct sunlight.**
 - The product can be damaged.

● Electrical Power Related Precautions

⚠ Warning

- **Make sure to connect the power cable to the grounded current.**
 - You may be electrocuted or injured.
- **Use the rated voltage only.**
 - The product can be damaged, or you may be electrocuted.
- **During a thunder or lightning storm, unplug the power cable or signal cable.**
 - You may be electrocuted or a fire can break out.
- **Do not connect several extension cords, electrical appliances or electrical heaters to a single outlet. Use a power bar with a grounding terminal designed for exclusive use with the computer.**
 - A fire can break out due to overheating.
- **Do not touch the power plug with wet hands. Additionally, if the cord pin is wet or covered with dust, dry the power plug completely or wipe dust off.**
 - You may be electrocuted due to excess moisture.
- **If you don't intend to use the product for a long time, unplug the power cable from the product.**
 - Covering dust can cause a fire, or insulation deterioration can cause electric leakage, electric shock or fire.
- **Fix the power cable completely.**
 - If the power cable is not fixed completely, a fire can break out.
- **Hold the plug when pulling out the power cable. Do not bend the power cord with excessive force or put heavy objects on the power cord.**
 - The power line can be damaged, which may cause electric shock or fire.
- **Do not insert a conductor (like a metal chopstick) into one end of the power cable while the other end is connected to the input terminal on the wall. Additionally, do not touch the power cable right after plugging into the wall input terminal.**
 - You may be electrocuted.
- **The power supply cord is used as the main disconnection device. Ensure that the socket-outlet is easily accessible after installation.**

⚠ Caution

- **Do not unplug the power cord while the product is in use.**
 - Electrical shock can damage the product.

● Precautions in Moving the Product

⚠ Warning

- **Make sure to turn off the product.**
 - You may be electrocuted or the product can be damaged.
- **Make sure to remove all cables before moving the product.**
 - You may be electrocuted or the product can be damaged.

Safety Precautions

Caution

- **Do not shock the product when moving it.**
 - You may be electrocuted or the product can be damaged.
- **Do not dispose the product-packing box. Use it when you move.**
- **Make the panel face forward and hold it with both hands to move.**
 - If you drop the product, the damaged product can cause electric shock or fire. Contact with the service center for repair.

Precautions in Using the Product

Warning

- **Do not disassemble, repair or modify the product at your own discretion.**
 - Fire or electric shock accident can occur.
 - Contact the service center for check, calibration or repair.
- **When cleaning the brown tube surface, unplug the power cord and scrub with soft cloth to prevent scratching. Do not clean with a wet cloth.**
- **Keep the product away from water.**
 - Fire or electric shock accident can occur.

Caution

- **Do not put or store inflammable substances near the product.**
 - There is a danger of explosion or fire due to careless handling of the inflammable substances.
- **When cleaning the brown tube surface, unplug the power cord and scrub with soft cloth to prevent scratching. Do not clean with a wet cloth.**
 - The water can sink into the product, which can cause electric shock or serious malfunction.
- **Take a rest from time to time to protect your vision.**
- **Keep the product clean at all times.**
- **Take a comfortable and natural position when working with a product to relax the muscles.**
- **Take a regular break when working with a product for a long time.**
- **Do not press strongly upon the panel with a hand or sharp object such as nail, pencil or pen, or make a scratch on it.**
- **Keep the proper distance from the product.**
 - Your vision may be impaired if you look at the product too closely.
- **Set the appropriate resolution and clock by referring to the User's Guide.**
 - Your vision can be impaired.
- **Use authorized detergent only when cleaning the product. (Do not use benzene, thinner or alcohol.)**
 - Product can be deformed.

On Disposal

- **The fluorescent lamp used in this product contains a small amount of mercury.**
- **Do not dispose of this product with general household waste.**
 - Disposal of this product must be carried out in accordance to the regulations of your local authority.

Accessories

Please check the accessories in the product package.

* The product and the accessories can be different from the figures shown here.

ENGLISH



Remote Control/Batteries

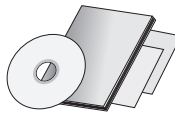

User's Guide/
Driver CD/Cards



D-Sub Signal Cable



Power Cable



Audio Cable (PC)

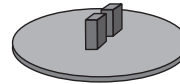

Stand base

● Inserting batteries into remote control.

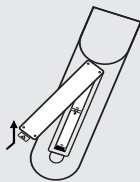

1. Take out the battery cap.
2. Insert the batteries with correct polarity (+/-).
3. Close the battery cap.
 - You can use a remote control 7 meter distance and 30 degree (left/right) within the receiving unit scope.
 - Dispose of used batteries in the recycle bin to prevent environmental pollution.

Before Connecting to the PC

- Before setting up the product, ensure that the power to the product, the computer system, and other attached devices is turned off.

Connecting the stand base

1. Place the product with its front facing downward on a soft cloth.
2. Align the hooks on the stand base with the matching slots in the base of the product.
3. Insert the hooks into slots.

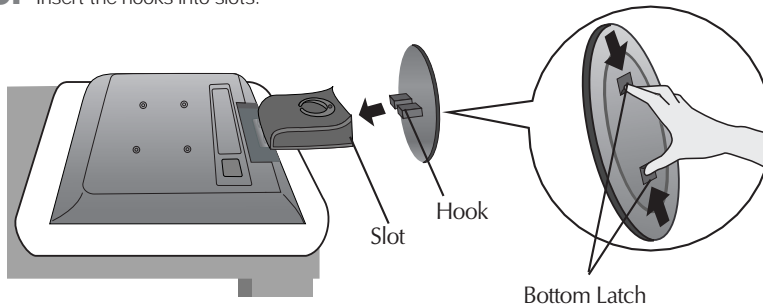

Removing the stand base

1. Place the product with its front facing downward on a soft cloth.
2. To remove the stand base, hold the bottom of the stand with one hand and pull the base bottom latch with the other hand, as shown in the figure.

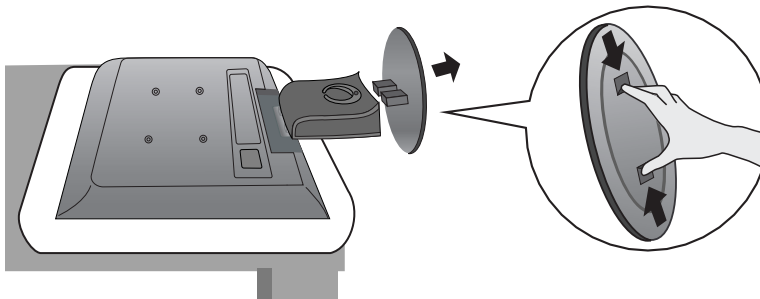

Important

- Once you connect the stand base, try not to disconnect it.
- Do not carry the product upside down holding only the stand base. The product may fall and get damaged or injure your foot.

- Before setting up the product, ensure that the power to the product, the computer system, and other attached devices is turned off.

Positioning your display

1. Adjust the position of the panel in various ways for maximum comfort.

- Tilt Range $-3^{\circ} \sim 25^{\circ}$

- Swivel : 345°

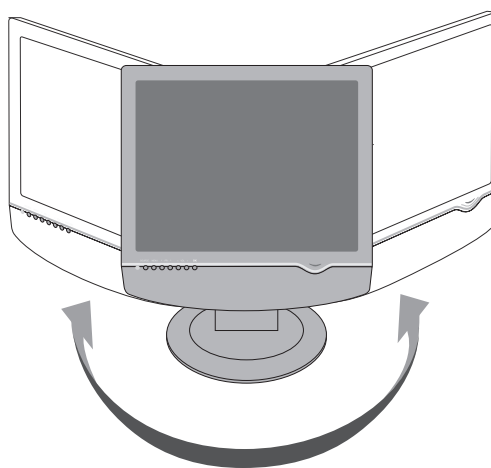
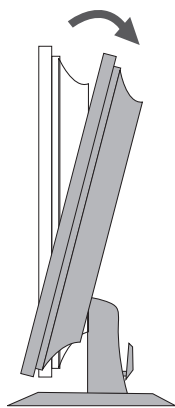

Name and Function of the Parts

Name of the Remote Control Buttons

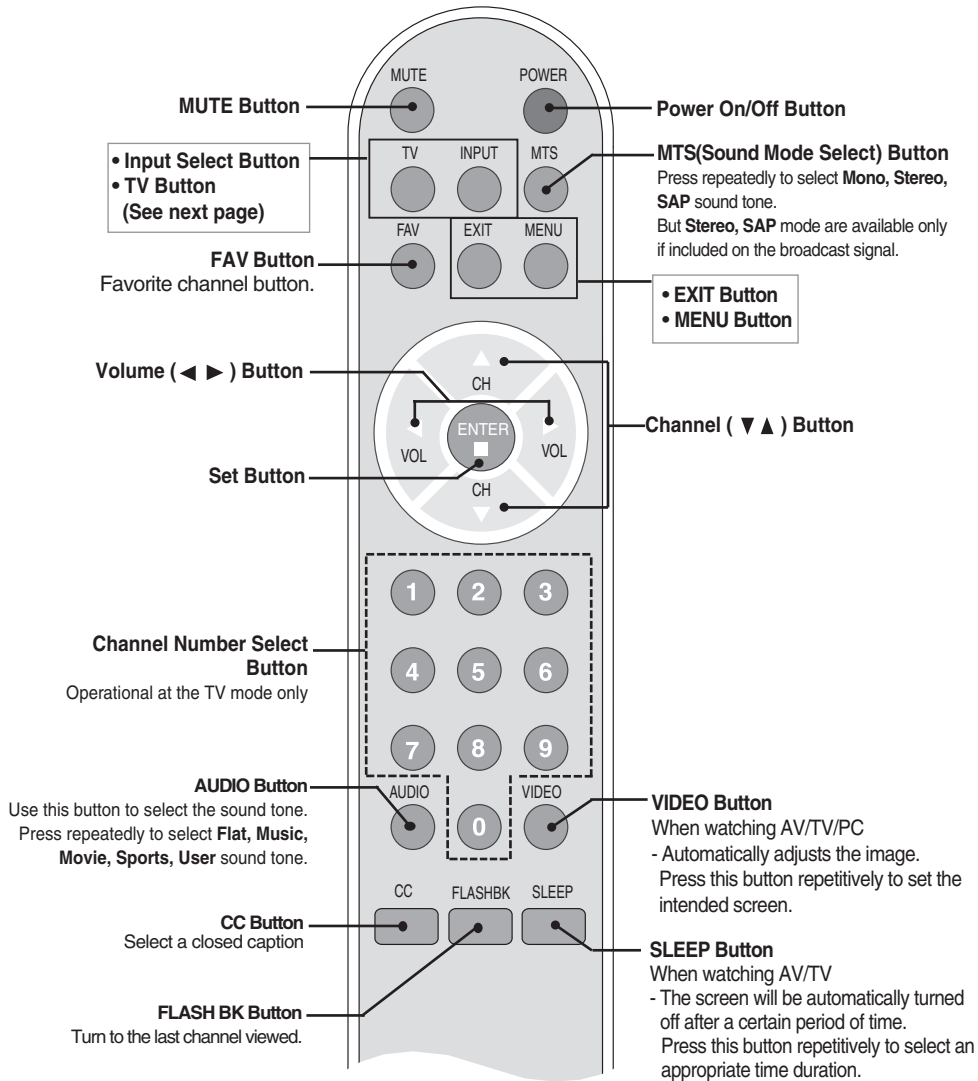

• **TV Button**

The signal type will be changed with the following order. Set the signal type you want.

TV → AV → RGB-DTV → RGB-PC

• **Input Select Button**

If you press the button once, the following Input Signal Window will appear. Select the signal type you want using the ▼▲ button.

Each time you press the Input button it will change to TV → Video → RGB-DTV → RGB-PC. If nothing is inputted for several seconds the screen will automatically move to the selected menu.

Input

TV
Video
RGB-DTV
RGB-PC

▼ ■ MENU

Name and Function of the Parts

Rear View

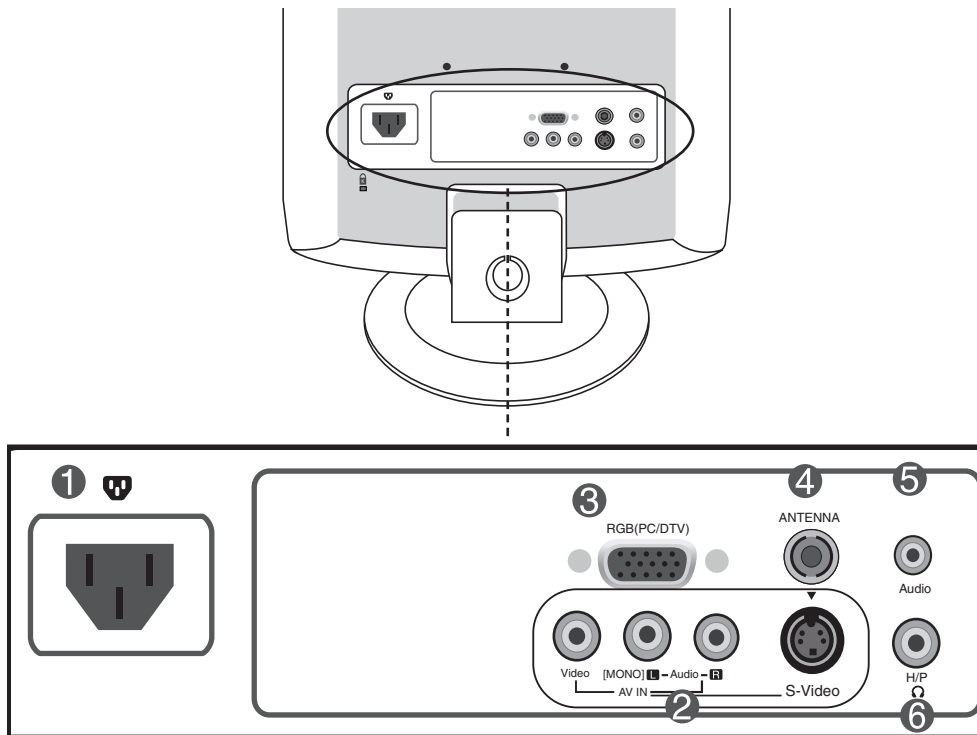

- ① Power Connector : Connect the power cord.
- ② AV Input Terminal
- ③ D-Sub Analog Signal Connector
- ④ TV Tuner Jack : Connect the antenna.
- ⑤ PC Sound Jack : Connect to the jack in the PC sound card.
- ⑥ Headphone/Earphone Connection Terminal

● AV Input Terminal

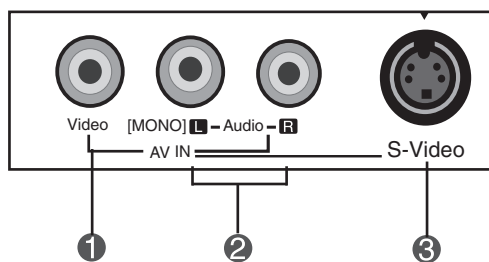

- ① **Video Input Terminal**
- ② **Audio Input Terminal**
- ③ **S-Video Input Terminal**

● Connecting the sound card output terminal

- Make sure to check the sound card connection terminal in the PC before connecting to the product.
If the PC sound card supports both Speaker Out and Line Out, change it to Line Out by setting the jumper or the PC application. (For more details, refer to the sound card user's guide.)
 - **Speaker Out** : The terminal connected to the speaker that is not equipped with an amplifier.
 - **Line Out** : The terminal connected to the speaker equipped with an amplifier.
- If Audio Out in the PC sound card has only Speaker Out, reduce the PC volume. This product is integrated with an amplifier.

Connecting to External Devices

■ ■ ■ When Connecting to your PC

1. First of all, see if the computer, product and the peripherals are turned off.
Then, connect the signal input cable.

- (A) When connecting with the D-Sub signal input cable. (IBM compatible PC)
- (B) When connecting with the D-Sub signal input cable. (Macintosh)

Rear side of the product.

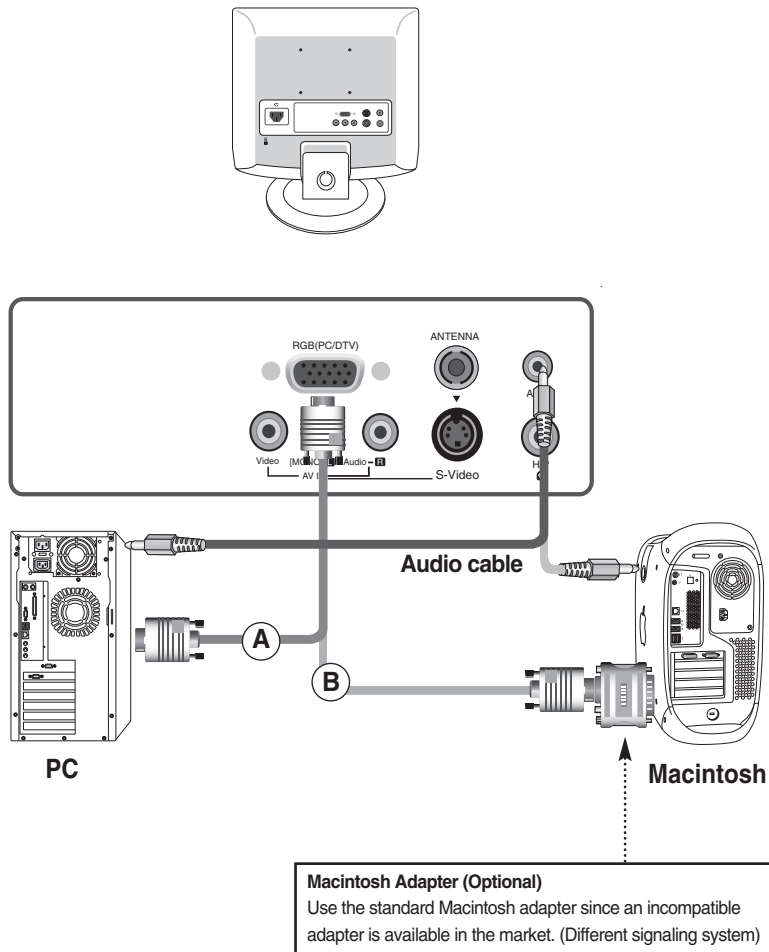

2. Connect the power cord.

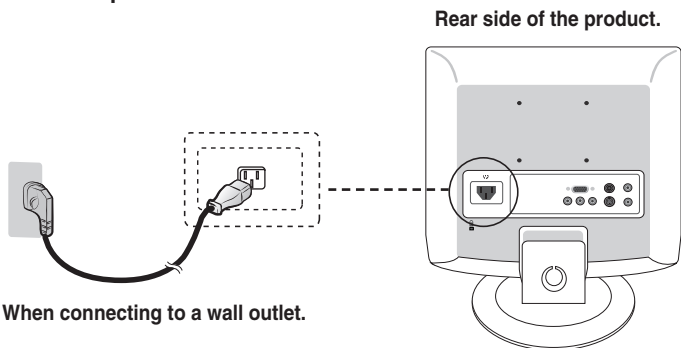

* When connecting to a wall outlet.

3. A Turn on power by pressing the power button on the product.

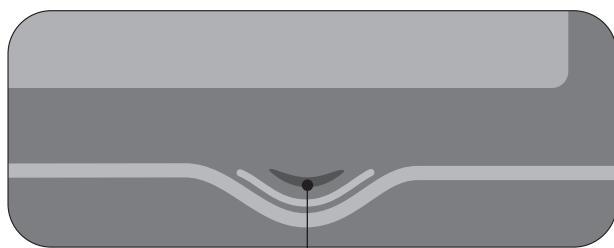

Power button

B Turn on the PC.

4. Select an input signal.
Press the INPUT button on the remote control to select the input signal.

INPUT → OK

Or, press the INPUT button at the front side of the product.

INPUT → OK

• Select **RBG-PC**

Each time you press the Input button it will change to
TV → Video → RGB-DTV → RGB-PC.
If nothing is inputted for several seconds the screen will automatically move to the selected menu.

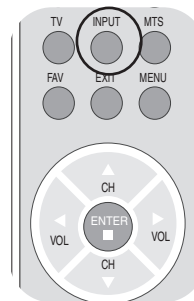
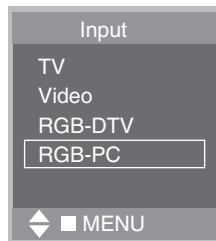

Note

• Directly connect to a grounded power outlet on the wall or a power bar with a ground wire.

Connecting to External Devices

■ ■ ■ When watching VCR/DVD

1. Connect the video/audio cable as shown in the below figure and then connect the power cord (See page A12).

- A** When connecting with an RCA cable.
- Connect the input terminal with a proper colour match.
(Video – Yellow, Sound (left) – White, Sound (right) – Red)

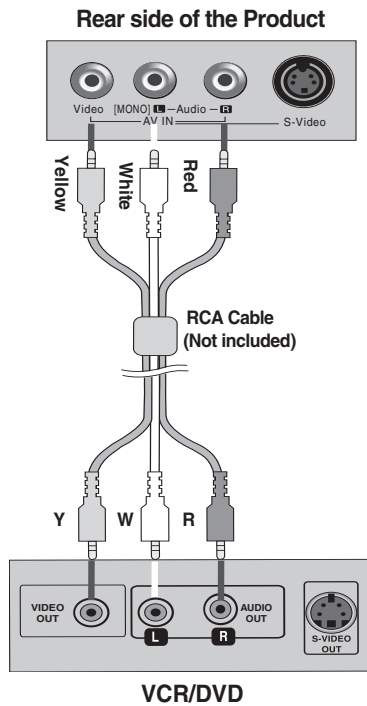

- B** When connecting with an S-Video cable.
- Connect to the S-Video input terminal to watch high image quality movies.

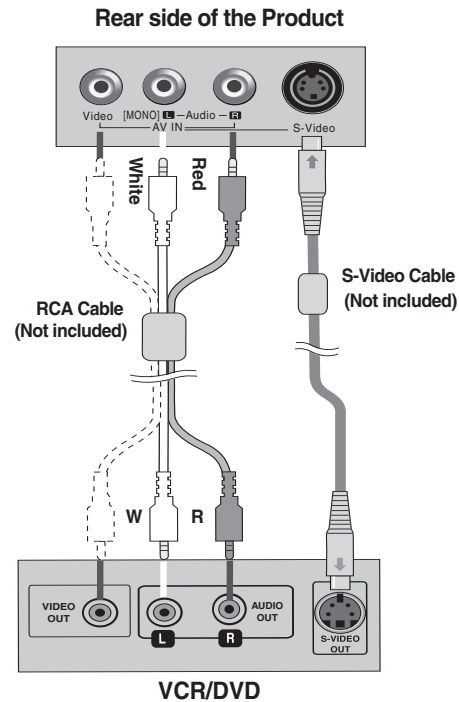

- 2.** Select an input signal.
Press the **INPUT** button on the remote control to select the input signal.

INPUT → **OK**

Or, press the **INPUT** button at the front side of the product.

INPUT → **OK**

- A** When connecting with a RCA cable.
• Select **Video**
- B** When connecting with a S-Video cable.
• Select **Video**

Each time you press the Input button it will change to
TV → Video → RGB-DTV → RGB-PC.
If nothing is inputted for several seconds the screen will automatically move to the selected menu.

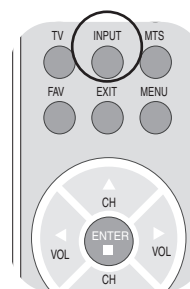
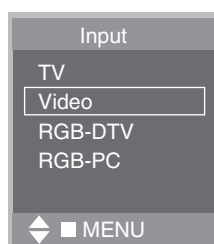

Connecting to External Devices

■ ■ ■ When watching D-Sub from the DVD/SET-TOP BOX

1. When connecting the video/audio cable as shown in the below figure and then connect the power cord. (see page A12)

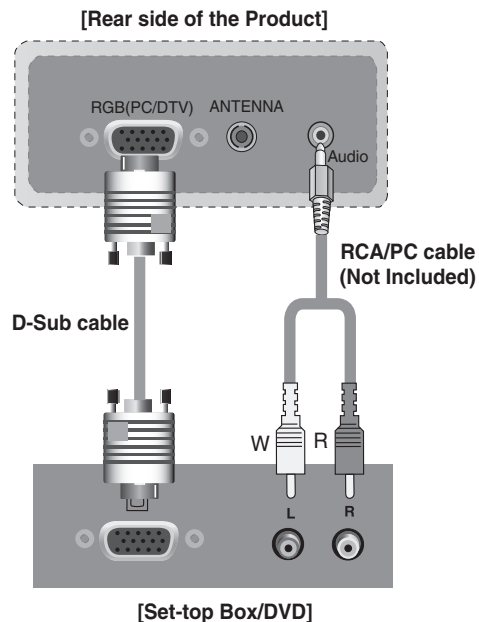

2. Select an input signal.
Press the INPUT button on the remote control to select the input signal.

INPUT → OK

Or, press the INPUT button at the front side of the product.

INPUT → OK

- Select RGB-DTV

Each time you press the Input button it will change to
TV → Video → RGB-DTV → RGB-PC.
If nothing is inputted for several seconds the screen will automatically move to the selected menu.

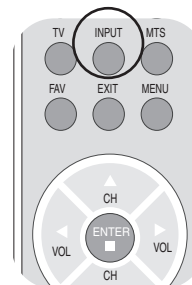
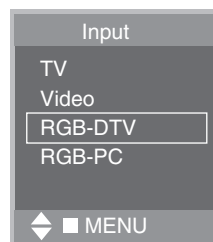

■ ■ ■ When watching TV

1. See if the antenna cable is connected at the rear side of the product and then, connect the power cord.

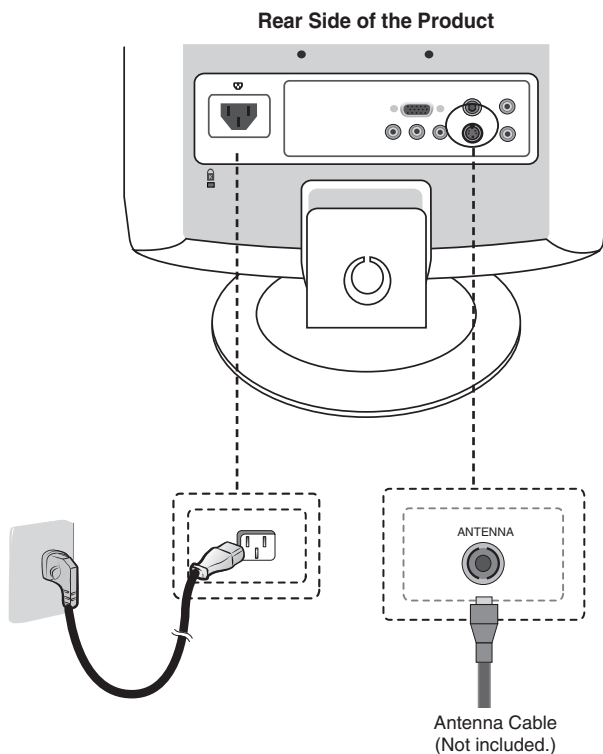

2. Select an input signal.
Press the INPUT button on the remote control to select the input signal.

INPUT → OK

Or, press the INPUT button at the front side of the product.

INPUT → OK

- Select TV

Each time you press the Input button it will change to
TV → Video → RGB-DTV → RGB-PC.
If nothing is inputted for several seconds the screen will automatically move to the selected menu.

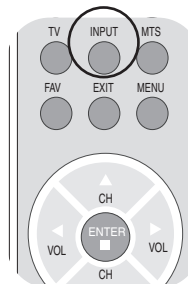
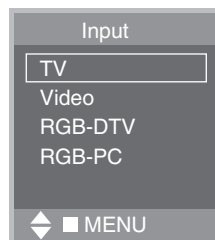

To arrange cables in order

Connect the signal cable, power cord and the audio cable to use in order to arrange in the cable holder as shown in the following figure.

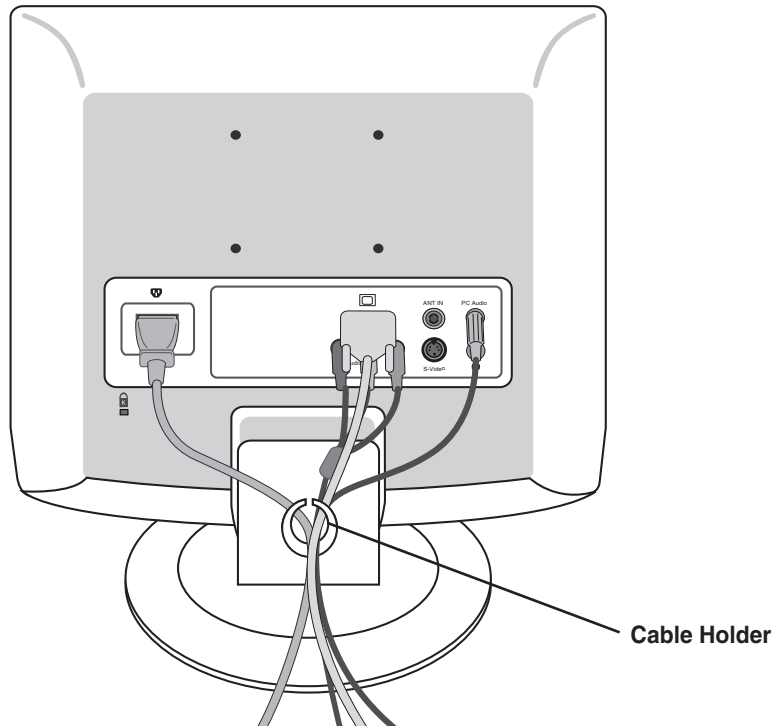

Selecting and Adjusting the Screen

● Name of the Buttons in the Screen Adjustment Unit

ENGLISH

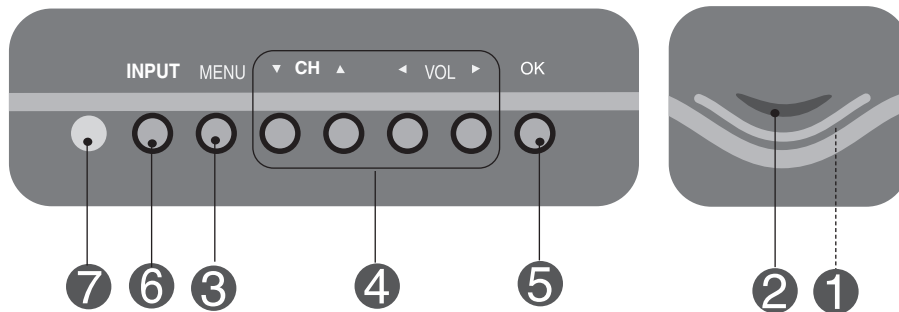

- 1** **Power Indicator** • This Indicator lights up blue when the display operates normally (On Mode). If the display is in Sleep (Energy Saving) Mode, this indicator colour changes to amber.
- 2** **Power Button** • Press the button to turn on the power. Press the button again to turn it off.
- 3** **MENU Button** • Use this button to show/hide the OSD (On Screen Display) menu screen.
- 4** **OSD Select/Adjust Button** • Use this button to select an icon or adjust the setting in the OSD screen.

 - ▼▲ • Use this button to control the channel for the TV signal.
 - ◀▶ • Adjust the volume.



Selecting and Adjusting the Screen

● Name of the Buttons in the Screen Adjustment Unit

5

OK Button

• Select the icon to adjust on the OSD screen.

[For PC Analog signal]



6

INPUT Button

TV	Television
AV	CVBS, S-Video
RGB-DTV	DTV
RGB-PC	D-Sub analog signal

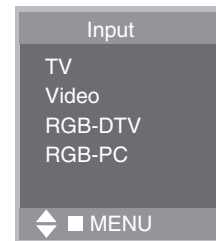







Each time you press the Input button it will change to
TV → Video → RGB-DTV → RGB-PC.
If nothing is inputted for several seconds the screen will automatically
move to the selected menu.

7

IR Receiver

• The unit that receives the signal from the remote control.

● OSD (On Screen Display) Menu

Icon	Function Description
 CHANNEL	Set/Select the channel when using the TV
 PICTURE	Adjusting the picture function.
 SOUND	Adjusting the sound function.
 TIMER	Adjusting the time function.
 SPECIAL	Selecting the setup function.
 SCREEN	Adjusting the screen function. (RGB-PC only)



Note OSD(On Screen Display)

The OSD function enables you to adjust the screen status conveniently since it provides graphical presentation.

Selecting and Adjusting the Screen

● OSD (On Screen Display) Screen Tracking Order

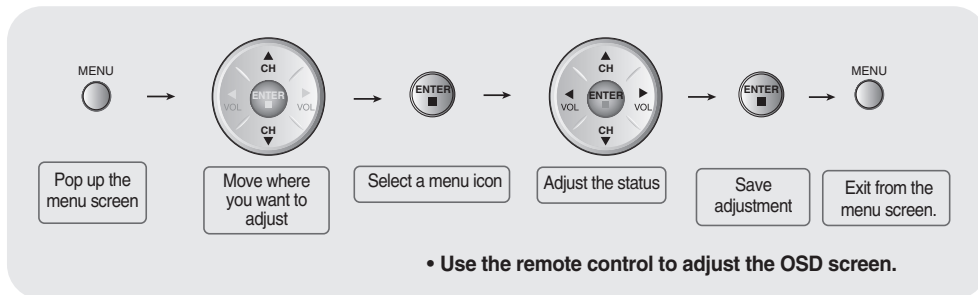

- 1 Press the **MENU** Button, then the main menu of the OSD appears.
- 2 To access a control, use the ▼▲ Buttons.
- 3 When the icon you want becomes highlighted, press the **ENTER** Button.
- 4 Use the ▼▲◀▶ Buttons to adjust the item to the desired level.
- 5 Accept the changes by pressing the **ENTER** Button.
- 6 Exit the OSD by pressing the **MENU** Button.



Set/Select the channel when using the TV

ENGLISH

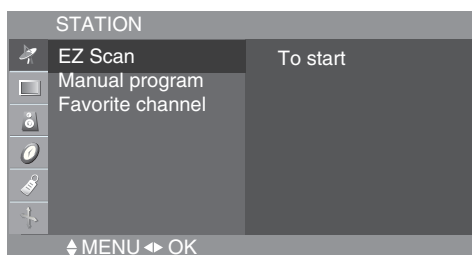

EZ Scan

Press ► button to start automatic programming. All available TV channels are searched and stored automatically.

To stop auto CH progress, press the **MENU** or **ENTER** button.

- Wait for auto CH progress to complete the channel search cycle before choosing a channel. The TV scans for over-the-air channels and then channels are provided by a cable service.

Manual program

User can do manual channel selection and store or erase individual channels.

Press ► button and then use ◀ ▶ button to select a channel you want to add to memory or erase. Press the ▼ button and then use ◀ ▶ button to select **Memory**(add) or **Erase**(delete).

Favorite Channel

This function lets you select your favourite channels directly.

Press the ▼ ▲ ◀ ▶ buttons to select a channel number.

* **FAV Button (remote control)** : Rotate Favourite channel.



Selecting and Adjusting the Screen



Adjusting the picture function

EZ Video

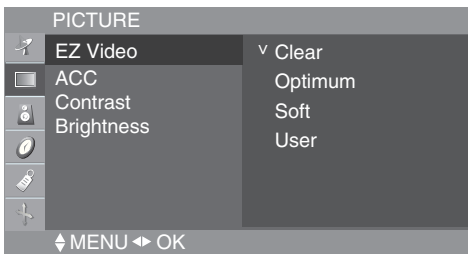

The **EZ Video** function automatically adjusts the screen image quality.

- **Clear**
Select this option to display with a sharp image.
- **Optimum**
The most general and natural screen display status.
- **Soft**
Select this option to display with a mild image.
- **User**
Select this option to use the user-defined settings.

ACC

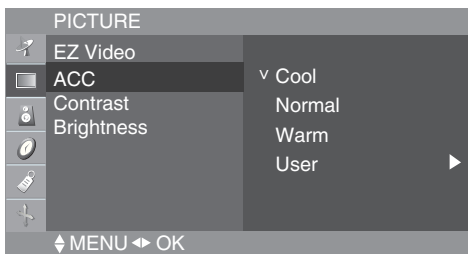

Selecting a factory setting color set.

- **Cool**
Slightly purplish white.
- **Normal**
Slightly bluish white.
- **Warm**
Slightly reddish white.
- **User**
Select this option to use the user-defined settings.
Red / Green / Blue
Set your own color levels.

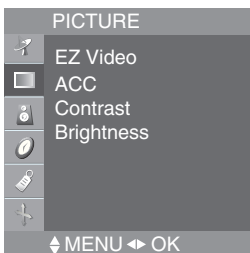

Contrast : To adjust the contrast of the screen.

Brightness : To adjust the brightness of the screen.



Adjusting the picture function (RGB-DTV, RGB-PC)

ENGLISH

EZ Video

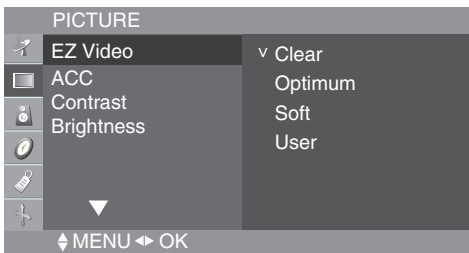

The **EZ Video** function automatically adjusts the screen image quality.

- **Clear**
Select this option to display with a sharp image.
- **Optimum**
The most general and natural screen display status.
- **Soft**
Select this option to display with a mild image.
- **User**
Select this option to use the user-defined settings.

ACC

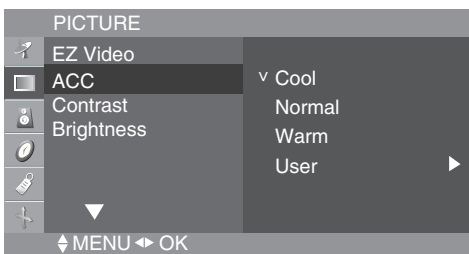

Selecting a factory setting color set.

- **Cool**
Slightly purplish white.
- **Normal**
Slightly bluish white.
- **Warm**
Slightly reddish white.
- **User**
Select this option to use the user-defined settings.
Red / Green / Blue
Set your own color levels.

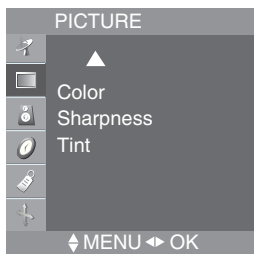

Contrast : To adjust the contrast of the screen.

Brightness : To adjust the brightness of the screen.

Color : To adjust the color to desired level.

Sharpness : To adjust the clearness of the screen.

Tint : To adjust the tint to desired level. This function is available only in NTSC broadcasting mode.

Selecting and Adjusting the Screen



Adjusting the sound function

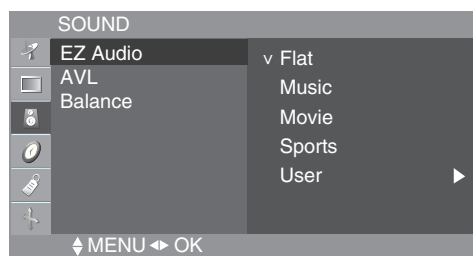

EZ Audio

The best sound tone quality will be selected automatically depending on the video type that you're currently watching.

- **Flat** : The most commanding and natural audio.
- **Music** : Select this option to enjoy the original sound when listening to the music.
- **Movie** : Select this option to enjoy sublime sound.
- **Sports** : Select this option to watch sports broadcasting.
- **User** : Select this option to use the user-defined audio settings.

AVL

To adjust uneven sound volumes across all channels or signals automatically to the most appropriate level. To use this feature, select **On**.

Balance

Use this function to balance sound from the left and right speakers.



Adjusting the time function

ENGLISH

Clock



Auto Clock Setup

This function is used to set up of current time.

You must set the time correctly before using **On/Off timer** function.

- 1) Press the **menu** button and then use **▼▲** button to select the **TIMER** menu.
- 2) Press the **▶** button and then use **▼▲** button to select the **Clock** menu.
- 3) Press **▶** button and then use **▼▲** button to select **Auto**.
- 4) Press **▶** button and then use **▼▲** button to select the time zone for your viewing area. Your choices are : AUTO, E.S.T(Eastern Standard Time), C.S.T(Central Standard Time), M.S.T(Mountain Standard Time), P.S.T (Pacific Standard Time), Alaska and Hawaii.
- 5) Press **▶** button and then use **▼▲** button to set PBS channel.
- 6) Press **▶** button and then use **▼▲** button to set D.S.T (Daylight Savings Time) **Auto**, **Off** or **On**, depending in whether or not your viewing area observes Daylight Savings Time.
- 7) Press **enter** button to save.

Manual Clock Setup

You must set the time correctly before using **On/Off timer** function.

- 1) Press the **menu** button and then use **▼▲** button to select the **TIMER** menu.
- 2) Press the **▶** button and then use **▼▲** button to select the **Clock** menu.
- 3) Press **▶** button and then use **▼▲** button to select **Manual**.
- 4) Press **▶** button and then use **▼▲** button to set the hour(01~12).
- 5) Press **▶** button and then use **▼▲** button to set the minutes(00~59).
- 6) The default value is -- : -- AM(PM).

Off / On timer

The **Off timer** automatically switches the set to off mode at the pre-set time.

- 1) Press the **menu** button and then use **▼▲** button to select the **TIMER** menu.
- 2) Press the **▶** button and then use **▼▲** button to select **Off timer** or **On timer**.
- 3) Press the **▶** button and then use **▼▲** button to set the hour(01~12).
- 4) Press the **▶** button and then use **▼▲** button to set the minutes(00~59).
- 5) Press the **▶** button and then use **▼▲** button to select **Run** or **Hold**.
- 6) Only **On timer** function; Press the **▶** button and then **▼▲** button to adjust volume level and channel number.
- 7) Press the **enter/menu** button to save.

Auto off

If **Auto off** is active and there is no input signal, the TV switches to off mode automatically after 10 minutes.

- 1) Press the **menu** button and then use **▼▲** button to select the **Auto off** menu.
- 2) Press the **▶** button and then use **▼▲** button to select **On** or **Off**.
- 3) Press the **enter/menu** button to save .



Note

- In the event of power interruption (disconnection or power failure), the **Clock** must be reset.
- Two hours after the set is switched on by the **On timer** function it will automatically switch back to off mode unless a button has been pressed.
- Once the **On** or **Off timer** is set, these functions operate daily at the preset time.
- **Off timer** function overrides **On timer** function if they are set to the same time.
- The set must be in off mode for the **On timer** to work.

Selecting and Adjusting the Screen



Selecting the setup function

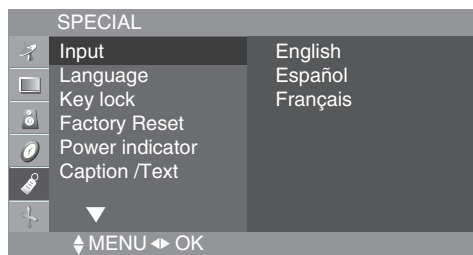

- Input** If you press the button once, the following Input Signal Window will appear. Select the signal type you want using the ▼▲ button.
- Language** To choose the language in which the control names are displayed.
- Key lock** Use the ▼▲ buttons to select **On** or **Off**. It can be set up so that it can only be used with the remote control. This feature can prevent unauthorized viewing.
In order to lock the OSD screen adjustment, set the **Key lock** tab to the '**On**' position. In order to unlock it, do the following :
1) Push the **menu** button on the remote control and set **Key lock** to the '**Off**' position.
- Factory Reset** Use this function to reset the product to the factory default. However, language selection will not be initialized.
- Power indicator** Use this function to set the power indicator on the front side of the product to **On** or **Off**. If you set **On** at any time, the power indicator will automatically be turned on.



Selecting the setup function (To adjust the CAPTION & VCHIP function - US Only)

- Caption / Text** Use the ▼▲ buttons to select caption mode.
Text services give a wide variety of information on all kind of subjects(ex. captioned program lists, weather forecasts, stock exchange topics, news for hearing-impaired....) on up to half of the TV screen. But not all stations offer text services, even though they might offer captioning.
In the event you are receiving a poor signal, an empty black box may appear and disappear, even when the text mode is selected. This is a normal when receiving a poor signal.
This TV is programmed to remember the **Caption/Text** mode it was last set to, when you turn the power off.



Selecting the setup function (To adjust the CAPTION & VCHIP function - US Only)

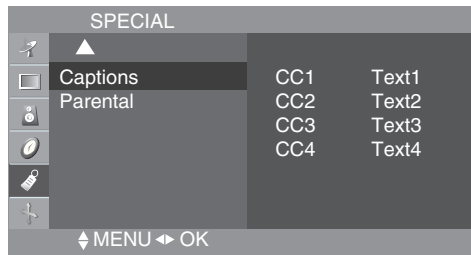

Caption (TV input only)

Use the ▼ ▲ buttons to select captions.

[Remote Control]

■ Press the CC button repeatedly to display the caption option as shown below. Press the enter button to select the caption option.

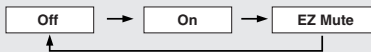

* EZ Mute

: If sound is on, the caption will be off. On the contrary, if sound is off, the caption will be on.

Parental

This function is used to block program viewing based on the ratings sent by the broadcast station. The default setting is to allow all programs to be viewed. Viewing can be blocked by the type of program and by the categories chosen to be blocked. It is also possible to block all program viewing for a time period.

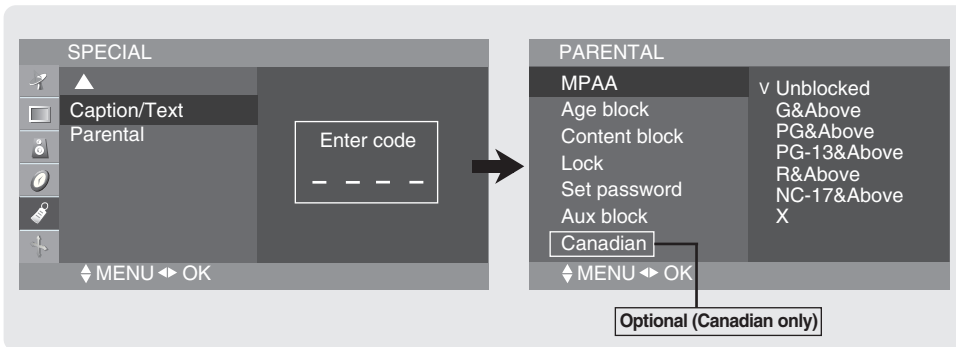

Select the **Parental** menu and click ► button. The 'Enter code' window will appear. Once the correct four-digit password is entered, sub-menu that allows a user to control various blocks will be enabled. The initial password is set for '0000' and it can be changed through 'Set password' menu.

PAGE A30

Selecting and Adjusting the Screen



Selecting the setup function

(To adjust the CAPTION & VCHIP function - US Only)

■ For movies previously shown in theaters.

PARENTAL	
MPAA	On
Age block	v Off
Content block	
Lock	
Set password	
Aux block	
Canadian	
◆ MENU ◀ OK	

MPAA

■ MOVIE Ratings :

- Unblocked
- G&above : General audience
- PG&above : Parental guidance suggested
- PG-13&above : 13 years and up
- R&above : Restricted
- NC-17&above : 17 years and up
- X : Adult

If you set PG-13&above, G and PG movies will be available : PG-13, R, NC-17, and X will be blocked.

PARENTAL	
MPAA	
Age block	Ent. code - - - -
Content block	Rep. code - - - -
Lock	
Set password	
Aux block	
Canadian	
◆ MENU ◀ OK	

Age block

■ GENERAL TV Rating :

- Unblocked
- TV-G&above : General audience / Individual categories do not apply.
- TV-PG&Above : Parental guidance suggested
- TV-14&Above : 14 years and up
- TV-MA : Mature audience

■ CHILDREN TV Rating :

- Unblocked
- TV-Y&Above : Youth / Individual content categories do not apply.
- TV-Y7 : Youth, 7 years and up.

PARENTAL	
MPAA	v Unblocked
Age block	G & above
Content block	PG & above
Lock	PG-13 & above
Set password	R & above
Aux block	NC-17 & above
Canadian	X
◆ MENU ◀ OK	

Content block

■ CONTENT Categories :

- Dialogue(sexual dialogue)
: Applies to TV-PG&above, TV-14.
- Language(adult language)
: Applies to TV-PG&above, TV-14&above, TV-MA.
- Sex (sexual situations)
: Applies to TV-PG&above, TV-14&above, TV-MA.
- Violence
: Applies to TV-PG&above, TV-14&above, TV-MA.
- F Violence(fantasy violence)
: Applies only to TV-Y7.



Selecting the setup function (To adjust the CAPTION & VCHIP function - US Only)

ENGLISH

■ V-CHIP rating and categories

- Rating guidelines are provided by broadcast station. Most television programs and television movies can be blocked by TV rating and/or individual categories. Movies that have been shown at the theaters or direct-to-video movies use the Movies Rating System(MPAA) only.

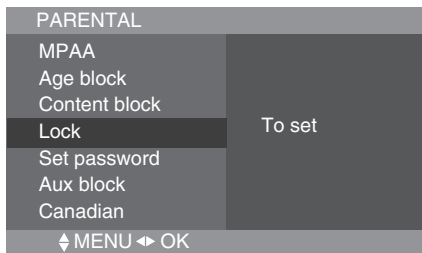

Lock On/Off

To select the VCHIP function On/Off.

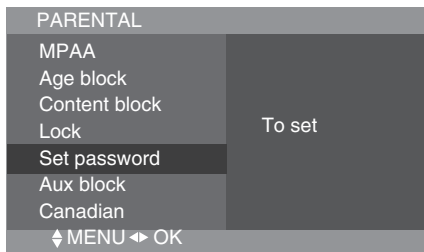

Set password

This menu is to be used to change password. Once the correct current password is entered using the number panel in a remote control, the window for new password will appear. Enter your choice of new four-digit password.

Setting a password

You control access to the parental controls with a password. The default password is '0000'. You can change the password to any four-digit number.

1. Open the OSD. -> Press the **▼▲** buttons to select the **Special** menu, then press the **▶** button to open the menu. -> Press the **▼▲** buttons to select the **Parental** sub-menu, then press the **▶** button to open the sub-menu.
2. Use the number pad to enter your password when prompted.
If you have not set a password, enter **0000**.
If you are unable to correct the problem yourself, contact the service center.
3. Press the **▼▲** buttons to select the **Set password** sub-menu, then press the **▶** button to change the setting. Use the number button pad to enter a new four-digit password when prompted.
4. Re-enter the new four-digit password when prompted.

Enter code

Ent. Code

Rep. Code

Selecting and Adjusting the Screen



Selecting the setup function (To adjust the CAPTION & VCHIP function - US Only)

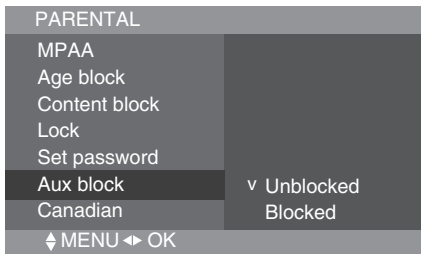

Aux.block

Enables you to select a source to block from the external source devices you have hooked up.



Selecting the setup function (To adjust the CAPTION & VCHIP function - Canadian Only)

■ V-CHIP rating and categories (Optional) - Canadian Rating System

- Rating guidelines are provided by broadcast station. Most television programs and television movies can be blocked by TV rating and/or individual categories.

Canadian

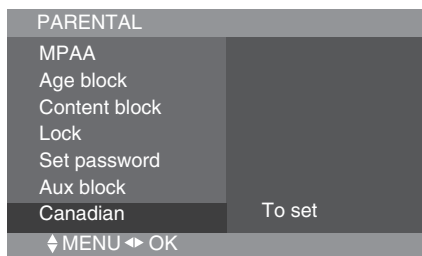

English

■ MOVIE Ratings :

- Unblocked
- C&Above : Under 8 years
- C8+ : 8 years and up
- G&Above : General audience
- PG&Above : Parental guidance suggested
- 14+ : 14 years and up
- 18+ : Adult

Français

■ MOVIE Ratings :

- Unblocked
- G&Above : General audience
- 8 ans + : 8 years and up
- 13 ans + : 13 years and up
- 16 ans + : 16 years and up
- 18 ans + : 18 years and up

Closed Captions - Optional

Closed captioning is a process which converts the audio portion of a television program into written words which then appear as subtitles on the television screen. Closed captions allow viewers to read the dialogue and narration of television programs.

Using Closed Captions

Captions are the subtitles of the dialogue and narration of television programs. For prerecorded programs, program dialogue can be arranged into captions in advance. It is possible to caption a live program by using a process called real-time captioning, which creates captions instantly. Real-time captioning is normally done by professional reporters using a machine shorthand system and computer for translation into English.

Captioning is an effective system for the hearing-impaired, and it can also aid in teaching language skills.

Caption Tips

1. Not all TV broadcasts include closed caption signals.
 2. Sometimes TV stations broadcasts four different caption signals on the same channel. By selecting **From CC1 ~ CC4, TEXT1 ~ TEXT4** you can choose which signal you view **CC1** is usually the signal with the captions, while **Another mode** might show demonstration or programming information.
 3. Your TV might not receive caption signals normally in the following situations.
 - Poor reception conditions are encountered :
 - **IGNITION** :
Picture may flutter, drift, suffer from black spots, or horizontal streaking. Usually caused by interference from automobile ignition systems, neon lamps, electrical drills, and other electrical appliances.
 - **GHOSTS** :
Ghosts are caused when the TV signal splits and follows two paths. One is the direct path and the other is reflected off tall buildings, hills or other objects. Changing the direction or position of the antenna may improve reception.
 - **SNOW** :
If your receiver is located at the weak, fringe area of a TV signal, your picture may be marred by small dots. It may be necessary to install a special antenna to improve the picture.
 - An old, bad or illegally recorded tape is playing.
 - Strong, random signals from a car or airplane interfere with the TV signal.
 - The signal from the antenna is weak.
 - The program wasn't captioned when it was produced, transmitted, or taped.
-

Selecting and Adjusting the Screen



Adjusting the screen function (RGB-PC, RGB-DTV only)

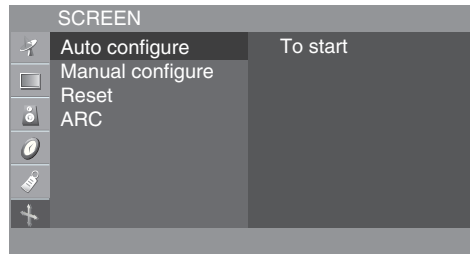

Auto configure

This button is for the automatic adjustment of the screen **Position**, **Clock** and **Phase**.

Manual configure

This button is for the manual adjustment of the screen **Position**, **Clock** and **Phase**.

- **H-Position**
To move image left or right.
- **V-Position**
To move image up or down.
- **Clock**
To minimize any vertical bars or stripes visible on the screen background.
The horizontal screen size will also change.
- **Phase**
To adjust the focus of the display. This item allows you to remove any horizontal noise and clear or sharpen the image of characters.

Reset

Use this function to reset the product to the factory default. However, language selection will not be initialized.

ARC

To select the image size of the screen.

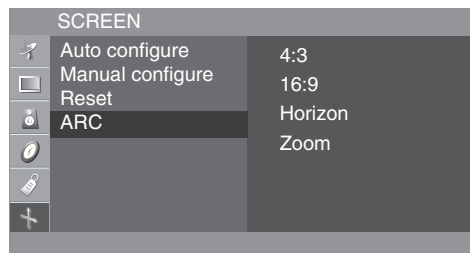

Troubleshooting

ENGLISH

No image is displayed

- Is the product power cord connected?
 - Does the power indicator is turned on?
 - Power is on, power indicator is blue but the screen appears extremely dark.
 - Does the power indicator look amber?
 - Does the 'Out of range' message appear?
 - Does the 'Check signal cable' message appear?
- See if the power cord is properly connected to the outlet.
 - See if the power switch is turned on.
 - Adjust brightness and contrast again.
 - If the product is in power saving mode, move the mouse or press any key.
 - The signal from the PC (video card) is out of the vertical or horizontal frequency range of the product. Adjust the frequency range by referring to the Specifications in this user's guide.
 - * **Maximum resolution**
 - 17 inch : 1280 x 1024 @60Hz
 - 19 inch : 1280 x 1024 @60Hz
 - The signal cable between PC and product is not connected. Check the signal cable.
 - Press the 'INPUT' button in the remote control to check the input signal.

'Unknown Product' message appears when the product is connected.

- Did you install the driver?
- Install the product driver, which is provided with the product, or download it from the web site. (<http://www.lge.com>)
 - See if the plug&play function is supported by referring to the video card user's guide.



Note

* **Vertical frequency:** To enable the user to watch the product display, screen image should be changed tens of times every second like a fluorescent lamp. The vertical frequency or refresh rate is the times of image display per second. The unit is Hz.

* **Horizontal frequency:** The horizontal interval is the time to display one vertical line. When the 1 is divided by horizontal interval, the number of horizontal lines displayed every second can be tabulated as the horizontal frequency. The unit is kHz.

Troubleshooting

The screen image looks abnormal.

- Is the screen position wrong?

If adjustment is not satisfactory, use the Position menu in OSD.

- See if the video card resolution and frequency are supported by the product. If the frequency is out of range, set to the recommended resolution in the Control Panel – Display – Setting menu.

- Do thin lines appear on the background screen?

If adjustment is not satisfactory, use the Clock menu in OSD.

- Horizontal noise appears or the characters look blurred.

If adjustment is not satisfactory, use the Phase menu in OSD.

After-image appears on the product.

- After-image appears when the product is turned off.

- If you use a fixed image for a long time, the pixels may be damaged quickly. Use the screensaver function.

The audio function does not work.

- **No sound?**
 - See if the audio cable is connected properly.
 - Adjust the volume.
 - See if the sound is set properly.
- **Sound is too low.**
 - Adjust the volume.

The TV function does not work.

- **The TV signal is not being received.**
 - See if you have selected the proper channel mode.
 - Use the automatic channel setup function.
 - See if the TV antenna is properly connected.

Screen colour is abnormal.

- **Screen has poor colour resolution (16 colours).**
 - Set the number of colours to more than 24 bits (true colour)
Select Control Panel – Display – Settings – Colour Table menu in Windows.
- **Screen colour is unstable or mono-coloured.**
 - Check the connection status of the signal cable.
Or, re-insert the PC video card.
- **Do black spots appear on the screen?**
 - Several pixels (red, green, white or black colour) may appear on the screen, which can be attributable to the unique characteristics of the LCD panel. It is not a malfunction of the LCD.

Specifications

The product specifications can change without prior notice for product improvement.

[17 inch]

LCD Panel	Screen Type	17 inches (43.27 cm) TFT (Thin Film Transistor) LCD (Liquid Crystal Display) Panel Visible diagonal size: 43.27 cm
	Pixel Pitch	0.264 mm
Video Signal	Max. Resolution	1280 X 1024 @60 Hz
	Recommended Resolution	1280 X 1024 @60 Hz
	Horizontal Frequency	30 - 70 kHz
	Vertical Frequency	56 - 75 Hz
	Synchronization Type	Separate
Input Connector		S-Video, Composite video, TV, D-Sub Analog, Headphone, PC Audio In
Power	Rated Voltage	AC 100-240V~ 50/60Hz 1.0A
	Power Consumption	On Mode : 40 W Sleep Mode ≤ 1 W Off Mode ≤ 1 W
Tilt	Tilt Range	3° ~ 25°
	Tilt Stand	Attached
	Swivel	345°
Dimension/Weight	Size (WxLxH)	389.5 mm x 232 mm x 437.9 mm
	Weight (excl. package)	5.28 kg (12.9 lbs)
Environmental Conditions	Operational Condition	Temperature: 10°C ~ 35°C , Humidity: 10% ~ 80%
	Storage Condition	Temperature: -20°C ~ 60°C , Humidity: 5% ~ 95%

The product specifications can change without prior notice for product improvement.

[19 inch]

LCD Panel	Screen Type	19 inches (48.18 cm) TFT (Thin Film Transistor) LCD (Liquid Crystal Display) Panel Visible diagonal size: 48.18 cm
	Pixel Pitch	0.294 mm
Video Signal	Max. Resolution	1280 X 1024 @60 Hz
	Recommended Resolution	1280 X 1024 @60 Hz
	Horizontal Frequency	30 - 70 kHz
	Vertical Frequency	56 - 75 Hz
	Synchronization Type	Separate
Input Connector		S-Video, Composite video, TV, D-Sub Analog Headphone, PC Audio In
Power	Rated Voltage	AC 100-240V~ 50/60Hz 1.0A
	Power Consumption	On Mode : 45 W Sleep Mode ≤ 1 W Off Mode ≤ 1 W
Tilt	Tilt Range	3° ~ 25°
	Tilt Stand	Attached
	Swivel	345°
Dimension/Weight	Size (WxLxH)	443.6 mm x 232.0 mm x 475.6 mm
	Weight (excl. package)	5.98 kg (14.7 lbs)
Environmental Conditions	Operational Condition	Temperature: 10°C ~ 35°C , Humidity: 10% ~ 80%
	Storage Condition	Temperature: -20°C ~ 60°C , Humidity: 5% ~ 95%

Specifications

● PC Mode – Preset Mode

[17 inch] [19 inch]

	Preset mode	Horizontal Frequency (kHz)	Vertical Frequency (Hz)		Preset mode	Horizontal Frequency (kHz)	Vertical Frequency (Hz)
1	VGA 640 x 350	31.469	70	8	VESA 1024 x 768	48.363	60
2	VGA 720 x 400	31.468	70	9	VESA 1024 x 768	60.123	75
3	VGA 640 x 480	31.469	59	10	MAC 1152 x 870	68.681	75
4	VESA 640 x 480	37.500	75	11	VESA 1152 x 900	61.805	65
5	VESA 800 x 600	37.879	60	12	VESA 1280 x 1024	63.981	60
6	VESA 800 x 600	46.875	75				
7	MAC 832 x 624	49.725	74				

● Power Indicator

Mode	Product
On Mode	Blue
Sleep Mode	Amber
Off Mode	Off

● Theft prevention locking device

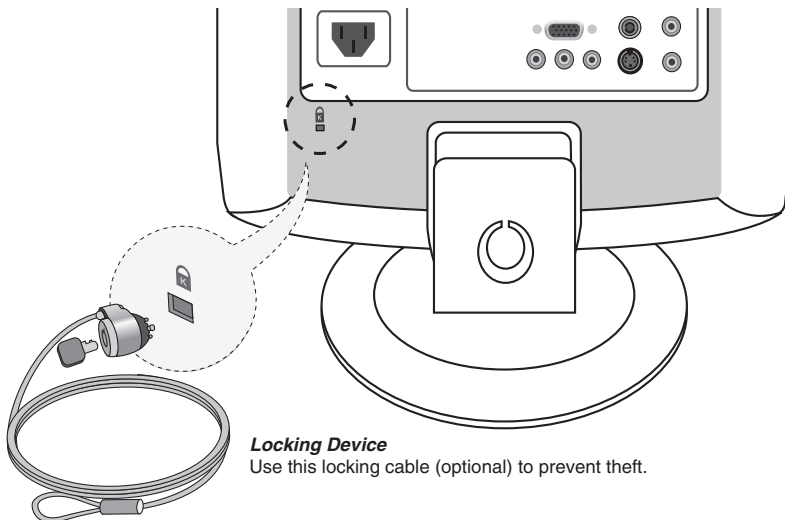

● VESA wall mounting

This product meets VESA-compliant mounting interface pad specifications.

1. Separate the Hinge Cover using a screwdriver as shown in the picture.

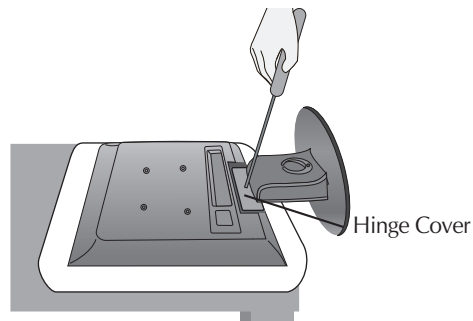

2. Please the product on a piece of cloth or other soft surface with the front side facing downward.
3. Separate the stand base using a screwdriver as shown in the picture.

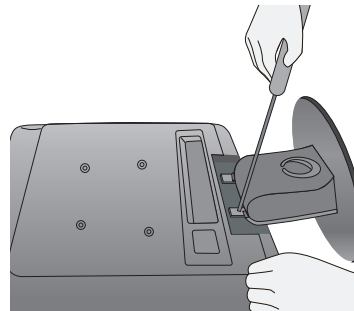

4. Install the VESA standrad wall mounting.

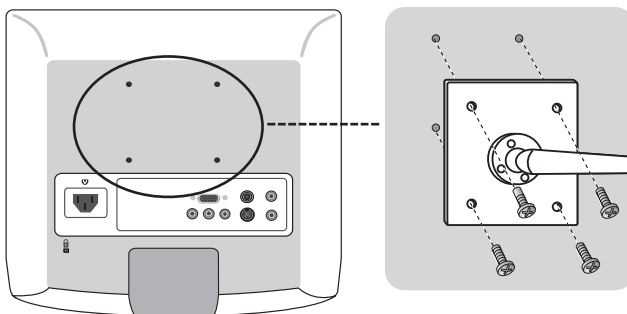

VESA wall mounting
 Connected to another object (stand type and wall-mounted type).
 This product accepts a VESA-compliant mounting interfacepad.(optional)
 For further information, refer to the VESA Wall Mounting Instruction Guide.



Regulatory information

Regulatory information

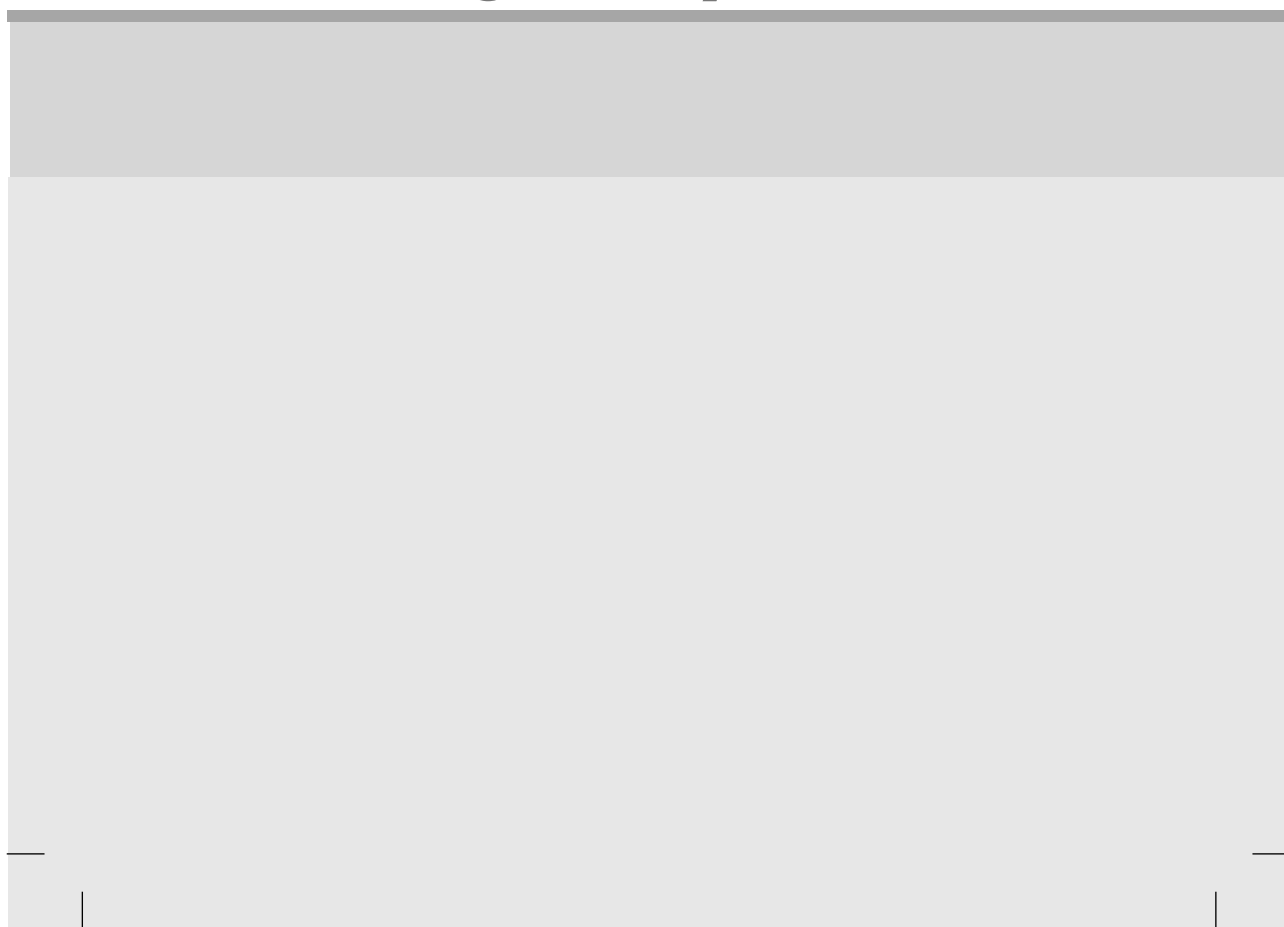

■ ■ ■ Regulatory Information cont.

:: FCC Compliance Statement

This equipment has been tested and found to comply within the limits of a Class B digital device pursuant to Part 15 of the FCC Rules. These limits are designed to provide reasonable protection against harmful interference in a residential installation.

This equipment generates, uses, and can radiate radio frequency energy and if not installed and used in accordance with the instructions, may cause harmful interference to radio communications. However, there is no guarantee that interference will not occur in a particular installation.

If this equipment does cause harmful interference to radio or television reception (which can be determined by turning the equipment on and off), the user is encouraged to try to correct the interference by using one or more of the following measures:

- Reorient or relocate the receiving antenna.
- Increase the separation between the equipment and the receiver.
- Connect the equipment into an outlet on a circuit different from that to which the receiver is connected.
- Consult the dealer or an experienced radio/TV technician for help.

Caution: Changes or modifications not expressly approved by the party responsible for compliance could void the user's (or your) authority to operate the equipment. Only peripherals (digital input/output devices, terminals, printers, etc.) certified to comply with the Class B limits may be attached to this monitor. Operation with non-certified peripherals is likely to result in interference to radio and TV reception. Only shielded signal cables may be used with this System.

NOTICE

The regulations are applied only to the products with the ID LABEL indicating specific requirements.

:: Canadian DOC Notice

This Class B digital apparatus meets all requirements of the Canadian Interference-Causing Equipment Regulations. Cet appareil numérique de la classe B

respecte toutes les exigences du Règlement sur le matériel brouilleur du Canada.

NOTICE

The regulations are applied only to the products with the ID LABEL indicating specific requirements.

:: CE Conformity Notice (for Europe)

Products with the "CE" Marking comply with the EMC Directive(89/336/EEC) and LOW VOLTAGE Directive (73/23/EEC) issued by the Commission of the European Community.

Compliance with these directives implies conformity to the following European Norms :

- EN 55022 ; Radio Frequency Interference
- EN 55024 ; Electromagnetic Immunity
- EN 61000-3-2 ; Power Line Harmonics
- EN 61000-3-3 ; Voltage Fluctuations

NOTICE

The regulations are applied only to the products with the ID LABEL indicating specific requirements.

:: Low Radiation Compliance (MPR II)

This monitor meets one of the strictest guidelines available today for low radiation emissions, offering the user extra shielding and an antistatic screen coating. These guidelines, set forth by a government agency in Sweden, limit the amount of emission allowed in the Extremely Low Frequency (ELF) and Very Low Frequency (VLF) electromagnetic range.

:: TCO95 (TCO95 applied model only)



Congratulations!

You have just purchased a TCO'95 approved and labelled product! Your choice has provided you with a product developed for professional use. Your purchase has also contributed to reducing the burden on the environment and to the further development of environmentally-adapted electronic products.

■ ■ ■ Regulatory Information cont.

Why do we have environmentally labelled computers?

In many countries, environmental labelling has become an established method for encouraging the adaptation of goods and services to the environment. The main problem as far as computers and other electronic equipment are concerned is that environmentally harmful substances are used both in the products and during their manufacture. Since it has not been possible so far for the majority of electronic equipment to be recycled in a satisfactory way, most of these potentially damaging substances sooner or later enter Nature.

There are also other characteristics of a computer, such as energy consumption levels, that are important from both the working and natural environment viewpoints. Since all types of conventional electricity generation have a negative effect on the environment (acidic- and climatic-influencing emissions, radioactive waste, etc.), it is vital to conserve energy. Electronic equipment in offices consumes an enormous amount of energy, since it is often routinely left running continuously.

What does the environmental labelling involve?

This product meets the requirements for the TCO'95 scheme, which provides for international environmental labelling of personal computers. The labelling scheme was developed as a joint effort by the TCO (The Swedish Confederation of Professional Employees), Naturkyddsforeningen (The Swedish Society for Nature Conservation), and NUTEK (The National Board for Industrial and Technical Development in Sweden), and SEMKO AB (an international certification agency).

The requirements cover a wide range of issues: environment, ergonomics, usability, emission of electrical and magnetic fields, energy consumption and electrical and fire safety.

The environmental demands concern, among other things, restriction on the presence and use of heavy metals, brominated and chlorinated flame retardants, CFCs (freons), and chlorinated solvents. The product must be prepared for recycling, and the manufacturer is obliged to have an environmental plan, which must be adhered to in each country where the company implements its operational policy.

The energy requirements include a demand that the

computer and/or display, after a certain period of inactivity, shall reduce its power consumption to a lower level, in one or more stages. The length of time to reactivate the computer shall be reasonable for the user.

Labelled products must meet strict environmental demands, for example, in respect of the reduction of electric and magnetic fields, along with physical and visual ergonomics and good usability.

The following is a brief summary of the environmental requirements met by this product. The complete environmental criteria document may be ordered from:

TCO Development Unit
Linnegatan 14, S-11494 Stockholm, Sweden
FAX +46-8 782 92 07
E-mail (Internet): development@tco.se

Current information regarding TCO'95 approved and labelled products may also be obtained on the Internet using the address: <http://www.tco-info.com/>

TCO'95 is a co-operative project between:



Naturkydds
foreningen



NUTEK

SEMKO

Närings- och teknikutvecklingsverket

Environmental requirements

Brominated flame retardants are present in printed circuit boards, cabling, casings, and housings, and are added to delay the spread of fire. Up to 30% of the plastic in a computer casing can consist of flame-retardant substances. These are related to another group of environmental toxins, PCBs, and are suspected of giving rise to similar harm, including reproductive damage in fish-eating birds and mammals. Flame retardants have been found in human blood, and researchers fear that they can disturb fetus development.

Bio-accumulative¹ TCO'95 demands require that plastic components weighing more than 25 grams must not contain flame retardants with organically bound chlorine or bromine.

Lead can be found in picture tubes, display screens, solder, and capacitors. Lead damages the nervous system and in higher doses causes lead poisoning. The

■ ■ ■ Regulatory Information cont.

relevant bio-accumulative TCO'95 requirement permits the inclusion of lead, as no replacement has yet been developed.

Cadmium is present in rechargeable batteries and in the color-generating layers of certain computer displays. Cadmium damages the nervous system and is toxic in high doses. The relevant bio-accumulative TCO'95 requirement states that batteries may not contain more than 25 ppm (parts per million) of cadmium. The color-generating layers of display screens must not contain any cadmium.

Mercury is sometimes found in batteries, relays and switches. Mercury damages the nervous system and is toxic in high doses. The relevant bio-accumulative TCO'95 requirement states that batteries may not contain more than 25 ppm of mercury and that no mercury is present in any of the electrical or electronic components concerned with the display unit.

CFCs (freons) are sometimes used for washing printed circuit boards and in the manufacture of expanded foam for packaging. CFCs break down ozone and thereby damage the ozone layer in the atmosphere, causing increased reception on Earth of ultra-violet light with consequent increased risks of skin cancer (malignant melanoma). The relevant TCO'95 requirement: Neither CFCs nor HCFCs may be used during the manufacture of the product or its packaging.

¹ Bio-accumulative means that the substance accumulates within living organisms.

Shipping Package

The packaging material can be recycled, or you can save it to return the monitor to a service center for repair or disposal.

CFC Compounds in Distribution Packaging

Cushioning material used for shipping finished monitors are not manufactured with nor do they contain any CFC compounds.

Design for Disassembly/Recycling

These monitors have been designed for easy end-of-life disassembly and recycling. Fasteners are generally of the same type for efficient disassembly. Components made of different materials can be easily separated and plastics have been identified using international symbols to aid in recycling.

Monitor Disposal

WARNING

If you need to dispose of a monitor, ask a qualified service representative for the proper procedure. Improper disposal could result in personal injury from implosion.

:: **TCO'99** (TCO'99 applied model only)



Congratulations!

You have just purchased a TCO'99 approved and labelled product! Your choice has provided you with a product developed for professional use. Your purchase has also contributed to reducing the burden on the environment and also to the further development of environmentally adapted electronics products.

Why do we have environmentally labelled computers?

In many countries, environmental labelling has become an established method for encouraging the adaptation of goods and services to the environment. With the growing manufacture and usage of electronic equipment throughout the world, there is a recognized concern for the materials and substances used by electronic products with regards to their eventual recycling and disposal. By proper selection of these materials and substances, the impact on the environment can be minimized.

There are also other characteristics of a computer, such as energy consumption levels, that are important from the viewpoints of both the work (internal) and natural (external) environments. Electronic equipment in offices is often left running continuously, resulting in unnecessary consumption of large amounts of energy and additional power generation. From the standpoint of carbon dioxide emissions alone, it is vital to save energy.

What does labelling involve?

The product meets the requirements for the TCO'99 scheme which provides for international and environmental labelling of personal computers and/or displays.

The labelling scheme was developed as a joint effort by the TCO (The Swedish Confederation of Professional Employees), Svenska Naturskyddsforeningen (The Swedish Society for Nature Conservation) and Statens Energimyndighet (The Swedish National Energy Administration).

■■■ Regulatory Information cont.

Approval requirements cover a wide range of issues: ecology, ergonomics, emission of electrical and magnetical fields, energy consumption and electrical safety.

Ecological criteria impose restrictions on the presence and use of heavy metals, brominated and chlorinated flame retardants, and other substances. The product must be prepared for recycling and the manufacturing site(s) shall be certified according to ISO14001 or EMAS registered.

Energy requirements include a demand that the system unit and/or display, after a certain period of inactivity, shall reduce its power consumption to a lower level in one or more stages. The length of time to reactivate the system unit shall be reasonable for the user.

Labelled products must meet strict environmental demands, for example, in respect of the reduction of electrical and magnetical fields as well as work load and visual ergonomics.

Below you will find a brief summary of the ecological requirements met by this product. The complete ecological criteria document can be found at TCO Development's website <http://www.tcodevelopment.com> or may be ordered from:

TCO Development
SE-114 94 STOCKHOLM, Sweden
Fax: +46 8 782 92 07
Email : development@tco.se
Information regarding TCO'99 approved and labelled products may also be obtained at <http://www.tcodevelopment.com>

Ecological requirements

Flame retardants

Flame retardants may be present in printed wiring board laminates, cables, and housings. Their purpose is to prevent, or at least to delay the spread of fire. Up to 30% by weight of the plastic in a computer casing can consist of flame retardant substances. Many flame retardants contain bromine or chlorine, and these flame retardants are chemically related to PCBs (polychlorinated biphenyls). Both the flame retardants containing bromine or chlorine and the PCBs are suspected of giving rise to health effects, including reproductive damage in fish-eating birds and mammals, due to the bio-accumulative* processes when not disposed of in accordance with strict standards for disposal.

TCO'99 requires that plastic components weighing more than 25 grams shall not contain flame retardants with organically bound bromine or chlorine. Flame retardants are allowed in the printed wiring board laminates due to the lack of commercially available alternatives.

Cadmium**

Cadmium is present in rechargeable batteries and in the colour-generating layers of certain computer displays. TCO'99 requires that batteries, the colour-generating layers of display screens, and the electrical or electronics components shall not contain any cadmium.

Mercury**

Mercury is sometimes found in batteries, relays and switches. TCO'99 requires that batteries shall not contain any mercury. It also demands that mercury is not present in any of the electrical or electronics components associated with the labelled unit. There is however one exception. Mercury is, for the time being, permitted in the back light system of flat panel monitors as there today is no commercially available alternative. TCO aims on removing this exception when a mercury free alternative is available.

Lead**

Lead can be found in picture tubes, display screens, solders and capacitors. TCO'99 permits the use of lead due to the lack of commercially available alternatives, but in future requirements TCO Development aims at restricting the use of lead.

* Bio-accumulative is defined as substances which accumulate in living organisms.

**Lead, Cadmium and Mercury are heavy metals which are bio-accumulative.

■■■ Regulatory Information cont.

:: **TCO'03** (TCO'03 applied model only)



Congratulations!

The display you have just purchased carries the TCO'03 Displays label.

This means that your display is designed, manufactured and tested according to some of the strictest quality and environmental requirements in the world. This makes for a high performance product, designed with the user in focus that also minimizes the impact on our natural environment. Some of the features of the TCO'03 Display requirements:

Ergonomics

- Good visual ergonomics and image quality in order to improve the working environment for the user and to reduce sight and strain problems. Important parameters are luminance, contrast, resolution, reflectance, colour rendition and image stability.

Energy

- Energy-saving mode after a certain time – beneficial both for the user and the environment
- Electrical safety

Emissions

- Electromagnetic fields
- Noise emissions

Ecology

- The product must be prepared for recycling and the manufacturer must have a certified environmental management system such as EMAS or ISO 14 001
- Restrictions on
 - chlorinated and brominated flame retardants and polymers
 - heavy metals such as cadmium, mercury and lead.

The requirements included in this label have been developed by TCO Development in co-operation with scientists, experts, users as well as manufacturers all over the world. Since the end of the 1980s TCO has been involved in influencing the development of IT equipment in a more user-friendly direction. Our labelling system started

with displays in 1992 and is now requested by users and IT-manufacturers all over the world.

For more information, please visit
www.tcodevelopment.com

English

Information for Environmental Preservation

LGE. announced the 'LG Declaration for a Cleaner Environment' in 1994, and this ideal has served as a guiding managerial principle ever since. The Declaration is a foundation that has allowed us to undertake environmentally friendly activities in careful consideration of economic, environmental, and social aspects.

We promote activities for environmental preservation, and we specifically develop our products to embrace the concept of environment-friendly.

We minimize the hazardous materials contained in our products. For example, there is no cadmium to be found in our monitors.

Information for recycling

This monitor may contain parts which could be hazardous to the environment. It is important that this monitor be recycled after use.

LGE. handles all waste monitors through an environmentally acceptable recycling method. There are several take-back and recycling systems currently in operation worldwide. Many parts will be reused and recycled, while harmful substances and heavy metals are treated by an environmentally friendly method.

If you want to find out more information about our recycling program, please contact your local LG vendor or a corporate representative of LG.

We set our vision and policies on a cleaner world by selecting the issue of the global environment as a task for corporate improvement. Please visit our website for more information about our 'green' policies.

http://www.lge.com/experience/social_commitment/environment.jsp

■ ■ ■ Regulatory Information cont.

■ ■ ■ Deutsch

Informationen zur Erhaltung der Umwelt

Im Jahr 1994 verkündete LGE die 'LG Declaration for a Cleaner Environment' (LG Erklärung für eine sauberere Umwelt). Seitdem dient dieses Ideal als führendes Prinzip des Unternehmens. Diese Erklärung war die Basis für die Durchführung von

umweltfreundlichen Aktivitäten, wobei wirtschaftliche, umweltbezogene und soziale Aspekte in die Überlegungen mit einbezogen wurden.

Wir fördern Aktivitäten zum Schutz der Umwelt und die Entwicklung unserer Produkte ist darauf ausgerichtet, unserem Konzept bezüglich Umweltfreundlichkeit gerecht zu werden.

Wir sind darauf bedacht, den Anteil der in unseren Produkten enthaltenen schädlichen Materialien zu minimieren. So ist in unseren Monitoren beispielsweise kein Kadmium zu finden.

Informationen zum Thema Recycling

Dieser Monitor enthält Teile, die umweltschädlich sein können. Es ist unbedingt erforderlich, dass der Monitor recycelt wird, nachdem er außer Dienst gestellt wurde.

Bei LGE werden alle ausrangierten Monitore in einem unter umweltbezogenen Aspekten geeigneten Verfahren recycelt. Augenblicklich sind weltweit mehrere Rücknahme- und Recyclingsysteme im Einsatz. Viele Teile werden wieder verwendet und recycelt. Schädliche Substanzen und Schwermetalle werden durch umweltverträgliche Verfahren behandelt.

Falls Sie mehr über unser Recyclingprogramm erfahren möchten, wenden Sie sich bitte an Ihren lokalen LG-Händler oder einen Unternehmensvertreter von LG.

Wir richten unsere Firmenpolitik auf eine sauberere Umwelt hin aus, indem wir umweltspezifische Aspekte als wichtigen Punkt in die Weiterentwicklung unseres Unternehmens einfließen lassen. Zusätzliche Informationen über unsere 'grüne' Firmenpolitik erhalten Sie auf unserer Website.

http://www.lge.com/experience/social_commitment/environment.jsp

■ ■ ■ Français

Information sur la protection de l'environnement

LGE a publié sa 'Déclaration en faveur d'un

environnement plus propre' en 1994 et celle-ci est restée, depuis lors, un principe directeur de notre entreprise. Cette déclaration a servi de base à notre réflexion et nous a permis de prendre en compte à la fois les aspects économiques et sociaux de nos activités, tout en respectant l'environnement.

Nous encourageons les activités en faveur de la préservation de l'environnement et c'est dans cet esprit que nous développons nos produits : nous réduisons au minimum les matières dangereuses qui entrent dans leur composition et l'on ne trouve pas de cadmium, par exemple, dans nos moniteurs.

Information sur le recyclage

Ce moniteur peut contenir des composants qui présentent un risque pour l'environnement. Il est donc important que celui-ci soit recyclé après usage.

LGE traite les moniteurs en fin de cycle conformément à une méthode de recyclage respectueuse de l'environnement. Nous reprenons nos produits et les recyclons dans plusieurs sites répartis dans le monde entier. De nombreux composants sont réutilisés et recyclés, et les matières dangereuses, ainsi que les métaux lourds, sont traités selon un procédé écologique.

Si vous souhaitez plus de renseignements sur notre programme de recyclage, veuillez contacter votre revendeur LG ou un l'un de nos représentants.

Nous voulons agir pour un monde plus propre et croyons au rôle de notre entreprise dans l'amélioration de l'environnement. Pour plus de renseignements sur notre politique "verte", rendez visite à notre site :

http://www.lge.com/experience/social_commitment/environment.jsp

■ ■ ■ Italiano

Informazioni per la tutela dell'ambiente

La LGE ha annunciato nel 1994 la cosiddetta 'LG Declaration for a Cleaner Environment' (Dichiarazione di LG a favore di un ambiente più pulito), un ideale che da allora funge da principio ispiratore della gestione aziendale. La dichiarazione rappresenta il fondamento che consente di intraprendere attività a favore dell'ambiente tenendo conto degli aspetti economici, ambientali e sociali.

■■■ Regulatory Information cont.

Noi della LG, promuoviamo attività a favore della tutela dell'ambiente sviluppando appositamente i nostri prodotti per cogliere il concetto del rispetto dell'ambiente riducendo i materiali dannosi presenti nei nostri prodotti. Ad esempio nei nostri monitor non è presente il cadmio.

Informazioni per il riciclaggio

Il monitor può presentare componenti che potrebbero risultare eventualmente dannosi per l'ambiente. È importante che il monitor sia riciclato al termine del suo utilizzo.

La LGE gestisce tutti i monitor di rifiuto con un metodo di riciclaggio soddisfacente dal punto di vista ambientale. In tutto il mondo sono attualmente in funzione numerosi sistemi di riciclaggio e recupero. I diversi componenti sono riutilizzati e riciclati, mentre le sostanze dannose e i metalli pesanti vengono trattati con un metodo rispettoso dell'ambiente.

Se si desiderano maggiori informazioni in merito al programma di riciclaggio, è consigliabile rivolgersi al proprio rivenditore LG o ad un rappresentante aziendale della LG.

Noi della LG impostiamo la nostra visione e le nostre politiche a favore di un mondo più pulito ponendo la questione dell'ambiente dal punto di vista globale come una mansione rivolta al miglioramento della nostra azienda. Vi invitiamo a visitare il nostro sito internet per ulteriori informazioni sulla nostra politica "verde".

http://www.lge.com/experience/social_commitment/enviro ment.jsp

■■■ Español

Información para la conservación medioambiental

LGE. presentó la 'Declaración para un entorno más limpio de LG' en 1994 y este ideal ha servido para guiar nuestros principios empresariales desde entonces. La Declaración es la base que nos ha permitido llevar a cabo tareas que respetan el medio ambiente siempre teniendo en cuenta aspectos sociales, económicos y medioambientales.

Promocionamos actividades orientadas a la conservación del medio ambiente y desarrollamos nuestros productos específicamente para que se ajusten a la filosofía que protege el entorno.

Reducimos al máximo el uso de materiales de riesgo en nuestros productos. Un ejemplo de ello es la ausencia total de cadmio en nuestros monitores.

Información para el reciclaje

Este monitor puede contener piezas que entrañen riesgos medioambientales. Es importante reciclar este monitor después de su utilización.

LGE. trata todos los monitores usados siguiendo un método de reciclaje que no daña al entorno. Contamos con diversos sistemas de recuperación y reciclaje que funcionan a nivel mundial en la actualidad. Es posible reciclar y reutilizar muchas de las piezas, mientras que las sustancias dañinas y los metales pesados se tratan siguiendo un método que no perjudique al medio ambiente. Si desea obtener más información acerca del programa de reciclaje, póngase en contacto con su proveedor local de LG o con un representante empresarial de nuestra marca.

Basamos nuestra visión y nuestras políticas en un mundo más limpio y para ellos optamos por un entorno global como tarea principal de nuestra evolución como empresa. Visite nuestra página Web para obtener más información sobre nuestras políticas ecológicas.

http://www.lge.com/experience/social_commitment/enviro ment.jsp

■■■ Português

Informações relacionadas à preservação ambiental

A LGE. anunciou a 'LG Declaration for a Cleaner Environment' (Declaração da LG para um ambiente mais limpo) em 1994 e esse ideal tem servido desde então como um princípio administrativo de orientação. A Declaração é a base que nos tem permitido realizar atividades favoráveis ao ambiente com consideração atenta aos aspectos econômicos, ambientais e sociais.

Promovemos atividades de preservação ambiental e desenvolvemos nossos produtos para englobar especificamente o conceito de favorável ao ambiente.

Reduzimos os materiais perigosos contidos em nossos produtos. Por exemplo, não há cádmio em nossos monitores.

Regulatory Information cont.

Informações relacionadas à reciclagem

Este monitor pode conter peças que podem representar riscos ao ambiente. É importante que ele seja reciclado após o uso.

A LGE cuida de todos os monitores descartados através de um método de reciclagem agradável ao ambiente. Há vários sistemas de devolução e reciclagem atualmente em operação no mundo. Muitas peças serão reutilizadas e recicladas e as substâncias nocivas e os metais pesados passarão por tratamento através de um método favorável ao ambiente.

Para obter mais informações sobre nosso programa de reciclagem, entre em contato com seu fornecedor LG local ou com um representante corporativo da LG.

Definimos nossa visão e nossas políticas relacionadas a um mundo mais limpo selecionando a questão do ambiente global como uma tarefa de aprimoramento corporativo. Visite nosso site para obter mais informações sobre nossas políticas de meio ambiente.

http://www.lge.com/experience/social_commitment/environment.jsp

Nederlands

Informatie met betrekking tot het behoud van het milieu

LGE publiceerde in 1994 de 'LG Declaration for a Cleaner Environment' (de LG-verklaring met betrekking tot een schoner milieu). Deze verklaring en het ideaal van een schoner milieu fungeren sindsdien als een bestuurlijke leidraad voor onze onderneming. Op basis van deze verklaring ontplooiën wij milieuvriendelijke activiteiten, waarbij er zowel met sociale en economische aspecten, als met milieuaspecten zorgvuldig rekening wordt gehouden.

Wij ondersteunen activiteiten die zijn gericht op het behoud van het milieu en wij houden bij het ontwikkelen onze producten specifiek rekening met de milieuvriendelijkheid van onze producten.

Wij minimaliseren het gebruik van schadelijke stoffen in onze producten. Er wordt bijvoorbeeld geen cadmium verwerkt in onze monitors.

Informatie met betrekking tot recycling

Deze monitor bevat materialen die schadelijk zouden kunnen zijn voor het milieu. Het is belangrijk dat deze

monitor aan het einde van zijn levensduur wordt gerecycled.

LGE verwerkt alle afvalmonitors via een milieuvriendelijke recyclingmethode. Hiervoor worden er momenteel wereldwijd verscheidene inname- en recyclingsystemen gehanteerd. Een groot aantal onderdelen wordt opnieuw gebruikt en gerecycled, waarbij schadelijke stoffen en zware metalen volgens een milieuvriendelijke methode worden verwerkt.

Voor meer informatie over ons recyclingprogramma kunt u contact opnemen met uw plaatselijke LG-vertegenwoordiger of een LG-vestiging.

Onze visie en ons beleid met betrekking tot een schonere wereld vloeien voort uit het feit dat wij het milieu hebben aangemerkt als een onderwerp dat speciale aandacht verdient binnen onze onderneming. Bezoek onze website voor meer informatie over ons 'groene' beleid.

http://www.lge.com/experience/social_commitment/environment.jsp

Russian

Информация по охране окружающей среды

В 1994 году корпорация LGE опубликовала 'Декларацию LG по охране окружающей среды', которая с тех пор служит основным принципом управления. На основе этой декларации мы смогли предпринять действия, обеспечивающие безопасность окружающей среды, уделяя при этом должное внимание экономическим, экологическим и социальным аспектам.

Мы стимулируем деятельность по охране окружающей среды, уделяя особое внимание разработке нашей продукции в соответствии с концепцией экологической безопасности.

Мы сводим к минимуму содержание опасных веществ в нашей продукции. Например, в наших мониторах вы не найдете кадмия.

Информация по утилизации отходов

Этот монитор может содержать компоненты, которые могут нанести ущерб окружающей среде.

Необходимо утилизировать монитор после использования.

■■■ Regulatory Information cont.

Корпорация LGE перерабатывает все бракованные мониторы с помощью экологически приемлемого метода утилизации отходов. По всему миру действуют системы утилизации отходов и возврата использованной продукции. Многие компоненты будут вторично использованы и утилизированы, в то время как вредные вещества и тяжелые металлы будут обработаны с помощью экологически приемлемого метода.

За более подробной информацией по нашей программе утилизации отходов обращайтесь к местному поставщику или представителю корпорации LG.

Мы ориентируемся на обеспечение экологической безопасности, ставя себе целью глобальную защиту окружающей среды. Дополнительную информацию о нашей политике по охране окружающей среды вы можете найти на нашем сайте:

http://www.lge.com/experience/social_commitment/environment.jsp

한국어

LG 1994 LG

LG

LG

가 가

LG

LG

LG

가

<http://www.lge.co.kr/about/digitalg/environment/environment.jsp>

:: **EPA (U.S.A only)** (EPA applied model only)

ENERGYSTAR is a set of power-saving guidelines issued by the U.S. Environmental Protection Agency(EPA).



As an ENERGY STAR Partner LGE U. S. A.,Inc. has determined that this product meets the ENERGY STAR guidelines for energy efficiency.

:: **NOM MARK (Mexico only)**

