

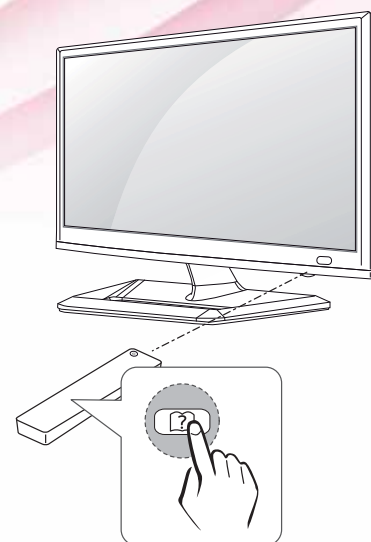

APPENDIX G
: USER'S MANUAL



OWNER'S MANUAL

CINEMA 3D TV / LED LCD TV

Please read this manual carefully before operating the your TV and retain it for future reference.

CINEMA 3D TV MODEL

DM2352D DM2352T

DM2752D DM2752T

LED LCD TV MODEL

M2252D M2252T

M2352D M2352T

M2452D M2452T

M2752D M2752T

TABLE OF CONTENTS

3 LICENSES

4 INSTALLATION PROCEDURE

5 ASSEMBLING AND PREPARING

- 5 Unpacking
- 8 - Separate purchase
- 9 Parts and buttons
- 10 Lifting and moving the TV
- 11 Setting up the TV
 - 11 - Attaching the Stand
 - 15 - Mounting on a table
 - 16 - Tidying cables
 - 17 - Detaching the Stand
 - 19 - Mounting on a wall

21 WATCHING TV

- 21 Turning the TV on for the first time

23 MAKING CONNECTIONS

- 23 Connecting an antenna
- 24 Connecting to a HD receiver, DVD, VCR player or Gaming device
 - 24 - HDMI connection
 - 25 - HDMI to DVI connection
 - 26 - Component connection
 - 27 - Composite connection
 - 28 - Euro Scart connection
- 29 Connecting to an audio system
 - 29 - Headphone connection
- 30 Connecting to a USB
- 30 Connecting to a CI Module
- 31 Connecting to a wired network
- 32 Connecting to a PC
 - 33 - HDMI connection
 - 34 - HDMI to DVI connection
 - 35 - RGB connection

36 REMOTE CONTROL

39 CUSTOMIZING SETTINGS

- 39 Accessing main menus

40 USING THE USER GUIDE

- 40 Accessing User Guide menu.
 - 40 - Using the TV menu
 - 40 - Using the Remote Control

41 3D IMAGING (ONLY CINEMA 3D TV)

- 41 3D Technology

42 MAINTENANCE

- 42 Cleaning Your TV
 - 42 Screen and frame
 - 42 Cabinet and stand
 - 42 Power cord
- 43 Preventing "Image burn" or "Burn-in" on your TV screen

44 TROUBLESHOOTING

- 44 General
- 44 Using 3D mode

45 SPECIFICATIONS

LICENSES

Supported licenses may differ by model. For more information of the licenses, visit www.lg.com.



Manufactured under license from Dolby Laboratories. "Dolby" and the double-D symbol are trademarks of Dolby Laboratories.



HDMI, the HDMI logo and High-Definition Multimedia Interface are trademarks or registered trademarks of HDMI Licensing LLC.



ABOUT DIVX VIDEO: DivX® is a digital video format created by DivX, LLC, a subsidiary of Rovi Corporation. This is an official DivX Certified® device that plays DivX video. Visit divx.com for more information and software tools to convert your files into DivX videos.

ABOUT DIVX VIDEO-ON-DEMAND: This DivX Certified® device must be registered in order to play purchased DivX Video-on-Demand (VOD) movies. To obtain your registration code, locate the DivX VOD section in your device setup menu. Go to vod.divx.com for more information on how to complete your registration.

DivX Certified® to play DivX® video up to HD 1080p, including premium content.

DivX®, DivX Certified® and associated logos are trademarks of Rovi Corporation or its subsidiaries and are used under license.

Covered by one or more of the following U.S. patents: 7,295,673; 7,460,668; 7,515,710; 7,519,274

INSTALLATION PROCEDURE

- 1 Open the package and make sure all the accessories are included.
- 2 Attach the stand to the TV.
- 3 Connect an external device to the TV.



NOTE

- Image shown may differ from your TV.
- Your TV's OSD (On Screen Display) may differ slightly from that shown in this manual.
- The available menus and options may differ from the input source or product model that you are using.
- New features may be added to this TV in the future.

ASSEMBLING AND PREPARING

Unpacking

Check your product box for the following items. If there are any missing accessories, contact the local dealer where you purchased your product. The illustrations in this manual may differ from the actual product and accessories.

! NOTE

- The accessories supplied with your product may vary depending on the model.
- Product specifications or contents in this manual may be changed without prior notice due to upgrade of product functions.



CAUTION

- Do not use any pirated items to ensure the safety and product life span.
- Any damages or injuries by using pirated items are not covered by the warranty.

! NOTE

- The items supplied with your product may vary depending on the model.
- Product specifications or contents of this manual may be changed without prior notice due to upgrade of product functions.
- For an optimal connection, HDMI cables and USB devices should have bezels less than 10 mm thick and 18 mm width. Use an extension cable that supports USB 2.0 if the USB cable or USB memory stick does not fit into your TV's USB port.

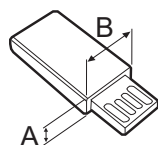
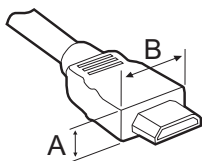

*A  10 mm

*B  18 mm

M2252D

M2352D

M2452D

M2752D

M2252T

M2352T

M2452T

M2752T

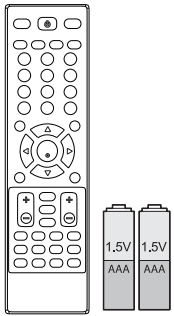

**Remote control.
Batteries (AAA).**

(See p.36, 38)



**CD (Owner's Manual).
Cards.**

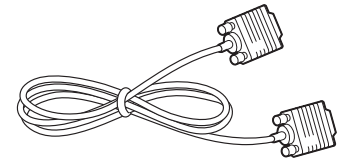

RGB Cable.

(See p.35)

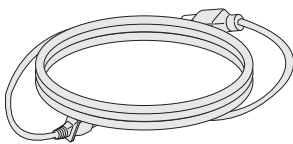

Power Cord.

(See p.15)

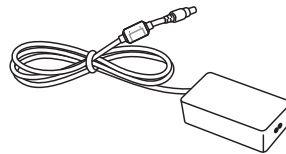

AC-DC Adapter.

(See p.15)



Cable Tie.

(See p.16)

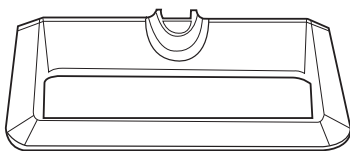

Stand Base.

- M2252D, M2352D, M2452D,
M2252T, M2352T, M2452T:

See p.11, 17

- M2752D, M2752T:

See p.13, 18

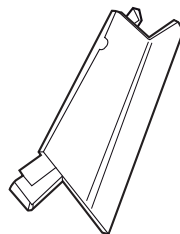

Stand Body. (Only M2252D /
M2352D / M2452D / M2252T
/ M2352T / M2452T model)

(See p.11, 17)

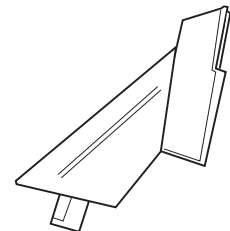

Stand Body. (Only M2752D
/ M2752T model)

(See p.13, 18)

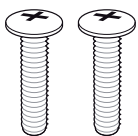

Screws for Assembly.

2 EA (Only M2752D /
M2752T model)

(See p.13, 18)

DM2352D

DM2752D

DM2352T

DM2752T

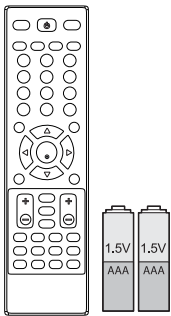

**Remote control.
Batteries (AAA).**

(See p.37, 38)

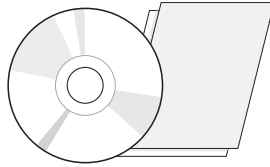

**CD (Owner's Manual).
Cards.**

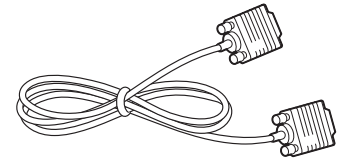

RGB Cable.

(See p.35)

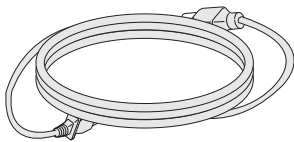

Power Cord.

(See p.15)

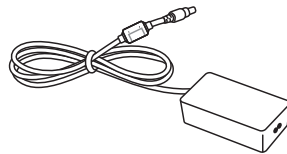

AC-DC Adapter.

(See p.15)



Cable Tie.

(See p.16)

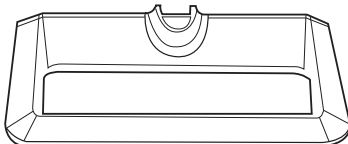

Stand Base.

- DM2352D, DM2352T:

See p.11, 17

- DM2752D, DM2752T:

See p.13, 18

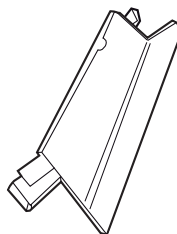

Stand Body. (Only DM2352D /
DM2352T model)

(See p.11, 17)

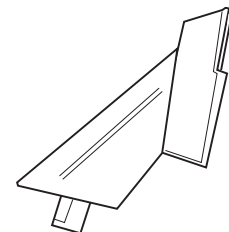

Stand Body. (Only DM2752D
/ DM2752T model)

(See p.13, 18)

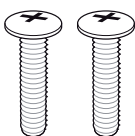

**Screws for Assembly.
2 EA** (Only DM2752D /
DM2752T model)

(See p.13, 18)

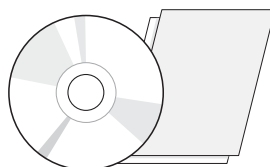

**TriDef 3D Game Software CD /
Quick Installation Guide**

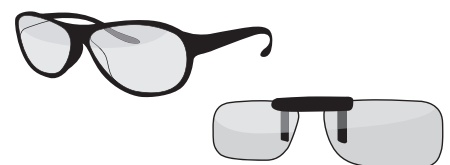

3D Glasses (Normal type / Clip type)

- The number of 3D glasses may differ depending on the model or country.

- Image shown may differ from your TV.

(See p.13, 18)

Separate purchase



Dual play glasses

AG-F2**DP, AG-F3**DP



NOTE

- The illustrations in this manual may differ from the actual product and accessories.
- Separate purchase items can be changed or modified for quality improvement without any notification.
- Contact your dealer to buying these items.
- The model name or design may be changed depending on the upgrade of product functions, manufacturer's circumstances or policies.

Parts and buttons

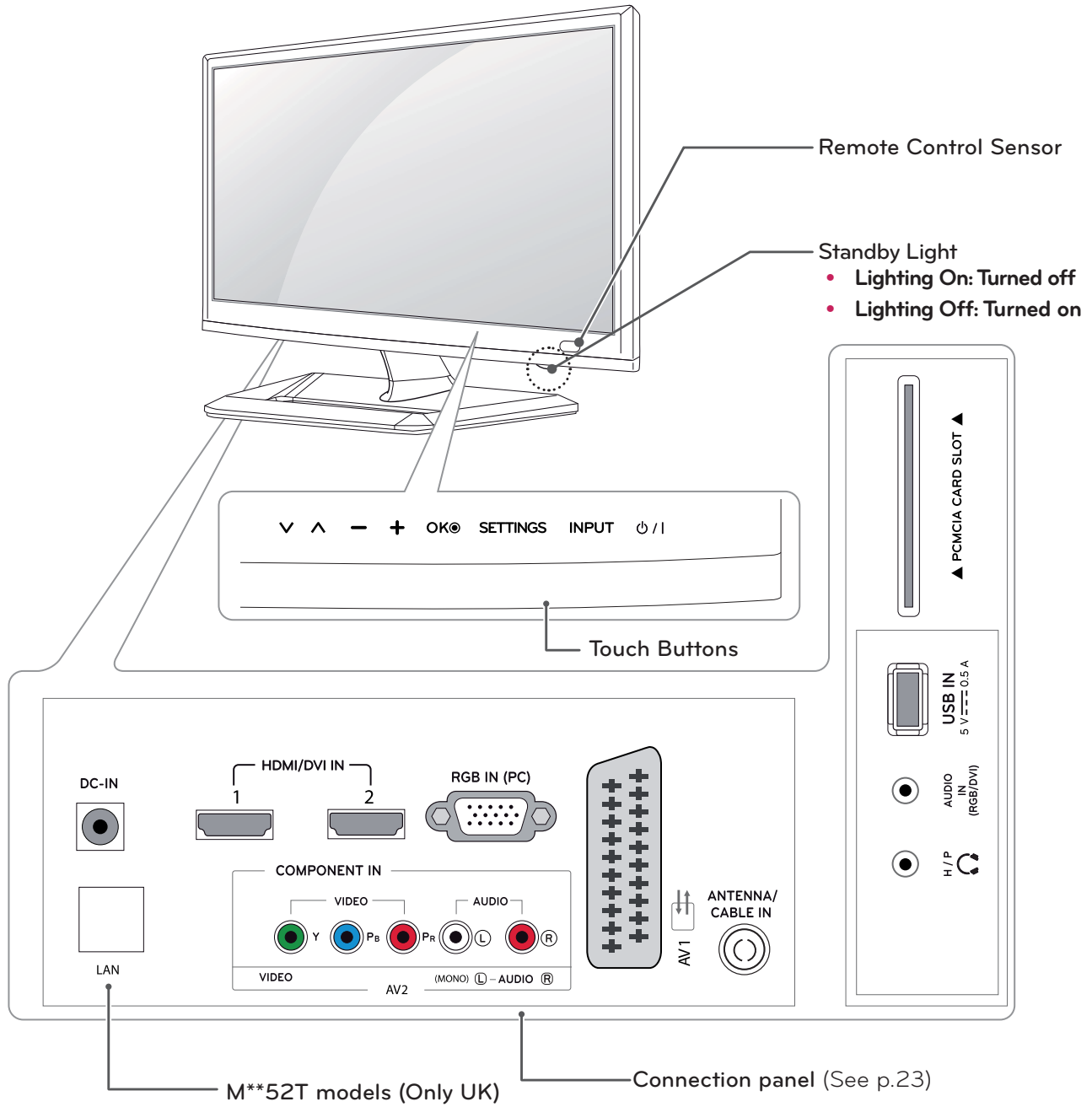

| Touch button | Description |
|--------------|---|
| ∨ ∨ | Scrolls through the saved programmes. |
| - + | Adjusts the volume level. |
| OK | Selects the highlighted menu option or confirms an input. |
| SETTINGS | Accesses the main menus, or saves your input and exits the menus. |
| INPUT | Changes the input source. |
| ⏻ / I | Turns the power on or off. |

NOTE

All of the buttons are touch sensitive and can be operated through simple touch with your finger.

Lifting and moving the TV

When moving or lifting the TV, read the following to prevent the TV from being scratched or damaged and for safe transportation regardless of its type and size.



CAUTION

Avoid touching the screen at all times, as this may result in damage to the screen or some of the pixels used to create images.

- It is recommended to move the TV in the box or packing material that the TV originally came in.
- Before moving or lifting the TV, disconnect the power cord and all cables.
- Hold the top and bottom of the TV frame firmly. Make sure not to hold the transparent part, speaker, or speaker grill area.

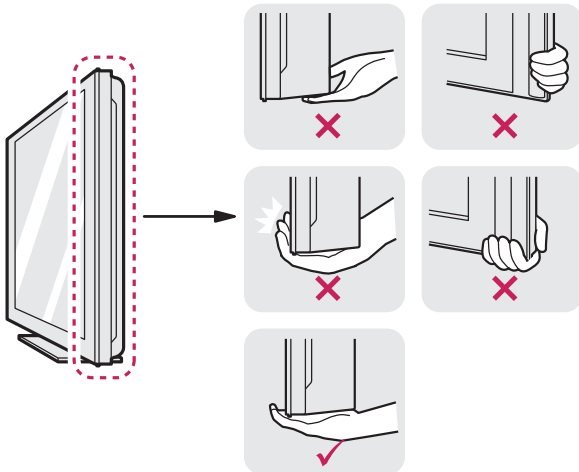

- When holding the TV, the screen should face away from you to prevent the screen from scratches.



- When transporting the TV, do not expose the TV to jolts or excessive vibration.
- When transporting the TV, keep the TV upright, never turn the TV on its side, or tilt towards the left or right.

Setting up the TV

M2252D

M2352D

M2452D

M2252T

M2352T

M2452T

DM2352D

DM2352T

Attaching the Stand

If you are not mounting the TV to a wall, use the following instructions to attach the stand.

- 1 Place the TV with the screen side down on a flat and cushioned surface.

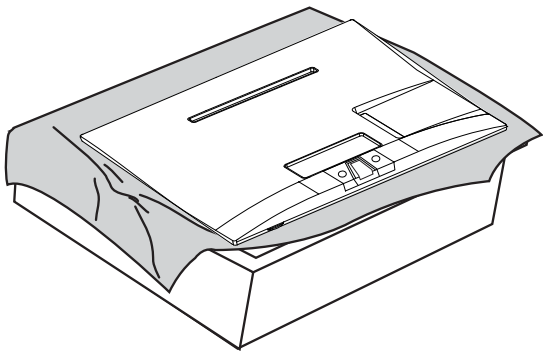

CAUTION

- Lay a foam mat or soft protective cloth on the surface to protect the screen from damage.
- When attaching the stand to the TV, place the screen facing down on a cushioned table or flat surface to protect the screen from scratches.

- 3 Attach the **Stand Base** from the **Stand Body** by turning the screw to the right with a **Coin**.

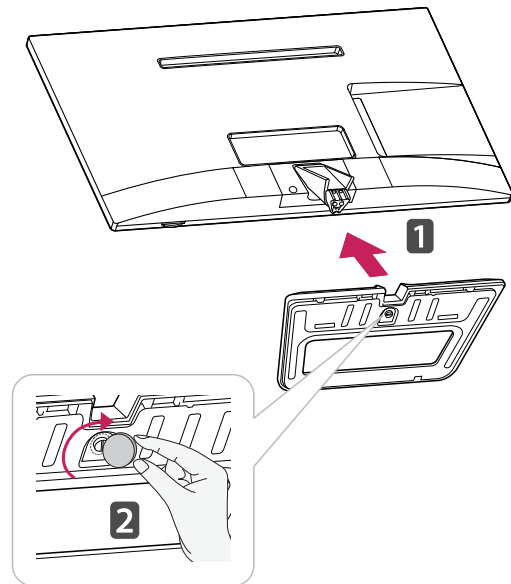

CAUTION

Tighten the screws firmly to prevent the TV from tilting forward. Do not over tighten.

- 2 Attach the **Stand Body** from the TV.

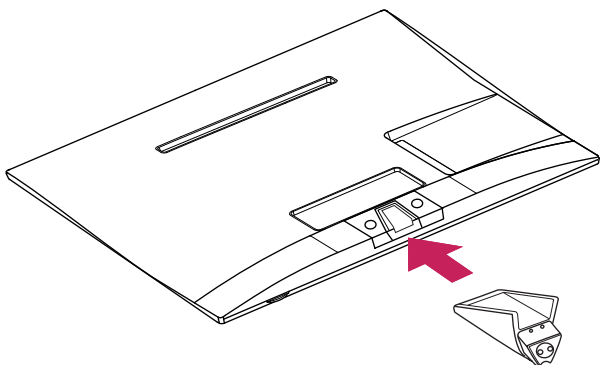

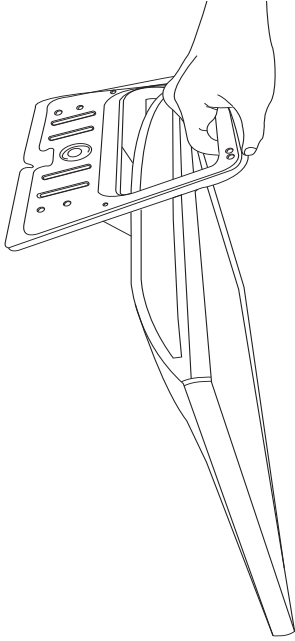
**CAUTION**

- Do not carry the monitor upside-down as this may cause it to fall off its stand, resulting in damage or injury.
- The illustration shows a general example of installation and may look different from the actual product.

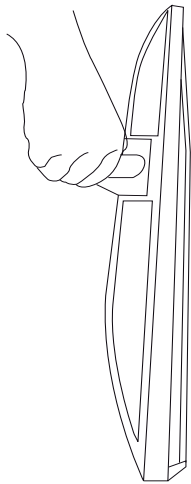

- Do not carry the monitor upside-down by holding the stand body as this may cause it to fall off, resulting in damage or injury.
- The illustration shows a general example of installation and may look different from the actual product.

M2752D M2752T DM2752D DM2752T

If you are not mounting the TV to a wall, use the following instructions to attach the stand.

- 1 Place the TV with the screen side down on a flat and cushioned surface.

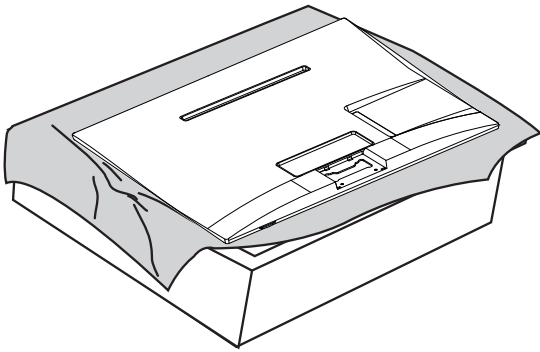

- 2 Attach the **Stand Body** from the TV. Insert the two **Lockers** of the **Stand Body** right into the groove of the TV head and secure them by pressing the left and right bottom sides.

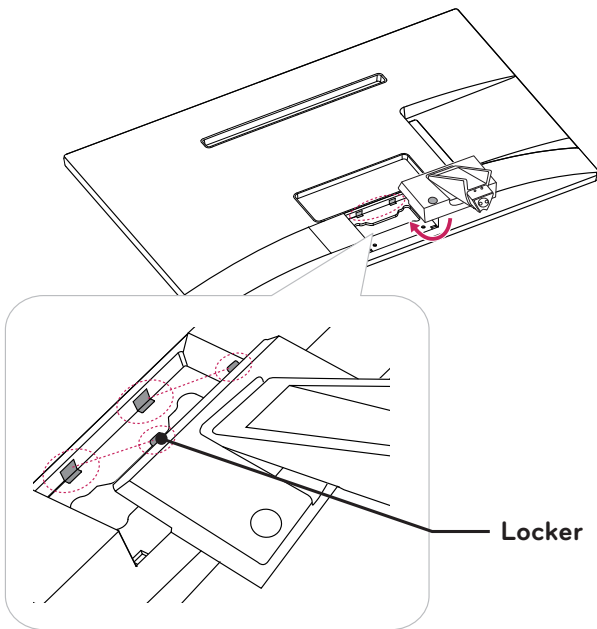

- 3 Secure the TV and the **Stand Body** with the 2 screws.

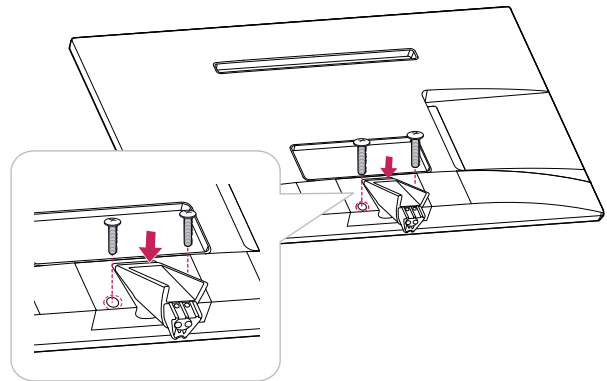

! WARNING

If you don't fasten the screw tightly, TV will fall down and get damaged.

- 4 Attach the **Stand Base** from the **Stand Body** by turning the screw to the right with a **Coin**.

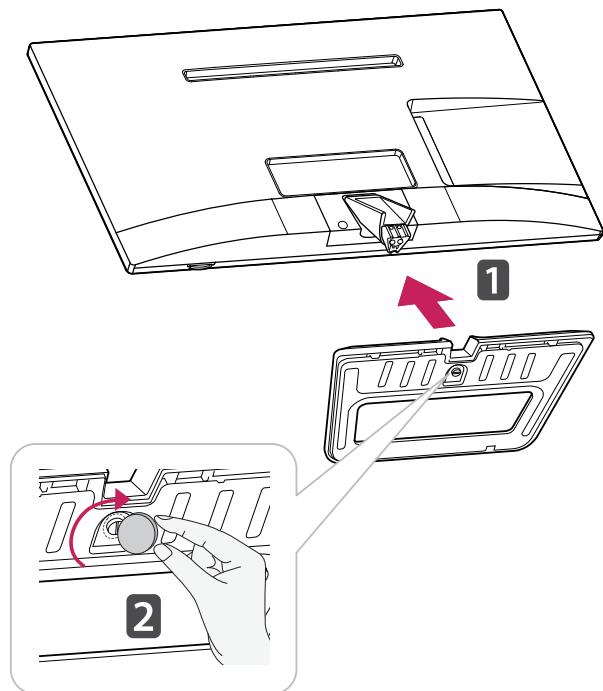

! CAUTION

Tighten the screws firmly to prevent the TV from tilting forward. Do not over tighten.

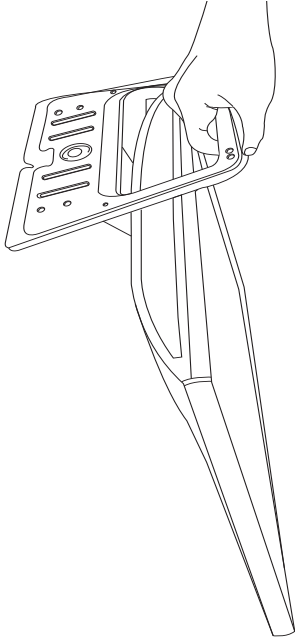
**CAUTION**

- Do not carry the monitor upside-down as this may cause it to fall off its stand, resulting in damage or injury.
- The illustration shows a general example of installation and may look different from the actual product.

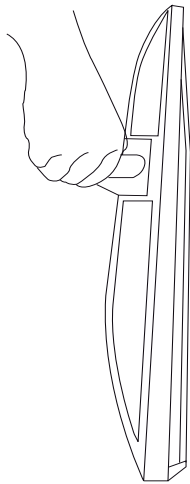

- Do not carry the monitor upside-down by holding the stand body as this may cause it to fall off, resulting in damage or injury.
- The illustration shows a general example of installation and may look different from the actual product.

Mounting on a table

- 1 Lift and tilt the TV into its upright position on a table.
Leave a 10 cm (4 inches) (minimum) space from the wall for proper ventilation.

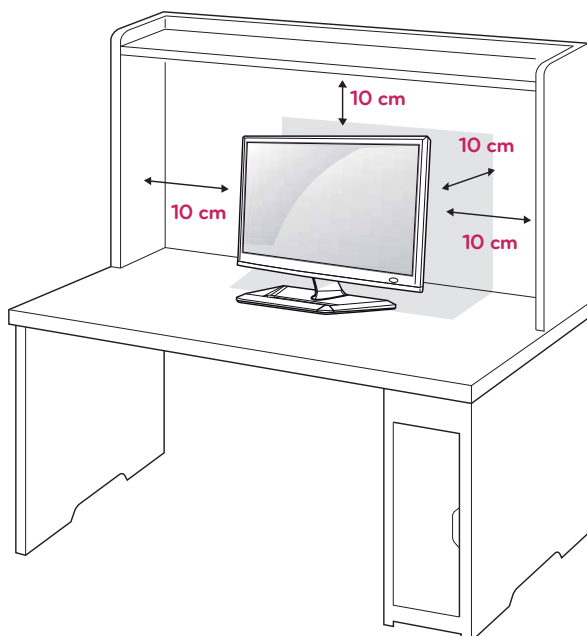

- 2 Connect the **AC-DC Adapter** and **Power Cord** to a wall outlet.

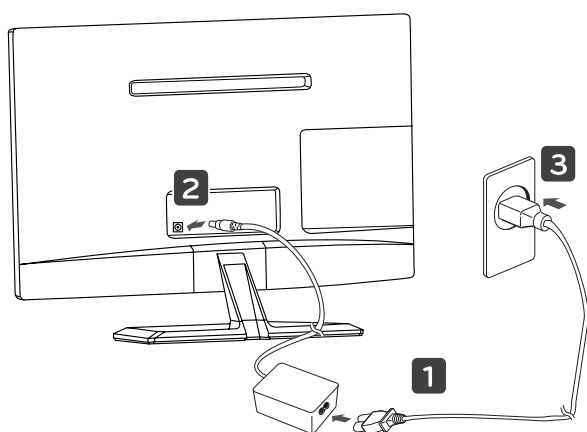

WARNING

When you adjust the angle, do not hold the bottom of the TV frame as shown on the following illustration, as may injure your fingers.

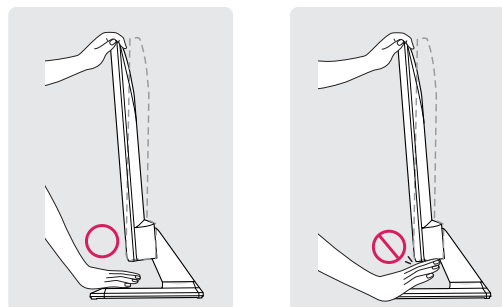

CAUTION

Disconnect the power cord first, and then move or install the TV. Otherwise electric shock may occur.

CAUTION

Do not place the TV near or on sources of heat, as this may result in fire or other damage.

NOTE

Tilt from +20 to -5 degrees up or down to adjust the angle of the TV to suit your view.

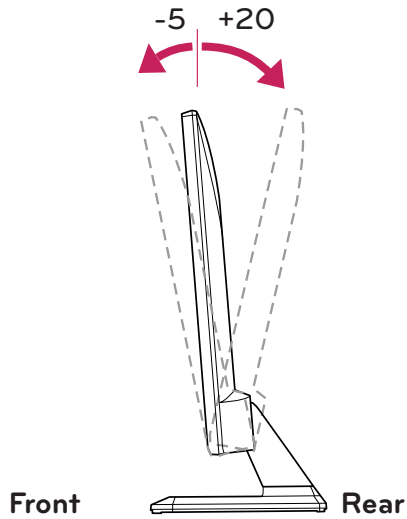
**Using the Kensington security system**

The Kensington security system connector is located at the back of the TV. For more information of installation and using, refer to the manual supplied with the Kensington security system or visit <http://www.kensington.com>.

Connect the Kensington security system cable between the TV and a table.

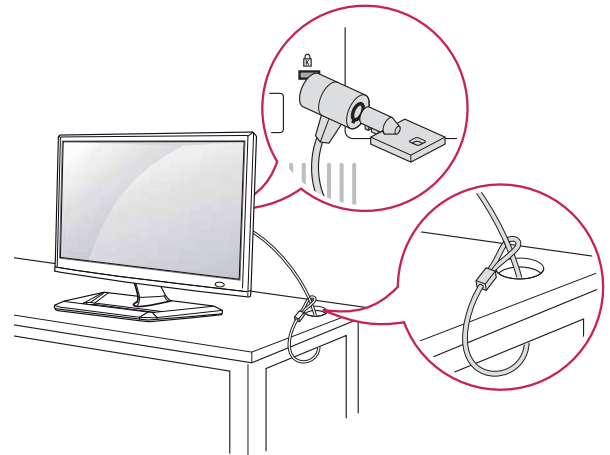
**Tidying cables**

Gather and bind the cables with the supplied cable tie.

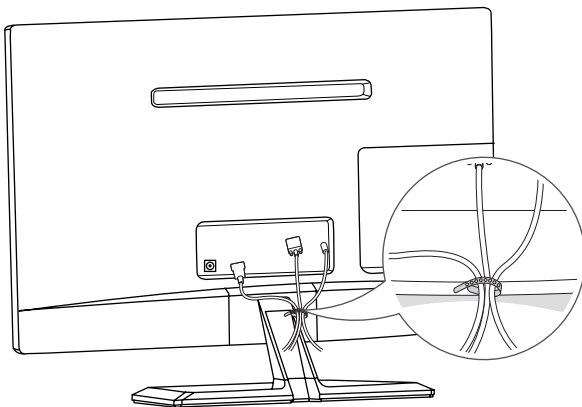
**NOTE**

The Kensington security system is optional. You can obtain additional accessories from most electronics stores.

Detaching the Stand

| | | | |
|--------|--------|---------|---------|
| M2252D | M2352D | M2452D | M2252T |
| M2352T | M2452T | DM2352D | DM2352T |

- 1 Place the TV with the screen side down on a flat and cushioned surface.

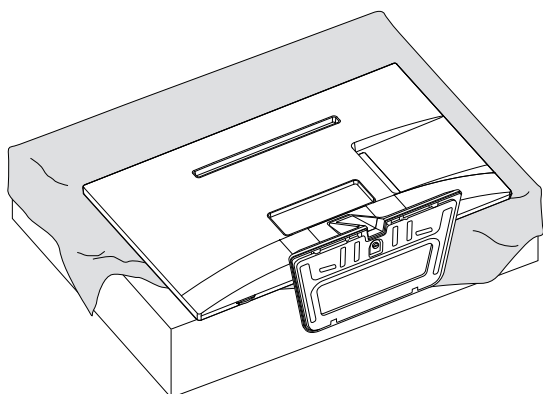

CAUTION

- Lay a foam mat or soft protective cloth on the surface to protect the screen from damage.
- When detaching the stand to the TV, place the screen facing down on a cushioned table or flat surface to protect the screen from scratches.

- 2 Turn the screw to the left, and then pull out the **Stand Base** from the **Stand Body**.

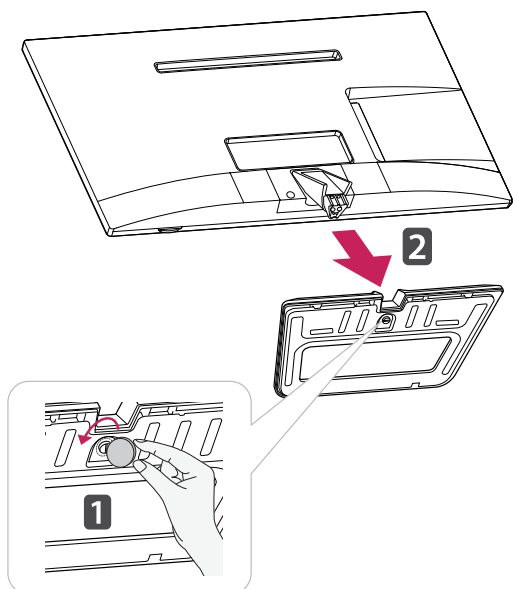

- 3 Pull out the **Stand Body** from the TV.

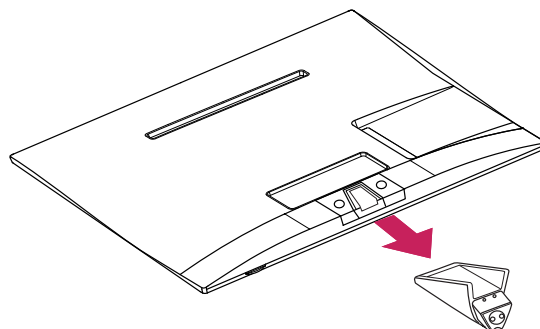

M2752D M2752T DM2752D DM2752T

- 1 Place the TV with the screen side down on a flat and cushioned surface.

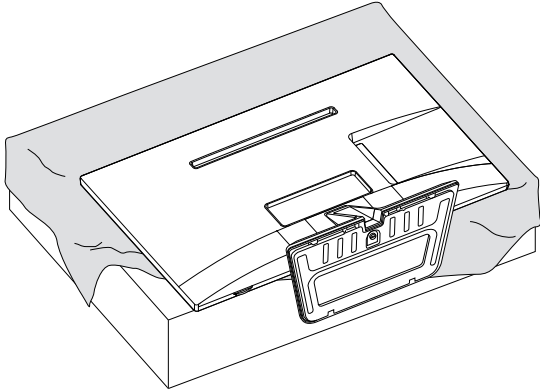

CAUTION

- Lay a foam mat or soft protective cloth on the surface to protect the screen from damage.
- When detaching the stand to the TV, place the screen facing down on a cushioned table or flat surface to protect the screen from scratches.

- 2 Turn the screw to the left, and then pull out the **Stand Base** from the **Stand Body**.

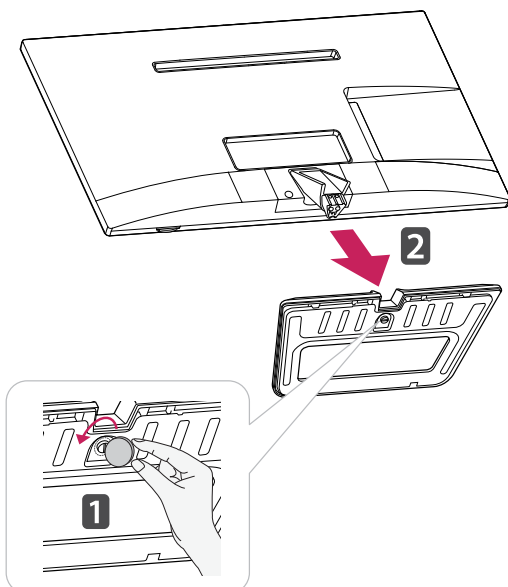

- 3 Remove 2 screws and pull out the **Stand Body** from the TV.

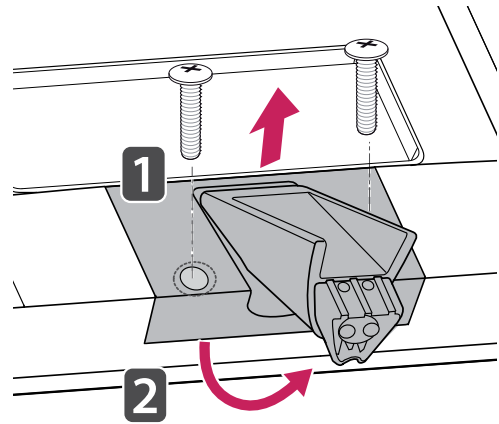

Mounting on a wall

For proper ventilation, allow a clearance of 10 cm on each side and from the wall. Detailed installation instructions are available from your dealer, see the optional Tilt Wall Mounting Bracket Installation and Setup Guide.

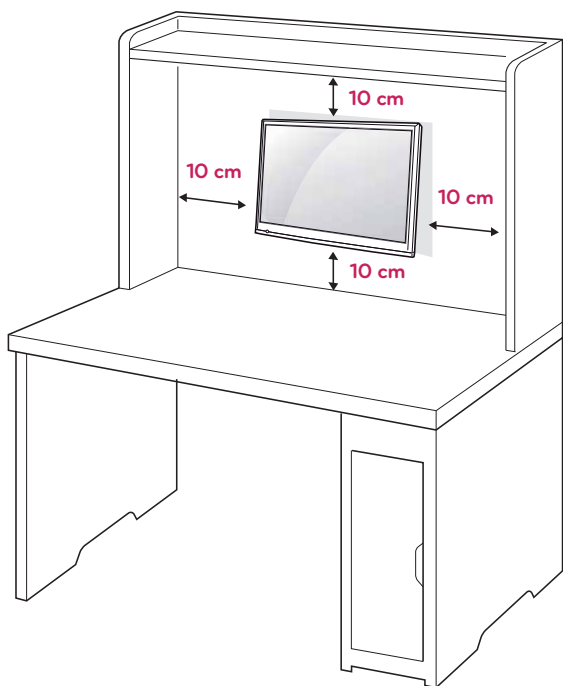

If you intend to mount the TV to a wall, attach Wall mounting interface (optional parts) to the back of the TV.

When you install the TV using the wall mounting interface (optional parts), attach it carefully so it will not drop.

- 1 Please, Use the screw and wall mount interface in accordance with VESA Standards.
- 2 If you use screw longer than standard, the TV might be damaged internally.
- 3 If you use improper screw, the product might be damaged and drop from mounted position. In this case, LG Electronics is not responsible for it.
- 4 VESA compatible only with respect to screw mounting interface dimensions and mounting screw specifications.

5 Please use VESA standard as below.

- 784.8 mm (30.9 inch) and under
 - * Wall Mount Pad Thickness : 2.6 mm
 - * Screw : Φ 4.0 mm x Pitch 0.7 mm x Length 10 mm
- 787.4 mm (31.0 inch) and above
 - * Please use VESA standard wall mount pad and screws.

| | |
|-------------------------------|-----------|
| VESA (A x B) | 100 x 100 |
| Standard screw | M4 |
| Number of screws | 4 |
| Wall mount bracket (optional) | RW120 |

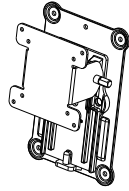

- VESA (A x B)

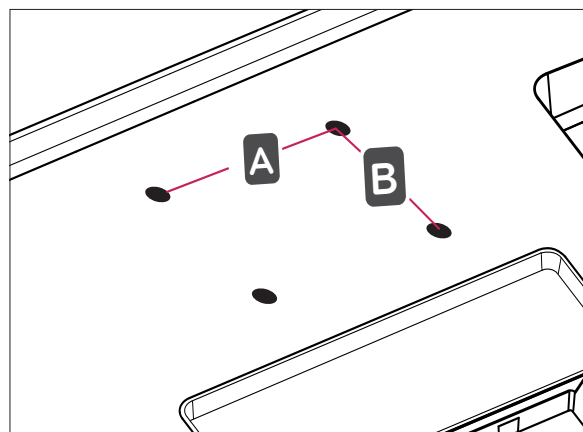

**CAUTION**

- Disconnect the power cord first, and then move or install the TV. Otherwise electric shock may occur.
- If you install the TV on a ceiling or slanted wall, it may fall and result in severe injury.
- Use an authorized LG wall mount and contact the local dealer or qualified personnel.
- Do not over tighten the screws as this may cause damage to the TV and void your warranty.
- Use the screws and wall mounts that meet the VESA standard. Any damages or injuries by misuse or using an improper accessory are not covered by the warranty.

**NOTE**

- Use the screws that are listed on the VESA standard screw specifications.
- The wall mount kit includes an installation manual and necessary parts.
- The wall mount bracket is optional. You can obtain additional accessories from your local dealer.
- The length of screws may differ depending on the wall mount. Be sure to use the proper length.
- For more information, refer to the instructions supplied with the wall mount.

WATCHING TV

Turning the TV on for the first time

When you access the TV for the first time, the initial setting screen appears. Select a language and customize the basic settings.

- 1 Connect the power cord to a power outlet.
- 2 Press  on the TV or power button on the remote control to turn the TV on.
The Standby Light is turned off.



NOTE

When the TV is in Power saving mode, the Standby Light turns amber.

- 3 The initial setting screen appears if you access the TV for the first time.



NOTE

If you do not operate the TV within 40 seconds when the setting menu screen appears, the setting menus will disappear.

- 4 Follow the on-screen instructions to customize your TV according to your preferences.

| | |
|---------------------|--|
| Language | Selects a language for the display. |
| ↓ | |
| Mode Setting | Selects Home Use for the home environment. |
| ↓ | |
| Power Indicator | Selects the Standby Light. If you select On, the TV turns on the Standby Light in the front panel when the TV is off. |
| ↓ | |
| Country | Selects a country to display. |
| ↓ | |
| Time Zone | Selects the time zone and daylight saving. (When Russia is selected for Country) |
| ↓ | |
| Network Setting | (If there is LAN port) selects Network Setting to display. (M**52T models (Only UK)) |
| ↓ | |
| Set Password | Set the password. (When France/Italy is selected for Country) |
| ↓ | |
| 3D-On-Start Setting | Set the 3D automatically mode. Turning on the TV, automatically converts 2D to 3D and prints images in 3D. (Only Cinema 3D TV) |
| ↓ | |
| Auto Tuning | Scans and saves available programmes automatically. |

 **NOTE**

- For those countries without confirmed DTV broadcasting standards, some DTV features might not work, depending on the DTV broadcasting environment.
- When France is selected for Country, the initial password is not '0', '0', '0', '0' but '1', '2', '3', '4'.
- To display images in the best quality for your home environment, select **Home Use mode**.
- **Store Demo** mode is suitable for the retail environment.
- If you select **Store Demo mode**, the previously customized settings will switch to the default settings of **Store Demo mode** in 2 minutes.

5 When the basic settings are complete, press **OK**.

 **NOTE**

If you do not complete the initial setting, it will appear whenever you access the TV.

6 To turn the TV off, press  on the TV.
The Standby Light is turned on.

 **CAUTION**

Disconnect the power cord from the power outlet when you do not use the TV for a long period of time.

 **NOTE**

- You can also switch the TV from PC mode to TV mode, press **TV/PC**.
- You can also access **Factory Reset** by accessing **OPTION** in the main menus.

MAKING CONNECTIONS

Connect various external devices to the TV and switch input modes to select an external device. For more information about an external device's connection, refer to the manual supplied with each device.

Available external devices are: HD receivers, DVD players, VCRs, audio systems, USB storage devices, PC, camcorders or cameras, gaming devices, and other external devices.

NOTE

- If you record a TV program on a DVD recorder or VCR, make sure to connect the TV signal input cable to the TV through a DVD recorder or VCR. For more information about recording, refer to the manual supplied with the connected device.
- The external device connection may differ from the model.
- Connect external devices to the TV regardless of the order of the TV port.

Connecting an antenna

Connect an antenna, cable or cable box to watch TV referring to the following. The illustrations may differ from the actual accessories and an RF cable is optional.

Connect the TV to a wall antenna socket with an RF cable (75).

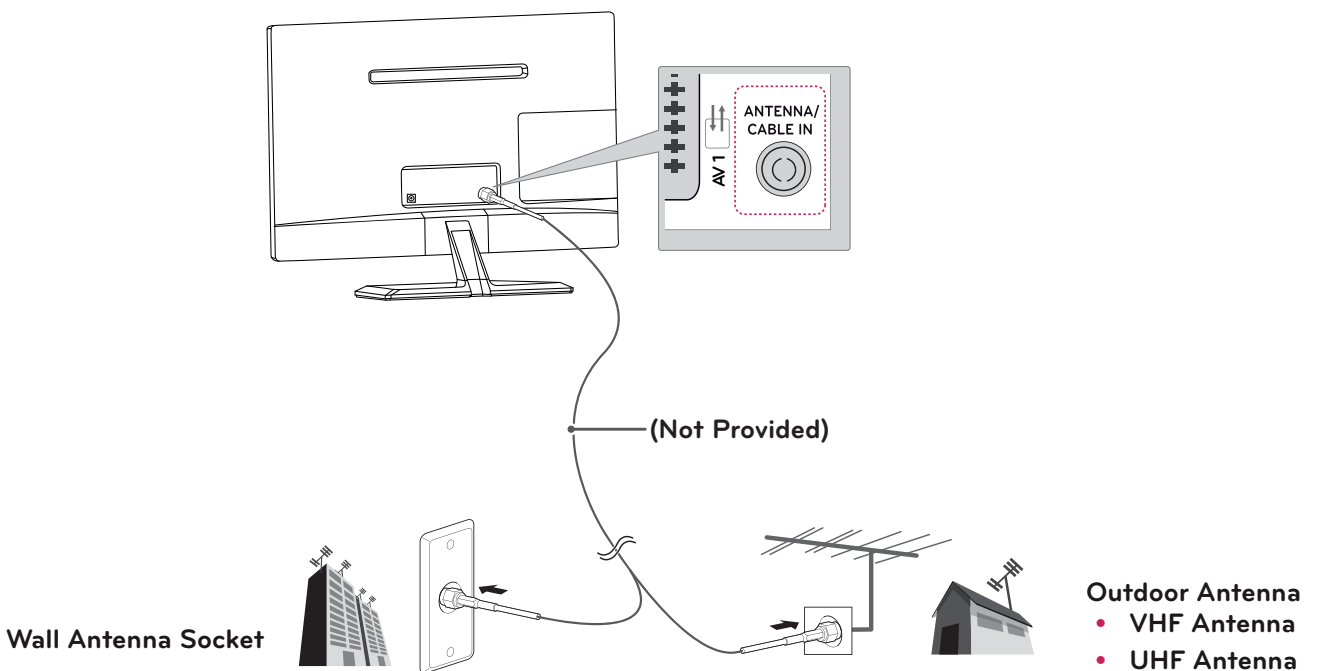

NOTE

- Use a signal splitter to use more than 2 TVs.
- If the image quality is poor, install a signal amplifier properly to improve the image quality.
- If the image quality is poor with an antenna connected, aim the antenna to the proper direction.
- Visit <http://AntennaWeb.org> for more information about the antenna and cable connection.

CAUTION

- Make sure not to bend the copper wire of the RF cable.



- Complete all connections instructions between devices, and then connect the power cord to the power outlet to prevent damages to your TV.

Connecting to a HD receiver, DVD, VCR player or Gaming device

Connect a HD receiver, DVD, VCR player or Gaming device to the TV and select an appropriate input mode.

HDMI connection

HDMI is the best way to connect a device.

Transmits the digital video and audio signals from an external device to the TV. Connect the external device and the TV with the HDMI cable as shown on the following illustration.

NOTE

- Use a High Speed HDMI™ Cable.
- High Speed HDMI™ Cables are tested to carry an HD signal up to 1080p and higher.
- Supported DTV Audio: MPEG, Dolby Digital.
- Supported HDMI Audio format: Dolby Digital, PCM (Up to 192 KHz, 32k/44.1k/48k/88k/96k/176k/192k, DTS Not supported.)

- Choose any HDMI input port to connect.
- It does not matter which port you use.

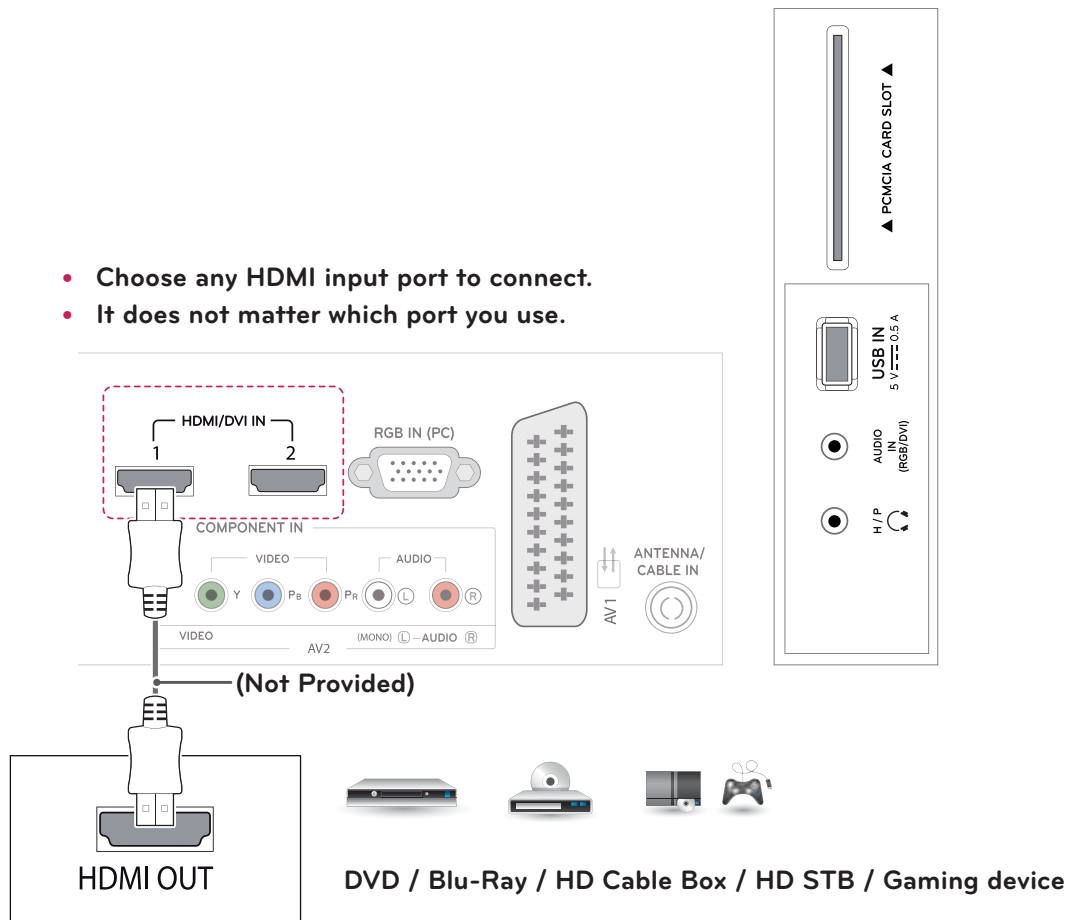

HDMI to DVI connection

Transmits the digital video signal from an external device to the TV. Connect the external device and the TV with the HDMI to DVI cable as shown in the following illustration. To transmit an audio signal, connect an optional audio cable.

NOTE

If you do not use an optional external speaker, connect the external device to the TV with the optional audio cable.

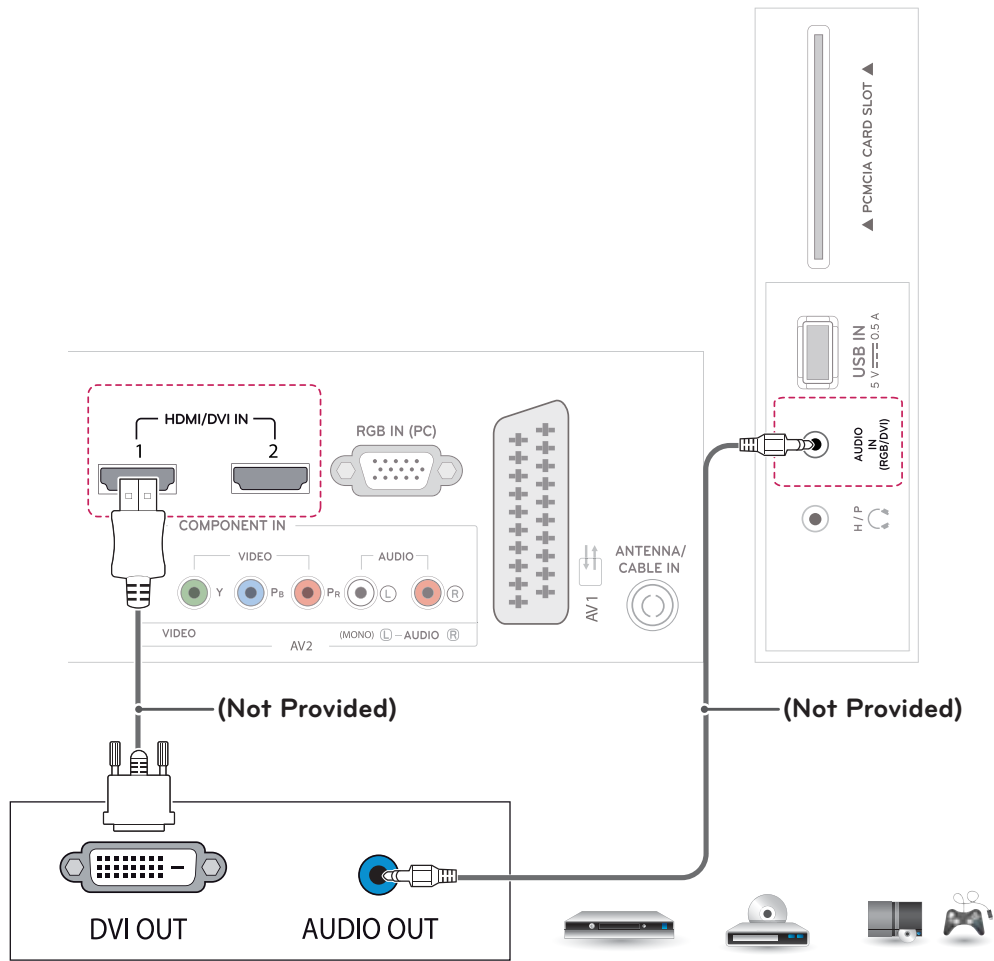

DVD / Blu-Ray / HD Cable Box /
HD STB / Gaming device

Component connection

Transmits the analog video and audio signals from an external device to the TV. Connect the external device and the TV with the component cable as shown on the following illustration. To display images by using progressive scan, make sure to use the component cable.

NOTE

- If cables are installed incorrectly, it could cause the image to display in black and white or with distorted color.
- **Check to ensure the cable are matched with the corresponding color connection.**

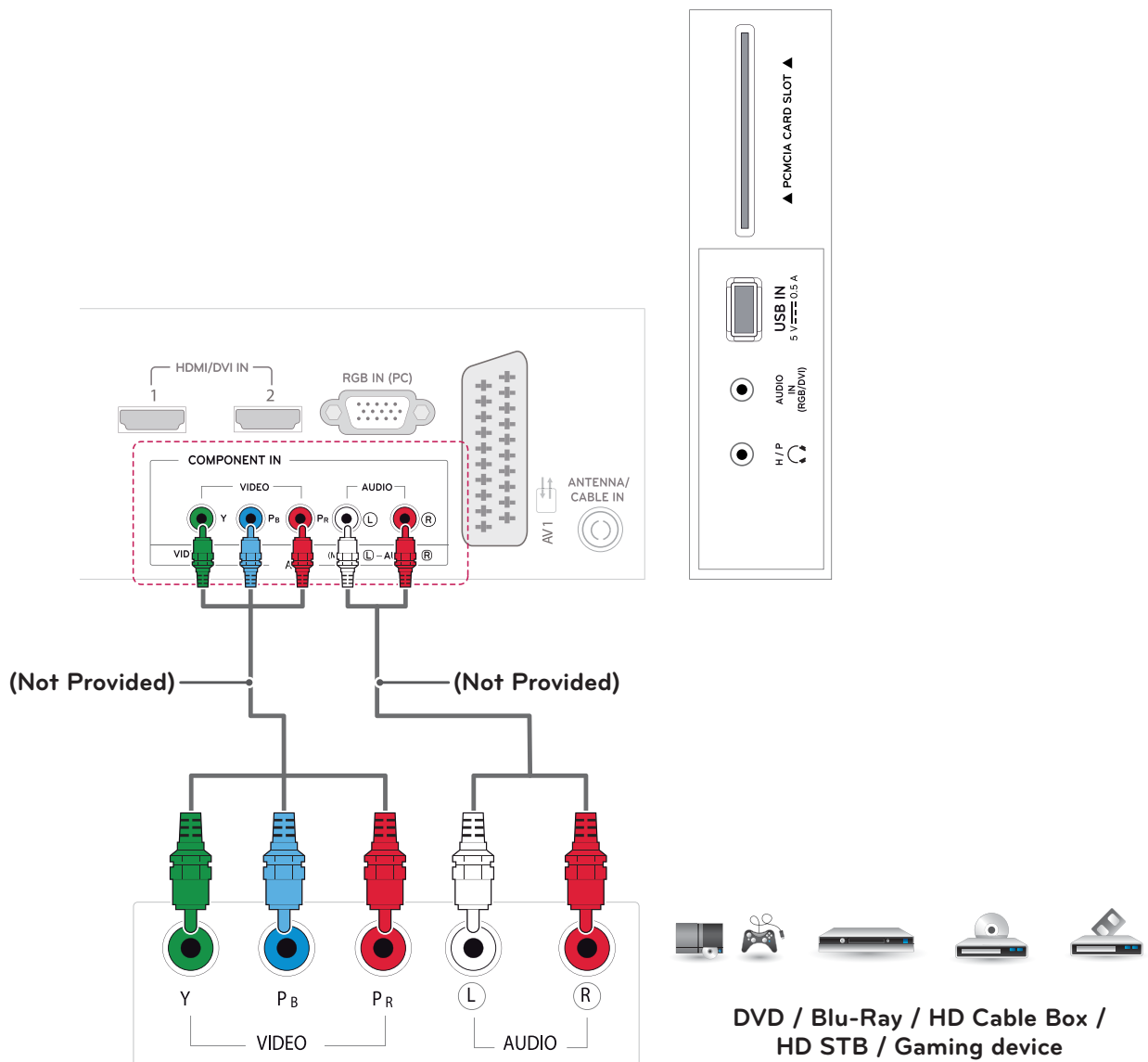

Composite connection

Transmits the analog video and audio signals from an external device to the TV. Connect the external device and the TV with the composite cable as shown on the following illustration.

NOTE

Check to ensure the cable are matched with the corresponding color connection.

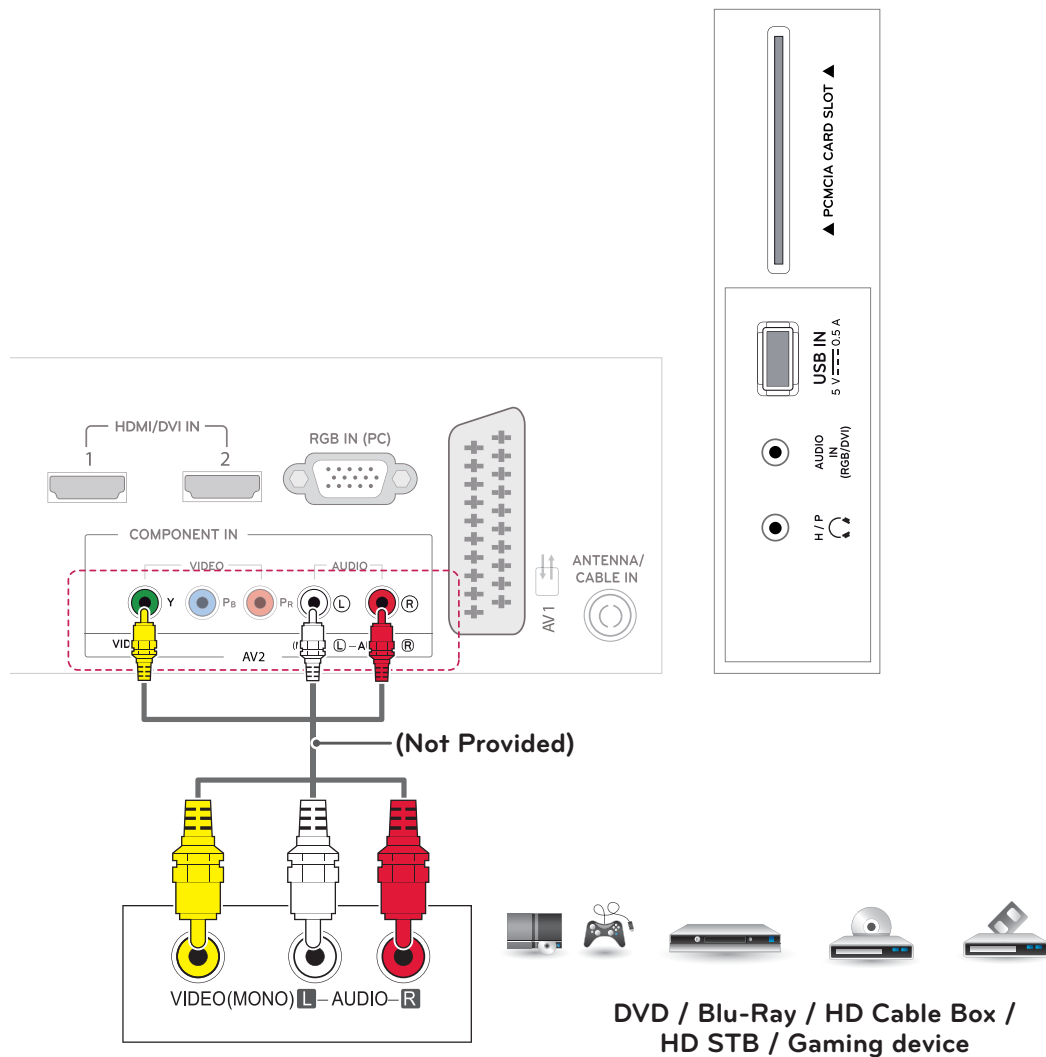

Euro Scart connection

Transmits the video and audio signals from an external device to the TV. Connect the external device and the TV with the Euro Scart cable as shown on the following illustration. To display images by using progressive scan, make sure to use the Euro Scart cable.

| | | | |
|--------------------|---------------|----------------------------|--|
| Current input mode | Output Type | AV1 (TV Out ¹) | AV1 (When DTV scheduled recording is in progress using recording equipment.) |
| | Digital TV | Digital TV | O |
| Analogue TV, AV | Component/RGB | Analogue TV | O (The input mode is converted to DTV.) |
| Component/RGB | | | |
| HDMI | | | |

NOTE

- Any Euro scart cable used must be signal shielded.
- When watching digital TV in 3D imaging mode, TV out signals cannot be output through the SCART cable.
- If you set the 3D mode to On while a scheduled recording is performed on digital TV, monitor out signals cannot be output through the SCART cable, and the recording cannot be performed.

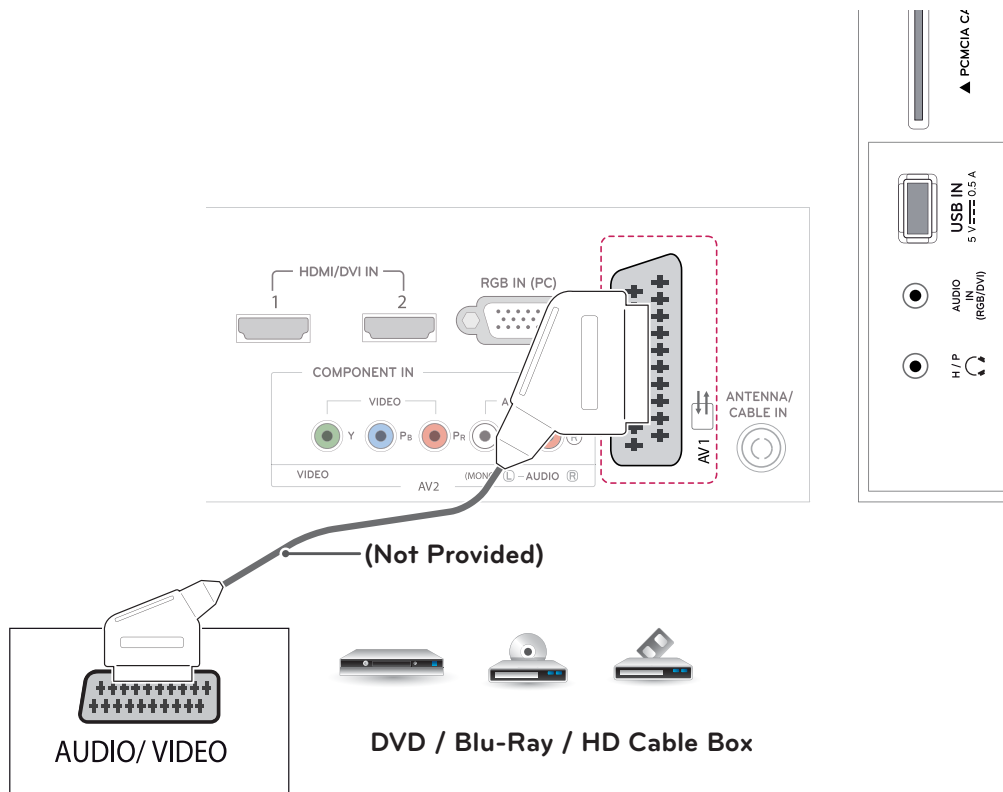

Connecting to an audio system

Use an optional external audio system instead of the built-in speaker.

Headphone connection

Transmits the headphone signal from the TV to an external device. Connect the TV with the headphone as shown on the following illustration.

! NOTE

- AUDIO menu items are disabled when connecting a headphone.
- When changing AV MODE with a headphone connected, the change is applied to video but not to audio.
- Optical digital audio out is not available when connecting a headphone.
- Headphone impedance: 16 Ω
- Max audio output of headphone: 10 mW to 15 mW
- Headphone jack size: 0.35 cm

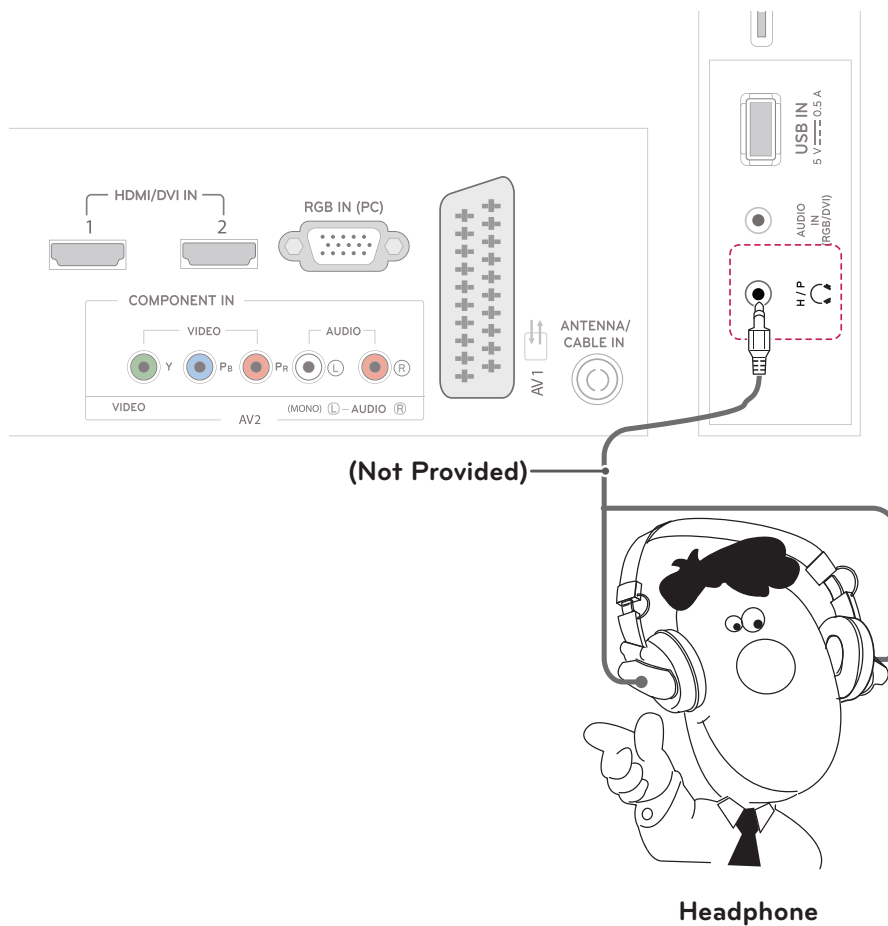

Connecting to a USB

Connect a USB storage device such as a USB flash memory, external hard drive, MP3 player or a USB memory card reader to the TV and access the USB menu to use various multimedia files.

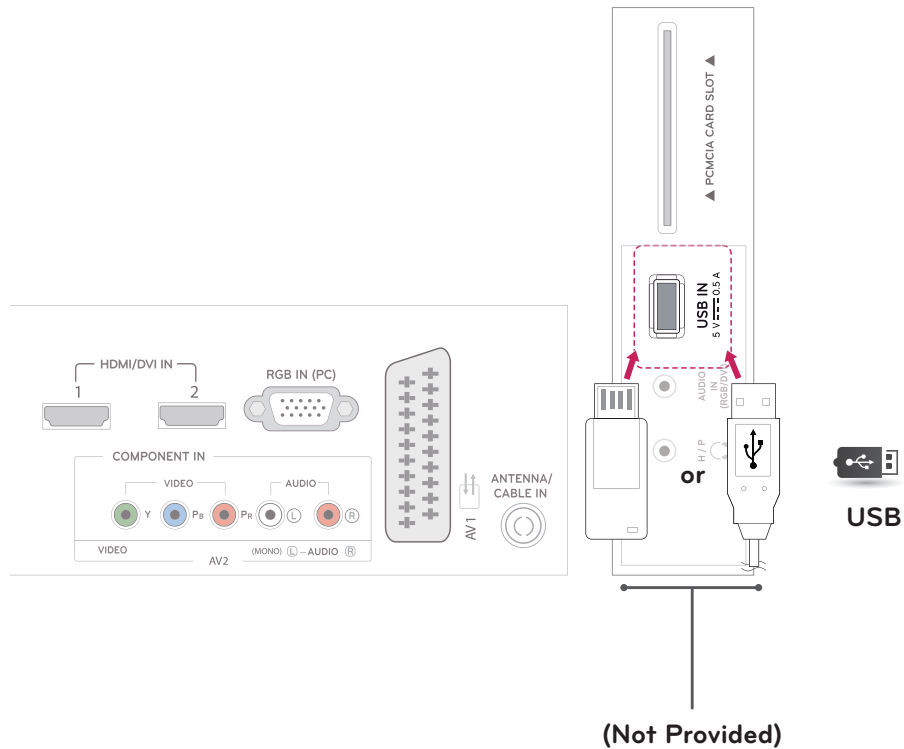

Connecting to a CI Module

View the encrypted (pay) services in digital TV mode. This feature is not available in all countries.



NOTE

Check if the CI module is inserted into the PCMCIA card slot in the right direction. If the module is not inserted properly, this can cause damage to the TV and the PCMCIA card slot.

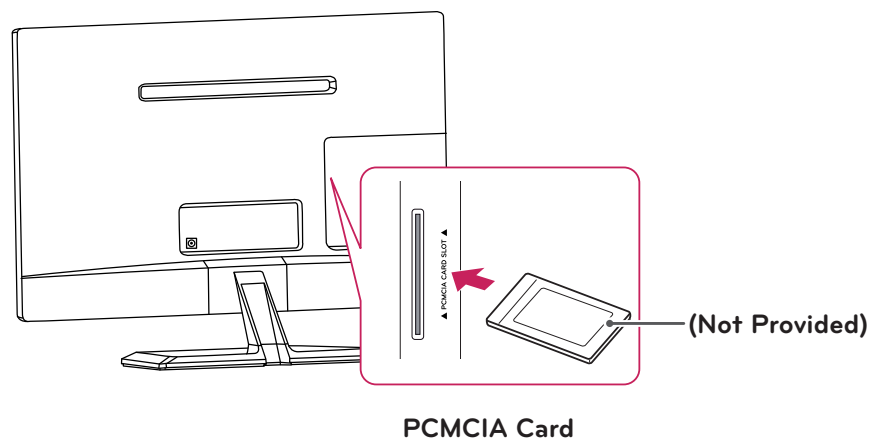

Connecting to a wired network

M**52T models(Only UK)

Connect the TV to a local area network (LAN) via the LAN port as shown on the following illustration and set up the network settings. After making a physical connection, a small number of home networks may require the TV network settings to be adjusted. For most home networks, the TV will connect to automatically without any adjustments.

For detail information, contact your internet provider or router manual.



CAUTION

- Do not connect a modular phone cable to the LAN port.
- Since there are various connection methods, please follow the specifications of your telecommunication carrier or internet service provider.

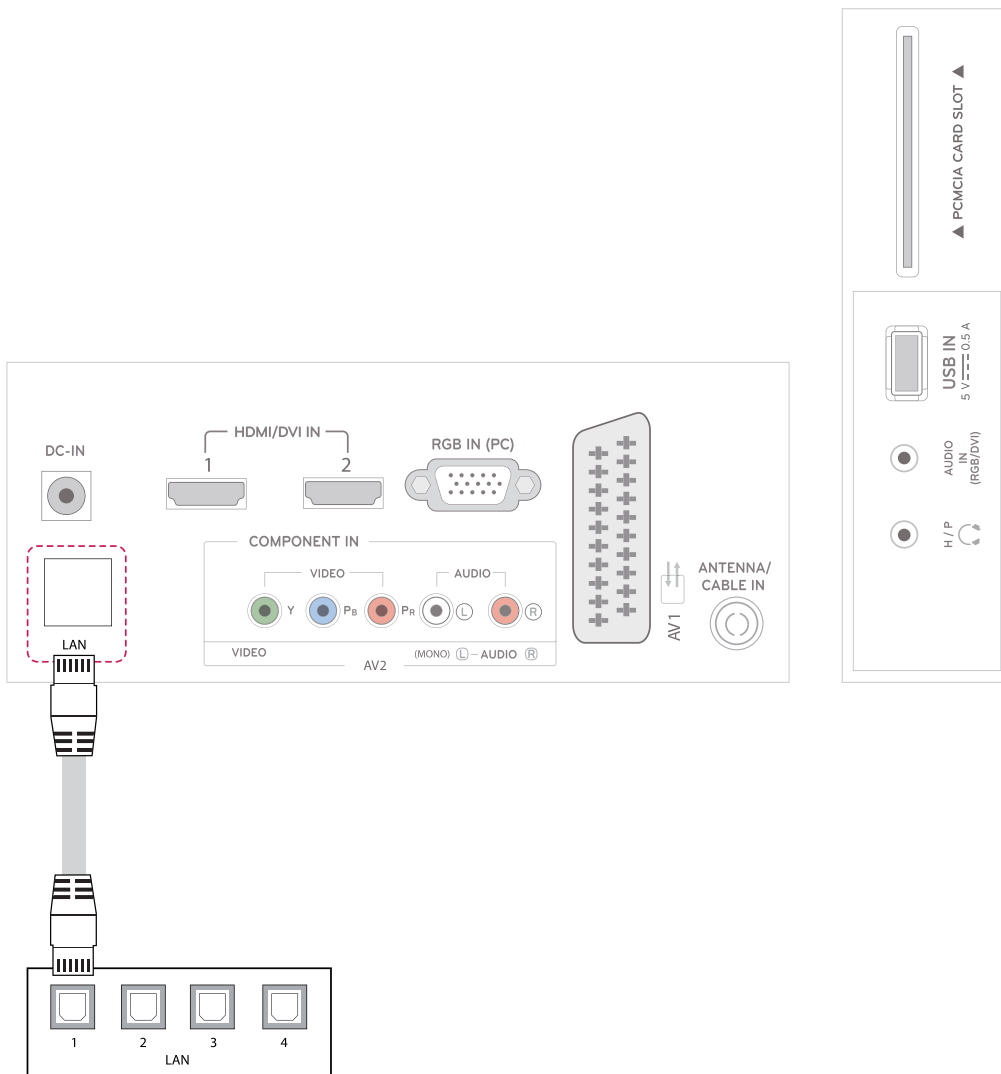

NOTE

[M**52T Model]

- U.K: LAN port is available. (The LAN port is added to support HD MHEG.)
- Other areas: LAN port is not available.

Connecting to a PC

Your TV supports the Plug & Play* feature and has the built-in speakers with Infinite Surround that reproduces sound clearly with a rich bass.

* Plug & Play: The function when a PC recognizes a connected device that users connect to a PC and turn on, without device configuration or user intervention.

NOTE

- It is recommended to use the TV with the HDMI connection for the best image quality.
- If you do not use an optional external speaker, connect the PC to the TV with the optional audio cable.
- If you turn the TV on when the set becomes cold, the screen may flicker. This is normal.
- Use a shielded signal interface cable, such as D-sub 15 pin signal cable and HDMI to DVI cable, with a ferrite core to maintain standard compliance for the product.
- Some red, green, or blue spots may appear on the screen. This is normal.
- Connect the signal input cable and tighten it by turning the screws clockwise.
- Do not press the screen with your finger for a long time as this may result in temporary distortion on the screen.
- Avoid displaying a fixed image on the screen for a long period of time to prevent image burn. Use a screensaver if possible.

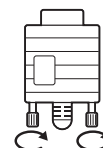

NOTE

- If you want to use HDMI-PC mode, you must set the input label to PC mode.
- The **OSD (On Screen Display)** is displayed on the screen as shown below.
 - » When turning the product on in **HDMI** input.
 - » When switching to **HDMI** input.

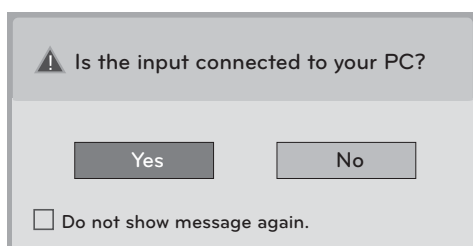

- If you select **"Yes"** the size and image quality are optimised for your PC.
- If you select **"No"** the size and image quality are optimised for the **AV device (DVD player, set-top box, gaming device)**.
- If you select **"Do not show message again"** this message does not appear until the TV is reset. You can change the set value in **SETTINGS ► INPUT ► Input Label**.
- The values set for HDMI1/HDMI2 are saved independently.

HDMI connection

Transmits the digital video and audio signals from your PC to the TV. Connect the PC and the TV with the HDMI cable as shown in the following illustrations. You should set PC as an input label to connect the PC to the TV with an HDMI connection.

NOTE

- Use a High Speed HDMI™ Cable.
- High Speed HDMI™ Cables are tested to carry an HD signal up to 1080p and higher.
- If you want to use HDMI-PC mode, you must set the input label to PC mode.
- Supported DTV Audio: MPEG, Dolby Digital.
- Supported HDMI Audio format: Dolby Digital, PCM (Up to 192 KHz, 32k/44.1k/48k/88k/96k/176k/192k, DTS Not supported.)

- Choose any HDMI input port to connect.
- It does not matter which port you use.

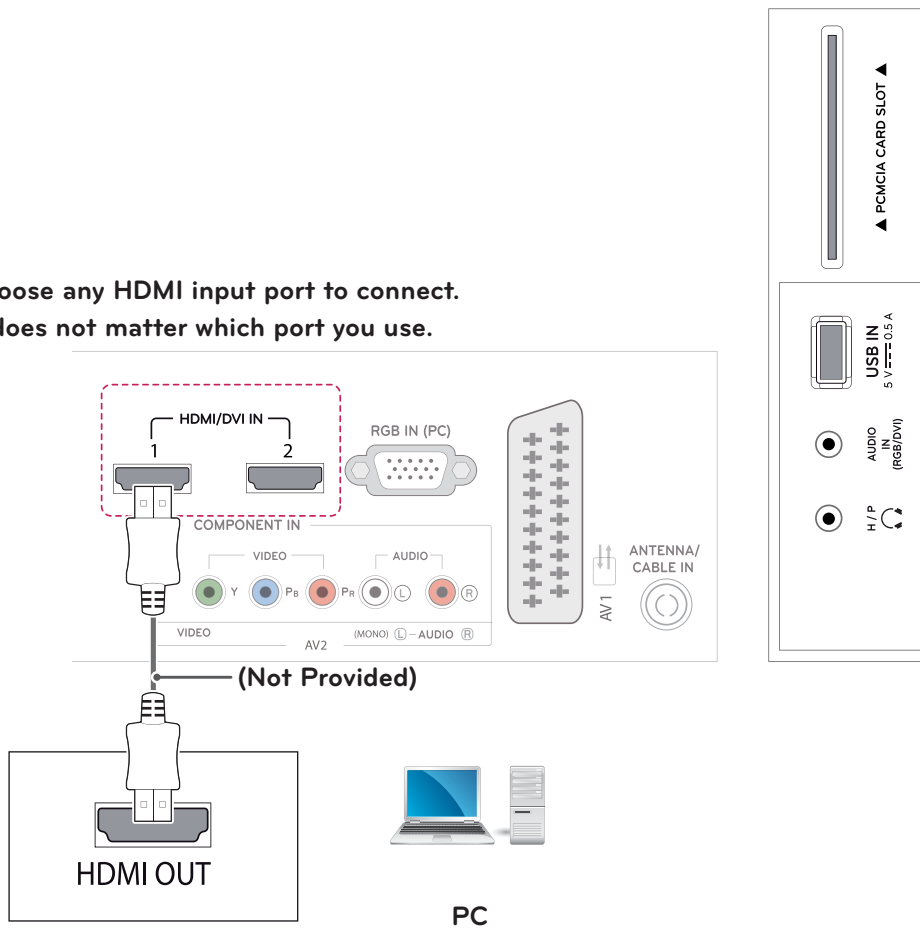

HDMI to DVI connection

Transmits the digital video signal from your PC to the TV. Connect the PC and the TV with the HDMI to DVI cable as shown the following illustrations. To transmit an audio signal, connect an optional audio cable.

NOTE

- If you want to use HDMI-PC mode, you must set the input label to PC or DVI mode.
- If you do not use an optional external speaker, connect the PC to the TV with the optional audio cable.

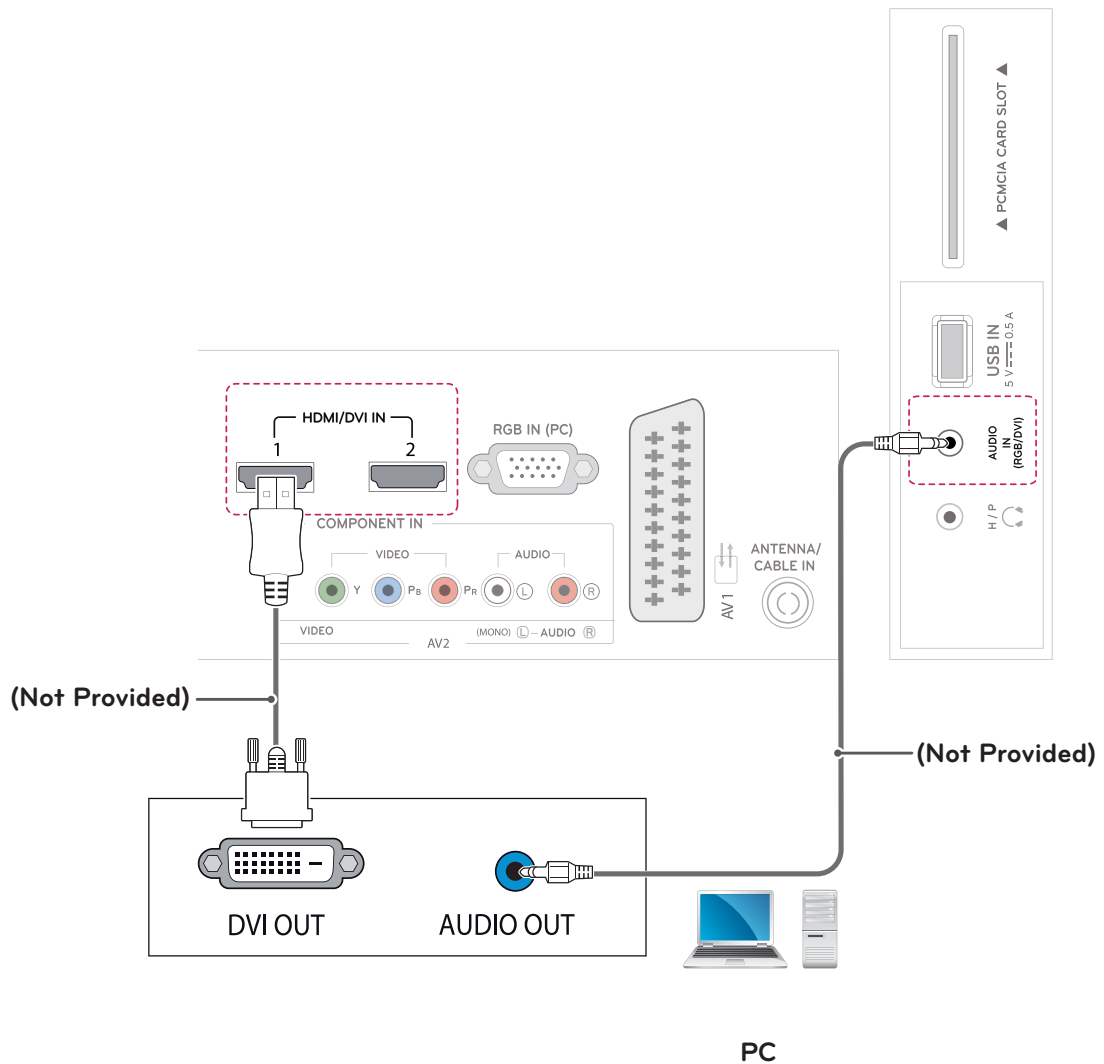

RGB connection

Transmits the analog video signal from your PC to the TV. Connect the PC and the TV with the D-sub 15 pin cable as shown the following illustrations. To transmit an audio signal, connect an optional audio cable.

! **NOTE**

If you do not use an optional external speaker, connect the PC to the TV with the optional audio cable.

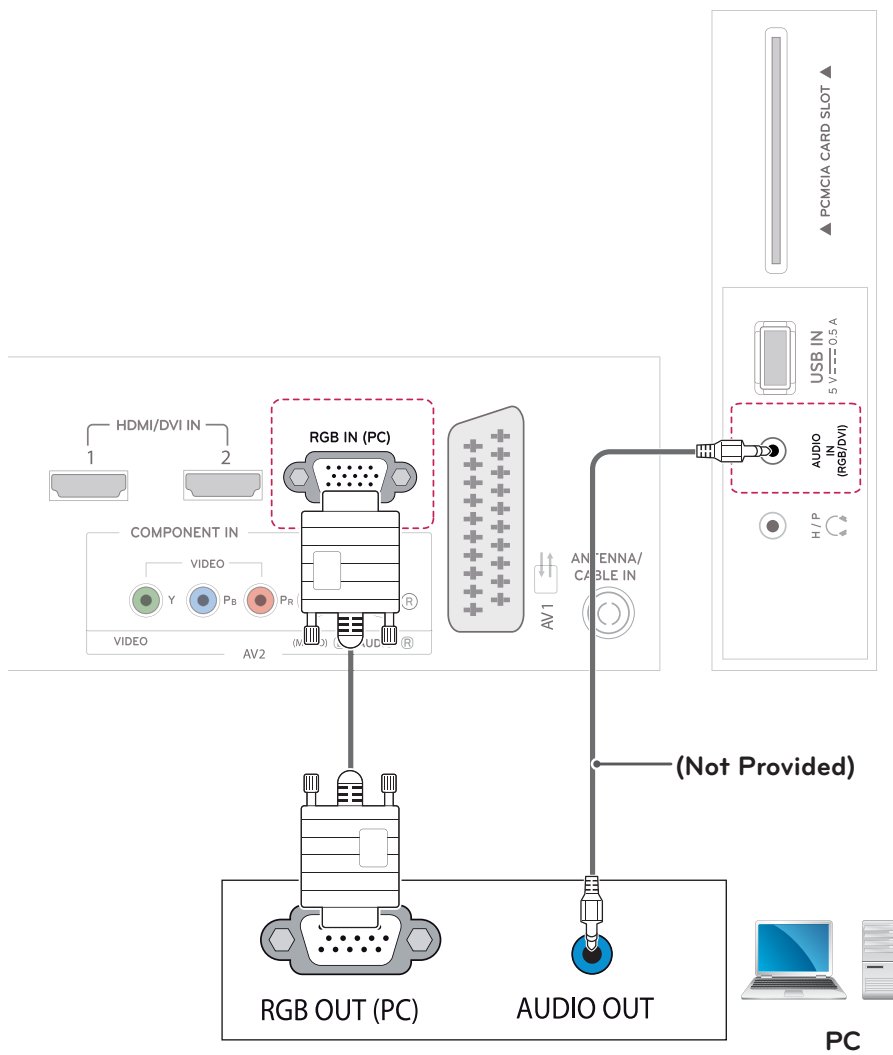

REMOTE CONTROL

M2252D M2352D M2452D M2752D M2252T M2352T M2452T M2752T

The descriptions in this manual are based on the buttons of the remote control. Please read this manual carefully and use the TV correctly.

To replace batteries, open the battery cover, replace batteries (1.5 V AAA) matching ⊕ and ⊖ ends to the label inside the compartment, and close the battery cover.

To remove the batteries, perform the installation actions in reverse.



CAUTION

Do not mix old and new batteries, as this may damage the remote control.

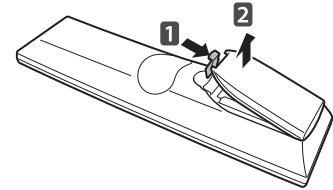

Make sure to point the remote control to the remote control sensor on the TV.

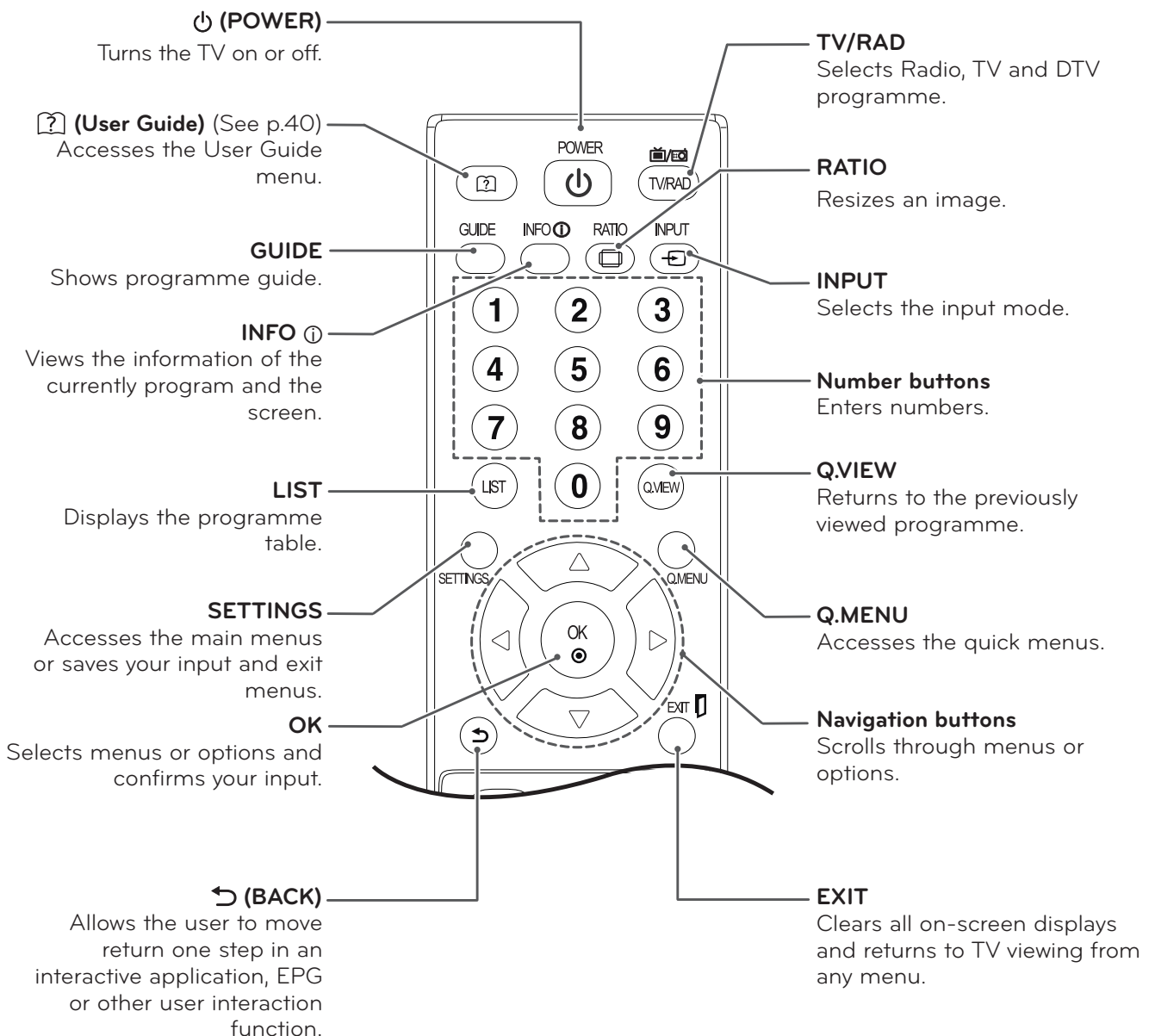

DM2352D DM2752D DM2352T DM2752T

The descriptions in this manual are based on the buttons of the remote control. Please read this manual carefully and use the TV correctly.

To replace batteries, open the battery cover, replace batteries (1.5 V AAA) matching ⊕ and ⊖ ends to the label inside the compartment, and close the battery cover.

To remove the batteries, perform the installation actions in reverse.



CAUTION

Do not mix old and new batteries, as this may damage the remote control.

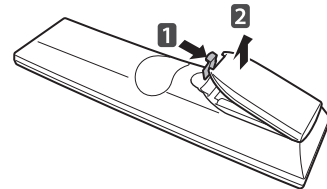

Make sure to point the remote control to the remote control sensor on the TV.

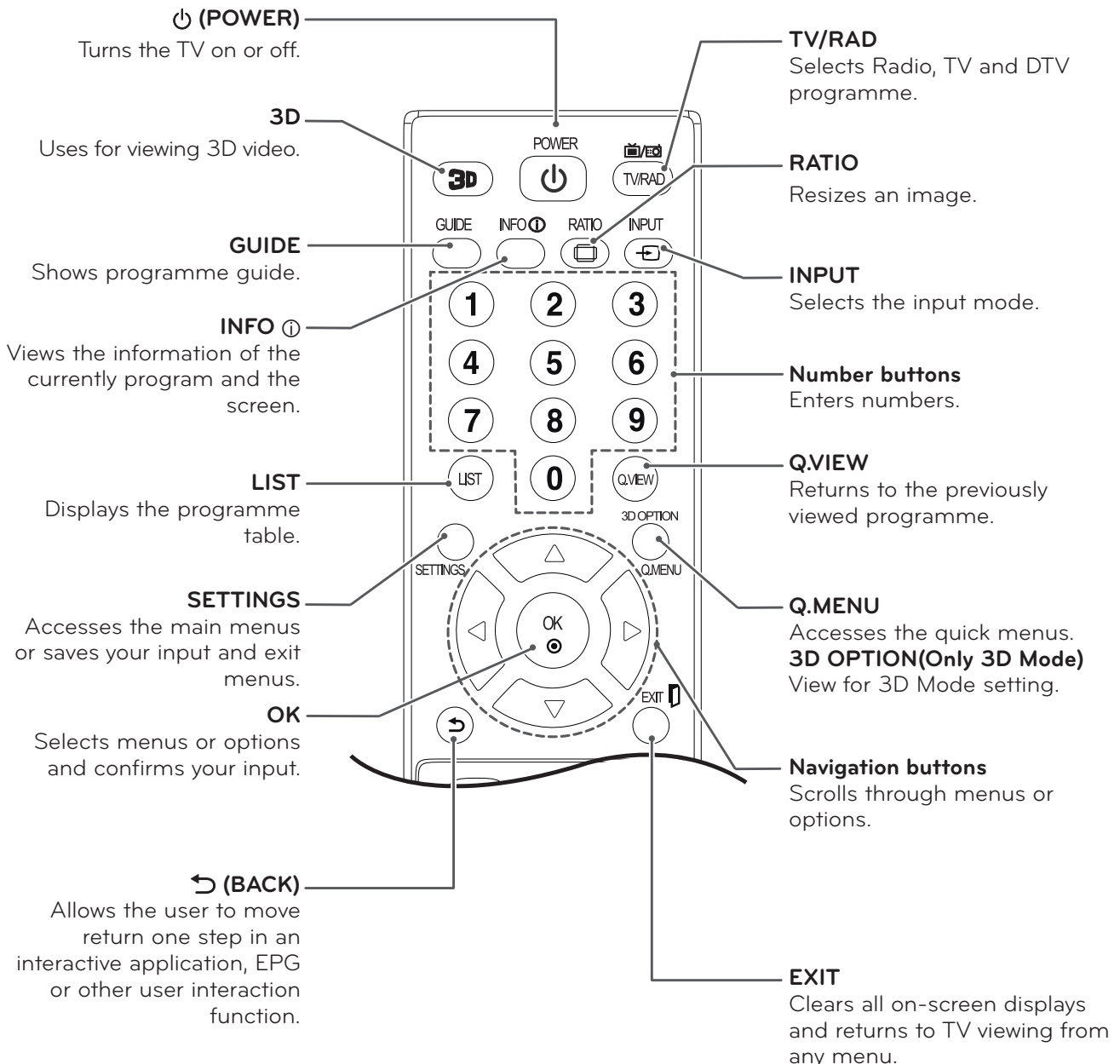

- M2252D
- M2352D
- M2452D
- M2752D
- M2252T
- M2352T
- M2452T
- M2752T
- DM2352D
- DM2752D
- DM2352T
- DM2752T

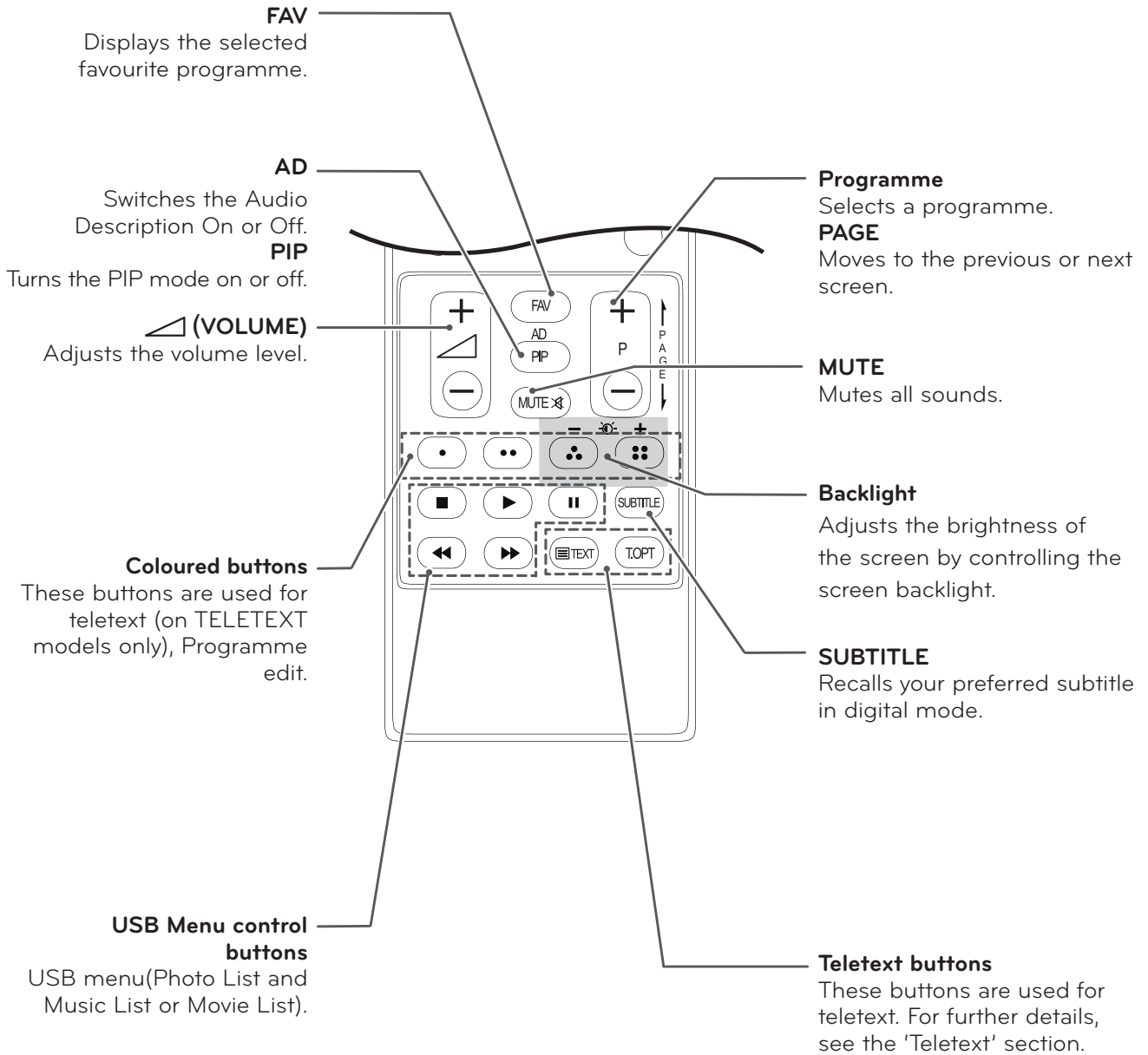

NOTE

On MHEG channel, you cannot adjust the backlight with the yellow or blue key.

CUSTOMIZING SETTINGS

Accessing main menus

- 1 Press **SETTINGS** to access the main menus.
- 2 Press the Navigation buttons to scroll to one of the following menus and press **OK**.
- 3 Press the Navigation buttons to scroll to the setting or option you want and press **OK**.
- 4 When you are finished, press **EXIT**.
When you return to the previous menu, press  (**BACK**).

| | |
|-----------------|--|
| PICTURE | Adjusts the image size, quality or effect. |
| AUDIO | Adjusts the sound quality, effect or volume level. |
| SETUP | Sets up and edit programmes. |
| TIME | Sets the time, date or Timer feature. |
| LOCK | Locks or unlocks channels and programs. |
| OPTION | Customizes the general settings. |
| INPUT | Views the input sources with their labels. (Only M**52D / DM**52D model) |
| NETWORK | Sets the network. (M**52T models (Only UK)) |
| MY MEDIA | Using integrated media feature. |

- Press **RED** button to access the **Customer Support** menus.
- Press **GREEN** Button to access the **FAQ** menus.

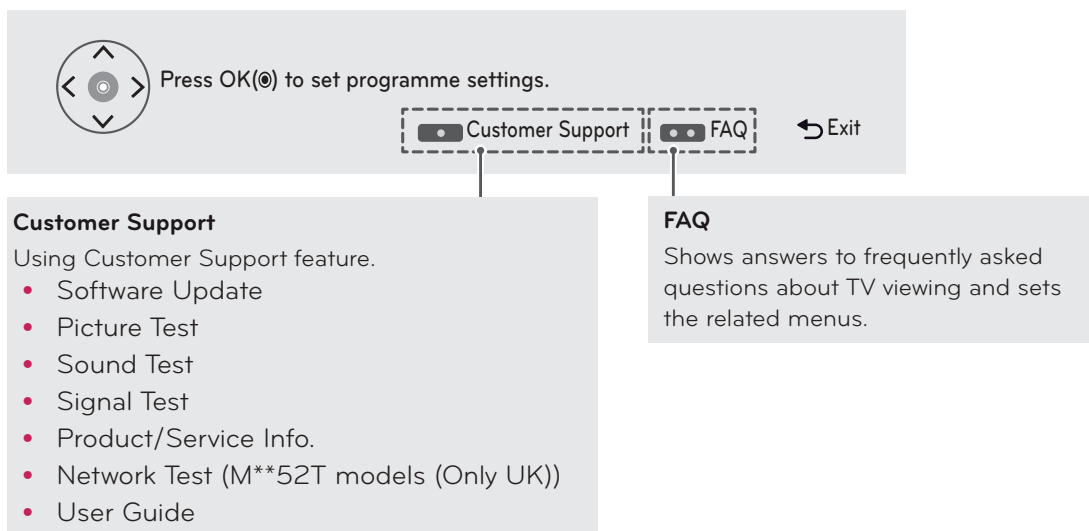

USING THE USER GUIDE

Accessing User Guide menu.

Using the TV menu

- 1 Press **SETTINGS** to access the main menus.
- 2 Press the **RED** button to access the **Customer Support** menus.
- 3 Press the Navigation button to scroll to **User Guide** and press **OK**.
- 4 Press the Navigation buttons to scroll to the option you want and press **OK**.
- 5 When you are finished, press **EXIT**.
When you return to the previous menu, press **↶** (**BACK**).

Using the Remote Control

(* Except for the 3D model)

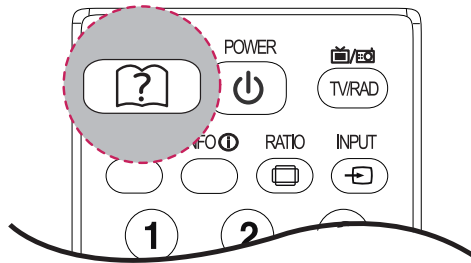

- 1 Press **?** (**User Guide**) to access the **User Guide**.
- 2 Press the Navigation buttons to scroll to the option you want and press **OK**.
- 3 When you are finished, press **EXIT**.
When you return to the previous menu, press **↶** (**BACK**).

- Image shown may differ from your TV.

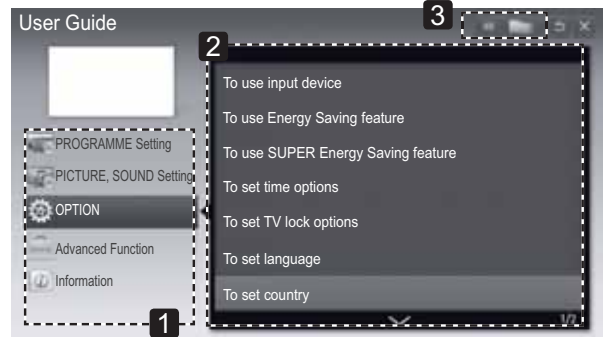

- 1 Allows to select the category you want.
- 2 Allows to select the item you want.
You can use **^**/**v** to move between pages.
- 3 Allows to browse the description of the function you want from the index.

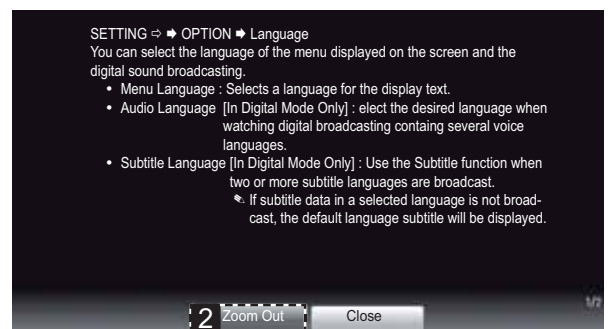
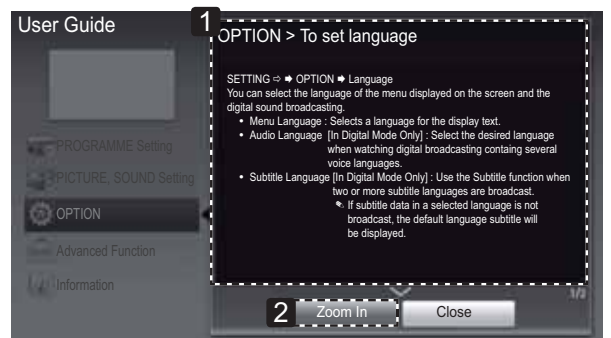

- 1 Shows the description of the selected menu.
You can use **^**/**v** to move between pages.
- 2 Zooms in or out the screen.

3D IMAGING(ONLY CINEMA 3D TV)

3D Technology

This TV can display in 3D via 3D broadcasting or when the TV is connected to a compatible device, such as a Blu-ray 3D Player. The viewer must wear compatible 3D glasses in order to see these images in 3D format.



NOTE

- After powering on the TV, a few seconds may be needed for your TV to calibrate.
- When watching digital TV in 3D imaging mode, TV out signals cannot be output through the SCART cable.
- If you set the 3D mode to On while a scheduled recording is performed on digital TV, TV out signals cannot be output through the SCART cable, and the recording cannot be performed.
- If 3D TV broadcast standard changes in the future and it is not supported by this TV, you may need a separate device, such as a set-top box.

MAINTENANCE

Cleaning Your TV

Clean your TV regularly to keep the best performance and to extend the product lifespan.



CAUTION

- Make sure to turn the power off and disconnect the power cord and all other cables first.
- When the TV is left unattended and unused for a long time, disconnect the power cord from the wall outlet to prevent possible damage from lightning or power surges.

Screen and frame

To remove dust, wipe the surface with a dry and soft cloth.

To remove major dirt, wipe the surface with a soft cloth dampened in clean water or a diluted mild detergent. Then wipe immediately with a clean and dry cloth.



CAUTION

- Do not push, rub, or hit the surface with your fingernail or a sharp object, as this may result in scratches on the screen and image distortions.
- Do not use any chemicals, such as waxes, benzene, alcohol, thinners, insecticides, air fresheners, lubricants, as these may damage the screen's finish and cause discolorations.

Cabinet and stand

To remove dust, wipe the cabinet with a dry and soft cloth.

To remove major dirt, wipe the cabinet with a soft cloth dampened in a clean water or water containing a small amount of mild detergent.



CAUTION

- Do not spray liquid onto the surface. If water enters the TV, it may result in fire, electric shock, or malfunction.
- Do not use any chemicals as this may deteriorate the surface.

Power cord

Remove the accumulated dust or dirt on the power cord regularly.

Preventing "Image burn" or "Burn-in" on your TV screen

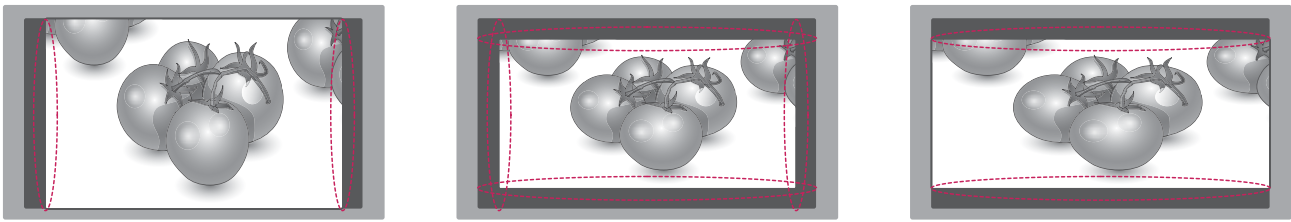

- If a fixed image displays on the TV screen for a long period of time, it will be imprinted and become a permanent disfigurement on the screen. This is "image burn" or "burn-in" and not covered by the warranty.
- If the aspect ratio of the TV is set to 4:3 for a long period of time, image burn may occur on the letterboxed area of the screen.
- Avoid displaying a fixed image on the TV screen for a long period of time (2 or more hours for LCD) to prevent image burn.

TROUBLESHOOTING

General

| Problem | Resolution |
|--|--|
| Cannot control the TV with the remote control. | <ul style="list-style-type: none"> Check the remote control sensor on the product and try again. Check if there is any obstacle between the product and the remote control. Check if the batteries are still working and properly installed (⊕ to ⊕, ⊖ to ⊖). |
| No image display and no sound is produced. | <ul style="list-style-type: none"> Check if the product is turned on. Check if the power cord is connected to a wall outlet. Check if there is a problem in the wall outlet by connecting other products. |
| The TV turns off suddenly. | <ul style="list-style-type: none"> Check the power control settings. The power supply may be interrupted. Check if the Auto sleep feature is activated in the Time settings. If there is no signal while the TV is on, the TV will turn off automatically after 15 minutes of inactivity. |

Using 3D mode

| Problem | Resolution |
|---|--|
| If you can see a swirling oil-like pattern on the TV when the TV is turned off. | This is caused by the interference of external light in the air layer between the LCD surface and 3D filter. The pattern becomes almost invisible when you turn on the power again. |
| If you are not using the glasses provided with the TV. | When you view 3D images with this TV, it is very important that you use the glasses provided with the TV. The glasses are designed to compensate optically for the 3D filter attached to the surface of the TV. If you wear third-party glasses, you may not see 3D images properly on the TV. |
| If you view 3D images outside the optimal viewing angle or distance. | The optimal viewing angle of this TV is between 12° degrees; the optimal viewing distance is between 50 cm to 150 cm from the TV. When you view 3D images outside the optimal viewing angle or viewing distance, the images may look overlapped or not be displayed properly in 3D. |

Notes for Viewing 3D Image with 3D Digital Brodcasting

*In Analogue Brodcasting, 3D Imaging does not work.

| Problem | Resolution |
|---|---|
| When switching the 2D image display to the 3D image display with the 3D button on the remote control, the overlapped image may be displayed. | <ul style="list-style-type: none"> Disable the 3D imaging mode with the 3D button. The 3D imaging mode is disabled automatically if you change the channel. |
| If the screen is divided into left/right or top/bottom when you change the channel  | This channel supports the 3D imaging mode. Select the 3D imaging type displayed on the screen by pressing the 3D button on the remote control. |
| If your eyes are sore or the screen looks blurry while viewing 3D images. | Select Left/Right or Right/Left option, which you find better for viewing 3D images. |

SPECIFICATIONS

M2252D

M2252T

ENGLISH

| | | |
|---|--|--|
| Panel | Screen Type | 546.1 mm Wide (21.5 inch) Visible diagonal size : 546.1 mm |
| | Pixel Pitch | 0.25 mm (H) x 0.25 mm (V) |
| Video Signal | Max. Resolution | 1920 × 1080 @ 60 Hz |
| | Recommended Resolution | 1920 × 1080 @ 60 Hz |
| | Horizontal Frequency | 30 kHz to 83 kHz |
| | Vertical Frequency | 56 Hz to 75 Hz |
| | Synchronization Type | Separate Sync, Digital |
| Input Connector | M2252D | |
| | TV, D-Sub Analog, SCART, PC Audio In, Component, CVBS, HDMI*2, USB, PCMCIA | |
| | M2252T | |
| | TV, D-Sub Analog, SCART, PC Audio In, Component, CVBS, HDMI*2, USB, PCMCIA, LAN JACK (Only UK) | |
| Power | Rated Voltage | 19 V $\overline{\text{---}}$ 1.6 A |
| | Power Consumption | On Mode : 30 W (typ.) Off Mode ≤ 0.4 W |
| AC/DC Adapter | | Manufacturer: Lien Chang, Model LCAP25A Manufacturer: HONOR, Model ADS-40SG-19-2 19032G |
| Tilt | Tilt Range | -5 to 20° |
| Dimensions (Width x Depth x Height) Weight | With Stand | |
| | 508.6 mm x 182.8 mm x 386.5 mm 3.6 kg | |
| | Without Stand | |
| | 508.6 mm x 62.9 mm x 314.8 mm 3.1 kg | |
| Environmental conditions | Operating Temperature | 10 °C to 35 °C |
| | Operating Humidity | 20 % to 80 % |
| | Storage Temperature | -10 °C to 60 °C |
| | Storage Humidity | 5 % to 90 % |

Product specifications shown above may be changed without prior notice due to upgrade of product functions.

M2352D M2352T DM2352D DM2352T

| | | |
|---|--|---|
| Panel | Screen Type | 584.2 mm Wide (23 inch) Visible diagonal size : 584.2 mm |
| | Pixel Pitch | 0.27 mm (H) x 0.27 mm (V) |
| Video Signal | Max. Resolution | 1920 × 1080 @ 60 Hz |
| | Recommended Resolution | 1920 × 1080 @ 60 Hz |
| | Horizontal Frequency | 30 kHz to 83 kHz |
| | Vertical Frequency | 56 Hz to 75 Hz |
| | Synchronization Type | Separate Sync, Digital |
| Input Connector | M2352D / DM2352D | |
| | TV, D-Sub Analog, SCART, PC Audio In, Component, CVBS, HDMI*2, USB, PCMCIA | |
| | M2352T / DM2352T | |
| | TV, D-Sub Analog, SCART, PC Audio In, Component, CVBS, HDMI*2, USB, PCMCIA, LAN JACK (Only UK) | |
| Power | Rated Voltage | 19 V $\overline{\text{---}}$ 2.0 A |
| | Power Consumption | On Mode : 33 W (typ.) Off Mode ≤ 0.4 W |
| AC/DC Adapter | | Manufacturer: LITE-ON, Model PA-1650-64 Manufacturer: LG Innotek, Model PSAB-L101A |
| Tilt | Tilt Range | -5 to 20° |
| Dimensions (Width x Depth x Height) Weight | With Stand | |
| | 544.1 mm x 182.8 mm x 406.2 mm 3.9 kg | |
| | Without Stand | |
| | 544.1 mm x 62.9 mm x 334.6 mm 3.4 kg | |
| Environmental conditions | Operating Temperature | 10 °C to 35 °C |
| | Operating Humidity | 20 % to 80 % |
| | Storage Temperature | -10 °C to 60 °C |
| | Storage Humidity | 5 % to 90 % |

Product specifications shown above may be changed without prior notice due to upgrade of product functions.

M2452D

M2452T

| | | |
|---|--|---|
| Panel | Screen Type | 609.6 mm Wide (24 inch) Visible diagonal size : 609.6 mm |
| | Pixel Pitch | 0.28 mm (H) x 0.28 mm (V) |
| Video Signal | Max. Resolution | 1920 × 1080 @ 60 Hz |
| | Recommended Resolution | 1920 × 1080 @ 60 Hz |
| | Horizontal Frequency | 30 kHz to 83 kHz |
| | Vertical Frequency | 56 Hz to 75 Hz |
| | Synchronization Type | Separate Sync, Digital |
| Input Connector | M2452D | |
| | TV, D-Sub Analog, SCART, PC Audio In, Component, CVBS, HDMI*2, USB, PCMCIA | |
| | M2452T | |
| | TV, D-Sub Analog, SCART, PC Audio In, Component, CVBS, HDMI*2, USB, PCMCIA, LAN JACK (Only UK) | |
| Power | Rated Voltage | 19 V --- 2.0 A |
| | Power Consumption | On Mode : 33 W (typ.) Off Mode ≤ 0.4 W |
| AC/DC Adapter | | Manufacturer: LITE-ON, Model PA-1650-64 Manufacturer: LG Innotek, Model PSAB-L101A |
| Tilt | Tilt Range | -5 to 20° |
| Dimensions (Width x Depth x Height) Weight | With Stand | |
| | 566.9 mm x 182.8 mm x 417.4 mm 3.4 kg | |
| | Without Stand | |
| | 566.9 mm x 62.9 mm x 345.9 mm 2.9 kg | |
| Environmental conditions | Operating Temperature | 10 °C to 35 °C |
| | Operating Humidity | 20 % to 80 % |
| | Storage Temperature | -10 °C to 60 °C |
| | Storage Humidity | 5 % to 90 % |

Product specifications shown above may be changed without prior notice due to upgrade of product functions.

M2752D

M2752T

DM2752D

DM2752T

| | | |
|---|--|---|
| Panel | Screen Type | 685.65 mm Wide (27 inch) Visible diagonal size : 685.65 mm |
| | Pixel Pitch | 0.31 mm (H) x 0.31 mm (V) |
| Video Signal | Max. Resolution | 1920 × 1080 @ 60 Hz |
| | Recommended Resolution | 1920 × 1080 @ 60 Hz |
| | Horizontal Frequency | 30 kHz to 83 kHz |
| | Vertical Frequency | 56 Hz to 75 Hz |
| | Synchronization Type | Separate Sync, Digital |
| Input Connector | M2752D / DM2752D | |
| | TV, D-Sub Analog, SCART, PC Audio In, Component, CVBS, HDMI*2, USB, PCMCIA | |
| | M2752T / DM2752T | |
| | TV, D-Sub Analog, SCART, PC Audio In, Component, CVBS, HDMI*2, USB, PCMCIA, LAN JACK (Only UK) | |
| Power | Rated Voltage | 19 V $\overline{\text{---}}$ 2.0 A |
| | Power Consumption | On Mode : 35 W (typ.) Off Mode ≤ 0.4 W |
| AC/DC Adapter | | Manufacturer: LITE-ON, Model PA-1650-64 Manufacturer: LG Innotek, Model PSAB-L101A |
| Tilt | Tilt Range | -5 to 20° |
| Dimensions (Width x Depth x Height) Weight | With Stand | |
| | 641.3 mm x 199.4 mm x 458.8 mm 5.55 kg | |
| | Without Stand | |
| | 641.3 mm x 53 mm x 391.1 mm 4.6 kg | |
| Environmental conditions | Operating Temperature | 10 °C to 35 °C |
| | Operating Humidity | 20 % to 80 % |
| | Storage Temperature | -10 °C to 60 °C |
| | Storage Humidity | 5 % to 90 % |

Product specifications shown above may be changed without prior notice due to upgrade of product functions.

RGB (PC) / HDMI (PC) supported mode

| Resolution | Horizontal Frequency(kHz) | Vertical Frequency(Hz) |
|-------------|---------------------------|------------------------|
| 720 x 400 | 31.468 | 70.080 |
| 640 x 480 | 31.469 | 59.940 |
| 640 x 480 | 37.500 | 75.000 |
| 800 x 600 | 37.879 | 60.317 |
| 800 x 600 | 46.875 | 75.000 |
| 1024 x 768 | 48.363 | 60.004 |
| 1024 x 768 | 60.023 | 75.029 |
| 1152 x 864 | 67.500 | 75.000 |
| 1280 x 720 | 45.000 | 60.000 |
| 1280 x 800 | 49.702 | 59.810 |
| 1280 x 1024 | 63.981 | 60.020 |
| 1280 x 1024 | 79.976 | 75.025 |
| 1400 x 1050 | 65.317 | 59.978 |
| 1440 x 900 | 55.935 | 59.887 |
| 1600 x 900 | 60.000 | 60.000 |
| 1680 x 1050 | 64.674 | 59.883 |
| 1680 x 1050 | 65.290 | 59.954 |
| 1920 x 1080 | 67.500 | 60.000 |

Component supported mode

| Resolution | Horizontal Frequency(kHz) | Vertical Frequency(Hz) |
|-------------|---------------------------|------------------------|
| 720 x 480 | 15.730 | 59.940 |
| 720 x 480 | 15.750 | 60.000 |
| 720 x 576 | 15.625 | 50.000 |
| 720 x 480 | 31.470 | 59.940 |
| 720 x 480 | 31.500 | 60.000 |
| 720 x 576 | 31.250 | 50.000 |
| 1280 x 720 | 44.960 | 59.940 |
| 1280 x 720 | 45.000 | 60.000 |
| 1280 x 720 | 37.500 | 50.000 |
| 1920 x 1080 | 33.720 | 59.940 |
| 1920 x 1080 | 33.750 | 60.000 |
| 1920 x 1080 | 28.125 | 50.000 |
| 1920 x 1080 | 56.250 | 50.000 |
| 1920 x 1080 | 67.432 | 59.940 |
| 1920 x 1080 | 67.500 | 60.000 |

HDMI (DTV) supported mode

| Resolution | Horizontal Frequency(kHz) | Vertical Frequency(Hz) |
|-------------|---------------------------|------------------------|
| 720 x 480 | 31.469 31.500 | 59.940 60.000 |
| 720 x 576 | 31.250 | 50.000 |
| 1280 x 720 | 37.500 | 50.000 |
| 1280 x 720 | 44.960 45.000 | 59.940 60.000 |
| 1920 x 1080 | 33.720 33.750 | 59.940 60.000 |
| 1920 x 1080 | 28.125 | 50.000 |
| 1920 x 1080 | 27.000 | 24.000 |
| 1920 x 1080 | 33.750 | 30.000 |
| 1920 x 1080 | 56.250 | 50.000 |
| 1920 x 1080 | 67.430 67.500 | 59.940 60.000 |

Component port connecting information

| | | | |
|----------------------------------|---|----------------|----------------|
| Component ports on the TV | Y | P _B | P _R |
| Video output ports on DVD player | Y | P _B | P _R |
| | Y | B-Y | R-Y |
| | Y | Cb | Cr |
| | Y | Pb | Pr |

**NOTE**

- Avoid keeping a fixed image on the set's screen for prolonged periods of time. The fixed image may become permanently imprinted on the screen. Use a screen saver when possible.
- There may be interference relating to resolution, vertical pattern, contrast or brightness in PC mode. Change the PC mode to another resolution or change the refresh rate to another rate or adjust the brightness and contrast on the menu until the picture is clear. If the refresh rate of the PC graphic card can not be changed, change the PC graphic card or consult the manufacturer of the PC graphic card.
- The synchronization input waveform for Horizontal and Vertical frequencies are separate.
- Connect the signal cable from the TV output port of the PC to the RGB (PC) port of the TV or the signal cable from the HDMI output port of the PC to the HDMI/DVI IN port on the TV.
- Connect the audio cable from the PC to the Audio input on the TV. (Audio cables are not included with the TV).
- If using a sound card, adjust PC sound as required.
- If the graphic card on the PC does not output analogue and digital RGB simultaneously, connect only one of either RGB or HDMI/DVI IN to display the PC output on the TV.
- If the graphic card on the PC does output analogue and digital RGB simultaneously, set the TV to either RGB or HDMI. (The other mode is set to Plug and Play automatically by the TV.)
- DOS mode may not work depending on the video card if you use an HDMI to DVI cable.
- If you use too long an RGB-PC cable that is too long, there may be interference on the screen. We recommend using under 5 m of cable. This provides the best picture quality.

3D video input format supported. (Only CINEMA 3D TV)

| | Signal | Resolution | Horizontal Frequency (kHz) | Vertical Frequency (Hz) | Playable 3D video format |
|------|---------------|-------------|----------------------------|----------------------------------|--|
| HDMI | 720p | 1280 x 720 | 89.9 90 | 59.94 60 | Frame Packing |
| | | | 45 | 60 | Side by Side(half), Top & Bottom |
| | 1080i | 1920 x 1080 | 33.7 | 60 | Side by Side(half), Top & Bottom |
| | 1080p | 1920 x 1080 | 53.95 54 | 23.98 24 | Frame packing |
| | | | 67.5 | 60 | Side by Side, Top & Bottom, Single Frame Sequential |
| | | | 27 | 24 | Side by Side(half), Top & Bottom |
| | | 33.7 | 30 | Side by Side(half), Top & Bottom | |
| RGB | 1080p | 1920 x 1080 | 67.5 | 60 | Side by Side, Top & Bottom |
| USB | 1080p | 1920 x 1080 | 33.75 | 30 | Side by Side, Top & Bottom, MPO(Photo) |
| | Signal | | | | Playable 3D video format |
| DTV | 720p, 1080i | | | | Side by Side, Top & Bottom |

 **NOTE**

- If HDMI input is received in HDMI 3D format, images are automatically converted into 3D.
- **2D → 3D** mode is available to watch for all signals.
- If you change **2D → 3D** mode, the left and right edges of the screen are clipped.
- If you select HDMI 3D, 3D mode is automatically enabled, which may cause the delay of screen turning on.
- For some 3D content files, if a 3D file is converted into 2D, the left and right edges of the screen may appear truncated.



Make sure to read the Safety Precautions before using the product.

Keep the Owner's Manual (CD) in an accessible place for future reference. The model and serial number of the TV is located on the back and one side of the TV. Record it below should you ever need service.

MODEL _____

SERIAL _____

To obtain the source code under GPL, LGPL, MPL and other open source licenses, that is contained in this product, please visit <http://opensource.lge.com>.

In addition to the source code, all referred license terms, warranty disclaimers and copyright notices are available for download. LG Electronics will also provide open source code to you on CD-ROM for a charge covering the cost of performing such distribution (such as the cost of media, shipping and handling) upon email request to opensource@lge.com. This offer is valid for three (3) years from the date on which you purchased the product.

■■■ Regulatory Information cont.

:: FCC Compliance Statement

This equipment has been tested and found to comply within the limits of a Class B digital device pursuant to Part 15 of the FCC Rules. These limits are designed to provide reasonable protection against harmful interference in a residential installation.

This equipment generates, uses, and can radiate radio frequency energy and if not installed and used in accordance with the instructions, may cause harmful interference to radio communications. However, there is no guarantee that interference will not occur in a particular installation.

If this equipment does cause harmful interference to radio or television reception (which can be determined by turning the equipment on and off), the user is encouraged to try to correct the interference by using one or more of the following measures:

- Reorient or relocate the receiving antenna.
- Increase the separation between the equipment and the receiver.
- Connect the equipment into an outlet on a circuit different from that to which the receiver is connected.
- Consult the dealer or an experienced radio/TV technician for help.

Caution: Changes or modifications not expressly approved by the party responsible for compliance could void the user's (or your) authority to operate the equipment. Only peripherals (digital input/output devices, terminals, printers, etc.) certified to comply with the Class B limits may be attached to this monitor. Operation with non-certified peripherals is likely to result in interference to radio and TV reception. Only shielded signal cables may be used with this System.

NOTICE

The regulations are applied only to the products with the ID LABEL indicating specific requirements.

:: Canadian DOC Notice

This Class B digital apparatus meets all requirements of the Canadian Interference-Causing Equipment Regulations. Cet appareil numérique de la classe B

respecte toutes les exigences du Règlement sur le matériel brouilleur du Canada.

NOTICE

The regulations are applied only to the products with the ID LABEL indicating specific requirements.

:: CE Conformity Notice (for Europe)

Products with the "CE" Marking comply with the EMC Directive(89/336/EEC) and LOW VOLTAGE Directive (73/23/EEC) issued by the Commission of the European Community.

Compliance with these directives implies conformity to the following European Norms :

- EN 55022 ; Radio Frequency Interference
- EN 55024 ; Electromagnetic Immunity
- EN 61000-3-2 ; Power Line Harmonics
- EN 61000-3-3 ; Voltage Fluctuations
- EN 60950-1 ; Product Safety

NOTICE

The regulations are applied only to the products with the ID LABEL indicating specific requirements.

:: Low Radiation Compliance (MPR II)

This monitor meets one of the strictest guidelines available today for low radiation emissions, offering the user extra shielding and an antistatic screen coating. These guidelines, set forth by a government agency in Sweden, limit the amount of emission allowed in the Extremely Low Frequency (ELF) and Very Low Frequency (VLF) electromagnetic range.

:: TCO'99 (TCO'99 applied model only)



Congratulations!

You have just purchased a TCO'99 approved and labelled product! Your choice has provided you with a product developed for professional use. Your purchase has also contributed to reducing the burden on the environment and also to the further development of environmentally adapted electronics products.

■■■ Regulatory Information cont.

Why do we have environmentally labelled computers?

In many countries, environmental labelling has become an established method for encouraging the adaptation of goods and services to the environment. With the growing manufacture and usage of electronic equipment throughout the world, there is a recognized concern for the materials and substances used by electronic products with regards to their eventual recycling and disposal. By proper selection of these materials and substances, the impact on the environment can be minimized.

There are also other characteristics of a computer, such as energy consumption levels, that are important from the viewpoints of both the work (internal) and natural (external) environments. Electronic equipment in offices is often left running continuously, resulting in unnecessary consumption of large amounts of energy and additional power generation. From the standpoint of carbon dioxide emissions alone, it is vital to save energy.

What does labelling involve?

The product meets the requirements for the TCO'99 scheme which provides for international and environmental labelling of personal computers and/or displays.

The labelling scheme was developed as a joint effort by the TCO (The Swedish Confederation of Professional Employees), Svenska Naturskyddsforeningen (The Swedish Society for Nature Conservation) and Statens Energimyndighet (The Swedish National Energy Administration).

Approval requirements cover a wide range of issues: ecology, ergonomics, emission of electrical and magnetical fields, energy consumption and electrical safety.

Ecological criteria impose restrictions on the presence and use of heavy metals, brominated and chlorinated flame retardants, and other substances. The product must be prepared for recycling and the manufacturing site(s) shall be certified according to ISO14001 or EMAS registered.

Energy requirements include a demand that the system unit and/or display, after a certain period of inactivity, shall reduce its power consumption to a lower level in one or more stages. The length of time to reactivate the system unit shall be reasonable for the user.

Labelled products must meet strict environmental demands, for example, in respect of the reduction of electrical and magnetical fields as well as work load and

visual ergonomics.

Below you will find a brief summary of the ecological requirements met by this product. The complete ecological criteria document can be found at TCO Development's website <http://www.tcodevelopment.com> or may be ordered from:

TCO Development

SE-114 94 STOCKHOLM, Sweden

Fax: +46 8 782 92 07

Email : development@tco.se

Information regarding TCO'99 approved and labelled products may also be obtained at <http://www.tcodevelopment.com>

Ecological requirements

Flame retardants

Flame retardants may be present in printed wiring board laminates, cables, and housings. Their purpose is to prevent, or at least to delay the spread of fire. Up to 30% by weight of the plastic in a computer casing can consist of flame retardant substances. Many flame retardants contain bromine or chlorine, and these flame retardants are chemically related to PCBs (polychlorinated biphenyls). Both the flame retardants containing bromine or chlorine and the PCBs are suspected of giving rise to health effects, including reproductive damage in fish-eating birds and mammals, due to the bio-accumulative* processes when not disposed of in accordance with strict standards for disposal.

TCO'99 requires that plastic components weighing more than 25 grams shall not contain flame retardants with organically bound bromine or chlorine. Flame retardants are allowed in the printed wiring board laminates due to the lack of commercially available alternatives.

Cadmium**

Cadmium is present in rechargeable batteries and in the colour-generating layers of certain computer displays. TCO'99 requires that batteries, the colour-generating layers of display screens, and the electrical or electronics components shall not contain any cadmium.

Mercury**

Mercury is sometimes found in batteries, relays and switches. TCO'99 requires that batteries shall not contain any mercury. It also demands that mercury is not present in any of the electrical or electronics components associated with the labelled unit. There is however one

■■■ Regulatory Information cont.

exception. Mercury is, for the time being, permitted in the back light system of flat panel monitors as there today is no commercially available alternative. TCO aims on removing this exception when a mercury free alternative is available.

Lead**

Lead can be found in picture tubes, display screens, solders and capacitors. TCO'99 permits the use of lead due to the lack of commercially available alternatives, but in future requirements TCO Development aims at restricting the use of lead.

* **Bio-accumulative is defined as substances which accumulate in living organisms.**

** **Lead, Cadmium and Mercury are heavy metals which are bio-accumulative.**

:: TCO'03 (TCO'03 applied model only)



Congratulations!

The display you have just purchased carries the TCO'03 Displays label.

This means that your display is designed, manufactured and tested according to some of the strictest quality and environmental requirements in the world. This makes for a high performance product, designed with the user in focus that also minimizes the impact on our natural environment. Some of the features of the TCO'03 Display requirements:

Ergonomics

- Good visual ergonomics and image quality in order to improve the working environment for the user and to reduce sight and strain problems. Important parameters are luminance, contrast, resolution, reflectance, colour rendition and image stability.

Energy

- Energy-saving mode after a certain time – beneficial both for the user and the environment
- Electrical safety

Emissions

- Electromagnetic fields

- Noise emissions

Ecology

- The product must be prepared for recycling and the manufacturer must have a certified environmental management system such as EMAS or ISO 14 001
- Restrictions on
 - chlorinated and brominated flame retardants and polymers
 - heavy metals such as cadmium, mercury and lead.

The requirements included in this label have been developed by TCO Development in co-operation with scientists, experts, users as well as manufacturers all over the world. Since the end of the 1980s TCO has been involved in influencing the development of IT equipment in a more user-friendly direction. Our labelling system started with displays in 1992 and is now requested by users and IT-manufacturers all over the world.

For more information, please visit
www.tcodevelopment.com

English

Information for Environmental Preservation

LGE. announced the 'LG Declaration for a Cleaner Environment' in 1994, and this ideal has served as a guiding managerial principle ever since. The Declaration is a foundation that has allowed us to undertake environmentally friendly activities in careful consideration of economic, environmental, and social aspects.

We promote activities for environmental preservation, and we specifically develop our products to embrace the concept of environment-friendly.

We minimize the hazardous materials contained in our products. For example, there is no cadmium to be found in our monitors.

Information for recycling

This monitor may contain parts which could be hazardous to the environment. It is important that this monitor be recycled after use.

LGE. handles all waste monitors through an environmentally acceptable recycling method. There are several take-back and recycling systems currently in

■■■ Regulatory Information cont.

operation worldwide. Many parts will be reused and recycled, while harmful substances and heavy metals are treated by an environmentally friendly method.

If you want to find out more information about our recycling program, please contact your local LG vendor or a corporate representative of LG.

We set our vision and policies on a cleaner world by selecting the issue of the global environment as a task for corporate improvement. Please visit our website for more information about our 'green' policies.

<http://www.lge.com/about/environment/html/Recycling.jsp>

■ ■ ■ Deutsch

Informationen zur Erhaltung der Umwelt

Im Jahr 1994 verkündete LGE die 'LG Declaration for a Cleaner Environment' (LG Erklärung für eine sauberere Umwelt). Seitdem dient dieses Ideal als führendes Prinzip des Unternehmens. Diese Erklärung war die Basis für die Durchführung von

umweltfreundlichen Aktivitäten, wobei wirtschaftliche, umweltbezogene und soziale Aspekte in die Überlegungen mit einbezogen wurden.

Wir fördern Aktivitäten zum Schutz der Umwelt und die Entwicklung unserer Produkte ist darauf ausgerichtet, unserem Konzept bezüglich Umweltfreundlichkeit gerecht zu werden.

Wir sind darauf bedacht, den Anteil der in unseren Produkten enthaltenen schädlichen Materialien zu minimieren. So ist in unseren Monitoren beispielsweise kein Kadmium zu finden.

Informationen zum Thema Recycling

Dieser Monitor enthält Teile, die umweltschädlich sein können. Es ist unbedingt erforderlich, dass der Monitor recycelt wird, nachdem er außer Dienst gestellt wurde.

Bei LGE werden alle ausrangierten Monitore in einem unter umweltbezogenen Aspekten geeigneten Verfahren recycelt. Augenblicklich sind weltweit mehrere Rücknahme- und Recyclingsysteme im Einsatz. Viele Teile werden wieder verwendet und recycelt. Schädliche Substanzen und Schwermetalle werden durch umweltverträgliche Verfahren behandelt.

Falls Sie mehr über unser Recyclingprogramm erfahren möchten, wenden Sie sich bitte an Ihren lokalen LG-Händler oder einen Unternehmensvertreter von LG.

Wir richten unsere Firmenpolitik auf eine sauberere Umwelt hin aus, indem wir umweltspezifische Aspekte als wichtigen Punkt in die Weiterentwicklung unseres Unternehmens einfließen lassen. Zusätzliche Informationen über unsere 'grüne' Firmenpolitik erhalten Sie auf unserer Website.

<http://www.lge.com/about/environment/html/Recycling.jsp>

■ ■ ■ Français

Information sur la protection de l'environnement

LGE a publié sa 'Déclaration en faveur d'un environnement plus propre' en 1994 et celle-ci est restée, depuis lors, un principe directeur de notre entreprise. Cette déclaration a servi de base à notre réflexion et nous a permis de prendre en compte à la fois les aspects économiques et sociaux de nos activités, tout en respectant l'environnement.

Nous encourageons les activités en faveur de la préservation de l'environnement et c'est dans cet esprit que nous développons nos produits : nous réduisons au minimum les matières dangereuses qui entrent dans leur composition et l'on ne trouve pas de cadmium, par exemple, dans nos moniteurs.

Information sur le recyclage

Ce moniteur peut contenir des composants qui présentent un risque pour l'environnement. Il est donc important que celui-ci soit recyclé après usage.

LGE traite les moniteurs en fin de cycle conformément à une méthode de recyclage respectueuse de l'environnement. Nous reprenons nos produits et les recyclons dans plusieurs sites répartis dans le monde entier. De nombreux composants sont réutilisés et recyclés, et les matières dangereuses, ainsi que les métaux lourds, sont traités selon un procédé écologique.

Si vous souhaitez plus de renseignements sur notre programme de recyclage, veuillez contacter votre revendeur LG ou un l'un de nos représentants.

Nous voulons agir pour un monde plus propre et croyons au rôle de notre entreprise dans l'amélioration de l'environnement. Pour plus de renseignements sur notre politique "verte", rendez visite à notre site :

<http://www.lge.com/about/environment/html/Recycling.jsp>

Regulatory Information cont.

Italiano

Informazioni per la tutela dell'ambiente

La LGE. ha annunciato nel 1994 la cosiddetta 'LG Declaration for a Cleaner Environment' (Dichiarazione di LG a favore di un ambiente più pulito), un ideale che da allora funge da principio ispiratore della gestione aziendale. La dichiarazione rappresenta il fondamento che consente di intraprendere attività a favore dell'ambiente tenendo conto degli aspetti economici, ambientali e sociali. Noi della LG, promuoviamo attività a favore della tutela dell'ambiente sviluppando appositamente i nostri prodotti per cogliere il concetto del rispetto dell'ambiente riducendo i materiali dannosi presenti nei nostri prodotti. Ad esempio nei nostri monitor non è presente il cadmio.

Informazioni per il riciclaggio

Il monitor può presentare componenti che potrebbero risultare eventualmente dannosi per l'ambiente. È importante che il monitor sia riciclato al termine del suo utilizzo.

La LGE. gestisce tutti i monitor di rifiuto con un metodo di riciclaggio soddisfacente dal punto di vista ambientale. In tutto il mondo sono attualmente in funzione numerosi sistemi di riciclaggio e recupero. I diversi componenti sono riutilizzati e riciclati, mentre le sostanze dannose e i metalli pesanti vengono trattati con un metodo rispettoso dell'ambiente.

Se si desiderano maggiori informazioni in merito al programma di riciclaggio, è consigliabile rivolgersi al proprio rivenditore LG o ad un rappresentante aziendale della LG.

Noi della LG impostiamo la nostra visione e le nostre politiche a favore di un mondo più pulito ponendo la questione dell'ambiente dal punto di vista globale come una mansione rivolta al miglioramento della nostra azienda. Vi invitiamo a visitare il nostro sito internet per ulteriori informazioni sulla nostra politica "verde".
<http://www.lge.com/about/environment/html/Recycling.jsp>

Espanol

Información para la conservación medioambiental

LGE. presentó la 'Declaración para un entorno más limpio de LG' en 1994 y este ideal ha servido para guiar nuestros principios empresariales desde entonces. La Declaración es la base que nos ha permitido llevar a cabo tareas que

respetan el medio ambiente siempre teniendo en cuenta aspectos sociales, económicos y medioambientales.

Promocionamos actividades orientadas a la conservación del medio ambiente y desarrollamos nuestros productos específicamente para que se ajusten a la filosofía que protege el entorno.

Reducimos al máximo el uso de materiales de riesgo en nuestros productos. Un ejemplo de ello es la ausencia total de cadmio en nuestros monitores.

Información para el reciclaje

Este monitor puede contener piezas que entrañen riesgos medioambientales. Es importante reciclar este monitor después de su utilización.

LGE. trata todos los monitores usados siguiendo un método de reciclaje que no daña al entorno. Contamos con diversos sistemas de recuperación y reciclaje que funcionan a nivel mundial en la actualidad. Es posible reciclar y reutilizar muchas de las piezas, mientras que las sustancias dañinas y los metales pesados se tratan siguiendo un método que no perjudique al medio ambiente. Si desea obtener más información acerca del programa de reciclaje, póngase en contacto con su proveedor local de LG o con un representante empresarial de nuestra marca.

Basamos nuestra visión y nuestras políticas en un mundo más limpio y para ellos optamos por un entorno global como tarea principal de nuestra evolución como empresa. Visite nuestra página Web para obtener más información sobre nuestras políticas ecológicas.

<http://www.lge.com/about/environment/html/Recycling.jsp>

Português

Informações relacionadas à preservação ambiental

A LGE. anunciou a 'LG Declaration for a Cleaner Environment' (Declaração da LG para um ambiente mais limpo) em 1994 e esse ideal tem servido desde então como um princípio administrativo de orientação. A Declaração é a base que nos tem permitido realizar atividades favoráveis ao ambiente com consideração atenta aos aspectos econômicos, ambientais e sociais.

Promovemos atividades de preservação ambiental e desenvolvemos nossos produtos para englobar

■■■ Regulatory Information cont.

especificamente o conceito de favorável ao ambiente.

Reduzimos os materiais perigosos contidos em nossos produtos. Por exemplo, não há cádmio em nossos monitores.

Informações relacionadas à reciclagem

Este monitor pode conter peças que podem representar riscos ao ambiente. É importante que ele seja reciclado após o uso.

A LGE. cuida de todos os monitores descartados através de um método de reciclagem agradável ao ambiente. Há vários sistemas de devolução e reciclagem atualmente em operação no mundo. Muitas peças serão reutilizadas e recicladas e as substâncias nocivas e os metais pesados passarão por tratamento através de um método favorável ao ambiente.

Para obter mais informações sobre nosso programa de reciclagem, entre em contato com seu fornecedor LG local ou com um representante corporativo da LG.

Definimos nossa visão e nossas políticas relacionadas a um mundo mais limpo selecionando a questão do ambiente global como uma tarefa de aprimoramento corporativo. Visite nosso site para obter mais informações sobre nossas políticas de meio ambiente.

<http://www.lge.com/about/environment/html/Recycling.jsp>

■ ■ ■ Nederlands

Informatie met betrekking tot het behoud van het milieu

LGE. publiceerde in 1994 de 'LG Declaration for a Cleaner Environment' (de LG-verklaring met betrekking tot een schoner milieu). Deze verklaring en het ideaal van een schoner milieu fungeren sindsdien als een bestuurlijke leidraad voor onze onderneming. Op basis van deze verklaring ontplooiën wij milieuvriendelijke activiteiten, waarbij er zowel met sociale en economische aspecten, als met milieuaspecten zorgvuldig rekening wordt gehouden.

Wij ondersteunen activiteiten die zijn gericht op het behoud van het milieu en wij houden bij het ontwikkelen onze producten specifiek rekening met de milieuvriendelijkheid van onze producten.

Wij minimaliseren het gebruik van schadelijke stoffen in onze producten. Er wordt bijvoorbeeld geen cadmium verwerkt in onze monitoren.

Informatie met betrekking tot recycling

Deze monitor bevat materialen die schadelijk zouden kunnen zijn voor het milieu. Het is belangrijk dat deze monitor aan het einde van zijn levensduur wordt gerecycled.

LGE. verwerkt alle afvalmonitoren via een milieuvriendelijke recyclingmethode. Hiervoor worden er momenteel wereldwijd verscheidene inname- en recyclingsystemen gehanteerd. Een groot aantal onderdelen wordt opnieuw gebruikt en gerecycled, waarbij schadelijke stoffen en zware metalen volgens een milieuvriendelijke methode worden verwerkt.

Voor meer informatie over ons recyclingprogramma kunt u contact opnemen met uw plaatselijke LG-vertegenwoordiger of een LG-vestiging.

Onze visie en ons beleid met betrekking tot een schonere wereld vloeien voort uit het feit dat wij het milieu hebben aangemerkt als een onderwerp dat speciale aandacht verdient binnen onze onderneming. Bezoek onze website voor meer informatie over ons 'groene' beleid.

<http://www.lge.com/about/environment/html/Recycling.jsp>

■ ■ ■ Russian

Информация по охране окружающей среды

В 1994 году корпорация LGE опубликовала 'Декларацию LG по охране окружающей среды', которая с тех пор служит основным принципом управления. На основе этой декларации мы смогли предпринять действия, обеспечивающие безопасность окружающей среды, уделяя при этом должное внимание экономическим, экологическим и социальным аспектам.

Мы стимулируем деятельность по охране окружающей среды, уделяя особое внимание разработке нашей продукции в соответствии с концепцией экологической безопасности.

Мы сводим к минимуму содержание опасных веществ в нашей продукции. Например, в наших мониторах вы не найдете кадмия.

Информация по утилизации отходов

Этот монитор может содержать компоненты, которые могут нанести ущерб окружающей среде.

■■■ Regulatory Information cont.

Необходимо утилизировать монитор после использования.

Корпорация LGE перерабатывает все бракованные мониторы с помощью экологически приемлемого метода утилизации отходов. По всему миру действуют системы утилизации отходов и возврата использованной продукции. Многие компоненты будут вторично использованы и утилизированы, в то время как вредные вещества и тяжелые металлы будут обработаны с помощью экологически приемлемого метода.

За более подробной информацией по нашей программе утилизации отходов обращайтесь к местному поставщику или представителю корпорации LG.

Мы ориентируемся на обеспечение экологической безопасности, ставя себе целью глобальную защиту окружающей среды. Дополнительную информацию о нашей политике по охране окружающей среды вы можете найти на нашем сайте:
<http://www.lge.com/about/environment/html/Recycling.jsp>

한국어

환경 보존 정보

LG 전자는 1994년 'LG 환경 선언문'을 발표한 후 현재까지 이를 기업 경영의 이념으로 삼아왔습니다. 이 선언문을 바탕으로 LG 전자는 모든 경영 활동에서 경제성뿐만 아니라 환경성 및 사회성을 주요 의사 결정의 기준으로 삼음으로써 지속적으로 환경 친화적인 경영을 전개하고 있습니다.

본사는 보다 활발한 환경 보존 활동과 더불어 환경 친화적 제품 개발에 주력해 왔습니다.

또한 제품에 포함되는 환경 위해 요소를 최소화하는 데에도 노력을 기울이지 않고 있습니다. LG 전자 모니터의 경우 카드뮴을 전혀 사용하지 않는 것에서도 이러한 노력을 알 수 있습니다.

재활용 정보

본 모니터에는 환경에 위해를 주는 부품이 포함되어 있을 수도 있습니다. 따라서 사용이 끝난 모니터는 재활용하는 것이 좋습니다.

폐모니터는 모두 환경 친화적 방식으로 처리됩니다. 현재 세계적으로 운영되고 있는 회수 및 재활용 시스템에는

여러 가지가 있습니다. 대부분의 부품의 경우 재사용 또는 재활용되지만 환경 위해 물질과 중금속은 환경 친화적 방법으로 처리됩니다.

본사의 재활용 프로그램에 대한 자세한 정보는 각 지역의 LG 공급업체나 LG 기업 대표부에 문의하시기 바랍니다.

LG 전자는 기업 개선 정책의 하나로 지구 환경 문제를 채택함으로써 보다 나은 환경을 만들어 나가기 위한 비전과 정책을 수립했습니다. 본사의 친환경 정책에 대한 자세한 정보를 보시려면 아래의 웹 사이트를 방문하십시오.

http://www.lge.co.kr/cckr/about/environ/purity_02.jsp

∴EPA (EPA applied model only)

ENERGY STAR is a set of power-saving guidelines issued by the U.S. Environmental Protection Agency(EPA).



As an ENERGY STAR Partner LGE U. S. A.,Inc. has determined that this product meets the ENERGY STAR guidelines for energy efficiency.

∴NOM MARK (Mexico only)



Regulatory Information cont.

:: WEEE (for Europe)



English

Disposal of your old appliance

1. When this crossed-out wheeled bin symbol is attached to a product it means the product is covered by the European Directive 2002/96/EC.
2. All electrical and electronic products should be disposed of separately from the municipal waste stream via designated collection facilities appointed by the government or the local authorities.
3. The correct disposal of your old appliance will help prevent potential negative consequences for the environment and human health.
4. For more detailed information about disposal of your old appliance, please contact your city office, waste disposal service or the shop where you purchased the product.

French

Élimination de votre ancien appareil

1. Ce symbole, représentant une poubelle sur roulettes barrée d'une croix, signifie que le produit est couvert par la directive européenne 2002/96/EC.
2. Les éléments électriques et électroniques doivent être jetés séparément, dans les vide-ordures prévus à cet effet par votre municipalité.
3. Une élimination conforme aux instructions aidera à réduire les conséquences négatives et risques éventuels pour l'environnement et la santé humaine.
4. Pour plus d'information concernant l'élimination de votre ancien appareil, veuillez contacter votre mairie, le service des ordures ménagères ou encore la magasin où vous avez acheté ce produit.

Italian

Smaltimento delle apparecchiature obsolete

1. Quando su un prodotto è riportato il simbolo di

un bidone della spazzatura barrato da una croce significa che il prodotto è coperto dalla direttiva europea 2002/96/EC.

2. Tutti i prodotti elettrici ed elettronici dovrebbero essere smaltiti separatamente rispetto alla raccolta differenziata municipale, mediante impianti di raccolta specifici designati dal governo o dalle autorità locali.
3. Il corretto smaltimento delle apparecchiature obsolete contribuisce a prevenire possibili conseguenze negative sulla salute umana e sull'ambiente.
4. Per informazioni più dettagliate sullo smaltimento delle apparecchiature obsolete, contattare il comune, il servizio di smaltimento rifiuti o il negozio in cui è stato acquistato il prodotto.

Swedish

Kassering av din gamla apparat

1. När den här symbolen med en överkryssad soptunna på hjul sitter på en produkt innebär det att den regleras av European Directive 2002/96/EC.
2. Alla elektriska och elektroniska produkter bör kasseras via andra vägar än de som finns för hushållsavfall, helst via för ändamålet avsedda uppsamlingsanläggningar som myndigheterna utser.
3. Om du kasserar din gamla apparat på rätt sätt så bidrar du till att förhindra negativa konsekvenser för miljön och människors hälsa.
4. Mer detaljerad information om kassering av din gamla apparat kan fås av kommunen, renhållningsverket eller den butik där du köpte produkten.

Dutch

Uw oude toestel wegdoen

1. Als het symbool met de doorgekruiste verrijdbare afvalbak op een product staat, betekent dit dat het product valt onder de Europese Richtlijn 2002/96/EC.
2. Elektrische en elektronische producten mogen niet worden meegegeven met het huishoudelijk afval, maar moeten worden ingeleverd bij speciale inzamelingspunten die door de lokale of landelijke overheid zijn aangewezen.
3. De correcte verwijdering van uw oude toestel helpt negatieve gevolgen voor het milieu en de menselijke gezondheid voorkomen.

Regulatory Information cont.

4. Wilt u meer informatie over de verwijdering van uw oude toestel? Neem dan contact op met uw gemeente, de afvalophaaldienst of de winkel waar u het product hebt gekocht.

Finnish

Vanhonjen laitteiden hävittäminen

1. Tämä merkki tuotteessa tarkoittaa, että tuote kuuluu sähkö- ja elektroniikkalaiteromusta annetun EU-direktiivin 2002/96/EY soveltamisalaan.
2. Kaikki elektroniset laitteet ovat ongelmajätettä, joten ne on toimitettava paikalliseen keräyspisteeseen.
3. Vanhan laitteen asianmukainen hävittäminen ehkäisee mahdollisia ympäristöön ja terveyteen kohdistuvia haittavaikutuksia.
4. Lisätietoa vanhan laitteen hävittämisestä saat ottamalla yhteyden paikallisiin viranomaisiin, kierrätyskeskukseen tai myymälään, josta ostit laitteen.

German

Entsorgung von Altgeräten

1. Wenn dieses Symbol eines durchgestrichenen Abfalleimers auf einem Produkt angebracht ist, unterliegt dieses Produkt der europäischen Richtlinie 2002/96/EC.
2. Alle Elektro- und Elektronik-Altgeräte müssen getrennt vom Hausmüll über dafür staatlich vorgesehenen Stellen entsorgt werden.
3. Mit der ordnungsgemäßen Entsorgung des alten Geräts vermeiden Sie Umweltschäden und eine Gefährdung der persönlichen Gesundheit.
4. Weitere Informationen zur Entsorgung des alten Geräts erhalten Sie bei der Stadtverwaltung, beim Entsorgungsamt oder in dem Geschäft, wo Sie das Produkt erworben haben.

Danish

Sådan smider du dit gamle apparat ud

1. Når der er et tegn med et kryds over en skraldespand, betyder det, at produktet er omfattet af EU-direktiv 2002/96/EC.
2. Alle elektriske og elektroniske produkter skal smides ud et andet sted end gennem den kommunale affaldsordning ved hjælp af specielle indsamlingsfaciliteter, der er organiseret af staten

eller de lokale myndigheder.

3. Korrekt bortskaffelse af dit gamle apparat er med til at forhindre mulige skadevirkninger på miljøet og menneskelig sundhed.
4. Mere detaljerede oplysninger om bortskaffelse af dit gamle apparat kan fås ved at kontakte dit lokale kommunekontor, renovationselskab eller den butik, hvor du købte produktet.

Greek

Απόρριψη της παλιάς σας συσκευής

1. Όταν ένα προϊόν διαθέτει το σύμβολο ενός διαγραμμένου κάλαθου απορριμμάτων, τότε το προϊόν καλύπτεται από την Ευρωπαϊκή Οδηγία 2002/96/ΕΟΚ.
2. Η απόρριψη όλων των ηλεκτρικών και ηλεκτρονικών προϊόντων πρέπει να γίνεται χωριστά από τα γενικά οικιακά απορρίμματα μέσω καθορισμένων εγκαταστάσεων συλλογής απορριμμάτων, οι οποίες έχουν δημιουργηθεί είτε από την κυβέρνηση ή από τις τοπικές αρχές.
3. Η σωστή απόρριψη της παλιάς σας συσκευής θα βοηθήσει στην αποτροπή πιθανών αρνητικών συνπειών ως προς το περιβάλλον και την υγεία του ανθρώπου.
4. Για πιο λεπτομερείς πληροφορίες σχετικά με την απόρριψη της παλιάς σας συσκευής, επικοινωνήστε με το αρμόδιο τοπικό γραφείο, υπηρεσία διάθεσης οικιακών απορριμμάτων ή το μαγαζί από το οποίο αγοράσατε το προϊόν.

Spanish

Cómo deshacerse de aparatos eléctricos y electrónicos viejos

1. Si en un producto aparece el símbolo de un contenedor de basura tachado, significa que éste se acoge a la Directiva 2002/96/CE.
2. Todos los aparatos eléctricos o electrónicos se deben desechar de forma distinta del servicio municipal de recogida de basura, a través de puntos de recogida designados por el gobierno o las autoridades locales.
3. La correcta recogida y tratamiento de los dispositivos inservibles contribuye a evitar riesgos potenciales para el medio ambiente y la salud pública.
4. Para obtener más información sobre cómo deshacerse de sus aparatos eléctricos y electrónicos viejos, póngase en contacto con su ayuntamiento, el servicio de recogida de basuras o el establecimiento donde adquirió el producto.

Regulatory Information cont.

Portuguese

Eliminação do seu antigo aparelho

1. Quando este símbolo de latão cruzado estiver afixado a um produto, significa que o produto é abrangido pela Directiva Europeia 2002/96/EC.
2. Todos os produtos eléctricos e electrónicos devem ser eliminados separadamente do lixo doméstico através de pontos de recolha designados, facilitados pelo governo ou autoridades locais.
3. A eliminação correcta do seu aparelho antigo ajuda a evitar potenciais consequências negativas para o ambiente e para a saúde humana.
4. Para obter informações mais detalhadas acerca da eliminação do seu aparelho antigo, contacte as autoridades locais, um serviço de eliminação de resíduos ou a loja onde comprou o produto.

Slovak

Likvidácia váš ho starého prístroja

1. Keď sa na produkte nachádza tento symbol prečiarknutej smetnej nádoby s kolieskami, znamená to, že daný produkt vyhovuje európskej Smernici č. 2002/96/EC.
2. Všetky elektrické a elektronické produkty by mali byť zlikvidované oddelene od komunálneho odpadu prostredníctvom na to určených zberných zariadení, ktoré boli ustanovené vládou alebo orgánmi miestnej správy.
3. Správnu likvidáciu starých zariadení pomôžete predchádzať potenciálnym negatívnym následkom pre prostredie a ľudské zdravie.
4. Podrobnejšie informácie o likvidácii starých zariadení nájdete na miestnom úrade, v službe na likvidáciu odpadu alebo u predajcu, kde ste tento produkt zakúpili.

Czech

Likvidace starých spotřebičů

1. Pokud je u výrobku uveden symbol pojízdného kontejneru v přeškrtnutém poli, znamená to, že na výrobek se vztahuje směrnice Evropské unie číslo 2002/96/EC.
2. Všechny elektrické a elektronické výrobky by měly být likvidovány odděleně od běžného komunálního odpadu prostřednictvím sběrných zařízení zřízených za tímto účelem vládou nebo místní samosprávou.
3. Správný způsob likvidace starého elektrického spotřebiče pomáhá zamezit možným negativním dopadům na životní prostředí a zdraví.
4. Bližší informace o likvidaci starého spotřebiče získáte u místní samosprávy, ve sběrném zařízení nebo v obchodě, ve kterém jste výrobek zakoupili.

Croatian

Uklanjanje starog aparata

1. Ako se na proizvodu nalazi simbol prekrizhene kante za smeće, to znači da je proizvod pokriven europskom direk-

tivom 2002/96/EC.

2. Električni i elektronski proizvodi ne smiju se odlagati zajedno s komunalnim otpadom, već u posebna odlagališta koja je odredila vlada ili lokalne vlasti.
3. Pravilno odlaganje starog proizvoda sprečiti će potencijalne negativne posljedice po okoliš i zdravlje ljudi.
4. Podrobnije informacije o odlaganju starog proizvoda potražite u gradskom uredu, službi za odlaganje otpada ili u trgovini u kojoj ste kupili proizvod.

Hungarian

Régi eszközök ártalmatlanítása

1. A termékhez csatolt áthúzott, keresek szeméttároló jel jelöli, hogy a termék a 2002/96/EC EU-direktíva hatálya alá esik.
2. Minden elektromos és elektronikai terméket a lakossági hulladéktól elkülönítve kell begyűjteni, a kormány vagy az önkormányzatok által kijelölt begyűjtő eszközök használatával.
3. Régi eszközeinek megfelelő ártalmatlanítása segíthet megelőzni az esetleges egészségre vagy környezetre ártalmas hatásokat.
4. Ha több információra van szüksége régi eszközeinek ártalmatlanításával kapcsolatban, tanulmányozza a vonatkozó környezetvédelmi szabályokat, vagy lépjen kapcsolatba az üzlettel, ahol a terméket vásárolta.

Polish

Utylizacja starych urządzeń

1. Kiedy do produktu dołączony jest niniejszy przekreślony symbol kołowego pojemnika na śmieci, oznacza to, że produkt jest objęty dyrektywą 2002/96/EC.
2. Wszystkie elektryczne i elektroniczne produkty powinny być utylizowane niezależnie od odpadów miejskich, z wykorzystaniem przeznaczonych do tego miejsc składowania wskazanych przez rząd lub miejscowe władze.
3. Właściwy sposób utylizacji starego urządzenia pomoże zapobiec potencjalnie negatywnemu wpływowi na zdrowie i środowisko.
4. Aby uzyskać więcej informacji o sposobach utylizacji starych urządzeń, należy skontaktować się z władzami lokalnymi, przedsiębiorstwem zajmującym się utylizacją odpadów lub sklepem, w którym produkt został kupiony.

■ ■ ■ Regulatory Information cont.

■ ■ Estonian

Kasutuskõlbmatu seadme käitlemise kord

1. Kui seade on märgistatud selle elektri- ja elektroonikaseadmete lahuskogumist märgistava tähisega (ratastega prügikonteineri kujutis, millele on rist peale tõmmatud), tuleb toodet käidelda vastavalt Eurodirektiivile 2002/96/EÜ.
2. Elektri- ja elektroonikaseadmeid ei tohi visata tavalise prügi hulka. Nad kuuluvad lahuskogumisele selleks määratud kogumispunktides.
3. Kasutuskõlbmatu tervikseadme käitlemine tavaprügist lahus on korraldatud selleks, et vältida negatiivseid tagajärgi, mida põhjustaksid seadme osade purunemisel vabaneda võivad ohtlikud jäätmed loodusele või inimorganismile.
4. Täpsemat informatsiooni selle kohta, kuhu ja millal saab ära anda oma kasutamiskõlbmatu elektri- ja elektroonikaseadme, küsige kohalikult omavalitsuselt, prügifirmalt või kaupluselt, kust seadme ostsite.

■ ■ Latvian

Vecās elektroierīces nodošana

1. Ja uz produkta ir simbols ar pārsvītrotu atkritumu tvertni, tas nozīmē, ka produkts ir iekļauts Eiropas direktīvā 2002/96/EC.
2. Visi elektriskie un elektroniskie produkti ir jāutilizē, nododot pašvaldības īpaši noteiktās pieņemšanas vietās. Tos nedrīkst izmest parastās municipalitātes atkritumu urnās.
3. Ievērojot prasības veco elektroierīču utilizēšanā, jūs pasargāsi apkārtējo vidi un cilvēku veselību no iespējami nelabvēlīgajām sekām, kādas varētu rasties, ierīcēm sadaloties nepiemērotā vietā.
4. Lai gūtu plašāku informāciju par veco ierīču utilizēšanas iespējām, sazinieties ar pilsētas pašvaldību, atkritumu savākšanas saimniecību vai veikalu, kurā ierīci iegādājāties.

■ ■ Lithuanian

Senos įrangos atliekų tvarkymas

1. Užbrauktas konteinerio simbolis priverčia ant prekės reiškia, kad įrangą saugo Europos direktyva 2002/96/EC.
2. Visos elektros ir elektroninės įrangos atliekos turi būti renkamos atskirai ir neišmetamos į atliekų konteinerį kartu su kitomis komunalinėmis atliekomis, taikant specialią atliekų surinkimo sistemą, patvirtintą vyriausybės ar vietos valdžios.
3. Teisingas senos įrangos atliekų tvarkymas, padės išvengti neigiamų pasekmių aplinkai ir žmonių sveikatai.
4. Dėl išsamesnės informacijos apie senos įrangos tvarkymą, prašome kreiptis į miesto valdžią, atliekų perdirbimo tarnybą arba parduotuvę, kurioje pirkote įrangą.