



APPENDIX G
: USER'S MANUAL

User's Guide

M4213C

Make sure to read the **Safety Precautions** before using the product.

Keep the User's Guide(CD) in an accessible place for future reference.

See the label attached on the product and give the information to your dealer when you ask for service.



Sellers or users should understand that this device is for public use, not home use.

Connecting the stand

- Only on some models.

1. Take the parts for the stand out of the box and assemble them as shown in the picture.

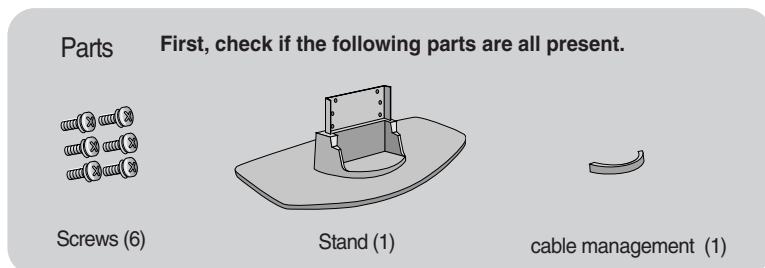

2. Place a soft cloth on the table and put the product with the screen facing downward. Connect the stand as shown in the following picture.

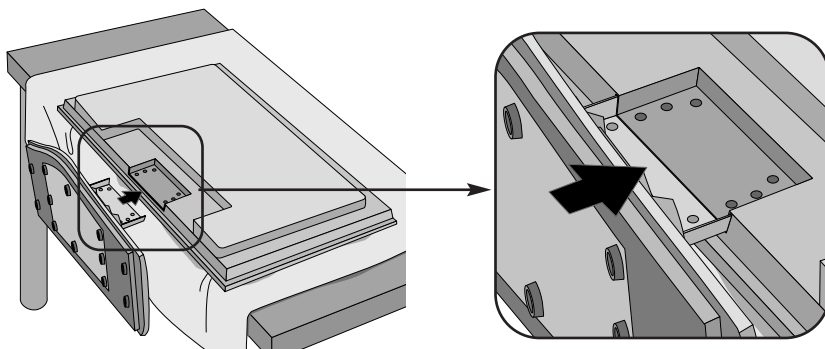

3. Use the screws to secure the stand on the rear side of the product as shown in the diagram.

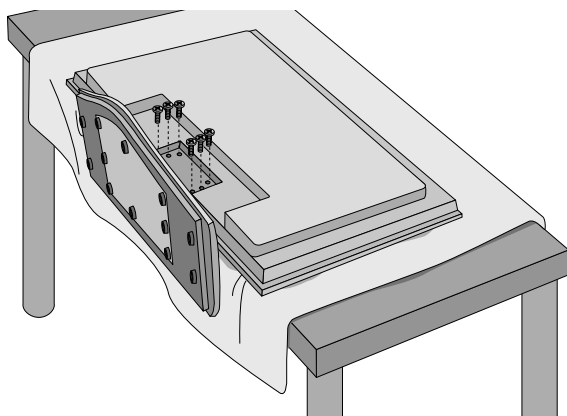

Connecting the Speakers

- Only on some models.

Mount the product onto the speaker by using a screw as shown in the following connect the speaker cable.

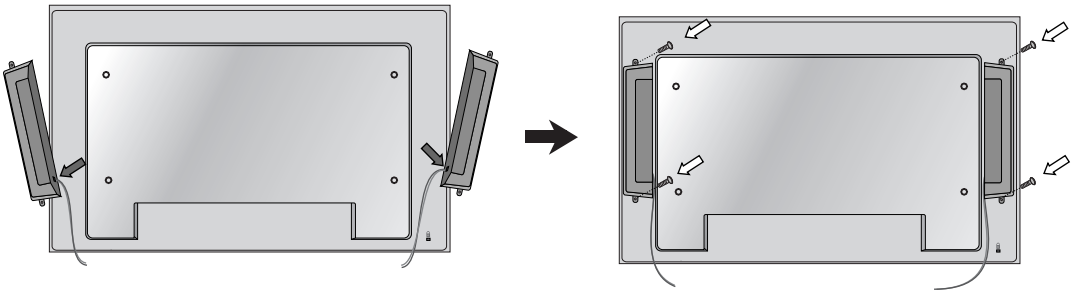

After installing your speakers, use holders and cable ties to organize the speaker cables.

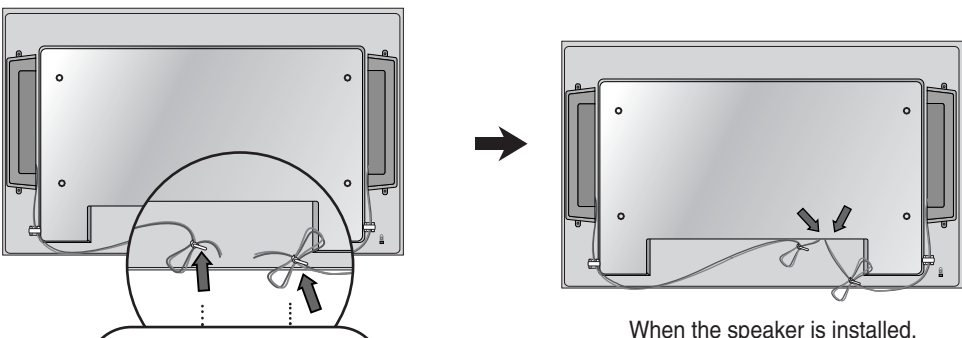
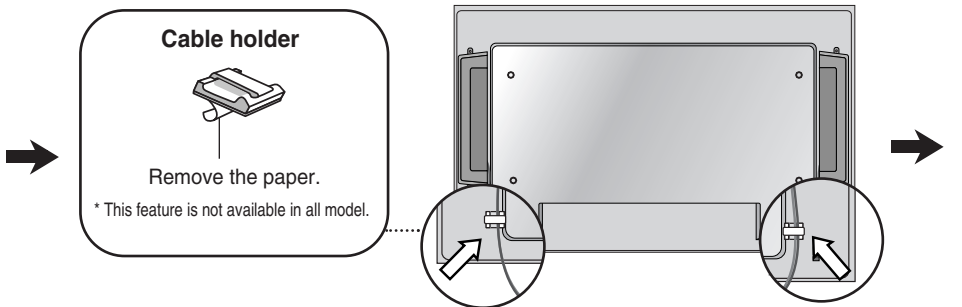

When the speaker is installed.

*Connect the input terminal with a proper color match.

To install Portrait

- Only on some models.

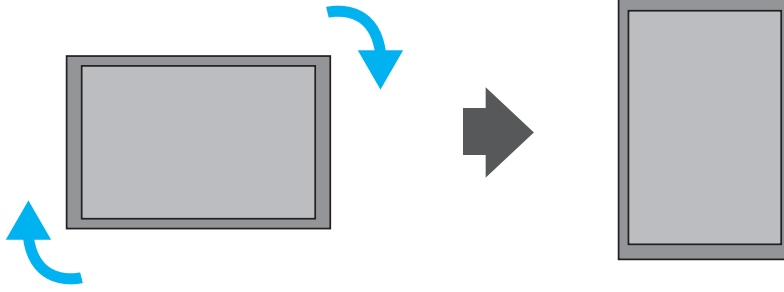

"When installing Portrait, rotate it clockwise based on its front."

Name and Function of the Parts

* The product image in the user's guide could be different from the actual image.

Rear View

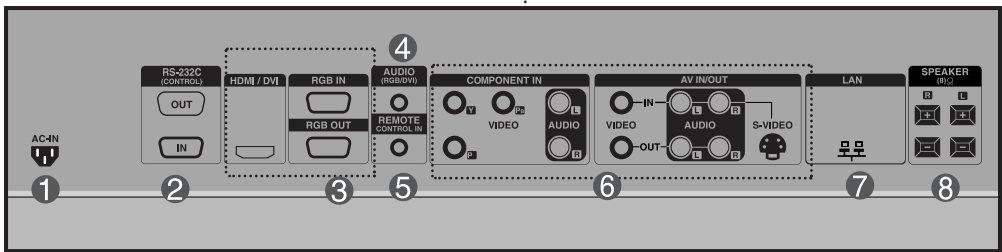
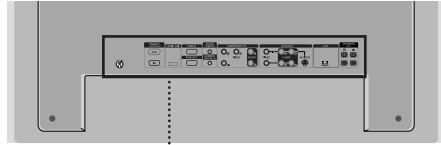

- ❶ **Power Connector : Connect the power cord**
- ❷ **RS-232C Serial Ports**
- ❸ **RGB PC, HDMI/DVI Ports**
-HDMI Supports High Definition input and HDCP (High-bandwidth Digital Content Protection). Some devices require HDCP in order to display HD signals.
- ❹ **PC Sound Jack**
: Connect the audio cable to the *LINE OUT jack of the PC sound card.
- ❺ **Wired Remote Control Port**
- ❻ **AV Ports**
- ❼ **LAN Port**
- ❽ **Speaker Ports**

*LINE OUT

A terminal used to connect to the speaker including a built-in amplifier (Amp). Make sure that the connecting terminal of the PC sound card is checked before connecting. If the Audio Out of PC sound card has only Speaker Out, reduce the PC volume.

If the Audio Out of the PC sound card supports both Speaker Out and Line Out, convert to Line Out using the card jumper of the program (Refer to the Sound Card Manual).

Connecting to External Devices

■ ■ ■ When Connecting to your PC

1 First of all, see if the computer, product and the peripherals are turned off. Then, connect the signal input cable.

- A** When connecting with the D-Sub signal input cable.
- B** When connecting with the HDMI to DVI signal input cable (not included).
* When HDMI PC is used, a compatibility problem might occur.

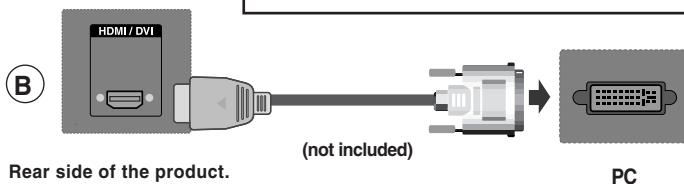
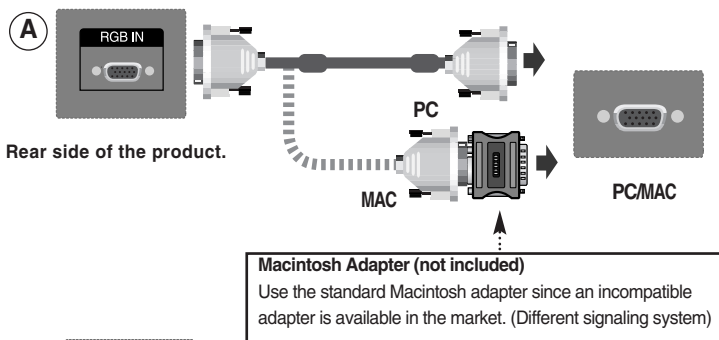

* User must use shielded signal interface cables (D-sub 15 pin cable, DVI cable) with ferrite cores to maintain standard compliance for the product.

2 Connect the Audio cable.



3 Connect the power cord.

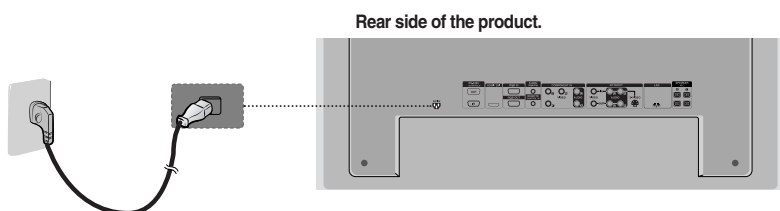

Connecting to External Devices

■ ■ ■ When using the LAN

1 Connect the LAN cable as shown in the below figure .

A Connect PC to Monitor directly

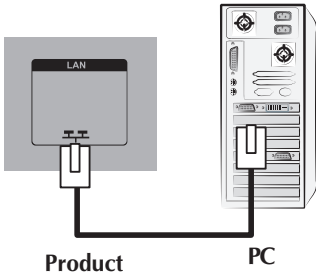

B Using a router(Switch)

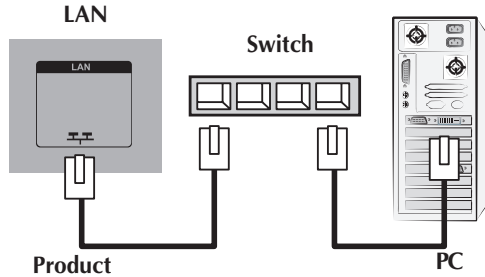

C Using the Internet

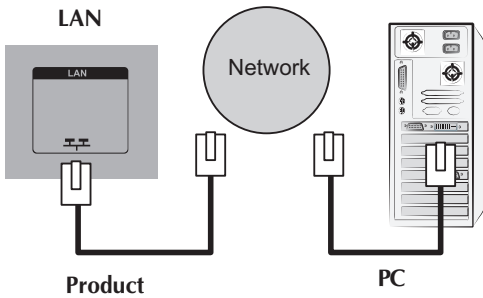

2 Connect the LAN cable and install the eZ-Net Manager program on the CD-ROM. For more information about the program, please refer to eZ-Net Guide in the enclosed CD-ROM.



Note

- Using LAN establishes communication between your PC and the monitor and enables to use the OSD menus on the PC as well as on the monitor.

Connecting to External Devices

■ ■ ■ Daisy Chain Monitors

Use this function when displaying ANALOG RGB inputs of a PC to the other product.

- **To use different products connected to each other**

Connect one end of the signal input cable(15-pin D-Sub Signal Cable) to the **RGB OUT** connector of **product 1** and connect the other end to the RGB IN connector of other products.

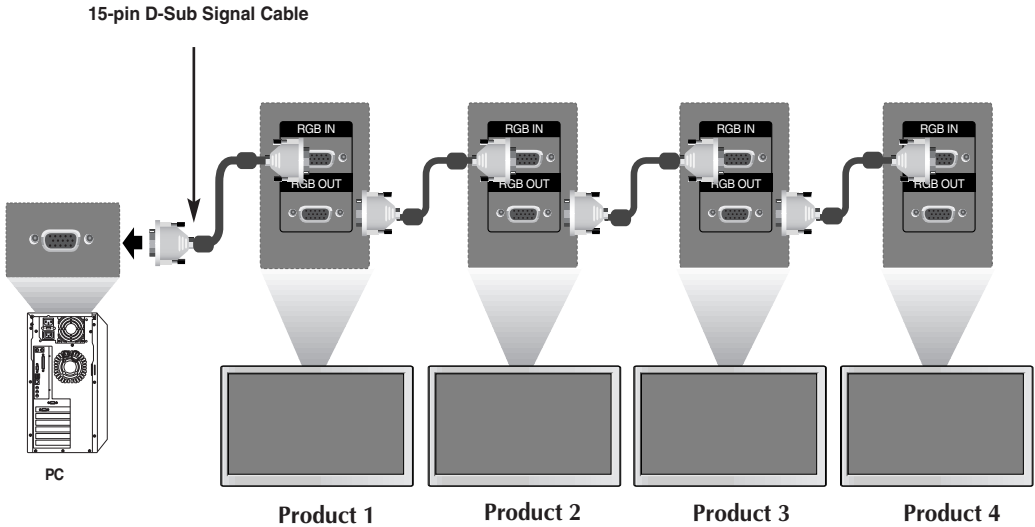

Note

- When multi-connecting in/out cascade format, no loss cables are recommended. We recommend that you should use cable distributor.

Connecting to External Devices

VESA FDMI wall Mounting

This product supports a VESA FDMI compliant mounting interface. These mounts are purchased separately and not available from LG. Refer to the instructions included with wall mount for more info.

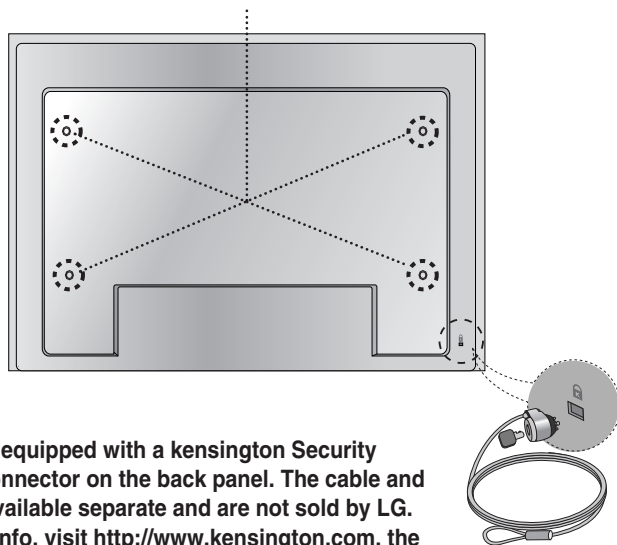

The Set is equipped with a Kensington Security System connector on the back panel. The cable and lock are available separately and are not sold by LG. For more info, visit <http://www.kensington.com>, the internet home page of the Kensington company.

Connecting to External Devices

Video Input

1 Connect the video cable as shown in the below figure and then connect the power cord (See page 7).

- A** When connecting with a BNC cable.
- Connect the input terminal with a proper color match.

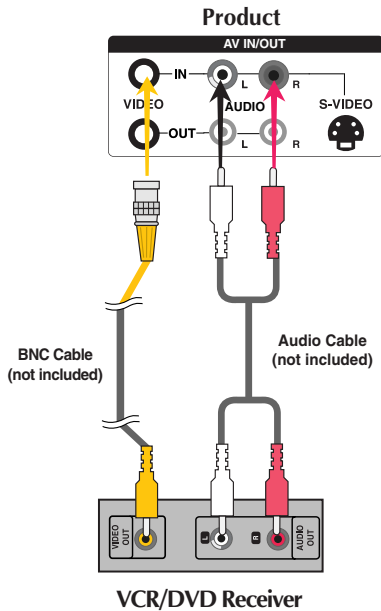

- B** When connecting with a S-Video cable.
- Connect to the S-Video input terminal to watch high image quality movies.

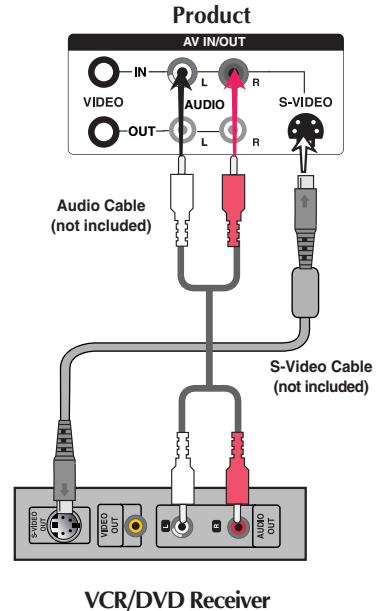

2 Select an input signal.
Press the INPUT button on the remote control to select the input signal.

INPUT → ▼▲ → SET

Or, press the SOURCE button on the back of the product.

SOURCE → ▼▲ → AUTO/SET

- A** When connecting with an BNC cable.
- Select AV.
- B** When connecting with an S-Video cable.
- Select AV.

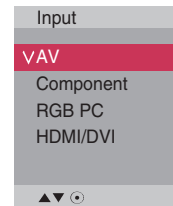

Note • When the BNC cable is connected simultaneously with S-Video cable, S-Video input has a priority.

Connecting to External Devices

■ ■ ■ Component Input (480p/576p/720p/1080p/1080i/480i/576i)

1 Connect the video/audio cable as shown in the below figure and then, connect the power cord (See page 7).

- Connect the input terminal with a proper color match.

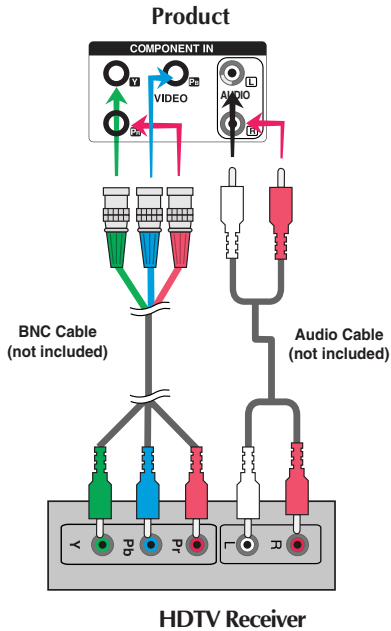

Note

- Some devices may require HDCP in order to display HD signals.
- Component doesn't support HDCP.

2 Select an input signal.

Press the INPUT button on the remote control to select the input signal.

INPUT → ▼▲ → SET

Or, press the SOURCE button on the back of the product.

SOURCE → ▼▲ → AUTO/SET

- Select **Component**

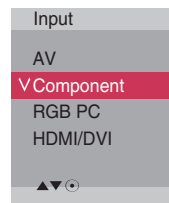

Connecting to External Devices

■ ■ ■ HDMI Input (480p/576p/720p/1080i/1080p)

-HDMI Supports High Definition input and HDCP (High-bandwidth Digital Content Protection). Some devices require HDCP in order to display HD signals.

- 1 Connect the video/audio cable as shown in the below figure and then connect the power cord (See page 7).

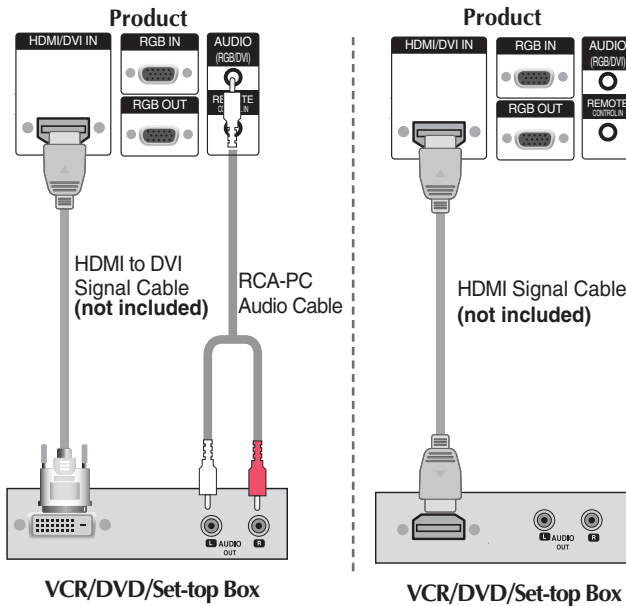

Note : Dolby Digital is not supported.

- 2 Select an input signal.
Press the INPUT button on the remote control to select the input signal.

INPUT → ▼▲ → SET

Or, press the SOURCE button on the back of the product.

SOURCE → ▼▲ → AUTO/SET

When connecting with a HDMI to DVI signal input cable.

When connecting with a HDMI signal input cable.

- Select **HDMI/DVI**

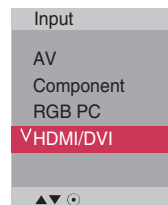

Connecting to External Devices

■ ■ ■ Watching AV Outputs

- When using AV input, you can connect the AV Out to other monitors.

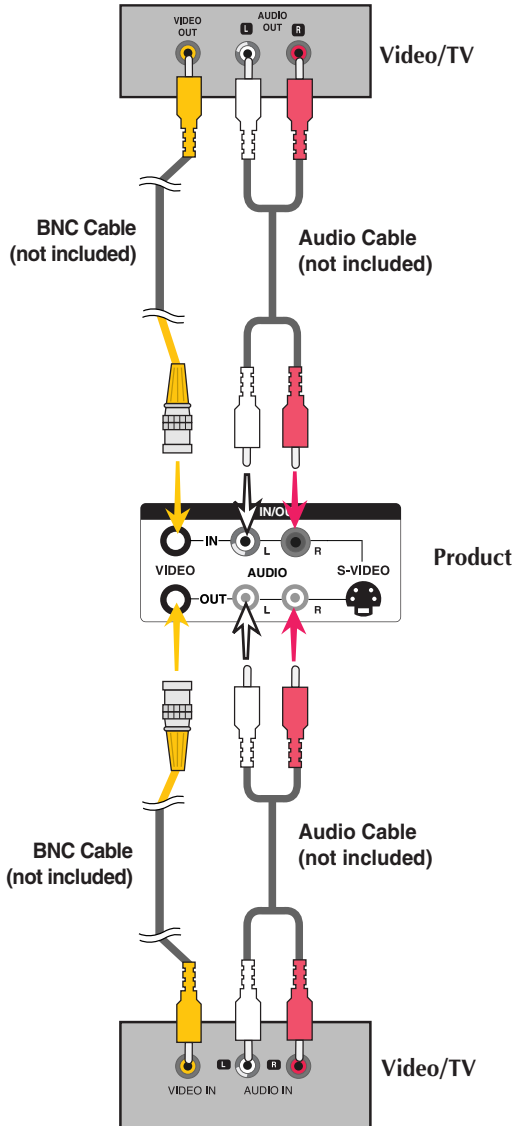

Note

- When multi-connecting in/out cascade format, no loss cables are recommended. We recommend that you should use cable distributor.

Cable management

- Only on some models.

1. Arrange the cables in the center as shown in the following picture.

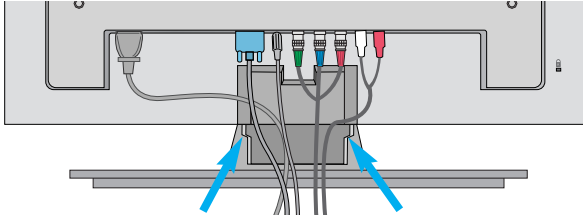

2. Fit the cable guide to the back to help manage the cables.

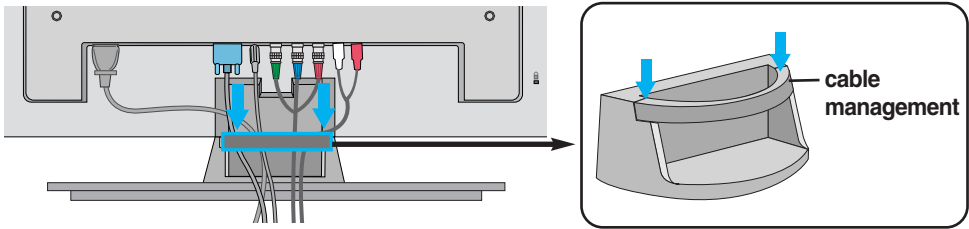

Removing the cable guide.

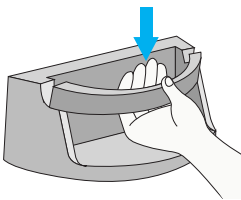

Hold the Cable management with both hands and pull it downward.

Warning

- Do not use the cable management as a handle for the Monitor.

Troubleshooting

No image is displayed

- Is the product power cord connected?
 - Is the power indicator light on?
 - Power is on, power indicator is blue but the screen appears extremely dark.
 - the power indicator amber?
 - Does the 'Out of range' message appear?
 - Does the 'Check signal cable' message appear?
- See if the power cord is properly connected to the outlet.
 - See if the power switch is turned on.
 - May need service.
 - Adjust brightness and contrast again.
 - Backlight may need repair.
 - If the product is in power saving mode, move the mouse or press any key.
 - Turn both devices off and then back on.
 - The signal from the PC (video card) is out of the vertical or horizontal frequency range of the product. Adjust the frequency range by referring to the Specifications in this manual.
 - * **Maximum resolution**
 - RGB : 1600 x 1200 @60Hz
 - HDMI/DVI : 1920 x 1080 @60Hz
 - The signal cable between PC and product is not connected. Check the signal cable.
 - Press the 'INPUT' menu in the remote Control to check the input signal.

'Unknown Product' message appears when the product is connected.

- Did you install the driver?
- Install the product driver, which is provided with the product, or download it from the web site. (<http://www.lge.com>)
 - See if the plug&play function is supported by referring to the video card user manual.

'Key Lock On' message appears.

- The 'Key Lock On' message appears when pressing the Menu button.
- The control locking function prevents unintentional OSD setting change due to careless usage. To unlock the controls, simultaneously press the Menu button and ► button for several seconds. (You cannot set this function using the remote control buttons. You can set this function in the product only.)



- * **Vertical frequency:** To enable the user to watch the product display, screen image should be changed tens of times every second like a fluorescent lamp. The vertical frequency or refresh rate is the times of image display per second. The unit is Hz.
- * **Horizontal frequency:** The horizontal interval is the time to display one vertical line. When 1 is divided by the horizontal interval, the number of horizontal lines displayed every second can be tabulated as the horizontal frequency. The unit is kHz.

Troubleshooting

The screen image looks abnormal.

- **Is the screen position wrong?**
 - D-Sub analog signal – Press the “AUTO” button in the remote control to automatically select the optimal screen status that fits into the current mode. If adjustment is not satisfactory, use the Position OSD menu.
 - See if the video card resolution and frequency are supported by the product. If the frequency is out of range, set to the recommended resolution in the Control Panel – Display – Setting menu.
- **Do thin lines appear on the background screen?**
 - D-Sub analog signal – Press the “AUTO” button in the remote control to automatically select an optimal screen status that fits into the current mode. If adjustment is not satisfactory, use the Clock OSD menu.
- **Horizontal noise appears or the characters look blurred.**
 - D-Sub analog signal – Press the “AUTO” button in the remote control to automatically select an optimal screen status that fits into the current mode. If adjustment is not satisfactory, use the Phase OSD menu.
- **The screen is displayed abnormally.**
 - The proper input signal is not connected to the signal port. Connect the signal cable that matches with the source input signal.

After-image appears on the product.

- **After-image appears when the product is turned off.**
 - If you use a fixed image for a long time, the pixels may be damaged quickly. Use the screen-saver function.

Troubleshooting

The audio function does not work.

- No sound?
 - See if the audio cable is connected properly.
 - Adjust the volume.
 - See if the sound is set properly.
- Sound is too dull.
 - Select the appropriate equalize sound.
- Sound is too low.
 - Adjust the volume.

Screen color is abnormal.

- Screen has poor color resolution (16 colors).
 - Set the number of colors to more than 24 bits (true color)
Select Control Panel – Display – Settings – Color Table menu in Windows.
- Screen color is unstable or monocolored.
 - Check the connection status of the signal cable.
Or, re-insert the PC video card.
- Do black spots appear on the screen?
 - Several pixels (red, green, white or black color) may appear on the screen, which can be attributable to the unique characteristics of the LCD panel. It is not a malfunction of the LCD.

The operation does not work normally.

- The power suddenly turned off.
 - Is the sleep timer set?
 - Check the power control settings.
Power interrupted.
 - "CAUTION! FAN STOP!"
If the power is turned off after this message appears, it means that the fan is out of order. In this case, contact your local service center.

Specifications

The product specifications can change without prior notice for product improvement.

LCD Panel

42.02 inches (106.73 cm) TFT (Thin Film Transistor)
 LCD (Liquid Crystal Display) Panel
 Visible diagonal size: 106.73 cm
 0.227 mm X 0.681 mm (Pixel Pitch)

Power

Rated Voltage AC 100-240V~ 50/60Hz 2.2A
Power Consumption On Mode : 220W Typ.
 Sleep Mode : ≤ 1W (RGB) / 3W(HDMI/DVI)
 (If LAN OFF is selected)
 Off Mode : ≤ 1W

Dimensions & Weight

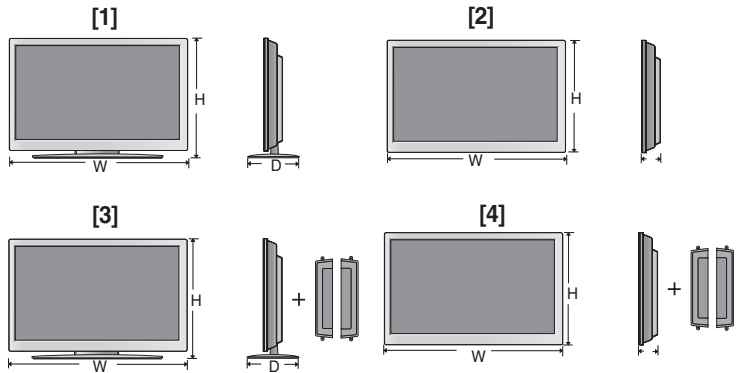

Width x Height x Depth

[1] 99.56 cm (39.19 inches) x 67.41 cm (26.54 inches) x 29.30 cm (11.54 inches)
 [2] 99.56 cm (39.19 inches) x 58.76 cm (23.13 inches) x 11.37 cm (4.47 inches)
 [3] 99.56 cm (39.19 inches) x 67.41 cm (26.54 inches) x 29.30 cm (11.54 inches)
 [4] 99.56 cm (39.19 inches) x 58.76 cm (23.13 inches) x 11.37 cm (4.47 inches)

Net

[1] 24.5 kg (54.02 lbs)
 [3] 27.1 kg (59.75 lbs)

[2] 21.1 kg (46.54 lbs)
 [4] 23.7 kg (52.25 lbs)

NOTE

- Information in this document is subject to change without notice.

Specifications

The product specifications can change without prior notice for product improvement.

Video Signal	Max. Resolution	RGB : 1600 X 1200 @60Hz HDMI/DVI : 1920 X 1080 @60Hz – It may not be supported depending on the OS or video card type.
	Recommended Resolution	RGB : WSXGA 1360 X 768@60Hz HDMI/DVI : WSXGA 1360 X 768 @60Hz – It may not be supported depending on the OS or video card type.
	Horizontal Frequency	RGB : 30 - 83 kHz HDMI/DVI : 30 - 83 kHz
	Vertical Frequency	RGB : 56 - 75 Hz HDMI/DVI : 56 - 60 Hz
	Synchronization Type	Composite/Separate/Digital
Input Connector		15-pin D-Sub type, HDMI (digital), S-Video, Composite Video, Component, RS-232C, LAN
Environmental Conditions	Operational Condition	Temperature: 0°C ~ 40°C , Humidity: 10% ~ 80%
	Storage Condition	Temperature: -20°C ~ 60°C , Humidity: 5% ~ 90%

* Applicable only for models that support the speakers

Audio	RMS Audio Output	10W+10W(R+L)
	Input Sensitivity	0.7Vrms
	Speaker Impedance	8Ω

NOTE

- Information in this document is subject to change without notice.

Specifications

PC Mode – Preset Mode

Preset mode		Horizontal Frequency (kHz)	Vertical Frequency (Hz)	Preset mode		Horizontal Frequency (kHz)	Vertical Frequency (Hz)
1	640 x 350	31.469	70.8	*11	1280 x 768	47.7	60
2	720 x 400	31.468	70.8	*12	1360 x 768	47.72	59.799
*3	640 x 480	31.469	59.94	*13	1366 x 768	47.7	60
4	640 x 480	37.5	75	*14	1280 x 1024	63.981	60.02
*5	800 x 600	37.879	60.317	15	1280 x 1024	79.98	75.02
6	800 x 600	46.875	75	16	1680 x 1050	65.290	59.954
7	832 x 624	49.725	74.55	17	1600 x 1200	75.0	60
*8	1024 x 768	48.363	60	*18	1920 x 1080	67.5	60
9	1024 x 768	60.123	75.029				
*10	1280 x 720	44.772	59.855				

1~17 : RGB mode
* : HDMI/DVI mode

DTV Mode

	Component	HDMI/DVI(DTV)
480i	o	x
576i	o	x
480p	o	o
576p	o	o
720p	o	o
1080i	o	o
1080p	o	o

Power Indicator

Mode	Product
On Mode	Blue
Sleep Mode	Amber
Off Mode	-

NOTE

- DTV/PC selection on RGB and HDMI/DVI inputs is available for PC resolutions : 640 X 480/60Hz, 1280 X 720/60Hz, 1920 X 1080/60Hz and DTV resolutions : 480p, 720p, 1080p.

**Use this method to connect several products to a single PC.
You can control several products at a time by connecting them to a single PC.**

Connecting the cable

Connect the RS-232C cable as shown in the picture.

* The RS-232C protocol is used for communication between the PC and product. You can turn the product on/off, select an input source or adjust the OSD menu from your PC.

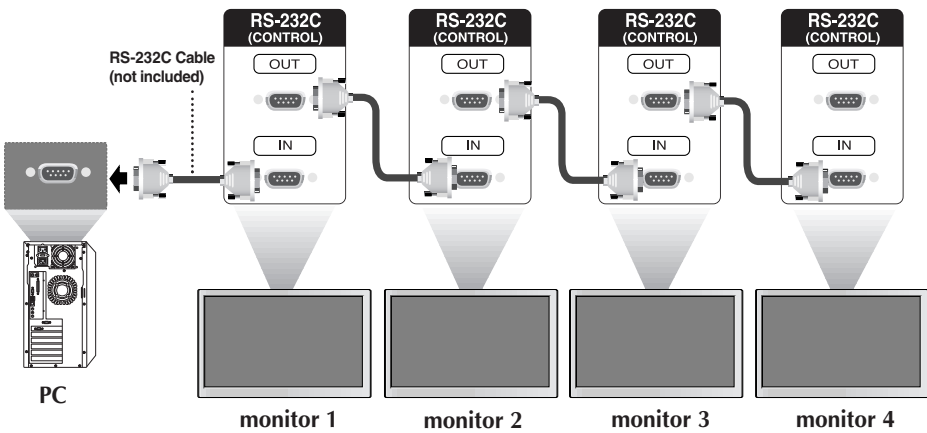

RS-232C Configurations

7-Wire Configurations (Standard RS-232C cable)

	PC	Monitor	
RXD	2	3	TXD
TXD	3	2	RXD
GND	5	5	GND
DTR	4	6	DSR
DSR	6	4	DTR
RTS	7	8	CTS
CTS	8	7	RTS

D-Sub 9 (Female) D-Sub 9 (Female)

3-Wire Configurations (Not Standard)

	PC	Monitor	
RXD	2	3	TXD
TXD	3	2	RXD
GND	5	5	GND
DTR	4	6	DTR
DSR	6	4	DSR
RTS	7	7	RTS
CTS	8	8	CTS

D-Sub 9 (Female) D-Sub 9 (Female)

Communication Parameter

- ▶ Baud Rate : 9600baud Rate (UART)
- ▶ Data Length : 8bits
- ▶ Parity Bit : None
- ▶ Stop Bit : 1bit
- ▶ Flow Control : None
- ▶ Communication Code : ASCII code
- ▶ Use a crossed (reverse) cable

How to connect

- ▶ Connect your wired remote control to Remote Control port on the Product.

Remote Control IR Code

- ▶ **Output waveform**
single pulse, modulated with 37.917KHz signal at 455KHz

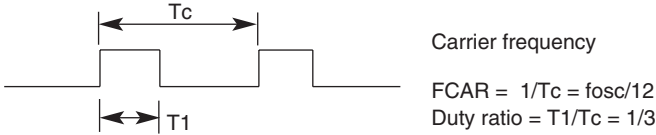

▶ **Configuration of frame**

- 1st frame

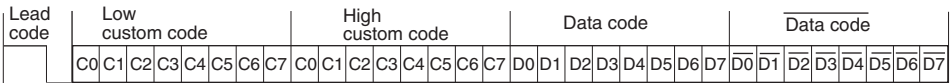

- Repeat frame

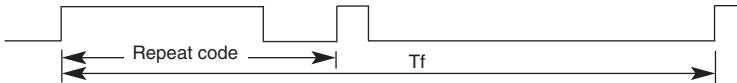

▶ **Lead code**

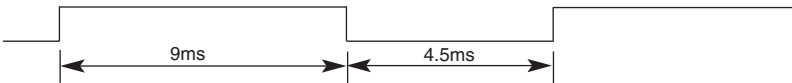

▶ **Repeat code**

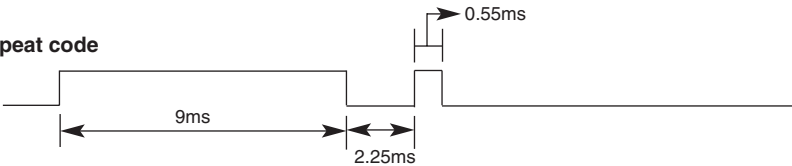

▶ **Bit description**

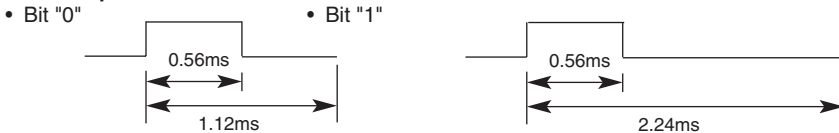

▶ **Frame interval : Tf**

- The waveform is transmitted as long as a key is depressed.

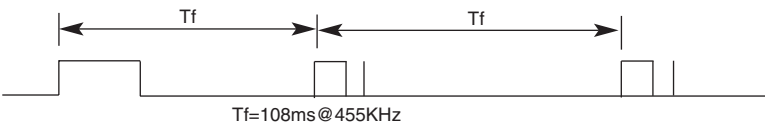

Code(Hex)	Function	Note
00	▲	R/C Button
01	▼	R/C Button
02	VOL(▶)	R/C Button
03	VOL(◀)	R/C Button
08	POWER ON/OFF	R/C Button (Power On/Off)
C4	POWER ON	Discrete IR Code(Only Power On)
C5	POWER OFF	Discrete IR Code(Only Power Off)
09	MUTE	R/C Button
98	AV	R/C Button
0B	INPUT	R/C Button
0E	SLEEP	R/C Button
43	MENU	R/C Button
5B	EXIT	R/C Button
6E	PSM	R/C Button
44	SET	R/C Button
10	Number Key 0	R/C Button
11	Number Key 1	R/C Button
12	Number Key 2	R/C Button
13	Number Key 3	R/C Button
14	Number Key 4	R/C Button
15	Number Key 5	R/C Button
16	Number Key 6	R/C Button
17	Number Key 7	R/C Button
18	Number Key 8	R/C Button
19	Number Key 9	R/C Button
5A	AV	Discrete IR Code(Input AV Selection)
BF	COMPONENT	Discrete IR Code(Input COMPONENT Selection)
D5	RGB PC	Discrete IR Code(Input RGB PC Selection)
C6	HDMI/DVI	Discrete IR Code(Input HDMI/DVI Selection)
79	ARC	R/C Button
76	ARC (4:3)	Discrete IR Code(Only 4:3 mode)
77	ARC (16:9)	Discrete IR Code(Only 16:9 mode)
AF	ARC (ZOOM)	Discrete IR Code(Only ZOOM1, ZOOM2 mode)
99	AUTO CONFIG	Discrete IR Code

■■■ Regulatory Information cont.

:: FCC Compliance Statement

This equipment has been tested and found to comply within the limits of a Class B digital device pursuant to Part 15 of the FCC Rules. These limits are designed to provide reasonable protection against harmful interference in a residential installation.

This equipment generates, uses, and can radiate radio frequency energy and if not installed and used in accordance with the instructions, may cause harmful interference to radio communications. However, there is no guarantee that interference will not occur in a particular installation.

If this equipment does cause harmful interference to radio or television reception (which can be determined by turning the equipment on and off), the user is encouraged to try to correct the interference by using one or more of the following measures:

- Reorient or relocate the receiving antenna.
- Increase the separation between the equipment and the receiver.
- Connect the equipment into an outlet on a circuit different from that to which the receiver is connected.
- Consult the dealer or an experienced radio/TV technician for help.

Caution: Changes or modifications not expressly approved by the party responsible for compliance could void the user's (or your) authority to operate the equipment. Only peripherals (digital input/output devices, terminals, printers, etc.) certified to comply with the Class B limits may be attached to this monitor. Operation with non-certified peripherals is likely to result in interference to radio and TV reception. Only shielded signal cables may be used with this System.

NOTICE

The regulations are applied only to the products with the ID LABEL indicating specific requirements.

:: Canadian DOC Notice

This Class B digital apparatus meets all requirements of the Canadian Interference-Causing Equipment Regulations. Cet appareil numérique de la classe B

respecte toutes les exigences du Règlement sur le matériel brouilleur du Canada.

NOTICE

The regulations are applied only to the products with the ID LABEL indicating specific requirements.

:: CE Conformity Notice (for Europe)

Products with the "CE" Marking comply with the EMC Directive(89/336/EEC) and LOW VOLTAGE Directive (73/23/EEC) issued by the Commission of the European Community.

Compliance with these directives implies conformity to the following European Norms :

- EN 55022 ; Radio Frequency Interference
- EN 55024 ; Electromagnetic Immunity
- EN 61000-3-2 ; Power Line Harmonics
- EN 61000-3-3 ; Voltage Fluctuations
- EN 60950-1 ; Product Safety

NOTICE

The regulations are applied only to the products with the ID LABEL indicating specific requirements.

:: Low Radiation Compliance (MPR II)

This monitor meets one of the strictest guidelines available today for low radiation emissions, offering the user extra shielding and an antistatic screen coating. These guidelines, set forth by a government agency in Sweden, limit the amount of emission allowed in the Extremely Low Frequency (ELF) and Very Low Frequency (VLF) electromagnetic range.

:: TCO'99 (TCO'99 applied model only)



Congratulations!

You have just purchased a TCO'99 approved and labelled product! Your choice has provided you with a product developed for professional use. Your purchase has also contributed to reducing the burden on the environment and also to the further development of environmentally adapted electronics products.

■■■ Regulatory Information cont.

Why do we have environmentally labelled computers?

In many countries, environmental labelling has become an established method for encouraging the adaptation of goods and services to the environment. With the growing manufacture and usage of electronic equipment throughout the world, there is a recognized concern for the materials and substances used by electronic products with regards to their eventual recycling and disposal. By proper selection of these materials and substances, the impact on the environment can be minimized.

There are also other characteristics of a computer, such as energy consumption levels, that are important from the viewpoints of both the work (internal) and natural (external) environments. Electronic equipment in offices is often left running continuously, resulting in unnecessary consumption of large amounts of energy and additional power generation. From the standpoint of carbon dioxide emissions alone, it is vital to save energy.

What does labelling involve?

The product meets the requirements for the TCO'99 scheme which provides for international and environmental labelling of personal computers and/or displays.

The labelling scheme was developed as a joint effort by the TCO (The Swedish Confederation of Professional Employees), Svenska Naturskyddsforeningen (The Swedish Society for Nature Conservation) and Statens Energimyndighet (The Swedish National Energy Administration).

Approval requirements cover a wide range of issues: ecology, ergonomics, emission of electrical and magnetical fields, energy consumption and electrical safety.

Ecological criteria impose restrictions on the presence and use of heavy metals, brominated and chlorinated flame retardants, and other substances. The product must be prepared for recycling and the manufacturing site(s) shall be certified according to ISO14001 or EMAS registered.

Energy requirements include a demand that the system unit and/or display, after a certain period of inactivity, shall reduce its power consumption to a lower level in one or more stages. The length of time to reactivate the system unit shall be reasonable for the user.

Labelled products must meet strict environmental demands, for example, in respect of the reduction of electrical and magnetical fields as well as work load and

visual ergonomics.

Below you will find a brief summary of the ecological requirements met by this product. The complete ecological criteria document can be found at TCO Development's website <http://www.tcodevelopment.com> or may be ordered from:

TCO Development

SE-114 94 STOCKHOLM, Sweden

Fax: +46 8 782 92 07

Email : development@tco.se

Information regarding TCO'99 approved and labelled products may also be obtained at <http://www.tcodevelopment.com>

Ecological requirements

Flame retardants

Flame retardants may be present in printed wiring board laminates, cables, and housings. Their purpose is to prevent, or at least to delay the spread of fire. Up to 30% by weight of the plastic in a computer casing can consist of flame retardant substances. Many flame retardants contain bromine or chlorine, and these flame retardants are chemically related to PCBs (polychlorinated biphenyls). Both the flame retardants containing bromine or chlorine and the PCBs are suspected of giving rise to health effects, including reproductive damage in fish-eating birds and mammals, due to the bio-accumulative* processes when not disposed of in accordance with strict standards for disposal.

TCO'99 requires that plastic components weighing more than 25 grams shall not contain flame retardants with organically bound bromine or chlorine. Flame retardants are allowed in the printed wiring board laminates due to the lack of commercially available alternatives.

Cadmium**

Cadmium is present in rechargeable batteries and in the colour-generating layers of certain computer displays. TCO'99 requires that batteries, the colour-generating layers of display screens, and the electrical or electronics components shall not contain any cadmium.

Mercury**

Mercury is sometimes found in batteries, relays and switches. TCO'99 requires that batteries shall not contain any mercury. It also demands that mercury is not present in any of the electrical or electronics components associated with the labelled unit. There is however one

■■■ Regulatory Information cont.

exception. Mercury is, for the time being, permitted in the back light system of flat panel monitors as there today is no commercially available alternative. TCO aims on removing this exception when a mercury free alternative is available.

Lead**

Lead can be found in picture tubes, display screens, solders and capacitors. TCO'99 permits the use of lead due to the lack of commercially available alternatives, but in future requirements TCO Development aims at restricting the use of lead.

* **Bio-accumulative is defined as substances which accumulate in living organisms.**

** **Lead, Cadmium and Mercury are heavy metals which are bio-accumulative.**

:: TCO'03 (TCO'03 applied model only)



Congratulations!

The display you have just purchased carries the TCO'03 Displays label.

This means that your display is designed, manufactured and tested according to some of the strictest quality and environmental requirements in the world. This makes for a high performance product, designed with the user in focus that also minimizes the impact on our natural environment. Some of the features of the TCO'03 Display requirements:

Ergonomics

- Good visual ergonomics and image quality in order to improve the working environment for the user and to reduce sight and strain problems. Important parameters are luminance, contrast, resolution, reflectance, colour rendition and image stability.

Energy

- Energy-saving mode after a certain time – beneficial both for the user and the environment
- Electrical safety

Emissions

- Electromagnetic fields

- Noise emissions

Ecology

- The product must be prepared for recycling and the manufacturer must have a certified environmental management system such as EMAS or ISO 14 001
- Restrictions on
 - chlorinated and brominated flame retardants and polymers
 - heavy metals such as cadmium, mercury and lead.

The requirements included in this label have been developed by TCO Development in co-operation with scientists, experts, users as well as manufacturers all over the world. Since the end of the 1980s TCO has been involved in influencing the development of IT equipment in a more user-friendly direction. Our labelling system started with displays in 1992 and is now requested by users and IT-manufacturers all over the world.

For more information, please visit
www.tcodevelopment.com

English

Information for Environmental Preservation

LGE. announced the 'LG Declaration for a Cleaner Environment' in 1994, and this ideal has served as a guiding managerial principle ever since. The Declaration is a foundation that has allowed us to undertake environmentally friendly activities in careful consideration of economic, environmental, and social aspects.

We promote activities for environmental preservation, and we specifically develop our products to embrace the concept of environment-friendly.

We minimize the hazardous materials contained in our products. For example, there is no cadmium to be found in our monitors.

Information for recycling

This monitor may contain parts which could be hazardous to the environment. It is important that this monitor be recycled after use.

LGE. handles all waste monitors through an environmentally acceptable recycling method. There are several take-back and recycling systems currently in

■■■ Regulatory Information cont.

operation worldwide. Many parts will be reused and recycled, while harmful substances and heavy metals are treated by an environmentally friendly method.

If you want to find out more information about our recycling program, please contact your local LG vendor or a corporate representative of LG.

We set our vision and policies on a cleaner world by selecting the issue of the global environment as a task for corporate improvement. Please visit our website for more information about our 'green' policies.

<http://www.lge.com/about/environment/html/Recycling.jsp>

■ ■ ■ Deutsch

Informationen zur Erhaltung der Umwelt

Im Jahr 1994 verkündete LGE die 'LG Declaration for a Cleaner Environment' (LG Erklärung für eine sauberere Umwelt). Seitdem dient dieses Ideal als führendes Prinzip des Unternehmens. Diese Erklärung war die Basis für die Durchführung von

umweltfreundlichen Aktivitäten, wobei wirtschaftliche, umweltbezogene und soziale Aspekte in die Überlegungen mit einbezogen wurden.

Wir fördern Aktivitäten zum Schutz der Umwelt und die Entwicklung unserer Produkte ist darauf ausgerichtet, unserem Konzept bezüglich Umweltfreundlichkeit gerecht zu werden.

Wir sind darauf bedacht, den Anteil der in unseren Produkten enthaltenen schädlichen Materialien zu minimieren. So ist in unseren Monitoren beispielsweise kein Kadmium zu finden.

Informationen zum Thema Recycling

Dieser Monitor enthält Teile, die umweltschädlich sein können. Es ist unbedingt erforderlich, dass der Monitor recycelt wird, nachdem er außer Dienst gestellt wurde.

Bei LGE werden alle ausrangierten Monitore in einem unter umweltbezogenen Aspekten geeigneten Verfahren recycelt. Augenblicklich sind weltweit mehrere Rücknahme- und Recyclingsysteme im Einsatz. Viele Teile werden wieder verwendet und recycelt. Schädliche Substanzen und Schwermetalle werden durch umweltverträgliche Verfahren behandelt.

Falls Sie mehr über unser Recyclingprogramm erfahren möchten, wenden Sie sich bitte an Ihren lokalen LG-Händler oder einen Unternehmensvertreter von LG.

Wir richten unsere Firmenpolitik auf eine sauberere Umwelt hin aus, indem wir umweltspezifische Aspekte als wichtigen Punkt in die Weiterentwicklung unseres Unternehmens einfließen lassen. Zusätzliche Informationen über unsere 'grüne' Firmenpolitik erhalten Sie auf unserer Website.

<http://www.lge.com/about/environment/html/Recycling.jsp>

■ ■ ■ Français

Information sur la protection de l'environnement

LGE a publié sa 'Déclaration en faveur d'un environnement plus propre' en 1994 et celle-ci est restée, depuis lors, un principe directeur de notre entreprise. Cette déclaration a servi de base à notre réflexion et nous a permis de prendre en compte à la fois les aspects économiques et sociaux de nos activités, tout en respectant l'environnement.

Nous encourageons les activités en faveur de la préservation de l'environnement et c'est dans cet esprit que nous développons nos produits : nous réduisons au minimum les matières dangereuses qui entrent dans leur composition et l'on ne trouve pas de cadmium, par exemple, dans nos moniteurs.

Information sur le recyclage

Ce moniteur peut contenir des composants qui présentent un risque pour l'environnement. Il est donc important que celui-ci soit recyclé après usage.

LGE traite les moniteurs en fin de cycle conformément à une méthode de recyclage respectueuse de l'environnement. Nous reprenons nos produits et les recyclons dans plusieurs sites répartis dans le monde entier. De nombreux composants sont réutilisés et recyclés, et les matières dangereuses, ainsi que les métaux lourds, sont traités selon un procédé écologique.

Si vous souhaitez plus de renseignements sur notre programme de recyclage, veuillez contacter votre revendeur LG ou un l'un de nos représentants.

Nous voulons agir pour un monde plus propre et croyons au rôle de notre entreprise dans l'amélioration de l'environnement. Pour plus de renseignements sur notre politique "verte", rendez visite à notre site :

<http://www.lge.com/about/environment/html/Recycling.jsp>

Regulatory Information cont.

Italiano

Informazioni per la tutela dell'ambiente

La LGE. ha annunciato nel 1994 la cosiddetta 'LG Declaration for a Cleaner Environment' (Dichiarazione di LG a favore di un ambiente più pulito), un ideale che da allora funge da principio ispiratore della gestione aziendale. La dichiarazione rappresenta il fondamento che consente di intraprendere attività a favore dell'ambiente tenendo conto degli aspetti economici, ambientali e sociali. Noi della LG, promuoviamo attività a favore della tutela dell'ambiente sviluppando appositamente i nostri prodotti per cogliere il concetto del rispetto dell'ambiente riducendo i materiali dannosi presenti nei nostri prodotti. Ad esempio nei nostri monitor non è presente il cadmio.

Informazioni per il riciclaggio

Il monitor può presentare componenti che potrebbero risultare eventualmente dannosi per l'ambiente. È importante che il monitor sia riciclato al termine del suo utilizzo.

La LGE. gestisce tutti i monitor di rifiuto con un metodo di riciclaggio soddisfacente dal punto di vista ambientale. In tutto il mondo sono attualmente in funzione numerosi sistemi di riciclaggio e recupero. I diversi componenti sono riutilizzati e riciclati, mentre le sostanze dannose e i metalli pesanti vengono trattati con un metodo rispettoso dell'ambiente.

Se si desiderano maggiori informazioni in merito al programma di riciclaggio, è consigliabile rivolgersi al proprio rivenditore LG o ad un rappresentante aziendale della LG.

Noi della LG impostiamo la nostra visione e le nostre politiche a favore di un mondo più pulito ponendo la questione dell'ambiente dal punto di vista globale come una mansione rivolta al miglioramento della nostra azienda. Vi invitiamo a visitare il nostro sito internet per ulteriori informazioni sulla nostra politica "verde".
<http://www.lge.com/about/environment/html/Recycling.jsp>

Espanol

Información para la conservación medioambiental

LGE. presentó la 'Declaración para un entorno más limpio de LG' en 1994 y este ideal ha servido para guiar nuestros principios empresariales desde entonces. La Declaración es la base que nos ha permitido llevar a cabo tareas que

respetan el medio ambiente siempre teniendo en cuenta aspectos sociales, económicos y medioambientales.

Promocionamos actividades orientadas a la conservación del medio ambiente y desarrollamos nuestros productos específicamente para que se ajusten a la filosofía que protege el entorno.

Reducimos al máximo el uso de materiales de riesgo en nuestros productos. Un ejemplo de ello es la ausencia total de cadmio en nuestros monitores.

Información para el reciclaje

Este monitor puede contener piezas que entrañen riesgos medioambientales. Es importante reciclar este monitor después de su utilización.

LGE. trata todos los monitores usados siguiendo un método de reciclaje que no daña al entorno. Contamos con diversos sistemas de recuperación y reciclaje que funcionan a nivel mundial en la actualidad. Es posible reciclar y reutilizar muchas de las piezas, mientras que las sustancias dañinas y los metales pesados se tratan siguiendo un método que no perjudique al medio ambiente. Si desea obtener más información acerca del programa de reciclaje, póngase en contacto con su proveedor local de LG o con un representante empresarial de nuestra marca.

Basamos nuestra visión y nuestras políticas en un mundo más limpio y para ellos optamos por un entorno global como tarea principal de nuestra evolución como empresa. Visite nuestra página Web para obtener más información sobre nuestras políticas ecológicas.

<http://www.lge.com/about/environment/html/Recycling.jsp>

Português

Informações relacionadas à preservação ambiental

A LGE. anunciou a 'LG Declaration for a Cleaner Environment' (Declaração da LG para um ambiente mais limpo) em 1994 e esse ideal tem servido desde então como um princípio administrativo de orientação. A Declaração é a base que nos tem permitido realizar atividades favoráveis ao ambiente com consideração atenta aos aspectos econômicos, ambientais e sociais.

Promovemos atividades de preservação ambiental e desenvolvemos nossos produtos para englobar

■■■ Regulatory Information cont.

especificamente o conceito de favorável ao ambiente.

Reduzimos os materiais perigosos contidos em nossos produtos. Por exemplo, não há cádmio em nossos monitores.

Informações relacionadas à reciclagem

Este monitor pode conter peças que podem representar riscos ao ambiente. É importante que ele seja reciclado após o uso.

A LGE. cuida de todos os monitores descartados através de um método de reciclagem agradável ao ambiente. Há vários sistemas de devolução e reciclagem atualmente em operação no mundo. Muitas peças serão reutilizadas e recicladas e as substâncias nocivas e os metais pesados passarão por tratamento através de um método favorável ao ambiente.

Para obter mais informações sobre nosso programa de reciclagem, entre em contato com seu fornecedor LG local ou com um representante corporativo da LG.

Definimos nossa visão e nossas políticas relacionadas a um mundo mais limpo selecionando a questão do ambiente global como uma tarefa de aprimoramento corporativo. Visite nosso site para obter mais informações sobre nossas políticas de meio ambiente.

<http://www.lge.com/about/environment/html/Recycling.jsp>

■ ■ ■ Nederlands

Informatie met betrekking tot het behoud van het milieu

LGE. publiceerde in 1994 de 'LG Declaration for a Cleaner Environment' (de LG-verklaring met betrekking tot een schoner milieu). Deze verklaring en het ideaal van een schoner milieu fungeren sindsdien als een bestuurlijke leidraad voor onze onderneming. Op basis van deze verklaring ontplooiën wij milieuvriendelijke activiteiten, waarbij er zowel met sociale en economische aspecten, als met milieuaspecten zorgvuldig rekening wordt gehouden.

Wij ondersteunen activiteiten die zijn gericht op het behoud van het milieu en wij houden bij het ontwikkelen onze producten specifiek rekening met de milieuvriendelijkheid van onze producten.

Wij minimaliseren het gebruik van schadelijke stoffen in onze producten. Er wordt bijvoorbeeld geen cadmium verwerkt in onze monitoren.

Informatie met betrekking tot recycling

Deze monitor bevat materialen die schadelijk zouden kunnen zijn voor het milieu. Het is belangrijk dat deze monitor aan het einde van zijn levensduur wordt gerecycled.

LGE. verwerkt alle afvalmonitoren via een milieuvriendelijke recyclingmethode. Hiervoor worden er momenteel wereldwijd verscheidene inname- en recyclingsystemen gehanteerd. Een groot aantal onderdelen wordt opnieuw gebruikt en gerecycled, waarbij schadelijke stoffen en zware metalen volgens een milieuvriendelijke methode worden verwerkt.

Voor meer informatie over ons recyclingprogramma kunt u contact opnemen met uw plaatselijke LG-vertegenwoordiger of een LG-vestiging.

Onze visie en ons beleid met betrekking tot een schonere wereld vloeien voort uit het feit dat wij het milieu hebben aangemerkt als een onderwerp dat speciale aandacht verdient binnen onze onderneming. Bezoek onze website voor meer informatie over ons 'groene' beleid.

<http://www.lge.com/about/environment/html/Recycling.jsp>

■ ■ ■ Russian

Информация по охране окружающей среды

В 1994 году корпорация LGE опубликовала 'Декларацию LG по охране окружающей среды', которая с тех пор служит основным принципом управления. На основе этой декларации мы смогли предпринять действия, обеспечивающие безопасность окружающей среды, уделяя при этом должное внимание экономическим, экологическим и социальным аспектам.

Мы стимулируем деятельность по охране окружающей среды, уделяя особое внимание разработке нашей продукции в соответствии с концепцией экологической безопасности.

Мы сводим к минимуму содержание опасных веществ в нашей продукции. Например, в наших мониторах вы не найдете кадмия.

Информация по утилизации отходов

Этот монитор может содержать компоненты, которые могут нанести ущерб окружающей среде.

■■■ Regulatory Information cont.

Необходимо утилизировать монитор после использования.

Корпорация LGE перерабатывает все бракованные мониторы с помощью экологически приемлемого метода утилизации отходов. По всему миру действуют системы утилизации отходов и возврата использованной продукции. Многие компоненты будут вторично использованы и утилизированы, в то время как вредные вещества и тяжелые металлы будут обработаны с помощью экологически приемлемого метода.

За более подробной информацией по нашей программе утилизации отходов обращайтесь к местному поставщику или представителю корпорации LG.

Мы ориентируемся на обеспечение экологической безопасности, ставя себе целью глобальную защиту окружающей среды. Дополнительную информацию о нашей политике по охране окружающей среды вы можете найти на нашем сайте:
<http://www.lge.com/about/environment/html/Recycling.jsp>

한국어

환경 보존 정보

LG 전자는 1994년 'LG 환경 선언문'을 발표한 후 현재까지 이를 기업 경영의 이념으로 삼아왔습니다. 이 선언문을 바탕으로 LG 전자는 모든 경영 활동에서 경제성뿐만 아니라 환경성 및 사회성을 주요 의사 결정의 기준으로 삼음으로써 지속적으로 환경 친화적인 경영을 전개하고 있습니다.

본사는 보다 활발한 환경 보존 활동과 더불어 환경 친화적 제품 개발에 주력해 왔습니다.

또한 제품에 포함되는 환경 위해 요소를 최소화하는 데에도 노력을 기울이지 않고 있습니다. LG 전자 모니터의 경우 카드를 전혀 사용하지 않는 것에서도 이러한 노력을 알 수 있습니다.

재활용 정보

본 모니터에는 환경에 위해를 주는 부품이 포함되어 있을 수도 있습니다. 따라서 사용이 끝난 모니터는 재활용하는 것이 좋습니다.

폐모니터는 모두 환경 친화적 방식으로 처리됩니다. 현재 세계적으로 운영되고 있는 회수 및 재활용 시스템에는

여러 가지가 있습니다. 대부분의 부품의 경우 재사용 또는 재활용되지만 환경 위해 물질과 중금속은 환경 친화적 방법으로 처리됩니다.

본사의 재활용 프로그램에 대한 자세한 정보는 각 지역의 LG 공급업체나 LG 기업 대표부에 문의하시기 바랍니다.

LG 전자는 기업 개선 정책의 하나로 지구 환경 문제를 채택함으로써 보다 나은 환경을 만들어 나가기 위한 비전과 정책을 수립했습니다. 본사의 친환경 정책에 대한 자세한 정보를 보시려면 아래의 웹 사이트를 방문하십시오.

http://www.lge.co.kr/cckr/about/environ/purity_02.jsp

∴EPA (EPA applied model only)

ENERGY STAR is a set of power-saving guidelines issued by the U.S. Environmental Protection Agency(EPA).



As an ENERGY STAR Partner LGE U. S. A.,Inc. has determined that this product meets the ENERGY STAR guidelines for energy efficiency.

∴NOM MARK (Mexico only)



■■■ Regulatory Information cont.

:: WEEE (for Europe)



English

Disposal of your old appliance

1. When this crossed-out wheeled bin symbol is attached to a product it means the product is covered by the European Directive 2002/96/EC.
2. All electrical and electronic products should be disposed of separately from the municipal waste stream via designated collection facilities appointed by the government or the local authorities.
3. The correct disposal of your old appliance will help prevent potential negative consequences for the environment and human health.
4. For more detailed information about disposal of your old appliance, please contact your city office, waste disposal service or the shop where you purchased the product.

French

Élimination de votre ancien appareil

1. Ce symbole, représentant une poubelle sur roulettes barrée d'une croix, signifie que le produit est couvert par la directive européenne 2002/96/EC.
2. Les éléments électriques et électroniques doivent être jetés séparément, dans les vide-ordures prévus à cet effet par votre municipalité.
3. Une élimination conforme aux instructions aidera à réduire les conséquences négatives et risques éventuels pour l'environnement et la santé humaine.
4. Pour plus d'information concernant l'élimination de votre ancien appareil, veuillez contacter votre mairie, le service des ordures ménagères ou encore la magasin où vous avez acheté ce produit.

Italian

Smaltimento delle apparecchiature obsolete

1. Quando su un prodotto è riportato il simbolo di

un bidone della spazzatura barrato da una croce significa che il prodotto è coperto dalla direttiva europea 2002/96/EC.

2. Tutti i prodotti elettrici ed elettronici dovrebbero essere smaltiti separatamente rispetto alla raccolta differenziata municipale, mediante impianti di raccolta specifici designati dal governo o dalle autorità locali.
3. Il corretto smaltimento delle apparecchiature obsolete contribuisce a prevenire possibili conseguenze negative sulla salute umana e sull'ambiente.
4. Per informazioni più dettagliate sullo smaltimento delle apparecchiature obsolete, contattare il comune, il servizio di smaltimento rifiuti o il negozio in cui è stato acquistato il prodotto.

Swedish

Kassering av din gamla apparat

1. När den här symbolen med en överkryssad soptunna på hjul sitter på en produkt innebär det att den regleras av European Directive 2002/96/EC.
2. Alla elektriska och elektroniska produkter bör kasseras via andra vägar än de som finns för hushållsavfall, helst via för ändamålet avsedda uppsamlingsanläggningar som myndigheterna utser.
3. Om du kasserar din gamla apparat på rätt sätt så bidrar du till att förhindra negativa konsekvenser för miljön och människors hälsa.
4. Mer detaljerad information om kassering av din gamla apparat kan fås av kommunen, renhållningsverket eller den butik där du köpte produkten.

Dutch

Uw oude toestel wegdoen

1. Als het symbool met de doorgekruiste verrijdbare afvalbak op een product staat, betekent dit dat het product valt onder de Europese Richtlijn 2002/96/EC.
2. Elektrische en elektronische producten mogen niet worden meegegeven met het huishoudelijk afval, maar moeten worden ingeleverd bij speciale inzamelingspunten die door de lokale of landelijke overheid zijn aangewezen.
3. De correcte verwijdering van uw oude toestel helpt negatieve gevolgen voor het milieu en de menselijke gezondheid voorkomen.

Regulatory Information cont.

4. Wilt u meer informatie over de verwijdering van uw oude toestel? Neem dan contact op met uw gemeente, de afvalophaaldienst of de winkel waar u het product hebt gekocht.

Finnish

Vanhonjen laitteiden hävittäminen

1. Tämä merkki tuotteessa tarkoittaa, että tuote kuuluu sähkö- ja elektroniikkalaiteromusta annetun EU-direktiivin 2002/96/EY soveltamisalaan.
2. Kaikki elektroniset laitteet ovat ongelmajätettä, joten ne on toimitettava paikalliseen keräyspisteeseen.
3. Vanhan laitteen asianmukainen hävittäminen ehkäisee mahdollisia ympäristöön ja terveyteen kohdistuvia haittavaikutuksia.
4. Lisätietoa vanhan laitteen hävittämisestä saat ottamalla yhteyden paikallisiin viranomaisiin, kierrätyskeskukseen tai myymälään, josta ostit laitteen.

German

Entsorgung von Altgeräten

1. Wenn dieses Symbol eines durchgestrichenen Abfalleimers auf einem Produkt angebracht ist, unterliegt dieses Produkt der europäischen Richtlinie 2002/96/EC.
2. Alle Elektro- und Elektronik-Altgeräte müssen getrennt vom Hausmüll über dafür staatlich vorgesehenen Stellen entsorgt werden.
3. Mit der ordnungsgemäßen Entsorgung des alten Geräts vermeiden Sie Umweltschäden und eine Gefährdung der persönlichen Gesundheit.
4. Weitere Informationen zur Entsorgung des alten Geräts erhalten Sie bei der Stadtverwaltung, beim Entsorgungsamt oder in dem Geschäft, wo Sie das Produkt erworben haben.

Danish

Sådan smider du dit gamle apparat ud

1. Når der er et tegn med et kryds over en skraldespand, betyder det, at produktet er omfattet af EU-direktiv 2002/96/EC.
2. Alle elektriske og elektroniske produkter skal smides ud et andet sted end gennem den kommunale affaldsordning ved hjælp af specielle indsamlingsfaciliteter, der er organiseret af staten

eller de lokale myndigheder.

3. Korrekt bortskaffelse af dit gamle apparat er med til at forhindre mulige skadevirkninger på miljøet og menneskelig sundhed.
4. Mere detaljerede oplysninger om bortskaffelse af dit gamle apparat kan fås ved at kontakte dit lokale kommunekontor, renovationselskab eller den butik, hvor du købte produktet.

Greek

Απόρριψη της παλιάς σας συσκευής

1. Όταν ένα προϊόν διαθέτει το σύμβολο ενός διαγραμμένου κάλαθου απορριμμάτων, τότε το προϊόν καλύπτεται από την Ευρωπαϊκή Οδηγία 2002/96/ΕΟΚ.
2. Η απόρριψη όλων των ηλεκτρικών και ηλεκτρονικών προϊόντων πρέπει να γίνεται χωριστά από τα γενικά οικιακά απορρίμματα μέσω καθορισμένων εγκαταστάσεων συλλογής απορριμμάτων, οι οποίες έχουν δημιουργηθεί είτε από την κυβέρνηση ή από τις τοπικές αρχές.
3. Η σωστή απόρριψη της παλιάς σας συσκευής θα βοηθήσει στην αποτροπή πιθανών αρνητικών συνπειών ως προς το περιβάλλον και την υγεία του ανθρώπου.
4. Για πιο λεπτομερείς πληροφορίες σχετικά με την απόρριψη της παλιάς σας συσκευής, επικοινωνήστε με το αρμόδιο τοπικό γραφείο, υπηρεσία διάθεσης οικιακών απορριμμάτων ή το μαγαζί από το οποίο αγοράσατε το προϊόν.

Spanish

Cómo deshacerse de aparatos eléctricos y electrónicos viejos

1. Si en un producto aparece el símbolo de un contenedor de basura tachado, significa que éste se acoge a la Directiva 2002/96/CE.
2. Todos los aparatos eléctricos o electrónicos se deben desechar de forma distinta del servicio municipal de recogida de basura, a través de puntos de recogida designados por el gobierno o las autoridades locales.
3. La correcta recogida y tratamiento de los dispositivos inservibles contribuye a evitar riesgos potenciales para el medio ambiente y la salud pública.
4. Para obtener más información sobre cómo deshacerse de sus aparatos eléctricos y electrónicos viejos, póngase en contacto con su ayuntamiento, el servicio de recogida de basuras o el establecimiento donde adquirió el producto.

Regulatory Information cont.

Portuguese

Eliminação do seu antigo aparelho

1. Quando este símbolo de latão cruzado estiver afixado a um produto, significa que o produto é abrangido pela Directiva Europeia 2002/96/EC.
2. Todos os produtos eléctricos e electrónicos devem ser eliminados separadamente do lixo doméstico através de pontos de recolha designados, facilitados pelo governo ou autoridades locais.
3. A eliminação correcta do seu aparelho antigo ajuda a evitar potenciais consequências negativas para o ambiente e para a saúde humana.
4. Para obter informações mais detalhadas acerca da eliminação do seu aparelho antigo, contacte as autoridades locais, um serviço de eliminação de resíduos ou a loja onde comprou o produto.

Slovak

Likvidácia váš ho starého prístroja

1. Keď sa na produkte nachádza tento symbol prečiarknutej smetnej nádoby s kolieskami, znamená to, že daný produkt vyhovuje európskej Smernici č. 2002/96/EC.
2. Všetky elektrické a elektronické produkty by mali byť zlikvidované oddelene od komunálneho odpadu prostredníctvom na to určených zberných zariadení, ktoré boli ustanovené vládou alebo orgánmi miestnej správy.
3. Správnu likvidáciu starých zariadení pomôžete predchádzať potenciálnym negatívnym následkom pre prostredie a ľudské zdravie.
4. Podrobnejšie informácie o likvidácii starých zariadení nájdete na miestnom úrade, v službe na likvidáciu odpadu alebo u predajcu, kde ste tento produkt zakúpili.

Czech

Likvidace starých spotřebičů

1. Pokud je u výrobku uveden symbol pojízdného kontejneru v přeškrtnutém poli, znamená to, že na výrobek se vztahuje směrnice Evropské unie číslo 2002/96/EC.
2. Všechny elektrické a elektronické výrobky by měly být likvidovány odděleně od běžného komunálního odpadu prostřednictvím sběrných zařízení zřízených za tímto účelem vládou nebo místní samosprávou.
3. Správný způsob likvidace starého elektrického spotřebiče pomáhá zamezit možným negativním dopadům na životní prostředí a zdraví.
4. Bližší informace o likvidaci starého spotřebiče získáte u místní samosprávy, ve sběrném zařízení nebo v obchodě, ve kterém jste výrobek zakoupili.

Croatian

Uklanjanje starog aparata

1. Ako se na proizvodu nalazi simbol prekrizhene kante za smeće, to znači da je proizvod pokriven europskom direk-

tivom 2002/96/EC.

2. Električni i elektronski proizvodi ne smiju se odlagati zajedno s komunalnim otpadom, već u posebna odlagališta koja je odredila vlada ili lokalne vlasti.
3. Pravilno odlaganje starog proizvoda sprečiti će potencijalne negativne posljedice po okoliš i zdravlje ljudi.
4. Podrobnije informacije o odlaganju starog proizvoda potražite u gradskom uredu, službi za odlaganje otpada ili u trgovini u kojoj ste kupili proizvod.

Hungarian

Régi eszközök ártalmatlanítása

1. A termékhez csatolt áthúzott, keresek szeméttároló jel jelöli, hogy a termék a 2002/96/EC EU-direktíva hatálya alá esik.
2. Minden elektromos és elektronikai terméket a lakossági hulladéktól elkülönítve kell begyűjteni, a kormány vagy az önkormányzatok által kijelölt begyűjtő eszközök használatával.
3. Régi eszközeinek megfelelő ártalmatlanítása segíthet megelőzni az esetleges egészségre vagy környezetre ártalmas hatásokat.
4. Ha több információra van szüksége régi eszközeinek ártalmatlanításával kapcsolatban, tanulmányozza a vonatkozó környezetvédelmi szabályokat, vagy lépjen kapcsolatba az üzlettel, ahol a terméket vásárolta.

Polish

Utylizacja starych urządzeń

1. Kiedy do produktu dołączony jest niniejszy przekreślony symbol kołowego pojemnika na śmieci, oznacza to, że produkt jest objęty dyrektywą 2002/96/EC.
2. Wszystkie elektryczne i elektroniczne produkty powinny być utylizowane niezależnie od odpadów miejskich, z wykorzystaniem przeznaczonych do tego miejsc składowania wskazanych przez rząd lub miejscowe władze.
3. Właściwy sposób utylizacji starego urządzenia pomoże zapobiec potencjalnie negatywnemu wpływowi na zdrowie i środowisko.
4. Aby uzyskać więcej informacji o sposobach utylizacji starych urządzeń, należy skontaktować się z władzami lokalnymi, przedsiębiorstwem zajmującym się utylizacją odpadów lub sklepem, w którym produkt został kupiony.

■ ■ ■ Regulatory Information cont.

■ ■ Estonian

Kasutuskõlbmatu seadme käitlemise kord

1. Kui seade on märgistatud selle elektri- ja elektroonikaseadmete lahuskogumist märgistava tähisega (ratastega prügikonteineri kujutis, millele on rist peale tõmmatud), tuleb toodet käidelda vastavalt Eurodirektiivile 2002/96/EÜ.
2. Elektri- ja elektroonikaseadmeid ei tohi visata tavalise prügi hulka. Nad kuuluvad lahuskogumisele selleks määratud kogumispunktides.
3. Kasutuskõlbmatu tervikseadme käitlemine tavaprügist lahus on korraldatud selleks, et vältida negatiivseid tagajärgi, mida põhjustaksid seadme osade purunemisel vabaneda võivad ohtlikud jäätmed loodusele või inimorganismile.
4. Täpsemat informatsiooni selle kohta, kuhu ja millal saab ära anda oma kasutamiskõlbmatu elektri- ja elektroonikaseadme, küsige kohalikult omavalitsuselt, prügifirmalt või kaupluselt, kust seadme ostsite.

■ ■ Latvian

Vecās elektroierīces nodošana

1. Ja uz produkta ir simbols ar pārsvītrotu atkritumu tvertni, tas nozīmē, ka produkts ir iekļauts Eiropas direktīvā 2002/96/EC.
2. Visi elektriskie un elektroniskie produkti ir jāutilizē, nododot pašvaldības īpaši noteiktās pieņemšanas vietās. Tos nedrīkst izmest parastās municipalitātes atkritumu urnās.
3. Ievērojot prasības veco elektroierīču utilizēšanā, jūs pasargāsiet apkārtējo vidi un cilvēku veselību no iespējami nelabvēlīgajām sekām, kādas varētu rasties, ierīcēm sadaloties nepiemērotā vietā.
4. Lai gūtu plašāku informāciju par veco ierīču utilizēšanas iespējām, sazinieties ar pilsētas pašvaldību, atkritumu savākšanas saimniecību vai veikalu, kurā ierīci iegādājāties.

■ ■ Lithuanian

Senos įrangos atliekų tvarkymas

1. Užbrauktas konteinerio simbolis priverčia ant prekės reiškia, kad įrangą saugo Europos direktyva 2002/96/EC.
2. Visos elektros ir elektroninės įrangos atliekos turi būti renkamos atskirai ir neišmetamos į atliekų konteinerį kartu su kitomis komunalinėmis atliekomis, taikant specialią atliekų surinkimo sistemą, patvirtintą vyriausybės ar vietos valdžios.
3. Teisingas senos įrangos atliekų tvarkymas, padės išvengti neigiamų pasekmių aplinkai ir žmonių sveikatai.
4. Dėl išsamesnės informacijos apie senos įrangos tvarkymą, prašome kreiptis į miesto valdžią, atliekų perdirbimo tarnybą arba parduotuvę, kurioje pirkote įrangą.