

APPENDIX H
: USER'S MANUAL

User's Guide

M4224C

Make sure to read the **Safety Precautions** before using the product.

Keep the User's Guide(CD) in an accessible place for future reference.

See the label attached on the product and give the information to your dealer when you ask for service.



Connecting the stand

- Only on some models.

1. Take the parts for the stand out of the box and assemble them as shown in the picture.

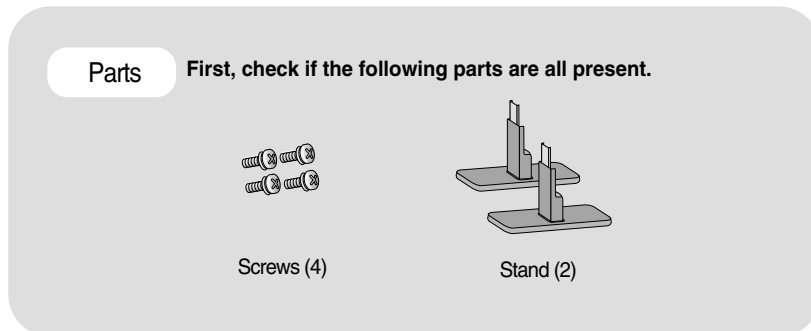

2. Place a soft cloth on the table and put the product with the screen facing downward. Connect the stand as shown in the following picture.

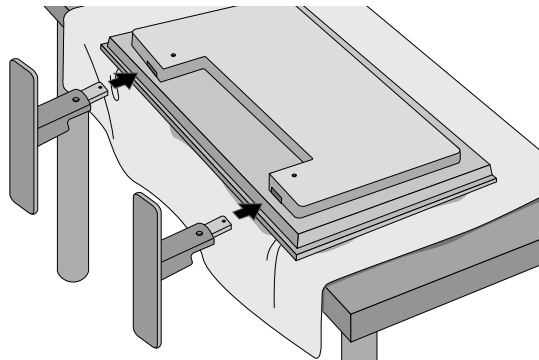

3. Use the screws to secure the stand on the rear side of the product as shown in the diagram.

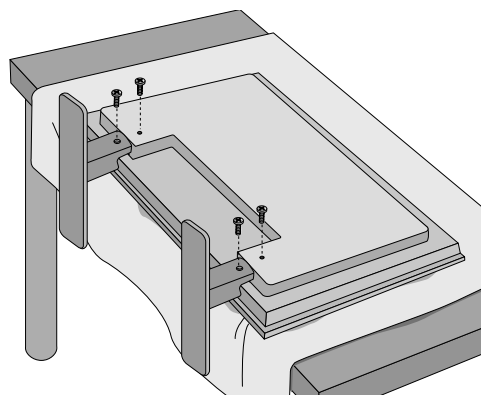

Connecting the Speakers

- Only on some models.

Mount the product onto the speaker by using a screw as shown in the following connect the speaker cable.

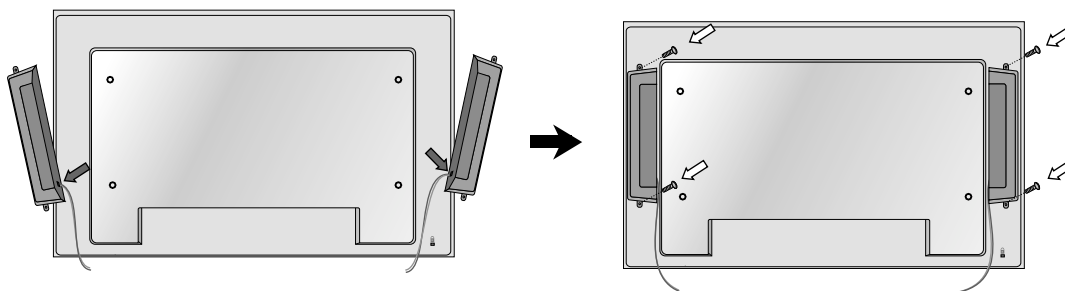

After installing your speakers, use holders and cable ties to organize the speaker cables.

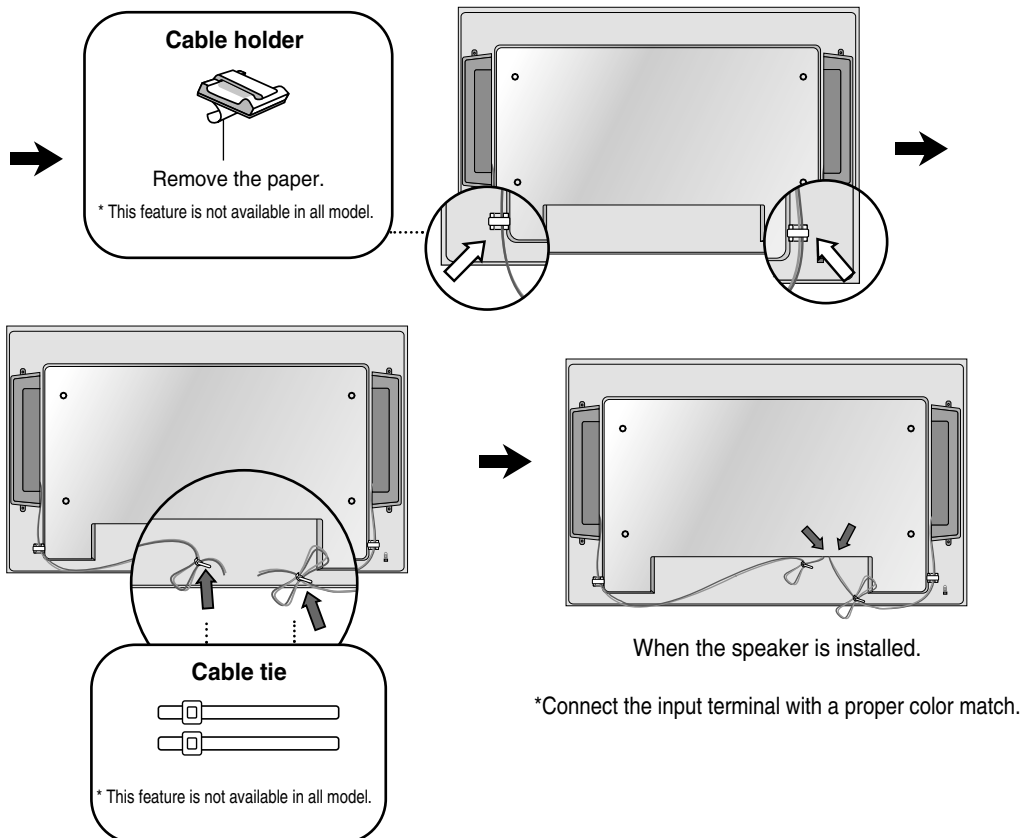

To install Portrait

- Only on some models.

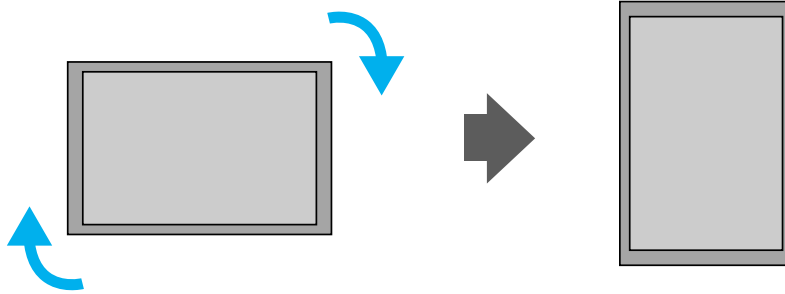

"When installing Portrait, rotate it clockwise based on its front."

Using the Remote Control

● Name of the Remote Control Buttons

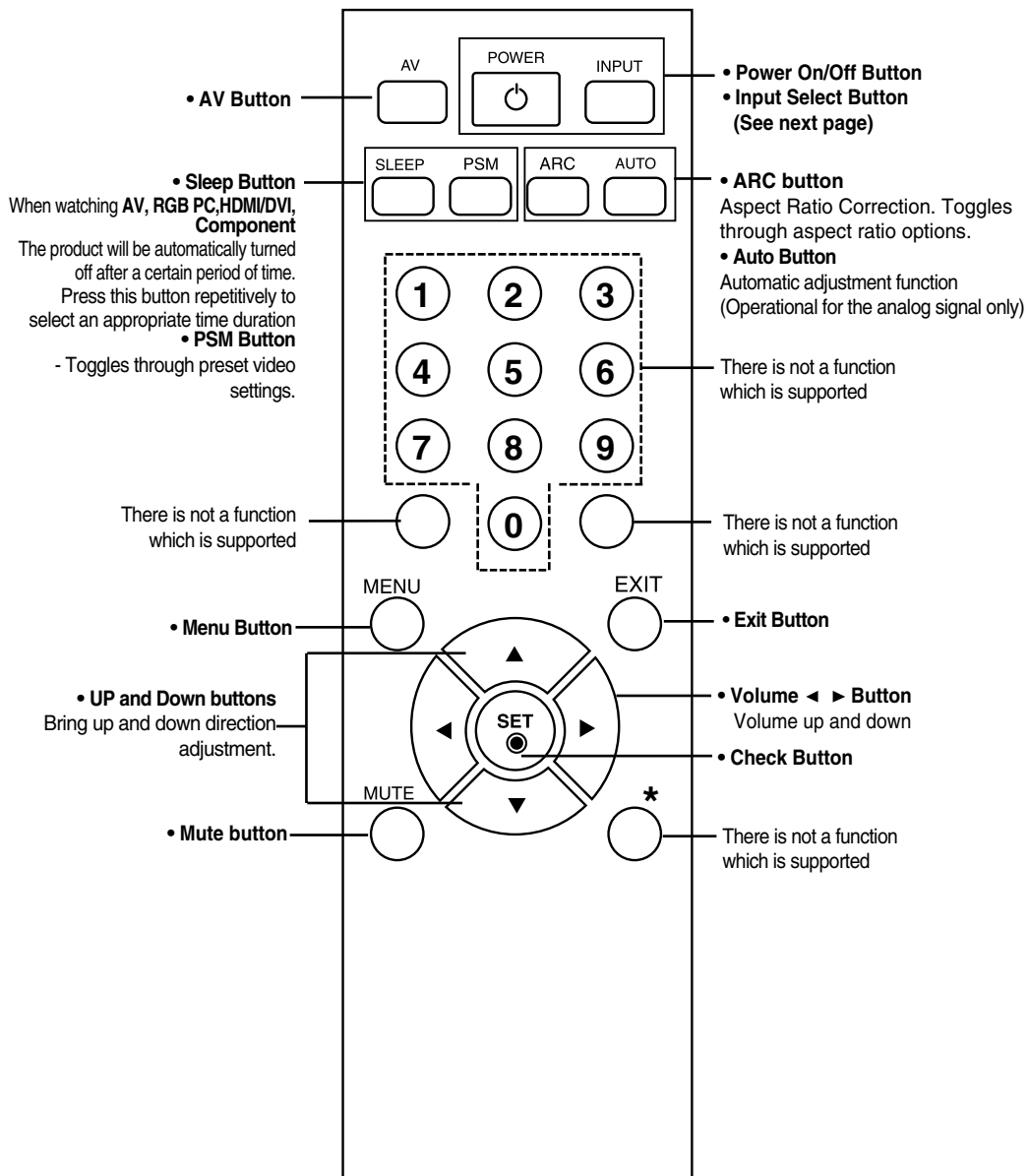

Using the Remote Control

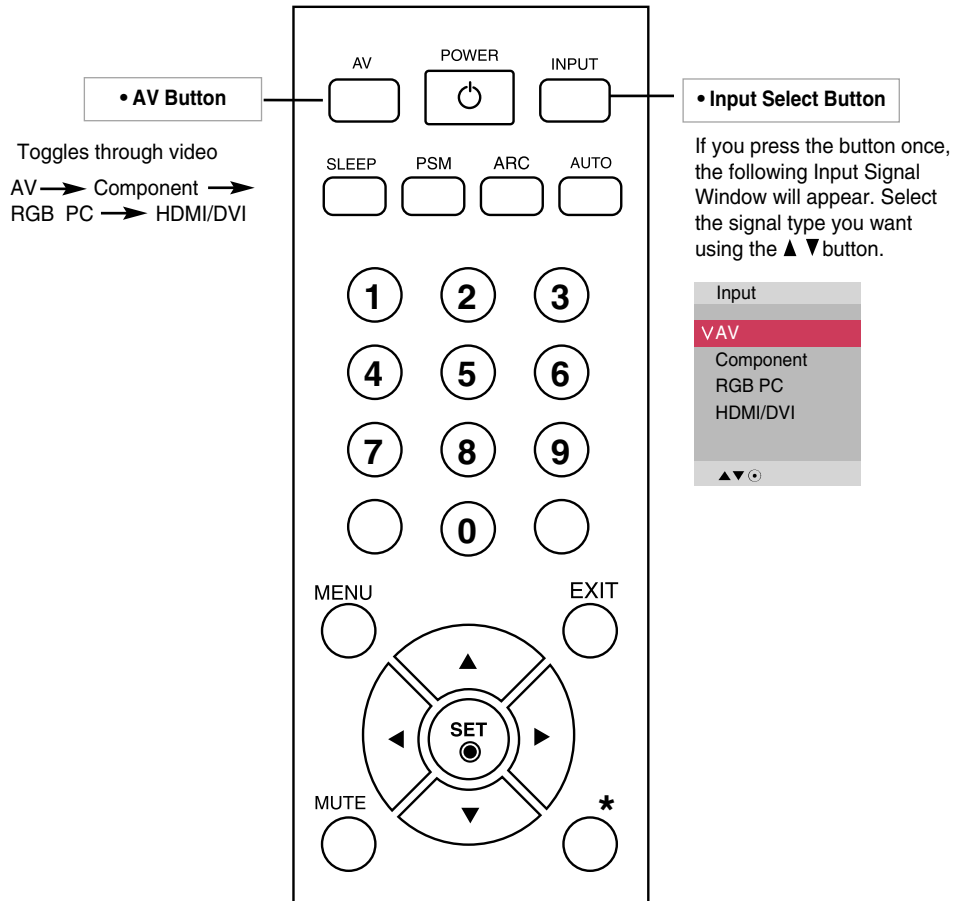

Inserting batteries into remote control.

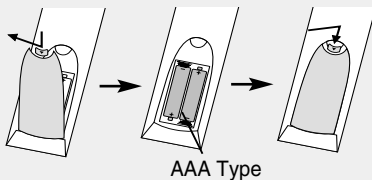

1. Slide off the battery cover.
2. Insert the batteries with correct polarity (+/-).
3. Close the battery cover.
 - Dispose of used batteries in the recycle bin to prevent environmental pollution.

Name and Function of the Parts

* The product image in the user's guide could be different from the actual image.

● Rear View

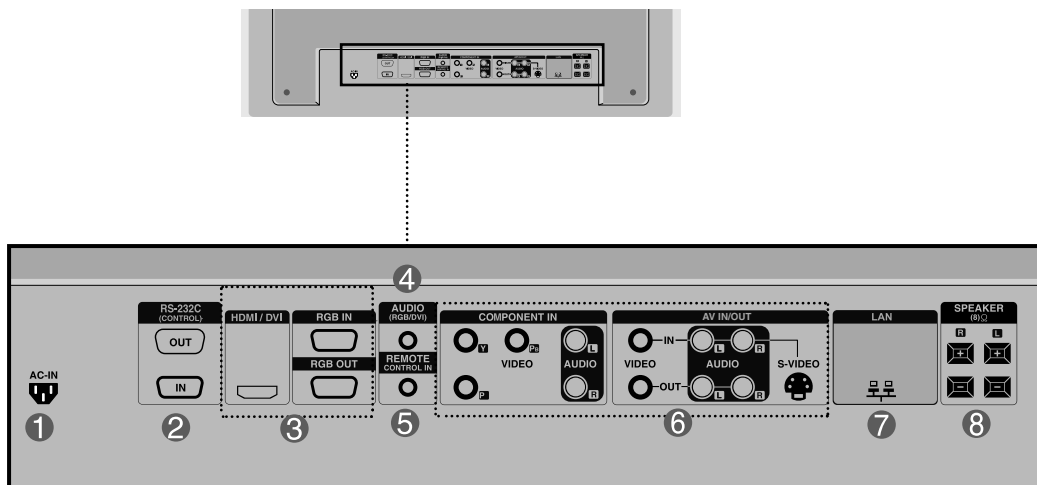

- 1 **Power Connector** : Connect the power cord
- 2 **RS-232C Serial Ports**
- 3 **RGB PC, HDMI/DVI Ports**
-HDMI Supports High Definition input and HDCP (High-bandwidth Digital Content Protection). Some devices require HDCP in order to display HD signals.
- 4 **PC Sound Jack**
: Connect the audio cable to the *LINE OUT jack of the PC sound card.
- 5 **Wired Remote Control Port**
- 6 **AV Ports**
- 7 **LAN Port**
- 8 **Speaker Ports**

*LINE OUT

A terminal used to connect to the speaker including a built-in amplifier (Amp). Make sure that the connecting terminal of the PC sound card is checked before connecting. If the Audio Out of PC sound card has only Speaker Out, reduce the PC volume.

If the Audio Out of the PC sound card supports both Speaker Out and Line Out, convert to Line Out using the card jumper of the program (Refer to the Sound Card Manual).

Connecting to External Devices

■ ■ ■ When Connecting to your PC

1 First of all, see if the computer, product and the peripherals are turned off. Then, connect the signal input cable.

A When connecting with the D-Sub signal input cable.

B When connecting with the HDMI to DVI signal input cable (not included).

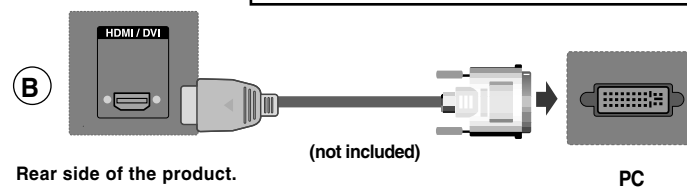
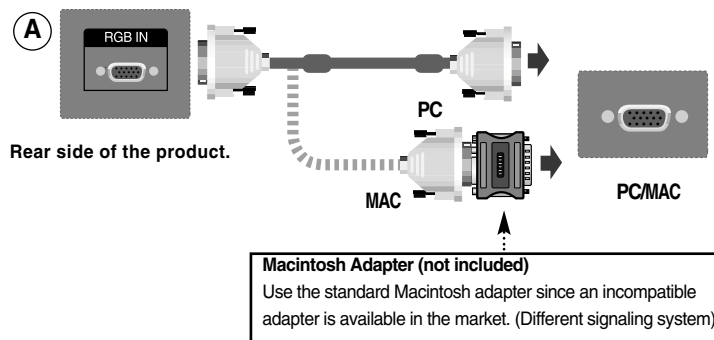

* User must use shielded signal interface cables (D-sub 15 pin cable, DVI cable) with ferrite cores to maintain standard compliance for the product.

2 Connect the Audio cable.



3 Connect the power cord.

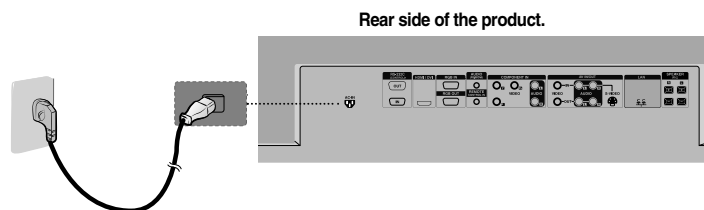

Connecting to External Devices

- 4 ① Turn on power by pressing the power button on the product.



- ② Turn on the PC.

- 5 ⑤ Select an input signal.
Press the INPUT button on the remote control to select the input signal.

INPUT → ▼▲ → SET

Or, press the SOURCE button on the back of the product.

SOURCE → ▼▲ → AUTO/SET

- A When connecting with a D-Sub signal input cable.
• Select **RGB PC** : 15-pin D-Sub analog signal.
- B When connecting with a HDMI to DVI signal input cable.
• Select **HDMI/DVI** : HDMI to DVI Digital signal.

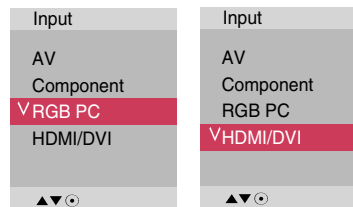

Note

- **How to connect to two computers.**
Connect the signal cables (HDMI to DVI and D-Sub) to each computer.
Press the INPUT button on the remote control to select the computer to use.
- **Directly connect to a grounded power outlet on the wall or a power bar with a ground wire.**

Connecting to External Devices

■ ■ ■ When using the Lan

1 Connect the Lan cable as shown in the below figure .

A When connecting with a PC.

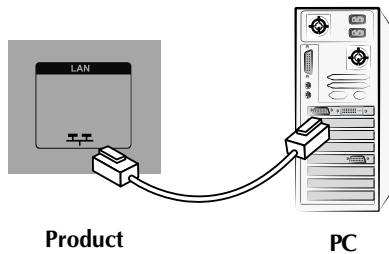

B When connecting with a Network.

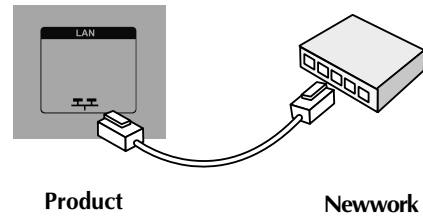

2 Please click on ez-Net Manager in the enclosed CD-ROM.
For more information about the program, please refer to ez-Net Guide in the enclosed CD-ROM.



Note

- Using LAN establishes communication between your PC and the monitor and enables to use the OSD menus on the PC as well as on the monitor.

Connecting to External Devices

■ ■ ■ Daisy Chain Monitors

Use this function when displaying ANALOG RGB inputs of a PC to the other product.

- **To use different products connected to each other**

Connect one end of the signal input cable(15-pin D-Sub Signal Cable) to the **RGB OUT** connector of **product 1** and connect the other end to the RGB IN connector of other products.

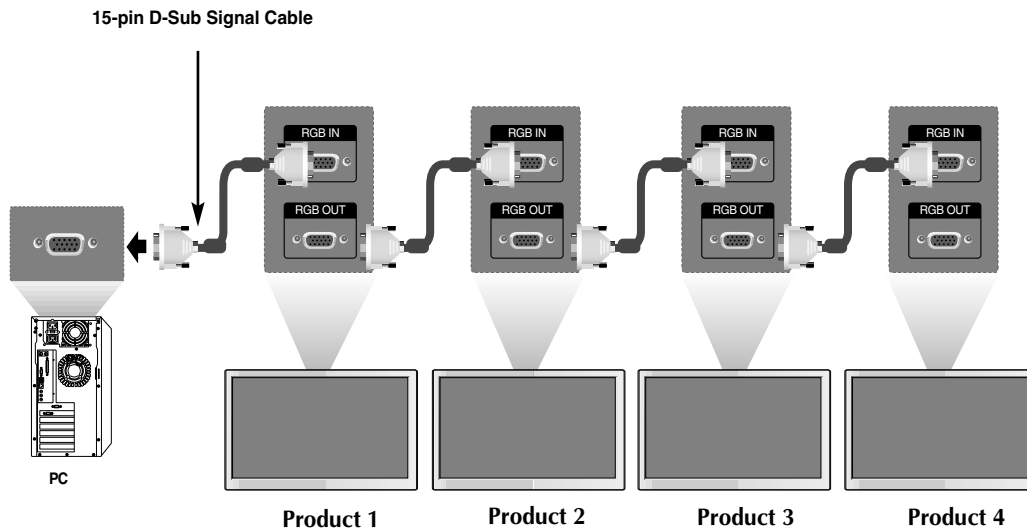

Note

- When multi-connecting in/out cascade format, no loss cables are recommended. We recommend that you should use cable distributor.

Connecting to External Devices

VESA FDMI wall Mounting

This product supports a VESA FDMI compliant mounting interface. These mounts are purchased separately and not available from LG. Refer to the instructions included with the mount for more info.

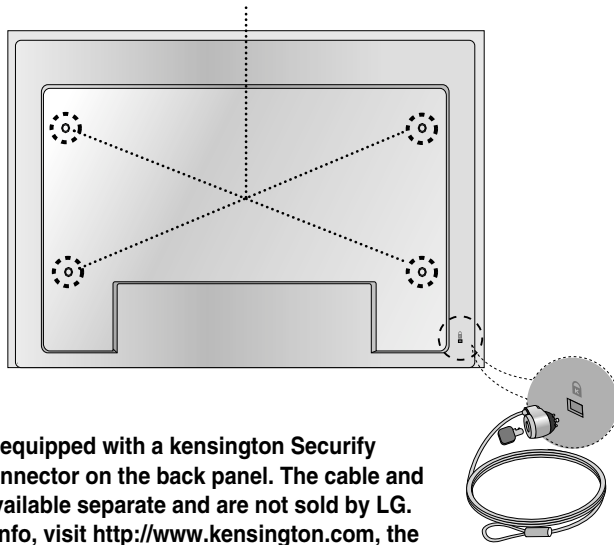

The Set is equipped with a Kensington Security System connector on the back panel. The cable and lock are available separately and are not sold by LG. For more info, visit <http://www.kensington.com>, the internet home page of the Kensington company.

Connecting to External Devices

Video Input

1 Connect the video cable as shown in the below figure and then connect the power cord (See page 7).

- A** When connecting with a BNC cable.
- Connect the input terminal with a proper color match.

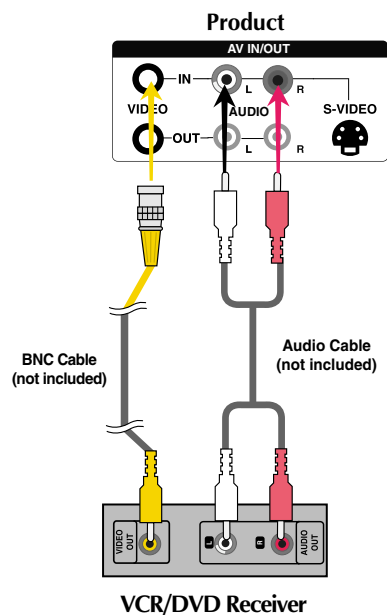

- B** When connecting with a S-Video cable.
- Connect to the S-Video input terminal to watch high image quality movies.

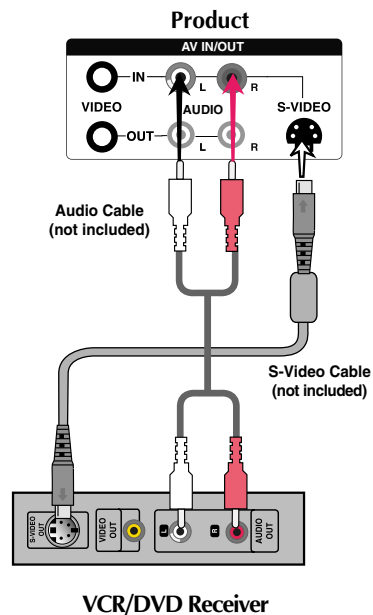

2 Select an input signal.
Press the INPUT button on the remote control to select the input signal.

INPUT → ▼▲ → SET

Or, press the SOURCE button on the back of the product.

SOURCE → ▼▲ → AUTO/SET

- A** When connecting with an BNC cable.
- Select AV.
- B** When connecting with an S-Video cable.
- Select AV.

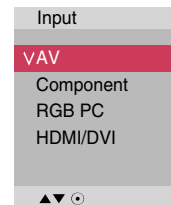

Note

- When the BNC cable is connected simultaneously with S-Video cable, S-Video input has a priority.

Connecting to External Devices

■ ■ ■ Component Input (480p/576p/720p/1080p/1080i/480i/576i)

1 Connect the video/audio cable as shown in the below figure and then, connect the power cord (See page 7).

- Connect the input terminal with a proper color match.

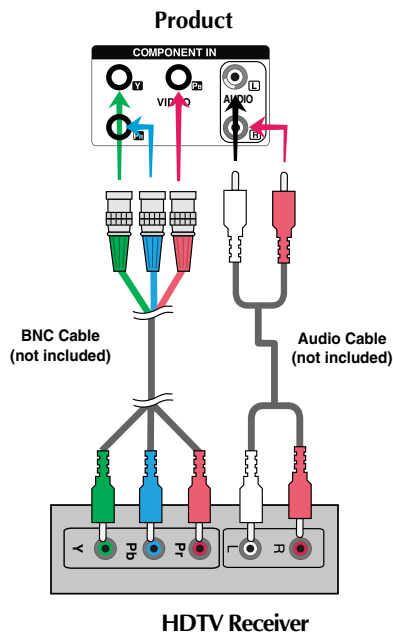

Note

- Some devices may require HDCP in order to display HD signals.
- Component doesn't support HDCP.

2 Select an input signal.
Press the INPUT button on the remote control to select the input signal.

INPUT → ▼▲ → SET

Or, press the SOURCE button on the back of the product.

SOURCE → ▼▲ → AUTO/SET

- Select **Component**

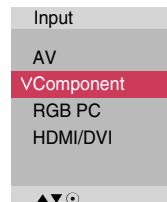

Connecting to External Devices

■ ■ ■ HDMI Input (480p/576p/720p/1080i/1080p)

-HDMI Supports High Definition input and HDCP (High-bandwidth Digital Content Protection). Some devices require HDCP in order to display HD signals.

- 1 Connect the video/audio cable as shown in the below figure and then connect the power cord (See page 7).

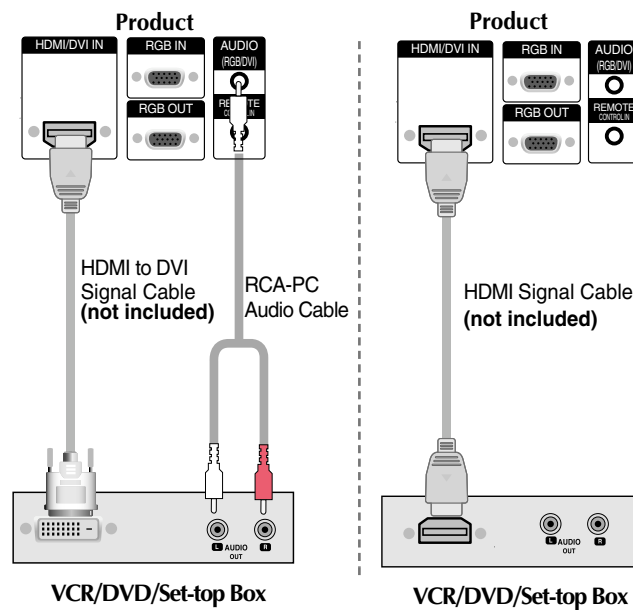

Note : Dolby Digital is not supported.

- 2 Select an input signal.
Press the INPUT button on the remote control to select the input signal.

INPUT → ▼▲ → SET

Or, press the SOURCE button on the back of the product.

SOURCE → ▼▲ → AUTO/SET

When connecting with a HDMI to DVI signal input cable.
When connecting with a HDMI signal input cable.

- Select **HDMI/DVI**

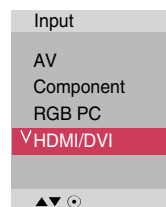

Connecting to External Devices

■ ■ ■ Watching AV Outputs

- When using AV input, you can connect the AV Out to other monitors.

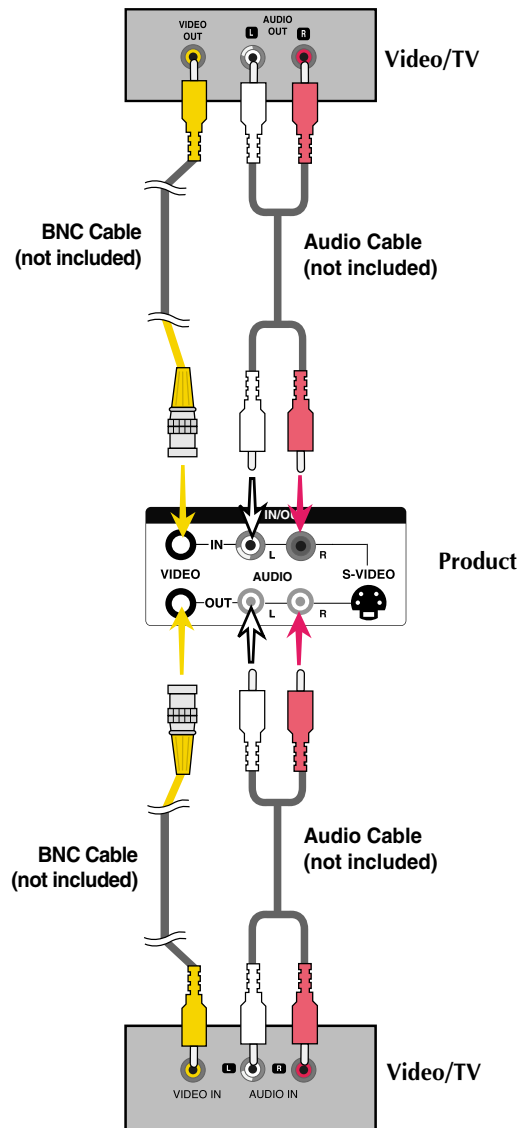

Note

- When multi-connecting in/out cascade format, no loss cables are recommended. We recommend that you should use cable distributor.

User Menus

● Screen Adjustment options

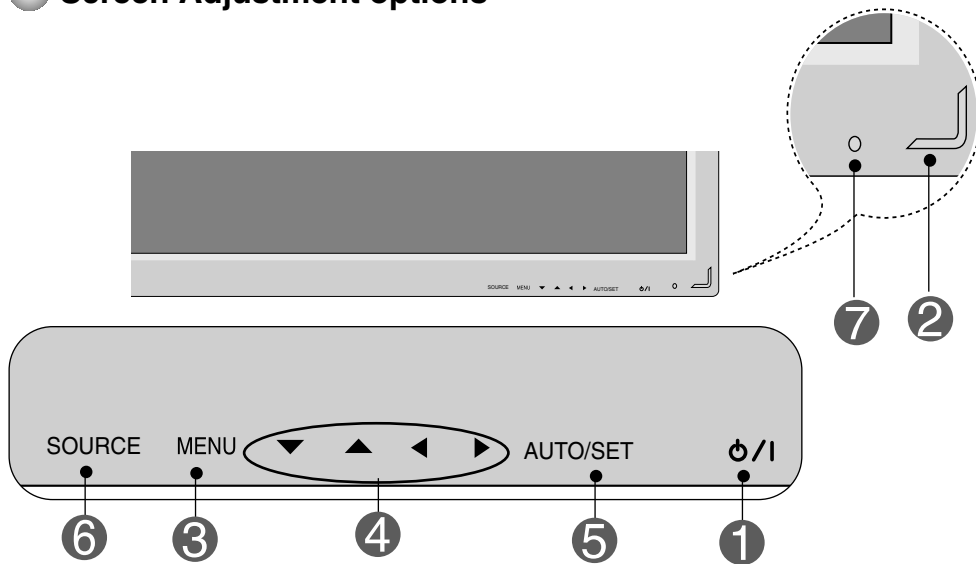

1 Power Button • Press this button to turn on the power. Press this button again to turn it off.

2 Power Indicator • This Indicator lights up blue when the display operates normally (on mode). If the display is in sleep (Energy Saving) mode, this indicator color changes to amber.

3 MENU Button • Use this button to show/hide the OSD (On Screen Display) menu screen.

4 OSD Select / Adjust Button • Use this button to select an icon or adjust the setting in the OSD screen.

▼▲ • Adjust the up and down.

◀▶ • Adjust the volume.

Volume 35
.....

User Menus

● Screen Adjustment options

5

AUTO/SET Button

[For PC Analog signal]

Auto in progress
For optimal display change
resolution to 1920 X 1080

[When 1920 X1080 is selected]

Auto in progress

6

SOURCE Button

SOURCE → ▼▲ → **AUTO/SET**

- Toggles between inputs

AV	Composite Video, Separate Video
Component	HDTV, DVD
RGB PC	15-pin D-Sub analog signal
HDMI/DVI	Digital signal

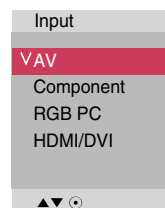





7

IR Receiver

• This is where the unit receives signals from the remote control.

User Menus

OSD Menu

Icon	Function Description
 Picture	Adjusts screen brightness, contrast and color that you prefer.
 Audio	Adjusts the audio options.
 Time	Adjusts the timer options.
 Option	Adjusts the screen status according to the circumstances.
 Information	Adjust Set ID and check Serial No. and SW version and IP address

**Note****OSD(On Screen Display)**

The OSD function enables you to adjust the screen status conveniently since it provides graphical presentation.

User Menus

● How to adjust the OSD (On Screen Display) screen

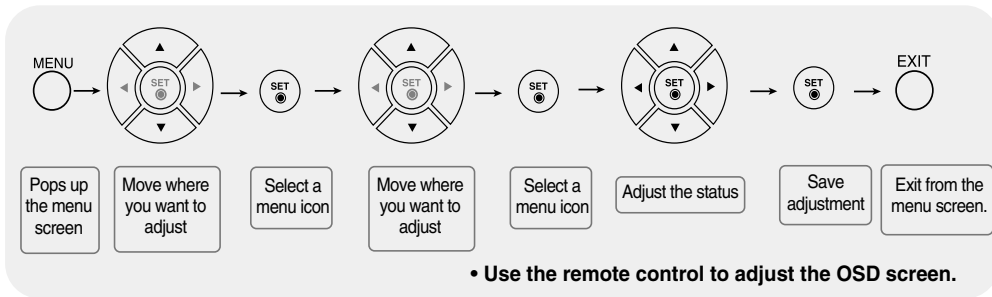

- 1 Press the **MENU** Button, then the main menu of the OSD appears.
- 2 To access a control, use the ▼ ▲ Buttons.
- 3 When the icon you want becomes highlighted, press the **SET** Button.
- 4 Use the ▼ ▲ ◀ ▶ Buttons to adjust the item to the desired level.
- 5 Accept the changes by pressing the **SET** Button.
- 6 Exit the OSD by pressing the **EXIT** Button.

● How to adjust the screen automatically

Press the AUTO/SET button (AUTO button on a remote Control) in the PC analog signal. Then optimal screen settings will be selected that fit into the current mode. If adjustment is not satisfactory, you can adjust the screen manually.

[When 1920 X1080 is selected]

Auto in progress

User Menus



Adjusting Screen Color

Picture Mode

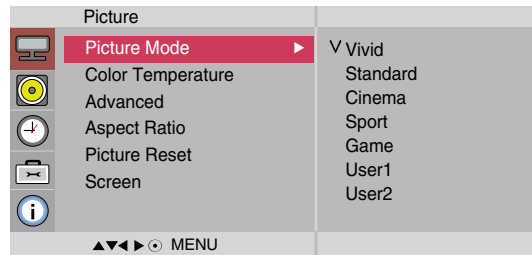

Toggles between screen presets.

- **Vivid** : Select this option to display with a sharp image.
- **Standard** : The most general and natural screen display status.
- **Cinema** : Select this option to lower brightness by one level.
- **Sport** : Select this option to display with a soft image.
- **Game** : To enjoy dynamic image when playing a game.
- **User1,2** : Select this option to use the user-defined settings.

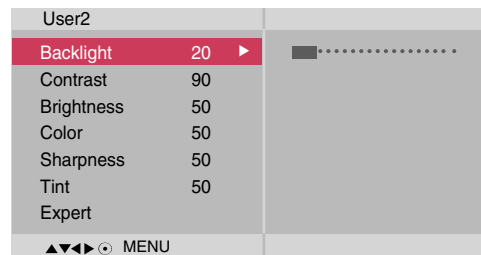

Backlight : To control the brightness of the screen, adjust the brightness of LCD panel.

Contrast : Adjust the difference between the light and dark levels in the picture.

Brightness : To adjust the brightness of the screen.

Color : To adjust the color to desired level.

Sharpness : To adjust the clearness of the screen.

Tint : To adjust the tint to desired level.

Expert : To compensate for each image mode, or adjust image values according to a particular image. (Applied only to User2 menu.)



Note

If the 'Picture Mode' setting in the **Picture** menu is set to **Vivid, Standard, Cinema, Sport** or **Game** the subsequent menus will be automatically set.

User Menus



Adjusting Screen Color

Color Temperature

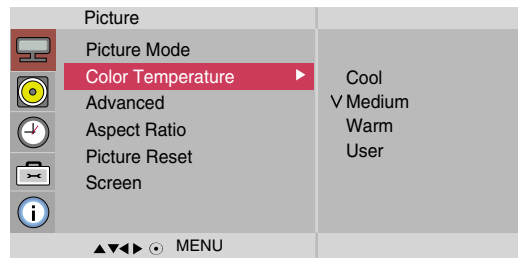

Color Settings

- **Cool** : Slightly purplish white.
- **Medium** : Slightly bluish white.
- **Warm** : Slightly reddish white.
- **User** : Select this option to use the user-defined settings.

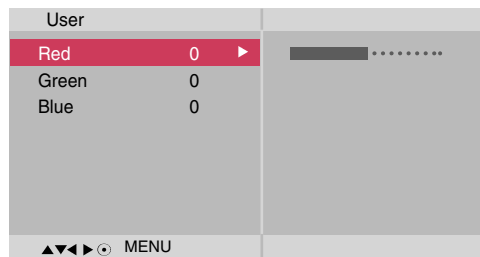

Red / Green / Blue

Set your own color levels.

User Menus



Adjusting Screen Color

Advanced

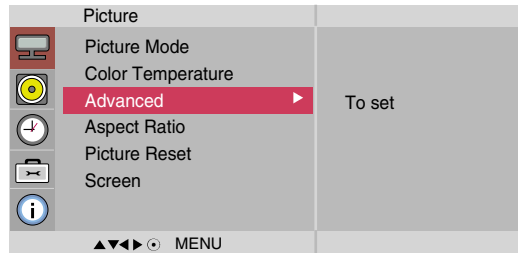

- **Gamma** : Set your own gamma value. : -50/0/50
On the monitor, high gamma values display whitish images and low gamma values display high contrast images.
- **Film Mode** : (Function works in the following mode - AV, Component 480i/576i)
When you watch a movie, this function adjusts the set to the best picture appearance.
- **Black Level** : (Function works in the following mode - AV(NTSC), HDMI/DVI)
adjusts the contrast and the brightness of the screen using the black level of the screen.
 - **Low** : The reflection of the screen gets brighter.
 - **High** : The reflection of the screen gets darker.
- **NR** : Removing the noise up to the point where it does not damage the original picture.

User Menus



Adjusting Screen Color

Aspect Ratio To select the image size of the screen.

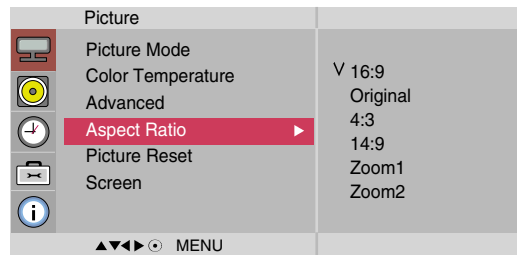

<AV>

- 16:9** Widescreen mode.
- Just Scan** Allows you to enjoy the transmitted data fully without any images cut off.
(* This menu is activated only in 720p, 1080p and 1080i in Component mode.)
- Original** The aspect ratio is not adjusted from the original. It is set by the program being watched.
- 4:3** This picture format is 4:3 aspect ratio.
- 1:1** The aspect ratio is not adjusted from the original. Used in PC mode.
(Only HDMI/ DVI PC, RGB PC)
- 14:9** 14:9 programs are viewed normally in 14:9 with black bars added to the top and bottom. 4:3 programs are magnified on the top/bottom and left/right sides.
- Zoom1, 2** 4:3 programmes are magnified until they fill the 16:9 screen. The top and bottom will be cut off.

ARC	MODE	AV	Component	HDMI/DVI		RGB
				DTV	PC	PC
16:9		●	●	●	●	●
Just Scan		×	●	●	×	×
Original		●	×	×	×	×
4:3		●	●	●	●	●
1:1		×	×	×	●	●
14:9		●	×	×	×	×
Zoom1		●	×	×	×	×
Zoom2		●	×	×	×	×

User Menus



Adjusting Screen Color

Picture Reset Return **Picture Mode**, **Color Temperature**, **Advanced** to the default factory settings.

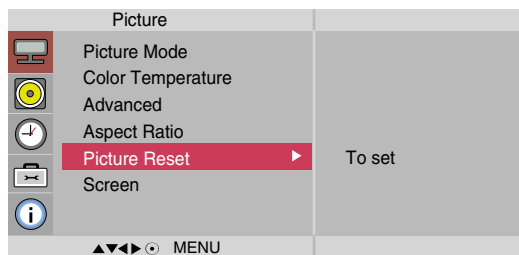

Screen Adjust the screen video.

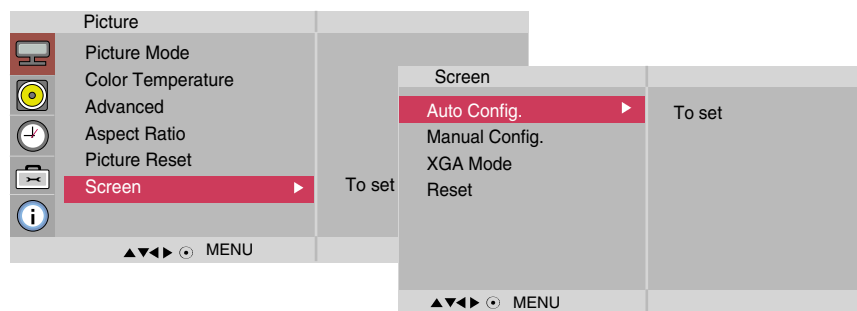

Auto Config. (RGB PC input only) : This button is for the automatic adjustment of the screen position, clock and phase. This function is available for analog signals only.

Manual Config. : If the picture isn't clear after auto adjustment and characters are still trembling, adjust the picture phase manually.

* Phase, Clock function are not available in Component, HDMI/DVI DTV.)

Clock : To minimize any vertical bars or stripes visible on the screen background. The horizontal screen size will also change. This function is available for analog signals only.

Phase : To adjust the focus of the display. This item allows you to remove any horizontal noise and clear or sharpen the image of characters. This function is available for analog signals only.

H-Position : Moving the screen position horizontally.

V-Position : Moving the screen position vertically.

H-Size : Adjust the horizontal size of the screen.

V-Size : Adjust the vertical size of the screen.

XGA Mode (RGB-PC only). : For more improved or better picture quality, select the same mode corresponding to computer resolution.

Reset: Return **Manual config.** to the default factory settings.

User Menus



Adjusting the audio function

Sound Mode

The best sound tone quality will be selected automatically depending on the video type that you're currently watching.

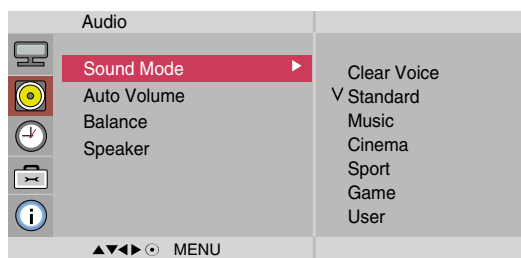

- **Clear Voice** : By differentiating the human sound range from others, it helps users listen to human voices better.
- **Standard** : The most commanding and natural audio.
- **Music** : Select this option to enjoy the original sound when listening to the music.
- **Cinema** : Select this option to enjoy sublime sound.
- **Sport** : Select this option to watch sports broadcasting.
- **Game** : To enjoy dynamic sound when playing a game.
- **User** : Select this option to use the user-defined audio settings.

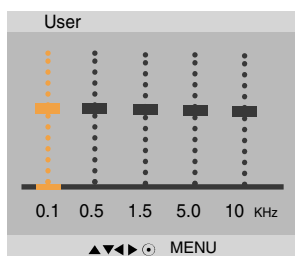

Auto Volume

To adjust uneven sound volumes across all channels or signals automatically to the most appropriate level. To use this feature, select On.

Balance

Use this function to balance sound from the left and right speakers.

Speaker

You can adjust internal speaker status.
If you want to use your external hi-fi stereo system, turn off the internal speakers of the set.



Note

When connected to your computer and the 'Sound Mode' setting in the audio menu is **Clear Voice, Standard, Music, Cinema** or **Sport**, the available menus are **Balance, Auto Volume, Speaker**.

User Menus



Adjusting the timer function

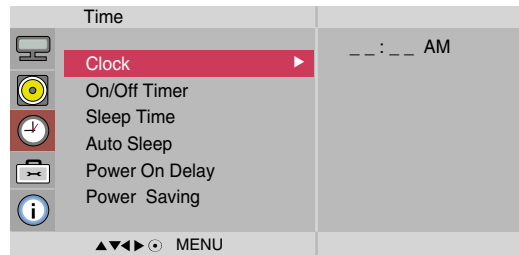

Clock

If the current time is incorrect, reset the clock manually.

- 1) Press the **MENU** button and then use **▼▲** button to select the **Time** menu.
- 2) Press the **▶** button and then use **▼▲** button to select the **Clock** menu.
- 3) Press the **▶** button and then use **▼▲** button to set the hour(00~23).
- 4) Press the **▶** button and then use **▼▲** button to set the minutes(00~59).

On/Off Timer

The off time automatically switches the set to standby at the pre-set time.

- 1) Press the **MENU** button and then use **▼▲** button to select the **Time** menu.
- 2) Press the **▶** button and then use **▼▲** button to select **On/Off Timer**.
- 3) Press the **▶** button and then use **▼▲** button to set the hour(00~23).
- 4) Press the **▶** button and then use **▼▲** button to set the minutes(00~59).
- 5) Press the **▶** button and then use **▼▲** button to select **On** or **Off**.
- 6) Press the **▶** button and then use **▼▲** button to select **Select input** or **On Timer**

Sleep Time

The power is automatically turned off when the time set by a user is passed.

- 1) Press the **MENU** button and then use **▼▲** button to select the **Sleep Time** menu.
- 2) Press the **▶** button and then use **▼▲** button to set the hour(00~23).
- 3) Press the **▶** button and then use **▼▲** button to set the minutes(00~59).

Auto Sleep

If **Auto Sleep** is active and there is no input signal, the set switches to off mode automatically after 10 minutes.

- 1) Press the **MENU** button and then use **▼▲** button to select the **Auto Sleep** menu.
- 2) Press the **▶** button and then use **▼▲** button to select **On** or **Off**.

Power On Delay

When connecting multiple monitors and turning the power on, the monitors are turned on individually to prevent overload.

Note



- In the event of power interruption (disconnection or power failure), the clock must be reset.
- Once the on or off time is set, these functions operate daily at the preset time.
- Off time function overrides On time function if they are set to the same time.
- When On time is operated, input screen is turned on as it was turned off.



Adjusting the timer function

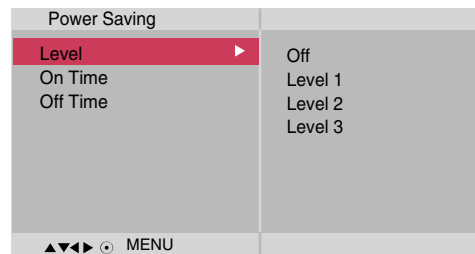
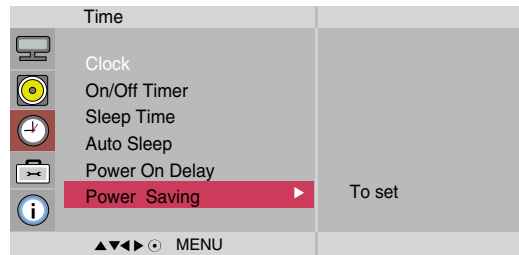

Power Saving

This screen brightness adjusting menu helps you save energy.

- **Level:** Total 4 screen brightness levels are provided.
 - Off: 100% light
 - Level 1: 80% light
 - Level 2: 60% light
 - Level 3: 40% light
- **On Time :** Enables to automatically turn on the Power Saving option at a scheduled time.
- **Off Time :** Enables to automatically turn off the Power Saving option at a scheduled time.

*The Power Saving option becomes in effect only during the scheduled time frame.
The On Time and Off Time menus become disabled if Level Off is selected.

User Menus



Selecting the options

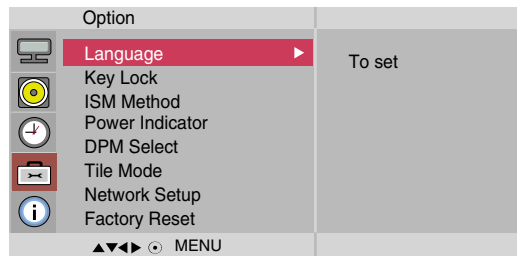

- Language** To choose the language in which the control names are displayed.
- Key Lock** Use the ▼ ▲ buttons to select **On** or **Off**. The monitor can be set up so that it can only be used with the remote control. This feature can prevent unauthorized viewing.
In order to lock the OSD screen adjustment, set the **Key Lock** tab to the '**On**' position.
In order to unlock it, do the following :
• Push the **MENU** button on the remote control and set **Key Lock** to the '**Off**' position.
- ISM Method** A frozen or still picture from a PC/Video game displayed on the screen for prolonged periods could result in a ghost image remaining even when you change the image. Avoid allowing a fixed image to remain on the screen for a long period of time.
Normal : Leave on normal if you don't foresee image burn in being a problem.
White wash : White wash fills the screen with solid white. This helps removes permanent images burned into the screen. A permanent image may be impossible to clear entirely with white wash.
Orbiter : May help prevent ghost images. However, it is best not to allow any fixed image to remain on the screen. To avoid a permanent image on the screen, the screen will move every 2 minutes.
Inversion : This function inverts the panel color of the screen. The panel color is automatically inverted every 30 minutes.
Dot Wash : This function moves the black dots of the screen. The black dots is automatically moved every 5 second.
- Power Indicator** Use this function to set the power indicator on the front side of the product to **On** or **Off**.
- DPM Select** A user can choose to turn the power saving mode on / off.

User Menus



Selecting the options

• To use this function

- Must be displayed with various other products.
- Must be in a function that can be connected to RS-232C or RGB Out

Tile mode	Option			
	Language	Tile Mode	Off	It is used to enlarge the screen and also used with several products to view screen.
	Key Lock	H-Size	0	
	ISM Method	V-Size	0	
	Power Indicator	H-Position	<>	
	DPM Select	V-Position	<>	
	Tile Mode	Reset		
	Network Setup	Tile ID	1	
	Factory Reset	Natural	Off	
▲▼▶◀ MENU				

- **Tile Mode** Tile mode and choose Tile alignment and set the ID of the current product to set location.

* Only after pressing the SET button the adjustments made to the settings will be saved.

- Tile mode : column x row (c = 1, 2, 3, 4,5 r = 1, 2, 3, 4,5)
- 5 x 5 available.
- Configuration of an integration screen is also available as well as configuration of One by one Display.



- Tile mode (product 1 ~ 4) : c(2) x r(2)

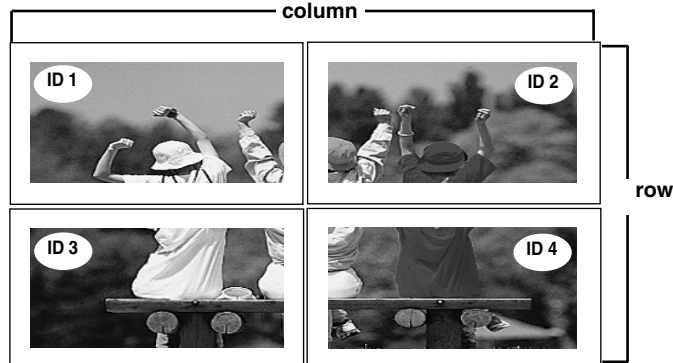

User Menus



Selecting the options

- Tile mode (product 1 ~ 9) : c(3) x r(3)

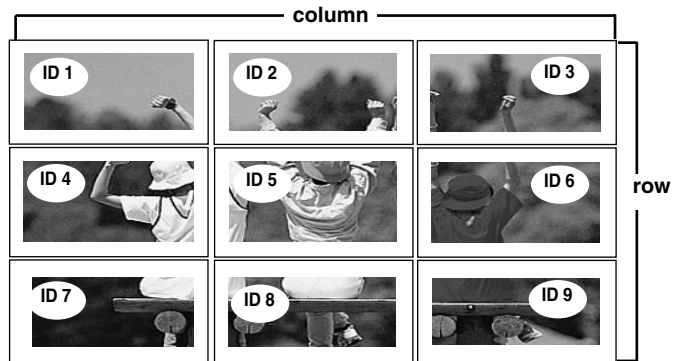

- Tile mode (product 1 ~ 2) : c(2) x r(1)

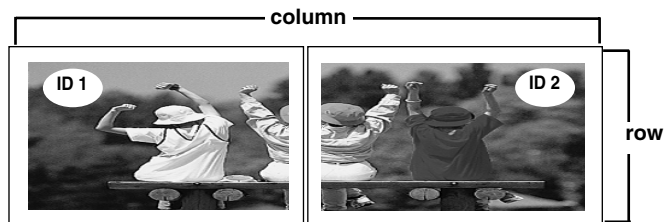



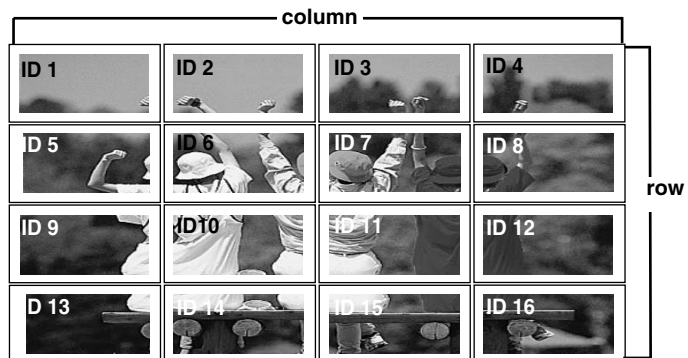





- Tile mode (product 1 ~16) : c(4) x r(4)











User Menu

Selecting the options

Tile mode	Option		
	Language	Tile Mode	Off
	Key Lock	H-Size	0
	ISM Method	V-Size	0
	Power Indicator	H-Position	<>
	DPM Select	V-Position	<>
	Tile Mode	Reset	
	Network Setup	Tile ID	1
	Factory Reset	Natural	Off
▲▼▶◀ MENU			

- **H-Size** Adjust the horizontal size of the screen taking into account the size of the bezel.
- **V-Size** Adjust the vertical size of the screen taking into account the size of the bezel.
- **H-Position** Moving the screen position horizontally.
- **V-Position** Moving the screen position vertically.
- **Reset** Function to initialize and release Tile.
All Tile setting are released when selecting Tile recall and the screen returns to Full screen.
- **Tile ID** Select the location of the Tile by setting an ID.
- **Natural** The image is omitted by the distance between the screens to be naturally shown.

Network Setup Network관련 정보를 설정할 수 있습니다.

Option										
	Language									
	Key Lock									
	ISM Method									
	Power Indicator									
	DPM Select									
	Tile Mode									
	Network Setup	To set								
	Factory Reset									
▲▼▶◀ MENU										
		<table border="1"> <thead> <tr> <th>Network Setup</th> <th></th> </tr> </thead> <tbody> <tr> <td>Network Select</td> <td>LAN RS-232C</td> </tr> <tr> <td>DHCP</td> <td></td> </tr> <tr> <td>Manual</td> <td></td> </tr> </tbody> </table>	Network Setup		Network Select	LAN RS-232C	DHCP		Manual	
Network Setup										
Network Select	LAN RS-232C									
DHCP										
Manual										
▲▼▶◀ MENU										

- **Network Select** Network과 연결된 통신을 설정할 수 있습니다.
-LAN: Ethernet 과 통신이 가능합니다.
-RS-232C: Serial과 통신 가능합니다.
- **DHCP** 자동으로 IP를 할당하고 설정합니다.
- **Manual** 원하는 IP address, Gateway, Subnet Mask, Primary DNS, Secondary DNS등을 설정합니다.

*Network Select가 Serial 설정 시에는 DHCP, Manual 항목은 비활성화 됩니다.

Factory Reset Select this option to return to the default factory settings.

User Menu



Adjust Set ID and check Serial No. and SW version.

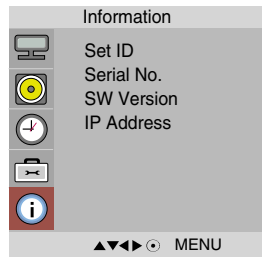

- Set ID** You can assign a unique **Set ID NO** (name assignment) to each product when several products are connected for display. Specify the number (01H-63H) using the ▼ ▲ button and exit. Use the assigned **Set ID** to individually control each product using the Product Control Program.
- Serial No.** This menu shows the serial number of the product.
- SW Version** This menu shows the software version.
- IP Address** Displays a selected network 's IP address.

Troubleshooting

No image is displayed

- | | |
|---|--|
| <ul style="list-style-type: none"> ● Is the product power cord connected? ● Is the power indicator light on? ● Power is on, power indicator is blue but the screen appears extremely dark. ● the power indicator amber? ● Does the 'Out of range' message appear? ● Does the 'Check signal cable' message appear? | <ul style="list-style-type: none"> • See if the power cord is properly connected to the outlet. • See if the power switch is turned on. • May need service. • Adjust brightness and contrast again. • Backlight may need repair. • If the product is in power saving mode, move the mouse or press any key. • Turn both devices off and then back on. • The signal from the PC (video card) is out of the vertical or horizontal frequency range of the product. Adjust the frequency range by referring to the Specifications in this manual. <ul style="list-style-type: none"> * Maximum resolution RGB : 1920 x 1080 @60Hz HDMI/DVI : 1920 x 1080 @60Hz • The signal cable between PC and product is not connected. Check the signal cable. • Press the 'INPUT' menu in the remote Control to check the input signal. |
|---|--|

'Unknown Product' message appears when the product is connected.

- | | |
|---|---|
| <ul style="list-style-type: none"> ● Did you install the driver? | <ul style="list-style-type: none"> • Install the product driver, which is provided with the product, or download it from the web site. (http://www.lge.com) • See if the plug&play function is supported by referring to the video card user manual. |
|---|---|

'Key Lock On' message appears.

- | | |
|--|--|
| <ul style="list-style-type: none"> ● The 'Key Lock On' message appears when pressing the Menu button. | <ul style="list-style-type: none"> • The control locking function prevents unintentional OSD setting change due to careless usage. To unlock the controls, simultaneously press the Menu button and ► button for several seconds. (You cannot set this function using the remote control buttons. You can set this function in the product only.) |
|--|--|



Note

* **Vertical frequency:** To enable the user to watch the product display, screen image should be changed tens of times every second like a fluorescent lamp. The vertical frequency or refresh rate is the times of image display per second. The unit is Hz.

* **Horizontal frequency:** The horizontal interval is the time to display one vertical line. When 1 is divided by the horizontal interval, the number of horizontal lines displayed every second can be tabulated as the horizontal frequency. The unit is kHz.

Troubleshooting

The screen image looks abnormal.

- **Is the screen position wrong?**
 - D-Sub analog signal – Press the “AUTO” button in the remote control to automatically select the optimal screen status that fits into the current mode. If adjustment is not satisfactory, use the Position OSD menu.
 - See if the video card resolution and frequency are supported by the product. If the frequency is out of range, set to the recommended resolution in the Control Panel – Display – Setting menu.
- **Do thin lines appear on the background screen?**
 - D-Sub analog signal – Press the “AUTO” button in the remote control to automatically select an optimal screen status that fits into the current mode. If adjustment is not satisfactory, use the Clock OSD menu.
- **Horizontal noise appears or the characters look blurred.**
 - D-Sub analog signal – Press the “AUTO” button in the remote control to automatically select an optimal screen status that fits into the current mode. If adjustment is not satisfactory, use the Phase OSD menu.
- **The screen is displayed abnormally.**
 - The proper input signal is not connected to the signal port. Connect the signal cable that matches with the source input signal.

After-image appears on the product.

- **After-image appears when the product is turned off.**
 - If you use a fixed image for a long time, the pixels may be damaged quickly. Use the screen-saver function.

Troubleshooting

The audio function does not work.

- No sound?
 - See if the audio cable is connected properly.
 - Adjust the volume.
 - See if the sound is set properly.
- Sound is too dull.
 - Select the appropriate equalize sound.
- Sound is too low.
 - Adjust the volume.

Screen color is abnormal.

- Screen has poor color resolution (16 colors).
 - Set the number of colors to more than 24 bits (true color)
Select Control Panel – Display – Settings – Color Table menu in Windows.
- Screen color is unstable or mono-colored.
 - Check the connection status of the signal cable.
Or, re-insert the PC video card.
- Do black spots appear on the screen?
 - Several pixels (red, green, white or black color) may appear on the screen, which can be attributable to the unique characteristics of the LCD panel. It is not a malfunction of the LCD.

The operation does not work normally.

- The power suddenly turned off.
 - Is the sleep timer set?
 - Check the power control settings.
Power interrupted.
 - "CAUTION! FAN STOP!"
If the power is turned off after this message appears, it means that the fan is out of order. In this case, contact your local service center.

Specifications

The product specifications can change without prior notice for product improvement.

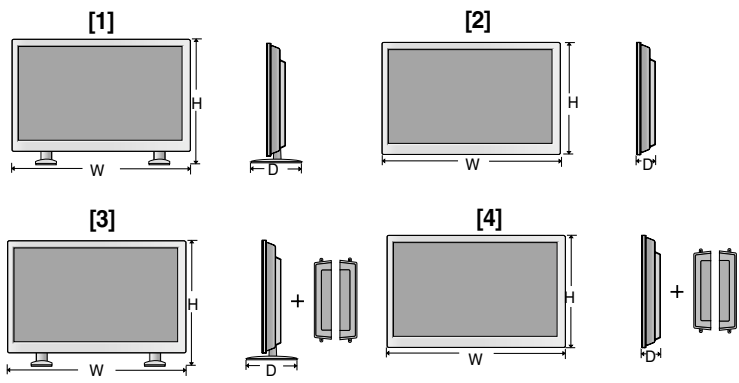
LCD Panel	<p>42.02 inches (106.731 cm) TFT (Thin Film Transistor) LCD (Liquid Crystal Display) Panel Visible diagonal size: 106.73 cm 0.4845 mm x 0.4845 mm (Pixel Pitch)</p>
Power	<p>Rated Voltage AC 100-240V ~ 50/60Hz 2.2A Power Consumption On Mode : 220W Typ. Sleep Mode : ≤ 1W (RGB) / 4W(HDMI/DVI) (If LAN OFF is selected) Off Mode : ≤ 1W</p>
Dimensions & Weight	<div style="text-align: center;">  </div> <p>Width x Height x Depth</p> <p>[1] 96.7 cm (38.07 inches) x 63.5 cm (24.99 inches) x 25.86 cm (10.18 inches) [2] 96.7 cm (38.07 inches) x 55.98 cm (22.03 inches) x 12.369 cm (4.87 inches) [3] 96.7 cm (38.07 inches) x 63.5 cm (24.99 inches) x 25.86 cm (10.18 inches) [4] 96.7 cm (38.07 inches) x 55.98 cm (22.03 inches) x 12.369 cm (4.87 inches)</p> <p>Net</p> <p>[1] 19.92 kg (43.92 lbs) [2] 18.64 kg (41.10 lbs) [3] 20.66 kg (45.55 lbs) [4] 19.38 kg (42.73 lbs)</p>

NOTE

- Information in this document is subject to change without notice.

Specifications

The product specifications can change without prior notice for product improvement.

Video Signal	Max. Resolution	RGB : 1920 X 1080 @60Hz HDMI/DVI : 1920 X 1080 @60Hz – It may not be supported depending on the OS or video card type.
	Recommended Resolution	RGB : WSXGA 1920 X 1080@60Hz HDMI/DVI : WSXGA 1920 X 1080 @60Hz – It may not be supported depending on the OS or video card type.
	Horizontal Frequency	RGB : 30 - 83 kHz HDMI/DVI : 30 - 83 kHz
	Vertical Frequency	RGB : 56 - 75 Hz HDMI/DVI : 56 - 60 Hz
	Synchronization Type	Composite/Separate/Digital
Input Connector	15-pin D-Sub type, HDMI (digital), S-Video, Composite Video, Component, RS-232C, LAN	
Environmental Conditions	Operational Condition	Temperature: 0°C ~ 40°C , Humidity: 10% ~ 80%
	Storage Condition	Temperature: -20°C ~ 60°C , Humidity: 5% ~ 90%

* Applicable only for models that support the speakers

Audio	RMS Audio Output	10W+10W(R+L)
	Input Sensitivity	0.7Vrms
	Speaker Impedance	8Ω

NOTE

- Information in this document is subject to change without notice.

Specifications

● PC Mode – Preset Mode

Preset mode		Horizontal Frequency (kHz)	Vertical Frequency (Hz)	Preset mode		Horizontal Frequency (kHz)	Vertical Frequency (Hz)
1	640 x 350	31.469	70.8	*11	1280 x 768	47.7	60
2	720 x 400	31.468	70.8	*12	1360 x 768	47.72	59.799
*3	640 x 480	31.469	59.94	*13	1366 x 768	47.7	60
4	640 x 480	37.5	75	*14	1280 x 1024	63.981	60.02
*5	800 x 600	37.879	60.317	15	1280 x 1024	79.98	75.02
6	800 x 600	46.875	75	*16	1680 x 1050	65.290	59.954
7	832 x 624	49.725	74.55	*17	1920 x 1080	67.5	60
*8	1024 x 768	48.363	60				
9	1024 x 768	60.123	75.029				
*10	1280 x 720	44.772	59.855				

1~17: RGB Mode
* : HDMI/DVI mode

● DTV Mode

	Component	HDMI/DVI(DTV)
480i	o	x
576i	o	x
480p	o	o
576p	o	o
720p	o	o
1080i	o	o
1080p	o	o

● Power Indicator

Mode	Product
On Mode	Green
Sleep Mode	Amber
Off Mode	-

NOTE

- DTV/PC selection on RGB and HDMI/DVI inputs is available for PC resolutions : 640 X 480/60Hz, 1280 X 720/60Hz, 1920 X 1080/60Hz and DTV resolutions : 480p, 720p, 1080p.

Controlling the Multiple Product

**Use this method to connect several products to a single PC.
You can control several products at a time by connecting them to a single PC.**

Connecting the cable

Connect the RS-232C cable as shown in the picture.

* The RS-232C protocol is used for communication between the PC and product. You can turn the product on/off, select an input source or adjust the OSD menu from your PC.

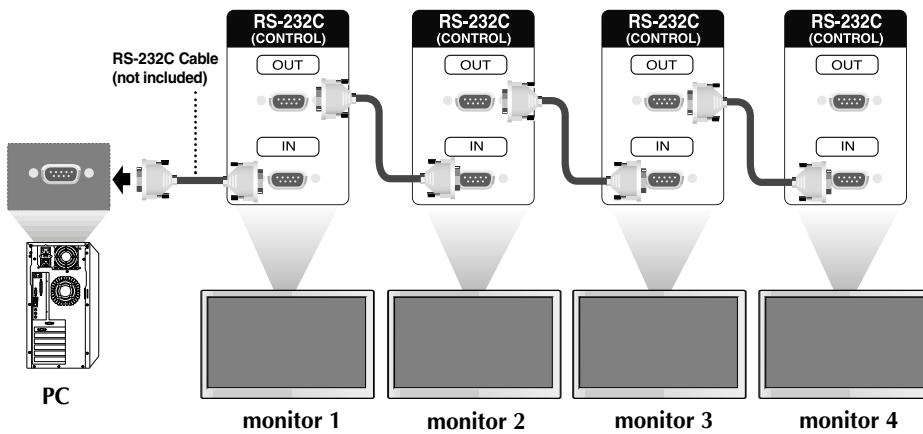

RS-232C Configurations

7-Wire Configurations (Standard RS-232C cable)

	PC	Monitor	
RXD	2	3	TXD
TXD	3	2	RXD
GND	5	5	GND
DTR	4	6	DSR
DSR	6	4	DTR
RTS	7	8	CTS
CTS	8	7	RTS

D-Sub 9 (Female) D-Sub 9 (Female)

3-Wire Configurations (Not Standard)

	PC	Monitor	
RXD	2	3	TXD
TXD	3	2	RXD
GND	5	5	GND
DTR	4	6	DTR
DSR	6	4	DSR
RTS	7	7	RTS
CTS	8	8	CTS

D-Sub 9 (Female) D-Sub 9 (Female)

Communication Parameter

- ▶ Baud Rate : 9600baudRate (UART)
- ▶ Data Length : 8bits
- ▶ Parity Bit : None
- ▶ Stop Bit : 1bit
- ▶ Flow Control : None
- ▶ Communication Code : ASCII code
- ▶ Use a crossed (reverse) cable

 Command Reference List

	COMMAND1	COMMAND2	DATA1	DATA2	DATA3
01. Power	k	a	00H - 01H		
02. Input Select	k	b	02H - 09H		
03. Aspect Ratio	k	c	01H - 09H		
04. Screen Mute	k	d	00H - 01H		
05. Volume Mute	k	e	00H - 01H		
06. Volume Control	k	f	00H - 64H		
07. Contrast	k	g	00H - 64H		
08. Brightness	k	h	00H - 64H		
09. Color	k	i	00H - 64H		
10. Tint	k	j	00H - 64H		
11. Sharpness	k	k	00H - 64H		
12. OSD Select	k	l	00H - 01H		
13. Remote Lock/ key Lock	k	m	00H - 01H		
14. Balance	k	t	00H - 64H		
15. Color Temperature	k	u	00H - 03H		
16. Abnomal state	k	z	FFH		
17. ISM mode	j	p	00H - 10H		
18. Auto configuration	j	u	01H		
19. Key	m	c	Key Code		
20. Tile Mode	d	d	00H - 55H		
21. Tile H Position	d	e	00H - 64H		
22. Tile V Position	d	f	00H - 64H		
23. Tile H Size	d	g	00H - 64H		
24. Tile V Size	d	h	00H - 64H		
25. Tile ID Set	d	i	00H - 19H		
26. Natural Mode (In Tilemode)	d	j	00H - 01H		
27. Picture mode(PSM)	d	x	00H - 09H		
28. Sound mode	d	y	00H - 09H		
29. Fan Fault check	d	w	FFH		
30. Elapsed time return	d	l	FFH		
31. Temperature value	d	n	FFH		
32. Lamp fault check	d	p	FFH		
33. Auto Volume	d	u	00H - 01H		
34. Speaker	d	v	00H - 01H		
35. Time	f	a	00H - 06H	00H - 17H	00 - 3BH
36. On Timer (On/Off Timer) On, Off	f	b	00H, FFH	00H - FFH	
37. Off Timer (On/Off Timer) On, Off	f	c	00H, FFH	00H - FFH	
38. On Timer (On/Off Timer) Time	f	d	00H - 07H	00H - 17H	00 - 3BH
39. Off Timer (On/Off Timer) Time	f	e	00H - 07H	00H - 17H	00 - 3BH
40. Sleep Time	f	f	00H - 08H		
41. Auto Sleep	f	g	00H - 01H		
42. Power On Delay	f	h	00H - 64H		
43. Language	f	i	00H - 09H		
44. DPM Select	f	j	00H - 01H		
45. Reset	f	k	00H - 02H		

	COMMAND1	COMMAND2	DATA1	DATA2	DATA3
46. Power Saving	f	1	00H - 03H		
47. Power Indicator	f	o	00H - 01H		
48. H Position	f	q	00H - 64H		
49. V Position	f	r	00H - 64H		
50. H Size	f	s	00H - 64H		
51. V Size	f	t	00H - 64H		
52. Scheduling input select	f	u	00H - 07H	00H - FEH	
53. Serial no.	f	y	FFH		
54. S/W Version	f	z	FFH		
55. Input Select	x	b	20H - A0H		

● Transmission / Receiving Protocol

Transmission

[Command1][Command2][][Set ID][][Data][Cr]

- * [Command 1]: First command. (k)
- * [Command 2]: Second command.(a ~ u)
- * [Set ID]: Set up the Set ID number of product.
range : 01H~63H. by setting '0', server can control all products.
* In case of operating with more than 2 sets using set ID as '0' at the same time, it should not be checked the ack message.
Because all sets will send the ack message, so it's impossible the check the whole ack messages.
- * [DATA]: To transmit command data.
Transmit 'FF' data to read status of command.
- * [Cr]: Carriage Return
ASCII code '0x0D'
- * []: ASCII code Space (0x20)

OK Acknowledgement

[Command2][][Set ID][][OK][Data][x]

- * The Product transmits ACK (acknowledgement) based on this format when receiving normal data. At this time, if the data is data read mode, it indicates present status data.
If the data is data write mode, it returns the data of the PC computer.

Error Acknowledgement

[Command2][][Set ID][][NG][Data][x]

- * If there is error, it returns NG

● Transmission / Receiving Protocol

01. Power(Command : a)

- ▶ To control Power On/Off of the Set.

Transmission

```
[k][a][ ][Set ID][ ][Data][Cr]
```

Data 0 : Power Off 1 : Power On

Acknowledgement

```
[a][ ][Set ID][ ][OK][Data][x]
```

- ▶ To show the status of Power On/Off.

Transmission

```
[k][a][ ][Set ID][ ][FF][Cr]
```

Acknowledgement

```
[a][ ][Set ID][ ][OK][Data][x]
```

Data 0 : Power Off 1 : Power On

02. Input Select (Command : b) (Main Picture Input)

- ▶ To select input source for the Set.
You can also select an input source using the INPUT button on the remote control.

Transmission

```
[k][b][ ][Set ID][ ][Data][Cr]
```

Data 2 : AV
4 : Component
7 : RGB (PC)
8 : HDMI (DTV)
9 : HDMI (PC)

Acknowledgement

```
[b][ ][Set ID][ ][OK][Data][x]
```

Data 2 : AV
4 : Component
7 : RGB (PC)
8 : HDMI (DTV)
9 : HDMI (PC)

 Transmission / Receiving Protocol**03. Aspect Ratio(Command : c) (Main picture format)**

▶ To adjust the screen format.

You can also adjust the screen format using the ARC (Aspect Ratio Control) button on remote control or in the Screen menu.

Transmission

```
[k][c][ ][Set ID][ ][Data][Cr]
```

Data 1 : Normal Screen (4:3)
2 : Wide Screen (16 :9)
4 : Zoom1 (AV)
5 : Zoom2 (AV)
6 : Original (AV)
7 :14:9 (AV)
9 : Just Scan(HD DTV), 1:1 (RGB PC, HDMI/DVI PC)

Acknowledgement

```
[c][ ][Set ID][ ][OK][Data][x]
```

04. Screen Mute(Command : d)

▶ To select screen mute on/off.

Transmission

```
[k][d][ ][Set ID][ ][Data][Cr]
```

Data 0 : Screen mute off (Picture on)
1 : Screen mute on (Picture off)

Acknowledgement

```
[d][ ][Set ID][ ][OK][Data][x]
```

● Transmission / Receiving Protocol

05. Volume Mute(Command : e)

- ▶ To control On/Off of the Volume Mute.

Transmission

```
[k][e][ ][Set ID][ ][Data][Cr]
```

Data 0 : Volume Mute On (Volume Off)
1 : Volume Mute Off (Volume On)

Acknowledgement

```
[e][ ][Set ID][ ][OK][Data][x]
```

Data 0 : Volume Mute On (Volume Off)
1 : Volume Mute Off (Volume On)

06. Volume Control(Command : f)

- ▶ To adjust Volume .

Transmission

```
[k][f][ ][Set ID][ ][Data][Cr]
```

Data Min : 00H ~ Max : 64H
(Hexadecimal code)

Acknowledgement

```
[f][ ][Set ID][ ][OK][Data][x]
```

Data Min : 00H ~ Max : 64H

- Refer to 'Real data mapping' page A7.

● Transmission / Receiving Protocol

07. Contrast(Command : g)

- ▶ To adjust screen contrast.
- You can also adjust the contrast in the Picture menu.

Transmission

```
[k][g][ ][Set ID][ ][Data][Cr]
```

Data Min : 00H ~ Max : 64H

- Refer to 'Real data mapping' as shown below.

Acknowledgement

```
[g][ ][Set ID][ ][OK][Data][x]
```

- * Real data mapping
- 0 : Step 0
- :
- A : Step 10
- :
- F : Step 15
- 10 : Step 16
- :
- 64 : Step 100

08. Brightness(Command : h)

- ▶ To adjust screen brightness.
- You can also adjust the brightness in the Picture menu.

Transmission

```
[k][h][ ][Set ID][ ][Data][Cr]
```

Data Min : 00H ~ Max : 64H

- Refer to 'Real data mapping' as shown below.

Acknowledgement

```
[h][ ][Set ID][ ][OK][Data][x]
```

- * Real data mapping
- 0 : Step
- :
- A : Step 10
- :
- F : Step 15
- 10 : Step 16
- :
- 64 : Step 100

● Transmission / Receiving Protocol

09. Color(Command : i) (Video only)

- ▶ To adjust the screen color.
You can also adjust the color in the Picture menu.

Transmission

```
[k][i][ ][Set ID][ ][Data][Cr]
```

Data Min : 00H ~ Max : 64H
(Hexadecimal code)

- Refer to 'Real data mapping' page A7.

Acknowledgement

```
[i][ ][Set ID][ ][OK][Data][x]
```

Data Min : 00H ~ Max : 64H

10. Tint(Command : j) (Video only)

- ▶ To adjust the screen tint.
You can also adjust the tint in the Picture menu.

Transmission

```
[k][j][ ][Set ID][ ][Data][Cr]
```

Data Red: 00H ~ Green: 64H
(Hexadecimal code)

- Refer to 'Real data mapping' page A7.

Acknowledgement

```
[j][ ][Set ID][ ][OK][Data][x]
```

Data Red: 00H ~ Green: 64H

- * Tint Real data mapping
0 : Step -50
:
64 : Step 50

● Transmission / Receiving Protocol

11. Sharpness(Command : k) (Video only)

- ▶ To adjust the screen Sharpness.
You can also adjust the sharpness in the Picture menu.

Transmission

```
[k][k][ ][Set ID][ ][Data][Cr]
```

Data Min : 00H ~ Max : 64H
(Hexadecimal code)

- Refer to 'Real data mapping' page A7.

Acknowledgement

```
[k][ ][Set ID][ ][OK][Data][x]
```

Data Min : 00H ~ Max : 64H

12. OSD Select(Command : l)

- ▶ To control OSD on/off to the set.

Transmission

```
[k][l][ ][Set ID][ ][Data][Cr]
```

Data 0 : OSD Off 1 : OSD On

Acknowledgement

```
[l][ ][Set ID][ ][OK][Data][x]
```

Data 0 : OSD Off 1 : OSD On

13. Remote Lock /Key Lock (Command : m)

- ▶ To control Remote Lock on/off to the set.
This function, when controlling RS-232C, locks the remote control and the local keys.

Transmission

```
[k][m][ ][Set ID][ ][Data][Cr]
```

Data 0 : Off 1 : On

Acknowledgement

```
[m][ ][Set ID][ ][OK][Data][x]
```

Data 0 : Off 1 : On

● Transmission / Receiving Protocol

14 Balance(Command : t)

▶ To adjust the sound balance.

Transmission

```
[k][t][ ][Set ID][ ][Data][Cr]
```

Data Min : 00H ~ Max : 64H
(Hexadecimal code)

- Refer to 'Real data mapping' page A7.

Acknowledgement

```
[t][ ][Set ID][ ][OK][Data][x]
```

Data Min : 00H ~ Max : 64H
* Balance : L50 ~ R50

15. Color Temperature (Command : u)

▶ To adjust the screen color temperature.

Transmission

```
[k][u][ ][Set ID][ ][Data][Cr]
```

Data 0 : Medium
1 : Cool
2 : Warm
3 : User

Acknowledgement

```
[u][ ][Set ID][ ][OK][Data][x]
```

Data 0 : Medium
1 : Cool
2 : Warm
3 : User

- Running the Color Temperature command changes the Picture Mode settings to User1.

● Transmission / Receiving Protocol

16. Abnormal state (Command : z)

▶ Abnormal State : Used to Read the power off status when Stand-by mode.

Transmission

```
[k][z][ ][Set ID][ ][Data][Cr]
```

Data FF : Read

- 0 : Normal (Power on and signal exist)
- 1 : No signal (Power on)
- 2 : Turn the monitor off by remote control
- 3 : Turn the monitor off by sleep time function
- 4 : Turn the monitor off by RS-232C function
- 8 : Turn the monitor off by off time function
- 9 : Turn the monitor off by auto off function

Acknowledgement

```
[z][ ][Set ID][ ][OK][Data][x]
```

17. ISM mode(Command: j p)

▶ Used to select the afterimage preventing function.

Transmission

```
[j][p][ ][Set ID][ ][Data][Cr]
```

- Data 1H : Inversion
 2H : Orbiter
 4H : White Wash
 8H : Normal
 10H : Dot Wash

Acknowledgement

```
[p][ ][Set ID][ ][OK][Data][x]
```

 Transmission / Receiving Protocol**18. Auto Configure(Command: j u)**

- ▶ To adjust picture position and minimize image shaking automatically. it works only in RGB(PC) mode.

Transmission

```
[j][u][ ][Set ID][ ][Data][Cr]
```

Data 1 : To set

Acknowledgement

```
[u][ ][Set ID][ ][OK][Data][x]
```

19. Key(Command : m c)

- ▶ To send IR remote key code.

Transmission

```
[m][c][ ][Set ID][ ][Data][Cr]
```

Data Key code : Refer to page A18.

Acknowledgement

```
[c][ ][Set ID][ ][OK][Data][x]
```

● Transmission / Receiving Protocol

20. Tile Mode(Command : d d)

▶ Change a Tile Mode.

Transmission

[d][d][Set ID][Data][x]

Data	Description
00	Tile mode is off.
12	1 x 2 mode(column x row)
13	1 x 3 mode
14	1 x 4 mode
...	...
55	5 x 5 mode

* The data can not be set to 0X or X0 except 00.

Acknowledgement

[d][00][OK/NG][Data][x]

 Transmission / Receiving Protocol**21. Tile H Position(Command : d e)**

▶To set the Horizontal position.

Transmission

```
[d][e][Set ID][Data][x]
```

Data Min : 00H ~ Max : 64H

Acknowledgement

```
[e][Set ID][OK/NG][Data][x]
```

22. Tile V Position(Command : d f)

▶To set the Vertical position.

Transmission

```
[d][f][Set ID][Data][x]
```

Data Min : 00H ~ Max : 64H

Acknowledgement

```
[f][Set ID][OK/NG][Data][x]
```

 Transmission / Receiving Protocol**23. Tile H Size(Command : d g)**

▶ To set the Horizontal size.

Transmission

```
[d][g][Set ID][Data][x]
```

Data Min : 00H ~ Max : 64H

Acknowledgement

```
[g][Set ID][OK/NG][Data][x]
```

24. Tile V Size(Command : d h)

▶ To set the Vertical size.

Transmission

```
[d][h][Set ID][Data][x]
```

Data Min : 00H ~ Max : 64H

Acknowledgement

```
[h][Set ID][OK/NG][Data][x]
```

● Transmission / Receiving Protocol

25. Tile ID Set(Command : d i)

▶ To assign the Tile ID for Tiling function .

Transmission

```
[d][i][Set ID][Data][x]
```

Data Min : 00H ~ Max : 19H
(Hexadecimal code)

Acknowledgement

```
[i][Set ID][OK/NG][Data][x]
```

26 Natural Mode (In Tilemode) (Command : d j)

▶ To assign the Tile Natural mode for Tiling function .

Transmission

```
[d][j][Set ID][Data][x]
```

Data 0 : Natural Off
1 : Natural On
ff : Read Status

Acknowledgement

```
[j][Set ID][OK/NG][Data][x]
```

27. Picture Mode (Command : d x)

▶ To adjust the picture mode.

Transmission

```
[d][x][Set ID][Data][x]
```

Data Structure

Data(Hex)	INPUT
00	Vivid
01	Standard
02	Cinema
03	Spot
04	Game
05	User1
06	User2

Acknowledgement

```
[x][Set ID][OK/NG][Data][x]
```

● Transmission / Receiving Protocol

28. Sound Mode (Command : d y)

▶ To adjust the Sound mode.

Transmission

```
[d][y][Set ID][Data][x]
```

Data Structure

Data(Hex)	INPUT
00	Clear Voice
01	Standard
02	Music
03	Cinema
04	sport
05	Game
06	User

Acknowledgement

```
[y][Set ID][OK/NG][Data][x]
```

29. Fan Fault check (Command : d w)

▶ To check the Fan fault of the TV.

Transmission

```
[d][w][Set ID][Data][x]
```

* The data is always ff(in Hex).

Data ff: Tead Status

Acknowledgement

```
[w][Set ID][OK/NG][Data][x]
```

* Data is the status value of the Fan fault.

Data 0: Fan fault

1: Fan OK

● Transmission / Receiving Protocol

30. Elapsed time return(Command : d l)

▶ To read the elapsed time.

Transmission

```
[d][l][Set ID][Data][x]
```

* The data is always FF(in Hex).

Acknowledgement

```
[l][Set ID][OK/NG][Data][x]
```

* The data means used hours.
(Hexadecimal code)

31. Temperature value (Command : d n)

▶ To read the inside temperature value.

Transmission

```
[d][n][Set ID][Data][x]
```

* The data is always FF(in Hex).

Acknowledgement

```
[n][Set ID][OK/NG][Data][x]
```

* The data is 1 byte long in Hexadecimal.

32. Lamp fault Check(Command : d p)

▶ To check lamp fault.

Transmission

```
[d][p][Set ID][Data][x]
```

* The data is always FF(in Hex).

Acknowledgement

```
[p][Set ID][OK/NG][Data][x]
```

Data 0 : Lamp Fault

1: Lamp OK

 Transmission / Receiving Protocol**33. Auto volume (Command : d u)**

- ▶ Automatically adjust the volume level.

Transmission

[d][u][Set ID][Data][x]

Data 0 : Off
1 : On

Acknowledgement

[u][Set ID][OK/NG][Data][x]

34. Speaker (Command : d v)

- ▶ Turn the speaker on or off.

Transmission

[d][v][Set ID][Data][x]

Data 0 : Off
1 : On

Acknowledgement

[v][Set ID][OK/NG][Data][x]

 Transmission / Receiving Protocol**35. Time (Command : f a)**

▶ Set the current time.

Transmission

```
[f][a][Set ID][Data1][Data2][Data3][Cr]
```

[Data1]

0 : Monday
1 : Tuesday
2 : Wednesday
3 : Thursday
4 : Friday
5 : Saturday
6 : Sunday

[Data2]

0H~17H (Hours)

[Data3]

00H~3BH (Minutes)

Acknowledgement

```
[a][Set ID][OK/NG][Data1][Data2][Data3][x]
```

*When reading data, FFH is inputted for [Data1], [Data2] and [Data3].
In other cases, all are treated as NG.

● Transmission / Receiving Protocol

36. On Timer (On/Off Timer) On, Off (Command : F b)

▶ Set days for On Timer.

Transmission

```
[f][b][Set ID][Data1][Data2][Cr]
```

[Data1]

0 (Write), FFH(Read)

[Data2]

00H~FFH

bit0 : Monday On Timer On(1), Off(0)

bit1 : Tuesday On Timer On(1), Off(0)

bit2 : Wednesday On Timer On(1), Off(0)

bit3 : Thursday On Timer On(1), Off(0)

bit4 : Friday On Timer On(1), Off(0)

bit5 : Saturday On Timer On(1), Off(0)

bit6 : Sunday On Timer On(1), Off(0)

bit7 : Everyday On Timer On(1), Off(0)

Acknowledgement

```
[b][Set ID][OK/NG][Data1][Data2][x]
```

37. Off Timer (On/Off Timer) On, Off (Command : f c)

▶ Set days for Off Timer.

Transmission

```
[f][c][Set ID][Data1][Data2][Cr]
```

[Data1]

0 (Write), FFH(Read)

[Data2]

00H~FFH

bit0 : Monday Off Timer On(1), Off(0)

bit1 : Tuesday Off Timer On(1), Off(0)

bit2 : Wednesday Off Timer On(1), Off(0)

bit3 : Thursday Off Timer On(1), Off(0)

bit4 : Friday Off Timer On(1), Off(0)

bit5 : Saturday Off Timer On(1), Off(0)

bit6 : Sunday Off Timer On(1), Off(0)

bit7 : Everyday Off Timer On(1), Off(0)

Acknowledgement

```
[c][Set ID][OK/NG][Data1][Data2][x]
```

 Transmission / Receiving Protocol**38. On Timer (On/Off Timer) Time (Command : f d)**

▶ Set On Timer.

Transmission

[f][d][Set ID][Data1][Data2][Data3][Cr]

[Data1]

0 : Monday

1 : Tuesday

2 : Wednesday

3 : Thursday

4 : Friday

5 : Saturday

6 : Sunday

7 : Everyday

[Data2]

00H~17H (Hours)

[Data3]

00H~3BH (Minutes)

Acknowledgement

[d][Set ID][OK/NG][Data1][Data2][Data3][x]
--

*When reading data, FFH is inputted for [Data2], [Data3].
In other cases, all are treated as NG.

 Transmission / Receiving Protocol**39. Off Timer (On/Off Timer) Time (Command : f e)**

▶ Set Off Timer.

Transmission

[f][e][Set ID][Data1][Data2][Data3][Cr]

[Data1]

0 : Monday

1 : Tuesday

2 : Wednesday

3 : Thursday

4 : Friday

5 : Saturday

6 : Sunday

7 : Everyday

[Data2]

00H~17H (Hours)

[Data3]

00H~3BH (Minutes)

Acknowledgement

[e][Set ID][OK/NG][Data1][Data2][Data3][x]
--

*When reading data, FFH is inputted for [Data2], [Data3].
In other cases, all are treated as NG.

 Transmission / Receiving Protocol**40. Sleep Time (Command : f f)**

▶ Set Sleep Time.

Transmission

[f][f][Set ID][Data][Cr]

Data

0 : Off

1 : 10

2 : 20

3 : 30

4 : 60

5 : 90

6 : 120

7 : 180

8 : 240

(Orderly)

Acknowledgement

[f][Set ID][OK/NG][Data][x]

41. Auto Sleep (Command : f g)

▶ Set Auto Sleep.

Transmission

[f][g][Set ID][Data][Cr]

Data 0 : Off

1 : On

Acknowledgement

[g][Set ID][OK/NG][Data][x]

 Transmission / Receiving Protocol**42. Power On Delay (Command : f h)**

▶ Set the schedule delay when the power is turned on (Unit: second).

Transmission

```
[f][h][Set ID][Data][Cr]
```

Data : 00H ~ 64H (Data value)

Acknowledgement

```
[h][Set ID][OK/NG][Data][x]
```

43. Language (Command : f i)

▶ Set the OSD language.

Transmission

```
[f][i][Set ID][Data][Cr]
```

Data

- 0 : English
- 1 : France
- 2 : Deutch
- 3 : Spanish
- 4 : Italian
- 5 : Portugues
- 6 : Chinese
- 7 : Japanese
- 8 : Korean
- 9 : Russian

Acknowledgement

```
[i][Set ID][OK/NG][Data][x]
```

 Transmission / Receiving Protocol**44. DPM Select (Command : f j)**

▶ Set the DPM (Display Power Management) function.

Transmission

```
[f][j][Set ID][Data][Cr]
```

Data 0 : Off
1 : On

Acknowledgement

```
[j][Set ID][OK/NG][Data][x]
```

45. Reset (Command : f k)

▶ Execute the Picture, Screen and Factory Reset functions.

Transmission

```
[f][k][Set ID][Data][Cr]
```

Data
0 : Picture Reset
1 : Screen Reset
2 : Factory Reset

Acknowledgement

```
[k][Set ID][OK/NG][Data][x]
```

● Transmission / Receiving Protocol

46. Power saving(Command : f l)

▶ To set the Power saving mode.

Transmission

```
[f][l][Set ID][Data][Cr]
```

Data 0 : Off

- 1: (static level 1)
- 2: (static level 2)
- 3: (static level 3)

Acknowledgement

```
[l][Set ID][OK/NG][Data][x]
```

47. Power Indicator (Command : f o)

▶ To set the LED for Power Indicator

Transmission

```
[f][o][Set ID][Data][Cr]
```

Data 0 : Off

- 1: On

Acknowledgement

```
[o][Set ID][OK/NG][Data][x]
```

48. H Position (Command : f q)

▶ To set the Horizontal position

Transmission

```
[f][q][Set ID][Data][Cr]
```

* The data range is from 00 to 64(in Hex)

Acknowledgement

```
[q][Set ID][OK/NG][Data][x]
```

 Transmission / Receiving Protocol**49. V Position (Command : f r)**

▶ To set the Horizontal position

Transmission

```
[f][r][Set ID][Data][Cr]
```

* The data range is from 00 to 64(in Hex)

Acknowledgement

```
[r][Set ID][OK/NG][Data][x]
```

50. H Size (Command : f s)

▶ To set the Horizontal size.

Transmission

```
[f][s][Set ID][Data][Cr]
```

* The data range is from 00 to 64(in Hex)

Acknowledgement

```
[s][Set ID][OK/NG][Data][x]
```

51. V Size (Command : f t)

▶ To set the Vertical size

Transmission

```
[f][t][Set ID][Data][Cr]
```

* The data range is from 00 to 64(in Hex)

Acknowledgement

```
[t][Set ID][OK/NG][Data][x]
```

 Transmission / Receiving Protocol
52. Scheduling Input select (Command : f u) (Main Picture Input)

▶ To select input source for TV depending on day.

Transmission

```
[f][u][Set ID][Data1][Data2][Cr]
```

Data 1 Structure

Min: 0~Max:7(0:Monday, 1: Tuesday, 2: Wednesday, 3: Tgursday, 4: Saturday, 6: Sunday, 7: Everyday)

Data 2 Structure

Data(Hex)	INPUT
02	AV
04	Component
07	RGB-PC
08	HDMI/DVI-DTV
09	HDMIDVI-PC
FE	No change

Acknowledgement

```
[u][Set ID][OK/NG][Data 1][Data 2][x]
```

53. Serial no.Check (Command : f y)

▶ To read the serial numbers

Transmission

```
[f][y][Set ID][Data][Cr]
```

Data FF (to read the serial numbers)

Acknowledgement

```
[y][Set ID][OK/NG][Data1] ~ [Data2] [x]
```

 Transmission / Receiving Protocol
54. S/W Version (Command : f z)

- ▶ Check the software version.

Transmission

```
[f][z][ ][Set ID][ ][Data][Cr]
```

Data FFH : Read

Acknowledgement

```
[z][ ][Set ID][ ][OK/NG][Data][x]
```

55. Input Select (Command : x b)

- ▶ To select input source for the Set.

Transmission

```
[x][b][ ][Set ID][ ][Data][Cr]
```

Data 20H : AV
 40H : Component
 60H : RGB (PC)
 90H : HDMI/DVI (DTV)
 A0H : HDMI/DVI (PC)

Acknowledgement

```
[b][ ][Set ID][ ][OK][Data][x]
```

Data 20H : AV
 40H : Component
 60H : RGB (PC)
 90H : HDMI/DVI (DTV)
 A0H : HDMI/DVI (PC)

How to connect

- ▶ Connect your wired remote control to Remote Control port on the Product.

Remote Control IR Code

▶ Output waveform

single pulse, modulated with 37.917KHz signal at 455KHz

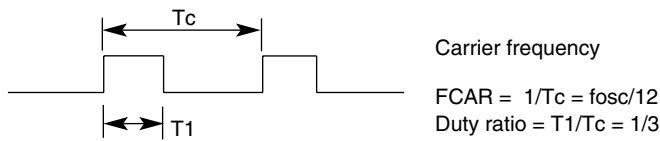

▶ Configuration of frame

- 1st frame

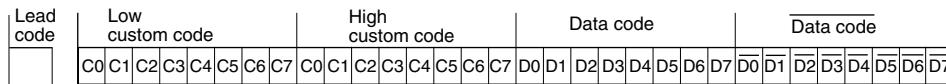

- Repeat frame

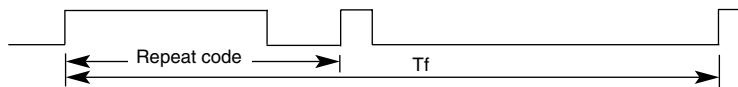

▶ Lead code

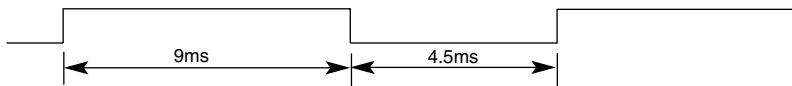

▶ Repeat code

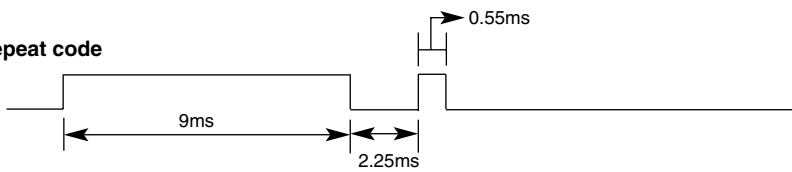

▶ Bit description

- Bit "0"

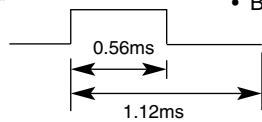

- Bit "1"

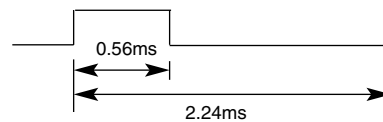

▶ Frame interval : Tf

- The waveform is transmitted as long as a key is depressed.

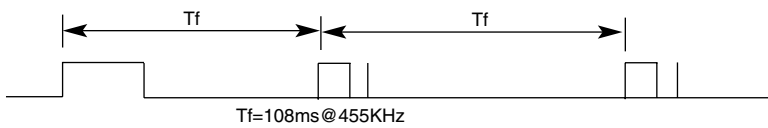

Code(Hexa)	Function	Note
00	▲	R/C Button
01	▼	R/C Button
02	VOL(▶)	R/C Button
03	VOL(◀)	R/C Button
08	POWER ON/OFF	R/C Button (Power On/Off)
C4	POWER ON	Discrete IR Code(Only Power On)
C5	POWER OFF	Discrete IR Code(Only Power On)
09	MUTE	R/C Button
98	AV	R/C Button
0B	INPUT	R/C Button
0E	SLEEP	R/C Button
43	MENU	R/C Button
5B	EXIT	R/C Button
6E	PSM	R/C Button
44	SET	R/C Button
10	Number Key 0	R/C Button
11	Number Key 1	R/C Button
12	Number Key 2	R/C Button
13	Number Key 3	R/C Button
14	Number Key 4	R/C Button
15	Number Key 5	R/C Button
16	Number Key 6	R/C Button
17	Number Key 7	R/C Button
18	Number Key 8	R/C Button
19	Number Key 9	R/C Button
5A	AV	Discrete IR Code(Input AV Selection)
BF	COMPONENT1	Discrete IR Code(Input COMPONENT1 Selection)
D4	COMPONENT2	Discrete IR Code(Input COMPONENT2 Selection)
D5	RGB PC	Discrete IR Code(Input RGB PC Selection)
C6	HDMI/DVI	Discrete IR Code(Input HDMI/DVI Selection)
79	ARC	R/C Button
76	ARC (4:3)	Discrete IR Code(Only 4:3 mode)
77	ARC (16:9)	Discrete IR Code(Only 16:9 mode)
AF	ARC (ZOOM)	Discrete IR Code(Only ZOOM1, ZOOM2 mode)
99	AUTO CONFIC	Discrete IR Code

■■■ Regulatory Information cont.

:: FCC Compliance Statement

This equipment has been tested and found to comply within the limits of a Class B digital device pursuant to Part 15 of the FCC Rules. These limits are designed to provide reasonable protection against harmful interference in a residential installation.

This equipment generates, uses, and can radiate radio frequency energy and if not installed and used in accordance with the instructions, may cause harmful interference to radio communications. However, there is no guarantee that interference will not occur in a particular installation.

If this equipment does cause harmful interference to radio or television reception (which can be determined by turning the equipment on and off), the user is encouraged to try to correct the interference by using one or more of the following measures:

- Reorient or relocate the receiving antenna.
- Increase the separation between the equipment and the receiver.
- Connect the equipment into an outlet on a circuit different from that to which the receiver is connected.
- Consult the dealer or an experienced radio/TV technician for help.

Caution: Changes or modifications not expressly approved by the party responsible for compliance could void the user's (or your) authority to operate the equipment. Only peripherals (digital input/output devices, terminals, printers, etc.) certified to comply with the Class B limits may be attached to this monitor. Operation with non-certified peripherals is likely to result in interference to radio and TV reception. Only shielded signal cables may be used with this System.

NOTICE

The regulations are applied only to the products with the ID LABEL indicating specific requirements.

:: Canadian DOC Notice

This Class B digital apparatus meets all requirements of the Canadian Interference-Causing Equipment Regulations. Cet appareil numérique de la classe B

respecte toutes les exigences du Règlement sur le matériel brouilleur du Canada.

NOTICE

The regulations are applied only to the products with the ID LABEL indicating specific requirements.

:: CE Conformity Notice (for Europe)

Products with the "CE" Marking comply with the EMC Directive(89/336/EEC) and LOW VOLTAGE Directive (73/23/EEC) issued by the Commission of the European Community.

Compliance with these directives implies conformity to the following European Norms :

- EN 55022 ; Radio Frequency Interference
- EN 55024 ; Electromagnetic Immunity
- EN 61000-3-2 ; Power Line Harmonics
- EN 61000-3-3 ; Voltage Fluctuations
- EN 60950-1 ; Product Safety

NOTICE

The regulations are applied only to the products with the ID LABEL indicating specific requirements.

:: Low Radiation Compliance (MPR II)

This monitor meets one of the strictest guidelines available today for low radiation emissions, offering the user extra shielding and an antistatic screen coating. These guidelines, set forth by a government agency in Sweden, limit the amount of emission allowed in the Extremely Low Frequency (ELF) and Very Low Frequency (VLF) electromagnetic range.

:: TCO'99 (TCO'99 applied model only)



Congratulations!

You have just purchased a TCO'99 approved and labelled product! Your choice has provided you with a product developed for professional use. Your purchase has also contributed to reducing the burden on the environment and also to the further development of environmentally adapted electronics products.

■■■ Regulatory Information cont.

Why do we have environmentally labelled computers?

In many countries, environmental labelling has become an established method for encouraging the adaptation of goods and services to the environment. With the growing manufacture and usage of electronic equipment throughout the world, there is a recognized concern for the materials and substances used by electronic products with regards to their eventual recycling and disposal. By proper selection of these materials and substances, the impact on the environment can be minimized.

There are also other characteristics of a computer, such as energy consumption levels, that are important from the viewpoints of both the work (internal) and natural (external) environments. Electronic equipment in offices is often left running continuously, resulting in unnecessary consumption of large amounts of energy and additional power generation. From the standpoint of carbon dioxide emissions alone, it is vital to save energy.

What does labelling involve?

The product meets the requirements for the TCO'99 scheme which provides for international and environmental labelling of personal computers and/or displays.

The labelling scheme was developed as a joint effort by the TCO (The Swedish Confederation of Professional Employees), Svenska Naturskyddsforeningen (The Swedish Society for Nature Conservation) and Statens Energimyndighet (The Swedish National Energy Administration).

Approval requirements cover a wide range of issues: ecology, ergonomics, emission of electrical and magnetical fields, energy consumption and electrical safety.

Ecological criteria impose restrictions on the presence and use of heavy metals, brominated and chlorinated flame retardants, and other substances. The product must be prepared for recycling and the manufacturing site(s) shall be certified according to ISO14001 or EMAS registered.

Energy requirements include a demand that the system unit and/or display, after a certain period of inactivity, shall reduce its power consumption to a lower level in one or more stages. The length of time to reactivate the system unit shall be reasonable for the user.

Labelled products must meet strict environmental demands, for example, in respect of the reduction of electrical and magnetical fields as well as work load and

visual ergonomics.

Below you will find a brief summary of the ecological requirements met by this product. The complete ecological criteria document can be found at TCO Development's website <http://www.tcodevelopment.com> or may be ordered from:

TCO Development

SE-114 94 STOCKHOLM, Sweden

Fax: +46 8 782 92 07

Email : development@tco.se

Information regarding TCO'99 approved and labelled products may also be obtained at <http://www.tcodevelopment.com>

Ecological requirements

Flame retardants

Flame retardants may be present in printed wiring board laminates, cables, and housings. Their purpose is to prevent, or at least to delay the spread of fire. Up to 30% by weight of the plastic in a computer casing can consist of flame retardant substances. Many flame retardants contain bromine or chlorine, and these flame retardants are chemically related to PCBs (polychlorinated biphenyls). Both the flame retardants containing bromine or chlorine and the PCBs are suspected of giving rise to health effects, including reproductive damage in fish-eating birds and mammals, due to the bio-accumulative* processes when not disposed of in accordance with strict standards for disposal.

TCO'99 requires that plastic components weighing more than 25 grams shall not contain flame retardants with organically bound bromine or chlorine. Flame retardants are allowed in the printed wiring board laminates due to the lack of commercially available alternatives.

Cadmium**

Cadmium is present in rechargeable batteries and in the colour-generating layers of certain computer displays. TCO'99 requires that batteries, the colour-generating layers of display screens, and the electrical or electronics components shall not contain any cadmium.

Mercury**

Mercury is sometimes found in batteries, relays and switches. TCO'99 requires that batteries shall not contain any mercury. It also demands that mercury is not present in any of the electrical or electronics components associated with the labelled unit. There is however one

■■■ Regulatory Information cont.

exception. Mercury is, for the time being, permitted in the back light system of flat panel monitors as there today is no commercially available alternative. TCO aims on removing this exception when a mercury free alternative is available.

Lead**

Lead can be found in picture tubes, display screens, solders and capacitors. TCO'99 permits the use of lead due to the lack of commercially available alternatives, but in future requirements TCO Development aims at restricting the use of lead.

* **Bio-accumulative is defined as substances which accumulate in living organisms.**

** **Lead, Cadmium and Mercury are heavy metals which are bio-accumulative.**

:: TCO'03 (TCO'03 applied model only)



Congratulations!

The display you have just purchased carries the TCO'03 Displays label.

This means that your display is designed, manufactured and tested according to some of the strictest quality and environmental requirements in the world. This makes for a high performance product, designed with the user in focus that also minimizes the impact on our natural environment. Some of the features of the TCO'03 Display requirements:

Ergonomics

- Good visual ergonomics and image quality in order to improve the working environment for the user and to reduce sight and strain problems. Important parameters are luminance, contrast, resolution, reflectance, colour rendition and image stability.

Energy

- Energy-saving mode after a certain time – beneficial both for the user and the environment
- Electrical safety

Emissions

- Electromagnetic fields

- Noise emissions

Ecology

- The product must be prepared for recycling and the manufacturer must have a certified environmental management system such as EMAS or ISO 14 001
- Restrictions on
 - chlorinated and brominated flame retardants and polymers
 - heavy metals such as cadmium, mercury and lead.

The requirements included in this label have been developed by TCO Development in co-operation with scientists, experts, users as well as manufacturers all over the world. Since the end of the 1980s TCO has been involved in influencing the development of IT equipment in a more user-friendly direction. Our labelling system started with displays in 1992 and is now requested by users and IT-manufacturers all over the world.

For more information, please visit
www.tcodevelopment.com

English

Information for Environmental Preservation

LGE. announced the 'LG Declaration for a Cleaner Environment' in 1994, and this ideal has served as a guiding managerial principle ever since. The Declaration is a foundation that has allowed us to undertake environmentally friendly activities in careful consideration of economic, environmental, and social aspects.

We promote activities for environmental preservation, and we specifically develop our products to embrace the concept of environment-friendly.

We minimize the hazardous materials contained in our products. For example, there is no cadmium to be found in our monitors.

Information for recycling

This monitor may contain parts which could be hazardous to the environment. It is important that this monitor be recycled after use.

LGE. handles all waste monitors through an environmentally acceptable recycling method. There are several take-back and recycling systems currently in

■■■ Regulatory Information cont.

operation worldwide. Many parts will be reused and recycled, while harmful substances and heavy metals are treated by an environmentally friendly method.

If you want to find out more information about our recycling program, please contact your local LG vendor or a corporate representative of LG.

We set our vision and policies on a cleaner world by selecting the issue of the global environment as a task for corporate improvement. Please visit our website for more information about our 'green' policies.

<http://www.lge.com/about/environment/html/Recycling.jsp>

■ ■ ■ Deutsch

Informationen zur Erhaltung der Umwelt

Im Jahr 1994 verkündete LGE die 'LG Declaration for a Cleaner Environment' (LG Erklärung für eine sauberere Umwelt). Seitdem dient dieses Ideal als führendes Prinzip des Unternehmens. Diese Erklärung war die Basis für die Durchführung von

umweltfreundlichen Aktivitäten, wobei wirtschaftliche, umweltbezogene und soziale Aspekte in die Überlegungen mit einbezogen wurden.

Wir fördern Aktivitäten zum Schutz der Umwelt und die Entwicklung unserer Produkte ist darauf ausgerichtet, unserem Konzept bezüglich Umweltfreundlichkeit gerecht zu werden.

Wir sind darauf bedacht, den Anteil der in unseren Produkten enthaltenen schädlichen Materialien zu minimieren. So ist in unseren Monitoren beispielsweise kein Kadmium zu finden.

Informationen zum Thema Recycling

Dieser Monitor enthält Teile, die umweltschädlich sein können. Es ist unbedingt erforderlich, dass der Monitor recycelt wird, nachdem er außer Dienst gestellt wurde.

Bei LGE werden alle ausrangierten Monitore in einem unter umweltbezogenen Aspekten geeigneten Verfahren recycelt. Augenblicklich sind weltweit mehrere Rücknahme- und Recyclingsysteme im Einsatz. Viele Teile werden wieder verwendet und recycelt. Schädliche Substanzen und Schwermetalle werden durch umweltverträgliche Verfahren behandelt.

Falls Sie mehr über unser Recyclingprogramm erfahren möchten, wenden Sie sich bitte an Ihren lokalen LG-Händler oder einen Unternehmensvertreter von LG.

Wir richten unsere Firmenpolitik auf eine sauberere Umwelt hin aus, indem wir umweltspezifische Aspekte als wichtigen Punkt in die Weiterentwicklung unseres Unternehmens einfließen lassen. Zusätzliche Informationen über unsere 'grüne' Firmenpolitik erhalten Sie auf unserer Website.

<http://www.lge.com/about/environment/html/Recycling.jsp>

■ ■ ■ Français

Information sur la protection de l'environnement

LGE a publié sa 'Déclaration en faveur d'un environnement plus propre' en 1994 et celle-ci est restée, depuis lors, un principe directeur de notre entreprise. Cette déclaration a servi de base à notre réflexion et nous a permis de prendre en compte à la fois les aspects économiques et sociaux de nos activités, tout en respectant l'environnement.

Nous encourageons les activités en faveur de la préservation de l'environnement et c'est dans cet esprit que nous développons nos produits : nous réduisons au minimum les matières dangereuses qui entrent dans leur composition et l'on ne trouve pas de cadmium, par exemple, dans nos moniteurs.

Information sur le recyclage

Ce moniteur peut contenir des composants qui présentent un risque pour l'environnement. Il est donc important que celui-ci soit recyclé après usage.

LGE traite les moniteurs en fin de cycle conformément à une méthode de recyclage respectueuse de l'environnement. Nous reprenons nos produits et les recyclons dans plusieurs sites répartis dans le monde entier. De nombreux composants sont réutilisés et recyclés, et les matières dangereuses, ainsi que les métaux lourds, sont traités selon un procédé écologique.

Si vous souhaitez plus de renseignements sur notre programme de recyclage, veuillez contacter votre revendeur LG ou un l'un de nos représentants.

Nous voulons agir pour un monde plus propre et croyons au rôle de notre entreprise dans l'amélioration de l'environnement. Pour plus de renseignements sur notre politique "verte", rendez visite à notre site :

<http://www.lge.com/about/environment/html/Recycling.jsp>

Regulatory Information cont.

Italiano

Informazioni per la tutela dell'ambiente

La LGE. ha annunciato nel 1994 la cosiddetta 'LG Declaration for a Cleaner Environment' (Dichiarazione di LG a favore di un ambiente più pulito), un ideale che da allora funge da principio ispiratore della gestione aziendale. La dichiarazione rappresenta il fondamento che consente di intraprendere attività a favore dell'ambiente tenendo conto degli aspetti economici, ambientali e sociali. Noi della LG, promuoviamo attività a favore della tutela dell'ambiente sviluppando appositamente i nostri prodotti per cogliere il concetto del rispetto dell'ambiente riducendo i materiali dannosi presenti nei nostri prodotti. Ad esempio nei nostri monitor non è presente il cadmio.

Informazioni per il riciclaggio

Il monitor può presentare componenti che potrebbero risultare eventualmente dannosi per l'ambiente. È importante che il monitor sia riciclato al termine del suo utilizzo.

La LGE. gestisce tutti i monitor di rifiuto con un metodo di riciclaggio soddisfacente dal punto di vista ambientale. In tutto il mondo sono attualmente in funzione numerosi sistemi di riciclaggio e recupero. I diversi componenti sono riutilizzati e riciclati, mentre le sostanze dannose e i metalli pesanti vengono trattati con un metodo rispettoso dell'ambiente.

Se si desiderano maggiori informazioni in merito al programma di riciclaggio, è consigliabile rivolgersi al proprio rivenditore LG o ad un rappresentante aziendale della LG.

Noi della LG impostiamo la nostra visione e le nostre politiche a favore di un mondo più pulito ponendo la questione dell'ambiente dal punto di vista globale come una mansione rivolta al miglioramento della nostra azienda. Vi invitiamo a visitare il nostro sito internet per ulteriori informazioni sulla nostra politica "verde".
<http://www.lge.com/about/environment/html/Recycling.jsp>

Espanol

Información para la conservación medioambiental

LGE. presentó la 'Declaración para un entorno más limpio de LG' en 1994 y este ideal ha servido para guiar nuestros principios empresariales desde entonces. La Declaración es la base que nos ha permitido llevar a cabo tareas que

respetan el medio ambiente siempre teniendo en cuenta aspectos sociales, económicos y medioambientales.

Promocionamos actividades orientadas a la conservación del medio ambiente y desarrollamos nuestros productos específicamente para que se ajusten a la filosofía que protege el entorno.

Reducimos al máximo el uso de materiales de riesgo en nuestros productos. Un ejemplo de ello es la ausencia total de cadmio en nuestros monitores.

Información para el reciclaje

Este monitor puede contener piezas que entrañen riesgos medioambientales. Es importante reciclar este monitor después de su utilización.

LGE. trata todos los monitores usados siguiendo un método de reciclaje que no daña al entorno. Contamos con diversos sistemas de recuperación y reciclaje que funcionan a nivel mundial en la actualidad. Es posible reciclar y reutilizar muchas de las piezas, mientras que las sustancias dañinas y los metales pesados se tratan siguiendo un método que no perjudique al medio ambiente. Si desea obtener más información acerca del programa de reciclaje, póngase en contacto con su proveedor local de LG o con un representante empresarial de nuestra marca.

Basamos nuestra visión y nuestras políticas en un mundo más limpio y para ellos optamos por un entorno global como tarea principal de nuestra evolución como empresa. Visite nuestra página Web para obtener más información sobre nuestras políticas ecológicas.

<http://www.lge.com/about/environment/html/Recycling.jsp>

Português

Informações relacionadas à preservação ambiental

A LGE. anunciou a 'LG Declaration for a Cleaner Environment' (Declaração da LG para um ambiente mais limpo) em 1994 e esse ideal tem servido desde então como um princípio administrativo de orientação. A Declaração é a base que nos tem permitido realizar atividades favoráveis ao ambiente com consideração atenta aos aspectos econômicos, ambientais e sociais.

Promovemos atividades de preservação ambiental e desenvolvemos nossos produtos para englobar

■■■ Regulatory Information cont.

especificamente o conceito de favorável ao ambiente.

Reduzimos os materiais perigosos contidos em nossos produtos. Por exemplo, não há cádmio em nossos monitores.

Informações relacionadas à reciclagem

Este monitor pode conter peças que podem representar riscos ao ambiente. É importante que ele seja reciclado após o uso.

A LGE. cuida de todos os monitores descartados através de um método de reciclagem agradável ao ambiente. Há vários sistemas de devolução e reciclagem atualmente em operação no mundo. Muitas peças serão reutilizadas e recicladas e as substâncias nocivas e os metais pesados passarão por tratamento através de um método favorável ao ambiente.

Para obter mais informações sobre nosso programa de reciclagem, entre em contato com seu fornecedor LG local ou com um representante corporativo da LG.

Definimos nossa visão e nossas políticas relacionadas a um mundo mais limpo selecionando a questão do ambiente global como uma tarefa de aprimoramento corporativo. Visite nosso site para obter mais informações sobre nossas políticas de meio ambiente.

<http://www.lge.com/about/environment/html/Recycling.jsp>

■ ■ ■ Nederlands

Informatie met betrekking tot het behoud van het milieu

LGE. publiceerde in 1994 de 'LG Declaration for a Cleaner Environment' (de LG-verklaring met betrekking tot een schoner milieu). Deze verklaring en het ideaal van een schoner milieu fungeren sindsdien als een bestuurlijke leidraad voor onze onderneming. Op basis van deze verklaring ontplooiën wij milieuvriendelijke activiteiten, waarbij er zowel met sociale en economische aspecten, als met milieuaspecten zorgvuldig rekening wordt gehouden.

Wij ondersteunen activiteiten die zijn gericht op het behoud van het milieu en wij houden bij het ontwikkelen onze producten specifiek rekening met de milieuvriendelijkheid van onze producten.

Wij minimaliseren het gebruik van schadelijke stoffen in onze producten. Er wordt bijvoorbeeld geen cadmium verwerkt in onze monitoren.

Informatie met betrekking tot recycling

Deze monitor bevat materialen die schadelijk zouden kunnen zijn voor het milieu. Het is belangrijk dat deze monitor aan het einde van zijn levensduur wordt gerecycled.

LGE. verwerkt alle afvalmonitoren via een milieuvriendelijke recyclingmethode. Hiervoor worden er momenteel wereldwijd verscheidene inname- en recyclingsystemen gehanteerd. Een groot aantal onderdelen wordt opnieuw gebruikt en gerecycled, waarbij schadelijke stoffen en zware metalen volgens een milieuvriendelijke methode worden verwerkt.

Voor meer informatie over ons recyclingprogramma kunt u contact opnemen met uw plaatselijke LG-vertegenwoordiger of een LG-vestiging.

Onze visie en ons beleid met betrekking tot een schonere wereld vloeien voort uit het feit dat wij het milieu hebben aangemerkt als een onderwerp dat speciale aandacht verdient binnen onze onderneming. Bezoek onze website voor meer informatie over ons 'groene' beleid.

<http://www.lge.com/about/environment/html/Recycling.jsp>

■ ■ ■ Russian

Информация по охране окружающей среды

В 1994 году корпорация LGE опубликовала 'Декларацию LG по охране окружающей среды', которая с тех пор служит основным принципом управления. На основе этой декларации мы смогли предпринять действия, обеспечивающие безопасность окружающей среды, уделяя при этом должное внимание экономическим, экологическим и социальным аспектам.

Мы стимулируем деятельность по охране окружающей среды, уделяя особое внимание разработке нашей продукции в соответствии с концепцией экологической безопасности.

Мы сводим к минимуму содержание опасных веществ в нашей продукции. Например, в наших мониторах вы не найдете кадмия.

Информация по утилизации отходов

Этот монитор может содержать компоненты, которые могут нанести ущерб окружающей среде.

■■■ Regulatory Information cont.

Необходимо утилизировать монитор после использования.

Корпорация LGE перерабатывает все бракованные мониторы с помощью экологически приемлемого метода утилизации отходов. По всему миру действуют системы утилизации отходов и возврата использованной продукции. Многие компоненты будут вторично использованы и утилизированы, в то время как вредные вещества и тяжелые металлы будут обработаны с помощью экологически приемлемого метода.

За более подробной информацией по нашей программе утилизации отходов обращайтесь к местному поставщику или представителю корпорации LG.

Мы ориентируемся на обеспечение экологической безопасности, ставя себе целью глобальную защиту окружающей среды. Дополнительную информацию о нашей политике по охране окружающей среды вы можете найти на нашем сайте:
<http://www.lge.com/about/environment/html/Recycling.jsp>

한국어

환경 보존 정보

LG 전자는 1994년 'LG 환경 선언문'을 발표한 후 현재까지 이를 기업 경영의 이념으로 삼아왔습니다. 이 선언문을 바탕으로 LG 전자는 모든 경영 활동에서 경제성뿐만 아니라 환경성 및 사회성을 주요 의사 결정의 기준으로 삼음으로써 지속적으로 환경 친화적인 경영을 전개하고 있습니다.

본사는 보다 활발한 환경 보존 활동과 더불어 환경 친화적 제품 개발에 주력해 왔습니다.

또한 제품에 포함되는 환경 위해 요소를 최소화하는 데에도 노력을 기울이지 않고 있습니다. LG 전자 모니터의 경우 카드를 전혀 사용하지 않는 것에서도 이러한 노력을 알 수 있습니다.

재활용 정보

본 모니터에는 환경에 위해를 주는 부품이 포함되어 있을 수도 있습니다. 따라서 사용이 끝난 모니터는 재활용하는 것이 좋습니다.

폐모니터는 모두 환경 친화적 방식으로 처리됩니다. 현재 세계적으로 운영되고 있는 회수 및 재활용 시스템에는

여러 가지가 있습니다. 대부분의 부품의 경우 재사용 또는 재활용되지만 환경 위해 물질과 중금속은 환경 친화적 방법으로 처리됩니다.

본사의 재활용 프로그램에 대한 자세한 정보는 각 지역의 LG 공급업체나 LG 기업 대표부에 문의하시기 바랍니다.

LG 전자는 기업 개선 정책의 하나로 지구 환경 문제를 채택함으로써 보다 나은 환경을 만들어 나가기 위한 비전과 정책을 수립했습니다. 본사의 친환경 정책에 대한 자세한 정보를 보시려면 아래의 웹 사이트를 방문하십시오.

http://www.lge.co.kr/cckr/about/environ/purity_02.jsp

∴EPA (EPA applied model only)

ENERGY STAR is a set of power-saving guidelines issued by the U.S. Environmental Protection Agency(EPA).



As an ENERGY STAR Partner LGE U. S. A.,Inc. has determined that this product meets the ENERGY STAR guidelines for energy efficiency.

∴NOM MARK (Mexico only)



Regulatory Information cont.

:: WEEE (for Europe)

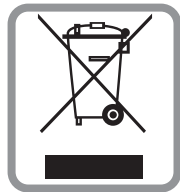

English

Disposal of your old appliance

1. When this crossed-out wheeled bin symbol is attached to a product it means the product is covered by the European Directive 2002/96/EC.
2. All electrical and electronic products should be disposed of separately from the municipal waste stream via designated collection facilities appointed by the government or the local authorities.
3. The correct disposal of your old appliance will help prevent potential negative consequences for the environment and human health.
4. For more detailed information about disposal of your old appliance, please contact your city office, waste disposal service or the shop where you purchased the product.

French

Élimination de votre ancien appareil

1. Ce symbole, représentant une poubelle sur roulettes barrée d'une croix, signifie que le produit est couvert par la directive européenne 2002/96/EC.
2. Les éléments électriques et électroniques doivent être jetés séparément, dans les vide-ordures prévus à cet effet par votre municipalité.
3. Une élimination conforme aux instructions aidera à réduire les conséquences négatives et risques éventuels pour l'environnement et la santé humaine.
4. Pour plus d'information concernant l'élimination de votre ancien appareil, veuillez contacter votre mairie, le service des ordures ménagères ou encore la magasin où vous avez acheté ce produit.

Italian

Smaltimento delle apparecchiature obsolete

1. Quando su un prodotto è riportato il simbolo di

un bidone della spazzatura barrato da una croce significa che il prodotto è coperto dalla direttiva europea 2002/96/EC.

2. Tutti i prodotti elettrici ed elettronici dovrebbero essere smaltiti separatamente rispetto alla raccolta differenziata municipale, mediante impianti di raccolta specifici designati dal governo o dalle autorità locali.
3. Il corretto smaltimento delle apparecchiature obsolete contribuisce a prevenire possibili conseguenze negative sulla salute umana e sull'ambiente.
4. Per informazioni più dettagliate sullo smaltimento delle apparecchiature obsolete, contattare il comune, il servizio di smaltimento rifiuti o il negozio in cui è stato acquistato il prodotto.

Swedish

Kassering av din gamla apparat

1. När den här symbolen med en överkryssad soptunna på hjul sitter på en produkt innebär det att den regleras av European Directive 2002/96/EC.
2. Alla elektriska och elektroniska produkter bör kasseras via andra vägar än de som finns för hushållsavfall, helst via för ändamålet avsedda uppsamlingsanläggningar som myndigheterna utser.
3. Om du kasserar din gamla apparat på rätt sätt så bidrar du till att förhindra negativa konsekvenser för miljön och människors hälsa.
4. Mer detaljerad information om kassering av din gamla apparat kan fås av kommunen, renhållningsverket eller den butik där du köpte produkten.

Dutch

Uw oude toestel wegdoen

1. Als het symbool met de doorgekruiste verrijdbare afvalbak op een product staat, betekent dit dat het product valt onder de Europese Richtlijn 2002/96/EC.
2. Elektrische en elektronische producten mogen niet worden meegegeven met het huishoudelijk afval, maar moeten worden ingeleverd bij speciale inzamelingspunten die door de lokale of landelijke overheid zijn aangewezen.
3. De correcte verwijdering van uw oude toestel helpt negatieve gevolgen voor het milieu en de menselijke gezondheid voorkomen.

Regulatory Information cont.

4. Wilt u meer informatie over de verwijdering van uw oude toestel? Neem dan contact op met uw gemeente, de afvalophaaldienst of de winkel waar u het product hebt gekocht.

Finnish

Vanhonjen laitteiden hävittäminen

1. Tämä merkki tuotteessa tarkoittaa, että tuote kuuluu sähkö- ja elektroniikkalaiteromusta annetun EU-direktiivin 2002/96/EY soveltamisalaan.
2. Kaikki elektroniset laitteet ovat ongelmajätettä, joten ne on toimitettava paikalliseen keräyspisteeseen.
3. Vanhan laitteen asianmukainen hävittäminen ehkäisee mahdollisia ympäristöön ja terveyteen kohdistuvia haittavaikutuksia.
4. Lisätietoa vanhan laitteen hävittämisestä saat ottamalla yhteyden paikallisiin viranomaisiin, kierrätyskeskukseen tai myymälään, josta ostit laitteen.

German

Entsorgung von Altgeräten

1. Wenn dieses Symbol eines durchgestrichenen Abfalleimers auf einem Produkt angebracht ist, unterliegt dieses Produkt der europäischen Richtlinie 2002/96/EC.
2. Alle Elektro- und Elektronik-Altgeräte müssen getrennt vom Hausmüll über dafür staatlich vorgesehenen Stellen entsorgt werden.
3. Mit der ordnungsgemäßen Entsorgung des alten Geräts vermeiden Sie Umweltschäden und eine Gefährdung der persönlichen Gesundheit.
4. Weitere Informationen zur Entsorgung des alten Geräts erhalten Sie bei der Stadtverwaltung, beim Entsorgungsamt oder in dem Geschäft, wo Sie das Produkt erworben haben.

Danish

Sådan smider du dit gamle apparat ud

1. Når der er et tegn med et kryds over en skraldespand, betyder det, at produktet er omfattet af EU-direktiv 2002/96/EC.
2. Alle elektriske og elektroniske produkter skal smides ud et andet sted end gennem den kommunale affaldsordning ved hjælp af specielle indsamlingsfaciliteter, der er organiseret af staten

eller de lokale myndigheder.

3. Korrekt bortskaffelse af dit gamle apparat er med til at forhindre mulige skadevirkninger på miljøet og menneskelig sundhed.
4. Mere detaljerede oplysninger om bortskaffelse af dit gamle apparat kan fås ved at kontakte dit lokale kommunekontor, renovationselskab eller den butik, hvor du købte produktet.

Greek

Απόρριψη της παλιάς σας συσκευής

1. Όταν ένα προϊόν διαθέτει το σύμβολο ενός διαγραμμένου κάλαθου απορριμμάτων, τότε το προϊόν καλύπτεται από την Ευρωπαϊκή Οδηγία 2002/96/ΕΟΚ.
2. Η απόρριψη όλων των ηλεκτρικών και ηλεκτρονικών προϊόντων πρέπει να γίνεται χωριστά από τα γενικά οικιακά απορρίμματα μέσω καθορισμένων εγκαταστάσεων συλλογής απορριμμάτων, οι οποίες έχουν δημιουργηθεί είτε από την κυβέρνηση ή από τις τοπικές αρχές.
3. Η σωστή απόρριψη της παλιάς σας συσκευής θα βοηθήσει στην αποτροπή πιθανών αρνητικών συνπειών ως προς το περιβάλλον και την υγεία του ανθρώπου.
4. Για πιο λεπτομερείς πληροφορίες σχετικά με την απόρριψη της παλιάς σας συσκευής, επικοινωνήστε με το αρμόδιο τοπικό γραφείο, υπηρεσία διάθεσης οικιακών απορριμμάτων ή το μαγαζί από το οποίο αγοράσατε το προϊόν.

Spanish

Cómo deshacerse de aparatos eléctricos y electrónicos viejos

1. Si en un producto aparece el símbolo de un contenedor de basura tachado, significa que éste se acoge a la Directiva 2002/96/CE.
2. Todos los aparatos eléctricos o electrónicos se deben desechar de forma distinta del servicio municipal de recogida de basura, a través de puntos de recogida designados por el gobierno o las autoridades locales.
3. La correcta recogida y tratamiento de los dispositivos inservibles contribuye a evitar riesgos potenciales para el medio ambiente y la salud pública.
4. Para obtener más información sobre cómo deshacerse de sus aparatos eléctricos y electrónicos viejos, póngase en contacto con su ayuntamiento, el servicio de recogida de basuras o el establecimiento donde adquirió el producto.

Regulatory Information cont.

Portuguese

Eliminação do seu antigo aparelho

1. Quando este símbolo de latão cruzado estiver afixado a um produto, significa que o produto é abrangido pela Directiva Europeia 2002/96/EC.
2. Todos os produtos eléctricos e electrónicos devem ser eliminados separadamente do lixo doméstico através de pontos de recolha designados, facilitados pelo governo ou autoridades locais.
3. A eliminação correcta do seu aparelho antigo ajuda a evitar potenciais consequências negativas para o ambiente e para a saúde humana.
4. Para obter informações mais detalhadas acerca da eliminação do seu aparelho antigo, contacte as autoridades locais, um serviço de eliminação de resíduos ou a loja onde comprou o produto.

Slovak

Likvidácia váš ho starého prístroja

1. Keď sa na produkte nachádza tento symbol prečiarknutej smetnej nádoby s kolieskami, znamená to, že daný produkt vyhovuje európskej Smernici č. 2002/96/EC.
2. Všetky elektrické a elektronické produkty by mali byť zlikvidované oddelene od komunálneho odpadu prostredníctvom na to určených zberných zariadení, ktoré boli ustanovené vládou alebo orgánmi miestnej správy.
3. Správnu likvidáciu starých zariadení pomôžete predchádzať potenciálnym negatívnym následkom pre prostredie a ľudské zdravie.
4. Podrobnejšie informácie o likvidácii starých zariadení nájdete na miestnom úrade, v službe na likvidáciu odpadu alebo u predajcu, kde ste tento produkt zakúpili.

Czech

Likvidace starých spotřebičů

1. Pokud je u výrobku uveden symbol pojízdného kontejneru v přeškrtnutém poli, znamená to, že na výrobek se vztahuje směrnice Evropské unie číslo 2002/96/EC.
2. Všechny elektrické a elektronické výrobky by měly být likvidovány odděleně od běžného komunálního odpadu prostřednictvím sběrných zařízení zřízených za tímto účelem vládou nebo místní samosprávou.
3. Správný způsob likvidace starého elektrického spotřebiče pomáhá zamezit možným negativním dopadům na životní prostředí a zdraví.
4. Bližší informace o likvidaci starého spotřebiče získáte u místní samosprávy, ve sběrném zařízení nebo v obchodě, ve kterém jste výrobek zakoupili.

Croatian

Uklanjanje starog aparata

1. Ako se na proizvodu nalazi simbol prekrizhene kante za smeće, to znači da je proizvod pokriven europskom direk-

tivom 2002/96/EC.

2. Električni i elektronski proizvodi ne smiju se odlagati zajedno s komunalnim otpadom, već u posebna odlagališta koja je odredila vlada ili lokalne vlasti.
3. Pravilno odlaganje starog proizvoda sprečiti će potencijalne negativne posljedice po okoliš i zdravlje ljudi.
4. Podrobnije informacije o odlaganju starog proizvoda potražite u gradskom uredu, službi za odlaganje otpada ili u trgovini u kojoj ste kupili proizvod.

Hungarian

Régi eszközök ártalmatlanítása

1. A termékhez csatolt áthúzott, keresek szeméttároló jel jelöli, hogy a termék a 2002/96/EC EU-direktíva hatálya alá esik.
2. Minden elektromos és elektronikai terméket a lakossági hulladéktól elkülönítve kell begyűjteni, a kormány vagy az önkormányzatok által kijelölt begyűjtő eszközök használatával.
3. Régi eszközeinek megfelelő ártalmatlanítása segíthet megelőzni az esetleges egészségre vagy környezetre ártalmas hatásokat.
4. Ha több információra van szüksége régi eszközeinek ártalmatlanításával kapcsolatban, tanulmányozza a vonatkozó környezetvédelmi szabályokat, vagy lépjen kapcsolatba az üzlettel, ahol a terméket vásárolta.

Polish

Utylizacja starych urządzeń

1. Kiedy do produktu dołączony jest niniejszy przekreślony symbol kołowego pojemnika na śmieci, oznacza to, że produkt jest objęty dyrektywą 2002/96/EC.
2. Wszystkie elektryczne i elektroniczne produkty powinny być utylizowane niezależnie od odpadów miejskich, z wykorzystaniem przeznaczonych do tego miejsc składowania wskazanych przez rząd lub miejscowe władze.
3. Właściwy sposób utylizacji starego urządzenia pomoże zapobiec potencjalnie negatywnemu wpływowi na zdrowie i środowisko.
4. Aby uzyskać więcej informacji o sposobach utylizacji starych urządzeń, należy skontaktować się z władzami lokalnymi, przedsiębiorstwem zajmującym się utylizacją odpadów lub sklepem, w którym produkt został kupiony.

■■■ Regulatory Information cont.

■ ■ ■ Estonian

Kasutuskõlbmatu seadme käitlemise kord

1. Kui seade on märgistatud selle elektri- ja elektroonikaseadmete lahuskogumist märgistava tähisega (ratastega prügikonteineri kujutis, millele on rist peale tõmmatud), tuleb toodet käidelda vastavalt Eurodirektiivile 2002/96/EÜ.
2. Elektri- ja elektroonikaseadmeid ei tohi visata tavalise prügi hulka. Nad kuuluvad lahuskogumisele selleks määratud kogumispunktides.
3. Kasutuskõlbmatu tervikseadme käitlemine tavaprügist lahus on korraldatud selleks, et vältida negatiivseid tagajärgi, mida põhjustaksid seadme osade purunemisel vabaneda võivad ohtlikud jäätmed loodusele või inimorganismile.
4. Täpsemat informatsiooni selle kohta, kuhu ja millal saab ära anda oma kasutamiskõlbmatu elektri- ja elektroonikaseadme, küsige kohalikult omavalitsuselt, prügifirmalt või kaupluselt, kust seadme ostsite.

■ ■ ■ Latvian

Vecās elektroierīces nodošana

1. Ja uz produkta ir simbols ar pārsvītrotu atkritumu tvertni, tas nozīmē, ka produkts ir iekļauts Eiropas direktīvā 2002/96/EC.
2. Visi elektriskie un elektroniskie produkti ir jāutilizē, nododot pašvaldības īpaši noteiktās pieņemšanas vietās. Tos nedrīkst izmest parastās municipalitātes atkritumu urnās.
3. Ievērojot prasības veco elektroierīču utilizēšanā, jūs pasargāsi apkārtējo vidi un cilvēku veselību no iespējami nelabvēlīgajām sekām, kādas varētu rasties, ierīcēm sadaloties nepiemērotā vietā.
4. Lai gūtu plašāku informāciju par veco ierīču utilizēšanas iespējām, sazinieties ar pilsētas pašvaldību, atkritumu savākšanas saimniecību vai veikalu, kurā ierīci iegādājāties.

■ ■ ■ Lithuanian

Senos įrangos atliekų tvarkymas

1. Užbrauktas konteinerio simbolis priverčia ant prekės reiškia, kad įrangą saugo Europos direktyva 2002/96/EC.
2. Visos elektros ir elektroninės įrangos atliekos turi būti renkamos atskirai ir neišmetamos į atliekų konteinerį kartu su kitomis komunalinėmis atliekomis, taikant specialią atliekų surinkimo sistemą, patvirtintą vyriausybės ar vietos valdžios.
3. Teisingas senos įrangos atliekų tvarkymas, padės išvengti neigiamų pasekmių aplinkai ir žmonių sveikatai.
4. Dėl išsamesnės informacijos apie senos įrangos tvarkymą, prašome kreiptis į miesto valdžią, atliekų perdirbimo tarnybą arba parduotuvę, kurioje pirkote įrangą.