



Color Monitor

USER GUIDE

StudioWorks 77M



<http://www.lge.co.kr>

AGENCY REGULATORY NOTICE

FCC Compliance Statement

This equipment has been tested and found to comply with the limits for a Class B digital device pursuant to Part 15 of the FCC Rules. These limits are designed to provide reasonable protection against harmful interference in a residential installation.

This equipment generates, uses, and can radiate radio frequency energy and if not installed and used in accordance with the instructions, may cause harmful interference to radio communications. However, there is no guarantee that interference will not occur in a particular installation.

If this equipment does cause harmful interference to radio or television reception (which can be determined by turning the equipment off and on), the user is encouraged to try to correct the interference by using one or more of the following measures:

- Reorient or relocate the receiving antenna.
- Increase the separation between the equipment and the receiver.
- Connect the equipment into an outlet on a circuit different from that to which the receiver is connected.
- Consult the dealer or an experienced radio/TV technician for help.

Caution: Changes or modifications not expressly approved by LG Electronics Inc. for compliance could void the user's (or your) authority to operate the equipment. Only peripherals (digital input/output devices, terminals, printers, etc.) certified to comply with the Class B limits may be attached to this monitor. Operation with non-certified peripherals is likely to result in interference to radio and TV reception.

Only shielded Signal Cables may be used with this System.

**Canadian
D. O. C.
Notice**

This Class B digital apparatus meets all requirements of the Canadian Interference-Causing Equipment Regulations.

Cet appareil numérique de la classe B respecte toutes les exigences du Règlement sur le matériel brouilleur du Canada.

**CE
Conformity
Notice**



Products with the "CE" Marking comply with the EMC Directive(89/336/EEC) and LOW VOLTAGE Directive (73/23/EEC) issued by the Commission of the European Community.

Compliance with these directives implies conformity to the following European Norms :

- EN 55022 ; Radio Frequency Interference
- EN 50082-1:1992 ; Electromagnetic Immunity
- EN 60555-2 ; Power Line Harmonics
- EN 60555-3 ; Voltage Fluctuations
- EN 60950 ; Product Safety

Table of Contents

Introduction	
Features	A1
Monitor Registration	
Notice.....	A2
Trademark Acknowledgments	A2
Important Precautions	
On Safety	A3
On Installation	A4
On Cleaning.....	A4
On Repacking.....	A4
Connecting the monitor	A5
Location and Function of Controls	
Front View	A6
Rear View	A6
Control Panel Function	
Front Panel Controls.....	A7
Left Side Jacks.....	A8
Rear Panel Jacks.....	A8
Microphone Operation	A8
Audio Features.....	A8
On Screen Display (OSD) Control Adjustment	A9
On Screen Display (OSD) Selection and Adjustment	A10
Sound Selection and Adjustment	A14
Video Memory Modes	
Factory Preset Timing Signal Chart	A15
User Modes.....	A15
Recalling Display Modes.....	A15
Energy Saving Design	
Power Consumption.....	A16
MPR II, Self Diagnostics, DDC	
Low Radiation Compliance (MPR II).....	A17
Self Diagnostics	A17
DDC (Display Data Channel)	A17
Troubleshooting Tips and Service	
Troubleshooting	A18
Service	A19
Specifications	
Specifications	A20

Introduction

Thank you for purchasing a high resolution monitor. It will give you high resolution performance and convenient reliable operation in a variety of video operating modes.

Features

- The monitor is a 17 inches (15.9 inches viewable) intelligent, microprocessor based monitor compatible with most analog RGB (Red, Green, Blue) display standards, including IBM PC®, PS/2®, Apple®, Macintosh®, Centris®, Quadra®, and Macintosh II family.
- The monitor provides crisp text and vivid color graphics with VGA, SVGA, XGA, and VESA Ergo modes (non-interlaced), and most Macintosh compatible color video cards when used with the appropriate adaptor. The monitor's wide compatibility makes it possible to upgrade video cards or software without purchasing a new monitor.
- Digitally controlled auto-scanning is done with the microprocessor for horizontal scan frequencies between 30 and 70kHz, and vertical scan frequencies between 50 and 160Hz. The microprocessor-based intelligence allows the monitor to operate in each frequency mode with the precision of a fixed frequency monitor.
- The microprocessor-based digital controls allow you to adjust conveniently a variety of image controls by using the OSD (On Screen Display).
- The monitor has 36 memory locations for display modes, 11 of which are factory preset to popular video modes.
- This monitor is capable of producing a maximum horizontal resolution of 1280 dots and a maximum vertical resolution of 1024 lines. It is well suited for CAD work and sophisticated windowing environments.
- For greater user health and safety, this monitor complies with the stringent Swedish MPR II requirements for low radiation emissions.
- For low cost of monitor operation, this monitor is certified as meeting the EPA Energy Star requirements, and utilizes the VESA Display Power Management Signalling (DPMS) protocol for power saving during non-use periods.

Monitor Registration

The model and serial numbers are found on the rear of this unit. These numbers are unique to this unit and not available to others. You should record requested information here and retain this guide as a permanent record of your purchase. Staple your receipt here.

Date of Purchase : _____
Dealer Purchased From : _____
Dealer Address : _____
Dealer Phone No. : _____
Model No. : _____
Serial No. : _____

Notice

All rights reserved. Reproduction in any manner, in whole or in part, is strictly prohibited without the written permission of LG Electronics Inc.

Trademark Acknowledgments

LG is a trademark of **LG Electronics Inc.**

IBM is a registered trademark and **VGA** is a trademark of International Business Machines Corporation.

Warning : To reduce the risk of fire or electric shock, do not expose this appliance to rain or moisture.

Avertissement : Ne pas placer cet appareil dans un endroit humide. Cela peut entraîner un incendie ou une décharge électrique.

Important Precautions

This unit has been engineered and manufactured to assure your personal safety, but improper use can result in potential electrical shock or fire hazard. In order not to defeat the safeguards incorporated in this monitor, observe the following basic rules for its installation, use, and servicing. Also follow all warnings and instructions marked directly on your monitor.

On Safety

Use only the power cord supplied with the unit. In case you use another power cord, make sure that it is certified by the applicable standards (UL/CSA or VDE) if not being provided by the supplier. If the power cable is faulty in any way, please contact the manufacturer or the nearest authorized repair service provider for a replacement.

Operate the monitor only from a power source indicated in the specifications of this manual or listed on the monitor. If you are not sure what type of power supply you have in your home, consult with your dealer.

Overloaded AC outlets and extension cords are dangerous. So are frayed power cords and broken plugs. They may result in a shock or fire hazard. Call your service technician for replacement.

Do not Open the Monitor

- There are no user serviceable components inside.
 - There are Dangerous High Voltages inside, even when the power is OFF.
 - Contact your dealer if the monitor is not operating properly.
-

To Avoid Personal Injury :

- Do not place the monitor on a sloping shelf unless properly secured.
 - Use only a stand recommended by the manufacturer.
 - Do not try to roll a stand with small casters across thresholds or deep pile carpets.
-

To Prevent Fire or Hazards:

- Always turn the monitor OFF if you leave the room for more than a short period of time. Never leave the monitor ON when leaving the house.
 - Keep children from dropping or pushing objects into the monitor's cabinet openings. Some internal parts carry hazardous voltages.
-

-
- Do not add accessories that have not been designed for this monitor.
 - During a lightning storm or when the monitor is to be left unattended for an extended period of time, unplug it from the wall outlet.
 - Do not bring magnetic devices such as magnets or motors near the picture tube.
-

On Installation

Do not allow anything to rest upon or roll over the power cord, and do not place the monitor where the power cord is subject to damage.

Do not use this monitor near water such as near a bathtub, washbowl, kitchen sink, laundry tub, in a wet basement, or near a swimming pool.

Monitors are provided with ventilation openings in the cabinet to allow the release of heat generated during operation. If these openings are blocked, built-up heat can cause failures which may result in a fire hazard. Therefore, NEVER:

- Block the bottom ventilation slots by placing the monitor on a bed, sofa, rug, etc.
 - Place the monitor in a built-in enclosure unless proper ventilation is provided.
 - Cover the openings with cloth or other material.
 - Place the monitor near or over a radiator or heat source.
-

On Cleaning

- Unplug the monitor before cleaning the face of the picture tube.
 - Use a slightly damp (not wet) cloth. Do not use an aerosol directly on the picture tube because overspray may cause electrical shock.
-

On Repacking

- Do not throw away the carton and packing materials. They make an ideal container in which to transport the unit. When shipping the unit to another location, repack it in its original material.
-

Connecting the monitor

On the back of the monitor are two plug-in connections; one for the AC power cord, and the other for the signal cable from the video card.

- ① Power off both the monitor and PC.
 - ② Connect the 15 pin VGA connector of the supplied signal cable to the output VGA video connector on the PC and the matching input connector on the rear of the monitor. The connectors will mate only one way. If you cannot attach the cable easily, turn the connector upside down and try again. When mated, tighten the thumbscrews to secure the connection.
 - ② Locate the appropriate MAC to VGA adapter block at your local computer store. This adapter changes the high density 3 row 15 pin VGA connector to the correct 15 pin 2 row connection to mate with your MAC. Attach the other end of the signal cable to the side of the adapter block with 3 rows.
- Connect the attached adapter block/signal cable to the video output on your MAC.
- ③ One end of the AC power cord is connected into the AC power connector on the back of the monitor. The other end is plugged into a properly grounded three-prong AC outlet.
 - ④ Power ON the PC, then the monitor.
 - ⑤ If you see the **NO SIGNAL** message, check the signal cable and connectors.
 - ⑥ After using the system, power OFF the monitor, then the PC.

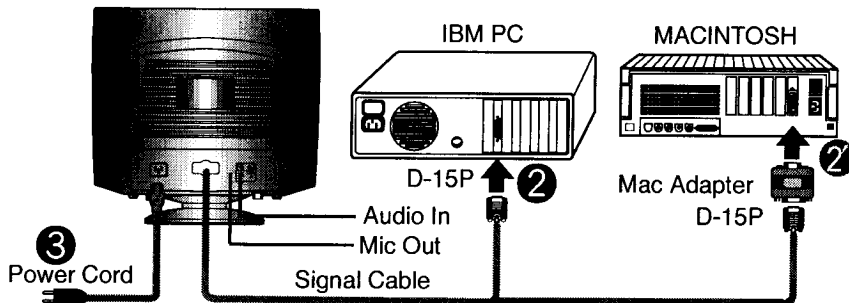
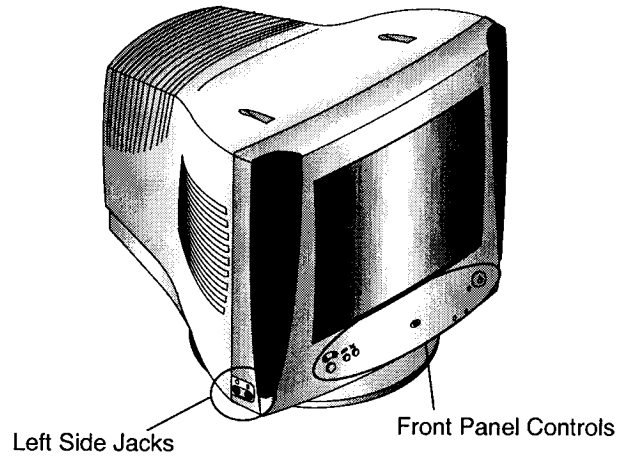

Figure 1.

* NOTE : For Apple Macintosh use, a separate plug adapter is needed to change the 15 pin high density (3 row) D-sub VGA connector on the supplied cable to a 15 pin 2 row connector.

Location and Function of Controls

Front View





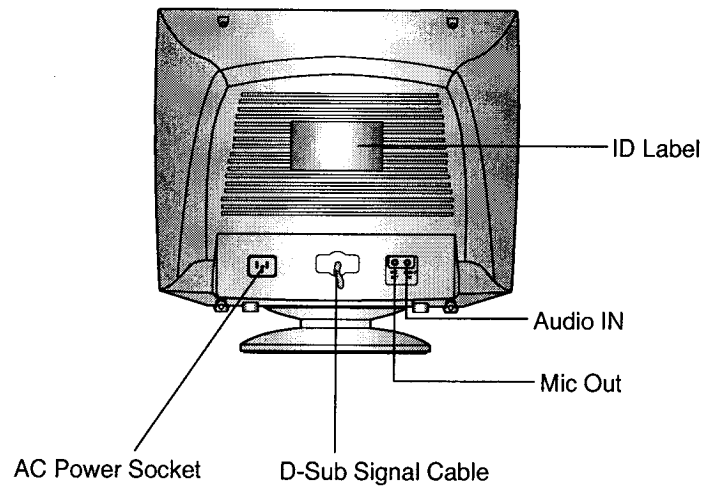





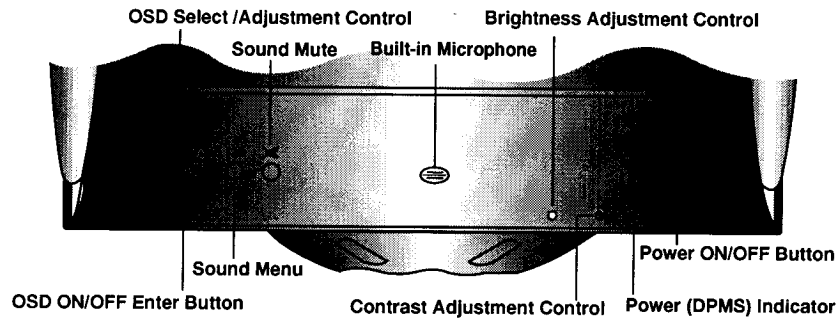

Rear View



Control Panel Function

Front Panel Controls



Control	Function
 OSD Select/Adjustment Control	Use this buttons selecting (highlighting) an OSD icon to be adjusted. It is also used for selecting the level of the selected item to be adjusted.
 OSD ON/OFF Enter Button	Use this button to start/enter and exit from the On Screen Display.
 Sound Menu	To adjust sound menu.
 Sound Mute	Used to select mute on (means sound off) and mute off (means sound on).
 Built-in Microphone	Built-in Microphone.
 Brightness Adjustment Control	Used to adjust the brightness of the screen.
 Contrast Adjustment Control	Adjust the display to the contrast desired.
 Power (DPMS) Indicator	This Indicator lights up green when the monitor operates normally. If the monitor is in DPM (Energy Saving) mode (stand-by/suspend/power off), this indicator color changes to amber.
 Power ON/OFF Button	Use this button to turn the monitor on or off.

Left Side Jacks

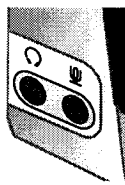
	Headphone Jack 🎧	Headphone Jack that automatically mutes the speaker volume when headphone is attached.
	Microphone Jack 🎤	An external microphone can be used instead of the built-in microphone.

Rear Panel Jacks

	Mic. Out	Connects microphone sound to PC via cable.
	Audio In	Connects speaker sound to PC via cable attachment.

Microphone Operation

On the left side there is a MIC (Microphone) jack. By plugging a microphone in here, it may reduce the long length of cable needed to reach the PC's sound card. In order to use this MIC jack, you need to use a cable (supplied) to plug into the rear of the monitor (MIC OUT) and into the MIC input jack of your sound card (if available).



Audio Features

A major feature of this monitor is its built-in audio system. This conveniently integrates a stereo audio amplifier and speakers without taking up any more space. Because the monitor is designed like this, you can easily upgrade to audio capable multimedia applications by attaching your PC with sound card to the back of this monitor. It will result in significantly less cabling and space requirements.

On Screen Display (OSD) Control Adjustment

Making adjustments to the image size, position, and operating parameters of the monitor is quick and easy with the On Screen Display Control system, using only the ENTER button and Adjustment Control buttons. A quick example is given below to familiarize you with the use of the controls. Following this section is an outline of the available adjustments and selections you can make using the OSD.

Note : (Monitor and PC should be ON, with an image or prompt on the screen). A single press of the ENTER button will present you with the Main Menu of the on screen display system with the first () highlighted.

The main picture area will also show the select icon () and next icon ().

1. The OSD system should look like:

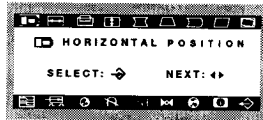

2. To adjust H Position (), Press the enter button once.
The display will look like:

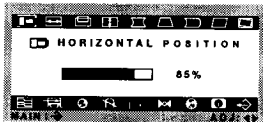











3. You want to move the next icon, Adjust the next button () control.
The display will look like:





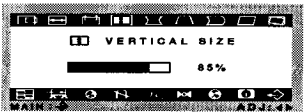

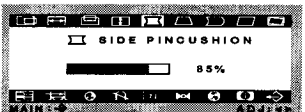

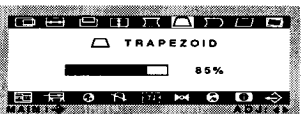

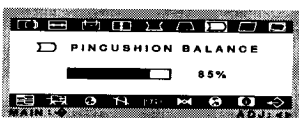

On Screen Display(OSD) Selection and Adjustment

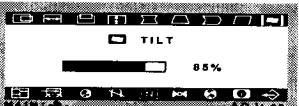
You were introduced to the procedure of selection and adjusting an item using the OSD system.

Listed below are the icons, icon names, and icon descriptions of the items that are shown on the Menu.

OSD Adjust	Description
 Horizontal Position 	To move picture image left and right. ◀ Moves the screen image left. ▶ Moves the screen image right.
 Horizontal Size 	To adjust image width. ◀ Decreases the size of the screen image. ▶ Increases the size of the screen image.
 Vertical Position 	To move image up and down. ◀ Moves the screen image up. ▶ Moves the screen image down.
 Vertical Size 	To adjust image height. ◀ Decreases the size of the screen image. ▶ Increases the size of the screen image.
 Side Pincushion 	To correct the bowing in and out of the image. ◀ Curves the image's edges inwards. ▶ Curves the image's edges outwards.
 Trapezoid 	To correct geometric distortion. ◀ Makes the screen image narrower at the top. ▶ Moves the screen image wider at the top.

OSD Adjust	Description
<p> Side pincushion balance</p> 	<p>To correct the balance of both sides bowling.</p> <ul style="list-style-type: none"> ◀ Curvature of the sides to the right. ▶ Curvature of the sides to the left.
<p> Parallelogram</p> 	<p>This control adjusts for a skewing of the screen image.</p> <ul style="list-style-type: none"> ◀ Tilts the screen image rightward. ▶ Tilts the screen image leftward.
<p> Tilt</p> 	<p>To correct image rotation.</p> <ul style="list-style-type: none"> ◀ Tilts the screen image left. ▶ Tilts the screen image right.
<p> Moire Reduction</p>   	<p>This item allows you to reduce the moire. It is normally OFF. If you want to adjust it, select ON using the adjustment control and push the Enter Button. When you are done, Press the Enter button once to return to More Reduction menu to make another selection. If you have finished using the OSD after you have returned to Moire Reduction menu, you can use the Enter button to EXIT the OSD.</p> <p>NOTE : The screen image may shake slightly while the moire reduction function is ON. Switching the OFF will improve image stability and clarity at the expense of slightly greater moire.</p>
<p> Video Input Level</p> 	<p>This item is used to select the monitor's input signal level. The normal level used for most PC's is 0.7V.</p>

OSD Adjust	Description
------------	-------------

Color Select



To select color temperature 9300K/ 6550K/ USER and CURVE. Select the desired color temperature or select user to set your own color levels.



Allow for specific adjustments to Red, Green and Blue(R/G/B).
 ◀ Decreases the amount of color in the image.
 ▶ Increases the amount of color in the image.



Curve color setting is adjusters at the factory to the display's color temperature. Temperature range is from 6000K to 9950K. So, user easily color set whitout adjustments Red, Green and Blue(R/G/B).

Degauss



Used to demagnetize the picture to give a move accurate image and color.





OSD OSD Control



To correct OSD image's Horizontal position and Vertical position.

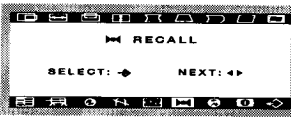

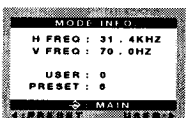

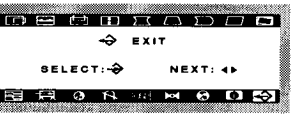







Horizontal position : To move image right and left.
Vertical position : To move image up and down.

OSD Adjust	Description
<p>▶◀ Recall</p> 	<p>If the monitor is operating in a factory preset mode, this control will reset the image to the factory preset mode. If the monitor is operating in a user mode, this control has no effect.</p>
<p>⊗ Language Select</p> 	<p>To choose the language in which the control names are displayed. OSD Menus are available in five language : English, German, French, Spanish and Italian.</p>
<p>ⓘ Mode Information</p>   	<p>This item gives access to 2 elements : Mode, DDC function. The message does not disappear until you click the select key again.</p> <p>MODE To inform users of preset and user mode data.</p> <p>DDC To select the DDC function(ON/OFF).</p>
<p>↔ Exit</p> 	<p>To disappear of the OSD on the screen.</p>

Sound Selection and Adjustment ()

You were introduced to the procedure of selection and adjusting an item using the OSD system.

Listed below are the icons, icon names, and icon descriptions of the items that are shown on the main Menu.

OSD Adjust	Description
<p> Volume</p> 	<p>Raises or lowers audio level.</p>
<p> Treble</p> 	<p>Raises or lowers treble level.</p>
<p> Bass</p> 	<p>Raises or lowers Bass level.</p>
<p> Balance</p> 	<p>Changes balance of left/right speaker level.</p>
<p> Microphone</p> 	<p>Enables or disables microphone usage.</p>

Video Memory Modes

The monitor has 36 memory locations for display modes, 11 of which are factory preset to popular video modes.

Display Modes (Resolution)

Display Modes (Resolution)	Horizontal Frequency (kHz)	Vertical Frequency (kHz)
VGA 640 x 480	37.50	75
VESA 800 x 600	46.88	75
VESA 800 x 600	53.68	85
VESA 1024 x 768	68.677	85
MAC 640 X 400	31.47	70
VESA 640 X 480	31.47	60
VESA 800 X 600	37.88	60
VESA 640 X 480	43.27	85
VESA 832 X 624	49.75	75
VESA 1024 X 768	60.02	75
VESA 1280 X 1024	63.98	60

User Modes

Modes 12-36 are empty and can accept new video data. If the monitor detects a new video mode that has not been present before or is not one of the preset modes, it stores the new mode automatically in one of the empty modes starting with mode 12.

If you use up the 25 blank modes and still have more new video modes, the monitor replaces the information in the user modes starting with mode 12.

Recalling Display Modes

When your monitor detects a mode it has seen before, it automatically recalls the image settings you may have made the last time you used that mode.

You may, however, manually force a recall of each of the 11 preset modes by pressing the Recall button. All preset modes are automatically recalled as the monitor senses the incoming signal.

The ability to recall the preset modes is dependent on the signal coming from your PC's video card or system. If this signal does not match any of the factory modes, the monitor automatically sets itself to display the image.

Energy Saving Design

This monitor complies with the EPA's Energy Star program, which is a program designed to have manufacturers of computer equipment build circuitry into their products to reduce power consumption during time of non-use.

This monitor also goes into its energy saving mode if you exceed the monitor's operating limits, such as the maximum resolution of 1280x1024 or the frequency refresh rates of 30-70kHz horizontal or 50-160Hz vertical. When this monitor is used with a Green or EPA Energy Star PC, or a PC with a screen blanking software following the VESA Display Power Management Signalling (DPMS) protocol, this monitor can conserve significant energy by reducing power consumption during periods of non-use. When the PC goes into the energy saving mode, the monitor will go into a suspended operation state, indicated by the Power LED light changing from a green color to an amber color. After an extended period in the suspended mode, the monitor will then enter a semi-OFF mode to conserve more energy. In the semi-OFF mode or DPMS OFF mode as we call it in our specifications, the Power LED will still show an amber color. When you awaken your PC by hitting a key or moving the mouse, the monitor will also awaken to its normal operating mode, indicated by the green Power LED light. By following these conventions, the power consumption can be reduced to the following levels:

Power Consumption

Mode	Hori. Sync	Verti. Sync	Video	Power Consumption	LED Color
Normal(Max.)	On	On	Normal	≤ 120W	Green
Stand-by	Off	On	Off	≤ 15W	Amber
Suspend	On	Off	Off	≤ 15W	Amber
Off	Off	Off	Off	≤ 8W	Amber

Note:stand-by/suspend Mode 에서는 오디오의 기능이 지원되지 않습니다.

Low Radiation Compliance (MPR II)

This monitor meets one of the strictest guidelines available today for low radiation emissions, offering the user extra shielding and an antistatic screen coating. These guidelines, set forth by a government agency in Sweden, limit the amount of emission allowed in the Extremely Low Frequency (ELF) and Very Low Frequency (VLF) electromagnetic range.

Self Diagnostics



This monitor can sense when there is a possible problem present, and informs you of this condition by presenting you with a **SELF DIAGNOSTICS** OSD. This OSD may pop up when it is **On** but no signal is detected. In this case the message **CHECK SIGNAL CABLE** will be high lighted, alerting you to check the signal cable connections.

DDC (Display Data Channel)

DDC is a communication channel over which the monitor automatically informs the host system (PC) about its capabilities. This monitor has DDC function; DDC2B DDC2B carry out uni-directional communication between the PC and the monitor. Under these situations, the PC sends display data to the monitor but not commands to control the monitor settings.

Note : PC must support DDC functions to do this.

If your monitor is displaying a monochrome image or the wrong resolution, select the DDC OFF function.

Troubleshooting

Self diagnostics message.

- The signal cable is not connected.
-

OUT OF FREQUENCY message appears.

- The frequency of the sync input is outside the operating range of the monitor.

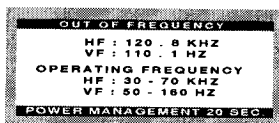

*Horizontal Frequency: 30-70kHz

*Vertical Frequency: 50-160Hz

Use the graphics board's utility software to change the frequency setting (Refer to the manual for graphics board).

The power LED is illuminated amber.

- Display power management mode.
 - There is no sync signal.
 - The signal cable is not fastened securely.
 - Check the computer power and graphics adapter configuration.
-

The image on the SCREEN is not centered, or too small, or not a rectangle shape.

- Image adjustment not been done yet in the current operating mode. Use the SELECT and ◀ or ▶ buttons to set the image to your liking.
-

The monitor doesn't enter the power saving off mode (Amber).

- Computer video signal is not VESA DPMS standard. Either the PC or the video controller card is not using the VESA DPMS power management function.
-

Service

Unplug the monitor from the wall outlet and refer servicing to qualified service personnel when :

- The power cord or plug is damaged or frayed.
- Liquid has been spilled into the monitor.
- The monitor has been exposed to rain or water.
- The monitor does not operate normally following the operating instructions. Adjust only those controls that are covered in the operating instructions. An improper adjustment of other controls may result in damage and often requires extensive work by a qualified technician to restore the monitor to normal operation.
- The monitor has been dropped or the cabinet has been damaged.
- The monitor exhibits a distinct change in performance.
- Snapping or popping from the monitor is continuous or frequent while the monitor is operating. It is normal for some monitors to make occasional sounds when being turned on or off, or when changing video modes.

Do not attempt to service the monitor yourself, as opening or removing covers may expose you to dangerous voltage or other hazards. Refer all servicing to qualified service personnel.

Specifications

Sync Signal Types

Type	H. Sync	V. Sync
Separate Sync	H. Sync	V. Sync

(N.C : No Connection)

Signal Connector Pin Assignment

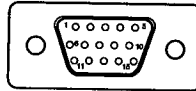

Pin	Signal(D-Sub)
1	Red
2	Green
3	Blue
4	Ground
5	Self-Test
6	Red Ground
7	Green Ground
8	Blue Ground
9	NC
10	Ground
11	Ground
12	SDA
13	Hori.Sync
14	Vert.Sync
15	SCL

Note :No. 5 Pin have to ground on the PC side.

Specifications

Picture tube

- 17 inches (15.9 inches viewable) FST
- 90 degree deflection
- 0.27 mm dot pitch, Non-glare, Darkface

Sync Input

- Horizontal Frequency : 30 - 70kHz (Automatic)
- Vertical Frequency : 50 - 160Hz (Automatic)
- Input Form : Separate, TTL, Positive/Negative
- Signal input : 15 pin D-Sub Connector

Video Input

- Display Area : 12.2 x 9.06 inches / 310 x 230mm (H x V)
- Input Form : Separate, RGB Analog, 0.7 Vp-p/75 ohm, Positive
- Resolution : 1280 x 1024, 60Hz

Audio

- RMS Audio Output : 4 W (R+L)
- Input Sensitivity : 0.7 Vrms
- Built-in MIC : E.C.M type (Electret Condenser Microphone)

Power input

- AC100-240V 50/60Hz 2.0A

Dimensions (with tilt/swivel stand)

- Width : 416 mm/16.4 inches
- Height : 430 mm/16.9 inches
- Depth : 440 mm/17.3 inches

Weight

- Net : 17.0kg (37.5lbs)

Information in this document is subject to change without notice and does not represent a commitment on the part of LG Electronics Inc.