

**Composition Touch, Composition
Colour**

Radio



L40SE2



Composition Touch, Composition Colour:
Radio
Stand: 21.08.2013
Englisch: 11.2013
Artikel-Nr.: 142.5R6.RCT.20



1425R6RCT20





Description of symbols

 Refers to a section within a chapter that contains important information and safety notes  that should always be observed.

 Indicates that the section is continued on the next page.

 Indicates the end of a section.

 Indicates situations in which the vehicle must be stopped as quickly as possible.

 TM Indicates a registered trademark. However, the absence of this symbol does not constitute a waiver of the rights concerning any term.

⇒  Symbols like these refer you to warnings within the same section or on a given page. They draw your attention to possible risks of accident or injury and explain how they can be avoided.

⇒  Symbols like these refer you to warnings within the same section or on a given page. They draw your attention to possible risks of accident or injury and explain how they can be avoided.

⇒  Cross reference to information about possible damage to your vehicle within the same section or on a given page.

DANGER

Texts with this symbol indicate dangerous situations which will lead to fatal or severe injuries if you do not observe the warning.

WARNING

Texts with this symbol indicate dangerous situations which could lead to fatal or severe injuries if you do not observe the warning.

CAUTION

Texts with this symbol indicate dangerous situations which could lead to slight or severe injuries if you do not observe the warning.

NOTICE

Texts with this symbol indicate situations which could cause damage to the vehicle or vehicle equipment if you do not observe the warning.

 Texts with this symbol contain additional information on the protection of the environment.

 Texts with this symbol contain additional information.

Volkswagen AG works continuously to develop and further improve all models. Please understand that we must therefore reserve the right to alter any part of the vehicle and its equipment or technical specifications at any time. The data provided concerning scope of delivery, appearance, performance, dimensions, weights, fuel consumption, standards and vehicle functions are all correct at the time of going to print. Some of the equipment described might not yet be available in a particular vehicle (information can be provided by your local Volkswagen dealership), and some equipment may not be available in certain countries. No legal commitment may be inferred from the information, illustrations or descriptions in this manual.

No part of this manual may be reprinted, reproduced or translated without the written permission of Volkswagen AG.

All rights under the laws of copyright are expressly reserved by Volkswagen AG. Subject to alteration and amendment.

Printed in Germany.

© Volkswagen AG 2013

 This paper was bleached without the use of chlorine.

FCC Compliance Statement [Level 4]

<North America>

This device complies with part 15 of the FCC Rules. Operation is subject to the following two conditions: (1) This device may not cause harmful interference, and (2) this device must accept any interference received, including interference that may cause undesired operation.

NOTE:

This equipment has been tested and found to comply with the limits for a Class B digital device, pursuant to Part 15 of the FCC Rules. These limits are designed to provide reasonable protection against harmful interference in a residential installation. This equipment generates, uses, and can radiate radio frequency energy and, if not installed and used in accordance with the instructions, may cause harmful interference to radio communications. However, there is no guarantee that interference will not occur in a particular installation. If this equipment does cause harmful interference to radio or television reception, which can be determined by turn-ing the equipment off and on, the user is encouraged to try to correct the interference by one or more of the following measures:

- Reorient or relocate the receiving antenna.
- Increase the separation between the equipment and receiver.
- Connect the equipment into an outlet on a circuit different from that to which the receiver is connected.
- Consult the dealer or an experienced radio/TV technician for help.

Caution:

Any changes or modifications in construction of this device which are not expressly approved by the party responsible for compliance could void the user's authority to operate the equipment.

<Canada>

This Class B digital apparatus complies with Canadian ICES-003 "To prevent radio interference to the licensed service, this device is intended to be operated indoors and away from windows to provide maximum shielding. Equipment (or its transmit antenna) that is installed outdoors is subject to licensing."

Cet appareil numérique de la classe B est conforme à la norme NMB-003 «Pour empêcher que cet appareil cause du brouillage au service faisant l'objet d'une licence, il doit être utilisé à l'intérieur et devrait être placé loin des fenêtres afin de fournir un écran de blindage maximal. Si le matériel (ou son antenne d'émission) est installé à l'extérieur, il doit faire l'objet d'une licence.»

Operation is subject to the following two conditions :

(1) This device may not cause Interference, and (2) this device must accept any interference, including interference that may cause undesired operation of the device.

PRODUCT SPECIFICATION

MODEL	L40SE2
Dimensions (mm) W	219.1
Dimensions (mm) H	118.5
Dimensions (mm) D	208.7
Weight (KG)	1.48
Power Requirement	9V~18V
Power Consumption	25W * 4CH

Bluetooth Specification

Standard	Bluetooth Version 2.1
Frequency Range	2400 ~ 2483.5 MHz
Output Power (Max.)	+4 dBm Max.

Table of Contents

About this manual	2	Telephone control (PHONE)	
		Introduction to telephone control system ..	30
		Description of telephone control system ..	34
Introduction		Settings	
Before using the unit for the first time	3	Menu and system settings (SETUP)	40
Safety information for the infotainment system	3	Sound and volume settings	42
Overview of the control elements	6	Abbreviations	44
General information on operating the unit ..	7	Index	45
Audio mode			
Radio mode	12		
Media mode	20		



About this manual

- An [alphabetical index](#) is included at the end of this manual.
- A [list of abbreviations](#) explains technical abbreviations and terms.
- [Directions and positions](#) (e.g. right, left, front, rear) are normally relative to the vehicle's direction of travel.
- [Illustrations](#) help with orientation and should be regarded as a general guide.
- In [right-hand drive vehicles](#) the controls may sometimes be different to those displayed in illustrations or described in the text.

All equipment and models are described without indicating whether the equipment is optional or specific to the model type. This means that some

of the equipment described might not be fitted in your vehicle. Your Volkswagen dealership can provide more information on this.

All details provided in this manual correspond to the information available at the time of going to print and apply only to factory-fitted infotainment systems. Due to continuous technical improvement of the infotainment system and possible updates to the unit's software, the displays and functions on the infotainment system may differ from the details given in this manual. No claims may be derived from the differing details, illustrations or descriptions.

Please ensure that this manual is in the vehicle if you lend or sell the vehicle to someone else. <

Introduction

Before using the unit for the first time

Before using the infotainment system for the first time, carry out the following steps. This will enable you to use the infotainment system safely and make full use of the functions it provides:

- ✓ Observe safety notes  ⇒ page 3.
- ✓ Familiarise yourself with the controls for the infotainment system ⇒ page 7.
- ✓ In the **System setup**, reset the infotainment system to its original condition (factory settings) ⇒ page 40.
- ✓ Use suitable data storage devices for media mode ⇒ page 20.

Safety information for the infotainment system

 **WARNING**

Accidents and injuries can occur if the driver is distracted. Operating the infotainment system can distract you from the road.

- Always drive carefully and responsibly.
- Select volume settings that allow signals from outside the vehicle (such as emergency services sirens) to be easily heard at all times.
- Setting the volume too high may damage your hearing. This also applies even if you are only exposed to high volumes for short periods.

 **WARNING**

External devices that are placed loose in the vehicle or not properly secured can be flung through the interior and cause injuries during a sudden driving or braking manoeuvre, or in the event of an accident.

- You should never position or attach an external device on a door, on the windscreen or above or near to the areas marked “AIRBAG” on the steering wheel, the dash panel and the seat backrests, or between these areas and the vehicle occupants. External devices can cause serious injury in an accident, especially when the airbags deploy.

 **WARNING**

The volume level may suddenly change when you switch audio source or connect a new audio source.

- Reduce the base volume before switching audio source or connecting a new audio source.

 **WARNING**

The armrest may obstruct the driver's arm movements, which could cause accidents and severe injuries.

- Always keep the armrest down while the vehicle is in motion.

 **WARNING**

Connecting, inserting or removing a storage device while the vehicle is in motion can distract you from the road and lead to accidents.

 **WARNING**

Opening the housing on a CD player can lead to injuries from invisible laser radiation.

- CD players should only be repaired by a qualified workshop.

 **WARNING**

Connecting leads for external devices may obstruct the driver.

- Arrange the connecting leads so that they do not obstruct the driver.

 **NOTICE**

The infotainment system can be damaged by incorrect insertion of a storage device or insertion of an incompatible storage device.

NOTICE (Continued)

- When inserting a memory card, ensure that it is correctly positioned ⇒ page 20.
- Applying force may destroy the memory card slot's locking mechanism.
- Only use suitable memory cards.
- When inserting and removing a CD, always hold it flat and at a right angle to the front of the unit. Inserting or removing a CD at an angle to the drive can lead to scratching ⇒ page 20.
- Inserting a second CD while a CD is already in the CD drive or being ejected can destroy the CD drive in the unit. Always wait until the CD is completely ejected!

NOTICE

The CD drive can be damaged by any foreign objects attached to a storage device, and by irregularly shaped storage devices.

NOTICE (Continued)

- Only clean 12 cm standard CDs should be used.
 - Do not affix stickers or other items to the data storage device. Stickers may peel off and damage the CD drive.
 - Do not use printable data storage devices. Coatings and prints may peel off and damage the drive.
 - Do not insert 8 cm single CDs or irregularly shaped CDs or DVDs.
 - Do not insert DVD Plus discs, dual discs or flip discs, as these are thicker than normal CDs.

NOTICE

The vehicle loudspeakers may be damaged if the volume is too high or the sound is distorted.

CONFIDENTIAL
not for distribution

Overview of the control elements



Fig. 1 Overview of the control elements

Different versions of the infotainment system are supplied. The labelling and functions of the infotainment buttons ⇒ Fig. 1 ② and the position of the CD slot ⑤ may vary between versions.

- ① **Rotary/push knob:**
 - Press to switch on or off ⇒ page 7.
 - Turn to adjust the basic volume on whichever source is in use ⇒ page 7.
- ② **Infotainment buttons:** press a button to select a function.
 - **RADIO:** switches to radio mode and changes frequency band in radio mode ⇒ page 12.
 - **MEDIA:** switches to media mode ⇒ page 20.
 - **CAR:** opens vehicle and system settings ⇒ Booklet *Owner's manual*, chapter *Introduction to the infotainment system*.
 - **SETUP:** opens menu and system settings ⇒ page 40.
 - **SOUND:** opens sound and volume settings ⇒ page 40.
 - **EJECT:** ejects the CD ⇒ page 20.
 - **MUTE:** mute the audio source ⇒ page 8.
 - **PHONE:** opens the telephone control system ⇒ page 30. The current audio source is muted if no mobile telephone provision is installed.
- ③ **Touchscreen** ⇒ page 7.
- ④ **Setting knob:** the function of this button depends on the unit's operating state.
 - In **all radio modes:** turn for manual station or channel selection. Press to start and stop the scan function ⇒ page 12.
 - In **media mode:** turn to open the track list. Press to start and stop the scan function ⇒ page 20.
 - Turn to select menu options in long lists and press to access the selected option (e.g. select a station from the station list).
- ⑤ **CD slot:** for inserting and removing CDs ⇒ page 20.
- ⑥ **AUX-IN socket:** for connecting an external audio source ⇒ page 20.
- ⑦ **Memory card slot:** the slot is located underneath or to the left of the screen, depending on the unit version ⇒ page 20.

General information on operating the unit

Introduction

This chapter contains information on the following subjects:

Rotary/push knobs and infotainment buttons	7
Switching on and off	7
Adjusting base volume	8
Operating function buttons and displays on the screen	8
Selecting list entries and browsing lists	9
Input windows with on-screen keypad	10
Additional display information and display options	11

Changes to settings may cause the display content to vary and some aspects of the infotainment system operation to differ from the descriptions given in this manual.

Additional information and warnings:

- Safety information  for infotainment system ⇒ page 3
- Overview of the control elements ⇒ page 6



 Lightly pressing the buttons or briefly touching the touchscreen is sufficient to operate the infotainment system.

 Not all listed function buttons and functions may be available due to the device software used in your market. The equipment is not faulty if a function button is missing from the screen.



 Due to country-specific legislation, certain functions cannot be selected on the screen when the vehicle is travelling above a certain speed.

 Using a mobile telephone in the vehicle may cause noise from the vehicle loudspeakers.



 There may be restrictions on the use of Bluetooth® devices in some countries. Information is available from the local authorities.

 In some vehicles equipped with ParkPilot, the volume of the current audio source is automatically lowered when reverse gear is engaged. Volume reduction can be set in the **Sound setup** menu ⇒ page 42. 

Rotary/push knobs and infotainment buttons

 **First read and observe the safety warnings  on page 3 and the introductory information on page 7.**

Rotary/push knobs

The left-hand rotary/push knob  ⇒ Fig. 1  is referred to as the volume control or the on/off switch.



The right-hand rotary/push knob ⇒ Fig. 1  is referred to as the setting knob.



Infotainment buttons

This manual uses a button symbol with blue content and the term “infotainment button” to refer to buttons on the infotainment system, e.g. the infotainment button [MEDIA](#).

Infotainment buttons are operated either by *pressing* them or by *pressing and holding*. 

Switching on and off

 **First read and observe the safety warnings  on page 3 and the introductory information on page 7.**

To switch the infotainment system on or off manually, briefly *press* the rotary/push knob  ⇒ Fig. 1 .

After switching on, the system starts at the last selected volume setting, provided that this does not exceed the preselected maximum switch-on volume ⇒ page 42, *Sound and volume settings*.



Depending on the unit version and the country, the infotainment system may switch off automatically when the engine is switched off or the vehicle key 

is removed from the ignition lock. If the infotainment system is switched on again, it will switch off automatically after approximately 30 minutes (switch-off delay).



i The infotainment system is permanently linked to the vehicle. It cannot be used in another vehicle.

i If the vehicle battery has been disconnected, the ignition must be switched on before switching the infotainment system back on.

Adjusting base volume

 First read and observe the safety warnings  on page 3 and the introductory information on page 7.

Function: action





Increasing the volume: turn the volume control  ⇒ Fig. 1  clockwise or press the  button on the multifunction steering wheel ⇒ Booklet *Owner's manual*.

Decreasing volume: turn the volume control  ⇒ Fig. 1  anticlockwise or press the  button on the multifunction steering wheel.

Changes to the base volume are indicated by a "bar" on the screen. During this time the infotainment system cannot be operated.

It is possible to preset certain volume settings and adjustments ⇒ page 42.

Muting the infotainment system

- Turn the volume control  ⇒ Fig. 1  anticlockwise until  is displayed.
- **OR:** press the **[MUTE]** infotainment system button¹⁾ ⇒ Fig. 1 .

Any media source currently being played is stopped while the infotainment system is muted.  appears on the display.

i If the base volume has been considerably increased to play a certain audio source, reduce the volume again before switching to another audio source.

Operating function buttons and displays on the screen













Fig. 2 Overview of possible function buttons on the screen

¹⁾ Depending on the unit version.

Inactive (grey) function buttons cannot be selected.

Overview of displays and function buttons



Displays and function buttons: action and effect

	In the title bar, the currently selected menu and any other possible function buttons are displayed.
	Touch to open a further menu.
	Move the crosshair across the screen with slight pressure without losing contact. OR: touch the desired position on the screen, the crosshair moves to this position.
	Touch to move up one level at a time from certain lists.
	Touch to move up one level at a time to the main menu from a submenu or to undo inputs made.
	Touch to open a pop-up window (option window), displaying further setting options.
	Some functions or displays are marked with a checkbox and are activated <input checked="" type="checkbox"/> or deactivated <input type="checkbox"/> by touching this box.
	Touch to confirm an input or selection.
	Touch to close a pop-up window or an input window.
	Touch to change settings incrementally.
	Move the slider across the screen with slight pressure without losing contact.

Selecting list entries and browsing lists



Fig. 3 List entries settings menu

 **First read and observe the safety warnings  on page 3 and the introductory information on page 7.**



List entries can be opened by touching them directly on the screen or by using the setting knob \Rightarrow Fig. 1 (4).

Marking and selecting list entries with the setting knob

- Turn the setting knob to mark each consecutive list entry with a selection box so you can browse through the list.
- Press the setting knob to select the marked list entry.

Browsing lists (scrolling)

If there are more items available in a list view than can be displayed on the screen, function buttons for scrolling or a scroll bar are displayed on the right of the screen \Rightarrow Fig. 3.

- *Browsing lists line-by-line:* touch the  or  function button briefly.
- *Browsing lists page-by-page:* briefly touch the screen above or below the scroll marker.
- *Browsing long lists quickly page-by-page:* touch and hold the screen above or below the scroll marker.
- *To quickly scan through a long list,* place your finger on the scroll marker and move it over the screen *without losing contact*. Lift your finger off the screen when you reach the desired position.

Input windows with on-screen keypad

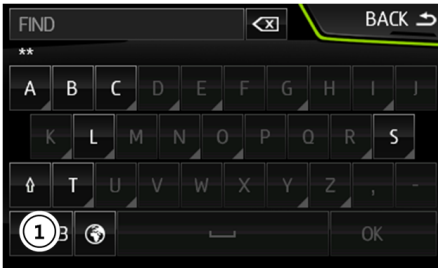



Fig. 4 Input window with on-screen keyboard

 **First read and observe the safety warnings  on page 3 and the introductory information on page 7.**







Input windows with on-screen keyboard allow you to enter text, such as an entry name for storing a destination or a search term for searching in long lists.

Not all of the function buttons listed here are available in all countries and for all topics.

Subsequent chapters only explain those functions that differ from the general view described here.

Overview of function buttons

Function buttons: action and effect

①	 : touch to open the input window for numbers and special characters.
	 : touch to go back to the input window for letters.
②	Displays the number and opens the list of entries corresponding to the specifications that are still available.
Letters/numbers	Touch to insert the character in the input line.
	Press and hold to open a pop-up window with special characters based on the letter shown.
Letters and ▾	Touch the desired character to enter it. Some special characters can also be written out (e.g. "AE" for "Ä").
	Touch to switch between upper and lower case.
	Touch to enter a space.
	Touch to accept the suggestion in the input line and close the input window.
	Touch to delete characters in the input line from right to left. Press and hold to delete several characters at once.
	Touch to close the input window.

The input line with the cursor is located on the left in the top line of the screen *. All inputs are displayed here.

Input windows for free text input

An input window for free text entry allows any letter, number and special character to be entered in any combination.

Touching the  function button applies the sequence of characters currently displayed in the window.

Input windows for selecting a stored entry

It is only possible to select a sequence of letters, numbers and special characters that matches a stored entry.

Every time a character is entered, a destination corresponding to the specifications is proposed in the input line. When terms are made up of more than one word, the space must be entered as well.

If fewer than 99 entries are available, the number of remaining entries is displayed after the input line ⇒ Fig. 4 ②. Touching this function button displays a list of these remaining entries.

Additional display information and display options



First read and observe the safety warnings  on page 3 and the introductory information on page 7.

The displays that appear on the screen can vary depending on the settings, and may differ from those described here.

Displays such as the current time and the current outside temperature can be displayed on the screen in the status bar.

All displays appear only after the infotainment system has completed start-up. 

Audio mode

Radio mode

Introduction

This chapter contains information on the following subjects:

RADIO main menu	12
RDS radio data service	13
Station buttons	14
Selecting, setting and storing stations	14
Scan function (SCAN)	16
Radio text	16
TP function (traffic program)	17
Incoming traffic announcement	17
FM/AM settings	18

- Basic information on use ⇒ page 7
- Menu and system settings (SETUP) ⇒ page 40

i Multi-storey car parks, tunnels, high buildings and mountains can impair radio reception.

i Foil or metal-coated stickers attached to the windows may affect reception on vehicles with a window aerial.

Additional information and warnings:

- Safety information **⚠** for infotainment system ⇒ page 3
- Overview of the control elements ⇒ page 6

RADIO main menu



Fig. 5 RADIO main menu



Fig. 6 Radio mode station list

First read and observe the safety warnings **⚠ on page 3 and the introductory information on page 12.**

Selecting the frequency band





- Select the required frequency band by pressing the **RADIO** infotainment button.

Function buttons in the RADIO main menu

Function button: effect

1	Changes the displayed station button group by touching the function button.
	Opens the list of currently receivable radio stations ⇒ page 14.
	Opens the frequency dial for the selected frequency band ⇒ page 15.
	Opens the settings menu for the currently activated frequency band (FM or AM) ⇒ page 18.

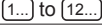
Function button: effect

	Browses through the available or stored stations. Setting for the arrow buttons in the FM/AM setup menu ⇒ page 18.
	The function button is only displayed while the scan function is on ⇒ page 16.
	Station buttons for storing stations ⇒ page 14.
	Updates the station list (AM frequency band) ⇒ page 15.

Possible displays and symbols

Display: meaning



	Displays station frequency or station name, and also possibly radio text. Station name and radio text are only displayed when RDS is available and activated ⇒ page 13.
RDS off ^{a)}	The RDS radio data service is deactivated. RDS can be activated in the FM setup menu ⇒ page 18.
TP	TP traffic news is activated and can be received ⇒ page 17.
No TP	No traffic news station can be received.
☆	The radio station is stored to a station button.

^{a)} Varies by country and unit version.

RDS radio data service



Fig. 7 RADIO main menu

 **First read and observe the safety warnings**  **on page 3 and the introductory information on page 12.**

RDS (radio data system) is a radio data service which enables additional FM services, such as the display of station names, automatic station tracking, radio text and TP traffic news (TP).

RDS is not supported by all units and is not available everywhere or on every FM radio station.

RDS can be deactivated in some country and unit versions ⇒ page 18.

Without RDS it is not possible to use radio data services.



Fig. 8 Radio mode station list

Station name and automatic station tracking

If RDS is available, station names can be displayed in the *RADIO* main menu and in the **FM station list**.

FM radio stations may occasionally or continuously broadcast different content on different regional frequencies under the same station name (e.g. Radio 2).

By default, automatic station tracking always switches to the currently selected station's frequency that offers the best reception, as the vehicle travels from one area to the next. As a result, you may lose the regional programme you are listening to.

Automatic frequency changing and automatic station tracking can be deactivated in the **FM setup** ⇒ page 18.

 The radio stations are responsible for the content of the information sent.



Station buttons

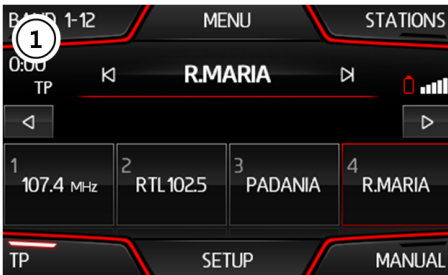





Fig. 9 RADIO main menu

 **First read and observe the safety warnings  on page 3 and the introductory information on page 12.**

In the *RADIO* main menu, you can store stations from the currently selected frequency band on 12 consecutively numbered function buttons. These function buttons are called station buttons.

Selecting stations via the station buttons	Touch the station button that shows the required station. When a stored station is selected via the station buttons, it will only be played if it can be received at your current location.
Changing station button group	Touch the \Rightarrow Fig. 9  function button. The station buttons are displayed in groups of four function buttons (1... to 4..., 5... to 8... and 9... to 12...).
Displaying station buttons	If radio text is shown instead of the station buttons, touch radio text in order to show the station buttons.
Storing stations to station buttons	See Storing stations \Rightarrow page 15.



Selecting, setting and storing stations



Fig. 10 RADIO main menu

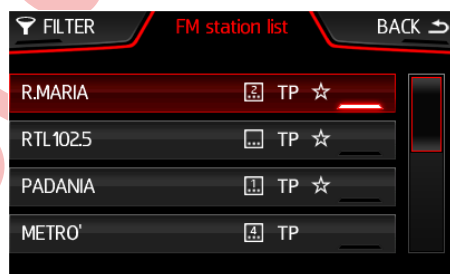









Fig. 11 Radio mode station list





First read and observe the safety warnings  on page 3 and the introductory information on page 12.

Selecting stations

Selecting stations using arrow buttons  / 	Touch the  or  ⇒ Fig. 10 function button. The unit only switches to stored or receivable stations, depending on what settings have been made for the arrow buttons. Setting for the arrow buttons in the FM/AM setup menu ⇒ page 18.
Selecting stations from a station list	Touch the  ⇒ Fig. 10 function button to open the station list. Search through the list and touch the required station to select it. To close the station list, touch the  ⇒ Fig. 11 function button.
Updating the station list	In the FM frequency band the station list is updated automatically. In the AM frequency band, touch the  ⇒ Fig. 11 function button to update the station list.

Tuning to a station frequency manually

Displaying the frequency dial	Turn the setting knob <i>one stop further</i> . OR: touch the  ⇒ Fig. 10 function button.
Adjusting the frequency in stages	Turn the setting knob. OR: touch the arrow buttons to the left or the right of the frequency band.
Quickly browsing through the frequency band	Touch one of the arrow buttons at the top of the screen ⇒ Fig. 10. The next receivable station is set automatically. OR: <i>press and hold</i> one of the arrow buttons at the top of the screen ⇒ Fig. 10. When you <i>release</i> the button, the unit automatically tunes to the next available station. OR: place your finger on the slider in the frequency dial and drag it along the dial.
Hiding the frequency band	Briefly press the setting knob. Manual frequency selection is also closed if you select a station with a station button. The frequency band closes automatically after a period of inactivity.

Storing stations

Storing the current station to a station button	Press and hold the desired station button ⇒ Fig. 10 until a tone is sounded. The station currently playing is then stored on that station button.
Storing a station from the station list to a station button	Touch the  ⇒ Fig. 10 function button to open the station list. Stations already stored on a station button are marked in the station list with the ☆ ⇒ Fig. 11 symbol. Select the desired station by <i>pressing and holding</i> on the screen. Touch the button to which you wish this station to be assigned. A signal tone sounds, and the station is then stored on this station button. Repeat the process to store further stations from the station list.
Deleting stored stations	All stored stations can be deleted individually or together in the FM/AM setup menu ⇒ page 18.

Stopping station names scrolling (FM frequency)

Some radio stations transmit a very long station name, which is shown on the screen as a scrolling text.

To fix the text that is currently displayed to the screen, touch the station name and hold until a tone is sounded.

Fixed station names are indicated by a dot to each side of the name.

The fixed text is adopted for all the station buttons on which the corresponding station is stored. <

Scan function (SCAN)

 **First read and observe the safety warnings ⚠ on page 3 and the introductory information on page 12.**

When the scan function is running, all available stations on the current frequency band are played in sequence for approximately 5 seconds each. **SCAN** appears on the display. <

Starting the scan function	Press the setting knob briefly. OR: touch the SCAN function button and then select SCAN .
Stopping the scan function	Press the setting knob briefly. OR: touch the SCAN function button to end the scan function at the station arrived at. Manually selecting a station with the station buttons also stops the scan function. <

Radio text



Fig. 12 RADIO main menu



Fig. 13 Radio mode: radio text is visible

 **First read and observe the safety warnings ⚠ on page 3 and the introductory information on page 12.**

The station buttons can be hidden to enlarge the display area for the radio text => Fig. 13.

Some RDS-compatible stations also broadcast additional text information known as radio text.

Hiding station buttons	Touch displayed radio text => Fig. 12.
Displaying station buttons	Touch displayed radio text => Fig. 13.
Switching off radio text permanently	In the FM setup menu, deactivate the Radio text function button by touching it => page 18. <

TP function (traffic program)



Fig. 14 RADIO main menu with TP display



First read and observe the safety warnings  on page 3 and the introductory information on page 12.

Traffic news monitoring with the TP function is only possible if a traffic news station is available. Traffic news stations are indicated in the *RADIO* main menu and in the station list by TP \Rightarrow Fig. 14 and \Rightarrow Fig. 15.

Some stations that do not broadcast their own traffic news support the TP function through a link to a traffic news station (EON).

Switching the TP function on and off

- In the **FM/AM setup** menu, activate or deactivate the **Traffic program (TP)** function button by touching it \Rightarrow page 18.

If the station that is currently selected does **not** support the TP function, **No TP** will be shown in the top right of the screen.

Activated TP function and station selection

While traffic news monitoring is on, TP is displayed at the top right in audio mode \Rightarrow Fig. 14. Traffic announcements broadcast by the current station or a linked traffic news station will interrupt the current audio mode.

Incoming traffic announcement



First read and observe the safety warnings  on page 3 and the introductory information on page 12.

Incoming traffic announcements will interrupt the active audio mode.

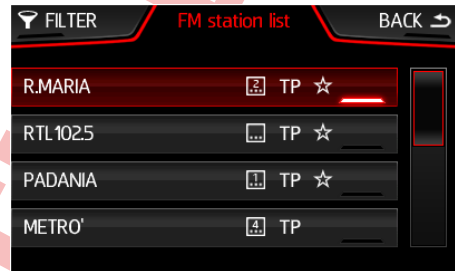





Fig. 15 Radio mode: station list with TP display

In **FM mode**, the **selected** station must support the TP function. After the TP function is switched on, if you change via the station buttons or manual selection to a station that does **not** support the TP function, traffic news monitoring will not be possible (display: **No TP**).



If the currently selected traffic news station can no longer be received, **No TP** is also displayed and you will have to start a manual station search \Rightarrow page 14.

In **AM mode** or **media mode**, the unit will always automatically tune to a traffic news station in the background, provided that a TP station is available. This procedure may take some time.

The traffic announcement volume setting can be adjusted with the volume control  ⇒ Fig. 1 . The adjusted volume setting will be applied to subsequent announcements.

- Touch the **Cancel** function button to end the traffic announcement. The TP function remains activated.
- **OR:** touch the **Deactivate** function button to end the current traffic announcement and permanently switch off the TP function. 

FM/AM settings

 **First read and observe the safety warnings  on page 3 and the introductory information on page 12.**

FM setup

- Select the **FM** frequency band by pressing the **RADIO** infotainment button.
- Touch the  function button to open the **FM setup** menu.

Function button: effect

Scan: scan function (SCAN). When the scan function is running, all available stations on the current frequency band are played in sequence for approximately 5 seconds each ⇒ page 16.

Arrow buttons: define the settings for the  and  arrow buttons. The setting is adopted for all frequency bands (FM, AM).

Preset list: **all stored** stations on the selected frequency band can be browsed with the arrow buttons.

Stations: **all available** stations on the selected frequency band can be browsed with the arrow buttons.

Traffic program (TP): the TP function (traffic news monitoring) is activated ⇒ page 17.

Radio text: radio text is activated ⇒ page 16.

Delete preset list: to delete some or all stored stations.

All: all stored stations will be deleted (FM 1, FM 2, FM 3).

To delete individual stations, selected the desired preset list **FM 1**, **FM 2** or **FM 3**. Then touch the station button of the station you wish to delete.

Advanced setup: settings for the RDS radio data services.

RDS Regional: defines the setting for automatic **station tracking** with RDS ⇒ page 13.

Fixed: the unit only switches to alternative frequencies for the selected station that broadcast the same regional service.



Automatic: the unit always switches to the station's frequency that currently offers the best reception. As a result, regional programmes may be interrupted.

Radio Data System (RDS)^{a)}: the radio data system (RDS) is deactivated ⇒ page 13. If the checkbox is deactivated, the traffic program (TP) and radio text functions are not available.

Alternative frequency (AF): automatic station tracking is activated. If the checkbox is deactivated, automatic station tracking is **switched off**. The **RDS Regional** function button is then inactive (greyed out).



^{a)} Varies by country and unit version.

AM setup

- Select the **AM** frequency band by pressing the **RADIO** infotainment button.
- Touch the  function button to open the **AM setup** menu. 

Function button: effect

Scan: scan function (SCAN). When the scan function is running, all available stations on the current frequency band are played in sequence for approximately 5 seconds each ⇒ page 16.

Arrow buttons: define the settings for the  und  arrow buttons. The setting is adopted for all frequency bands (FM, AM).

Preset list: all **stored** stations on the selected frequency band can be browsed with the arrow buttons.

Stations: all **available** stations on the selected frequency band can be browsed with the arrow buttons.

Traffic program (TP): the TP function (traffic news monitoring) is activated ⇒ page 12.

Delete preset list: to delete some or all stored stations.

All: all stored stations will be deleted (AM 1, AM 2, AM 3).

To delete individual stations, select the desired preset list **AM 1**, **AM 2** or **AM 3**. Then touch the station button of the station you wish to delete. 

Media mode

Introduction

This chapter contains information on the following subjects:

- Data storage device and file requirements . . . 20
- Playing order of files and folders 21
- MEDIA main menu 22
- Changing the media source 23
- Changing tracks in the MEDIA main menu . . . 24
- Selecting tracks from the track list 24
- Inserting or ejecting a CD 25
- Inserting or removing a memory card 26
- External data storage device connected to USB port  26
- External audio source connected to the AUX-IN socket 27
- Connecting an external audio source via Bluetooth® 28
- Media settings 28

dio files can be played by the infotainment system from its corresponding drives or audio input sockets (internal CD drive, memory card slot, AUX-IN socket etc.).

Copyright

Audio and video files stored on data storage devices are normally subject to national and international copyright laws. Observe legal requirements.



Additional information and warnings:

- Safety information  for infotainment system ⇒ page 3
- Overview of the control elements ⇒ page 6
- Basic information on use ⇒ page 7

 This product is subject to certain intellectual property rights and copyrights owned by the Microsoft Corporation. The use or distribution of this type of technology outside this product requires a licence from Microsoft or an authorised Microsoft company.

“Media sources” are audio sources containing audio files on various different storage devices (e.g. CD, memory card, external MP3 player). These au-





Data storage device and file requirements

 **First read and observe the safety warnings  on page 3 and the introductory information on page 20.**

The supported file formats listed are collectively referred to below as “audio files”. A CD containing audio files of these types is referred to as an “audio data CD”.

Factory-fitted CD drives conform to safety class 1 according to DIN IEC 76 (CO) 6/ VDE 0837.

The infotainment system only accepts standard 12 cm CDs, and memory cards measuring 32 mm x 24 mm x 2.1 mm or 1.4 mm.

Media source	Requirements for playing in the unit
 Audio CDs (up to 80 minutes).	– CD Digital Audio specification  .
 CD-ROM, CD-R and CD-RW audio data CDs up to max. 700 MB (megabytes) with the file systems ISO 9660 Level 1 or 2, Joliet or UDF 1.02, 1.5, 2.01	– MP3 files (.mp3) with bit rates of between 32 and 320 kbit/s or with variable bit rate. – WMA files (.wma) up to 10 mono/stereo without copy protection.
 SD and MMC memory cards with the file systems FAT12, FAT16, FAT32, VFAT or exFAT up to max. 2 GB (gigabytes), SDHC memory cards up to max. 32 GB and SDXC memory cards up to max. 2 TB (terabytes).	– Playlists in the formats PLS, M3U and WPL. – Playlists no larger than 20 kB and containing no more than 1,000 entries. – File name and path information not longer than 256 characters.

Media source	Requirements for playing in the unit
AUX External audio source.	– Playback of external audio sources via 3.5 mm jack plug ⇒ page 27.
⊗ Audio file playback via Bluetooth ^{®a)} .	– The external media player must support the A2DP Bluetooth [®] profile ⇒ page 28.

a) Bluetooth[®] is a registered trademark of Bluetooth[®] SIG, Inc.

Restrictions and notes

Contamination, exposure to high temperatures and mechanical damage can render storage devices unusable. Please observe the manufacturer's instructions.

Variations in the quality of storage devices from different manufacturers can lead to problems during playback.

Please observe copyright laws.

The unit may be unable to read individual tracks or the entire storage device due to the storage device's configuration or the devices and programs used for recording. Information about the best ways to create audio files and configure storage devices (compression rate, ID3 tag etc.) can be found online.

The reading time may vary considerably depending on the condition of the storage device (copying and deleting actions), folder structure and file type.

Playlists only determine a certain playing order. There are **no** files stored in a playlist. The unit will **not** play a playlist if the files are **not** stored on the storage device at the locations referred to by the playlist (relative file paths).

i Do not use memory card adapters.

i No liability can be accepted for damaged or lost files on the storage devices.

Playing order of files and folders

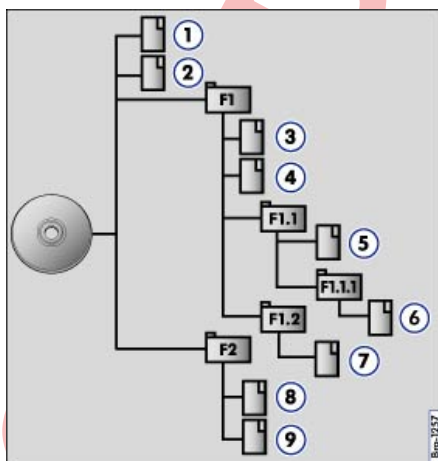

Fig. 16 Possible structure on an audio data CD

📖 First read and observe the safety warnings **⚠** on page 3 and the introductory information on page 20.

Audio files **📁** on storage devices are often sorted by folders **📁** and playlists **📁** to determine a certain playing order.

Tracks, folders and playlists on a storage device are each sorted by name in alphanumeric order.

The illustration shows a typical audio data CD that contains tracks **📁**, folders **📁** and subfolders ⇒ Fig. 16.

The tracks are played in the following order¹⁾:

1. Tracks **①** and **②** in the CD's root directory
2. Tracks **③** and **④** in the **first** folder **F1** in the CD's root directory
3. Track **⑤** in the **first** subfolder **F1.1** of the folder **F1**
4. Track **⑥** in the **first** subfolder **F1.1.1** of the subfolder **F1.1**
5. Track **⑦** in the **second** subfolder **F1.2** of the folder **F1**
6. Tracks **⑧** and **⑨** in the **second** folder **F2**

i The playing order can be altered by selecting different playback modes ⇒ page 22.

¹⁾ The **☑ Mix/Repeat including subfolders** function must be activated ⇒ page 40 in the **Media setup** menu.

 Playlists are **not** played automatically. Instead they must be specifically selected via the track selection menu → page 24. <

MEDIA main menu



In the *MEDIA* main menu, various media sources can be selected and played.



- Press the **MEDIA** infotainment button to open the *MEDIA* main menu → Fig. 17.

Playback of the media source that was most recently played resumes from the point where it stopped.

The media source currently playing is indicated at the bottom left in the function button ①.

















The *MEDIA* main menu will indicate if no media source is available.

Fig. 17 MEDIA main menu

 First read and observe the safety warnings  on page 3 and the introductory information on page 20.

Function buttons in the MEDIA main menu

Function button: effect

	Indicates the media source currently selected. Touch to select a different media source → page 23.
	 CD: internal CD drive → page 25.
①	 SD card: memory card → page 26.
	 USB: external data storage device connected to USB port → page 26.
	 AUX: external audio source connected to AUX-IN socket → page 27.
	 BT audio: Bluetooth® audio → page 28.
	Opens the track list → page 24.
	Changes track when in media mode → page 24
	Playback stops. The  function button changes to  → page 24.
	Playback is resumed. The  function button changes to  → page 24.
	Opens the Media setup menu → page 28.
	Repeats all tracks.
	All tracks on the same memory level as the current track will be repeated. If <input checked="" type="checkbox"/> Mix/repeat including subfolders is activated in Media setup subfolders are also included → page 28.
	Repeat current track.
	Random play.
	All tracks on the same memory level as the current track are included. If <input checked="" type="checkbox"/> Mix/repeat including subfolders is activated in Media setup subfolders are also included → page 28.

Function button: effect

When the scan function is running, all tracks in the current track list are played for approximately 10 seconds each.

SCAN

The function button is only displayed while the scan function is on. To start the scan function, press setting knob ⇒ Fig. 1 ④ or open the **▶** track list and touch the **SCAN** function button.

Displays and symbols in the MEDIA main menu

Display: meaning

	Display of track information (CD text  , ID3 tag with MP3 files).
A	Audio CDs: track and track number corresponding to the track order on the CD are displayed. Audio files: artist name , album name and track name are displayed.
B	Track playing time and remaining playing time in minutes and seconds. The remaining playing time displayed may differ for audio files with variable bit rate (VBR).
RDS off^{a)}	The RDS radio data service is deactivated. RDS can be activated in the FM setup menu ⇒ page 12.
TP	TP is activated and can be received ⇒ page 12.
No TP	No traffic news station can be received.

^{a)} Varies by market and unit version.

Changing the media source





- In the **MEDIA** main menu, press the **MEDIA** infotainment button as often as required to switch between the available media sources.
- **OR:** in the **MEDIA** main menu, touch the ⇒ Fig. 18 ① function button and select the desired media source.

Media sources not currently available are shown as inactive (grey) in the pop-up window.

If a media source that has already been played is selected again, playback is resumed from the point that was last reached.

Fig. 18 MEDIA main menu

 First read and observe the safety warnings  on page 3 and the introductory information on page 20.

Optionally selectable media sources

Function button: media source

@CD	Audio or audio data CD in the internal CD drive ⇒ page 25.
SD card	Memory card ⇒ page 26.
USB	External data storage device connected to USB ⇒ page 26.
AUX	External audio source connected to AUX-IN socket ⇒ page 27.
BT audio	Bluetooth® audio ⇒ page 28.

 The media source can also be changed in the **Track list** view ⇒ page 24.

Changing tracks in the MEDIA main menu

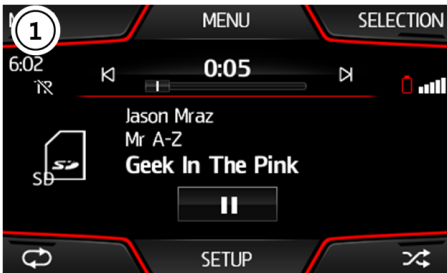

Fig. 19 MEDIA main menu

First read and observe the safety warnings on page 3 and the introductory information on page 20.

You can browse through the tracks of the media source that is currently playing using the arrow buttons.

You **cannot** switch to playback from a playlist using the arrow keys. Playback from a playlist must be started manually via the track selection menu ⇒ page 24, *Selecting tracks from the track list*.

Controlling playback via the MEDIA main menu

Action	Effect
Briefly touch the function button once.	Goes to the start of the current track. If the track is shorter than 3 seconds, the system goes to the start of the previous track.
Briefly touch the function button twice.	Goes to the start of the previous track. Changes from the first track to the last track on the storage device that is being played.
Briefly touch the function button once.	Goes to the next track. Changes from the last track to the first track on the storage device that is being played.
Press and hold the function button.	Fast reverse.
Press and hold the function button.	Fast forward.
Briefly touch the function button once.	Playback stops. The function button changes to .
Briefly touch the function button once.	Playback is resumed. The function button changes to .

Selecting tracks from the track list



Fig. 20 Track list from a media source

First read and observe the safety warnings on page 3 and the introductory information on page 20.















Opening the track list

- In the *MEDIA* main menu, touch the function button ⇒ Fig. 19 to open the track list. The track that is currently playing is highlighted ⇒ Fig. 20.
- Search through the track list and touch the desired track.



If track information is available, the track name is displayed instead of Track + No..

Overview of function buttons in the track list

Function button: effect

	Opens the Sources menu. Touch to select a different media source. Indicates the media source currently selected. Touch to change the media source.  CD : internal CD drive ⇒ page 25.  SD card : memory card ⇒ page 26.  A  USB : external data storage device connected to USB port ⇒ page 26.  AUX : external audio source connected to AUX-IN socket ⇒ page 27.  BT audio : external media player connected via Bluetooth® ⇒ page 28.
	Touch the function button to open the parent folder of the current folder on the media source. The name of the current folder will be displayed to the right of the symbol.
	Starts playback at the first track.
	Repeats all tracks.
	All tracks on the same memory level as the current track will be repeated. If <input checked="" type="checkbox"/> Mix/repeat including subfolders is activated in Media setup subfolders are also included ⇒ page 28.
	Repeat current track.
	Random play.
	All tracks on the same memory level as the current track are included. If <input checked="" type="checkbox"/> Mix/repeat including subfolders is activated in Media setup subfolders are also included ⇒ page 28.
	When the scan function is running, all tracks in the current track list are played for approximately 10 seconds each.
	Closes track list.
	Tracks, folders and playlists can also be marked by turning the setting knob then loaded or opened up or opened by pressing the knob. <

Inserting or ejecting a CD

 **First read and observe the safety warnings**  **on page 3 and the introductory information on page 20.**

The internal CD drive can play audio CDs and audio data CDs.

When an audio CD without CD text is playing, only **TITLE** and the track number, corresponding to the playing order on the data medium, are displayed in the centre line of the screen.

If the audio file CDs played contain additional track information (CD text , ID3 tag for MP3 files), it can be displayed on the screen.

Inserting a CD

- Hold the CD with the printed side facing up.
- Push the CD into the CD slot only to the point where it is drawn in automatically.
- When the CD is inserted, playback will start automatically.

Ejecting a CD

In some countries, the vehicle key must be in the ignition lock of a cabriolet vehicle in order to eject a CD (anti-theft protection).

- Press the **[EJECT]** infotainment button.
- The CD in the drive will be ejected and must be removed within approximately 10 seconds.

For safety reasons, the CD will be drawn back into the player if it is not removed within roughly 10 seconds, but the unit will not switch to CD mode.

CD cannot be read or is faulty



A message will be shown on the screen if the data on an inserted CD cannot be read or the CD is faulty.

 Uneven road surfaces and strong vibrations can cause playback to jump. ▶

 When the temperature inside the infotainment system is too high, loading and playback of CDs is disabled.

 If you insert a number of different CDs and receive the message **Error: CD drive** every time, contact a qualified workshop. <

Inserting or removing a memory card

 **First read and observe the safety warnings  on page 3 and the introductory information on page 20.**

Only supported audio files are displayed and played. Other files are ignored.

Inserting a memory card

Fig. 1 



Vertical card slot	Insert a compatible memory card into the memory card slot with the cut-off corner first and the lettering facing left (contact surfaces facing down) until the card clicks into place.
Horizontal card slot	Insert a compatible memory card into the memory card slot with the cut-off corner first and the label facing up (contact surfaces facing down) until the card clicks into place.

If a memory card cannot be inserted, ensure that it is positioned correctly and is compatible with the unit.

Playback starts automatically if supported audio files are stored on the memory card.

Removing a memory card

The inserted memory card **must** be prepared for removal.

- In the **MEDIA** main menu touch the  function button to open the **Media setup** menu.
- **OR:** press the **SETUP** infotainment button.
- Touch the **Remove the SD card safely** function button.
- **OR:** touch the **Remove safely** function button and then select .

Once the memory card has been ejected from the system, a message is shown on the screen and the function button is greyed out. The memory card can then be removed.



- Press the inserted memory card. The memory card springs out of the slot.
- Remove the memory card.

Memory card cannot be read

If you insert a memory card containing data that cannot be read, the unit will **not** change to memory card mode after loading.

A corresponding message is displayed. <

External data storage device connected to USB port

 **First read and observe the safety warnings  on page 3 and the introductory information on page 20.**



In some countries and with some equipment levels, the vehicle may be fitted with a USB connection  in the stowage compartment in the centre console. \Rightarrow Booklet *Owner's Manual*, chapter *Practical equipment*.

Only supported audio files are displayed and played. Other files are ignored.

Playback starts automatically if supported audio files are stored on the data storage device.

Removing

The connected storage device **must** be prepared before removal.

- In the **MEDIA** main menu, touch the  function button to open the **Media setup** menu.
- **OR:** press the **SETUP** infotainment button.
- Touch the **Remove safely** function button and then select .

Data media cannot be read

The message **No playable files available** appears if the data on the connected storage device cannot be read. ▶

 Please read and observe the manufacturer's manual for the external storage device.

External audio source connected to the AUX-IN socket



Fig. 21 MEDIA main menu

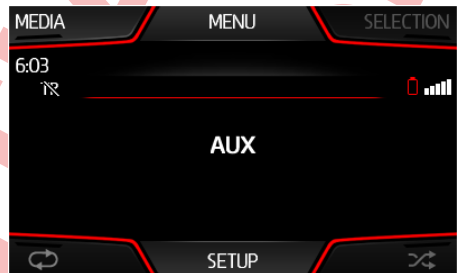





Fig. 22 External audio source connected to AUX-IN

 First read and observe the safety warnings  on page 3 and the introductory information on page 20.

The AUX-IN socket \Rightarrow Fig. 1  can only be used with a 3.5 mm jack plug.

The connected external audio source is played over the vehicle speakers and **cannot** be controlled via the infotainment system.

AUX shows on the screen when an external audio source is connected \Rightarrow Fig. 22.

Connecting an external audio source to the AUX-IN socket

- Reduce the base volume on the infotainment system.
- Connect the external audio source to the AUX-IN socket.

- Start playback on the external audio source.
- In the *MEDIA* main menu, touch the  function button and select **AUX**. \Rightarrow Fig. 21

The **output volume** of the external audio source should be adjusted to the volume of the other audio sources \Rightarrow page 42.

Information on operating an external audio source connected to the AUX-IN socket

Action	Effect
Selecting another audio source on the infotainment system.	The external audio source continues to run in the background.
Stopping playback on the external audio source.	The infotainment system remains in the AUX menu.
Disconnecting the plug from the AUX-IN socket.	The infotainment system switches to playback of the most recently played audio source.

 Please read and observe the manufacturer's manual for the external audio source.

 Interference may occur if the external audio source is powered from the vehicle's 12-volt socket.

Connecting an external audio source via Bluetooth®

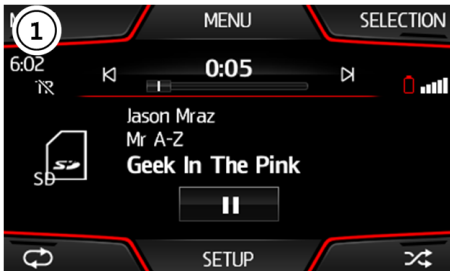





Fig. 23 MEDIA main menu



 First read and observe the safety warnings  on page 3 and the introductory information on page 20.

In Bluetooth® audio mode, audio files from a Bluetooth® audio source (e.g. mobile telephone) that is connected via Bluetooth® can be played over the vehicle loudspeakers (Bluetooth® audio playback).



Conditions

- The Bluetooth® audio source must support the A2DP Bluetooth® profile.
- The  Bluetooth audio (A2DP/AVRCP) function must be activated in the **Bluetooth setup** menu ⇒ page 39.

Starting Bluetooth® audio transfer

- Switch on Bluetooth® visibility on the external Bluetooth® audio source (e.g. mobile telephone).
- Reduce the base volume on the infotainment system.
- Press the **MEDIA** infotainment button.
- Touch the  function button and select .

Media settings

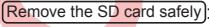

 First read and observe the safety warnings  on page 3 and the introductory information on page 20.

Function button: effect

: memory card is ejected from the system and can then be safely removed ⇒ page 26.

: sound settings ⇒ page 42.

: opens the **Bluetooth setup** menu ⇒ page 39. ▶

- Touch the  function button to connect an external Bluetooth® audio source for the first time.
- **OR:** touch the  function button to select an external Bluetooth® audio source from the list.
- Continue the process by following the prompts on the infotainment system screen and in the display on the Bluetooth® audio source.

You may then have to start playback on the Bluetooth® audio source manually.

When playback on the Bluetooth® audio source is stopped, the infotainment system remains in Bluetooth® audio mode.

Controlling playback

The extent to which the Bluetooth® audio source can be controlled via the infotainment system varies depending on what Bluetooth® audio source is connected.

With media players that support the AVRCP Bluetooth® profile, playback on the Bluetooth® audio source can be automatically started or stopped when the unit is switched to Bluetooth® audio mode or to a different audio source. In addition, track display or track change is possible via the infotainment system.

 Due to the large number of possible Bluetooth® audio sources, it is not possible to guarantee fault-free operation of all described functions.

 Always switch off the warning and service tones on a connected Bluetooth® audio source, e.g. key tones on a mobile telephone, to prevent interference noise and malfunctions. ◀

Function button: effect

Traffic program (TP): the TP function (traffic news monitoring) is activated ⇒ page 12.

Mix/Repeat including subfolders: subfolders will be included in the selected playback mode ⇒ page 22.

Remove safely: disconnect data storage device (USB storage device or SD card) from the system. Once the storage device has been ejected from the system the respective function button is greyed out. <

Telephone control (PHONE)

Introduction to telephone control system

Introduction

This chapter contains information on the following subjects:

General information	31
Areas where special regulations apply	31
Bluetooth®	31
Pairing and connecting mobile telephone on the infotainment system	32
Switching telephone control system off	33

The telephone functions described in the following section can be controlled via the infotainment system if a mobile telephone that is switched on is paired and connected with the infotainment system.

The mobile telephone must support the **Bluetooth® function** otherwise a connection cannot be made between the telephone and the infotainment system.

If a mobile telephone is not connected to the infotainment system, the telephone control system cannot be used.

Observe the notes on using a mobile telephone in the vehicle without a connection to the external aerial ⇒ Booklet *Owner's manual*.

Additional information and warnings:

- Safety information  for infotainment system ⇒ page 3
- Overview of the control elements ⇒ page 6
- Basic information on use ⇒ page 7

WARNING

Making telephone calls and operating the telephone control system while the vehicle is in motion can distract you from the road and lead to accidents.

- Always drive carefully and responsibly.
- Select volume settings that allow signals from outside the vehicle (such as emergency services sirens) to be easily heard at all times.
- Your call may be cut off or you may be unable to make calls if you are in an area with no mobile telephone network coverage, an

WARNING (Continued)

area where the network is very weak or, in some cases, in a tunnel, garage or underpass. This also means that no emergency calls can be made.

WARNING

If a mobile telephone is not secured or is incorrectly secured in the vehicle, it could be flung through the interior during a sudden driving or braking manoeuvre, or in the event of an accident. This can cause injuries.

- While the vehicle is in motion, always secure the mobile telephone properly outside the airbag deployment area.

WARNING

Carrying a mobile telephone that is switched on just next to a pacemaker may cause the pacemaker to malfunction.

- Maintain a gap of approximately 20 centimetres between the aerials of the mobile telephone and the pacemaker, as mobile telephones may affect the functioning of pacemakers.
- Do not carry a mobile telephone in your breast pocket above your pacemaker when the telephone is switched on or in standby mode.
- If you suspect interference, switch off the mobile telephone immediately.

WARNING

The centre armrest may obstruct the driver's arm movements if raised, which could cause accidents and severe injuries.

- Always keep the armrest down while the vehicle is in motion.

NOTICE

High speeds, poor weather and poor road conditions as well as the network quality may impair telephone calls in the vehicle.

General information



First read and observe the introductory information and safety warnings  on page 30.

How the individual telephone menus are displayed depends on the mobile telephone being used. There may be differences.

Observe the notes on using a mobile telephone in the vehicle without a connection to the external aerial ⇒ Booklet *Owner's manual*, chapter *Vehicle care and maintenance*.

Use compatible Bluetooth® devices only. Information on compatible Bluetooth® products is available from your Volkswagen dealership or online.

Follow the operating manual for your mobile telephone and the instructions provided by the accessory manufacturer.

You may experience poor reception or may be cut off in areas where the signal is weak.

Most electronic devices are shielded against high-frequency signals. In rare cases, however, electronic devices may not be shielded against high-frequency signals emitted by the telephone control system. This can cause interference.



There may be restrictions on the use of Bluetooth® devices in some countries. Information is available from the local authorities.



When connecting the telephone control system with a device using Bluetooth®, read the device's operating manual for detailed safety information. Use compatible Bluetooth® products only. 

Areas where special regulations apply



First read and observe the introductory information and safety warnings  on page 30.

Switch off the mobile telephone and mobile telephone provision in areas with a risk of explosion. These areas are often clearly marked, but not always ⇒  in *Introduction* on page 30. They include, for example:

- Areas immediately around chemical pipelines and tanks.
- Lower decks of ships and ferries.
- The area around vehicles which run on liquid gas (such as propane or butane).
- Places where there are chemicals or particles such as flour, dust and metal powder in the air.
- All other places where the vehicle engine must be switched off.



WARNING

Switch off the mobile telephone in areas with a risk of explosion!



NOTICE

Your mobile telephone must always be switched off in areas where special regulations apply and when the use of mobile telephones is forbidden. The radiation produced by the mobile telephone when switched on may interfere with sensitive technical and medical equipment, possibly resulting in malfunction or damage to the equipment. 

Bluetooth®



First read and observe the introductory information and safety warnings  on page 30.

Bluetooth®

Bluetooth® technology is used to connect a mobile telephone to the telephone control system fitted in a vehicle. A pairing process has to be carried out before the telephone control system can be used with a Bluetooth® mobile telephone. 

Some Bluetooth® mobile telephones are detected and connected automatically when the ignition is switched on, if a connection already exists. For this to happen, the mobile telephone itself and the Bluetooth® function in the telephone must be switched on and all active Bluetooth® connections to other units must be disconnected.

The Bluetooth® connection is free of charge.

Bluetooth® is a registered trademark of Bluetooth® SIG, Inc.

Bluetooth® profiles

When a mobile telephone is connected to the telephone control system, data is exchanged via one of the Bluetooth® profiles.

Basic telephony Bluetooth® Hands-Free Profile (HFP):

- If a mobile telephone is connected via HFP to the telephone control system, you can make calls wirelessly via the hands-free system. The vehicle's exterior aerial *cannot* be used with this. Observe the notes on using a mobile telephone in the vehicle without a connection to the external aerial ⇒ Booklet *Owner's manual*.

Music playback Bluetooth® Advanced Audio Distribution Profile (A2DP):

- Bluetooth® profile for the transmission of stereo-quality audio signals.

Playback controls Bluetooth® Audio Video Remote Control Profile (AVRCP):

- Bluetooth® profile for displaying track information and control of playback in the mobile device. ◀

Pairing and connecting mobile telephone on the infotainment system

 **First read and observe the introductory information and safety warnings** ⚠ on page 30.

In order to operate a mobile telephone via the infotainment system, a **single** pairing process is required for both devices.

Pairing should only be performed when the vehicle is stationary.

Conditions

- Ignition is switched on.
- If necessary, disconnect any headsets from the mobile telephone.
- The **Bluetooth® function** must be activated or set to visible on the mobile telephone and on the infotainment system.
- The **keypad lock** on the mobile telephone has to be unlocked.

Follow the operating manual for the mobile telephone.

The **Bluetooth® function** is set to visible on the infotainment system for about 3 minutes after the ignition is switched on.

Entries have to be made on the mobile telephone keypad during the pairing process. The mobile telephone has to be at hand for this.

Starting mobile telephone pairing

- Press the **PHONE** infotainment button.
- Touch the **Find telephone** function button.

OR:

- Press the **PHONE** infotainment button.
- Touch the **Setup** function button.
- Touch the **Select telephone** function button and then **Find telephone**.

Once the search process is complete, the names of all Bluetooth® devices found will be displayed on the screen.

- Select the mobile telephone to be paired from this list of Bluetooth® devices and then select **Hands-free telephone (HFP)**.

The infotainment system and the mobile telephone are now connected. Further input may be required on the mobile telephone and on the infotainment system to conclude the connection process. ▶

- If necessary, confirm the pairing on the mobile telephone.

Depends on the mobile telephone:

- Enter the PIN code that is then displayed on the infotainment system into the mobile telephone and confirm it.

OR:

- Compare the PIN code displayed on the infotainment system with the PIN code displayed on the mobile telephone. If the PIN code matches, it has to be confirmed on **both** devices.

The *PHONE* main menu is displayed and the telephone book and the call lists stored in the mobile telephone are loaded automatically once pairing has been completed. The time taken by the loading process varies depending on the amount of data stored in the mobile telephone. This data is available on the infotainment system once the loading process is completed.

Pairing and connecting mobile telephones



Several mobile telephones can be paired with the infotainment system, but only **one** mobile telephone can be connected to the infotainment system at a time.

When you switch the infotainment system on, a connection is automatically set up with the mobile telephone that was connected last. If no connection can be set up with this mobile telephone, the telephone control system automatically attempts to set up a connection with the next mobile telephone in the list of paired devices.

Bluetooth® connections have a **maximum** range of **10 metres**. Any active Bluetooth® connection is interrupted when this distance is exceeded. The connection is **automatically** restored as soon as the device enters the Bluetooth® range.

 You will find further information on pairing and connecting mobile telephones on the Internet at www.volkswagen.com. ◀

Switching telephone control system off

 **First read and observe the introductory information and safety warnings  on page 30.**

- Switch off the ignition.
- Remove the vehicle key from the ignition lock. The telephone control system is switched off and any active call is transferred to the mobile telephone.

The telephone control system is **not** switched off if the vehicle key is left in the ignition lock after the engine is switched off. Once a set time has ex-

pired, a message appears on the infotainment system screen informing you that the telephone control system will be switched off automatically. An active call will be transferred to the mobile telephone.

 The transfer of an active call from the telephone control system to the mobile telephone can take up to approximately 10 seconds (depending on the mobile telephone being used). ◀

Description of telephone control system

Introduction

This chapter contains information on the following subjects:



PHONE main menu	34
During a telephone call	35
Entering a telephone number	36
Telephone book menu (Contacts)	36
Call lists menu	37
Speed dial buttons	38
Telephone settings	38
Bluetooth settings®	39
User profile settings	39

Some functions and settings are only available when the vehicle is stationary, and are not supported by all mobile telephones.

The range of possible settings depends on the country, the unit and the vehicle's equipment specification.

Up to 20 devices can be linked to the telephone control system. One device at a time can be connected via the hands-free profile (HFP) or audio playback profile (A2DP) ⇒ page 33.

Additional information and warnings:

- Safety information  for infotainment system ⇒ page 3
- Overview of the control elements ⇒ page 6
- Basic information on use ⇒ page 7
- Introduction to and safety information  for telephone control system ⇒ page 30

 Using a mobile telephone in the vehicle may cause noise from the vehicle speakers.

 Some networks might not support all language-dependent characters and services. ▶

PHONE main menu

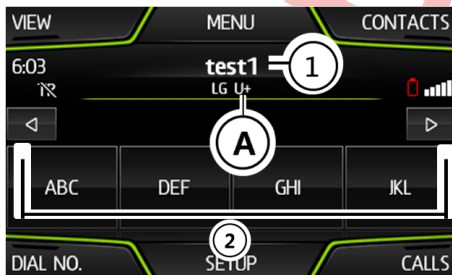

Fig. 24 PHONE main menu

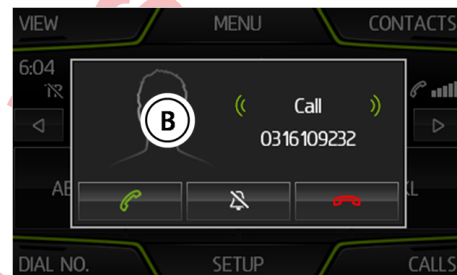

Fig. 25 Incoming call

 **First read and observe the introductory information given on page 34.**

Assignment to a user profile

Telephone book data, call lists and stored speed dial buttons are assigned to a user profile and stored in the telephone control system. They are available when the mobile phone is connected with the telephone control system again.

If, while connected to the radio, telephone book entries on the mobile telephone are changed, you can start a manual update of the telephone book









data via the **User profile setup** menu ⇒ page 39. The telephone book will be automatically updated when the telephone is connected again (e.g. on the next journey).

A **maximum of 4 user profiles** can be stored for mobile telephones in the telephone control system. If another mobile telephone is connected, the user profile which has not been used for the longest amount of time will be deleted automatically.

Telephone control function buttons





- Press the **PHONE** infotainment button to open the *PHONE* main menu. ▶

Function button: effect

	Name of the paired mobile telephone or the user profile in use. Touch to connect or pair another mobile telephone.
	Speed dial buttons which can be used to store one telephone number from the telephone book each ⇒ page 38.
	Opens the keypad to enter a telephone number ⇒ page 36.
	Opens the telephone book in the paired mobile telephone ⇒ page 36.
	Opens the call lists in the paired mobile telephone ⇒ page 37.
	Opens the Telephone setup menu ⇒ page 38.
	Touch to accept a call.
	Touch to end a call. OR: touch to reject an incoming call.
	Touch to mute the ring tone during a call or to switch the mute off.

Telephone control displays and symbols

Display: meaning

	The name of the mobile telephone network provider where the inserted SIM card or the SIM card of the paired mobile telephone is registered.
	Displays the telephone number or the stored name.
	The charge level of the paired mobile telephone.
	The signal strength of the current mobile telephone transmitter station.

During a telephone call

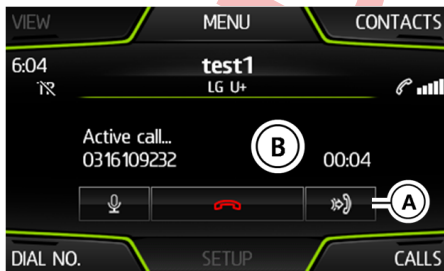









First read and observe the introductory information given on page 34.

When a connection is made to a dialled telephone number, the *PHONE* main menu changes to the *telephone call view* ⇒ Fig. 26.

Fig. 26 During a telephone call

Displays and function buttons: action and effect

	Touch to make the call on the mobile telephone provision.
	Touch to switch off the microphone in the mobile telephone provision during a call ( function button changes to ). The conversation in the vehicle cannot be heard at the other end.  appears on the display  .
	Touch the  function button to switch on the microphone in the mobile telephone provision again.
	Touch to end a call.

Displays and function buttons: action and effect

- ☎: call is being made with the connected mobile telephone. Touch the ☎ function button to make the call on the mobile telephone provision.
- (A) 🎤: the microphone in the provision for mobile telephone is switched off.
- 🔋: charge level of the paired mobile telephone.
- (B) ⌚: Display of call duration and telephone number or the stored name.

a) This function button is only displayed when the call is made on the mobile telephone.

Entering a telephone number



First read and observe the introductory information given on page 34.

In the *PHONE* main menu, press the ☎ function button.

Fig. 27 Entering a telephone number

Possible functions

Entering a telephone number

Enter the telephone number on the keypad.
Touch the ☎ function button to dial the number.

Selecting a contact from a list

Enter the first letters of the required contact on the keypad. Possible entries appear in the contact list.
Browse through the contact list and touch the desired contact to make the call.

Telephone book menu (Contacts)



Fig. 28 Contacts menu

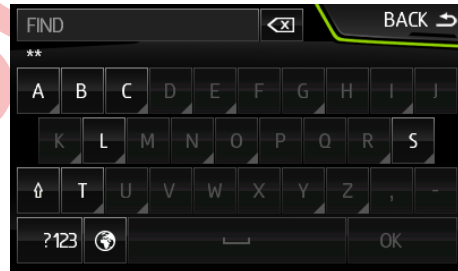

Fig. 29 Search window



First read and observe the introductory information given on page 34.

It may take a few minutes after the first pairing process until the telephone book data¹⁾ from the paired mobile telephone is available on the infotainment system. The process could take up to an hour, depending on the amount of data to be transferred. If necessary, confirm the transfer on the mobile telephone.

The telephone book can also be opened during an on-going telephone call.

In the *PHONE* main menu, press the  function button.

Possible functions





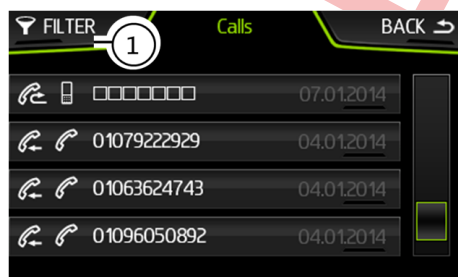

Selecting a contact from a list	Browse through the list and touch the desired contact to make the call. OR: if several numbers are allocated to the same contact, first touch the contact and then the desired number to make the call.
Finding a contact in the search window	Touch the  ⇒ Fig. 28 function button to open the search window. Enter the name you are looking for in the search window ⇒ Fig. 29. The number of matching results is displayed to the right of the entry field. Touch the function button to go to the list view. Browse through the list and touch the desired contact to make the call.

 Availability of telephone book menu depends on the mobile telephone being used. <

Call lists menu









 **First read and observe the introductory information given on page 34.**

- In the *PHONE* main menu, press the  function button.
- Touch the  ⇒ Fig. 30 ① function button.
- Select the desired call list: , ,  or .

If a telephone number is already stored in the telephone book, the stored name is displayed in the call list instead of the telephone number.

Fig. 30 Call list menu

Possible displays in the call menu

Display	Meaning
	 Missed calls : shows telephone numbers of missed and unanswered calls.
	 Dialled numbers : shows telephone numbers that were dialled on the mobile telephone and the infotainment system telephone control system.
	 Received calls : shows all telephone numbers that were received on the mobile telephone and on the infotainment system via the telephone control system.

 Availability of call lists depends on the mobile telephone being used. <

¹⁾ Depending on what device is used, only contacts from the telephone memory may be loaded.

Speed dial buttons



Fig. 31 PHONE main menu

Possible functions

Assigning speed dial buttons	In the <i>PHONE</i> main menu, touch a free speed dial button. Select the desired contact from the list. If several telephone numbers are stored for the selected contact, select the desired number.
Editing assigned speed dial buttons	In the <i>PHONE</i> main menu, <i>press and hold</i> an assigned speed dial button until the <i>Contacts</i> menu opens. Select the desired contact from the list. If several telephone numbers are stored for the selected contact, select the desired number. To close the <i>Contacts</i> menu without applying changes, touch the  function button.
Deleting assigned speed dial buttons	Any telephone number stored on a speed dial button can be deleted in the User profile setup menu → page 39.
Dialling with speed dial buttons	In the <i>PHONE</i> main menu, <i>briefly touch</i> an assigned speed dial button to dial the telephone number stored to that button.

 Contacts stored to the speed dial buttons are not updated automatically. If a contact stored to a speed dial button is modified on the mobile telephone, the speed dial button must be assigned again.



Telephone settings

 **First read and observe the introductory information given on page 34.** In the *PHONE* main menu, touch the  function button.

Function button: effect

 **Hands-free[®]**: the hands-free function is activated. Touch the function button during a telephone call to make the call on the mobile telephone.

 **Select telephone**: select the mobile telephone from the list view to connect it to the infotainment system.

 **Find telephone**: touch to connect a new mobile telephone.

 **Bluetooth**: opens the **Bluetooth setup** menu → page 39.

Function button: effect

User profile: opens the **User profile setup** menu ⇒ page 39.

Select ring tone^{P)}: select the ring tone from the list of preset ring tones. The selected ring tone is played and stored when you leave the submenu.

- a) This function button is only active during a telephone call.
- b) Either the selected ring tone or the ring tone set in the mobile phone is sounded, depending on what mobile phone is being used. <

Bluetooth settings[®]



First read and observe the introductory information given on page 34.

In the *PHONE* main menu, touch the **Setup** function button and then **Bluetooth**.

Function button: effect

Bluetooth: touch to switch Bluetooth[®] off. All existing connections are ended.

Visibility: switch Bluetooth[®] visibility on and off.

Visible: Bluetooth[®] visibility is activated.

Not visible: Bluetooth[®] visibility is deactivated. The Bluetooth[®] visibility has to be switched on before a Bluetooth[®] device can be externally paired with the infotainment system.

Upon start: Bluetooth[®] visibility is deactivated approximately 3 minutes after the engine is started.

Name: to display or edit the device name. This name is displayed to other Bluetooth[®] devices in their Bluetooth[®] settings.

Paired devices: displays paired devices. Separating and connecting individual Bluetooth[®] devices and Bluetooth[®] profiles.

Find devices: finds Bluetooth[®] devices that are set to visible and are within the range of the infotainment system. The **maximum range** is approximately **10 metres**.

Bluetooth audio (A2DP/AVRCP): this function must be activated if you want to connect an external audio source to the infotainment system via Bluetooth[®] ⇒ page 28. <

User profile settings



First read and observe the introductory information given on page 34.

In the *PHONE* main menu, touch the **Setup** function button and then **User profile**.

Function button: effect

Manage favourites: to edit speed dial buttons.

Assigned speed dial button: touch to delete the stored number.

Unassigned speed dial button: touch to store a number from the address book to the speed dial button.

Sort by: set the sorting order for telephone book entries (**Last name** or **First name**).

Import contacts: touch to import the address book from the connected telephone or to update the previously imported address book.

Delete other profiles: to delete individual or all non-active user profiles. <

Settings

Menu and system settings (SETUP)

Introduction

This chapter contains information on the following subjects:

System settings main menu (Setup) 40

The range of possible settings depends on the country, the unit and the vehicle's equipment specification.

Additional information and warnings:

- Safety information  for infotainment system ⇒ page 3
- Overview of the control elements ⇒ page 6
- Basic information on use ⇒ page 7



System settings main menu (Setup)

 **First read and observe the introductory information given on page 40.**

- Press the **SETUP** infotainment button to open the **System setup** main menu.
- To adjust the settings for a certain function, touch the appropriate function button.

Function button: effect

Remove the SD card safely: ejects the memory card from the system. Once the memory card has been ejected from the system the function button is greyed out.

Sound: make sound and volume settings ⇒ page 42.

Screen: make screen settings.

Display off (in 10 s): when this function is activated, the screen switches off if no button is pressed on the infotainment system for about ten seconds. The screen is switched back on by touching the screen or pressing an infotainment button.

Brightness: select the brightness of the screen.

Confirmation tone: activates the confirmation tone that sounds when a function button is touched.

Show clock in standby mode: the screen shows the current time when the infotainment system is in standby mode.

Time and date: set the time and date.

Time: to set the current time.

Time format: select the format for the time display (12 or 24-hour).

Summer (DST): summer time is activated.

Date: set the current date.

Date format: to select the format for the date display (DD.MM.YY, YY-MM-DD or MM-DD-YY).

Language: select the desired language for text and voice output.

Keypad: select the required layout (alphabetical or keyboard layout).

More keypad languages: select additional keypad languages.

Units: sets units of measurement for displays in the vehicle.

Distance, Speed, Temperature, Volume, Consumption and Pressure.

Bluetooth: make settings relating to Bluetooth® ⇒ page 39.

Remove safely: disconnect data storage device (USB storage device or SD card) from the system. Once the storage device has been ejected from the system the respective function button is greyed out. ▶

Function button: effect

Factory settings: restoring the factory settings will **erase entered data and settings** depending on which option has been selected.

System information: displays the system information (serial number, hardware and software versions).

Copyright: copyright information.

 It is important that the correct date and time are set in the vehicle to ensure the infotainment system works properly.



Sound and volume settings

Introduction

This chapter contains information on the following subjects:

Adjusting settings 42

The range of possible settings depends on the country, the unit and the vehicle's equipment specification.

Additional information and warnings:

- Safety information  for infotainment system ⇒ page 3
- Overview of the control elements ⇒ page 6
- Basic information on use ⇒ page 7

Adjusting settings

 **First read and observe the introductory information given on page 42.**

Changes are automatically stored when a menu is closed.

- Press the **SOUND** infotainment button.
- **OR:** press the **SETUP** infotainment button and then select **Sound** to open the **Sound setup** main menu.
- To adjust the settings for a certain function, touch the appropriate function button.

Function button: effect

Bass - Mid - Treble: sets the tonal quality (Bass - Mid - Treble).

Balance or **Balance - Fader:** set the sound focus.

The crosshair shows the where the sound is currently focused in the car's interior. To move the sound focus, touch the required position on the interior view or use the arrow buttons to change the position. To place the focus of sound at the centre of the interior view, touch the function button between the arrows.

Volume: to make volume settings.

Max. switch-on volume: define the maximum volume at switch-on.

Announcements: to set the output volume for announcements (e.g. traffic announcements).

Speed-dep. vol. (GALA): define the scope of the speed-dependent volume control. The audio volume is automatically increased as the vehicle speed increases.

Audio lower: set how much the volume of the infotainment system should be reduced by when the ParkPilot is active.

AUX volume: to set the output volume for audio sources that are connected via the AUX-IN multimedia socket (**Quiet**, **Medium** or **Loud**). Please also refer to ⇒ page 42, *Adjusting playback volume of external audio sources*.

BT audio: to set the output volume for audio sources connected via Bluetooth® (**quiet**, **medium** or **Loud**). Please also refer to ⇒ page 42, *Adjusting playback volume of external audio sources*.

Confirmation tone: activates the confirmation tone that sounds when a function button is touched.

Adjusting playback volume of external audio sources

If you need to increase the output volume of an external audio source, first lower the base volume on the infotainment system.

If the sound from the external audio source is **too quiet**, increase the **output volume** on the external audio source if possible. If this is not sufficient, set the **input volume** to **Medium** or **Loud**.

If the sound from the connected external audio source is **too loud or distorted**, lower the **output volume** on the external audio source if possible. If this is not sufficient, set the **input volume** to **Medium** or **Quiet**.



CONFIDENTIAL
not for distribution

Abbreviations

Abbreviation	Definition
A2DP	Generic technology for the transmission of audio signals via Bluetooth® (Advanced Audio Distribution Profile).
AM	Amplitude modulation (medium wave, MW).
AUX-IN	Auxiliary audio input.
AVRCP	Universal technology for remote control of audio sources via Bluetooth® (Audio Video Remote Control Profile).
DIN	German Standards Authority (Deutsches Institut für Normung).
DRM	Digital rights management.
EON	Supporting of other networks (enhanced other network).
FM	Frequency modulation (very high frequency, VHF).
HFP	Wireless telephony (hands-free profile).
MP3	Format for compressing audio files.
RDS	Radio data system.
TP	Traffic news function (traffic program).
VBR	Variable bit rate.
WMA	Format for compressing audio files.



Index

A

AM	12
Areas where special regulations apply	31
AUX-IN	27
AUX-IN socket	27
External audio sources	27
Selecting	23
AUX-IN socket	27

B

Base volume	8
Adjusting	8
Muting	8
Bluetooth	
Profiles	31
Settings	39
Bluetooth audio	28
Browsing lists	9
BT audio	28
Buttons	8
Infotainment system	6

C

Call lists	37
CD	
Cannot be read	25
Ejecting	25
Faulty	25
Inserting	25
Mode	25
Selecting	23
Checkboxes	8
Control elements (infotainment system)	6
Copyright	20
Information	41
Cursor	10

D

Dialling a number	36
During a telephone call	35

E

Eject	
see CD	25
EON	17, 44
Explosion risk areas	
Telephone	31

External audio sources	27
Adjusting playback volume	42
BT audio	28

External data storage device	
USB	26

F

Factory settings	40
FM	12, 44
Frequency band	
AM	12
Changing	12
FM	12
Selecting	12
Function buttons	8
MEDIA main menu	22
Operating	8
Radio main menu	12
Function buttons (soft keys)	
PHONE main menu	34

G

GALA	42
-------------------	----

H

Hard keys	7
Hard keys (infotainment system)	6

I

Ignition off	
Switch-off delay (timeout)	7
Infotainment buttons	6, 7
Input window	10
Interference from a mobile telephone	7
Introduction	3

K

Keypad	10
---------------------	----

M

Main menu	
MEDIA	22
PHONE	34
RADIO	12
Settings (SETUP)	40
Sound	42
MEDIA	
AUX-IN socket	27
Bit rate	20

Bluetooth audio	28
CD audio data	20
CD cannot be read	25
CD faulty	25
CD mode	25
Changing media source	23
Changing tracks	24
Copyright	20
Displays	22
Displays and symbols	23
Ejecting a CD	25
External data storage device connected to	
USB port	26
Fast forward	24
Fast reverse	24
Function buttons	22
Inserting a CD	25
Inserting memory card	26
Main menu	22
Media mode	20
Media source selection menu	23
Memory card cannot be read	26
MP3 files	20
Playback modes	22
Playing order	21
Playlists	21
Preparing for removal	26
Random play (Mix)	22
Removing memory card	26
Repeat function (Repeat)	22
Requirements	20
Restrictions	21
Scan function (SCAN)	22
Selecting storage devices	23
Selecting track	24
Settings	28
Track information	23
Track list	24
WMA files	20
Media sources	
AUX-IN	23
CD	23
Memory card	23
Selecting	23
Memory card	
Cannot be read	26
Inserting	26
Preparing memory card for removal	26
Removing	26
Selecting	23
Muting	8
N	
Numbers	
Dialling	36

O

On-screen keypad	10
-------------------------	----

Operation

Additional display information	11
Adjusting the volume	8
Browsing lists	9
Checkboxes	8
Entries	10
Function buttons	8
Infotainment buttons	7
Input window	10
Muting	8
On-screen keypad	10
PHONE	30, 34
RADIO	12
Rotary/push knobs	7
Scrolling	9
Slider	9
Switching on and off	7
Touchscreen	8

P

PHONE

A2DP	31
Areas where special regulations apply	31
Bluetooth profiles	31
Bluetooth settings	39
Call lists	37
Connecting via infotainment system	32
Contacts	36
Description of functions	31
Dialling	36
Displays and symbols	35
During a telephone call	35
Entering telephone number	36
Explosion risk areas	31
Function buttons	34
General information	31
HFP	31
Main menu	34
Mobile telephone pairing	32
Pairing via infotainment system	32
Settings	38
Speed dial buttons	38
Telephone book	36
Telephone control	30
Telephone control system	34
User profile settings	39

Playback

AUX-IN	27
CD	25
External data storage device (USB)	26
MEDIA	22
Memory card	22
RADIO	12
Track	24

Pop-up windows	8	Scan function (SCAN)	
Q		MEDIA	22
Quick reference guide	3	RADIO	16
R		Screen	
RADIO	12	Operating	8
AM settings	18	Screen (infotainment system)	6
Display of station names	13	Scrolling	9
Displays and symbols	13	SD card	
EON	17	see Memory card	26
FM settings	18	Setting date	40
Frequency change	12	Settings	
Function buttons	12	AM	18
Main menu	12	Bluetooth	39
Radio mode	12	Defaults	40
Radio text	16	Factory settings	40
RDS	13	FM	18
Scan function (SCAN)	16	Main menu	40
Selecting stations	14	Media	28
Settings	18	Menu and system settings	40
Setting station frequency	14	PHONE	38
Setting stations	14	Radio	18
Station buttons	14	Sound	42
Station list	14	System	40
Station tracking via RDS	13	User profile	39
Stopping station name scrolling	16	Volumes	42
Storing stations	14	Setting time	40
TP (traffic program)	17	SETUP	
Traffic announcement (INFO)	17	see Settings	40
Traffic news	17	Slider	9
Radio text (RDS)	16	Soft keys	
Random play (Mix)	22	Infotainment system	8
RDS	13	MEDIA main menu	22
Automatic station tracking	13	Radio main menu	12
Radio text	16	Sound focus (balance, fader)	42
RDS Regional	13	Sound settings (treble, bass)	42
TP (traffic program)	17	Speed-dependent volume	42
Repeat	22	Speed dial buttons	38
Repeat function (Repeat)	22	Station buttons	14
Requirements for		Station names	13
CDs	20	Stations	
memory cards	20	Scan function (SCAN)	16
Rotary/push knobs	7	Selecting	14
Rotary/push knobs (infotainment system)	6	Setting	14
		Stopping station name scrolling	16
		Storing	14
		Station search	16
		Station tracking	13
		Switch-off delay (timeout)	7
		Switching off	7
		Switching on	7
S		T	
Safety information		Telephone control	
Infotainment system	3	see PHONE	30
SCAN			
Media	22		
Radio	16		

Telephone control system (PHONE)	
Switching off	33
Text input	10
Things to note	
AUX operation	27
Displays	11
Volume reduction	7
Timeout	7
Touchscreen (infotainment system)	6
TP (traffic program)	
EON	17
Switching on and off	17
Traffic announcement (INFO)	17
Track list	24
Traffic announcement (INFO)	17
Traffic news	
see TP (traffic program)	17
U	
Unit buttons	7
USB	
Connecting an external data storage device	26
Disconnecting	26
Not readable	26
User profile	
Settings	39
V	
VHF	
see FM	44
Volume	
Adjusting	8
Base volume	8
Determining for external audio sources	42
Speed-dependent volume increase (GALA)	42
Traffic announcements	42
Volume distribution (balance, fader)	42
Volume reduction	7