



PLASMA MONITOR OWNER'S MANUAL

**MODELS : MU-42PM11/12X/20
MU-50PM10/11/20**

Please read this owner's manual thoroughly before operating the Monitor.
Retain it for future reference.
Record model number and serial number of the Monitor.
See the label attached on the back of the Monitor and relate this information to your dealer if you ever require service.

Model Number :
Serial Number :

Warning



WARNING
RISK OF ELECTRIC SHOCK
DO NOT OPEN



WARNING:

TO REDUCE THE RISK OF ELECTRIC SHOCK DO NOT REMOVE COVER (OR BACK). NO USER SERVICEABLE PARTS INSIDE. REFER TO QUALIFIED SERVICE PERSONNEL.



The lightning flash with arrowhead symbol, within an equilateral triangle, is intended to alert the user to the presence of uninsulated "dangerous voltage" within the product's enclosure that may be of sufficient magnitude to constitute a risk of electric shock to persons.



The exclamation point within an equilateral triangle is intended to alert the user to the presence of important operating and maintenance (servicing) instructions in the literature accompanying the appliance.

WARNING:

TO PREVENT FIRE OR SHOCK HAZARDS, DO NOT EXPOSE THIS PRODUCT TO RAIN OR MOISTURE.

FCC NOTICE

• A Class B digital device

This equipment has been tested and found to comply with the limits for a Class B digital device, pursuant to Part 15 of the FCC Rules. These limits are designed to provide reasonable protection against harmful interference in a residential installation. This equipment generates, uses and can radiate radio frequency energy and, if not installed and used in accordance with the instructions, may cause harmful interference to radio communications. However, there is no guarantee that interference will not occur in a particular installation. If this equipment does cause harmful interference to radio or television reception, which can be determined by turning the equipment off and on, the user is encouraged to try to correct the interference by one or more of the following measures:

- Reorient or relocate the receiving antenna.
- Increase the separation between the equipment and receiver.
- Connect the equipment into an outlet on a circuit different from that to which the receiver is connected.
- Consult the dealer or an experienced radio/TV technician for help.

• Any changes or modifications not expressly approved by the party responsible for compliance could void the user's authority to operate the equipment.

CAUTION:

Do not attempt to modify this product in any way without written authorization from LG Electronics. Unauthorized modification could void the user's authority to operate this product.

COMPLIANCE:

The responsible party for this product's compliance is:
LG Electronics U.S.A., Inc
1000 Sylvan Avenue, Englewood Cliffs, NJ 07632
1-201-816-2000
<http://www.lgusa.com>

WARNING

TO REDUCE THE RISK OF FIRE AND ELECTRIC SHOCK, DO NOT EXPOSE THIS PRODUCT TO RAIN OR MOISTURE.

Safety Instructions

* Safety instructions have two kinds of information, and each meaning of it is as below.



WARNING The violation of this instruction may cause serious injuries and even death.



NOTES The violation of this instruction may cause light injuries or damage of the product.

⚠ Take care of danger that may happen under specific condition.



WARNING

- 1. Do not place the product in direct sunlight or near heat sources such as heat registers, stove and so on.**

This may cause a fire.

- 2. Do not use the product in damp place such as a bathroom or any place where it is likely to get wet.**

This may cause a fire or could give an electric shock.

- 3. Bend antenna cable between inside and outside building to prevent rain from flowing in.**

This may cause water damaged inside the product and could give an electric shock.

- 4. Earth wire should be connected.**

- If the earth wire is not connected, there is possible a danger of electric shock caused by the current leakage.
- If grounding methods are not possible, a separate circuit breaker should be employed and installed by a qualified electrician.
- Do not connect ground to telephone wires, lightning rods or gas pipe.

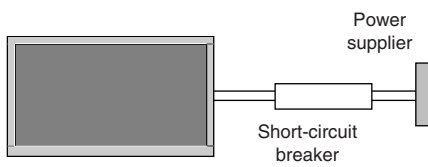

- 5. Do not placing anything containing liquid on top of the product.**

This may cause a fire or could give an electric shock.

- 6. Do not insert any object into the exhaust vent.**

This may cause a fire or could give an electric shock.

- 7. Do not place heavy objects on the product.**

This may cause serious injury to a child or adult.

- 8. Do not use water the product while cleaning.**

This may cause damaged the product or could give an electric shock.

- 9. In case of smoke or strange smell from the product, switch it off ,unplug it from the wall outlet and contact your dealer or service center.**

This may cause a fire or could give an electric shock.

- 10. Do not attempt to service the product yourself. Contact your dealer or service center.**

This may cause damaged the product or could give an electric shock.

- 11. During a lightning thunder, unplug the product from the wall outlet and don't touch an antenna cable.**

This may cause damaged the product or could give an electric shock.

Safety Instructions continued

NOTE

1. **Never touch the power plug with a wet hand.**

This may cause an electric shock.

2. **Disconnect from the mains and remove all connections before moving.**

3. **Do not place the product in a built-in installation such as a bookcase or rack.**

Ventilation required.

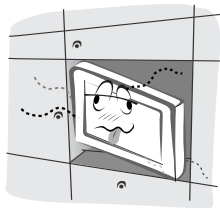

4. **When installing the product on a table, be careful not to place the edge of its stand.**

This may cause the product to fall, causing serious injury to a child or adult, and serious damage to the product.



5. **Do not place an outside antenna in the vicinity of overhead power lines or other electric light or power circuits.**

This may cause an electric shock.

6. **There should be enough distance between an outside antenna and power lines to keep the former from touching the latter even when the antenna falls.**

This may cause an electric shock.

7. **Do not pull the cord but the plug when unplugging.**

This may cause a fire.

8. **Ensure the power cord doesn't trail across any hot objects like a heater.**

This may cause a fire or an electric shock.

9. **Do not plug when the power cord or the plug is damaged or the connecting part of the power outlet is loose.**

This may cause a fire or an electric shock.

10. **Dispose of used batteries carefully to protect a child from eating them.**

In case that it eats them, take it to see a doctor immediately.

11. **When moving the product assembled with speakers do not carry holding the speakers.**

This may cause the product to fall, causing serious injury to a child or adult, and serious damage to the product.

12. **Unplug this product from the wall outlet before cleaning. Do not use liquid cleaners or aerosol cleaners.**

This may cause damaged the product or could give an electric shock.

13. **Contact the service center once a year to clean the internal part of the product.**

Accumulated dust can cause mechanical failure.

14. **The distance between eyes and the screen should be about 5 ~ 7 times as long as diagonal length of the screen.**

If not, eyes will strain.

15. **Unplug the product from the wall outlet when it is left unattended and unused for long periods of time.**

Accumulated dust may cause a fire or an electric shock from deterioration or electric leakage.

16. **Only use the specified batteries.**

This make cause damaged the product or could give an electric shock.

Contents

Warnings	2	Key Lock	23
Safety Instructions	3~4	ISM (Image Sticking Minimization) Method	23
Introduction		Low Power	24
Controls	7	XD Demo	24
Connection Options	8	Menu Rotation for Vertical Viewing	24
Remote Control Key Functions	9	Screen Menu Options	
Installation		Auto Adjustment	25
Installation Instructions	10~11	Setting Picture Format	25
External Equipment Connections	12~16	Screen Position	25
VCR Setup	12	Manual Configure	26
Cable TV Setup	12	Selecting VGA Mode	26
External A/V Source Setup	13	Screen Adjustments	26
DVD Setup	13	Cinema Mode Setup	26
DTV Setup / Monitor Out Setup	14	Luminance Noise Reduction	27
PC Setup	15~16	Initializing (Reset to original factory value)	27
		Split Zoom	27
Operation		PIP (Picture-In-Picture)/Double Window Feature	
Turning on the Monitor	17	Watching PIP/Double Window	28
Menu Language Selection	17	Swapping the PIP/Double Window	28
Picture Menu Options		TV Program selection for PIP	28
APC (Auto Picture Control)	18	Selecting an Input Signal Source for PIP/Double Window	28
XD	18	Moving the PIP(PIP Mode only)	28
Color Temperature Control	18	PIP Size	28
Fleshstone	19	PIP Transparency (PIP Mode only)	28
sRGB	19	External Control Device Setup	29~34
Manual Picture Control(Off option)	19	IR Code Information	35~36
Sound Menu Options		Troubleshooting Checklist	37
DASP (Digital Auto Sound Processing)	20	Maintenance	38
BBE	20	Specifications	38
AVL (Auto Volume Leveler)	20	Warranty	39~40
Manual Sound Control (Off option)	21		
Stereo/SAP Broadcasts Setup	21		
Timer Menu Options			
Clock Setup	22		
On/Off Timer Setup	22		
Auto Off / Sleep Timer	22		
Special Menu Options			

Setup and Operation Checklist

Setup and Operation Checklist
(See pages 11~15 for available connection and operational setup options.)

1. Unpack Monitor and all accessories.
2. Connect all external video and audio equipment.
see pages 11 ~ 15.
3. Install batteries in remote control.
See page 8.
4. Turn Monitor on.
See page 17.
5. Turn video source equipment on.
6. Select viewing source for Monitor.
See page 8.
7. Fine-tune source image and sound to personal preference
or as required by source.
See pages 18 ~ 21.
8. Additional features Setup
See Contents above.

After reading this manual, keep it handy for future reference.

Introduction

What is a Plasma Display Panel (PDP)?

If voltage is applied to gas within glass panels, ultraviolet rays are produced and fused with a fluorescent substance. At that instant, light is emitted. A Plasma Display is a next generation flat Display using this phenomenon.

160° - Wide angle range of vision

Your flat panel plasma screen offers an exceptionally broad viewing angle -- over 160 degrees. This means that the display is clear and visible to viewers who can see the screen anywhere in the room.

Wide Screen

The screen of the Plasma Display is 60" so wide that your viewing experience is as if you are in a theater.

Multimedia

Connect your plasma display to a PC and you can use it for conferencing, games, and internet browsing. The Picture-in-Picture feature allows you to view your PC and video images simultaneously.

Versatile

The light weight and thin size makes it easy to install your plasma display in a variety of locations where conventional TVs would not fit.

The PDP Manufacturing Process: Why minute colored dots may be present on the PDP screen

The PDP (Plasma Display Panel) which is the display device of this product is composed of 0.9 to 2.2 million cells. A few cell defects will normally occur in the PDP manufacturing process. Several minute colored dots visible on the screen should be acceptable. This also occurs in other PDP manufacturers' products and the tiny dots appearing does not mean that this PDP is defective. Thus a few cell defects are not sufficient cause for the PDP to be exchanged or returned. Our production technology is designed to minimize cell defects during the manufacture and operation of this product.

Cooling Fan Noise

In the same way that a fan is used in a PC computer to keep the CPU (Central Processing Unit) cool, the PDP is equipped with cooling fans to cool the Monitor and improve its reliability. Therefore, a certain level of noise could occur while the fans are operating and cooling the PDP.

The fan noise doesn't have any negative effect on the PDP's efficiency or reliability. The noise from these fans is normal during the operation of this product. We hope you understand that a certain level of noise from the cooling fans is acceptable and is not sufficient cause for the PDP to be exchanged or returned.

Controls

Front Panel Controls

- This is a simplified representation of a typical front panel.
The Front Panel Controls shown here may be somewhat different from your monitor.

MU-42/50PM10/11 series

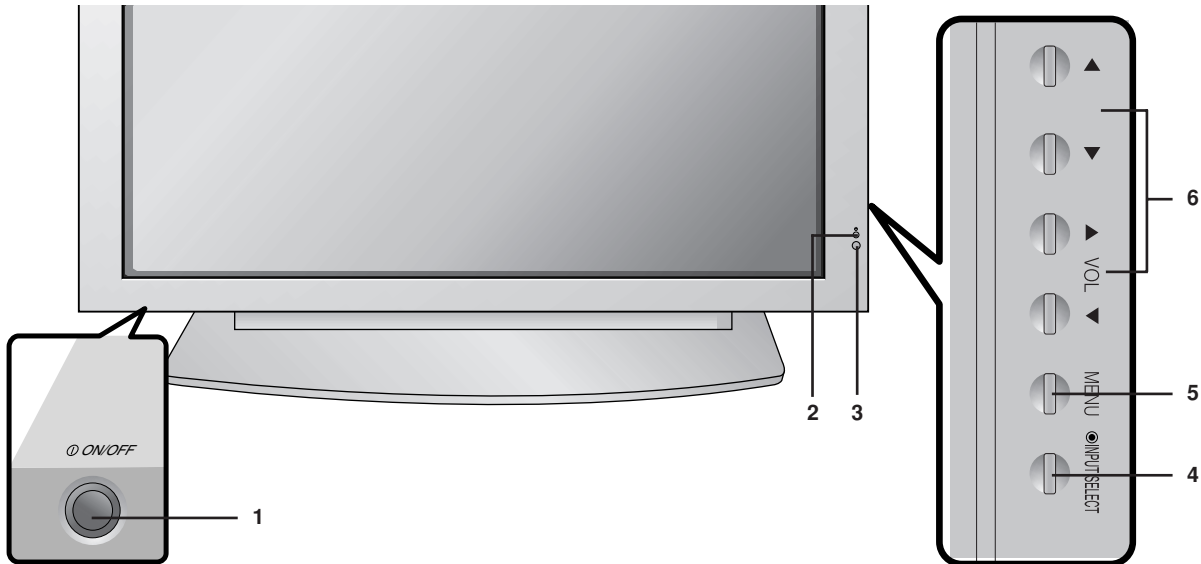

MU-42/50PM20 series

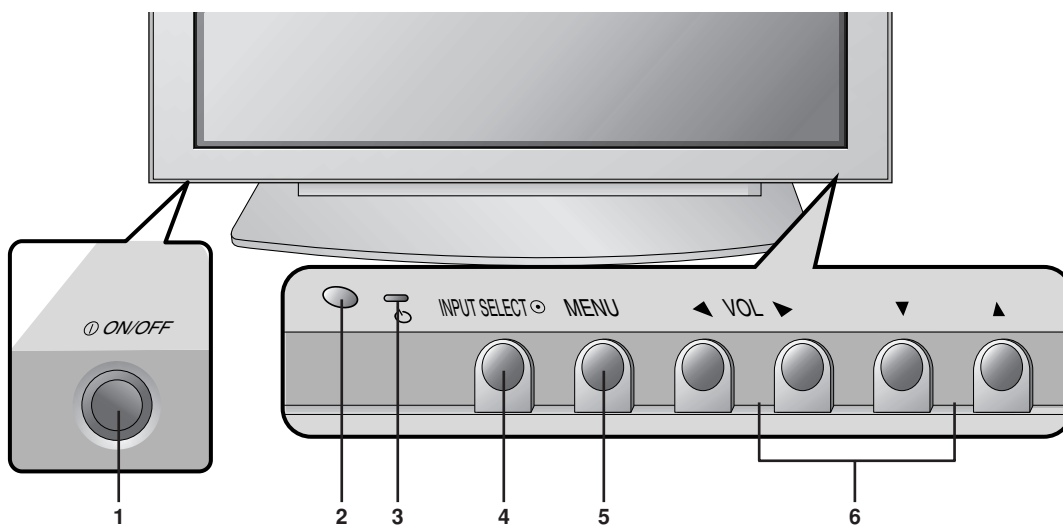

1. Main Power Button

2. Remote Control Sensor

3. Power Standby Indicator

Illuminates red in standby mode. Illuminates green when the Monitor is turned on.

4. INPUT SELECT Button

5. MENU

Displays on screen menus one by one.
Exits the current menu.
Memorizes menu changes.

6. ▲ / ▼

Selects a menu option.

◀ / ▶ (Volume Up/Down)

Increases/decreases sound level.
Adjusts menu settings.

Connection Options

Back Connection Panel

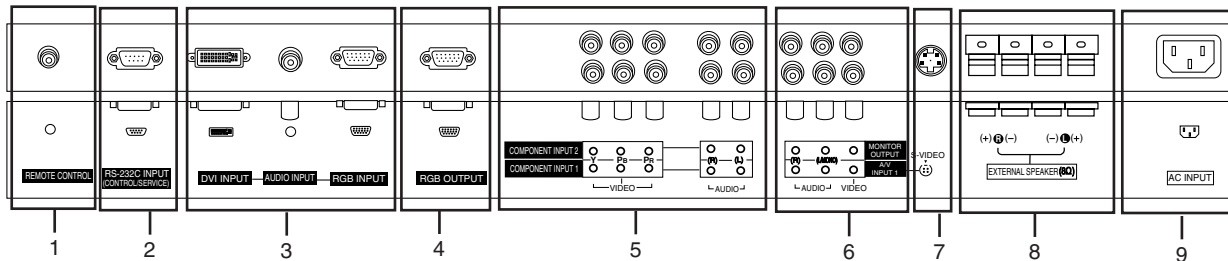
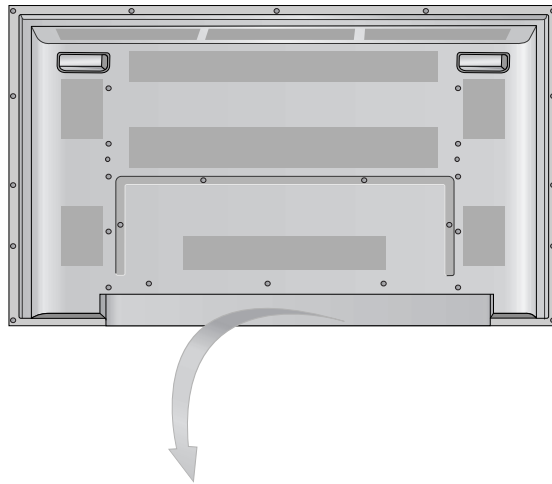

1. REMOTE CONTROL

Connect your wired remote control to the remote control port on the Monitor.

2. RS-232C INPUT (CONTROL/SERVICE) PORT

Connect to the RS-232C port on a PC.

3. DVI (Digital Visual Interface) INPUT/ AUDIO INPUT/ RGB INPUT JACKS

Connect the monitor output connector from a PC to the appropriate input port.

4. RGB OUTPUT PORT

You can watch the RGB signal on another monitor, connect RGB OUTPUT to another monitor's PC input port.

5. DVD/DTV Input (Component 1-2)

Connect a component video/audio device to these jacks.

6. Monitor Output

Connect a second TV or Monitor.

Audio/Video Input 1

Connect audio/video output from an external device to these jacks.

7. S-Video Input

Connect S-Video out from an S-VIDEO device to the S-VIDEO input.

8. EXTERNAL SPEAKER (8 ohm output)

Connect to optional external speaker(s).

* For further information, refer to 'Speaker & Speaker Stand' manual.

9. POWER CORD SOCKET

This Monitor operates on an AC power. The voltage is indicated on the Specifications page. Never attempt to operate the Monitor on DC power.

Remote Control Key Functions

- When using the remote control, aim it at the remote control sensor on the monitor.
- Under certain conditions such as if the remote IR signal is interrupted, the remote control may not function. Press the key again as necessary.

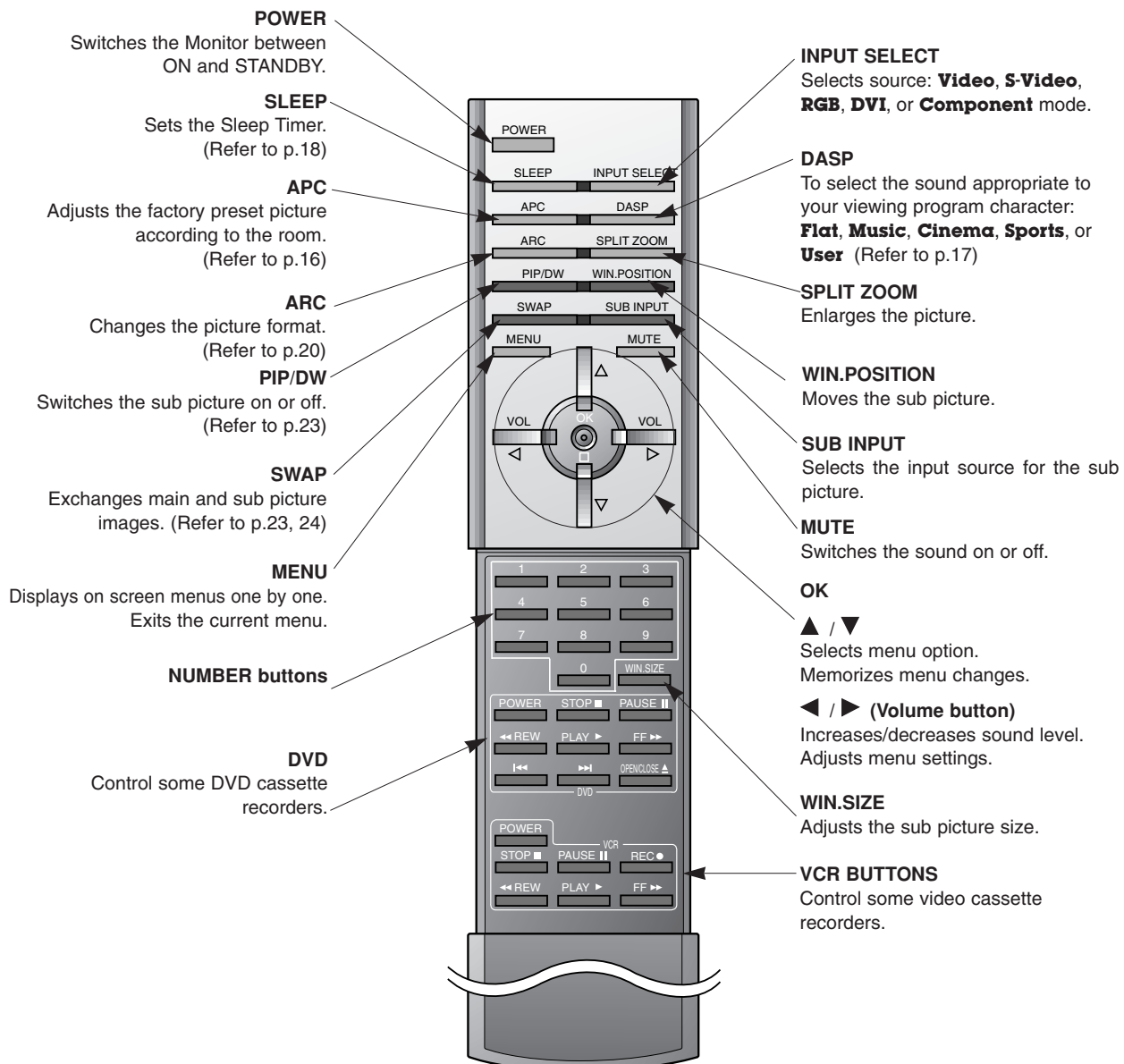

Installing Batteries

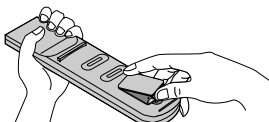

- Open the battery compartment cover on the back side and insert the batteries with correct polarity.
- Install two 1.5V alkaline batteries of AAA type. Don't mix used batteries with new batteries.

Installation

Ensure that the following accessories are included with your plasma display. If an accessory is missing, please contact the dealer where you purchased the product.

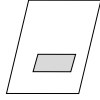

Owner's Manual

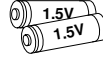

Alkaline Batteries



Power Cord



Remote Control

Installation Instructions

- The Monitor can be installed in various ways such as on a wall, or on a desktop etc.
- The plasma display is designed to be mounted horizontally or vertically. The speakers shown are optional.

GROUNDING

Ensure that you connect the grounding / earth wire to prevent possible electric shock. If grounding methods are not possible, have a qualified electrician install a separate circuit breaker. Do not try to ground the unit by connecting it to telephone wires, lightening rods, or gas pipes.

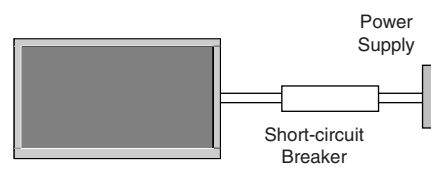

Installation Instructions continued

Wall Mount Installation

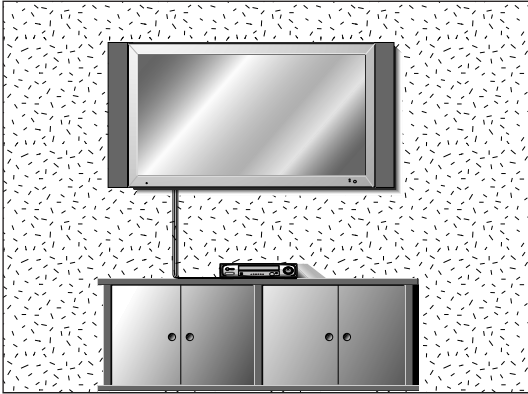

For proper ventilation, allow a clearance of 4" on each side and 2" from the wall. Detailed installation instructions are available from your dealer, see the optional Wall Mounting Bracket Installation and Setup Guide.

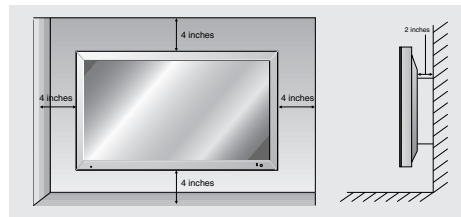

Desktop Pedestal Installation

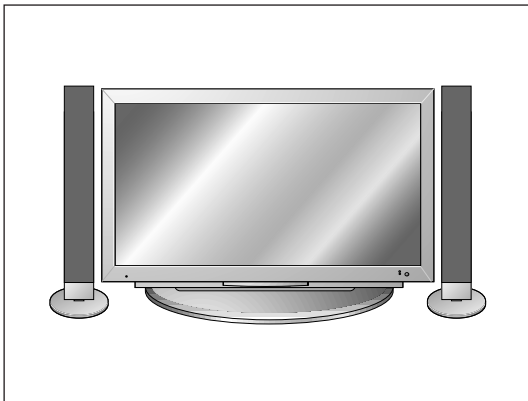

For proper ventilation, allow a clearance of 4" on each side and the top, 2.36" on the bottom, and 2" from the wall. Detailed installation instructions are included in the optional Desktop Stand Installation and Setup Guide available from your dealer.

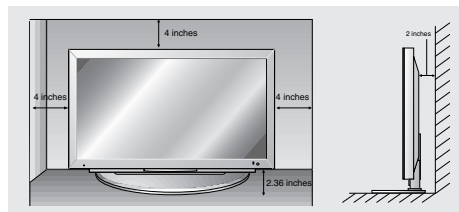

External Equipment Connections

NOTE: All cables shown are not included with the TV

VCR Setup

- To avoid picture noise (interference), leave an adequate distance between the VCR and TV
- Use the ISM Method (on the Option menu) feature to avoid having a fixed image remain on the screen for a long period of time. Typically a frozen still picture from a VCR. If the 4:3 picture format is used; the fixed images on the sides of the screen may remain visible on the screen.

Connection Option 1

Set VCR output switch to 3 or 4 and then tune TV to the same channel number.

Connection Option 2

1. Connect the audio and video cables from the VCR's output jacks to the TV input jacks, as shown in the figure.
When connecting the TV to VCR, match the jack colors (Video = yellow, Audio Left = white, and Audio Right = red).
If you connect an S-VIDEO output from VCR to the S-VIDEO input, the picture quality is improved; compared to connecting a regular VCR to the Video input.
2. Insert a video tape into the VCR and press PLAY on the VCR. (Refer to the VCR owner's manual.)
3. Select the input source with using the **INPUT SELECT** button on the remote control. (If connected to A/V INPUT 1, select **Video 1** input source)



Do not connect to both Video and S-Video at the same time. In the event that you connect both Video and the S-Video cables, only the S-Video will work.)

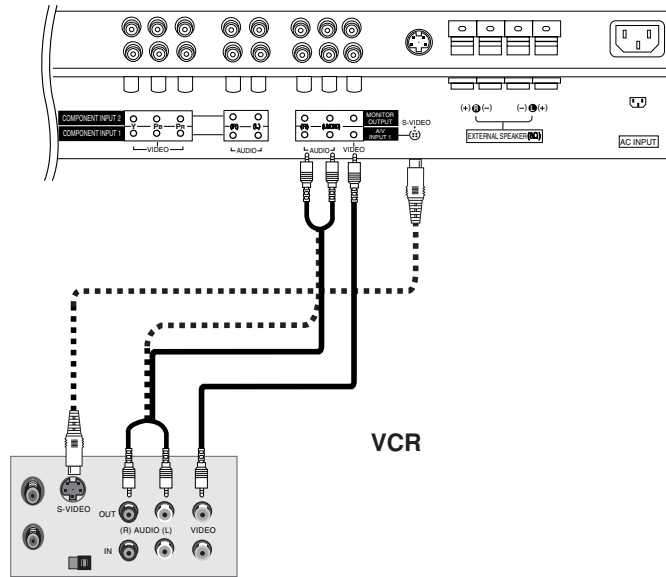

Cable TV Setup

- After subscribing to a cable TV service from a local provider and installing a converter, you can watch cable TV programming. The TV cannot display TV programming unless a TV tuner device or cable TV converter box is connected to the TV.
- For further information regarding cable TV service, contact your local cable TV service provider(s).

Connection Option 1

1. Select 3 or 4 with channel switch on cable box.
2. Tune the TV channel to the same selected output channel on cable box.
3. Select channels at the cable box or with the cable box remote control.

Connection Option 2

1. Connect the audio and video cables from the Cable Box's output jacks to the TV input jacks, as shown in the figure.
When connecting the TV to a Cable Box, match the jack colors (Video = yellow, Audio Left = white, and Audio Right = red).
2. Select the input source with using the **INPUT SELECT** button on the remote control. (If connected to A/V INPUT 1, select **Video 1** input source)
3. Select your desired channel with the remote control for cable box.

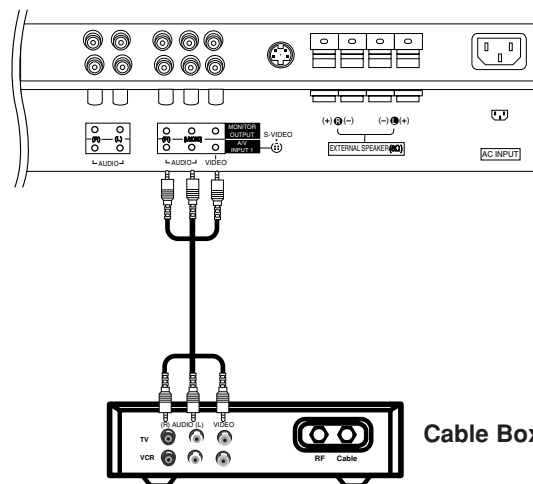

External A/V Source Setup

How to connect

Connect the audio and video cables from the external equipment's output jacks to the TV input jacks, as shown in the figure.

When connecting the TV to external equipment, match the jack colors (Video = yellow, Audio Left = white, and Audio Right = red).

How to use

1. Select the input source with using the **INPUT SELECT** button on the remote control. (If connected to A/V INPUT 1, select **Video 1** input source).
2. Operate the corresponding external equipment. Refer to external equipment operating guide.

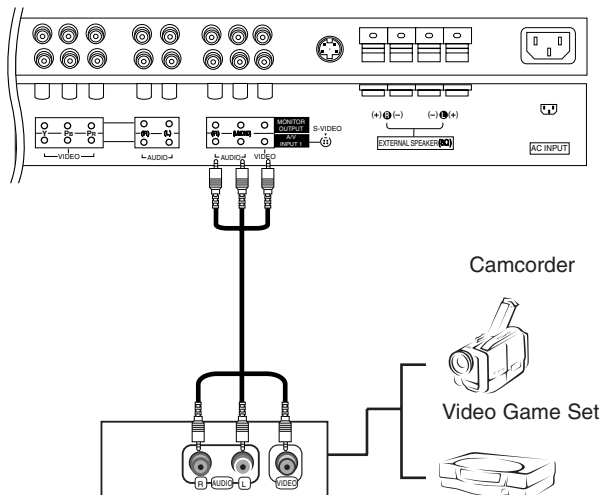

DVD Setup

How to connect

1. Connect the DVD video outputs (Y, P_B, P_R) to the COMPONENT (Y, P_B, P_R) INPUT jacks on the TV and connect the DVD audio outputs to the AUDIO INPUT jacks on the TV, as shown in the figure.
2. If your DVD only has an S-Video output jack, connect this to the S-VIDEO input on the TV and connect the DVD audio outputs to the AUDIO INPUT jacks on the TV, as shown in the figure.

NOTE: If your DVD player does not have component video output, use S-Video.

How to use

1. Turn on the DVD player, insert a DVD.
2. Use the **INPUT SELECT** or **MULTIMEDIA** button on the remote control to select **Component 1** or **Component 2**. (If connected to S-VIDEO, select the **Video 1** or **Video 2** external input source.)
3. Refer to the DVD player's manual for operating instructions.

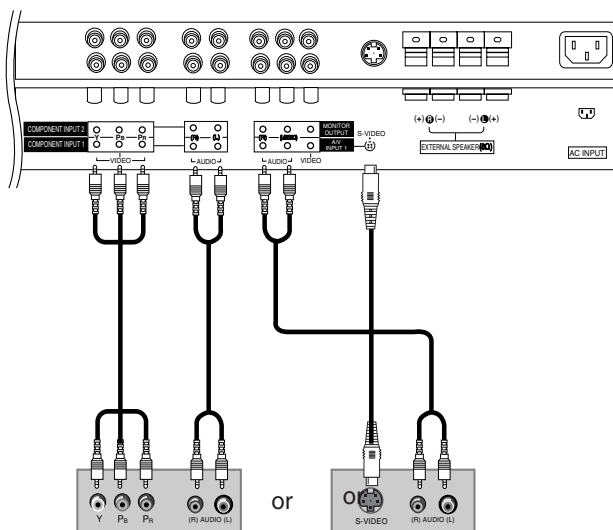

• **Component Input ports**

To get better picture quality, connect a DVD player to the component input ports as shown below.

Component ports on the TV	Y	P _B	P _R
Video output ports on DVD player	Y	P _B	P _R
	Y	B-Y	R-Y
	Y	Cb	Cr
	Y	P _B	P _R

DVD

DTV Setup

- To watch digitally broadcast programs, purchase and connect a digital set-top box.

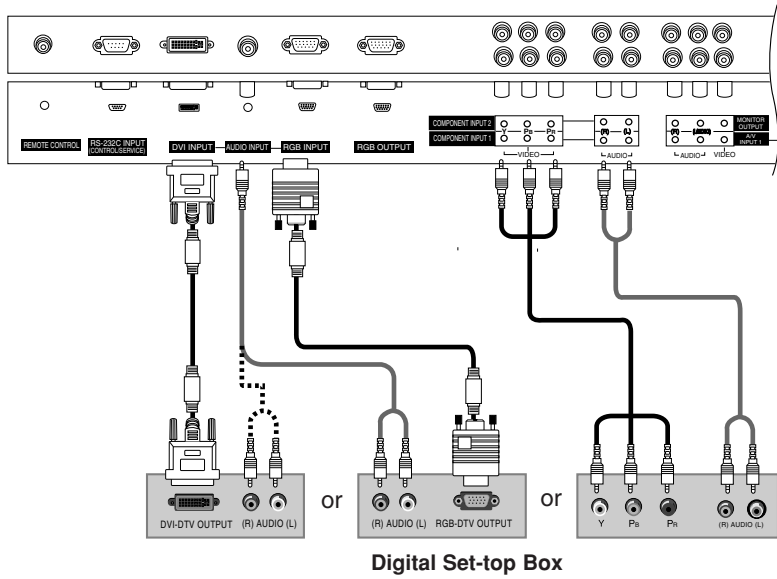

How to connect

Use the TV's COMPONENT (Y, Pb, Pr) INPUT, RGB or DVI jack for video connections, depending on your set-top box connector. Then, make the corresponding audio connections.

How to use

1. Turn on the digital set-top box. (Refer to the owner's manual for the digital set-top box.)
2. Use **INPUT SELECT** or **MULTIMEDIA** on the remote control to select **Component 1**, **Component 2**, **RGB**, or **DVI** source.

Signal	Component 1/2	RGB,DVI
480i	Yes	No
480p	Yes	Yes
720p	Yes	Yes
1080i	Yes	Yes

Monitor Out Setup

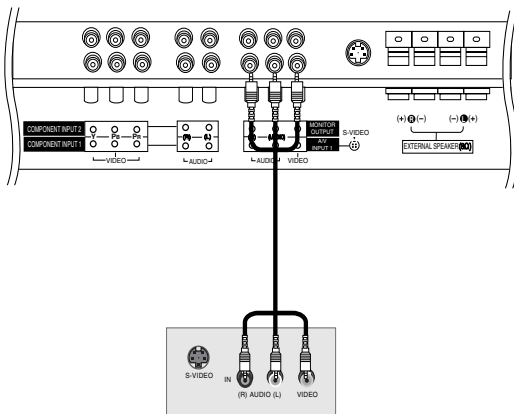

The TV has a special signal output capability which allows you to hook up a second TV or monitor.

Connect the second TV or monitor to the TV's MONITOR OUTPUT. See the Operating Manual of the second TV or monitor for further details regarding that device's input settings.

NOTE

- Component, RGB-PC/RGB-DTV, DVI-PC/DVI-DTV input sources cannot be used for Monitor out.

PC Setup

How to connect

1. To get the best picture quality, adjust the PC graphics card to 640x 480, 60Hz.
2. Use the TV's RGB INPUT or DVI (Digital Visual Interface) INPUT port for video connections, depending on your PC connector.
 - If the graphic card on the PC does not output analog and digital RGB simultaneously, connect only one of either RGB INPUT or DVI INPUT to display the PC on the TV.
 - If the graphic card on the PC does output analog and digital RGB simultaneously, set the TV to either RGB or DVI; (the other mode is set to Plug and Play automatically by the TV.)
3. Then, make the corresponding audio connection. If using a sound card, adjust the PC sound as required.

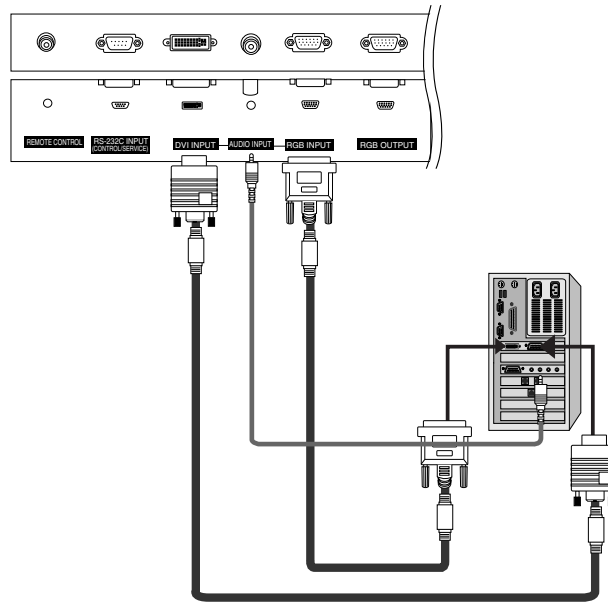
**How to use**

1. Turn on the PC and the TV.
2. Turn on the display by pressing the POWER button on the TV's remote control.
3. Use **INPUT SELECT** or **MULTIMEDIA** on the remote control to select **RGB**, or **DVI** source.
4. Check the image on your TV. There may be noise associated with the resolution, vertical pattern, contrast or brightness in PC mode. If noise is present, change the PC mode to another resolution, change the refresh rate to another rate or adjust the brightness and contrast on the menu until the picture is clear. If the refresh rate of the PC graphic card can not be changed, change the PC graphic card or consult the manufacturer of the PC graphic card.

- NOTES:**
- Use a DVI cable.
 - Avoid keeping a fixed image on the TV's screen for a long period of time. The fixed image may become permanently imprinted on the screen. Use the Orbiter screen saver when possible.
 - The synchronization input form for Horizontal and Vertical frequencies is separate.

Monitor Display Specifications (RGB-PC / DVI-PC Mode)

Resolution	Horizontal Frequency(KHz)	Vertical Frequency(Hz)	Resolution	Horizontal Frequency(KHz)	Vertical Frequency(Hz)
640x350	31.468	70.09	852x480	31.500	60.00
	37.861	85.08		35.000	70.00
720x400	31.469	70.08		37.500	75.00
	37.927	85.03	1024x768	48.363	60.00
640x480	31.469	59.94		56.476	70.06
	35.000	66.66	60.023	75.02	
	37.861	72.80	1152x864	54.348	60.05
	37.500	75.00		63.995	70.01
	43.269	85.00		67.500	75.00
800x600	35.156	56.25	1280x960	60.000	60.00
	37.879	60.31	1280x1024	63.981	60.02
	46.875	75.00	1360x768	47.700	60.00
	53.674	85.06		59.625	75.02
832x624	49.725	74.55	1366x768	47.700	60.00
848x480	31.500	60.00		59.625	75.02
	35.000	70.00			
	37.500	75.00			

Operation

Turning on the Monitor

Turning on the Monitor just after installation

1. Connect power cord correctly.
2. Press the **⏻ ON/OFF** button on the Monitor. At this moment, the Monitor is switched to standby mode. Press the **INPUT SELECT** button on the Monitor or press the **POWER, INPUT SELECT** button on the remote control and then the Monitor will switch on.

Turning on the Monitor (power cord is still connected)

1. If the Monitor was turned off with the **⏻ ON/OFF** button on the Monitor
 - Press the **⏻ ON/OFF** button on the Monitor to turn the Monitor on.
2. If the Monitor was turned off with the remote control and then the **⏻ ON/OFF** button on the Monitor
 - Press the **⏻ ON/OFF** button on the Monitor and then press the **INPUT SELECT** button on the Monitor or press the **POWER, INPUT SELECT** button on the remote control to turn the Monitor on.

Menu Language Selection

- The menus can be shown on the screen in the selected language. First select your language.

1. Press the **MENU** button and then use **▲ / ▼** button to select the **SPECIAL** menu.
2. Press the **▶** button and then use **▲ / ▼** button to select **Language**.
3. Press the **▶** button and then use **▲ / ▼** button to select your desired language.
From this point on, the on-screen menus will be shown in the language of your choice.
4. Press the **ENTER** button to save.

Picture Menu Options

APC (Auto Picture Control)

- APC adjusts the TV to the best picture appearance.
- If adjusting picture options (contrast, brightness, color, sharpness, or tint) manually, APC automatically changes to **Off**.

1. Press the **APC** button repeatedly to select the picture appearance setup option as shown below.



- You can also adjust **APC** in the **PICTURE** menu.
- **Daylight**, **Optimum** and **Night time** settings are preset for good picture quality at the factory and cannot be changed.

XD

- XD is LG Electronic's unique picture improving technology to display a real HD source through an advanced digital signal processing algorithm.
- When selecting APC options (Clear, Optimum and Soft), XD is automatically change to On.

1. Press the **MENU** button and then use **▲ / ▼** button to select the **PICTURE** menu.
2. Press the **▶** button and then use **▲ / ▼** button to select **XD**.
3. Press the **▶** button and then use **▲ / ▼** button to set **On** or **Off**.
4. Press the **ENTER** button to save.

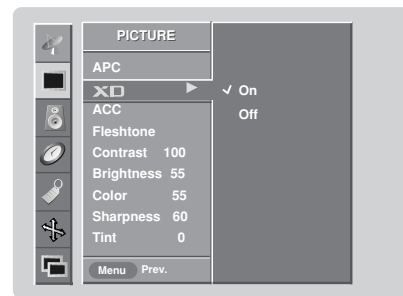

Color Temperature Control

Auto Color Temperature Control

- To initialize values (reset to default settings), select the **Normal** option.

1. Press the **MENU** button and then use **▲ / ▼** button to select the **PICTURE** menu.
2. Press the **▶** button and then use **▲ / ▼** button to select **ACC**.
3. Press the **▶** button and then use **▲ / ▼** button to select either: **Cool** (Preset), **Normal** (Default), or **Warm** (Preset).
4. Press the **ENTER** button to save.

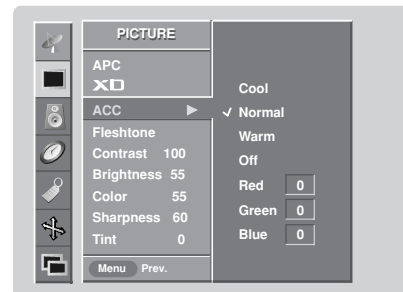

Manual Color Temperature Control (ACC set to Off option)

- You can adjust red, green, or blue to any color temperature you prefer.

1. Press the **MENU** button and then use **▲ / ▼** button to select the **PICTURE** menu.
2. Press the **▶** button and then use **▲ / ▼** button to select **ACC**.
3. Press the **▶** button and then use **▲ / ▼** button to select **User**.
4. Press the **▶** button and then use **▲ / ▼** button to select **Red**, **Green** or **Blue**.
5. Use the **◀ / ▶** button to make appropriate adjustments.
 - The adjustment range of **Red**, **Green**, and **Blue** is -30 ~ +30.
6. Press the **ENTER** button to save.

Fleshtone (RGB-DTV, and DVI-DTV Mode only)

- Use Fleshtone to select the desired skin color option.
1. Press the **MENU** button and then use ▲ / ▼ button to select the **PICTURE** menu.
 2. Press the ► button and then use ▲ / ▼ button to select **Fleshtone**.
 3. Press the ► button and then use ◀ / ▶ button to make appropriate adjustments.
 - The adjustment range is 0 ~ 3.
 4. Press the **ENTER** button to save.

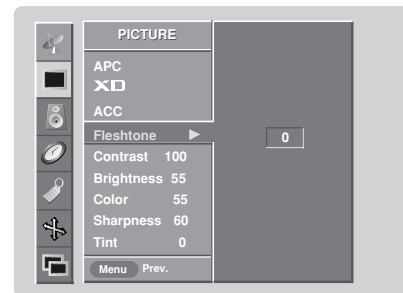

sRGB (only RGB-PC, DVI-PC Modes)

- If the TV is connected to external equipment using sRGB, set sRGB to On to adjust for the color difference.
1. Press the **MENU** button and then use ▲ / ▼ button to select the **PICTURE** menu.
 2. Press the ► button and then use ▲ / ▼ button to select **sRGB**.
 3. Press the ► button and then use ▲ / ▼ button to select **On** or **Off**.
 4. Press the **ENTER** button to save.

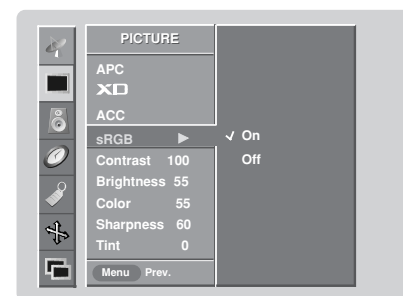

Manual Picture Control (**APC** set to **Off** option)

- You can adjust picture contrast, brightness, color, sharpness, and tint options to the levels you prefer.
1. Press the **MENU** button and then use ▲ / ▼ button to select the **PICTURE** menu.
 2. Press the ► button and then use ▲ / ▼ button to select the desired picture option (**Contrast**, **Brightness**, **Color**, **Sharpness**, **Tint**).
 3. Press the ► button and then use ◀ / ▶ button to make appropriate adjustments.
 4. Press the **ENTER** button to save.

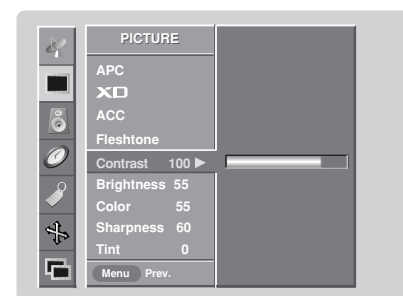

Sound Menu Options

DASP (Digital Auto Sound Processing)

- This function lets you enjoy the best sound without any special adjustment because the TV has the appropriate sound options based on the program content.
- If you adjust sound options (Treble and Bass) manually, DASP automatically changes to **Off**.

1. Press the **DASP** button repeatedly to select the appropriate sound setup as shown below.



- You can also adjust **DASP** in the **SOUND** menu.
- **SRS TSXT**, **Flat**, **Music**, **Movie**, and **Sports** are preset for good sound quality at the factory and cannot be changed.
- **SRS**  is a trademark of SRS Labs, Inc.
- TruSurround XT technology is incorporated under license from SRS Labs, Inc.

BBE

- BBE High Definition Sound restores clarity and presence for better speech intelligibility and music realism.

1. Press the **MENU** button and then use **▲ / ▼** button to select the **SOUND** menu.
2. Press the **▶** button and then use **▲ / ▼** button to select **BBE**.
3. Press the **▶** button and then use **▲ / ▼** button to select **On** or **Off**.
4. Press the **ENTER** button to save.

- **BBE**. Manufactured under license from BBE Sound, Inc.
- Treble, Bass or BBE aren't suitable for **SRS TSXT** mode.

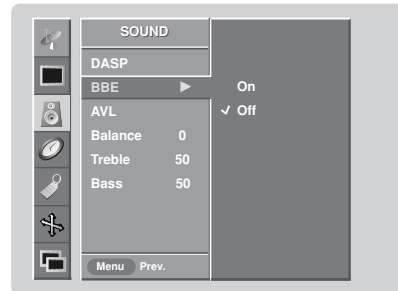

AVL (Auto Volume Leveler)

- AVL maintains an equal sound level; even if you change channels.

1. Press the **MENU** button and then use **▲ / ▼** button to select the **SOUND** menu.
2. Press the **▶** button and then use **▲ / ▼** button to select **AVL**.
3. Press the **▶** button and then use **▲ / ▼** button to select **On** or **Off**.
4. Press the **ENTER** button to save.

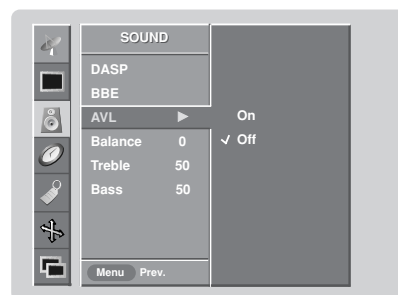

Manual Sound Control (**DASP** set to **Off** option)

- You can adjust sound options Balance, Treble, and Bass to the levels you prefer.
1. Press the **MENU** button and then use **▲ / ▼** button to select the **SOUND** menu.
 2. Press the **▶** button and then use **▲ / ▼** button to select the desired sound option (**Balance, Treble, Bass**).
 3. Press the **▶** button and then use **◀ / ▶** button to make appropriate adjustments.
 4. Press the **ENTER** button to save.

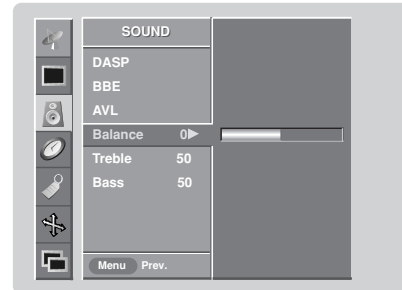

Stereo/SAP Broadcasts Setup

- The TV can receive MTS stereo programs and any SAP (Secondary Audio Program) that accompanies the stereo program; if the broadcaster transmits one additional sound signal in addition to the original one.
- Mono: The primary language is heard from left and right speakers. Signal mode is mono.
- Stereo: The primary language is heard from left and right speakers. Signal mode is stereo.
- SAP: The secondary language is heard from left and right speakers in mono sound.

1. Press the **MTS** button repeatedly.



- Select mono sound mode if the signal is not clear or in poor signal reception areas.
- **Stereo, SAP** modes are available only if included on the broadcast signal.

Timer Menu Options

Clock Setup

- If current time setting is wrong, reset the clock manually.

 1. Press the **MENU** button and then use ▲ / ▼ button to select the **TIMER** menu.
 2. Press the ► button and then use ▲ / ▼ button to select **Clock**.
 3. Press the ► button and then use ▲ / ▼ button to set the hour.
 4. Press the ► button and then use ▲ / ▼ button to set the minutes.
 5. Press the **ENTER** button to save.

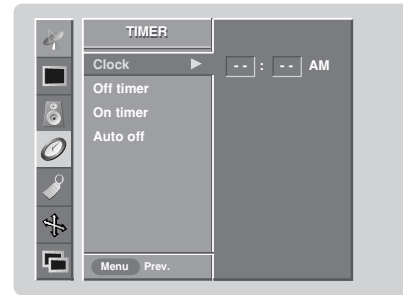

On/Off Timer Setup

- Timer function operates only if current time has been set.
- Off-Timer function overrides On-Timer function if they are set both set to the same time.
- The TV must be in standby mode for the On-Timer to work.
- If you do not press any button within 2 hours after the TV turns on with the On Timer function, the TV will automatically revert to standby mode.

1. Press the **MENU** button and then use ▲ / ▼ button to select the **TIMER** menu.
2. Press the ► button and then use ▲ / ▼ button to select **Off timer** or **On timer**.
3. Press the ► button and then use ▲ / ▼ button to select **On**.
 - To cancel **On/Off timer** function, select **Off**.
4. Press the ► button and then use ▲ / ▼ button to set the hour.
5. Press the ► button and then use ▲ / ▼ button to set the minutes.
6. **For only On timer function**
 - Press the ► button and then use ▲ / ▼ button to set the volume level at turn-on.
 - Press the ► button and then use ▲ / ▼ button to select the channel at turn-on.
7. Press the **ENTER** button to save.

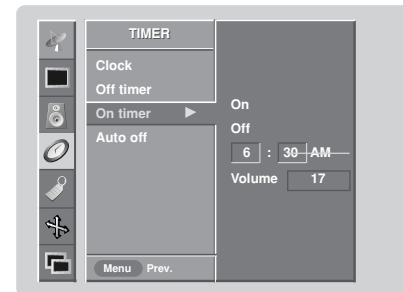

Auto Off

1. Press the **MENU** button and then use ▲ / ▼ button to select the **TIMER** menu.
2. Press the ► button and then use ▲ / ▼ button to select **Auto off**.
3. Press the ► button and then use ▲ / ▼ button to select **On** or **Off**.
4. Press the **ENTER** button to save.

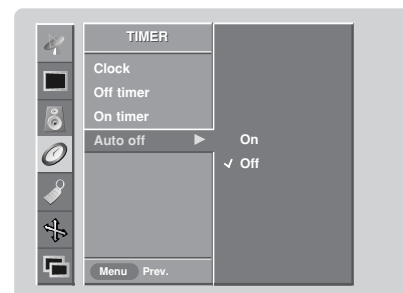

Sleep Timer

- The Sleep Timer turns the TV off at the preset time. Note that this setting is cleared when the TV is turned off.

 1. Press the **SLEEP** button repeatedly to select the number of minutes. First the **Off** option appears on the screen, followed by the following sleep timer options: 10, 20, 30, 60, 90, 120, 180, and 240 minutes.
 2. When the number of minutes you want is displayed on the screen, press the **OK** button. The timer begins to count down from the number of minutes selected.
 3. To check the remaining minutes before the TV turns off, press the **SLEEP** button once.
 4. To cancel the Sleep Timer, press the **SLEEP** button repeatedly to select **Off**.

Special Menu Options

Key Lock

- The TV can be set up so that it can only be used with the remote control.
- This feature can be used to prevent unauthorized viewing by locking out the front panel controls.
- This TV is programmed to remember which option it was last set to even if you turn the TV off.

1. Press the **MENU** button and then use ▲ / ▼ button to select the **SPECIAL** menu.
2. Press the ► button and then use ▲ / ▼ button to select **Key lock**.
3. Press the ► button and then use ▲ / ▼ button to select **On** or **Off**.
4. Press the **ENTER** button to save.
 - With the Key lock On, the display '▲ Key lock' appears on the screen if any button on the front panel is pressed.



ISM (Image Sticking Minimization) Method

- A frozen still picture from a PC/video game displayed on the screen for prolonged periods will result in a ghost image remaining even when you change the image. Avoid allowing a fixed image to remain on the TV's screen for a long period of time.

1. Press the **MENU** button and then use ▲ / ▼ button to select the **SPECIAL** menu.
2. Press the ► button and then use ▲ / ▼ button to select **ISM Method**.
3. Press the ► button and then use ▲ / ▼ button to select either **Normal**, **White wash**, **Orbiter** or **Inversion**.

• Normal

If image sticking is never a problem, ISM is not necessary - set to Normal.

• White wash

White Wash removes permanent images from the screen. Note: An excessive permanent image may be impossible to clear entirely with White Wash. To return to normal viewing, press any button.

• Orbiter

Orbiter may help prevent ghost images. However, it is best not to allow any fixed image to remain on the screen. To avoid a permanent image on the screen, the image will move every 2 minutes: Right → Right → Downside → Downside → Left → Left → Upside → Upside.

• Inversion

Inversion will automatically invert the TV panel color every 30 minutes.

4. Press the **ENTER** button to save.

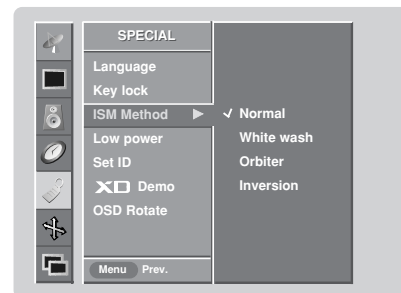

Special Menu Options continued

Low Power

- Low power reduces the plasma display power consumption.

1. Press the **MENU** button and then use ▲ / ▼ button to select the **SPECIAL** menu.
2. Press the ► button and then use ▲ / ▼ button to select **Low power**.
3. Press the ► button and then use ▲ / ▼ button to select **On** or **Off**.
 - When you select **On**, the screen darkens.
4. Press the **ENTER** button to save.

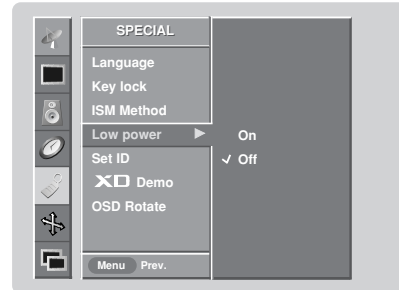

XD Demo

- Use it to see the difference between XD Demo on and XD Demo off.

1. Press the **MENU** button and then use ▲ / ▼ button to select the **SPECIAL** menu.
2. Press the ► button and then use ▲ / ▼ button to select **XD Demo**.
3. Press the ► button to begin **XD Demo**.
4. Press the **MENU** button to stop **XD Demo**.



Menu Rotation for Vertical Viewing

1. Press the **MENU** button and then use ▲ / ▼ button to select the **SPECIAL** menu.
2. Press the ► button and then use ▲ / ▼ button to select **OSD (On Screen Display) Rotate**.
3. Press the ► button and then use ▲ / ▼ button to select **Normal** or **Rotate**.
 - Select **Normal**, if the monitor was installed horizontally.
 - Select **Rotate**, if the monitor was installed vertically.
4. Press the **ENTER** button to save.

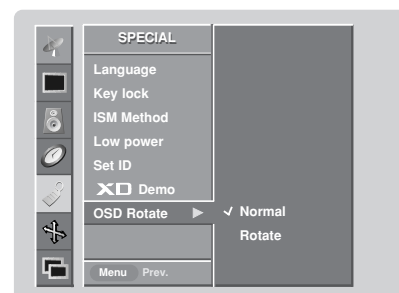

Screen Menu Options

Auto Adjustment

- RGB (PC) mode only; This function doesn't work for RGB-DTV mode.
- Automatically adjusts picture position and minimizes image shaking.
- After adjustment, if the image is still not correct, your TV is functioning properly but needs further adjustment.
- The **Auto config.** and **Manual config.** are not active in DVI mode.

1. Press the **MENU** button and then use ▲ / ▼ button to select the **SCREEN** menu.
2. Press the ► button and then use ▲ / ▼ button to select **Auto config.**.
3. Press the ► button to run Auto configure.
 - When **Auto config.** has finished, **OK** will be shown on screen.
 - If the position of the image is still not correct, try Auto adjustment again.
4. In RGB (PC) mode, if the image needs to be adjusted more after using **Auto config.**, you can make further adjustments with the **Manual config.** option.

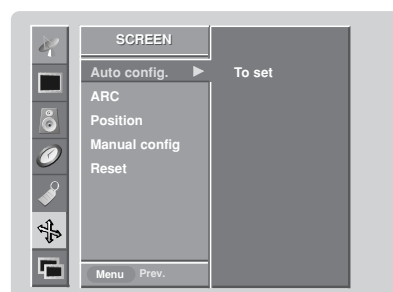

Setting Picture Format

- Caution: If a 4:3 fixed image is on the screen for a long time, it may remain visible.
- Set every aspect ratio for TV, Video, Component 480i sources.
- Use 4:3, or 16:9 for other RGB-PC and DVI-PC sources.
- Horizon is not available for Component (480p,720p,1080i), DTV (480p,720p,1080i) sources.

1. Press the **ARC** button repeatedly to select the desired picture format. You can also adjust **ARC** in the **SCREEN** menu.
 - **4:3**
Choose **4:3** when you want to view a picture with an original 4:3 aspect ratio, with black bars appearing at both the left and right sides.
 - **16:9**
Choose **16:9** when you want to adjust the picture horizontally, in a linear proportion to fill the entire screen.
 - **Horizon**
Choose **Horizon** when you want to adjust the picture in a non-linear proportion, that is, more enlarged at both sides, to create a spectacular view.
 - **Zoom**
Choose **Zoom** when you want to view the picture without any alteration. However, the top and bottom portions of the picture will be cropped.

Screen Position

- This function works in the following modes:
RGB-PC, RGB-DTV (480p,720p,1080i), DVI-DTV (480p,720p,1080i), COMPONENT (480p,720p,1080i).

1. Press the **MENU** button and then use ▲ / ▼ button to select the **SCREEN** menu.
2. Press the ► button and then use ▲ / ▼ button to select **Position**.
3. Press the ► button and then use ▲ / ▼ / ◀ / ▶ button to adjust the position.
4. Press the **ENTER** button to save.

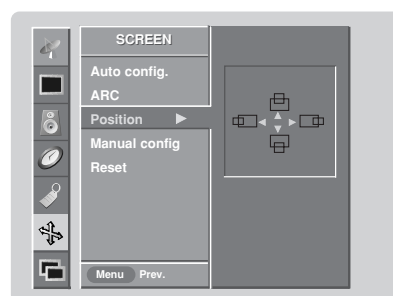

Manual Configure (RGB-PC mode only)

1. Press the **MENU** button and then use ▲ / ▼ button to select the **SCREEN** menu.
2. Press the ► button and then use ▲ / ▼ button to select **Manual config.**
3. Press the ► button and then use ▲ / ▼ button to select **Phase** or **Clock**.
4. Use the ◀ / ▶ button to make appropriate adjustments.
 - The **Phase** adjustment range is 0 ~ 30.
 - The **Clock** adjustment range is -127 ~ +128.
5. Press the **ENTER** button to save.

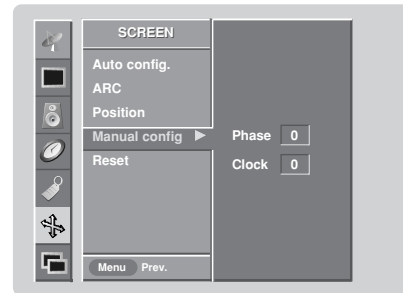

Selecting VGA Mode (RGB-PC mode only)

- To see a normal picture, match the resolution of RGB mode and selection of VGA mode.
1. Press the **MENU** button and then use ▲ / ▼ button to select the **SCREEN** menu.
 2. Press the ► button and then use ▲ / ▼ button to select **VGA Mode**.
 3. Press the ► button and then use ▲ / ▼ button to select the desired VGA resolution.
 4. Press the **ENTER** button to save.

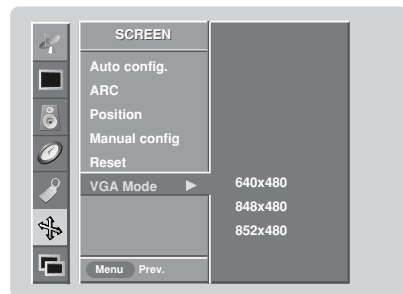

Screen Adjustments (Video1-2 and Component 480i mode only)

- Use this function to correct jittering or picture instability while viewing a video tape.
1. Press the **MENU** button and then use ▲ / ▼ button to select the **SCREEN** menu.
 2. Press the ► button and then use ▲ / ▼ button to select **Screen adj.**
 3. Press the ► button and then use ▲ / ▼ button to select **TV** or **VCR**.
 - Select the **VCR** option if watching a VCR.
 - Select the **TV** option for other equipment. (Except VCR)
 4. Press the **ENTER** button to save.

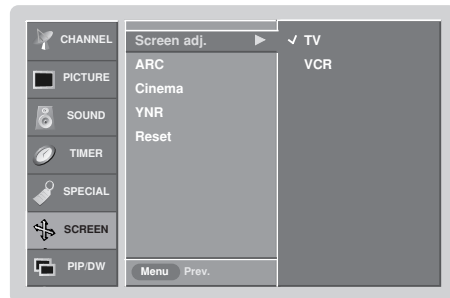

Cinema Mode Setup (Video1-2 and Component 480i mode only)

- Sets up the TV for the best picture appearance for viewing movies.
1. Press the **MENU** button and then use ▲ / ▼ button to select the **SCREEN** menu.
 2. Press the ► button and then use ▲ / ▼ button to select **Cinema**.
 3. Press the ► button and then use ▲ / ▼ button to select **On** or **Off**.
 4. Press the **ENTER** button to save.

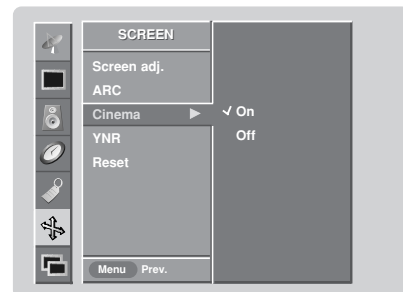

Screen Menu Options continued

Luminance Noise Reduction (Video 1-2 and Component 480i modes only)

- Use YNR to reduce the picture noise that may appear on the screen.

1. Press the **MENU** button and then use **▲ / ▼** button to select the **SCREEN** menu.
2. Press the **▶** button and then use **▲ / ▼** button to select **YNR**.
3. Press the **▶** button and then use **▲ / ▼** button to select **On** or **Off**.
4. Press the **ENTER** button to save.

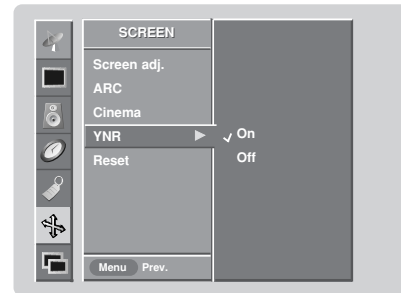

Initializing (Reset to original factory value)

- Reset is unique to each function: Manual config., Position, Split zoom, PIP position and sub picture size for double window.
 - Use the Reset option to initialize the adjusted settings.

1. Press the **MENU** button and then use **▲ / ▼** button to select the **SCREEN** menu.
2. Press the **▶** button and then use **▲ / ▼** button to select **Reset**.
3. Press the **▶** button.
 - You can initialize Position, Split zoom, PIP Transparency, PIP position, PIP size and sub picture size for double window.

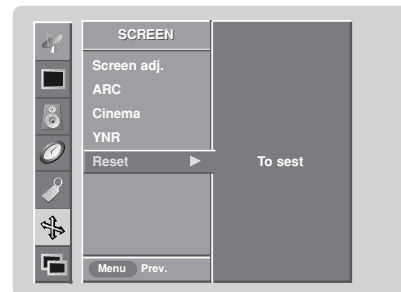

Split Zoom

- Enlarges the picture in correct proportions.
 - Split Zoom can be used for all input sources.
 - In 2-Split Zoom mode, you can only move the image up or down.
 - If an image is enlarged, a section can be viewed without using Split Zoom.

1. Press the **SPLIT ZOOM** button repeatedly to select either 2, 4, or 9 Split Zoom.

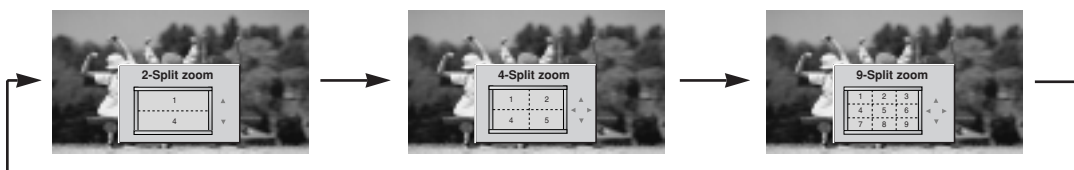

2. Press the number button corresponding to the section you wish to enlarge. You can move within the enlarged picture using the **▲ / ▼ / ◀ / ▶** button. To return to normal viewing, press the **SPLIT ZOOM** button again.

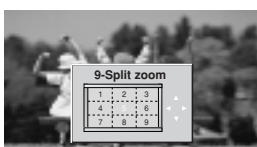

Example of choosing 5.



Section 5 is enlarged to fill the screen.

PIP (Picture-In-Picture)/Double Window Feature

- PIP lets you view 2 different inputs pictures (sources) on your TV screen at the same time. One source will be large, and the other source will show a smaller inset image.
- Double Window mode splits the screen into 2, allowing 2 picture sources to be shown on the TV screen at the same time. Each source is given half the screen.

Watching PIP/Double Window

Press the **PIP/DW** button to access the sub picture. Each press of PIP changes the PIP options as shown below.

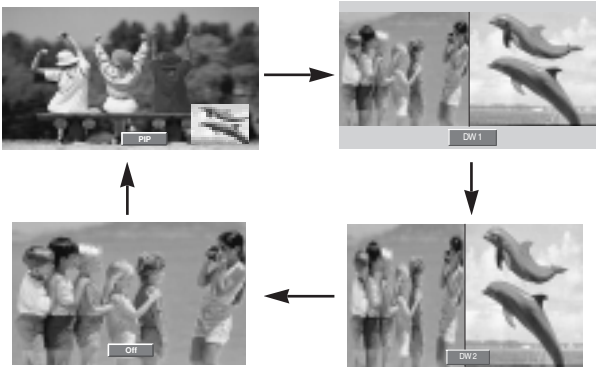

Swapping the PIP/Double Window

Use the **SWAP** button to switch the main and sub pictures.

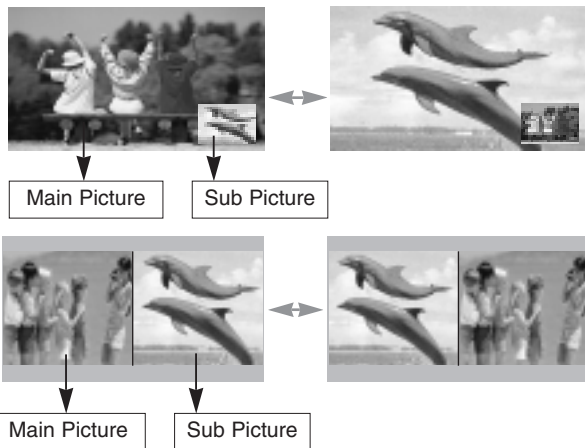

TV Program selection for PIP

Press the **PIPCH+** / **PIPCH-** button to select a channel for the sub picture in PIP mode.

Selecting an Input Signal Source for PIP/Double Window

Use the **PIP INPUT** button to select the input source for the sub picture. Each press of **PIP INPUT** button changes the PIP source.

Main Picture Source	Available Sub Picture Sources
TV, Video 1-2, Component 480i	TV, Video 1-2, Component 480i/480p/720p/1080i, RGB and DVI
Component 480p/720p/1080i, RGB and DVI	TV, Video 1-2, Component 480i

Moving the PIP (PIP Mode only)

Press the **POSITION** button.

Press the **▲ / ▼ / ◀ / ▶** button repeatedly until desired position is achieved. The sub picture moves up/down/left/right.

- You can also move the PIP position with **Win.position** in the **PIP/DW** menu.



PIP Size

Press the **WIN.SIZE** button and then use **◀ / ▶** button to change the sub picture size.

- Using the Win.size function in Double Window mode, main and sub picture sizes are changed simultaneously.
- Using the Win.size function in PIP mode, sub picture size is changed.

- You can also change the sub picture size with **Win.size** in the **PIP/DW** menu.



PIP Transparency (PIP Mode only)

- To make the PIP clear or opaque

1. Press the **MENU** button and then use **▲ / ▼** button to select the **PIP/DW** menu.
2. Press the **▶** button and then use **▲ / ▼** button to select **PIP Transparency**.
3. Press the **▶** button and then use **◀ / ▶** button to adjust PIP transparency.
4. Use the **◀ / ▶** button to make appropriate adjustments.
 - The adjustment range of **PIP Transparency** is 0 ~ 10.
5. Press the **ENTER** button to save.

External Control Device Setup

- Connect the RS-232C input jack to an external control device (such as a computer or an A/V control system) and control the Monitor's functions externally.
- Connect the serial port of the control device to the RS-232C jack on the Monitor back panel.
- RS-232C connection cables are not supplied with the Monitor.

RS-232C Setup

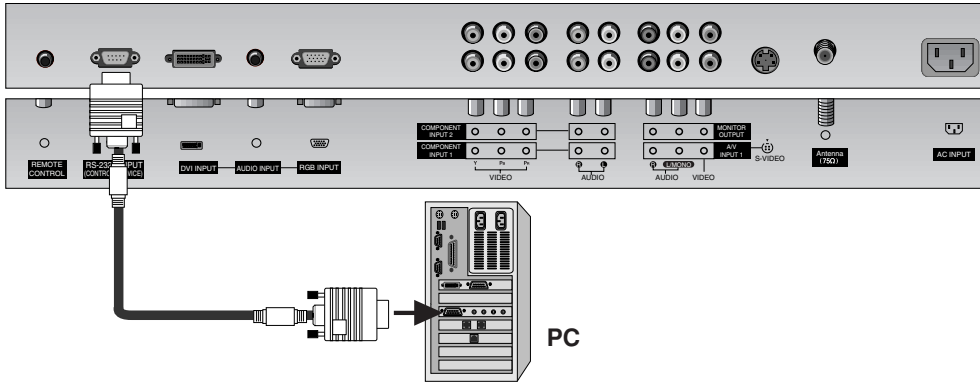

Type of Connector; D-Sub 9-Pin Male

No.	Pin name
1	No connection
2	RXD (Receive data)
3	TXD (Transmit data)
4	DTR (DTE side ready)
5	GND
6	DSR (DCE side ready)
7	RTS (Ready to send)
8	CTS (Clear to send)
9	No Connection

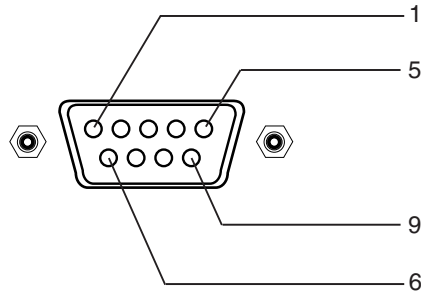

RS-232C Configurations

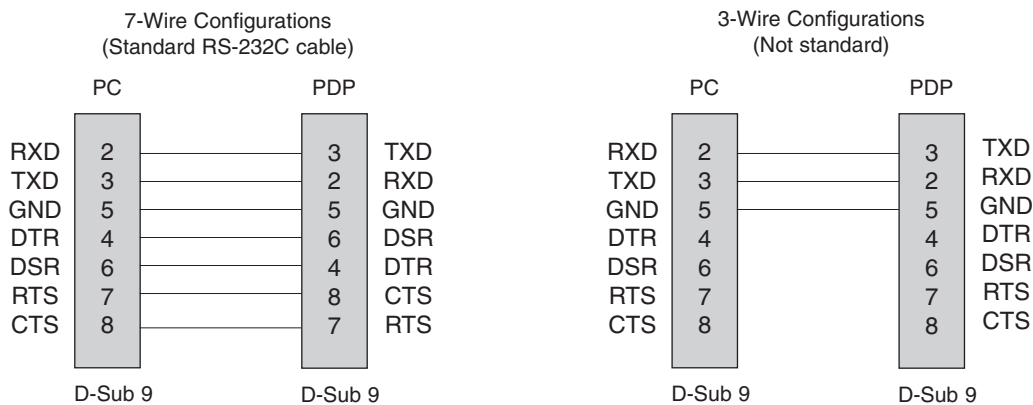

Set ID

- Use this function to specify a monitor ID number.
- Refer to 'Real Data Mapping 1'. See page 32.

1. Press the **MENU** button and then use **▲ / ▼** button to select the **SPECIAL** menu.
2. Press the **▶** button and then use **▲ / ▼** button to select **Set ID**.
3. Press the **▶** button and then use **◀ / ▶** button to adjust **Set ID** to choose the desired monitor ID number. The adjustment range of **Set ID** is 1 ~ 99.
4. Press the **ENTER** button to save.

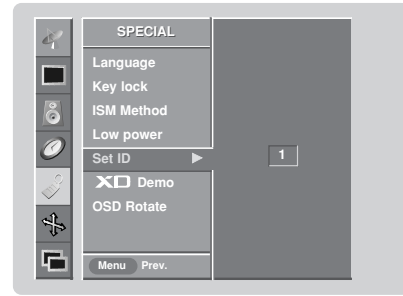

Communication Parameters

- Baud rate :9600 bps (UART)
- Data length : 8 bits
- Parity : None
- Stop bit : 1 bit
- Communication code : ASCII code

* Use a crossed (reverse) cable.

Command Reference List

	COMMAND 1	COMMAND 2	DATA (Hexadecimal)
01. Power	k	a	0 ~ 1
02. Input Select	k	b	0 ~ 6
03. Aspect Ratio	k	c	0 ~ 3
04. Screen Mute	k	d	0 ~ 1
05. Volume Mute	k	e	0 ~ 1
06. Volume Control	k	f	0 ~ 64
07. Contrast	k	g	0 ~ 64
08. Brightness	k	h	0 ~ 64
09. Color	k	i	0 ~ 64
10. Tint	k	j	0 ~ 64
11. Sharpness	k	k	0 ~ 64
12. OSD Select	k	l	0 ~ 1
13. Remote Control Lock Mode	k	m	0 ~ 1
14. PIP/DW	k	n	0 ~ 3
15. Split Zoom	k	p	0 ~ 99
16. PIP Position	k	q	0 ~ 3
17. Treble	k	r	0 ~ 64
18. Bass	k	s	0 ~ 64
19. Balance	k	t	0 ~ 64
20. Color Temperature	k	u	0 ~ 3
21. Red Adjustment	k	v	0 ~ 3C
22. Green Adjustment	k	w	0 ~ 3C
23. Blue Adjustment	k	\$	0 ~ 3C
24. PIP Input Source	k	y	0 ~ 6
25. Abnormal State	k	z	0 ~ a
26. ISM Method	j	p	0 ~ 3
27. Low Power	j	q	0 ~ 1
28. Orbiter Time Setting	j	r	1 ~ FE
29. Orbiter Pixel Setting	j	s	1~9
30. Picture Size	j	t	0 ~ 14
31. Auto Config	j	u	1

	COM- MAND 1	COM- MAND 2	DATA 0 (Hexadecimal)	DATA 1 (Hexadecimal)	DATA 2 (Hexadecimal)	DATA 3 (Hexadecimal)
32. Tune Command	m	a	01 ~ 7D	0	0	main/sub/TuneBand
33. Channel Add/Del	m	b	0 ~ 1			
34. Key	m	c	Key code			

Transmission / Receiving Protocol

Transmission

[Command1][Command2][][Set ID][][Data][Cr]

- * [Command 1]: First command to control PDP set. (j, k or m)
- * [Command 2]: Second command to control PDP set.
- * [Set ID]: You can adjust the set ID to choose desired monitor ID number in Special menu. Adjustment range is 1 ~ 99. When selecting Set ID '0', every connected PDP set is controlled. Set ID is indicated as decimal (1~99) on menu and as Hexa decimal (0x0~0x63) on transmission/receiving protocol.
- * [DATA]: To transmit command data.
Transmit 'FF' data to read status of command.
- * [Cr]: Carriage Return
ASCII code '0x0D'
- * []: ASCII code 'space (0x20)'

OK Acknowledgement

[Command2][][Set ID][][OK][Data][x]

- * The Monitor transmits ACK (acknowledgement) based on this format when receiving normal data. At this time, if the data is data read mode, it indicates present status data. If the data is data write mode, it returns the data of the PC computer.

Error Acknowledgement

[Command2][][Set ID][][NG][Data][x]

- * The Monitor transmits ACK (acknowledgement) based on this format when receiving abnormal data from non-viable functions or communication errors.

- Data 1: Illegal Code
2: Not supported function
3: Wait more time

09. Color (Command2:i)

- ▶ To adjust the screen color.
You can also adjust color in the Picture menu.

Transmission

[k][i][][Set ID][][Data][Cr]

Data Min : 0 ~ Max : 64

- Refer to 'Real data mapping 1'. See page 32.

Acknowledgement

[i][][Set ID][][OK][Data][x]

10. Tint (Command2:j)

- ▶ To adjust the screen tint.
You can also adjust tint in the Picture menu.

Transmission

[k][j][][Set ID][][Data][Cr]

Data Red : 0 ~ Green : 64

- Refer to 'Real data mapping 1'. See page 32.

Acknowledgement

[j][][Set ID][][OK][Data][x]

11. Sharpness (Command2:k)

- ▶ To adjust the screen sharpness.
You can also adjust sharpness in the Picture menu.

Transmission

[k][k][][Set ID][][Data][Cr]

Data Min: 0 ~ Max: 64

- Refer to 'Real data mapping 1'. See page 32.

Acknowledgement

[k][][Set ID][][OK][Data][x]

12. OSD Select (Command2:l)

- ▶ To select OSD (On Screen Display) on/off.

Transmission

[k][l][][Set ID][][Data][Cr]

Data 0: OSD off 1: OSD on

Acknowledgement

[l][][Set ID][][OK][Data][x]

13. Remote Control Lock Mode (Command2:m)

- ▶ To lock the remote control and the front panel controls on the monitor.

Transmission

[k][m][][Set ID][][Data][Cr]

Data 0: Lock off 1: Lock on

Acknowledgement

[m][][Set ID][][OK][Data][x]

- If you're not using the remote control and front panel controls on the monitor, use this mode. When main power is on/off, remote control lock is released.

14. PIP / DW (Command2:n)

- ▶ To control the PIP (Picture In picture)/DW (Double Window).
You can also control the PIP/DW using the PIP/DW button on the remote control or in the PIP/DW menu.

Transmission

[k][n][][Set ID][][Data][Cr]

Data 0: PIP/DW off 2: DW1
1: PIP 3: DW2Acknowledgement

[n][][Set ID][][OK][Data][x]

15. Split Zoom (Command2:p)

- ▶ To operate split zoom function and select the split zoom section number.

Transmission

[k][p][][Set ID][][Data][Cr]

Data Min: 0 ~ Max:99

- Refer to 'Real data mapping 2'.

Acknowledgement

[p][][Set ID][][OK][Data][x]

* **Real data mapping 2**

- 0 : Reset split zoom
- 21: Selection 1 of 2 split zoom
- 24: Selection 4 of 2 split zoom
- 41: Selection 1 of 4 split zoom
- 42: Selection 2 of 4 split zoom
- 44: Selection 4 of 4 split zoom
- 45: Selection 5 of 4 split zoom
- 91: Selection 1 of 9 split zoom
- ⋮
- 99: Selection 9 of 9 split zoom

16. PIP Position (Command2:q)

- ▶ To select sub picture position for PIP.
You can also adjust the sub picture position using WIN.POSITION on the remote control or in the PIP/DW menu.

Transmission

[k][q][][Set ID][][Data][Cr]

Data 0: Right down on screen
1: Left down on screen
2: Left up on screen
3: Right up on screenAcknowledgement

[q][][Set ID][][OK][Data][x]

17. Treble (Command2:r)

- ▶ To adjust treble.
You can also adjust treble in the Sound menu.

Transmission

[k][r][][Set ID][][Data][Cr]

Data Min: 0 ~ Max: 64

- Refer to 'Real data mapping 1'. See page 32.

Acknowledgement

[r][][Set ID][][OK][Data][x]

18. Bass (Command2:s)

- ▶ To adjust bass.
You can also adjust bass in the Sound menu.

Transmission

[k][s][][Set ID][][Data][Cr]

Data Min: 0 ~ Max: 64

- Refer to 'Real data mapping 1'. See page 32.

Acknowledgement

[s][][Set ID][][OK][Data][x]

19. Balance (Command2:t)

- ▶ To adjust balance.
You can also adjust balance in the Sound menu.

Transmission

[k][t][][Set ID][][Data][Cr]

Data Min: 0 ~ Max: 64

- Refer to 'Real data mapping 1'. See page 32.

Acknowledgement

[t][][Set ID][][OK][Data][x]

20. Color Temperature (Command2:u)

- ▶ To adjust color temperature.
You can also adjust ACC in the Picture menu.

Transmission

[k][u][][Set ID][][Data][Cr]

Data 0: Cool 1: Normal 2: Warm 3: User

Acknowledgement

[u][][Set ID][][OK][Data][x]

21. Red Adjustment (Command2:v)

- ▶ To adjust red in color temperature.

Transmission

[k][v][][Set ID][][Data][Cr]

Data Min: 0 ~ Max: 3C

- Refer to 'Real data mapping 3' as shown right.

Acknowledgement

[v][][Set ID][][OK][Data][x]

22. Green Adjustment (Command2:w)

- ▶ To adjust green in color temperature.

Transmission

[k][w][][Set ID][][Data][Cr]

Data Min: 0 ~ Max: 3C

- Refer to 'Real data mapping 3' as shown right.

Acknowledgement

[w][][Set ID][][OK][Data][x]

23. Blue Adjustment (Command2:\$)

- ▶ To adjust blue in color temperature.

Transmission

[k][\$][][Set ID][][Data][Cr]

Data Min: 0 ~ Max: 3C

- Refer to 'Real data mapping 3' as shown below.

Acknowledgement

[\$][][Set ID][][OK][Data][x]

*** Real data mapping 3**

```

0 : -30
1 : -29
2 : -28
⋮
1E : 0
⋮
3A : +28
3B : +29
3C : +30

```

24. PIP Input Select (Command2:y)

- ▶ To select input source for sub picture in PIP mode.

Transmission

[k][y][][Set ID][][Data][Cr]

Data 0 : TV	4 : Component 2
1 : Video 1	5 : RGB
2 : Video 2	6 : DVI
3 : Component 1	

Acknowledgement

[y][][Set ID][][OK][Data][x]

25. Abnormal State (Command2:z)

- ▶ To recognize an abnormal state.

Transmission

[k][z][][Set ID][][FF][Cr]

Data FF:Read

Acknowledgement

[z][][Set ID][][OK][Data][x]

Data 0: Normal (Power on and signal exist)
1: No signal (Power on).
2: Turn the monitor off with remote control.
3: Turn the monitor off with Sleep Time function.
4: Turn the monitor off with RS-232C function.
5: 5V down.
6: AC down.
7: Turn the monitor off with Fan Alarm function.
8: Turn the monitor off with Off Time function.
9: Turn the monitor off with Auto Off function.
a: Turn the monitor off with On Time function.
(If you do not press any button within 2 hours after the TV turns on with the On Timer function, the TV will automatically revert to standby mode.)

* This function is "read only".

26. ISM Method (Command2:p)

- To avoid having a fixed image remain on screen.

Transmission

Data 0: Normal 2: Orbiter
1: White wash 3: Inversion

Acknowledgement

27. Low Power (Command2:q)

- To control the low power function on/off.

Transmission

Data 0: Low power off
1: Low power on

Acknowledgement

28. Orbiter Time Setting (Command2:r)

- To adjust orbiter operation time term.

Transmission

Data Min: 1 ~ Max: FE

Acknowledgement

29. Orbiter Pixel Setting (Command2:s)

- To adjust pixel number in orbiter function.

Transmission

Data Min: 1 ~ Max: 9

Acknowledgement

30. Picture Size Setting for Double Window mode (Command2:t)

- To adjust main window size in Double Window mode.

Transmission

Data Min: 0 ~ Max: 14

- Refer to 'Real data mapping1'. See page 32.

Acknowledgement

31. Auto Configure (Command2:u)

- To adjust picture position and minimize image shaking automatically. It works only in RGB (PC) mode.

Transmission

Data 1: To set

Acknowledgement

32. Tune command (Command: m a)

- Tune channel to following physical number

Transmission

Data 0: Air: 02 ~ 45, Cable: 01, 0E ~ 7D
1: 0
2: 0
3: High → Main Channel: 0, Sub Channel: 1
Low → Air: 0, CATV: 1

Acknowledgement

33. Channel Add/Del (Command: m b)

- To add and delete the channels

Transmission

Data 0: Channel Memory
1: Channel Erase

Acknowledgement

34. Key (Command: m c)

- To send IR remote key code

Transmission

Data Key code: Refer to page 37.

Acknowledgement

IR Codes

How to Connect

▶ Connect your wired remote control to the Remote Control port on the Monitor.

Remote Control IR Code

▶ Output waveform

Single pulse, modulated with 37.917KHz signal at 455KHz

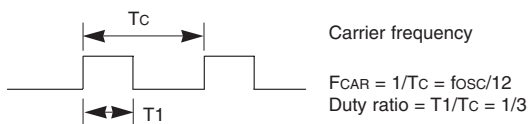

▶ Configuration of frame

- 1st frame

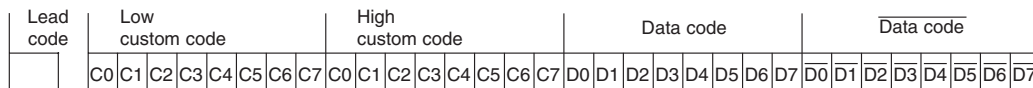

- Repeat frame

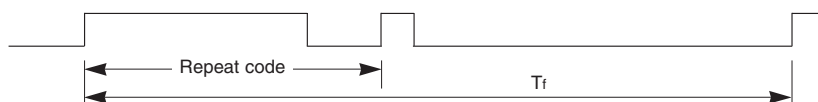

▶ Lead code



▶ Repeat code

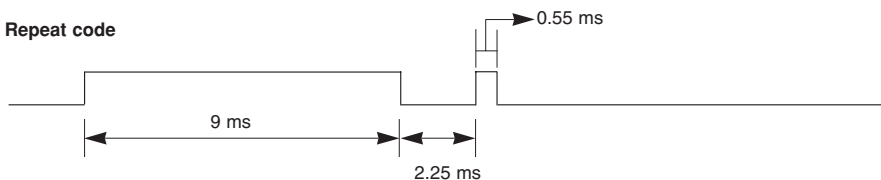

▶ Bit description

- Bit "0"

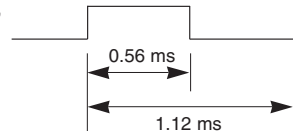

- Bit "1"

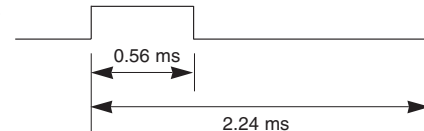

▶ Frame interval : Tf

The waveform is transmitted as long as a key is depressed.

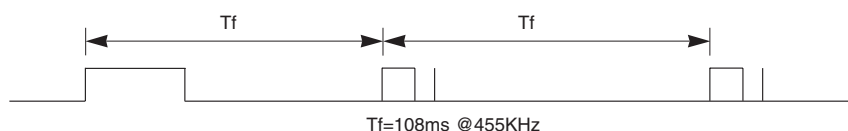

Code (Hexa)	Function	Note
00	CH (▲)	R/C Button
01	CH (▼)	R/C Button
02	VOL (▶)	R/C Button
03	VOL (◀)	R/C Button
08	POWER	R/C Button (Power On/Off)
C4	POWER ON	Discrete IR Code (Only Power On)
C5	POWER OFF	Discrete IR Code (Only Power Off)
09	MUTE	R/C Button
10	Number Key 0	R/C Button
11	Number Key 1	R/C Button
12	Number Key 2	R/C Button
13	Number Key 3	R/C Button
14	Number Key 4	R/C Button
15	Number Key 5	R/C Button
16	Number Key 6	R/C Button
17	Number Key 7	R/C Button
18	Number Key 8	R/C Button
19	Number Key 9	R/C Button
0B	TV/VIDEO	R/C Button
98	MULTIMEDIA	R/C Button
D6	TV	Discrete IR Code (Input TV Selection)
5A	VIDEO1	Discrete IR Code (Input VIDEO1 Selection)
D0	VIDEO2	Discrete IR Code (Input VIDEO2 Selection)
BF	COMPONENT1	Discrete IR Code (Input COMPONENT1 Selection)
D4	COMPONENT2	Discrete IR Code (Input COMPONENT2 Selection)
C6	DVI	Discrete IR Code (Input DVI Selection)
D5	RGB	Discrete IR Code (Input RGB Selection)
0E	SLEEP	R/C Button
43	MENU	R/C Button
44	ENTER	R/C Button
4D	APC	R/C Button
52	DASP	R/C Button
60	PIP/DW	R/C Button
61	PIP INPUT	R/C Button
63	SWAP	R/C Button
64	WIN.SIZE	R/C Button
62	POSITION	R/C Button
71	PIP CH+	R/C Button
72	PIP CH-	R/C Button
7B	SPLIT ZOOM	R/C Button
79	ARC	R/C Button
76	ARC (4:3)	Discrete IR Code (Only 4:3 mode)
77	ARC (16:9)	Discrete IR Code (Only 16:9 mode)
AF	ARC (Zoom)	Discrete IR Code (Only Zoom mode)
1E	FCR	R/C Button
1A	REVIEW	R/C Button
54	AUTO PROGRAM	R/C Button
55	MEMORY/ERASE	R/C Button
0A	MTS	R/C Button
39	CAPTION	R/C Button
99	AUTO CONFIG	Discrete IR Code

Troubleshooting Checklist

No picture & No sound

- Check whether the TV is turned on.
- Is the power cord inserted into wall power outlet?
- Test the wall power outlet, plug another product's power cord into the outlet where the TV's power cord was plugged in.

Picture OK & No sound

- Press the **VOLUME** (▶) button.
- Sound muted? Press **MUTE** button.

The remote control doesn't work

- Check to see if there is any object between the TV and the remote control causing obstruction.
- Are batteries installed with correct polarity (+ to +, - to -)? (Refer to p.9)
- Correct remote operating mode set: TV, VCR etc.?
- Install new batteries. (Refer to p.9)

Picture appears slowly after switching on

- This is normal, the image is muted during the TV startup process. Please contact your service center, if the picture has not appeared after five minutes.

No or poor color or poor picture

- Select **Color** in the **Picture** menu and press the **VOLUME** (▶) button. (Refer to p.18)
- Keep a sufficient distance between the TV and the VCR.
- Activate any function to restore the brightness of the picture. (If still picture is on the screen for more than 5 minutes, the screen gets dark.)

Horizontal/vertical bars or picture shaking

- Check for local interference such as an electrical appliance or power tool.

No output from one of the speakers

- Adjust **Balance** in the **Sound** menu. (Refer to p.20)

Unusual sound from inside the TV

- A change in ambient humidity or temperature may result in an unusual noise when the plasma display is turned on or off and does not indicate a fault with the TV.

Maintenance

- Early malfunctions can be prevented. Careful and regular cleaning can extend the amount of time you will have your new Monitor. Be sure to turn the power off and unplug the power cord before you begin any cleaning.

Cleaning the Screen

1. Here's a great way to keep the dust off your screen for a while. Wet a soft cloth in a mixture of lukewarm water and a little fabric softener or dish washing detergent. Wring the cloth until it's almost dry, and then use it to wipe the screen.
2. Make sure the excess water is off the screen, and then let it air-dry before you turn on your Monitor.

Cleaning the Cabinet

To remove dirt or dust, wipe the cabinet with a soft, dry, lint-free cloth. Please be sure not to use a wet cloth.

Extended Absence



If you expect to leave your Monitor dormant for a long time (such as a vacation), it's a good idea to unplug the power cord to protect against possible damage from lightning or power surges.

Product Specifications

MODELS	MU-42PM11/12X/20	MU-50PM10/11/20
Width (inches / mm)	56 / 1400	56 / 1400
Height (inches / mm)	30.4 / 761.5	30.4 / 761.5
Depth (inches / mm)	11.4 / 290	11.4 / 290
Weight (pounds / kg)	103.2 / 46.8	103.2 / 46.8
Resolution	1366 x 768 (Dot)	1366 x 768 (Dot)
Power requirement	AC100-240V, 50/60Hz	
Color	16,770,000 (256 steps of each R, G and B)	
Operating Temperature Range	32 ~ 104°F (0 ~ 40°C)	
Operating Humidity Range	Less than 80%	

- The specifications shown above may be changed without notice for quality improvement.



LG ELECTRONICS, INC.
PLASMA DISPLAY PANEL — U.S. LIMITED WARRANTY

Your LG Plasma Display Panel will be repaired or replaced in accordance with the terms of this warranty, at LGE's option, if it proves to be defective in material or workmanship under normal use, during the warranty period ("Warranty Period") listed below, effective from the date ("Date of Purchase") of original consumer purchase of the product. This warranty is good only to the original purchaser of the product and effective only when used in the United States, including Alaska, Hawaii, and U.S. Territories.

WARRANTY PERIOD:

LABOR and PARTS: 2 YEARS from the Date of Purchase. Your unit will be repaired or replaced with a new, substitute model or factory reconditioned unit, at LGE's option. If repaired, parts used in the repair may be new or remanufactured.

Replacement Units and Repair Parts are warranted for the remaining portion of the original unit's warranty period.

EFFECTIVE DATE OF WARRANTY: Your warranty period begins on the date of sale to the original consumer/end user. KEEP THE DEALER'S DATED BILL OF SALE OR PROOF OF DELIVERY as evidence of the purchase date. You will be required to submit a legible copy of your bill of sale or proof of delivery when requesting warranty service.

HOW SERVICE IS HANDLED:

In-Home Service: Please retain dealer's dated bill of sale or delivery ticket as evidence of the Date of Purchase for proof of warranty, and submit a copy of the bill of sale to the service person at the time warranty service is provided.

Please call 1-201-816-2000 to locate your nearest LGE Authorized Service Center.

Visit our website at:
<http://www.lgservice.com>

THIS WARRANTY IS IN LIEU OF ANY OTHER WARRANTY, EXPRESS OR IMPLIED, INCLUDING WITHOUT LIMITATION, ANY WARRANTY OF MERCHANTABILITY OR FITNESS FOR A PARTICULAR PURPOSE. TO THE EXTENT ANY IMPLIED WARRANTY IS REQUIRED BY LAW, IT IS LIMITED IN DURATION TO THE EXPRESS WARRANTY PERIOD ABOVE. NEITHER THE MANUFACTURER NOR ITS U.S. DISTRIBUTOR SHALL BE LIABLE FOR ANY INCIDENTAL, CONSEQUENTIAL, INDIRECT, SPECIAL, OR PUNITIVE DAMAGES OF ANY NATURE, INCLUDING WITHOUT LIMITATION, LOST PROFITS, LOST OR CORRUPTED PROGRAMMING OR DATA, OR ANY OTHER DAMAGE WHETHER BASED IN CONTRACT, TORT, OR OTHERWISE. Some states do not allow the exclusion or limitation of incidental or consequential damages or limitations on how long an implied warranty lasts, so the above exclusion or limitation may not apply to you. This warranty gives you specific legal rights and you may also have other rights that vary from state to state.

CONCERNING PIXEL FUNCTIONALITY: Your Plasma Display Panel contains about one million individual pixels. Plasma Display Panel typically contain a small number of pixels that do not function normally. Your display has been inspected and is in compliance with manufacturer's specifications, indicating that any pixel defects do not effect the operation or use of your display.

IMPORTANT: Please fill out and mail in your Product Registration Card or go to www.lgservice.com to register your product online. This information will allow us to reach you promptly should we discover a safety or reliability problem that could affect you.

THIS LIMITED WARRANTY DOES NOT APPLY TO:

<ul style="list-style-type: none">● damage caused in shipping or transit● service required as a result of improper installation, including incorrect or insufficient AC supply (please consult the owner's manual for power supply requirements)● installation or repair of antenna systems, cable converters, cable company supplied equipment, or other components in a video system● set-up or adjustment on consumer controls, or damage caused by improper adjustments● damage caused by other system components● any panel that has been modified or incorporated into any other product● replacement of batteries on the remote control.● damage (including cosmetic damage), failure, loss or personal injury due to misuse, abuse, negli-	<p>gence, improper maintenance or storage, or to acts of nature or other causes beyond our control. (Causes beyond our control include but are not limited to lightning strike, power surges, power outages and water damage.)</p> <ul style="list-style-type: none">● image burn-in● repair or replacement of warranted parts by other than LGE authorized service centers.● units purchased or serviced outside of the coverage area.● product where the original factory serial numbers have been removed, defaced or changed in any way.● product sold and labeled as "as is, where is" or similar disclaimer.
---	--

The cost of repair or replacement under these excluded circumstances shall be borne by the consumer.

CUSTOMER INTERACTIVE CENTER NUMBERS:

<p>To obtain customer assistance, product information or Dealer or Service locations</p>	<p>Call 1-201-816-2000 24 hours a day, 365 days per year</p>
---	---

FOR SERVICE:

Before you call for warranty service, check your operating guide – you may avoid a service call.

For warranty service information, please contact the LGE Customer Interactive Center telephone number.

When calling for service, **please have your product model number, serial number and the date of purchase or the date of original installation available.**

If a replacement unit is required, under some circumstances you may be asked to provide a reserve deposit to the LGE Service Center against a credit card number as surety for advanced shipment. Your credit card will not be charged if you return the defective unit within 10 working days.

If a replacement unit is received, please use the carton and packaging from that unit in returning the defective unit to the LG®Brand Service Center.

Parts and service in accordance with the LGE warranty are LGE's responsibility and will be provided without charge. Other service requirements will be at the owner's expense. If you have problems in obtaining satisfactory warranty service, write or call the LGE Customer Interactive Center. Service may be provided by independently owned and operated service organizations.

To assure proper credit and avoid unnecessary charges, you must obtain an LGE Return Authorization before returning any product to the LGE Service Center. Contact the Customer Interactive Center for details.

TO CONTACT THE LGE CUSTOMER SERVICE CENTER BY MAIL:

LGE Customer Interactive Center
P.O. Box 240007
201 James Record Road
Huntsville, Alabama 35824
<http://www.lgservice.com>

P/N : 3828VA0520B @ (RF04GB)