



PLASMA MONITOR OWNER'S MANUAL

MODEL : MU-50PZ40/41
MU-50PZ40A/41A
MU-50PZ40B/41B
MU-50PZ40K/41K
MU-50PZ40R/41R
MU-50PZ40S/41S



Please read this owner's manual carefully before operating the Monitor.
Retain it for future reference.
Record model number and serial number of the Monitor.
See the label attached on the back of the Monitor and quote this information to your dealer when you require service.

Model number :
Serial number :

P/NO : 3828VA0352A (RF02CA)

WARNING



WARNING
RISK OF ELECTRIC SHOCK
DO NOT OPEN



WARNING:
TO REDUCE THE RISK OF ELECTRIC SHOCK DO NOT REMOVE COVER (OR BACK). NO USER SERVICEABLE PARTS INSIDE. REFER TO QUALIFIED SERVICE PERSONNEL.



The lightning flash with arrowhead symbol, within an equilateral triangle, is intended to alert the user to the presence of uninsulated "dangerous voltage" within the product's enclosure that may be of sufficient magnitude to constitute a risk of electric shock to persons.



The exclamation point within an equilateral triangle is intended to alert the user to the presence of important operating and maintenance (servicing) instructions in the literature accompanying the appliance.

WARNING:

TO PREVENT FIRE OR SHOCK HAZARDS, DO NOT EXPOSE THIS PRODUCT TO RAIN OR MOISTURE.

FCC NOTICE

- **MU-50PZ41/A/B/K/R/S : A Class A digital device**

This equipment has been tested and found to comply with the limits for a Class A digital device, pursuant to Part 15 of the FCC Rules. These limits are designed to provide reasonable protection against harmful interference when the equipment is operated in a commercial environment. This equipment generates, uses, and can radiate radio frequency energy and, if not installed and used in accordance with the instruction manual, may cause harmful interference to radio communications. Operation of this equipment in a residential area is likely to cause harmful interference in which case the user will be required to correct the interference at his own expense.

- **MU-50PZ40/A/B/K/R/S : A Class B digital device**

This equipment has been tested and found to comply with the limits for a Class B digital device, pursuant to Part 15 of the FCC Rules. These limits are designed to provide reasonable protection against harmful interference in a residential installation. This equipment generates, uses and can radiate radio frequency energy and, if not installed and used in accordance with the instructions, may cause harmful interference to radio communications. However, there is no guarantee that interference will not occur in a particular installation. If this equipment does cause harmful interference to radio or television reception, which can be determined by turning the equipment off and on, the user is encouraged to try to correct the interference by one or more of the following measures:

- Reorient or relocate the receiving antenna.
- Increase the separation between the equipment and receiver.
- Connect the equipment into an outlet on a circuit different from that to which the receiver is connected.
- Consult the dealer or an experienced radio/TV technician for help.

- **Any changes or modifications not expressly approved by the party responsible for compliance could void the user's authority to operate the equipment.**

WARNING

TO REDUCE THE RISK OF FIRE AND ELECTRIC SHOCK, DO NOT EXPOSE THIS PRODUCT TO RAIN OR MOISTURE.

SAFETY INSTRUCTIONS

Important safeguards for you and your new product

Your product has been manufactured and tested with your safety in mind. However, improper use can result in potential electrical shock or fire hazards. To avoid defeating the safeguards that have been built into your new product, please read and observe the following safety points when installing and using your new product, and save them for future reference.

Observing the simple precautions discussed in this booklet can help you get many years of enjoyment and safe operation that are built into your new product.

This product complies with all applicable U.S. Federal safety requirements, and those of the Canadian Standards Association.

1. Read Instructions

All the safety and operating instructions should be read before the product is operated.

2. Follow Instructions

All operating and use instructions should be followed.

3. Retain Instructions

The safety and operating instructions should be retained for future reference.

4. Heed Warnings

All warnings on the product and in the operating instructions should be adhered to.

5. Cleaning

Unplug this product from the wall outlet before cleaning. Do not use liquid cleaners or aerosol cleaners. Use a damp cloth for cleaning.

6. Water and Moisture

Do not use this product near water, for example, near a bath tub, wash bowl, kitchen sink, or laundry tub, in a wet basement, or near a swimming pool.

7. Accessories Carts and Stands

Do not place this product on a slippery or tilted surface, or on an unstable cart, stand, tripod, bracket, or table. The product may slide or fall, causing serious injury to a child or adult, and serious damage to the product. Use only with a cart, stand, tripod, bracket, or table recommended by the manufacturer, or sold with the product. Any mounting of the product should follow the manufacturer's instructions, and should use a mounting accessory recommended by the manufacturer.

8. Transporting Product

A product and cart combination should be moved with care. Quick stops, excessive force, and uneven surfaces may cause the product and cart combination to overturn.



9. Attachments

Do not use attachments not recommended by the product manufacturer as they may cause hazards.

10. Ventilation

Slots and openings in the cabinet are provided for ventilation and to ensure reliable operation of the product and to protect it from overheating, and these openings must not be blocked or covered. The openings should never be blocked by placing the product on a bed, sofa, rug, or other similar surface. This product should not be placed in a built-in installation such as a book-

case or rack unless proper ventilation is provided or the manufacturer's instructions have been adhered to.

11. Power Sources

This product should be operated only from the type of power source indicated on the marking label. If you are not sure of the type of power supply to your home, consult your product dealer or local power company. For products intended to operate from battery power, or other sources, refer to the operating instructions.

12. Power-Cord Polarization

This product is equipped with a three-wire grounding type plug, a plug having a third (grounding) pin. This plug will only fit into the grounding-type power outlet. This is a safety feature. If you are unable to insert the plug into the outlet, contact your electrician to replace your obsolete outlet. Do not defeat the safety purpose of the grounding-type plug.

13. Power-Cord Protection

Power-supply cords should be routed so that they are not likely to be walked on or pinched by items placed upon or against them, paying particular attention to cords at plugs, convenience receptacles, and the point where they exit from the product.

14. Outdoor Antenna Grounding

If an outside antenna or cable system is connected to the product, be sure the antenna or cable system is grounded so as to provide some protection against voltage surges and built-up static charges. Article 810 of the National Electrical Code (U.S.A.), ANSI/ NFPA 70 provides information with regard to proper grounding of the mast and supporting structure, grounding of the lead-in wire to an antenna discharge unit, size of grounding conductors, location of antenna-discharge unit, connection to grounding electrodes, and requirements for the grounding electrode.

Example of Grounding According to National Electrical Code Instructions

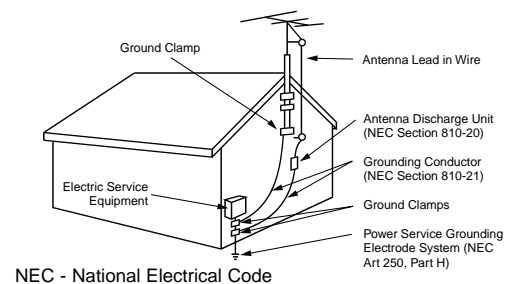

(Continued on next page)

SAFETY INSTRUCTIONS

(Continued from previous page)

15. Lightning

For added protection for this product (receiver) during a lightning storm, or when it is left unattended and unused for long periods of time, unplug it from the wall outlet and disconnect the antenna or cable system. This will prevent damage to the product due to lightning and power-line surges.

16. Power Lines

An outside antenna system should not be located in the vicinity of overhead power lines or other electric light or power circuits, or where it can fall into such power lines or circuits. When installing an outside antenna system, extreme care should be taken to keep from touching such power lines or circuits as contact with them might be fatal.

17. Overloading

Do not overload wall outlets and extension cords as this can result in a risk of fire or electric shock.

18. Object and Liquid Entry

Never push objects of any kind into this product through openings as they may touch dangerous voltage points or short-out parts that could result in a fire or electric shock. Never spill liquid of any kind on the product.

19. Servicing

Do not attempt to service this product yourself as opening or removing covers may expose you to dangerous voltage or other hazards. Refer all servicing to qualified service personnel.

20. Damage Requiring Service

Unplug this product from the wall outlet and refer servicing to qualified service personnel under the following conditions:

- a. If the power-supply cord or plug is damaged.
- b. If liquid has been spilled, or objects have fallen into the product.
- c. If the product has been exposed to rain or water.
- d. If the product does not operate normally by following the operating instructions. Adjust only those controls that are covered by the operating instructions as an improper adjustment of other controls may result in damage and will often require extensive work by a qualified technician to restore the product to its normal operation.
- e. If the product has been dropped or the cabinet has been damaged.
- f. If the product exhibits a distinct change in performance.

21. Replacement Parts

When replacement parts are required, be sure the service technician has used replacement parts specified by the manufacturer or have the same characteristics as the original part. Unauthorized substitutions may result in fire, electric shock, or other hazards.

22. Safety Check

Upon completion of any service or repairs to this product, ask the service technician to perform safety checks to determine that the product is in proper operating condition.

23. Wall or Ceiling Mounting

The product should be mounted to a wall or ceiling only as recommended by the manufacturer. The product may slide or fall, causing serious injury to a child or adult, and serious damage to the product.

24. Heat

The product should be situated away from heat sources such as radiators, heat registers, stoves, or other products (including amplifiers) that produce heat.

The PDP Manufacturing Process: Why colored dots may be present on the PDP screen

The PDP (Plasma Display Panel) which is the display device of this product is composed of 0.9 to 2.2 million cells. A few cell defects will normally occur in the PDP manufacturing process. Several colored dots visible on the screen should be acceptable. This also occurs in other PDP manufacturers' products and the dots appearing does not mean that this PDP is defective. Thus a few cell defects are not sufficient cause for the PDP to be exchanged or returned. Our production technology is designed to minimize cell defects.

Cooling Fan Noise

In the same way that a fan is used in a PC computer to keep the CPU (Central Processing Unit) cool, the PDP is equipped with cooling fans to cool the Monitor and improve its reliability. Therefore, a certain level of noise could occur while the fans are operating and cooling the PDP.

This noise doesn't have any negative effect on the PDP's efficiency or reliability. The noise from these fans is normal during the operation of this product. We hope you understand that a certain level of noise from the cooling fans is acceptable and is not sufficient cause for the PDP to be exchanged or returned.

Contents

Warnings	2
Safety Instructions	3~4
Step 1. Monitor Installation & Setup	
Controls and Connection Options	6
External Equipment Viewing Setups	7~10
Remote Control Key Functions	11
Monitor Accessories	12
Monitor Installation/Mounting Options	12
Stand Installation	12
Step 2. Customize your Monitor's Features	
Basic Features Setup and Operation	
Turning on the Monitor	13
Menu Language Selection	13
Video Menu Options	
APC (Auto Picture Control)	14
Adjusting Auto Color Control	14
Manual Color Temperature Control	14
Manual Picture Control	14
Audio Menu Options	
DASP (Digital Auto Sound Processing)	15
AVL (Auto Volume Leveler)	15
Adjusting Sound (Manual Settings)	15
Time Menu Options	
Setting the Clock	16
Setting the On/Off Timer	16
Auto Off	16
Sleep Timer	16
Special Menu Options	
Key Lock	17
Orbiter	17
White Wash	17
Screen Menu Options	
Auto Adjustment	18
Setting Picture Format	18
Split Zoom	18
Screen Position	19
Manual Configure	19
Screen Adjustments	19
Initializing	19
PIP (Picture In Picture) Feature	
Watching PIP/PIP Size/PIP Aspect Ratio	20
Swapping PIP/ Moving PIP	20
Selecting a Input Signal Source for PIP	20
Main Picture Size Adjustment	20
Main Picture Position Adjustment	20
Twin Picture Setup Options	
Main Picture Size Adjustment	21
Sub Picture Size Adjustment	21
Selecting a Source for the Twin Picture	21
Swapping the Twin Picture	21
Step.3 Miscellaneous	
External Control Device Setup	22
IR Code (NEC format)	27
Maintenance	29
Troubleshooting Checklist	30
Specifications	31

After reading this manual, keep it handy for future reference.

Monitor Controls

Front Panel Controls

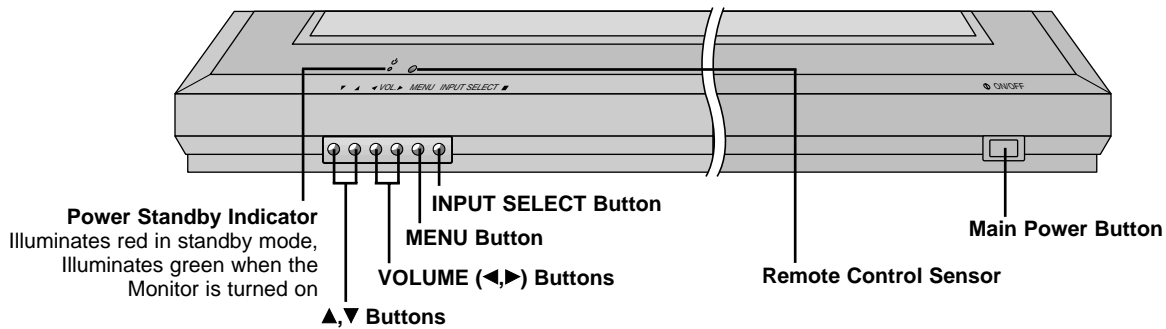

Connection Options

Back Connection Panel

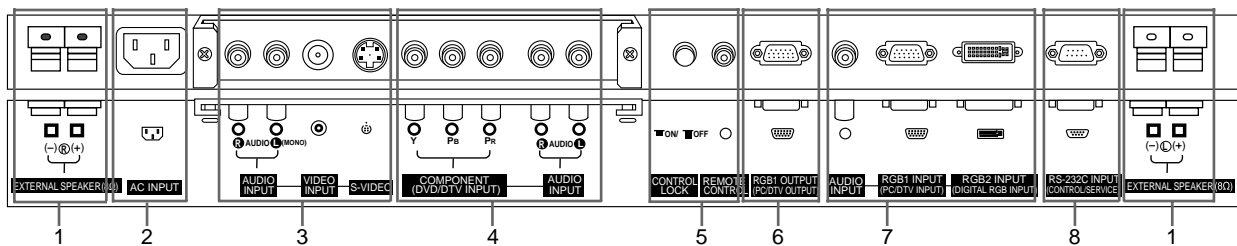

1. **EXTERNAL SPEAKER (8 ohm output)**
Connect to optional external speaker(s).
*For further information, refer to 'Speaker & Speaker Stand' manual.
2. **POWER CORD SOCKET**
This Monitor operates on an AC power. The voltage is indicated on the Specifications page. Never attempt to operate the Monitor on DC power.
3. **AUDIO/VIDEO INPUT JACKS**
Connect audio/video out from external equipment to these jacks.
S-VIDEO INPUTS (S-VIDEO)
Connect video out from an S-VIDEO VCR to the S-VIDEO input.
4. **COMPONENT(DVD/DTV INPUT)/AUDIO INPUT JACKS**
5. **CONTROL LOCK Switch**
REMOTE CONTROL
When "CONTROL LOCK" is set "ON", Monitor is operated by the external control device.
6. **RGB1 OUTPUT(PC/DTV OUTPUT) JACKS**
You can watch the RGB1 signal on another monitor, connect RGB1 OUTPUT (PC/DTV OUTPUT) to another monitor's PC input port.
7. **AUDIO INPUT/RGB1 INPUT(PC/DTV INPUT)/RGB2 INPUT(DIGITAL RGB INPUT) JACKS**
Connect the monitor output socket of the PC to this socket.
8. **RS-232C INPUT(CONTROL/SERVICE) PORT**
Connect to the RS-232C port on a PC.

External Equipment Connections

Monitor External Equipment Connection Panel

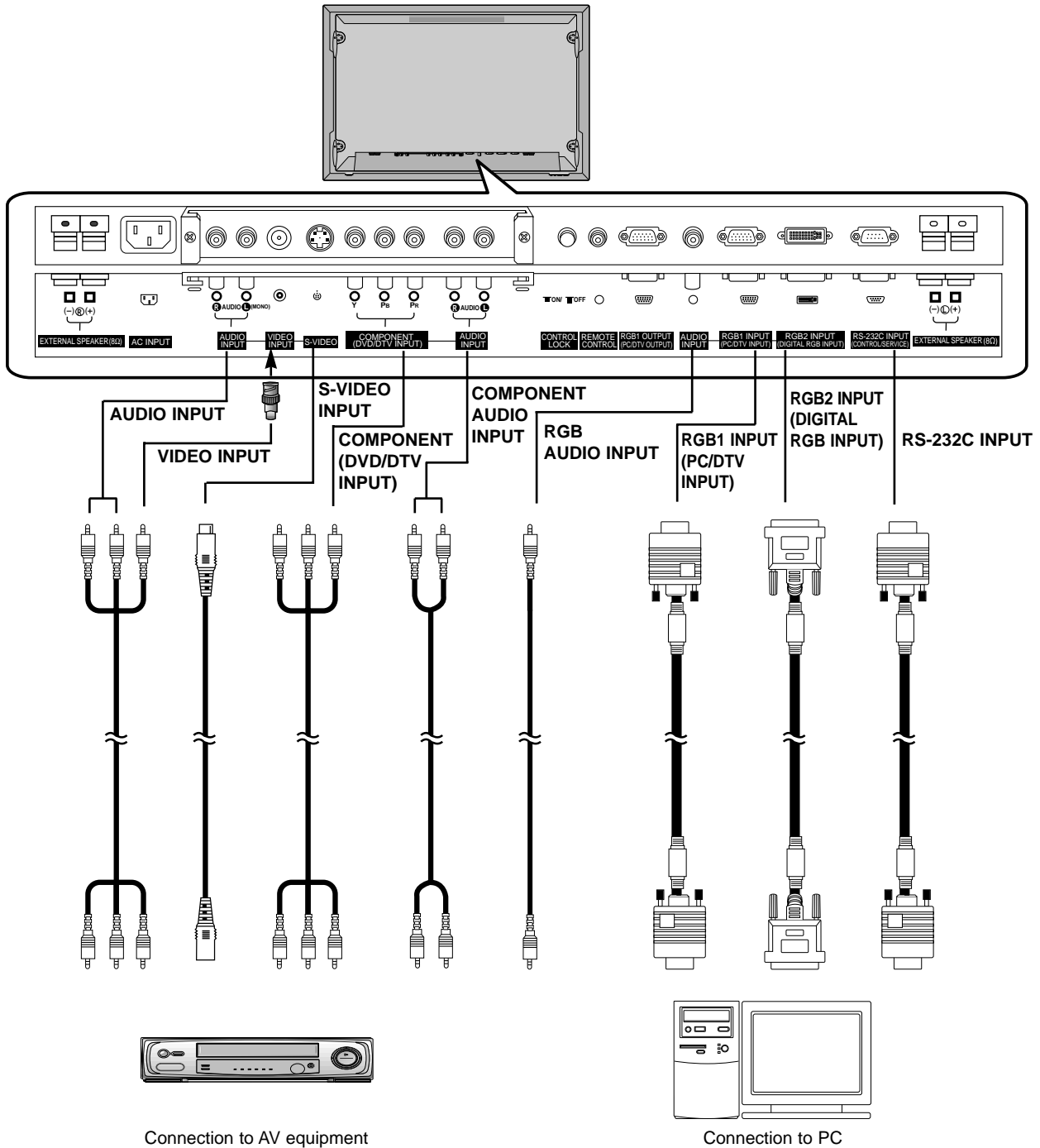

Note: All cables shown are not provided with the Monitor, except:
A D-sub 15 pin cable and DVI cable is supplied to connect the Monitor to a PC.

External Equipment Viewing Setups

Watching VCR Setup

- When connecting the Monitor to external equipment, match the colors of connecting ports (Video - yellow, Audio (L) - white, Audio (R) -red).
- Connect the VIDEO INPUT socket (yellow) with the BNC-RCA adapter to the VIDEO INPUT on the Monitor.
- If you have a mono VCR, connect the audio cable from the VCR to the AUDIO (L/MONO) input on the Monitor.
- If you connect an S-VIDEO VCR to the S-VIDEO input, the picture quality is improved; compared to connecting a regular VCR to the Video input.
- Use the orbiter function to Avoid having a fixed image remain on the screen for a long period of time. Typically a frozen still picture from a VCR.
If a 4:3 picture format is used; the fixed image may remain visible on the screen.
- To avoid picture noise (interference), leave an adequate distance between the VCR and Monitor

1. Use the **INPUT SELECT** button on the remote control to select **VIDEO**.
(If connected to S-VIDEO, select the **S-VIDEO** external input source.)
2. Insert a video tape into the VCR and press the **PLAY** button on the VCR. (See VCR owner's manual)

Watching Cable TV Setup

- After subscribing to a cable TV service from a local provider and installing a converter, you can watch cable TV programming. This monitor cannot display TV programming unless a TV tuner device or cable TV converter box is connected to the Monitor.
- For further information regarding cable TV service, contact your local cable TV service provider(s).

1. Use the **INPUT SELECT** button on the remote control and select **VIDEO**.
2. Tune to cable service provided channels using the cable box.

Watching External A/V Source Setup

- When connecting the monitor to an external source, match the colors of AUDIO/VIDEO input jacks on the monitor with the output jacks on the audio/video equipment: Video = yellow, Audio (Left) = white, Audio (Right) = red.

1. Use the **INPUT SELECT** button on the remote control to select **VIDEO**.
2. Operate the corresponding external equipment. See external equipment operating guide.

Watching DVD Setup

How to connect

Connect DVD video inputs to Y, P_B, P_R of COMPONENT (DVD/DTV INPUT) and audio inputs to Audio sockets of AUDIO INPUT.

How to use

1. Turn on the DVD player, and insert a DVD.
2. Use **INPUT SELECT** button on the remote control to select **COMPONENT**. Refer to the DVD player's manual for operating instructions.

• Component Input ports

You can get better picture quality if you connect DVD player with component input ports as below.

Component ports of the Monitor	Y	P _B	P _R
--------------------------------	---	----------------	----------------

Video output ports of DVD player	Y	P _b	P _r
	Y	B-Y	R-Y
	Y	P _B	P _R

Watching DTV Setup

- To watch digitally broadcast programs, purchase/connect a digital SET-TOP BOX.

How to connect a user-supplied Digital Set-Top Box

- Connect DTV set-top box video output to monitor COMPONENT (DVD/DTV INPUT) or to the monitor RGB1 (PC/DTV INPUT) connector depending on your Set Top Box connectors.
- Connect DTV set-top box audio outputs to monitor AUDIO INPUT jacks.

How to use

1. Turn on the digital SET-TOP BOX. (Refer to the owner's manual for the digital SET-TOP BOX.)
2. Use **INPUT SELECT** on the remote control to select **COMPONENT** or **RGB 1**.

PC Setup

- To enjoy vivid picture and sound, connect a PC to the Monitor.
- Avoid keeping a fixed image on the monitor's screen for a long period of time. The fixed image may become permanently imprinted on the screen; use a screen saver when possible.
- Connect PC to the RGB1 INPUT(PC/DTV INPUT) or RGB2 INPUT(DIGITAL RGB INPUT) port of the Monitor; change the resolution output of PC accordingly.
- Synchronization input form; Separate

Setup Instructions to Connect a PC to your Monitor

- If the resolution of PC is over UXGA, there will be no picture on the Monitor.
- Connect the signal cable from the monitor output port of the PC to the RGB1 INPUT(PC/DTV INPUT) port of the Monitor or the signal cable from the DVI output port of the PC to the RGB2 INPUT(DIGITAL RGB INPUT) port on the Monitor.
- Connect the audio cable from the PC to the Audio input on the Monitor. (Audio cables are not included with the Monitor).
- If using a sound card, adjust PC sound as required.
- This monitor apply a VESA Plug and Play Solution. The monitor provides EDID data to the PC system with a DDC protocol. The PC adjusts automatically to use this monitor.
- DDC protocol is preset for RGB1 (Analog RGB), RGB2 (DVI, Digital RGB) mode.
- If required, adjust the monitor settings for Plug and Play functionally.
- If graphic card on the PC does not output analog and digital RGB simultaneously, connect only one of both RGB1 INPUT (PC/DTV INPUT) or RGB2 INPUT (DIGITAL RGB INPUT) to display the PC on the monitor.
If graphic card on the PC does output analog and digital RGB simultaneously, set the monitor to either RGB1 or RGB2; (the other mode is set to Plug and Play automatically by the monitor.)
- The monitor perceives 640x480, 60Hz as DTV 480p based on the PC graphic card. In this case, change the screen scanning rate for the graphic card.

PC Setup

1. Turn on the PC and apply power to the Monitor.
2. Turn on the display by pressing the **POWER** button on the Monitor's remote control.
3. Use the **INPUT SELECT** button on the remote control to select the RGB1 or RGB2 input source.
4. Set the resolution output of the PC to SXGA or under (1280 x 1024, 75Hz).

Monitor Display Specifications

RGB1 Mode

Resolution	Horizontal Frequency(KHz)	Vertical Frequency(Hz)	DDC	Resolution	Horizontal Frequency(KHz)	Vertical Frequency(Hz)	DDC
640x350	31.468	70.09		832x624	49.725	74.55	o
	37.861	85.08		1024x768	48.363	60.00	o
720x400	31.469	70.08	56.476		70.06	o	
	37.927	85.03	60.023		75.02	o	
640x480	31.469	59.94	o		1152x864	68.677	84.99
	35.000	66.66	o	54.348		60.05	o
	37.861	72.80	o	63.995		70.01	o
	37.500	75.00	o	67.500		75.00	o
	43.269	85.00	o	77.487	85.05	o	
	45.913	90.03	1152x870	68.681	75.06	o	
	53.011	100.04		1280x960	75.000	75.00	o
64.062	120.00	1280x1024		63.981	60.02	o	
800x600	35.156	56.25	o	79.976	75.02	o	
	37.879	60.31	o				
	46.875	75.00	o				
	53.674	85.06	o				
	56.000	90.00					
	64.016	100.00					

RGB2 Mode

Resolution	Horizontal Frequency(KHz)	Vertical Frequency(Hz)	DDC	Resolution	Horizontal Frequency(KHz)	Vertical Frequency(Hz)	DDC
640x350	31.468	70.09		832x624	49.725	74.55	o
	37.861	85.08		1024x768	48.363	60.00	o
720x400	31.469	70.08	56.476		70.06	o	
	37.927	85.03	60.023		75.02	o	
640x480	31.469	59.94	o		68.677	84.99	o
	35.000	66.66	o	1152x864	54.348	60.05	o
	37.861	72.80	o		63.995	70.01	o
	37.500	75.00	o		67.500	75.00	o
43.269	85.00	o	77.487		85.05	o	
800x600	35.156	56.25	o	1152x870	68.681	75.06	o
	37.879	60.31	o	1280x960	60.000	60.00	o
	48.077	72.18	o		75.000	75.00	o
	46.875	75.00	o	1280x1024	63.981	60.02	o
	53.674	85.06	o				

- Dos mode may not work depending on video card if using a DVI-I cable.

Remote Control Key Functions

- When using the remote control aim it at the remote control sensor of the Monitor.
- There's maybe a defect in consecutive operation of remote control in specified brightness according to this monitor feature.

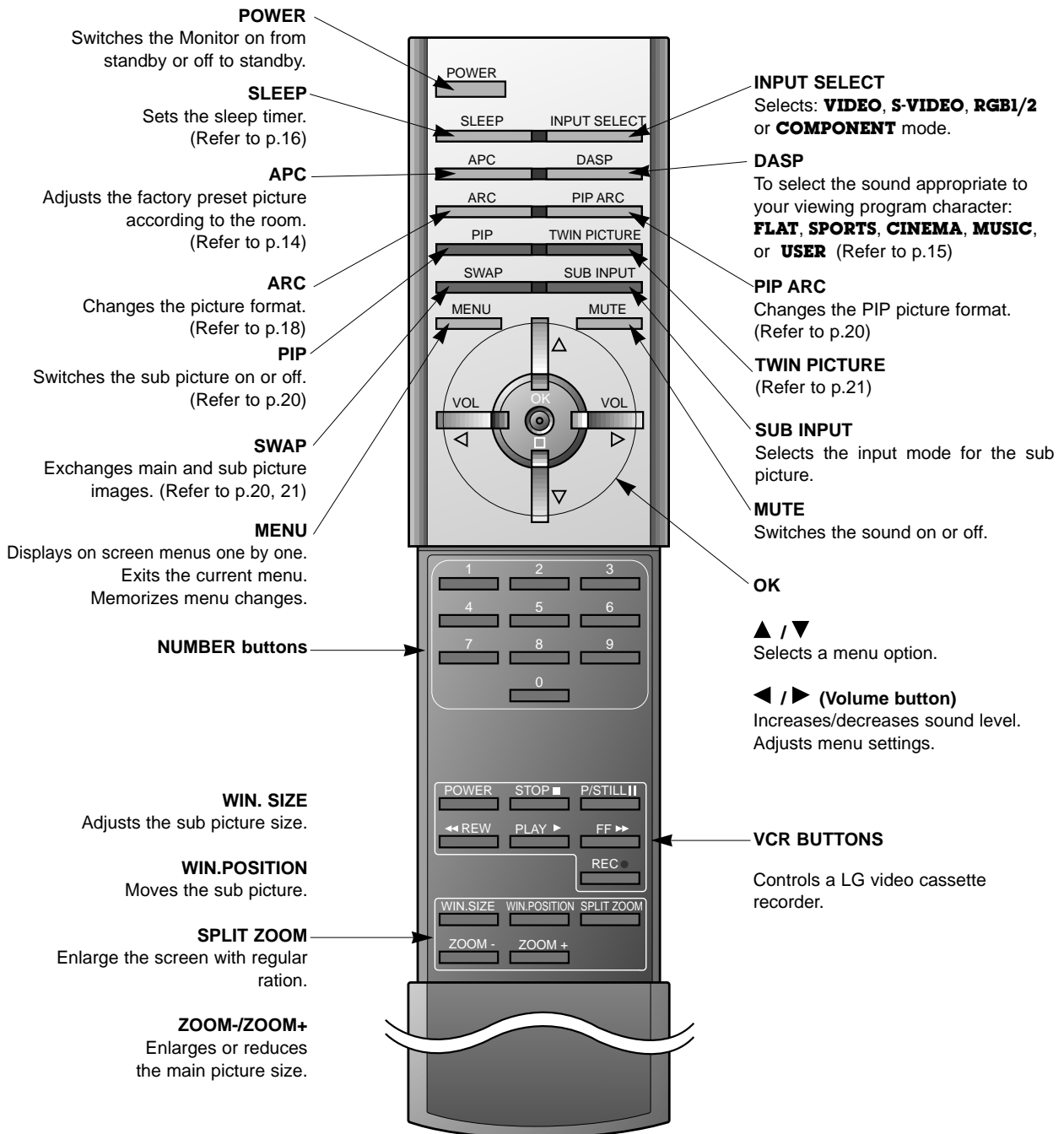

Installing Batteries

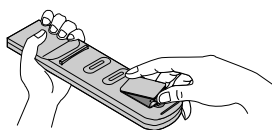

- Open the battery compartment cover on the back side and insert the batteries with correct polarity.
- Install two 1.5V alkaline batteries of AAA type. Don't mix used batteries with new batteries.

Monitor overview

Accessories



Owner's Manual

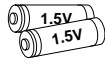

Alkaline batteries



BNC-RCA adapter



Remote Control

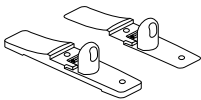

Simple Monitor Stand

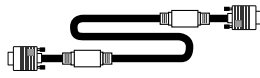

D-sub 15 pin cable



Power Cord



DVI Cable

Monitor Installation Options

- The Monitor can be installed in various ways such as on a wall, or on a desktop etc.
- Install this monitor only in a location where adequate ventilation is available.
- It is recommended that this product only be used at an altitude of less than 6561 feet (2000m) to get the best quality picture and sound.

To Mount on a Wall

Wall mount minimum allowable clearances for adequate ventilation.

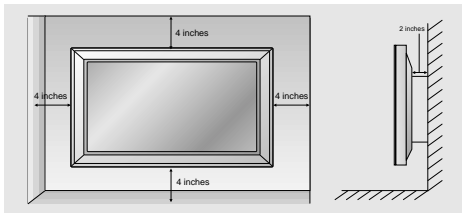

To Install on a Desktop

Pedestal mount minimum allowable clearances for adequate ventilation.

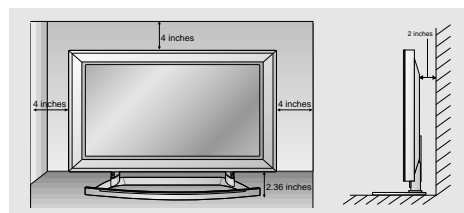

Stand Installation

1. Make sure to secure the stand to the display platform using M8 bolts (commercially available) 1 inch (25mm) longer than the thickness of the platform.

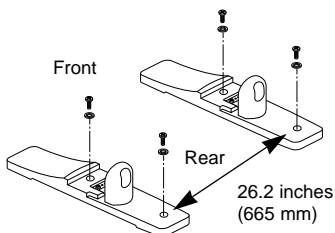

2. Align the holes on the monitor and stand.

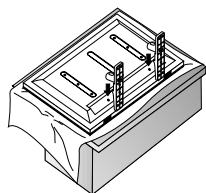

3. Use the two (2) bolts provided to attach the stand to the monitor. Tighten each bolt securely in a clockwise direction.

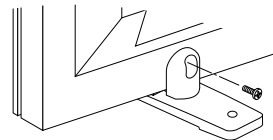

The monitor weigh 99.2 pounds (45kg) and its thinness makes it unstable. Therefore, unpacking and installation should be performed by two or more persons.

Turning on the Monitor

- When using the remote control, aim it at its sensor on the Monitor.

Turning on the Monitor just after installation

1. Connect power cord correctly.
2. Press the **⓪ ON/OFF** button on the Monitor. At this moment, the Monitor is switched to standby mode. Press the **INPUT SELECT** button on the Monitor or press the **POWER, INPUT SELECT** button on the remote control and then the Monitor will switch on.

Turning on the Monitor (power cord is still connected)

1. **If the Monitor was turned off with the **⓪ ON/OFF** button on the Monitor**
 - Press the **⓪ ON/OFF** button on the Monitor to turn the Monitor on.
2. **If the Monitor was turned off with the remote control or the ON/OFF button on the Monitor**
 - Press the **⓪ ON/OFF** button on the Monitor and then press the **INPUT SELECT** button on the Monitor or press the **POWER, INPUT SELECT** button on the remote control to turn the Monitor on.

Menu Language Selection

- The menus can be shown on the screen in the selected language. First select your language.

1. Press the **MENU** button and then use **▲ / ▼** button to select the **SPECIAL** menu.
2. Press the **▶** button and then use **▲ / ▼** button to select **LANGUAGE**.
3. Press the **▶** button and then use **▲ / ▼** button to select your desired language.
From this point on, the on-screen menus will be shown in the language of your choice.
4. Press the **MENU** button.



Video Menu Options

APC (Auto Picture Control)

- This function adjusts the Monitor to the best picture appearance

1. Press the **APC** button to select the picture appearance setup option.

- Each press of the **APC** button changes the screen display as shown below.



- You can also select **CLEAR**, **SOFT** or **USER** in the **VIDEO** menu.
- Picture options **CLEAR** and **SOFT** are preset and programmed for good picture quality at the factory and cannot be changed.

Adjusting Auto Color Control

- To initialize values (reset to default settings), select the **NORMAL** option.

1. Press the **MENU** button and then use **▲ / ▼** button to select the VIDEO menu.

2. Press the **▶** button and then use **▲ / ▼** button to select **ACC**.

3. Press the **▲ / ▼** button to select the desired color temperature.

- Each press of **▲ / ▼** button changes the screen display as shown.

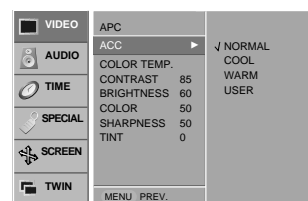
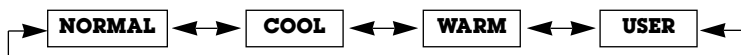

Manual Color Temperature Control (User option)

- You can adjust red, green, or blue to any color temperature you prefer.

1. Press the **MENU** button and then use **▲ / ▼** button to select the VIDEO menu.

2. Press the **▶** button and then use **▲ / ▼** button to select the **COLOR TEMP.** option.

3. Press the **▶** button and then use **▲ / ▼** button to select a color.

4. Use the **◀ / ▶** button to make appropriate adjustments.

5. Press the **MENU** button.

- The adjustment range of **RED**, **GREEN** and **BLUE** is -10~+10.

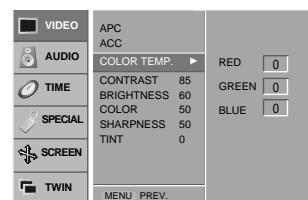

Manual Picture Control (User option)

- You can adjust picture contrast, brightness, color, sharpness and tint to the levels you prefer.

- PIP settings are not adjustable.

1. Press the **MENU** button and then use **▲ / ▼** button to select the VIDEO menu.

2. Press the **▶** button and then use **▲ / ▼** button to select the desired picture option.

3. Press the **▶** button and then use **◀ / ▶** button to make appropriate adjustments.

4. Press the **MENU** button.

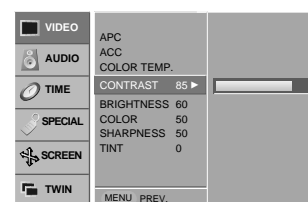

Audio Menu Options

DASP (Digital Auto Sound Processing)

- This function lets you enjoy the best sound without any special adjustment because the Monitor automatically selects the appropriate sound option based on the program content.

1. Press the **DASP** button to select the picture appearance setup.



- You can also select **FLAT**, **SPORTS**, **CINEMA**, **MUSIC**, or **USER** in the **AUDIO** menu.

AVL (Auto Volume Leveler)

- This feature maintains an equal volume level; even if you change channels.

1. Press the **MENU** button and then use **▲ / ▼** button to select the **AUDIO** menu.
2. Press the **▶** button and then use **▲ / ▼** button to select **AVL**.
3. Press the **▶** button and then use **▲ / ▼** button to select **ON** or **OFF**.
4. Press the **MENU** button.

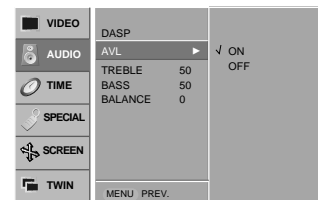

Adjusting Sound (Manual Setting)

1. Press the **MENU** button and then use **▲ / ▼** button to select the **AUDIO** menu.
2. Press the **▶** button and then use **▲ / ▼** button to select the desired sound item.
3. Press the **▶** button and then use **◀ / ▶** button to make appropriate adjustments.
4. Press the **MENU** button.

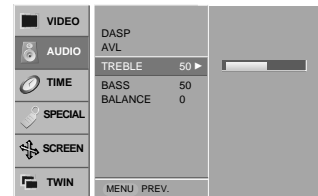

Time Menu Options

Setting the Clock

- If current time setting is erased by a power failure, if TV is unplugged or if the monitor is turned off with the ① ON/OFF button on the monitor, reset the clock.

1. Press the **MENU** button and then use ▲ / ▼ button to select the TIME menu.
2. Press the ► button and then use ▲ / ▼ button to select **CLOCK**.
3. Press the ► button and then use ▲ / ▼ button to set the hour.
4. Press the ► button and then use ▲ / ▼ button to set the minutes.
5. Press the **MENU** button.



Setting the On/Off Timer

- Timer function operates only if current time has been already set.
 - Off-Timer function overrides On-Timer function if they are set to the same time.
 - The monitor must be in standby mode for the On Timer to work.

1. Press the **MENU** button and then use ▲ / ▼ button to select the TIME menu.
2. Press the ► button and then use ▲ / ▼ button to select **OFF TIMER/ON TIMER**.
3. Press the ► button and then use ▲ / ▼ button to select **ON**.
4. Press the ► button and then use ▲ / ▼ button to set the hour.
5. Press the ► button and then use ▲ / ▼ button to set the minutes.
6. **For only ON TIMER function;** Press the ► button and then use ▲ / ▼ button to set volume level.
7. Press the **MENU** button.



- To cancel **ON/OFF TIMER** function
 Press the ▲ / ▼ button to select **OFF** in step 3.

Auto Off

- If there is no input signal, the Monitor turns off automatically after 10 minutes.

1. Press the **MENU** button and then use ▲ / ▼ button to select the TIME menu.
2. Press the ► button and then use ▲ / ▼ button to select **AUTO OFF**.
3. Press the ► button and then use ▲ / ▼ button to select **ON** or **OFF**.
4. Press the **MENU** button.



Sleep Timer

- Sleep timer turns the Monitor off at the preset time.
 - Press the **SLEEP** button to select the number of minutes. The display Ⓛ^{zz} --- **MIN** will appear on the screen, followed by **10, 20, 30, 60, 90, 120, 180** and **240**. The timer begins to count down from the number of minutes selected.
 - When the sleep time you want is displayed on the screen, press the **OK** button.

- a. To check the remaining sleep time, press the SLEEP or OK button once.
- b. To cancel the sleep time, repeatedly press the SLEEP button until the display Ⓛ^{zz} --- **MIN** appears.
- c. If you turn the monitor off after setting the sleep timer, the setting will be erased.

Special Menu Options

Key Lock

- The monitor can be set up so that it can only be used with the remote control.
- This feature can be used to prevent unauthorized viewing.

1. Press the **MENU** button and then use **▲ / ▼** button to select the **SPECIAL** menu.
2. Press the **▶** button and then use **▲ / ▼** button to select **KEY LOCK**.
3. Press the **▶** button and then use **▲ / ▼** button to select **ON** or **OFF**.
4. Press the **MENU** button.

With the lock on, the display **KEY LOCK** appears on the screen if any button on the front panel is pressed while viewing the monitor.



- This Monitor is programmed to remember which option it was last set to even if you turn the monitor off.
- In **KEY LOCK 'ON'**, if the monitor is turned off with the remote control, press the **INPUT SELECT** button on the monitor or **POWER, INPUT SELECT** on the remote control.
- With the **KEY LOCK ON**, the display '▲ KEY LOCK' appears on the screen if any button on the front panel is pressed.

Orbiter

- Avoid allowing a fixed image to remain on the Monitor's screen for a long period of time. A frozen still picture from a PC/video game displayed on the screen for prolonged periods will result in an ghost image remaining even when you change the image.
- To avoid a permanent image on the screen, the screen will move every 2 minutes:
Right → Right → Downside → Downside → Left → Left → Upside → Upside
- The Orbiter feature may help prevent ghost images. However, it is best not to allow any fixed image to remain on the screen.

1. Press the **MENU** button and then use **▲ / ▼** button to select the **SPECIAL** menu.
2. Press the **▶** button and then use **▲ / ▼** button to select **ORBITER**.
3. Press the **▶** button and then use **▲ / ▼** button to select **ON** or **OFF**.
4. Press the **MENU** button.



White Wash

- White Wash removes permanent images from the screen.
- Set **White Wash 'ON'** until fixed image disappears.
- A excessive permanent image is impossible to clear with using this function perfectly.

1. Press the **MENU** button and then use **▲ / ▼** button to select the **SPECIAL** menu.
2. Press the **▶** button and then use **▲ / ▼** button to select **WHITE WASH**.
3. Press the **▶** button and then use **▲ / ▼** button to select **ON** or **OFF**.
 - When you select **ON**, the screen changes to white.
4. Press the **MENU** button.



Screen Menu Options

Auto Adjustment

- RGB1 (PC) mode only; This function doesn't work in RGB1-Digital broadcast.
 - Automatically adjusts picture position and minimizes image shaking.
1. Press the **MENU** button and then use **▲ / ▼** button to select the **SCREEN** menu.
 2. Press the **▶** button and then use **▲ / ▼** button to select **AUTO CONFIG.**
 3. Press the **▶** button to run Auto configure.
 - When **AUTO CONFIG.** has finished, **OK** will be shown on screen.
 - If the position of the image is still not correct, try Auto adjustment again.
 4. If picture needs to be adjusted more after Auto adjustment in RGB1(PC), you can adjust the **MANUAL CONFIG.**



- Although the image is still not correct, your Monitor is functioning properly but needs further adjustment.
- The **AUTO CONFIG.** and the **MANUAL CONFIG.** can be adjust automatically for RGB 2 mode.

Setting Picture Format

- You are available to 4:3 and 16:9 in RGB1,RGB2 and COMPONENT(DTV).
 - You are available to 16:9, 4:3 and ZOOM in VIDEO and S-VIDEO.
 - If 4:3 is on the screen for a long time, that fixed image may remain visible.
1. Press the **ARC** button to select a desired picture format.
 - Each press of **ARC** button changes the screen display as shown below.
 - You can also select **4:3**, **16:9** or **ZOOM** in the **SCREEN** menu.



Split Zoom

- This is the function to enlarge the screen with regular ration.
 - It's available to use this function in every input source.
 - with 2-SPLIT ZOOM, you can only move the screen into upside or downside.
 - If a screen is enlarged, a screen can move without selecting section of screen Split Zoom.
1. Press the **SPLIT ZOOM** button.
 - Each press of **SPLIT ZOOM** button changes the screen display as shown below.



In case of 9-SPLIT ZOOM:

Press the number button to select the section you enlarge.

If you choose No.5, the 5 section is enlarged and also can move the enlarged screen with using the **▲ / ▼ / ◀ / ▶** button.



In case of choosing the No.5



The 5 section is changed to a full screen.

Screen Position

- This function works in the following mode:
RGB1-PC, RGB1-DTV 480p,720p,1080i, COMPONENT 480p,720p,1080i.
1. Press the **MENU** button and then use **▲ / ▼** button to select the **SCREEN** menu.
 2. Press the **▶** button and then use **▲ / ▼** button to select **POSITION**.
 3. Press the **▶** button and then use **▲ / ▼ / ◀ / ▶** button to adjust the position.
 4. Press the **MENU** button.

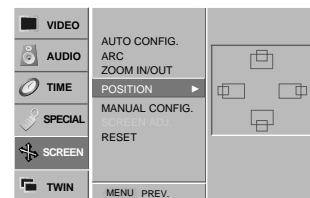

Manual Configure (RGB1 [PC] mode only)

- If the picture isn't clear after auto adjustment and especially if characters are still jittery, adjust the picture phase manually.
 - To correct the screen size, adjust **CLOCK**.
1. Press the **MENU** button and then use **▲ / ▼** button to select the **SCREEN** menu.
 2. Press the **▶** button and then use **▲ / ▼** button to select **MANUAL CONFIG.**
 3. Press the **▶** button and then use **▲ / ▼** button to select **PHASE** or **CLOCK**.
 4. Use the **◀ / ▶** button to make appropriate adjustments.
 - The adjustment range of **PHASE** is 0 ~ 31.
 - The adjustment range of **CLOCK** is -50 ~ +50.
 5. Press the **MENU** button.



Screen Adjustments (VIDEO, S-VIDEO and COMPONENT 480i mode only)

- Use this function to correct jittering or picture instability while viewing a video tape.
1. Press the **MENU** button and then use **▲ / ▼** button to select the **SCREEN** menu.
 2. Press the **▶** button and then use **▲ / ▼** button to select **SCREEN ADJ.**
 3. Press the **▶** button and then use **▲ / ▼** button to select **TV** or **VCR**.
 - Select the **VCR** option if watching a VCR.
 - Select the **TV** option for other equipment.(Except VCR)
 4. Press the **MENU** button.

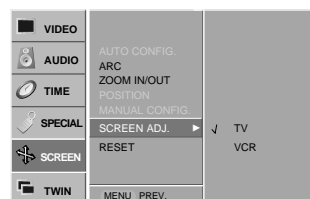

Initializing (Reset to original factory value)

- This function operates in every mode.
 - To initialize the adjusted value
1. Press the **MENU** button and then use **▲ / ▼** button to select the **SCREEN** menu.
 2. Press the **▶** button and then use **▲ / ▼** button to select **RESET**.
 3. Press the **▶** button.
 - You can initialize ZOOM IN/OUT, POSITION, SPLIT ZOOM, PIP size, PIP position and sub picture size for twin picture.

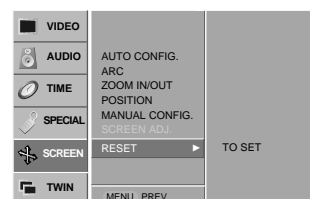

PIP (Picture-in-Picture) Feature

- PIP lets you view 2 different inputs (sources) on your monitor screen at the same time. One source will be large, and the other source will show a smaller inset image.
- When you select PC or DTV for main picture in PIP, you can watch VIDEO, S-VIDEO or COMPONENT 480i for sub picture.

Watching PIP

Press the **PIP** button to show the sub picture.

- Press the PIP button again to turn PIP off.



PIP Size

Press the **WIN.SIZE** button and then use **◀ / ▶** button to change the sub picture size.



PIP Aspect Ratio

Press the **PIP ARC** button.

- The sub picture appears as below.

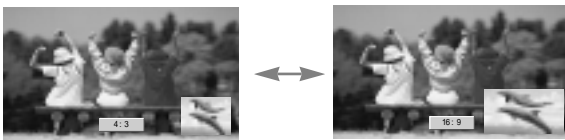

Swapping the PIP

Press the **SWAP** button to exchange the main and sub pictures.

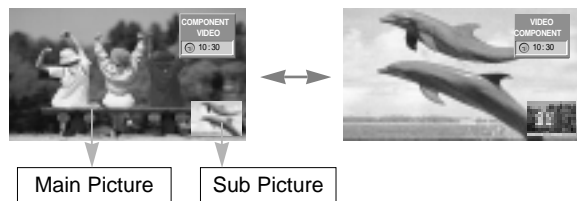

Moving the PIP

Press the **WIN.POSITION** button.

Press the **▲ / ▼ / ◀ / ▶** button repeatedly until desired position is achieved. The sub picture moves up/down/left/right.



Selecting a Input Signal Source for the PIP

Press the **SUB INPUT** button to select the input source for the sub picture.



- In RGB1 and RGB2 for main picture, you can select COMPONENT 480i, VIDEO and S-VIDEO for sub picture.
- In VIDEO and S-VIDEO for main picture, you can select COMPONENT 480p/720p/1080i, RGB1 and RGB2 for sub picture.
- In COMPONENT 480p/720p/1080i for main picture, you can select VIDEO and S-VIDEO for sub picture.
- In COMPONENT 480i for main picture, you can select RGB1 and RGB2 for sub picture.

Main Picture Size Adjustment

Press the **ZOOM+/ZOOM-** button to enlarge or reduce the main picture size when viewing the PIP.

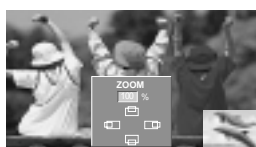

Main Picture Position Adjustment

Adjust the main picture position with the **▲ / ▼ / ◀ / ▶** buttons in enlarged main picture mode.

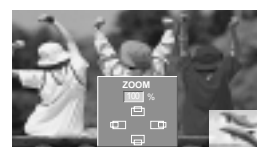

Twin Picture

Main Picture Size Adjustment

Use the **TWIN PICTURE** button.

- Each press of the **TWIN PICTURE** button cycles through the screen displays shown below.



Sub Picture Size Adjustment

Use the **WIN.SIZE** button.

- Use the ◀/▶ button to adjust the sub picture size.
- Using WIN.SIZE function in Twin Picture mode, main and sub picture are adjusted simultaneously.
- Using WIN.SIZE function in PIP mode, sub picture is adjusted.
- WIN.POSITION is not functional in twin picture mode.



Selecting a Source for the Twin Picture

Use the **SUB INPUT** button to select the input source for the sub picture.



- Using sources RGB1 or RGB2 for main picture, you can select COMPONENT 480i, VIDEO, or S-VIDEO for sub picture.
- Using sources VIDEO or S-VIDEO for main picture, you can select COMPONENT 480p/720p/1080i, RGB1, or RGB2 for sub picture.
- Using sources COMPONENT 480p/720p/1080i for main picture, you can select VIDEO, or S-VIDEO for sub picture.
- Using sources COMPONENT 480i for main picture, you can select RGB1, or RGB2 for sub picture.

Swapping the Twin Picture

Use the **SWAP** button to switch the main and sub pictures in twin picture mode.



External Control Device Setup

- Connect the RS-232C input jack to an external control device (such as a computer or an A/V control system) and control the Monitor's functions externally.
- Connect the serial port of the control device to the RS-232C jack on the Monitor back panel.
- RS-232C connection cables are not supplied with the Monitor.

Type of connector; D-Sub 9-pin male

No.	Pin name
1	No connection
2	RXD (Receive data)
3	TXD (Transmit data)
4	DTR (DTE side ready)
5	GND
6	DSR (DCE side ready)
7	RTS (Ready to send)
8	CTS (Clear to send)
9	No Connection

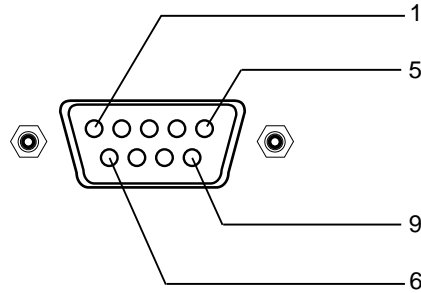

RS-232C configurations

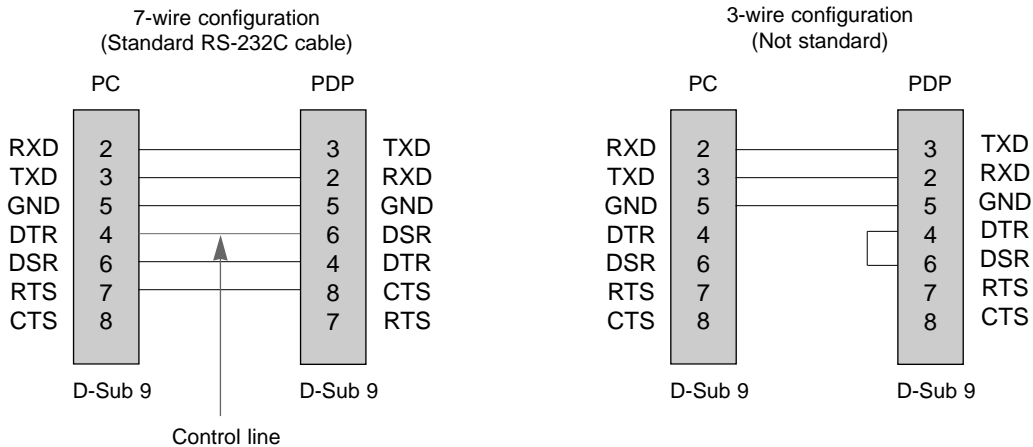

Set ID

- Use this function to specify a monitor ID number.
 - Refer to 'Real Data Mapping 1'. See page 24.
1. Press the **MENU** button and then use the **▲ / ▼** button to select the **SPECIAL** menu.
 2. Press the **▶** button and then use **▲ / ▼** button to select **SET ID**.
 3. Press the **▶** button and then use **◀ / ▶** button to adjust **SET ID** to choose the desired monitor ID number.
 - The adjustment range of **SET ID** is 1 ~ 99.



Communication Parameters

- Baud rate : 115200 bps (UART)
- Data length : 8 bits
- Parity : None
- Stop bit : 1 bit
- Communication code : ASCII code

Command Reference List

	COMMAND 1	COMMAND 2	DATA (Hexadecimal)
01. Power	k	a	0 ~ 1
02. Input Select	k	b	0 ~ 4
03. Aspect Ratio	k	c	0 ~ 2
04. Screen Mute	k	d	0 ~ 1
05. Volume Mute	k	e	0 ~ 1
06. Volume Control	k	f	0 ~ 64
07. Contrast	k	g	0 ~ 64
08. Brightness	k	h	0 ~ 64
09. Color	k	i	0 ~ 64
10. Tint	k	j	0 ~ 64
11. Sharpness	k	k	0 ~ 64
12. OSD select	k	l	0 ~ 1
13. Remote control lock mode	k	m	0 ~ 1
14. PIP/Twin	k	n	0 ~ 3
15. PIP size	k	o	0 ~ 1
16. PIP position	k	q	0 ~ 3
17. Treble	k	r	0 ~ 64
18. Bass	k	s	0 ~ 64
19. Balance	k	t	0 ~ 64
20. Color temperature	k	u	0 ~ 3
21. Red adjustment	k	v	0 ~ 64
22. Green adjustment	k	w	0 ~ 64
23. Blue adjustment	k	\$	0 ~ 64
24. PIP input source	k	y	0 ~ 4
25. Orbiter	j	p	0 ~ 1
26. White Wash	j	q	0 ~ 1
27. Orbiter Time Setting	j	r	1 ~ FE
28. Orbiter Pixel Setting	j	s	0 ~ 9

* When setting the 25 ~ 28, a menu doesn't display on screen.

Transmission / Receiving Protocol

Transmission

[Command1][Command2][][Set ID][][Data][Cr]

- * [Command 1] : k
- * [Command 2] : To control PDP set.
- * [Set ID] : You can adjust the set ID to choose desired monitor ID number in special menu. See previous page.
Adjustment range is 1 ~ 99.
When selecting Set ID '0', every connected PDP set is controlled.
- * [DATA] : To transmit command data.
Transmit 'FF' data to read status of command.
- * [Cr] : Carriage Return
ASCII code '0x0D'
- * [] : ASCII code 'space (0x20)'

OK Acknowledgement

[Command2][][Set ID][][OK][Data][x]

* The Monitor transmits ACK (acknowledgement) based on this format when receiving normal data. At this time, if the data is data read mode, it indicates present status data. If the data is data write mode, it returns the data of the PC computer.

Error Acknowledgement

[Command2][][Set ID][][NG][x]

* The Monitor transmits ACK (acknowledgement) based on this format when receiving abnormal data from non-viable functions or communication errors.

01. Power (Command:a)

► To control Power On/Off of the Monitor.

Transmission

[k][a][][Set ID][][Data][Cr]

Data 0 : Power Off 1 : Power On

Acknowledgement

[a][][Set ID][][OK][Data][x]

Data 0 : Power Off 1 : Power On

► To show Power On/Off.

Transmission

[k][a][][Set ID][][FF][Cr]

Data 0 : Power Off 1 : Power On

Acknowledgement

[a][][Set ID][][OK][Data][x]

Data 0 : Power Off 1 : Power On

* In like manner, if other functions transmit 'FF' data based on this format, Acknowledgement data feed back presents status about each function.

02. Input Select (Command:b) (Main Picture Input)

► To select input source for the Monitor.

You can also select an input source using the INPUT SELECT button on the Monitor's remote control.

Transmission

[k][b][][Set ID][][Data][Cr]

Data 0 : RGB 1 3 : S-VIDEO
1 : COMPONENT 4 : RGB 2
2 : VIDEO

Acknowledgement

[b][][Set ID][][OK][Data][x]

Data 0 : RGB 1 3 : S-VIDEO
1 : COMPONENT 4 : RGB 2
2 : VIDEO

03. Aspect Ratio (Command:c) (Main picture format)

- ▶ To adjust the screen format.
You can also adjust the screen format using the ARC (Aspect Ratio Control) button on remote control or in the Special menu.

Transmission

[k][c][][Set ID][][Data][Cr]

Data 0 : Wide screen (16:9)
1 : Normal screen (4:3)
2 : Full screen (Zoom)

Acknowledgement

[c][][Set ID][][OK][Data][x]

Data 0 : Wide screen (16:9)
1 : Normal screen (4:3)
2 : Full screen (Zoom)

* Using the PC input, you select either 16:9 or 4:3 screen aspect ratio.

04. Screen Mute (Command:d)

- ▶ To select screen mute on/off.

Transmission

[k][d][][Set ID][][Data][Cr]

Data 0 : Screen mute off (Picture on)
1 : Screen mute on (Picture off)

Acknowledgement

[d][][Set ID][][OK][Data][x]

Data 0 : Screen mute off (Picture on)
1 : Screen mute on (Picture off)

05. Volume Mute (Command:e)

- ▶ To control volume mute on/off.
You can also adjust mute using the MUTE button on remote control.

Transmission

[k][e][][Set ID][][Data][Cr]

Data 0 : Volume mute on (Volume off)
1 : Volume mute off (Volume on)

Acknowledgement

[e][][Set ID][][OK][Data][x]

Data 0 : Volume mute on (Volume off)
1 : Volume mute off (Volume on)

06. Volume Control (Command:f)

- ▶ To adjust volume.
You can also adjust volume with the volume buttons on remote control.

Transmission

[k][f][][Set ID][][Data][Cr]

Data Min : 0 ~ Max : 64
* Refer to 'Real data mapping1' as shown right.

Acknowledgement

[f][][Set ID][][OK][Data][x]

Data Min : 0 ~ Max : 64

07. Contrast (Command:g)

- ▶ To adjust screen contrast.
You can also adjust contrast in the Video menu.

Transmission

[k][g][][Set ID][][Data][Cr]

Data Min : 0 ~ Max : 64
* Refer to 'Real data mapping1' as shown below.

Acknowledgement

[g][][Set ID][][OK][Data][x]

Data Min : 0 ~ Max : 64

08. Brightness (Command:h)

- ▶ To adjust screen brightness.
You can also adjust brightness in the Video menu.

Transmission

[k][h][][Set ID][][Data][Cr]

Data Min : 0 ~ Max : 64
* Refer to 'Real data mapping1' as shown below.

Acknowledgement

[h][][Set ID][][OK][Data][x]

Data Min : 0 ~ Max : 64

09. Color (Command:i)

- ▶ To adjust the screen color.
You can also adjust color in the Video menu.

Transmission

[k][i][][Set ID][][Data][Cr]

Data Min : 0 ~ Max : 64
* Refer to 'Real data mapping1' as shown below.

Acknowledgement

[i][][Set ID][][OK][Data][x]

Data Min : 0 ~ Max : 64

10. Tint (Command:j)

- ▶ To adjust the screen tint.
You can also adjust tint in the Video menu.

Transmission

[k][j][][Set ID][][Data][Cr]

Data Red : 0 ~ Green : 64
* Refer to 'Real data mapping1' as shown below.

Acknowledgement

[j][][Set ID][][OK][Data][x]

Data Red : 0 ~ Green : 64

* Real data mapping 1

0 : Step 0
⋮
A : Step 10 (SET ID 10)
⋮
F : Step 15 (SET ID 15)
10 : Step 16 (SET ID 16)
⋮
64 : Step 100

* Real data mapping 2

0 : -10
5 : -9
A : -8
⋮
2D : -1
32 : 0
37 : +1
⋮
5F : +9
64 : +10

11. Sharpness (Command:k)

- ▶ To adjust the screen sharpness.
You can also adjust sharpness in the Video menu.

Transmission

[k][k][][Set ID][][Data][Cr]

Data Min : 0 ~ Max : 64

* Refer to 'Real data mapping1'. See page 24.

Acknowledgement

[k][][Set ID][][OK][Data][x]

Data Min : 0 ~ Max : 64

12. OSD Select (Command:l)

- ▶ To select OSD (On Screen Display) on/off.

Transmission

[k][l][][Set ID][][Data][Cr]

Data 0 : OSD off 1 : OSD on

Acknowledgement

[l][][Set ID][][OK][Data][x]

Data 0 : OSD off 1 : OSD on

13. Remote Control Lock Mode (Command:m)

- ▶ To lock the front panel controls on the monitor and remote control.

Transmission

[k][m][][Set ID][][Data][Cr]

Data 0 : Lock off 1 : Lock on

Acknowledgement

[m][][Set ID][][OK][Data][x]

Data 0 : Lock off 1 : Lock on

- * If you're not using the remote control, use this mode.
When main power is on/off, remote control lock is released.

14. PIP / Twin (Command:n)

- ▶ To control the PIP (Picture In picture).
You can also control the PIP/TWIN using the PIP or Twin picture button on the remote control or in the Special menu.

Transmission

[k][n][][Set ID][][Data][Cr]

Data 0 : PIP/DW off 2 : DW1
1 : PIP 3 : DW2

Acknowledgement

[n][][Set ID][][OK][Data][x]

Data 0 : PIP/DW off 2 : DW1
1 : PIP 3 : DW2

15. PIP Size (Command:o)

- ▶ To select the PIP picture format.
You can also select the PIP picture format using WIN.SIZE on the remote control.

Transmission

[k][o][][Set ID][][Data][Cr]

Data 0 : 4:3 1 : 16:9

Acknowledgement

[o][][Set ID][][OK][Data][x]

Data 0 : 4:3 1 : 16:9

16. PIP Position (Command:q)

- ▶ To select sub picture position for PIP.
You can also adjust the sub picture position using WIN.POSITION on the remote control or in the Special menu.

Transmission

[k][q][][Set ID][][Data][Cr]

Data 0 : Right down on screen
1 : Left down on screen
2 : Left up on screen
3 : Right up on screen

Acknowledgement

[q][][Set ID][][OK][Data][x]

Data 0 : Right down on screen
1 : Left down on screen
2 : Left up on screen
3 : Right up on screen

17. Treble (Command:r)

- ▶ To adjust treble.
You can also adjust treble in the Audio menu.

Transmission

[k][r][][Set ID][][Data][Cr]

Data Min : 0 ~ Max : 64

* Refer to 'Real data mapping1'. See page 24.

Acknowledgement

[r][][Set ID][][OK][Data][x]

Data Min : 0 ~ Max : 64

18. Bass (Command:s)

- ▶ To adjust bass.
You can also adjust bass in the Audio menu.

Transmission

[k][s][][Set ID][][Data][Cr]

Data Min : 0 ~ Max : 64

* Refer to 'Real data mapping1'. See page 24.

Acknowledgement

[s][][Set ID][][OK][Data][x]

Data Min : 0 ~ Max : 64

19. Balance (Command:t)

- ▶ To adjust balance.
You can also adjust balance in the Audio menu.

Transmission

[k][t][][Set ID][][Data][Cr]

Data Min : 0 ~ Max : 64

* Refer to 'Real data mapping1'. See page 24.

Acknowledgement

[t][][Set ID][][OK][Data][x]

Data Min : 0 ~ Max : 64

20. Color Temperature (Command:u)

- ▶ To adjust color temperature.
You can also adjust ACC in the Video menu.

Transmission

[k][u][][Set ID][][Data][Cr]

Data 0: Normal 1: Cool 2: Warm 3: User

Acknowledgement

[u][][Set ID][][OK][Data][x]

Data 0: Normal 1: Cool 2: Warm 3: User

21. Red Adjustment (Command:v)

- ▶ To adjust red in color temperature.

Transmission

[k][v][][Set ID][][Data][Cr]

Data Min : 0 ~ Max : 64
* Refer to 'Real data mapping 2'. See page 24.

Acknowledgement

[v][][Set ID][][OK][Data][x]

Data Min : 0 ~ Max : 64

22. Green Adjustment (Command:w)

- ▶ To adjust green in color temperature.

Transmission

[k][w][][Set ID][][Data][Cr]

Data Min : 0 ~ Max : 64
* Refer to 'Real data mapping 2'. See page 24.

Acknowledgement

[w][][Set ID][][OK][Data][x]

Data Min : 0 ~ Max : 64

23. Blue Adjustment (Command:\$)

- ▶ To adjust blue in color temperature.

Transmission

[k][\$][][Set ID][][Data][Cr]

Data Min : 0 ~ Max : 64
* Refer to 'Real data mapping 2'. See page 24.

Acknowledgement

[\$][][Set ID][][OK][Data][x]

Data Min : 0 ~ Max : 64

24. PIP Input Select (Command:y)

- ▶ To select input source for sub picture in PIP mode.

Transmission

[k][y][][Set ID][][Data][Cr]

Data 0 : RGB1 1 : COMPONENT
2 : VIDEO 3 : S-VIDEO 4 : RGB2

Acknowledgement

[y][][Set ID][][OK][Data][x]

Data 0 : RGB1 1 : COMPONENT
2 : VIDEO 3 : S-VIDEO 4 : RGB2

25. Orbiter (Command:p)

- ▶ To control the orbiter function on/off.

Transmission

[i][p][][Set ID][][Data][Cr]

Data 0 : Orbiter off
1 : Orbiter on

Acknowledgement

[p][][Set ID][][OK][Data][x]

Data 0 : Orbiter off
1 : Orbiter on

26. White Wash (Command:q)

- ▶ To control the white wash function on/off.

Transmission

[i][q][][Set ID][][Data][Cr]

Data 0 : White Wash off
1 : White Wash on

Acknowledgement

[q][][Set ID][][OK][Data][x]

Data 0 : White Wash off
1 : White Wash on

27. Orbiter Time Setting (Command:r)

- ▶ To adjust orbiter operation time term.

Transmission

[i][r][][Set ID][][Data][Cr]

Data Min : 1 ~ Max : FE
* Refer to 'Real data mapping1'. See page 24.

Acknowledgement

[r][][Set ID][][OK][Data][x]

Data Min : 1 ~ Max : FE

28. Orbiter Pixel Setting (Command:s)

- ▶ To adjust pixel number in orbiter function.

Transmission

[i][s][][Set ID][][Data][Cr]

Data Min : 0 ~ Max : 9
* Refer to 'Real data mapping1'. See page 24.

Acknowledgement

[s][][Set ID][][OK][Data][x]

Data Min : 0 ~ Max : 9

IR Code (NEC Format)

How to connect

- ▶ Connect your wired remote control to the Remote port on the Monitor.
Set the CONTROL LOCK to 'ON' on the Monitor back panel to operate Monitor with wired remote control.

Remote Control IR Code (NEC Format)

▶ Output waveform

Single pulse, modulated with 37.917KHz signal at 455KHz

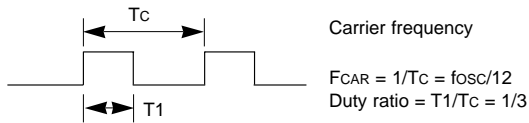

▶ Configuration of frame

- 1st frame

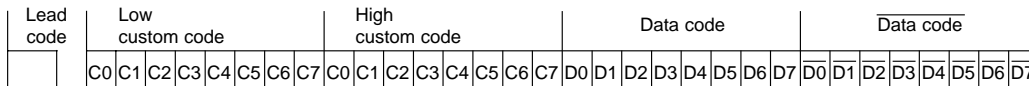

- Repeat frame

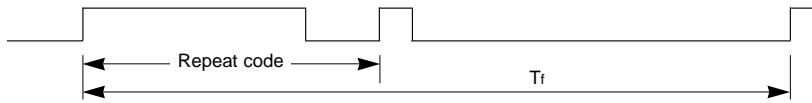

▶ Lead code

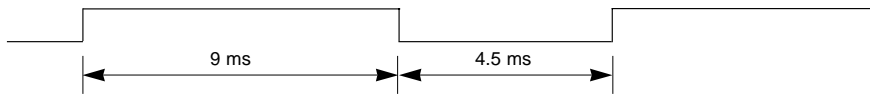

▶ Repeat code

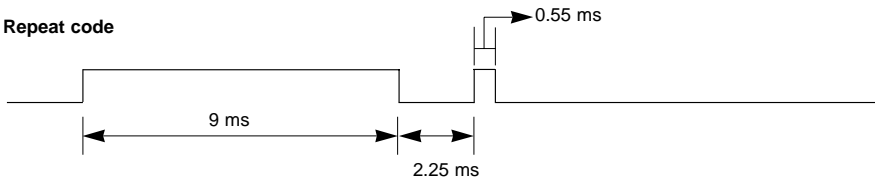

▶ Bit description

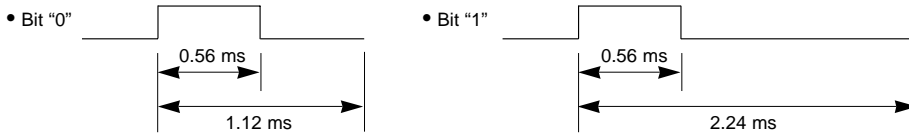

▶ Frame interval : T_f

The waveform is transmitted as long as a key is depressed.

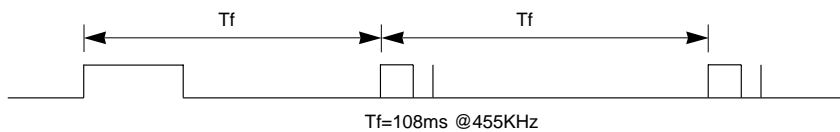

Code (Hexa)	Function	Note
00H	UP (▲)	R/C Button
01H	DOWN (▼)	R/C Button
02H	VOL+ (▶)	R/C Button
03H	VOL- (◀)	R/C Button
08H	POWER On/Off	R/C Button (Power On/Off)
C4H	POWER ON	Discrete IR Code (Only Power On)
C5H	POWER OFF	Discrete IR Code (Only Power Off)
09H	MUTE	R/C Button
10H	Number Key 0	R/C Button
11H	Number Key 1	R/C Button
12H	Number Key 2	R/C Button
13H	Number Key 3	R/C Button
14H	Number Key 4	R/C Button
15H	Number Key 5	R/C Button
16H	Number Key 6	R/C Button
17H	Number Key 7	R/C Button
18H	Number Key 8	R/C Button
19H	Number Key 9	R/C Button
0BH	All INPUT SELECT	R/C Button(RGB1/RGB2/Comp/VIDEO/S-VIDEO)
98H	RGB 1	Discrete IR Code (Input RGB1 Selection)
C6H	RGB 2 (DVI input)	Discrete (Input RGB2 Selection)
5AH	VIDEO	Discrete (Input VIDEO Selection)
51H	S-VIDEO	Discrete (Input S-VIDEO Selection)
BFH	COMPONENT	Discrete (Input COMPONENT Selection)
0EH	SLEEP	R/C Button
44H	OK (■)	R/C Button
43H	MENU	R/C Button
52H	DASP	R/C Button
4DH	APC	R/C Button
60H	PIP	R/C Button
61H	PIP INPUT	R/C Button
63H	SWAP	R/C Button (PIP/TWIN Exchange)
64H	PIP ARC	R/C Button (4:3/16:9)
6BH	TWIN PICTURE	R/C Button
40H	ZOOM +	R/C Button
41H	ZOOM -	R/C Button
69H	Window Size	R/C Button
6AH	Window Position	R/C Button
7BH	Split Zoom	R/C Button
79H	ARC	R/C Button(4:3/16:9/Zoom Mode Selection)
76H	ARC (4:3)	Discrete (Only 4:3 mode)
77H	ARC (16:9)	Discrete (Only 16:9 mode)
AFH	ARC (ZOOM)	Discrete (Only ZOOM mode)

Maintenance

- Early malfunctions can be prevented. Careful and regular cleaning can extend the amount of time you will have your new Monitor. Be sure to turn the power off and unplug the power cord before you begin any cleaning.

Cleaning the Screen

1. Here's a great way to keep the dust off your screen for a while. Wet a soft cloth in a mixture of lukewarm water and a little fabric softener or dish washing detergent. Wring the cloth until it's almost dry, and then use it to wipe the screen.
2. Make sure the excess water is off the screen, and then let it air-dry before you turn on your Monitor.

Cleaning the Cabinet

To remove dirt or dust, wipe the cabinet with a soft, dry, lint-free cloth. Please be sure not to use a wet cloth.

Extended Absence



If you leave your Monitor dormant for a long time (such as a vacation), it's a good idea to unplug the power cord to protect against possible damage from lightning or power surges.

Troubleshooting Checklist

No picture & No sound

- Check whether the Monitor is turned on.
- Power cord inserted into wall outlet?
- Plug another product's power cord into the wall outlet where the Monitor's power cord was plugged in.

Picture OK & No sound

- Press the **VOLUME** (▶) button.
- Sound muted? Press **MUTE** button.

The remote control doesn't work

- Check to see if there is any object between the Plasma Display and the remote control causing obstruction.
- Check to see if the batteries are installed with the correct polarities. (Refer to p.11)
- Install new batteries. (Refer to p.11)

No or Poor color or Poor picture

- Select **COLOR** in the **VIDEO** menu and press the **VOLUME** (▶) button. (Refer to p.14)
- Keep a certain distance between the Monitor and the VCR.
- Activate any function to restore the brightness of the picture. (If still picture is on the screen for more than 5 minutes, the screen gets dark.)

No output from one of the speakers

- Adjust **BALANCE** in the **AUDIO** menu. (Refer to p.15)

Strange sound from the Monitor

- Typical sound due to normal Monitor operation, Monitor is not faulty.

Product Specifications

MODEL	MU-50PZ40/A/B/K/R/S, MU-50PZ41/A/B/K/R/S
Width (inches / mm)	48.2 / 1223
Height (inches / mm)	28.9 / 734
Depth (inches / mm)	4.1 / 105
Weight (pounds / kg)	99.2 / 45
Power requirement	AC120V, 60Hz
Resolution	1366 x 768 (Dot)
Color	16,770,000 (256 steps of each R, G and B)
Operating Temperature Range	32 ~ 104°F (0 ~ 40°C)
Operating Humidity Range	Less than 80%

- The specifications shown above may be changed without notice for quality improvement.