

 **Dometic®**

**OVER THE RANGE
MICROWAVE-
CONVECTION OVEN**

**OWNER'S
GUIDE**

To help you get the
most out of your
new appliance



LISTED



LISTED

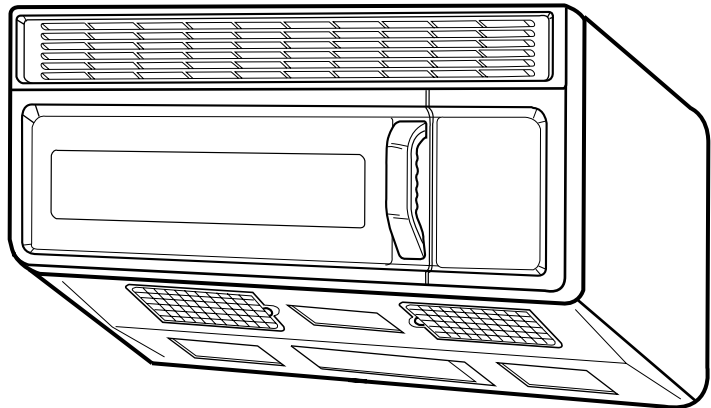

MODEL NO.: DOTRC11B, DOTRC11W

P/N: 3828W5A0823

PRECAUTIONS TO AVOID POSSIBLE EXPOSURE TO EXCESSIVE MICROWAVE ENERGY...

- (a) DO NOT ATTEMPT TO OPERATE THIS OVEN WITH THE DOOR OPEN, since open-door operation can result in harmful exposure to microwave energy. It is important not to defeat or tamper with the safety interlocks.
- (b) DO NOT PLACE ANY OBJECT BETWEEN THE OVEN FRONT FACE AND THE DOOR, or allow soil or cleaner residue to accumulate on sealing surfaces.
- (c) DO NOT OPERATE THE OVEN IF IT IS DAMAGED.
It is particularly important that the oven door closes properly and that there is no damage to the:
- door (bent),
 - hinges and latches (broken or loosened),
 - door seals and sealing surfaces.
- (d) THE OVEN SHOULD NOT BE ADJUSTED OR REPAIRED by anyone except properly qualified service personnel.

TABLE OF CONTENTS

PRECAUTIONS TO AVOID POSSIBLE EXPOSURE TO EXCESSIVE MICROWAVE ENERGY	2	Combination Cooking	23
TABLE OF CONTENTS	3	Introduction	23
SAFETY	4	Combination Baking/Roasting Without Preheating ..	24
Important Safety Instructions	4	Combination Baking/Roasting With Preheating ..	24
INFORMATION	6	Auto Combination	25
Location of Model Number	6	Auto Combination chart	25
Oven Specifications	6	USING THE METAL RACK	26
Electrical Rating	6	UTENSIL GUIDE	27
Electrical Requirements	6	CARE AND CLEANING	28
Grounding Instructions	6	General	28
Microwave Oven Features	7	Metal Rack	28
Oven Control Panel	8	Grease Filters	28
OPERATION	9	Charcoal Filter Replacement	29
LEARN ABOUT YOUR MICROWAVE OVEN	9	Cooktop Light Replacement	29
Clock	9	QUESTIONS AND ANSWERS	30
Child Lock	9	Operation	30
Custom Cook	9	Foods	30
Hold Warm	10	BEFORE CALLING FOR SERVICE	32
Timer	10	LIMITED WARRANTY	Back Cover
Fan	10		
Light	10		
Time Cooking at High Power	11		
Time Cooking at Multi-Power	11		
Multi-Stage Cooking	11		
Cooking Guide for Lower Power Levels	12		
Sensor Operating Instructions	13		
Sensor Cooking Guide	13		
Adding or Subtracting Cook Time	13		
Popcorn	14		
Sensor Cook	14		
Auto Reheat	14		
Cooking Guide for Sensor Cook	15		
Auto Defrost	16		
Auto Defrost Instructions	16		
Defrosting Tips	16		
Auto Defrost Sequence Table	17		
General Guidelines	17		
Defrost Chart	18		
Convection Cooking	20		
Introduction	20		
Convection Baking Without Preheating	21		
Convection Baking With Preheating	21		
Convection Broiling	21		
Convenience Foods Cooking Chart for Convection Cooking	22		

SAFETY

Important Safety Instructions

The safety instructions below will tell you how to use your oven to avoid harm to yourself or damage to your oven.

WARNING - To reduce the risk of burns, electric shock, fire, injury to persons, or exposure to excessive microwave energy:

- **Read all the instructions before using your oven.**
- **Do not allow children to use this oven without close supervision.**
- Read and follow the specific **PRECAUTIONS TO AVOID POSSIBLE EXPOSURE TO EXCESSIVE MICROWAVE ENERGY** found on page 2.
- **Do not use** corrosive chemicals or vapors, such as sulfide and chloride, in this appliance. This type of oven is specifically designed to heat, cook, or dry food. It is not designed for industrial or laboratory use.
- **Do not store** this appliance outdoors. Do not use this product near water - for example, near a kitchen sink, in a wet basement, near a swimming pool, or similar location.
- **Do not use** the cavity for storage purposes. Do not leave paper products, cooking utensils, or food in the cavity when not in use.
- **Clean the ventilating hood frequently.** Do not allow grease to accumulate on the hood or the filters.
- Use care when cleaning the vent hood filters. Corrosive cleaning agents such as lye-based oven cleaners, may damage the filters.
- **Do not tamper with the built-in safety switches on the oven door.** The oven has several built-in safety switches to make sure the power is off when the door is open.
- When flaming foods under the hood, turn the fan on.
- Suitable for use above both gas and electric cooking equipment 36 inches wide or less.
- **Do not use this oven for commercial purposes.** It is made for household use only.
- **When cleaning the door and the surfaces that touch the door, use only mild, non-abrasive soaps or detergents and a sponge or soft cloth.**
- **If your oven is dropped or damaged,** have it thoroughly checked by a qualified service technician before using it again.
- **To avoid a fire hazard:**
 - **Do not severely overcook food.** Severely overcooked foods can start a fire in the oven. Watch the oven carefully, especially if you have paper, plastic, or other combustibles in the oven.
 - **Do not store combustible items (bread, cookies, etc.) in the oven,** because if lightning strikes the power lines it may cause the oven to turn on.
 - **Do not use wire twist-ties in the oven.** Be sure to inspect purchased items for wire twist-ties and remove them before placing the item in the oven.
- **If a fire should start:**
 - **Keep the oven door closed.**
 - **Turn the oven off.**
 - **Disconnect the power cord or shut off the power at the fuse or circuit breaker panel.**
- **To avoid electric shock:**
 - **This appliance must be grounded.** Connect it only to a properly grounded outlet. See the electrical **GROUNDING INSTRUCTIONS** on page 6.
 - **Do not operate this appliance if it has a damaged cord or plug,** if it is not working properly or if it has been damaged or dropped.
 - **Do not immerse the electrical or plug in water.**
 - **Keep the cord away from heated surfaces.**

SAFETY

- **To avoid improperly cooking some foods.**
 - **Do not heat any types of baby bottles or baby food.** Uneven heating may occur and possibly cause personal injury.
 - Do not heat small-necked containers,** such as syrup bottles.
 - Do not deep-fat fry in your microwave oven.**
 - Do not attempt home canning in your microwave oven.**
 - Do not heat the following items in the microwave oven:** whole eggs in the shell, water with oil or fat, sealed containers, or closed glass jars. These items may explode.
- Do not cover or block any openings in the oven.
- Use your oven only for the operations described in this manual.
- **Do not run the oven empty, without food in it.**
- Do not let cord hang over edge of table or counter.
- **Preserve the oven floor:**
 - **Do not heat the oven floor excessively.**
 - **Do not** allow the gray film on special microwave cooking packages to touch the oven floor. Put the package on a microwavable dish.
 - **Do not** cook anything directly on the oven floor or turntable. Use a microwavable dish.
 - Keep a browning dish at least 3/16 inch above floor. Carefully read and follow the instructions for the

browning dish. If you use a browning dish incorrectly, you could damage the oven floor.

- Install or locate this appliance only in accordance with the provided installation instructions.
- This appliance should be serviced only by qualified service personnel. Contact the nearest authorized service facility for examination, repair, or adjustment.
- Liquids, such as water, coffee, or tea are able to be overheated beyond the boiling point without appearing to be boiling. Visible bubbling or boiling when the container is removed from the microwave oven is not always present.
THIS COULD RESULT IN VERY HOT LIQUIDS SUDDENLY BOILING OVER WHEN THE CONTAINER IS DISTURBED OR A SPOON OR OTHER UTENSIL IS INSERTED INTO THE LIQUID. To reduce the risk of injury to persons:
 - Do not overheat the liquid.
 - Stir the liquid both before and halfway through heating it.
 - Do not use straight-sided containers with narrow necks.
 - After heating, allow the container to stand in the microwave oven for a short time before removing the container.
 - Use extreme care when inserting a spoon or other utensil into the container.

SAVE THESE INSTRUCTIONS

FEDERAL COMMUNICATIONS COMMISSION RADIO FREQUENCY INTERFERENCE STATEMENT (U.S.A. ONLY)

WARNING:

This equipment generates and uses ISM frequency energy and if not installed and used properly, that is in strict accordance with the manufacturer's instructions, may cause interference to radio and television reception. It has been type tested and found to comply with limits for ISM Equipment pursuant to part 18 of FCC Rules, which are designed to provide reasonable protection against such interference in a residential installation.

However, there is no guarantee that interference will not occur in a particular installation. If this equipment does cause interference to radio or television reception, which can be determined by turning the equipment off and on, the user is encouraged to try to correct the interference by one or more of the following:

- Reorient the receiving antenna of the radio or television.
- Relocate the Microwave Oven with respect to the receiver.
- Move the microwave oven away from the receiver.
- Plug the microwave oven into a different outlet so that the microwave oven and the receiver are on different branch circuits.

The manufacturer is not responsible for any radio or TV interference caused by **unauthorized modification** to this microwave oven. It is the responsibility of the user to correct such interference.

INFORMATION

Please read this owner's manual. It will tell you how to use all the fine features of this microwave oven.

LOCATION OF MODEL NUMBER

To request service, information or replacement parts, the service center will require the complete model number of your microwave oven. The number is on the control panel side as shown in the illustration below.

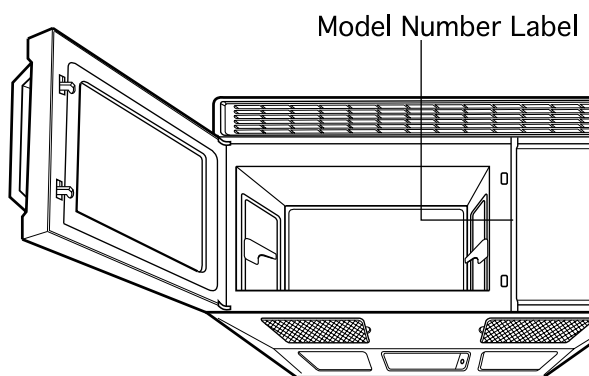

OVEN SPECIFICATIONS

Output Power	850W (IEC 705 Rating Standard) 1350W (Heater)
Outer Dimensions	29-7/8" x 14" x 16-3/16"
Cavity Volume	1.1 Cu.Ft
Net Weight	69 lbs

ELECTRICAL RATING

- * Electrical Rating of the Oven: 120 V AC. 60 Hz.
- * 1300 Watts 12 Amperes (Microwave oven only)
- * 1500 Watts 13 Amperes (Microwave oven + Cooktop Lamps + Ventilation Fan.)

ELECTRICAL REQUIREMENTS

The oven is designed to operate on a Standard 120 volt/60 Hz household outlet. Be sure the circuit is at least 15A and the microwave oven is the only appliance on the circuit. It is not designed for 50 Hz or any circuit other than a 120 volt/60 Hz circuit.

GROUNDING INSTRUCTIONS

This appliance must be grounded. If an electrical short circuit occurs, grounding reduces the risk of electric shock by providing an escape wire for the electric current. The cord for this appliance has a grounding wire with a grounding plug. Put the plug into an outlet that is properly installed and grounded.

WARNING - If you use the grounding plug improperly, you risk electric shock.

Ask a qualified electrician if you do not understand the grounding instructions or if you wonder whether the appliance is properly grounded.

Because this appliance fits under the cabinet, it has a short power-supply cord. See the separate Installation Instructions for directions on properly placing the cord. Keep the electrical power cord dry and do not pinch or crush it in any way.

If it is necessary to use an extension cord, use only a 3-wire extension cord that has a 3-blade grounding plug, and a 3-slot receptacle that will accept the plug on the appliance. The marked rating of the extension cord should be equal to or greater than the electrical rating of the appliance.

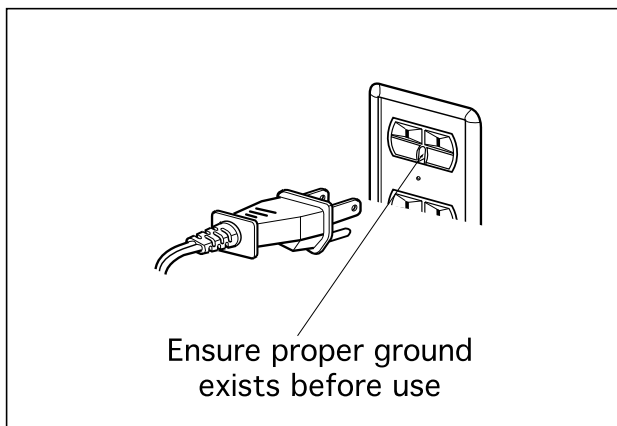

For a permanently connected appliance: This appliance must be connected to a grounded, metallic, permanent wiring system, or an equipment grounding conductor should be run with the circuit conductors and connected to the equipment grounding terminal or lead on the appliance.

INFORMATION

MICROWAVE OVEN FEATURES

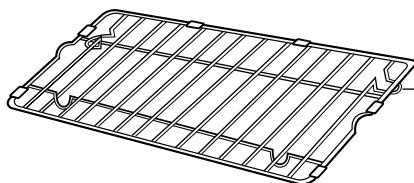
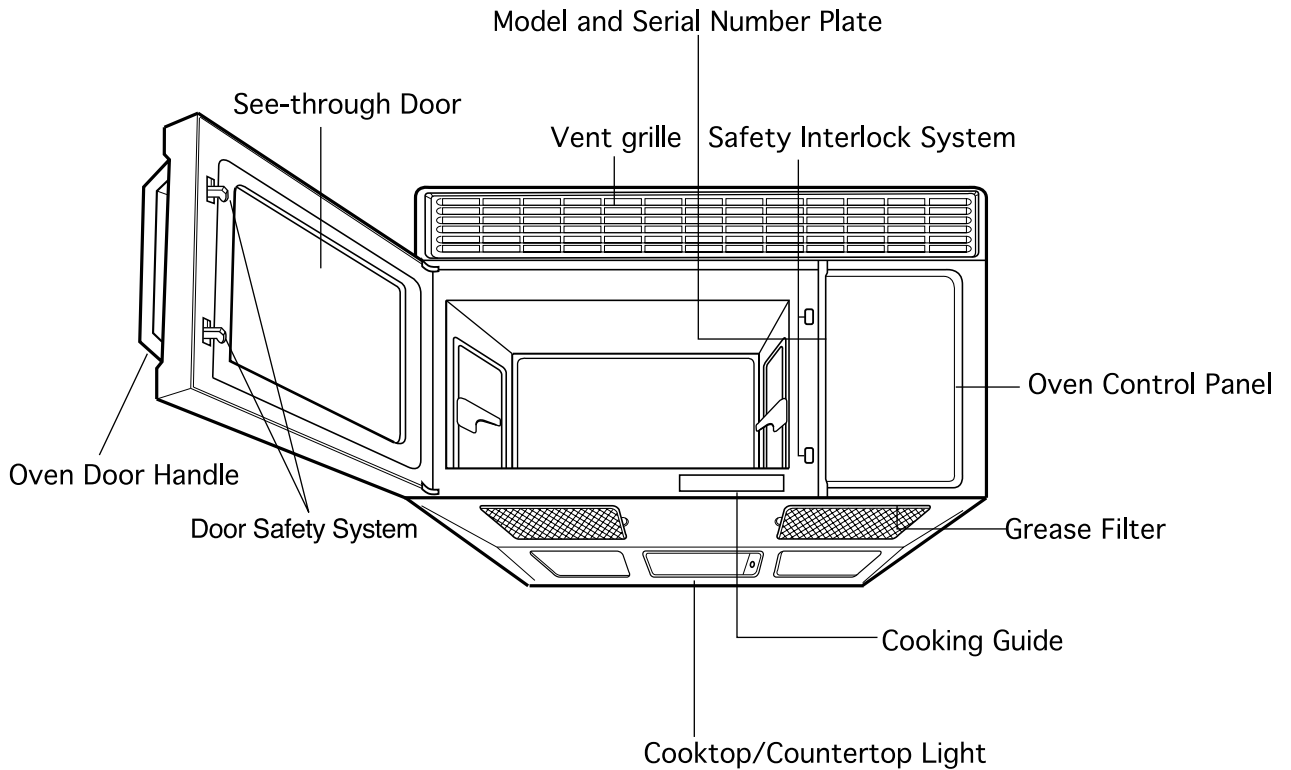

Metal Rack

CAUTION: Do not use the oven empty with the metal rack in it.

INFORMATION

OVEN CONTROL PANEL

Hold Warm -

Used to keep hot, cooked foods safely warm in your microwave oven up to 60 minutes.

Clock -

Used in setting time of day.

Custom Cook -

Used for memory entry and memory recall of a cooking program.

Numbers -

Used to enter the:

- Time of day
- Cooking Time
- Cooking Powers
- Quantities or weights

Time -

Used in setting cooking time.

Power -

Used to select cooking power.

Stop/Clear -

Used to stop the oven or clear all entries except time of day.

Start -

Used to start the oven.

Auto Defrost -

Used to defrost frozen meat, poultry, and fish.

Fan Control Pad -

Used to turn on the fan at high speed or low speed and turn off the fan.

Light Pad -

Used to turn the work light on/off in either the high or night modes.

Display -

Used to show time of day, cooking time, cooking power level, and miscellaneous indicators during cooking functions.

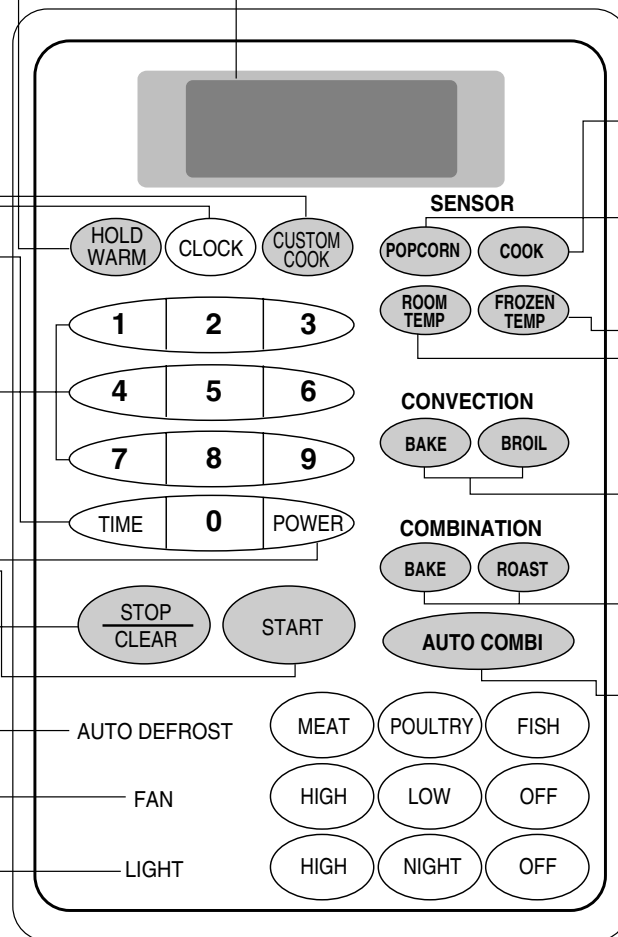

Popcorn -

Used to pop popcorn.

Cook -

Used to sensor cooking.

Room Temp -

Used to reheat foods at room temperature.

Frozen Temp -

Used to reheat frozen foods.

Convection -

Used in setting convection cooking or preheat.

Combination -

Used in setting combination cooking or preheat.

Auto Combination -





Used in setting weight combination cooking.

OPERATION

LEARN ABOUT YOUR MICROWAVE OVEN

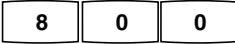

This section discusses the concepts behind microwave cooking and introduces you to the basics you need to know to operate your microwave oven. Please read this information before use.

CLOCK(TIME OF DAY)

To set clock.	
	Touch STOP/CLEAR .
	Touch CLOCK .
	Enter the time by using the number key pad. Example for setting 8:00.
	Touch CLOCK .

CHILD LOCK



You may lock the control panel to prevent the microwave from being accidentally started or used by children.



To set the child lock.	
	Touch STOP/CLEAR .
	Touch and hold 0 more than 2 seconds. LOCK will appear in the display window with one beep.

To set cancel the child lock.	
	Touch and hold 0 more than 2 seconds. LOCK will disappear and you hear 1 beep. At this time the oven is ready.

CUSTOM COOK

CUSTOM COOK lets you to recall one cooking instruction previously placed in memory and begin cooking quickly.



To memorize a cooking program.	
	Touch STOP/CLEAR .
<i>PROGRAM</i>	Set the single or multi-stage program you wish to put into memory (set as you would normally).
	Touch CUSTOM COOK for more than 3 seconds ENTER will display.
When you touch CUSTOM COOK, no beep will be heard until ENTER is displayed.	

To recall the memory.	
	Touch STOP/CLEAR .
	Touch CUSTOM COOK . CALL will display.
	Touch START .

OPERATION



HOLD WARM

You can safely keep hot, cooked food warm in your microwave oven. You can use HOLD WARM by itself or to follow a cooking cycle automatically.

To set the HOLD WARM.	
	Touch STOP/CLEAR .
<i>PROGRAM</i>	Set the desired cooking cycle following suitable operating instructions in this manual.
	Touch HOLD WARM .
	Touch START .

When the cooking cycle is over, the oven will switch into HOLD WARM to keep the food warm. HOLD will show in the display window. The HOLD WARM will continue for up to 60 minutes or until the door has been opened or STOP/CLEAR has been touched.

If you want to keep your cooked food warm, the HOLD WARM can be used independently without setting the cooking cycle.

To use the HOLD WARM independently.	
	Touch STOP/CLEAR .
	Touch HOLD WARM .
	Touch START .





The oven will begin to keep warm for up to 60 minutes or until the door has been opened or STOP/CLEAR has been touched.

NOTES:

- **Food cooked covered** should be covered during HOLD WARM.
- **Pastry items** (pies, turnovers, etc.) should be uncovered during HOLD WARM.
- **Complete meals** kept warm on a dinner plate could be covered during HOLD WARM.

TIMER

Your oven has a timer that you can use when not cooking. The oven does not run and the timer just counts down in seconds.

To set timer.	
	Touch STOP/CLEAR .
	Touch TIME .
<i>NUMBER</i>	Touch the numbers for the you want to counter down.
	Touch POWER .
	Touch 0 (Power Level 0)
	Touch START .

The time will count down in the display window but the oven will not heat. When the times is over you will hear two short and one long beeps and END will display.

	Touch STOP/CLEAR to return the CLOCK display.
---	---

FAN

Your oven has a **FAN** to ventilate during electric or gas oven cooking.

To use the FAN:

1. Choose fan speed.
2. Turn off fan when desired.

NOTE: If the temperature gets too hot around the microwave oven, the exhaust fan in the vent hood will automatically turn on at the **LOW** setting to protect the oven.

LIGHT

Your oven has a **LIGHT** to illuminate on the electric or gas oven.

To use the LIGHT:

1. Choose light.
2. Turn off light when desired.

OPERATION

TIME COOKING AT HIGH POWER

HI is the highest cooking power possible with your microwave oven. It is the best setting for cooking foods that have high water content, such as coffee, soups, or foods that need fast cooking to maintain their natural flavor and texture, like fish, vegetables, and most casseroles.

Example: To cook food for 8 minutes.

 Touch **STOP/CLEAR**.

 Touch **TIME**.

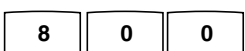
 Touch the numbers for the cooking time you want.

 Touch **START**.

TIME COOKING AT MULTI-POWER

HI power cooking does not always give you the best results with foods that need slow cooking, such as roasts, baked goods, or custards. Your oven has 9 power settings in addition to HI.

Example: To cook food for 8 minutes at 70% power.

 Touch **STOP/CLEAR**.

 Touch **TIME**.

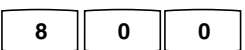
 Touch the numbers for the cooking time you want.

 Touch **POWER**.

 Touch the numbers for the power level you want.

 Touch **START**.

MULTI-STAGE COOKING

Multi-Stage cooking allows you to set the oven in two stages at different power levels for a specific time.

Example: First Stage - 4 minutes at HI power
Second Stage - 9 minutes at 7 Power

 Touch **STOP/CLEAR**.

 Touch **TIME**.

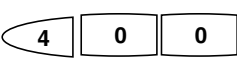
 Touch the numbers for the cooking time you want.

 Touch **TIME**.

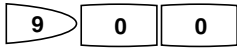
 Touch the numbers for the cooking time you want.

 Touch **POWER**.

 Touch the number for the power level you want.

 Touch **START**.

NOTE:

- Unless you want to change the **POWER**, the oven always cooks at **HI-POWER**.
- To stir turn the food during cooking, open the oven door and stir or turn. Close the oven door and touch **START**. The oven will count down the time left.

OPERATION

COOKING GUIDE FOR LOWER POWER LEVELS

The nine power levels in addition to HIGH allow you to choose the best power level for the food you are cooking. Below are listed all the power levels, examples of foods best cooked at each level, and the amount of microwave power you are using.

POWER LEVEL	MICROWAVE OUTPUT	USE
10 "HI"	100%	<ul style="list-style-type: none">• Boil water.• Cook ground beef.• Make candy.• Cook fresh fruits and vegetables.• Cook fish, and poultry.• Preheat browning dish.
9	90%	<ul style="list-style-type: none">• Reheat meat slices quickly.• Saute onions, celery, and green pepper.
8	80%	<ul style="list-style-type: none">• All reheating.• Cooking scrambled eggs.
7	70%	<ul style="list-style-type: none">• Cook quickly breads and cereal products.• Cook cheese dishes, veal.• Cook cakes, muffins, brownies, cup cakes.
6	60%	<ul style="list-style-type: none">• Cook pasta.
5	50%	<ul style="list-style-type: none">• Cook meats, whole poultry.• Cook custard.• Cook whole chicken, turkey, spare ribs, rib roast, sirloin roast.
4	40%	<ul style="list-style-type: none">• Cook less tender cuts of meat.• Reheat frozen convenience foods.
3	30%	<ul style="list-style-type: none">• Thawing meat, poultry, and seafood.• Cooking small quantities of food.• Finish cooking casserole, stew, and some sauces.
2	20%	<ul style="list-style-type: none">• Soften butter and cream cheese.• Heating small amounts of food.
1	10%	<ul style="list-style-type: none">• Soften ice cream.• Raise yeast dough.
0		<ul style="list-style-type: none">• Standing time.

OPERATION

SENSOR OPERATING INSTRUCTIONS ADDING OR SUBTRACTING COOK TIME (SENSOR COOK, POPCORN and SENSOR REHEAT)

Sensor cook allows you to cook most of your favorite foods without selecting cooking times and power levels. The display will indicate SENSOR during the sensing period. The oven automatically determines required cooking time for each food item. When the initial sensor detects a certain amount of vapor coming from the food, it will show the remaining heating time. For best results by sensor, following these recommendations.

1. Food cooked with the sensor system should be at normal storage temperature.
2. Foods should always be covered loosely with microwavable plastic wrap, waxed paper, or a lid.
3. Do not open the door or touch STOP/CLEAR key during the sensing time. When sensing time is over, the oven beeps and the remaining cooking time will appear in the display window. At this time you can open the door to stir, turn, or rearrange the food.

SENSOR COOKING GUIDE

Appropriate containers and coverings help assure good sensor cooking results.

1. Always use microwavable containers.
2. Never use tight-sealing plastic covers. They can prevent steam from escaping and cause food to overcook.
3. Match the amount of food and the size of containers. Fill containers at least half full for best results.
4. Be sure the outside of the cooking container and the inside of the microwave oven are dry before placing food in the oven. Beads of moisture turning into steam can mislead the sensor.

If the preset cooking time is too long or too short you can increase or decrease cooking time by 10% after choosing one of the following functions.

To adjust the sensor cook, reheat or popcorn.

 Touch **COOK**.
Example for setting for cook.

 Touch the number for the category you want.
Example for setting 1 (Beverage).

You can only increase or decrease cooking time before cooking starts.

 Touch 9 , then MORE will blink.
Example: To increase time by 10%.

Cook Time & Blink	Touch Pad Number
LESS	7
NORMAL	8
MORE	9



***NORMAL:** To reset the original cook time.

You do not need to touch START. 3 seconds after touching the pad, the oven begins cooking automatically.

OPERATION

POPCORN

POPCORN lets you pop commercially packaged microwave popcorn. Pop only one package at a time. Do not double quantity. For best results, use fresh bags of popcorn.

To pop popcorn.	
	Touch STOP/CLEAR .
	Touch POPCORN .

You do not need to touch START. 3 seconds after touching the pad, the oven begins cooking automatically.

NOTE:



- Place the popcorn bag on the bottom of the oven.
- Do not place the bag on the paper or plastic cookware or on turntables which are not an original part of the oven.
- Do not leave the oven unattended while popping corn.
- Remove the bag from the oven carefully. The popcorn and steam are extremely hot. Open the bag carefully by pulling the diagonal corners.
- Do not reheat unpopped kernels or re-use the bag.
- Never popcorn in brown paper bag.
- When using Jumbo prepackaged popcorn bags, follow the manufacturer's directions. Do not use the POPCORN pad.
- Cooking performance may vary with brand. Try several brands to decide which gives best popping results.

SENSOR COOK

SENSOR COOK lets you cook common microwave prepared foods without needing to program times and cook powers. A sensor in your oven detects the vapor released by the food, and the amount vapor detected tells oven how long to cook your food.

SENSOR COOK has preset cook powers for seven categories: Beverage, Baked Potato, Frozen Entree, Casserole, Baked Goods, Fresh Vegetables, Frozen Vegetables.



All you do is touch the NUMBER Pad assigned to the desired category(See COOKING GUIDE FOR SENSOR COOK.) and you do not need to touch START.

To use the SENSOR COOK.	
	Touch STOP/CLEAR .
	Touch COOK .
	Touch the number for the category you want. Example for setting 1(Beverage).

You do not need to touch START. 3 seconds after touching the pad, the oven begins cooking automatically.

AUTO REHEAT (ROOM TEMP or FROZEN TEMP)

Most microwave ovens require the selection of the power level and time for cooking or reheating. Your new oven makes reheating foods more convenient. A sensor in your oven detects the vapor released by the food, and the amount of vapor detected tells the oven how long to heat your food. To reheat food that is at room temperature, touch ROOM TEMP. To reheat food that is frozen, touch FROZEN TEMP.

To reheat foods, simply follow the steps below.	
	Touch STOP/CLEAR .
	Touch ROOM TEMP or FROZEN TEMP you want.
	

The oven will begin heating automatically.
ROOM (or **FROZEN**) will display and the remaining time will begin counting down.

OPERATION

COOKING GUIDE FOR SENSOR COOK

CODE	CATEGORY	DIRECTION
1	BEVERAGE	No cover. Use uncovered microproof cup(s) or mug(s). Stir after reheating.
2	BAKED POTATO	Wash and scrub well. Pierce with fork. Place on paper towel in a circle 1" apart. Let stand 3 to 5 minutes after cooking.
3	FROZEN ENTREE	Use the original package of frozen entree, and follow the package directions. But if the cover is film, perforate the film instead of removing it. (Don't remove the cover wholly.)
4	CASSEROLE	Place the food in microproof bowl or glass casserole. Cover tightly with plastic wrap.
5	BAKED GOODS	Use microwave safe paper plate or towels. One serving is 1 to 2 doughnuts, 1 roll, 1 muffin, etc. Place on a paper towel. No cover.
6	FRESH VEGETABLES	Use small bowl. Cover with microwave safe plastic wrap.
7	FROZEN VEGETABLES	Place frozen vegetable in microproof bowl or glass casserole. Add water and cover with plastic wrap. NOTE: Most vegetables improve with 2 to 3 minutes standing time after cooking.

OPERATION

AUTO DEFROST

Your microwave oven is preset with three defrost sequences (MEAT, POULTRY and FISH). The Auto Defrost method is the best way to defrost frozen foods.

Prepare the food for defrosting:

- Place the food in a flat, shallow baking dish or use a microwave roasting in the dish to catch drippings.
- Pierce meats with a casing, such as hot dogs and sausage, to allow steam to escape.
- Cover fatty or thin areas of meat with a small amount of foil before defrosting to prevent them from cooking.

During the defrosting cycle, remember:





- Check the food. If items open cook at the edges when defrosting, reduce the weight you set.
- Be sure to turn, stir or rotate the food as directed.

After defrosting, remember:

- Pierce dense roasts with a skewer to check whether defrosting is complete.
- Remove the giblets from poultry and rinse ice crystals out of cavity.

AUTO DEFROST INSTRUCTIONS

To set Auto Defrost.
(Example: To set 2.5 lbs. of ground beef)

	Touch STOP/CLEAR . (Erase all previous settings.)
	Touch MEAT . (ENTER and WEIGHT will blink.)
 	Enter the Weight of food. MIN. Food: 0.1 lb. MAX. Food: 9.9 lbs.
	Touch START .

Count down the time of the first stage. Five long beeps sound at the end of the first stage.

Open the door to separate, rearrange, cover or turn over the food. (Follow recipe directions.)

	Touch START to continue.
---	---------------------------------

At the end of the sequence, two short beeps and one long beep will sound and END displays.

Weight conversion chart

You are probably used to food weights being in pounds and ounces that are fractions of a pound (for example 4 ounces equals 1/4 pound).

However, in order to enter food weight in AUTO DEFROST, you must specify pounds and tenths of a pound. If the weight on the food package is in fractions of a pound, you can use the following chart to convert the weight to decimals.

EQUIVALENT OUNCE WEIGHT	NUMBER AFTER DECIMAL	
1.6	.10	
3.2	.20	
4.0	.25	One-Quarter Pound
4.8	.30	
6.4	.40	
8.0	.50	One-Half Pound
9.6	.60	
11.2	.70	
12.0	.75	Three-Quarters Pound
12.8	.80	
14.4	.90	
16.0	.100	One Pound

DEFROSTING TIPS

- **When using AUTO DEFROST**, the weight to be entered is the net weight in pounds and tenths of pounds (the weight of the food minus the container).
- **Use AUTO DEFROST** only for raw food. AUTO DEFROST gives best results when food to be thawed is a minimum of 0°F (taken directly from a **true** freezer). If food has been stored in a refrigerator-freezer that does not maintain a temperature of 5°F or below, always program a lower food weight (for a shorter defrosting time) to prevent cooking the food.
- **If the food is stored outside** the freezer for up to 20 minutes, enter a lower food weight.
- **The shape of the package** alters the defrosting time. Shallow rectangular packets defrost more quickly than a deep block.
- **Separate pieces** as they begin to defrost. Separated pieces defrost more easily.
- **You can use small pieces** of aluminum foil to shield foods like chicken wings, leg tips, and fish tails, but the foil must not touch the side of the oven. Foil causes arcing, which can damage the oven lining.
- **Shield areas of food** with small pieces of foil if they start to become warm.
- **For better results**, a preset standing time is included in the defrosting time.

OPERATION

AUTO DEFROST SEQUENCE TABLE

SEQUENCE	FOOD	BASE QTY.	MIN./MAX. FOOD
MEAT	<ul style="list-style-type: none"> • BEEF Ground beef (bulk), Round steak, Tenderloin steak, Pot roast, Rib roast, Rump roast, Chuck roast. Stew Beef, Ground beef (Patties) • LAMB Chops (1-inch, thick), Rolled roast Cubes for stew • PORK Chops (1/2-inch thick), Spareribs, Country-style ribs. Rolled roast, Sausage (links), Hot dogs • VEAL Cutlets (lbs., 1/2-inch thick) 	1 lb.	0.1/9.9 lbs.
POULTRY	<ul style="list-style-type: none"> • CHICKEN Whole (under 4 lbs.), Breast (boneless) Cut up. • CORNISH HENS Whole • TURKEY Breast (under 6 lbs.) 	1 lb.	0.1/9.9 lbs.
FISH	<ul style="list-style-type: none"> • FISH Fish fillets, Fish steak, whole fish • SHELL FISH Lobster tails, Crab meat, Shrimp, Scallops 	1 lb.	0.1/9.9 lbs.

GENERAL GUIDELINES

The benefit of this AUTO DEFROST feature is automatic setting and control of defrosting. But, just as in conventional defrosting, you must check the food during the defrosting time. Here are some important tips to remember about defrosting.

For best results when defrosting, remember :

- Do not defrost less than 1/4 lb. of ground beef.
- Freeze ground beef in a doughnut shape.
- Press down the center of ground beef patties before freezing.
- Meats, fish or poultry up to 6 lbs. defrost best.
- To reduce moisture loss, defrost meats just before cooking.
- To defrost convenience foods, follow package directions.

To prepare the item for defrosting, remember :

Remove the packaging.

NOTE : If the package is microwavable, pierce the package several times.

- Note the weight of the item on the package.
- When you calculate the weight of the item, round it to the nearest lower decimal. (See the weight conversion chart.)
- Remove metal twist ties from the packaging.
- For best results, remove meat, poultry, and fish from the original wrapper. The wrapper can hold steam and juice close to the food and cause the outer surface to cook.
- If removing the wrapper is difficult, defrost the wrapped food for about 1/4 of the defrosting time (displayed at the beginning of the defrost cycle). Then remove the food from the oven and remove the wrapping. Return the food to the oven and touch START.

OPERATION

DEFROST CHART

Meat setting

FOOD	SETTING	AT BEEP	SPECIAL INSTRUCTIONS
BEEF			Meat of irregular shape and large, fatty cuts of meat should have the narrow or fatty areas shielded with foil at beginning of a defrost sequence.
Ground beef (bulk)	MEAT	Remove thawed portions with fork. Turn over. Return remainder to oven.	Do not defrost less than 1/4 lb. Freeze in doughnut shape.
Ground beef (patties)	MEAT	Separate and rearrange.	Do not defrost less than 4 oz. patties. Depress center when freezing.
Round steak	MEAT	Turn over. Cover warm areas with aluminum foil.	Place on a microwavable roasting rack.
Tenderloin steak	MEAT	Turn over. Cover warm areas with aluminum foil.	Place on a microwavable roasting rack.
Stew beef	MEAT	Remove thawed portions with fork. Separate remainder. Return remainder to oven.	Place on a microwavable roasting rack.
Pot roast, chuck roast	MEAT	Turn over. Cover warm areas with aluminum foil.	Place on a microwavable roasting rack.
Rib roast	MEAT	Turn over. Cover warm areas with aluminum foil.	Place on a microwavable roasting rack.
Rolled rump roast	MEAT	Turn over. Cover warm areas with aluminum foil.	Place on a microwavable roasting rack.
LAMB			
Cubes for stew	MEAT	Remove thawed portions with fork. Return remainder to oven.	Place in a microwavable baking dish.
Chops (1-inch thick)	MEAT	Separate and rearrange.	Place on a microwavable roasting rack.
PORK			
Chops (1/2-inch thick)	MEAT	Separate and rearrange.	Place on a microwavable roasting rack.
Hot dogs	MEAT	Separate and rearrange.	Place on a microwavable roasting rack.
Spareribs Country - style ribs	MEAT	Separate and rearrange. Turn over. Cover warm areas with aluminum foil.	Place on a microwavable roasting rack. Place on a microwavable roasting rack.
Sausage, links	MEAT	Separate and rearrange.	Place on a microwavable roasting rack.
Sausage, bulk	MEAT	Remove thawed portions with fork. Turn over. Return remainder to oven.	Place in a microwavable baking dish.
Loin roast, boneless	MEAT	Turn over. Cover warm areas with aluminum foil.	Place on a microwavable roasting rack.

OPERATION

DEFROST CHART(continued)

Poultry setting

FOOD	SETTING	AT BEEP	SPECIAL INSTRUCTIONS
CHICKEN Whole (under 4 lbs.)	POULTRY	Turn over. Finish defrosting breast-side down. Cover warm areas with aluminum foil.	Place chicken breast-side-up on a microwavable roasting rack. Finish defrosting by immersing in cold water. Remove giblets when chicken is partially defrosted.
Cut-up		Turn over. Cover warm areas with aluminum foil. Separate pieces and rearrange.	Place on a microwavable roasting rack. Finish defrosting by immersing in cold water.
CORNISH - HENS Whole	POULTRY	Turn over. Cover warm areas with aluminum foil.	Place on a microwavable roasting rack. Finish defrosting by immersing in cold water.
TURKEY Breast (under 6 lbs.)	POULTRY	Turn over. Cover warm areas with aluminum foil.	Place on a microwavable roasting rack. Finish defrosting by immersing in cold water.

Fish setting

FOOD	SETTING	AT BEEP	SPECIAL INSTRUCTIONS
FISH Fillets	FISH	Turn over. Separate fillets when partially thawed if possible.	Place in a microwavable baking dish. Carefully separate fillets under cold water.
Steaks	FISH	Separate and rearrange.	Place in a microwavable baking dish. Run cold water over to finish defrosting.
Whole	FISH	Turn Over.	Place in a microwavable baking dish. Cover head and tail with foil; do not let foil touch sides of microwave . Finish defrosting by immersing in cold water.
SHELLFISH Crabmeat	FISH	Break apart. Turn Over.	Place in a microwavable baking dish.
Lobster tails	FISH	Turn Over and rearrange.	Place in a microwavable baking dish.
Shrimp	FISH	Separate and rearrange.	Place in a microwavable baking dish.
Scallops	FISH	Separate and rearrange.	Place in a microwavable baking dish.

NOTE: Food to be defrosted must be not more than 9.9 lbs.

OPERATION

CONVECTION COOKING

INTRODUCTION

Convection ovens are not new. They have been a favorite of professional bakers for many years. Both conventional and convection ovens cook food with heat generated by gas or electricity. In a conventional oven, air remains stationary; the heat rises to the top of the oven and is not evenly distributed throughout the oven interior. In a convection oven, a fan circulates the warm air. The continuous flow of warm air around food in a convection oven causes it to be cooked more evenly and somewhat faster than it can be cooked by motionless air in a conventional oven. Convection cooking, with its circulating hot, dry air, is a superb cooking method for baked goods, roasts, poultry and other foods that require a crisp, browned surface.

Your oven uses convection cooking whenever you use the Convection Command Pads.

- **Do not cover** baking rack with aluminum foil. It interferes with the flow of air that cooks the food.
- **Round pizza pans** are excellent cooking utensils for many convection-only items. Choose pans that do not have extended handles.
- **Use convection cooking** for items like souffles, breads, cookies, angel food cakes, pizza, and for some meat and fish cooking.
- **You do not need to use** any special techniques to adapt your favorite oven recipes to convection cooking; however, you may need to lower some temperatures or reduce some cooking times from the convection oven cooking directions.
- **When baking** cakes, cookies, breads, rolls or other baked foods, most recipes call for preheating. Preheat the empty oven just as you do a regular oven. You can start heavier dense foods such as meats, casseroles, and poultry without preheating.
- **All heatproof** cookware or metal utensils can be used in convection cooking.
- **As in conventional cooking**, the distance of the food from the heat source affects cooking results.
- **Use metal utensils** only for convection cooking. Never use for microwave or combination cooking since arcing and damage to the oven may occur.
- **After preheating**, if you do not open the door, the oven will automatically hold at the preheated temperature for 30 minutes.
- **You can set** up to three convection cycles.
(Example for two crust pies: you can set the oven to preheat for baking at 425°F and to finish baking at 350°F.)

OPERATION

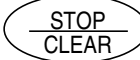

CONVECTION BAKING WITHOUT PREHEATING (Meats, Casseroles and Poultry)

To set Convection Baking.

 Touch **STOP/CLEAR**.





 Touch **BAKE**.

Touch the number for the baking temperature(optional).
Example for 325°F.
You can enter a temperature between 150°F and 450°F.

NOTE: To clear the temperature you entered, touch CONVECTION BAKE before entering a bake time. You can then enter the cooking temperature, if desired.

Touch numbers for cooking time.
Example for 20 minutes.
You can enter a time up to 99 minutes 99 seconds.

   

 Touch **START**.

You can see the cooking temperature anytime during cooking by touching CONVECTION BAKE. The cooking temperature will show for two seconds.



CONVECTION BAKING WITH PREHEATING

To set Convection Baking.





 Touch **STOP/CLEAR**.

 Touch **BAKE** twice.

Touch the number for the baking temperature(optional).
Example for 325°F.
You can enter a temperature between 150°F and 450°F.

Touch numbers for cooking time. Example for 20 minutes.

You can enter a time up to 99 minutes 99 seconds.



Touch **START**.
After preheating, open the door, put food in oven and close the door.

NOTE:

- If you open the door or touch **STOP/CLEAR** during preheating, preheating will stop. To resume preheating, close the door and touch **START**.
- When the oven reaches the set preheat temperature, four tones will sound and the oven will automatically hold that temperature for 30 minutes.





Touch **START**.

You can see the cooking temperature anytime during cooking by touching CONVECTION BAKE. The cooking temperature will show for two seconds.





CONVECTION BROILING

To set Convection Broiling.

 Touch **STOP/CLEAR**.

 Touch **BROIL**.

Touch numbers for cooking time.
Example for 20 minutes.
You can enter a time up to 99 minutes 99 seconds.

 Touch **START**.
After preheating, open the door, put food in oven and close the door.

NOTE:

- Oven will preheat to 450°F.
- If you open the door or touch **STOP/CLEAR** during preheating, preheating will stop. To resume preheating, close the door and touch **START**.
- When the oven reaches the set preheat temperature, four tones will sound and the oven will automatically hold that temperature for 30 minutes.

 Touch **START**.

You can see the cooking temperature anytime during cooking by touching CONVECTION BAKE. The cooking temperature will show for two seconds.

OPERATION

CONVENIENCE FOODS COOKING CHART FOR CONVECTION COOKING

Convection cooking of convenience foods is similar to cooking in a conventional oven. Select items that fit conveniently such as an 8 1/2-inch frozen pizza. Convection preheat to the desired temperature, and use metal or ovenproof glass cooking utensils. When cooking or baking these convenience foods, follow package directions for preparation and selecting the correct container. Because of the great variety of foods available, times given here are approximate. It is advisable to always check food about five minutes before the minimum recommended time, and cook longer only if needed. Use oven mitts to insert or remove items from the oven.

FOOD	SIZE/WT	COOKING MODE	COOKING TIME	SPECIAL INSTRUCTIONS
Pizza (frozen)	13 ounces (8 1/2 inch)	CONVECTION 400°F (preheated)	14-16 minutes	Bake in ovenproof pan on Metal Rack for crisper crust.
Brownies	20 ounces	CONVECTION 350°F(preheated)	23-26 minutes	Bake in 9-inch square pan on Metal Rack.
Frozen Double Crust Pie	26 ounces	CONVECTION 425°F (preheated) then 350°F	30 minutes 30-35 minutes	Bake in metal or ovenproof pan on Metal Rack.
Cake Layers	18-25 ounces	CONVECTION 325°F (preheated)	45 minutes	Bake one layer at a time on Metal Rack.
Apple Sauce Cake	18-25 ounces	CONVECTION 350°F (preheated)	30-35 minutes	Use metal 10-cup fluted tube pan on Metal Rack.
Date Nut Bread	17 ounces	CONVECTION 350°F (preheated)	40 minutes	Bake in 9x5-inch metal loaf pan on Metal Rack.
Frozen Bread Dough	16 ounces	CONVECTION 375°F (preheated)	25-30 minutes	Follow package directions for thawing and proofing dough. Bake in metal greased 8 1/2 x 4 1/2 x 2 1/2 - inch loaf pan on Metal Rack.
Refrigerated Cookies	20 ounces	CONVECTION 350°F (preheated)	8-9 1/2 minutes	Bake six at a time on metal round cookie sheet on Metal Rack.

NOTE: Use the normal position when cooking with the Metal Rack.

OPERATION

COMBINATION COOKING

INTRODUCTION

Some foods benefit from the combination of cooking by microwave energy and convection heat. This combination method allows you to take advantage of the speed moisture retention of microwave cooking and the crisping and browning effect of hot, dry air. For example, microwave energy will speed cooking and keep meat and poultry moist on the inside while convection heat crisps and browns the surface. When you use the micro/convection method, your oven will alternate automatically back and forth between both cooking methods and the results will delight and amaze you.

Your oven has two preprogrammed settings that make it easy to cook with both convection heat and

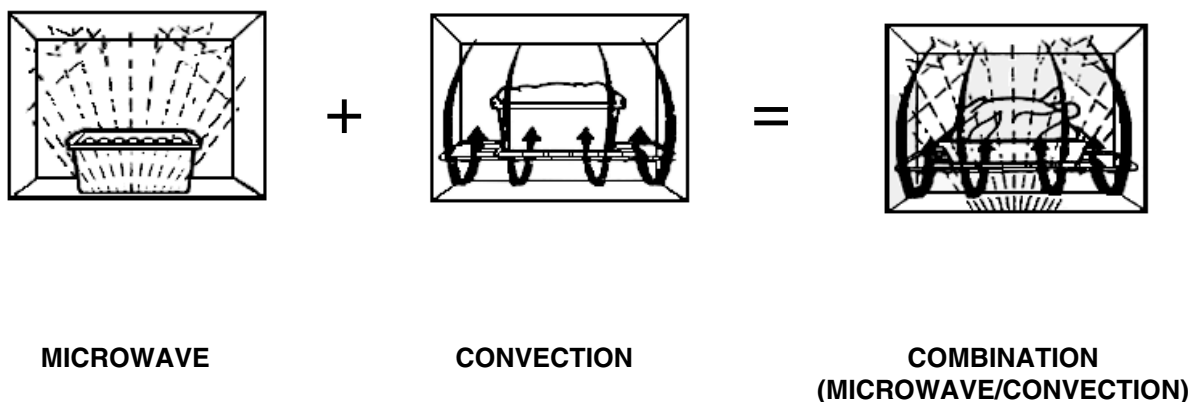

microwave energy automatically.

All utensils used for micro/convection cooking must be BOTH microwaveproof and heatproof. Oven-tempered heatproof glass, china, and pottery that do not have metal trim or glaze are the best choice. THE METAL RACK MAY BE USED IN COMBINATION COOKING ONLY WHEN SPECIFICALLY INDICATED IN A RECIPE.

However, METAL PANS MUST NEVER BE PLACED ON THE METAL RACK IN COMBINATION COOKING. If any metal touches the metal rack during a microwave cycle, arcing may occur and your oven may be damaged.

- Meats may be roasted directly on the Metal Rack or in a shallow roasting pan placed on the rack. When using the Metal Rack, please check the manual for information on proper use.
- Less tender cuts of beef can be roasted and tenderized using oven cooking bags.
- When baking, check for doneness after cooking time is up. If not completely done, let stand in oven for a few minutes to complete cooking.



NOTE: During combination baking, some baking utensils may cause arcing when they come in contact with the oven walls or metal racks. Arcing is a discharge of electricity that occurs when microwaves come in contact with metal. If arcing occurs, place a heatproof dish between the pan and the Metal Rack. If arcing occurs with other baking utensils, stop using them for combination cooking.



OPERATION





COMBINATION BAKING/ROASTING WITHOUT PREHEATING

To set Combination Baking/Roasting.

 Touch **STOP/CLEAR**.

COMBINATION
  Touch **BAKE** or **ROAST**.

   Touch the number for food temperature.
 Example for 325°F.
 You can enter a temperature between 150°F and 450°F.

    Touch numbers for cooking time.
 Example for 20 minutes.
 You can enter a time up to 99 minutes 99 seconds.



 Touch **START**.



You can see the cooking temperature anytime during cooking by touching **COMBINATION BAKE**(when baking)or **COMBINATION ROAST** (when roasting). The cooking temperature will show for two seconds.





COMBINATION BAKING/ROASTING WITH PREHEATING

To set Combination Baking/Roasting.

 Touch **STOP/CLEAR**.

COMBINATION
  Touch **BAKE** or **ROAST**.

   Touch the number for food temperature.
 Example for 325°F.
 You can enter a temperature between 150°F and 450°F.

    Touch numbers for cooking time.
 Example for 20 minutes.
 You can enter a time up to 99 minutes 99 seconds.

 Touch **START**.
 After preheating, open the door, put food in oven and close the door.

NOTE:

- If you open the door or touch **STOP/CLEAR** during preheating, preheating will stop.
 To resume preheating, close the door and touch **START**.
- When the oven reaches the set preheat temperature, four tones will sound and the oven will automatically hold that temperature for 30 minutes.

 Touch **START**.

You can see the cooking temperature anytime during cooking by touching **COMBINATION BAKE**(when baking) or **COMBINATION ROAST** (when roasting). The cooking temperature will show for two seconds.

OPERATION

AUTO COMBINATION

AUTO COMBINATION lets you cook with both microwaves and convection heat, without needing to set a cooking time or cook power. All you do is choose the category of the food you are cooking and enter the weight or quantity.

See the Auto Combination Chart on this page for the setting available to you.

Auto Combination Chart

Setting	Food	Quantity /Weight You Can Cook
1	Hamburger	0.3 ~ 2.0 lbs
2	Chicken Piece	0.5 ~ 3.0 lbs
3	Whole Chicken	2.0 ~ 3.5 lbs
4	Turkey	4.0 ~ 9.0 lbs
5	Cake	1 layer / 2 layers
6	Bread	1 loaf / 2 loaves

To set Auto Combination.



Touch **STOP/CLEAR**.

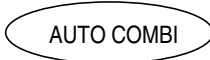

Touch **AUTO COMBI**.



Touch numbers for food category.
Example for setting 1 (Hamburger).







Touch numbers for food weight or quantity.
Example for 1 lb of Hamburger.



Touch **START**.
After preheating, open the door, put food in oven and close the door.



Touch **START**.
At beep open the door, turn over the food in oven and close the door.



Touch **START** to continue.

USING THE METAL RACK

The Metal Rack gives you extra space when cooking in more than one container at the same time. The metal rack must not be turned upside-down on the bottom of the oven. You can also use the metal rack for convection cooking.

INSERTING THE RACK

NORMAL POSITION

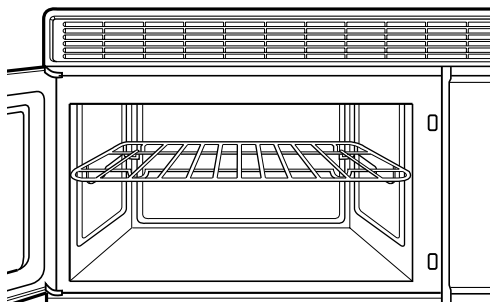

Normal position: Insert the rack securely on the rack guides on the side walls of the oven.

BOTTOM POSITION

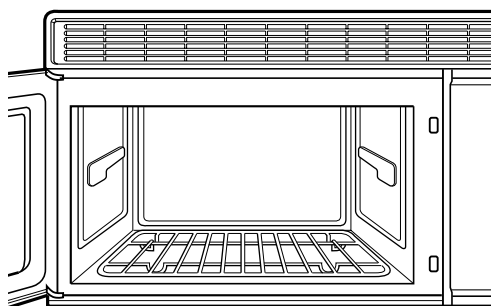

Bottom position: Insert the rack securely on the bottom of the oven.

- Use hot pads when removing rack from oven after cooking to prevent burns. Rack may be hot.
- Do not store the metal rack in the oven.
Arcing and damage to the oven could result if someone accidentally starts the oven.
- Use rack only in the microwave oven.
- Do not use rack with browning dish.
- Do not let food container on rack touch the top or sides of the oven.
- Do not cook foods directly on rack without putting them in containers first.
- Do not place a metal cooking container on rack when microwave cooking or combination cooking.
Place a microwave-safe plate under container.

UTENSIL GUIDE

You can use a variety of utensils and materials in your microwave-convection oven. For your safety and to prevent damage to utensils and your oven, choose appropriate utensils and materials for each cooking method. The list below is a general guide to help you select the correct utensils and materials.

MATERIAL	UTENSILS	MICROWAVE COOKING	COMBINATION COOKING	CONVECTION COOKING
Ceramic & Glass	Ceramic	YES	YES	YES
	Ovenproof, Heat-Tempered, Microwave-Safe Glassware	YES	YES	YES
	Glassware with Metal Decoration	NO	NO	YES
	Lead Glass	NO	NO	YES
China	Without Metal Decoration (Ovenproof and Heat-Tempered)	YES	YES	YES
Pottery		YES	YES	YES
Plastic	Regular Ovenproof	YES	YES	YES
	Heat-Tempered Ware	YES	NO	NO
Metal	Bake/Roast Rack	NO	NO	YES
	Metal Baking Pan	NO	NO	YES
Aluminum Foil		*	*	YES
Paper	Cups, Plates, Towels	YES	NO	NO
Straw, Wicker, Wood		YES	NO	NO
Wax Paper		YES	NO	NO
Plastic Wrap		YES	NO	NO

YES: Utensils to use

NO: Utensils to avoid

CARE AND CLEANING

GENERAL

For best performance and safety, keep the oven clean inside and outside. Take special care to keep the inner door panel and the oven front frame free of food or grease build-up.

NEVER USE ROUGH POWDERS OR PADS. Wipe the microwave oven inside and out, including the hood bottom cover, with a soft cloth and a warm (not hot) mild detergent solution. Then rinse and wipe dry.

Use a chrome cleaner and polish on chrome, metal and aluminum surfaces.

Wipe spatters immediately with a wet paper towel, especially after cooking chicken or bacon.

Clean your oven weekly or more often, if needed.

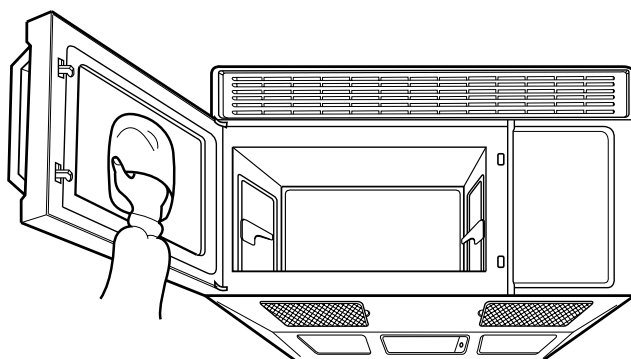

Metal Rack

Remove the metal rack to clean it at the sink.

Use a mild detergent solution. Then rinse and wipe dry.

Grease Filters

Remove the metal mesh grease filters on the hood bottom cover for washing at the sink. To remove each filter :

1. Grasp the tab at the end of the filter, as shown.
2. Slide the filter toward each side of the oven.
3. Pull it downward and out.

Use a warm detergent solution, rinse and wipe dry.

DO NOT USE AMMONIA to clean an aluminum mesh filter.

Do not run the hood fan without the filter.

To reinstall the filter, slide it into the side slot, then push up and toward oven center to lock.

The filter should be completely dry before reinstalling into the oven.

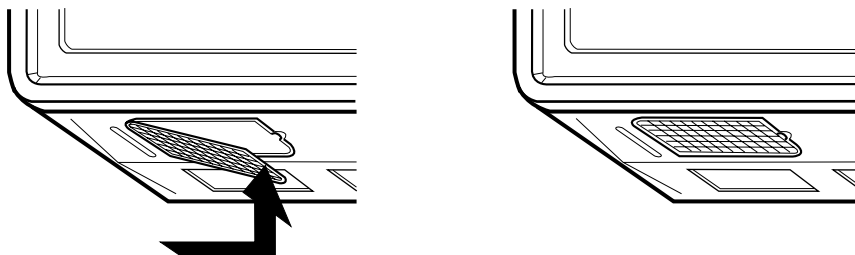

CARE AND CLEANING

Charcoal Filter(Optional) Replacement

If your oven is vented inside, the charcoal filter needs replacing every 6 to 12 months, and more often if necessary. The charcoal filter removes odors and smoke from the vented air. If you start smelling cooking odors or see some smoke, you need to replace the charcoal filter. Here's how:

1. To order a new charcoal filter, contact your dealers parts department.
2. Remove the two vent grille mounting screws.
If the screws are not accessible, remove the oven from the wall.
3. Tip the grille forward, then lift it out.
4. Lift the back of the charcoal filter and slide it toward you.
5. Slide a new charcoal filter into place.
6. Put the grille back on with the mounting screws.

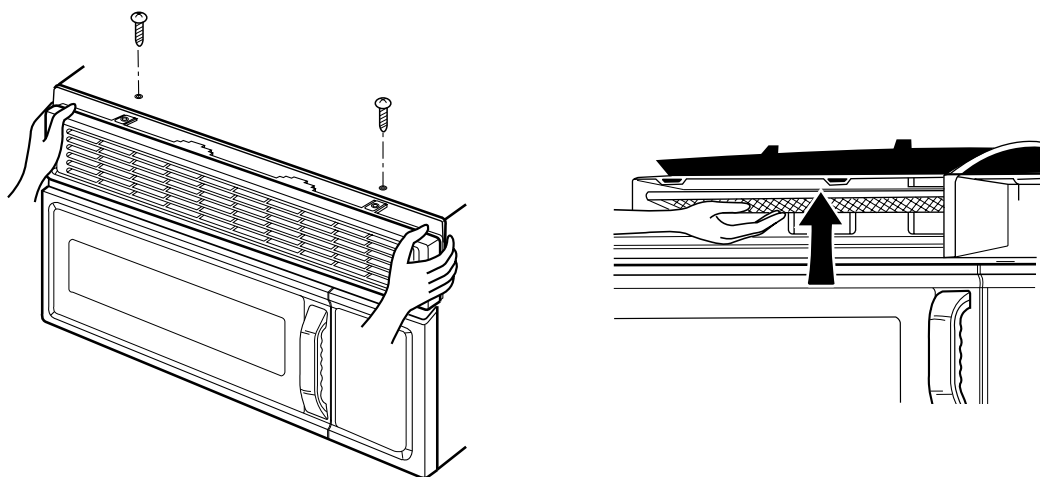

Work Light Replacement(Cooktop/Countertop Light)

When either bulb in the work light burns out, you will need to replace it with a 30 watt appliance bulb.

1. Disconnect the power at the circuit breaker or unplug the power cord.
2. Remove the phillips head screw from the work light cover. Right side will drop.
3. Unhook tab at left side.
4. Unscrew the burned out bulb and replace with one of the same size and wattage (30 watts).
5. Replace the work light cover and the screw.
6. Reconnect the power.
7. Set the Time of Day (see Page 9).

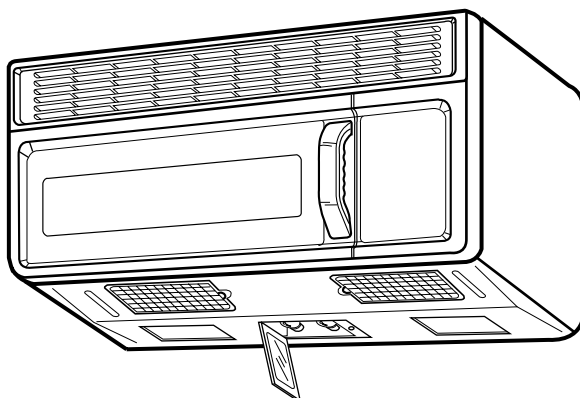

QUESTIONS AND ANSWERS

OPERATION

Q. What is wrong when the oven light will not glow during cooking or when the oven door is open?

A. *There may be several reasons why the oven light will not glow. Perhaps:*

The door is not closed & locked. Push the door firmly to be sure that the door is locked properly.

- The light bulb has burned out.

Q. Why does steam come out of the vent grill?

A. *Steam is normally produced during cooking. The microwave oven has been designed to vent this steam out the left side vent.*

Q. Will the microwave oven be damaged if it operates empty?

A. *Yes. Never operate the oven empty.*

Q. Does microwave energy pass through the viewing screen in the door?

A. *No. The metal screen bounces back the energy to the oven cavity. The holes (or ports) are made to allow light to pass through. They do not let microwave energy pass through.*

Q. Why does the "beep" tone sound when a "pad" on the control panel is touched?

A. *The "beep" tone sounds to assure that the setting is being properly entered.*

Q. Can my microwave oven be damaged if food is cooked for too long a period of time?

A. *Like any other cooking appliance, it is possible to destroy food by overcooking, which may result in smoke and even possible fire damage to the inside of the oven. It is always best to stay with the oven while it is cooking. See the "Safety Instructions" on pages 4 and 5.*

Q. Why does the hood fan start when I have not pushed the Fan Control Button?

A. *The hood fan starts automatically to prevent the oven from overheating.*

Q. When the oven is plugged into a wall outlet for the first time, it may not work properly. What is wrong?

A. *Only when the oven is plugged in for the first time or when power starts again after a power outage, the microcomputer in the oven may become scrambled and not work as it was programmed to work. Unplug the oven from the 120V household outlet and then plug it back in. The microcomputer will reset and work properly afterward.*

Q. Why do I see light reflection around the outer case?

A. *This light is from the oven light located outside the cavity.*

Q. How can I be sure the oven is turned off when the hood fan is running?

A. *The hood fan may be louder than the oven. If you are not sure the oven is off, turn off the hood fan and check to see if the oven is operating. The oven is designed to turn off automatically when you open the door.*

If, for some reason, you are still not satisfied, have your oven checked.

FOODS

Q. What is wrong when baked foods have a hard, dry, brown spot?

A. *A hard, dry, brown spot shows overcooking. Shorten the cooking or reheating time.*

Q. Why do eggs sometimes pop?

A. *When baking, frying or poaching eggs, the yolk may pop due to steam build-up inside the yolk membrane. To prevent this build-up, simply pierce the yolk with a toothpick before cooking it.*

QUESTIONS AND ANSWERS

CAUTION

Never microwave eggs in the shell.

Q. Why are scrambled eggs sometimes a little dry after cooking?

A. Eggs dry out if they are overcooked. Though you use the same recipe each time, you may need to vary the cooking time for one of these reasons:

- Eggs vary in size.
- Eggs are at room temperature one time and at refrigerator temperature another time.
- The shape of utensils vary, making cooking time vary also.
- Eggs continue cooking during standing time.

Q. Is it possible to popcorn in a microwave oven?

A. Yes, if using one of the two methods described below.

1. Microwave-popping devices designed for microwave cooking
2. Prepackaged commercial microwave popcorn that suggests specific times and power outputs needed for an acceptable final product.

FOLLOW EXACT DIRECTIONS GIVEN BY EACH MANUFACTURER FOR THE POPCORN POPPING PRODUCT AND DO NOT LEAVE THE OVEN UNATTENDED WHILE THE CORN IS BEING POPPED.

IF THE CORN FAILS TO POP AFTER THE SUGGESTED TIMES, DISCONTINUE COOKING. OVERCOOKING COULD RESULT IN AN OVEN FIRE.

CAUTION

Never use a brown paper bag for popping corn.

Q. What is wrong when three potatoes bake thoroughly and the fourth one is still not cooked?

A. The fourth potato may be slightly heavier than the others, and should be cooked 30 to 60 seconds longer.

Remember to allow space around each potato when baking. Also, for more even cooking, put the potatoes in a circle.

Q. Why do baked apples sometimes burst during cooking?

A. The peeling has not been removed from the top half of each apple to allow for expansion of the interior of the apple during cooking. As in regular cooking the interior of the apple expands during cooking.

Q. How do you avoid boilovers?

A. When cooking foods that tend to boil over, use a larger utensil than usual for cooking. If you open door or press STOP, the food will stop boiling. (Remember to press START again after closing the the door to restart the cooking cycle.)

Q. Why is standing time necessary after microwave cooking is over?

A. Standing time allows foods to continue cooking evenly throughout for a few moments after the actual microwave oven cooking cycle. The amount of standing time depends on the density of the food.

Q. Why is additional time required for cooking food stored in the refrigerator?

A. As in conventional cooking, the initial temperature of food affects total cooking time. Refrigerated foods take more time to cook than foods stored at room temperature.

BEFORE CALLING FOR SERVICE

You can often correct operating problems yourself. If your microwave oven fails to work properly, locate the operating problem in the list below and try the solutions listed for each problem.

PROBLEM :

Oven will not start

- Is the power cord plugged in?
- Is the door closed?
- Is the cooking time set?
- Is the temperature set?

Arcing or Sparking

- Are you using the approved cookware?
- Is the oven empty?

Incorrect time of day

- Have you tried to reset?

Unevenly Cooked Foods

- Are you using the approved cookware?
- Were the foods turned or stirred?
- Were the foods completely defrosted?
- Was the time/cooking power level correct?

Overcooked Foods

- Was the time/cooking power level correct?
- Was the temperature setting correct?

Undercooked Foods

- Are you using the approved cookware?
- Were the foods completely defrosted?
- Was the time/cooking power level correct?
- Are the ventilation ports clear?

Improper Defrosting

- Are you using the approved cookware?
- Were the foods turned or stirred?
- Was the time/cooking power level correct?
- Did you use the metal rack?

MEMO

MEMO

MEMO

Limited Warranty

For Dometic Microwave Models DOTRC11B/W

THE SELLER NAMED BELOW MAKES THE FOLLOWING WARRANTY WITH RESPECT TO THIS DOMETIC MICROWAVE OVEN.

1. This Warranty is made only to the first Purchaser (hereinafter called the "Original Purchaser") who acquires this product for his own use.
2. This Warranty will be in effect for three years from the date of purchase by the Original Purchaser. It is suggested that the Original Purchaser retain a copy of the dated bill of sales as evidence of the date of purchase.
3. This Warranty covers only specified parts which shall be free from defects in material and workmanship under normal use. This Warranty does not cover conditions unrelated to the material and workmanship of the product. Such unrelated conditions include, but are not limited to (a) faulty installation and any damage resulting from such; (b) the need for normal maintenance and any damage resulting from the failure to provide such maintenance; (c) failure to follow Seller's instructions for use of the product, and (d) any accident to, or misuse of any part of this product and any alteration by anyone other than Seller or the authorized representative.
4. In order to obtain the benefits of this Warranty, you should return the product which you find defective to your dealer during the period that this Warranty is in effect. All charges incurred in delivery of the microwave to Seller must be paid by the Original Purchaser. A copy of the dated bill of sale must accompany the returned microwave oven.
5. Any item returned in the manner described in paragraph 4 will be examined by your dealer. If it is found that the microwave is defective in material and workmanship, the Seller will replace the appliance.
6. The Seller does not authorize any person or company to create an warranty obligation or liability on their behalf.
7. IN NO EVENT SHALL SELLER BE LIABLE FOR INCIDENTAL OR CONSEQUENTIAL DAMAGES, SOME STATES DO NOT ALLOW THE EXCLUSION OR IMITATION OF INCIDENTAL OR CONSEQUENTIAL DAMAGES SO THE ABOVE LIMITATION MAY NOT APPLY TO YOU.
8. ANY IMPLIED WARRANTY, INCLUDING THE IMPLIED WARRANTY OF MERCHANTABILITY AND FITNESS FOR ANY PURPOSE, IS LIMITED TO THE DURATION OF THIS LIMITED WARRANTY, SOME STATES DO NOT ALLOW LIMITATIONS ON HOW LONG AN IMPLIED WARRANTY LASTS, SO THE ABOVE LIMITATION MAY NOT APPLY TO YOU.
9. THIS WARRANTY GIVES YOU SPECIFIC LEGAL RIGHTS, AND YOU MAY ALSO HAVE OTHER RIGHTS WHICH VARY FROM STATE TO STATE.
10. All appliances (except those specifically built for commercial use) are warranted only when installed in vehicles built to the R.V.I.A and CSA Standards.

Seller in USA

The Dometic Corporation
The Warranty Department
509 South Poplar Street
LaGrange, Indiana 46761

Seller in CANADA

The Dometic Corporation
The Warranty Department
866 Langs Drive
Cambridge, Ontario
Canada N3H 2N7