



OWNER'S MANUAL

CERAMIC-GLASS INDUCTION COOKTOP

Read this owner's manual thoroughly before operating the appliance and keep it handy for reference at all times.

HN951VA



MFL54169109_00

www.signaturekitchensuite.com

Copyright © 2018 Signature Kitchen Suite. All Rights Reserved.

TABLE OF CONTENTS

3 IMPORTANT SAFETY INSTRUCTIONS

9 INTRODUCTION TO INDUCTION COOKING

- 9 Selecting Cookware

11 PARTS AND FEATURES

- 11 Parts and Features of the Cooktop
- 12 Touch Control Features

13 OPERATING INSTRUCTIONS

- 13 Getting Started
- 13 Changing Cooktop Settings
- 16 Before Using the Cooktop
- 16 Setting the Controls
- 18 Using the Cook Modes
- 19 Using the Flex Cooking Zones
- 19 Using the Cook Mode Function
- 20 Other Functions

21 SMART FUNCTIONS

- 21 SIGNATURE KITCHEN SUITE Application
- 22 FCC Notice
- 22 FCC RF Radiation Exposure Statement

23 CARE AND CLEANING

- 23 Cleaning the Cooktop

25 INSTALLATION INSTRUCTIONS

- 25 Before You Begin
- 25 Unpacking the Cooktop
- 26 Technical Specifications
- 27 Preparing the Installation Location
- 28 Dimensions and Clearances
- 29 Electrical Connections
- 31 Cooktop Installation
- 31 Final Check

32 TROUBLESHOOTING

- 32 Before Calling for Service

33 WARRANTY

IMPORTANT SAFETY INSTRUCTIONS

Read and follow all instructions when using the range to prevent the risk of fire, electric shock, personal injury, or damage. This guide does not cover all possible conditions that may occur. Always contact your service agent or manufacturer about problems that you do not understand.

Download this owner's manual at: www.signaturekitchensuite.com



This is the safety alert symbol. This symbol alerts you to potential hazards that can result in property damage and/or serious bodily harm or death.

All safety messages will follow the safety alert symbol and either the word WARNING or CAUTION. These words mean:



WARNING - Indicates a hazardous situation which, if not avoided, could result in death or serious injury.



CAUTION - Indicates a hazardous situation which, if not avoided, could result in minor or moderate injury.



WARNING

- For your safety, the information in this manual must be followed to minimize the risk of fire, electric shock, or to prevent property damage, personal injury, or death.

SAFETY PRECAUTIONS

- **Proper Installation:** Be sure your appliance is properly installed and grounded by a qualified technician in accordance with the National Electrical Code ANSI/NFPA No. 70, latest edition in the United States, and all local code requirements. Install only per installation instructions.
- Do not attempt to repair or replace any part of your cooktop unless it is specifically recommended in this manual. All other service should be referred to a qualified technician.
- Remove all tape and packaging wrap before using the appliance. Destroy the carton and plastic bags after unpacking the appliance. Never allow children to play with packaging material.
- The safety aspects of this appliance comply with accepted technical standards.
- **Know how to disconnect the electrical power to the appliance at the circuit breaker or fuse box in case of an emergency.** Mark the breaker or fuse for ease of identification and swift action if necessary.
- **Do not repair or replace any part of the appliance.** All servicing should be done only by a qualified technician to avoid the risk of personal injury and damage to the appliance.
- **Never modify or alter the construction of an appliance such as removal of panels, wire covers or any other permanent part of the product.**
- **Storage on appliance: Flammable materials should not be stored near or on the cooking surface.** This includes paper, plastic and cloth items, such as cookbooks, plasticware and towels, as well as flammable liquids. Do not store explosives, such as aerosol cans, on or near the appliance. Flammable materials may explode and result in fire or property damage.
- **Do not leave children alone. Children should not be left alone or unattended in the area where an appliance is in use.** They should never be allowed to sit or stand on any part of the appliance.
- **Do not store or use gasoline or other flammable vapors and liquids in the vicinity of this or any other appliance.**

 **CAUTION**

- Items of interest to children should not be stored in cabinets above a cooktop or on the backsplash of a cooktop – children climbing on the cooktop to reach items could be seriously injured.

 **WARNING**

- Never use your appliance for warming or heating a room.

 **WARNING**

- Persons with a pacemaker or similar medical device should exercise caution using or standing near an induction unit while it is in operation, as the electromagnetic field may affect the working of the pacemaker or similar medical device.
It would be advisable to consult your doctor or the pacemaker or medical device manufacturer about your particular situation.

 **CAUTION**

- **DO NOT touch cooking zones or areas near these surfaces.** Cooking zones may be hot from residual heat even though they are dark in color. Areas near the cooking zones may become hot enough to cause burns. During and after use, do not touch or let clothing or other flammable materials touch these areas until they have had sufficient time to cool.
- **Never wear loose fitting or hanging garments while using this appliance.**

- Always turn off all controls when cooking is completed.
- Never allow children to sit or stand on any parts of the appliance as they could be injured or burned.
- **Wear proper apparel. Loose-fitting or hanging garments should never be worn while using the appliance.** Do not let clothing or other flammable materials contact hot surfaces.
- **Do not use water or flour on grease fires.** Smother the fire with a pan lid, or use baking soda, a dry chemical or foam-type extinguisher.
- **When heating fat or grease, watch it closely.** Fat or grease may catch fire if allowed to become too hot.
- **Use only dry pot holders.** Moist or damp pot holders on hot surfaces may result in burns from steam. Do not let pot holders touch hot surface units. Do not use a towel or other bulky cloth instead of a pot holder.
- **Do not heat unopened food containers.** A buildup of pressure may cause the container to burst and result in injury.

ELECTRICAL SAFETY

 **WARNING**

- If the surface is cracked, switch off the appliance to avoid the possibility of electric shock. Do not reuse your COOKTOP until the glass surface has been changed.
- When using the COOKTOP, never use aluminum foil, products wrapped in aluminum foil, or deep-frozen food in aluminum cookware.
- If the supply cord is damaged, it must be replaced by the manufacturer, its service agent or similarly qualified persons in order to avoid a hazard.

- The installation and connection of the new appliance must only be carried out by qualified personnel.
- Flush-mounted appliances may only be operated following installation in suitable cabinets and workplaces which conform to the relevant standards. This ensures sufficient protection against electric shock as required by certification agencies.
- If your appliance malfunctions or fractures, switch off all cooking zones, and contact the Signature Kitchen Suite Customer Information Center for service.

CHILD SAFETY

WARNING

- This appliance is not intended for use by young children or infirm persons unless they have been adequately supervised by a responsible person to ensure that they can use the appliance safely.
- Young children should be supervised to ensure that they do not play with the appliance.
- Accessible parts may become hot during use. Young children should be kept away.

SAFETY DURING USE

- **This appliance may only be used for normal cooking and frying in the home.** It is not designed for commercial or industrial purposes.
- **Do not use the cooktop to heat the room.**
- **Take care when plugging in electric appliances near the cooktop.** Cords must not come into contact with the hot surface. This could cause damage to the cooktop and cable insulation.
- **Overheated fats and oils catch fire quickly.**
You should supervise cooking when preparing foods in fat or oil.
- **After use, switch off the hob element by its control and do not rely on the pan detector.**
- **Always keep the control display panel clean and dry.**
Do not let liquids or grease remain on the cooktop display area. Spilled or burnt-on foods can activate or deactivate the appliance. Clean the display area thoroughly to resume normal operation of the appliance.
- **Never place combustible items on the cooktop.**
- **Never keep any combustible items or aerosol cans in a drawer located under the cooktop.**
- **Avoid placing metal cooking utensils on the cooking surface areas.** Metal objects can become hot and cause burns.
- **Clean the appliance regularly to keep all parts free of grease that could catch fire.**
Exhaust fan ventilation hoods and grease filters should be kept clean. Do not allow grease to accumulate on hood or filter. Greasy deposits in the fan could catch fire. Refer to hood manufacturer's instructions for cleaning.
- **Use Proper Pan Sizes.** This appliance is equipped with one or more surface units of different size.
- **Select utensils having flat bottoms large enough to cover the cooking zones.** The pan detection sensors will not allow the affected cooking zones to operate without a pan present.
- **Do not place any object on or near the display area in order to prevent accidental activation of the cooktop controls.**

- **Cookware handles should be turned inward and not extend over adjacent surface units.** To reduce the risk of burns, ignition of flammable materials, and spillage due to unintentional contact with the cookware, the handles of cookware should be positioned so that they are turned inward, and do not extend over adjacent surface units.
- **Never leave prepared food on the cooking zones.** Boilovers cause smoking and greasy spillovers that may ignite, or a pan that has boiled dry may melt or become damaged.
- **Protective liners: Do not use aluminum foil to line any part of the cooktop.** Only use aluminum foil as recommended after the cooking process, if used as a cover to be placed over the food. Any other use of aluminum foil may result in the risk of electric shock, fire or short circuit.
- **Glazed cookware: Only certain types of glass, glass/ceramic, ceramic, earthenware, or other glazed cookware are suitable for rangetop service without breaking due to the sudden change in temperature.** Check the manufacturer's recommendations for cooktop use.
- **Ventilating hood: The ventilating hood above the cooking surface should be cleaned frequently, so the grease from cooking vapors does not accumulate on the hood or filter.**
- **Do not clean or operate a broken cooktop.** If cooktop should break, cleaning solutions and spillovers may penetrate the broken cooktop and create a risk of electric shock. Contact a qualified technician immediately.
- **Clean cooktop with caution.** Do not use sponges or cloth to wipe spills on a hot cooking area. Use a proper metal scraper.
- **Do not place hot cookware on cold cooktop glass.** This could cause glass to break.
- **Do not slide pans across the cooktop surface.** They may scratch the cooktop surface.
- **Do not let pans boil dry.** This may cause permanent damage in the form of breakage, fusion, or marking that can affect the ceramic-glass cooktop. (This type of damage is not covered by your warranty.)
- **Never leave surface units unattended at high heat settings.** Boilover causes smoking and greasy spillovers that may ignite.
- Do not use water on grease fires. Use baking soda or a dry chemical or foam-type extinguisher to smother fire or flame.
- **Always turn off all controls when cooking is completed.**
- **Use only dry potholders.**
Moist or damp pot holders on hot surfaces may result in burns from steam.
Do not let the pot holder touch hot heating elements. Do not use a towel or other bulky cloth.

SAFETY WHEN CLEANING

- **Always switch off the appliance before cleaning.**
- **For safety reasons, do not clean the appliance with a steam jet or high-pressure cleaner.**
- **Clean the cooktop in accordance with the maintenance and cleaning instructions in this manual.**
- **Do not use harsh abrasive cleaners or rough metal scrapers to clean the cooktop glass since they can scratch the surface, which may result in shattering of the glass.**
- **Clean cooktop cautiously.** Do not use sponges or cloth to wipe spills on a hot cooking area. Use a proper metal scraper.

COOK MEAT AND POULTRY THOROUGHLY

- Cook meat and poultry thoroughly—meat to at least an INTERNAL temperature of 160°F and poultry to at least an INTERNAL temperature of 180°F. Cooking to these temperatures usually protects against food-borne illnesses.

HOW TO AVOID DAMAGE TO THE APPLIANCE

- Prior to using the cooktop for the first time, apply the recommended cooktop cleaning cream to the ceramic surface. Buff with a non-abrasive cloth or pad. This will make cleaning off cooking soil easier.
The special cooktop cleaning cream leaves a protective finish on the glass to help prevent scratches and abrasions.
- Do not use the cooktop as a worksurface or storage space.
- Please be careful at the edges when moving pots and pans.
- Do not operate the cooking zones with empty pots or pans.
- Do not turn on the cooking zones with no pots or pans on the element.
- Ceramic glass is very tough, and impervious to sharp temperature changes but is not unbreakable. It can be damaged if hard or sharp objects fall on it.
- Be very cautious if using pots made of cast iron, or other pots with rough edges or burrs. Moving these can cause scratches on glass.
- If sugar or a mixture containing sugar falls onto a hot cooking zone and melts, remove immediately, while still hot. If left to cool down, it may damage the surface when removed.
- Do not slide metal or glass across the cooktop surface.
- Keep meltable objects or materials away from the ceramic glass surface, for example, plastic utensils, aluminum foil, or cooking wraps.
If any materials or foodstuffs melt on the ceramic-glass surface, these should be cleaned up immediately.

NOTE

There is a risk of burning yourself when the glass scraper is used on a hot cooking zone!

- Do not use cookware with any dirt buildup on the bottom.
- Do not use cookware with rough or uneven bottoms. This cookware can mark and scratch the cooktop surface.
- Refer to the owner's manual for proper cleaning and maintenance of the cooktop.
- **Do not use the glass cooktop surface as a cutting board.**

DISPOSAL OF OLD APPLIANCES

To protect the environment, it is important that worn-out appliances are disposed of in the correct manner.

- The appliance must not be disposed of with household rubbish.
- You can obtain information about collection dates or public refuse disposal sites from your local government offices or state environmental protection agency.



CAUTION

Before disposing of old appliances please make them inoperable so they cannot be a source of danger. To do this, have a qualified person disconnect the appliance from the house circuitry.

Read and follow this safety information carefully.
SAVE THESE INSTRUCTIONS

INTRODUCTION TO INDUCTION COOKING

How Induction Cooking Works

An induction coil beneath the ceramic glass cooking surface generates magnetic fields, which act directly on the base of the pots and pans.

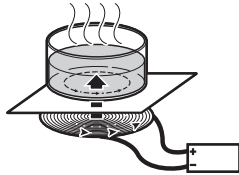

Instead of heating the ceramic glass, this method heats the base of the pan immediately, saving time and energy. Since the heat required for cooking is generated directly in the base of the pan, the cooking zone itself warms up only slightly. The cooktop does become hot when heat is transferred from the cookware.

NOTE

If there is no pot or pan on the cooking zone, there is no energy transfer and the surface remains cool. This prevents the cooking zones from being switched on accidentally.

IMPORTANT

- Remove all tape and packaging wrap before using the appliance. Destroy the carton and plastic bags after unpacking the appliance. Never allow children to play with packaging materials.
- Electromagnetic fields can affect electronic circuits and interfere with portable radios and phones.
- Do not put magnetically active objects (e.g., credit cards, computer diskettes, cassettes) on or near the ceramic glass surface while one or more induction cooking zones are in use.
- Do not put any metallic objects (e.g., spoons, pan lids) on the cooking zones as they can become hot when the cooking zones are in use.

Selecting Cookware

The magnetic cooking zone sensors located below the cooktop surface require the use of cookware made with magnetic material in order to start the heating process on any of the cooking zone. When purchasing pans, look for cookware specifically labeled by the manufacturer for use with induction cooktops.

Pots and Pans

- In principle, all pots and pans with magnetic bases are suitable. These include steel, enameled steel, as well as cast-iron pots and pans.
- High grade steel pans with a mixed metal base (sandwich base, e.g. Tefal® with an aluminum/copper base) are suitable for induction only if the manufacturer has expressly marked them as such. In that case they have a magnetic material in the base.
- If you wish to use a special type of pan (e.g., a pressure cooker, simmering pan, wok), please follow the manufacturer's instructions and do not use a very thin pan.

NOTE

Some cookware can produce noises when used on induction cooking zones. This is not a fault in the cooktop, and its function will not be impaired in any way as a result.

Suitability Test

If you are not sure if a pot or pan is suitable for use with your induction cooktop, you can find out with a few simple tests:

- Place a pot filled with a little water (1/8"–1/4") on the cooking zone. Set the cooking zone to full power (power level 9). If the pan is suitable, the base should heat up within a few seconds and the water should rapidly boil.
- You can also check cookware suitability with a magnet. If the magnet remains fixed to the base of the pan, the pan is suitable for induction cooking.

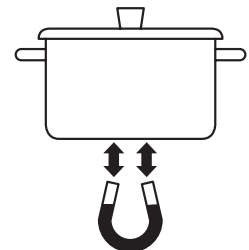

CAUTION

Keep an eye on cookware to avoid burns or boilovers. Cookware will heat within seconds, and water will come to a boil very rapidly.

Use Flat-Bottomed Cookware

Cookware must fully contact the surface of the cooking element. Use flat-bottomed pans sized to fit the cooking element and amount of food being prepared. Check for flatness by rotating a ruler across the bottom of the cookware.

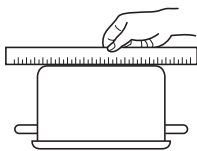

Avoiding Scratches

Use heavier gauge stainless steel cookware on your ceramic cooktop surface. This will help reduce the possibility of developing scratches on the ceramic surface.

Low-quality cookware can scratch the cooktop surface.

Cookware should always be lifted over the ceramic cooktop surface to prevent scratching.

Sliding any type of cookware over the ceramic cooktop can affect the overall appearance of the cooktop. Over time, sliding ANY type of cookware over the ceramic cooktop may alter the overall appearance of the cooktop. Eventually, the buildup of scratches can make cleaning the surface difficult and degrade the overall appearance of the cooktop.

Scratches can also result from grains of sand (e.g., after washing vegetables) which are dragged with the pot across the cooking surface.

For Best Results:

Always follow the recommendations for proper cookware type and size. In addition:

- Do not use dirty pans with grease buildup. Always use pans that are easy to clean after cooking, and make sure that the bottoms of the pans are clean and dry.
- When cooking with large amounts of liquid, use large pots so that nothing can boil over.
- Do not let pans boil dry. This may cause permanent damage in the form of breakage, fusion, or marring that can affect the ceramic cooktop. (This type of damage is not covered by your warranty.)
- Match the pan size and cooking zone to the amount of food being prepared.

Tips for Saving Energy:

- Always position pots and pans before switching on the cooking zone.
- Dirty cooking zones and cookware use more electricity.
- Whenever possible, place lids firmly on pots and pans so that they are completely covered.

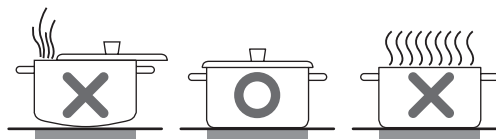

- Switch off the cooking zones before the end of the cooking time to use the residual heat for keeping food warm or to melt food.
- The base of the pot should be the same size as the cooking zone.

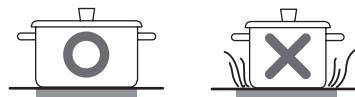

- Using a pressure cooker shortens cooking times by up to 50%.

PARTS AND FEATURES

Parts and Features of the Cooktop

Throughout this manual, features and appearance may vary from your model.

Induction Cooktop

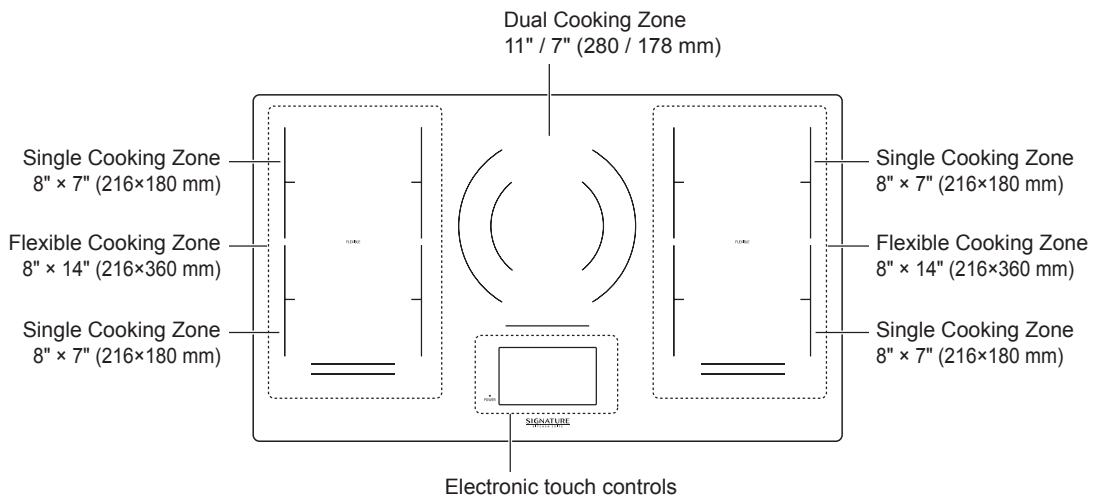

CAUTION

Burn Hazard: The cooking zones may appear cool when turned ON and after they have been turned OFF.

Touch Control Features

Locations of Surface Elements and Controls

The surface burner elements are positioned in the same locations on the cooktop and the control panel for ease of use.

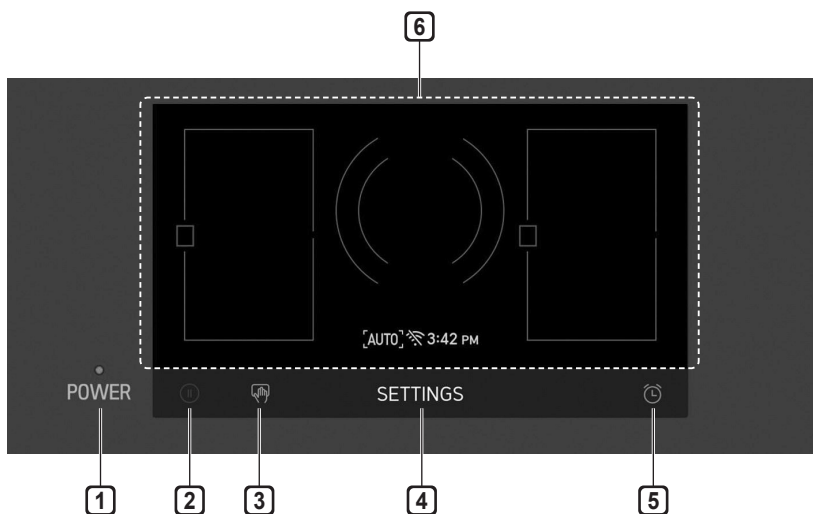

1 Power

Touch and hold for 1 second to turn the entire cooktop ON and OFF. When it is ON, the cooktop is in standby mode until a cooking zone is activated.

2 Hold

Sets the active cooking zone to minimum output. Touch to activate or deactivate.

3 Clean Lock

Touch to lock the touch screen before cleaning it.

4 Settings

5 Timer

6 Cooktop Control

To set the element power level

Select the number on the element power settings for the active cooking zone to adjust the power level from 1 to 9.

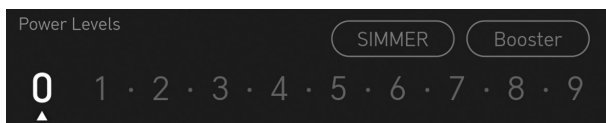

Hot Surface Indicator



This icon appears in the display for each cooking zone when the cooking zone is hot. It will remain on, even after the control is turned off, until the surface has cooled.

OPERATING INSTRUCTIONS

Getting Started

After turning on the cooktop for the first time, adjust the settings to suit your preferences.

- 1 Touch POWER on the LCD display.



- 2 After the startup animation, select the desired language and touch NEXT.
- 3 Set the correct time of day and choose between a 12-hour or 24-hour time format, then touch NEXT.
- 4 Read through the application guide in the display and touch DONE.
- 5 The Main screen appears in the display.

Changing Cooktop Settings

Settings

To adjust settings after the initial setup, touch the display to open the Main screen. Touch Settings at the bottom center of the Main screen.

Swipe the screen or touch the <> arrow keys to navigate through the Settings screens.

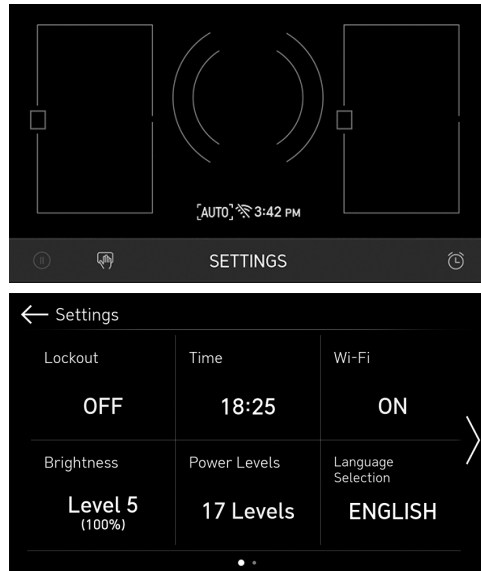

Location of Settings

- Page 1: Lockout, Time, Wi-Fi, Brightness, Power Levels, Language Selection
- Page 2: Volume, Program Update, Automatic Detection, Demo Mode, Factory Data Reset, Open Source License

14 OPERATING INSTRUCTIONS

Lockout

The Lockout feature automatically prevents most cooktop controls from being turned on. It does not disable the clock or timer.

- If Lockout is turned on, all cooktop modules are disabled.

Lock

- 1 Touch Settings at the center bottom of the Main screen.
- 2 Touch Lockout on the first Settings screen.
- 3 When Lockout is turned on, the lock icon  appears at the center bottom of the display.

Unlock

- 1 Touch any part of screen while Lockout is on.
- 2 A popup screen appears. Touch Unlock for 3 seconds.
- 3 The lock icon disappears from the top of the display.

Time

The time is displayed on the LCD display when the cooktop is turned on.

Setting Time of Day

- 1 Touch Settings at the center bottom of the Main screen.
- 2 Touch Time, then set the correct hour and minutes by scrolling. You can also touch the number pad icon  and enter the desired numbers.
- 3 Select either a 12-hour or 24-hour clock mode (12H/24H).
- 4 Touch OK.

Wi-Fi

Connect the appliance to a home Wi-Fi network to use Remote Start and other smart functions. See the Smart Functions section for more details.

Setting Up Wi-Fi

- 1 Touch Settings at the center bottom of the Main screen, then touch Wi-Fi in the first Settings screen.
- 2 Follow the instructions in the Wi-Fi Guide in the display.
- 3 Select ON, OFF, or RESET and touch OK.
- 4 If ON is selected, the Wi-Fi icon  appears at the top of the display.
- 5 If you select RESET, you will have to re-enter the IP address.

Brightness

Adjust the brightness of the LCD display from 20 % to 100 % in increments of 20 %.

Setting Display Brightness

- 1 Touch Settings at the center bottom of the Main screen, and touch Brightness.
- 2 Adjust the display brightness by touching and dragging the dot across the bar, by tapping anywhere on the bar, or by touching + or -.
- 3 Touch OK.

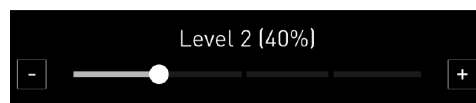

Power Levels

- 1 Touch Settings at the center bottom of the Main screen, and touch Power Levels.
- 2 Choose between 17 levels and 9 levels. (the output of each maximum level is the same)
- 3 Touch OK.

Language Selection

Set the display language to English, Spanish, or French.

Selecting a Language

- 1 Touch Settings at the center bottom of the Main screen, and touch Language Selection.
- 2 Select the desired language.
- 3 Touch OK.

Volume

Adjust the volume of the cooktop controls.

Setting the Volume

- 1 Touch Settings at the center bottom of the Main screen, swipe to the second Settings screen, and touch Volume.
- 2 Select Mute, Low, or High.
- 3 Touch OK.

Program Update

Once the appliance is connected to a home Wi-Fi network, use this setting to check for available programming updates and install them.

- 1 Touch Settings at the center bottom of the Main screen, swipe to the second Settings screen, and touch Program Update.
- 2 The display shows available programming updates. Touch UPDATE to download and install the new version.

Automatic Detection

This function automatically detects the size and location of induction compatible cookware placed on the cooktop. It is turned on by default.

- 1 Touch Settings at the center bottom of the Main screen, swipe to the second Settings screen, and touch Automatic Detection.
- 2 Touch On or Off to activate or deactivate the Automatic Detection function.

Demo Mode

The Demo Mode is for showroom use only. It prevents the cooking zones from heating up.

- 1 Touch Settings at the center bottom of the Main screen, swipe to the second Settings screen, then touch Demo Mode on the Settings screen.
- 2 Select either ON or OFF.
- 3 Touch OK.



NOTE

- When Demo Mode is on, the appliance will not heat up.
- The cooktop Demo Mode icon appears in the display if the Demo Mode is on.

Factory Data Reset

This function returns all settings to the factory defaults.

- 1 Touch Settings at the center bottom of the Main screen, swipe to the second Settings screen, and touch Factory Data Reset.
- 2 If you want to reset data to the factory defaults, touch RESET and then OK.

NOTE

- All stored data will be deleted.

Open Source License

This screen contains open source software licensing information.

- 1 Touch Settings at the center bottom of the Main screen and swipe to the second Settings screen.
- 2 Touch Open Source License.

Before Using the Cooktop

Before using the cooktop for the first time, clean it thoroughly with the included cleaner or ceramic cooktop cleaner according to the Care and Cleaning instructions in this guide. This will help protect the ceramic surface and make future cleanup easier.



CAUTION

Never use abrasive scrubbing pads or cleaners. They can cause permanent damage to the cooktop surface.

Setting the Controls

To operate the touch control pads, touch the pad firmly with the flat part of your fingertip.

First Operation

The first time that power is supplied to the cooktop, the Signature Kitchen Suite logo is displayed for 1 second.

Activating the Cooktop

To turn ON the cooktop, touch the **POWER** key for approximately 1 second. The indicator above the key will light up.

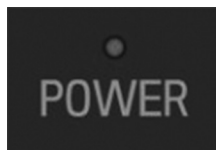

To turn OFF the cooktop, touch the **POWER** key. The indicator light above the key will turn off.

NOTE

After turning on the cooktop with the POWER key, you must select one of the cooking zones within 1 minute. If no selection is made, the cooktop will turn off for safety.

Selecting the Cooking Zone

Place an induction-compatible pan on top of the desired cooking zone.

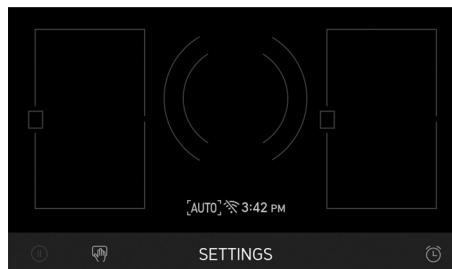

If Automatic Detection is turned on, only the detected cooking zone is activated. If it is turned off, all cooking zones will appear in the display.

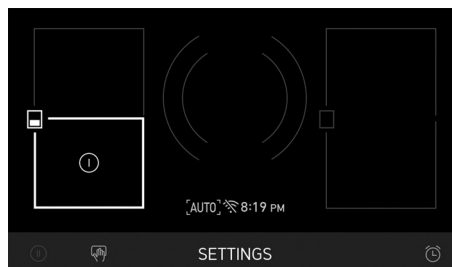

Touch the Power icon in the desired cooking zone to set the power level.

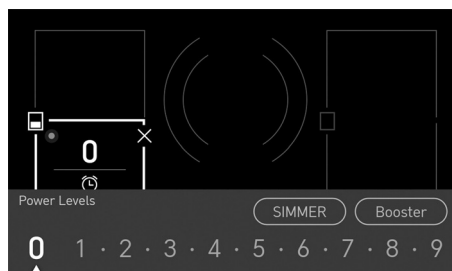

NOTE

Once the cooking zone has been selected the power level must be selected within 3 seconds with the element power settings. Otherwise, the power settings will turn off for safety.

Setting the Power Level

The power level for the selected cooking zone can be set from **1** to **9**.

Selecting the Power Level

- 1 Touch a number in the Power Level popup to set the power level from 1 to 9. If you've set 17 power levels in the Settings menu, touch the dots between the numbers to adjust the power level up or down half a step.

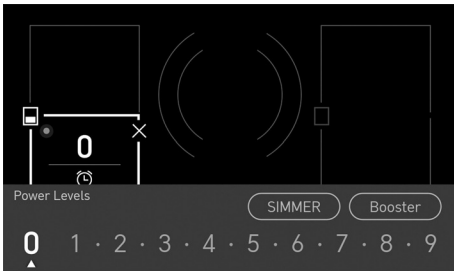

- 2 Selecting a power level turns on the cooking zone. The cooking zone indicator remains lit and the power level is stored.

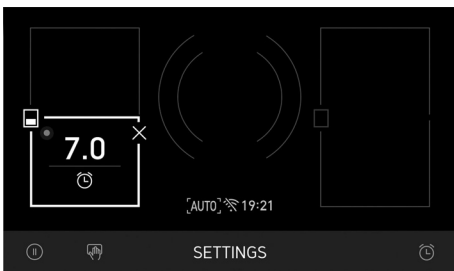

NOTE

If power level is not selected, the power settings will turn off after 3 seconds.

Readjusting the Power Level

- 1 Touch the desired cooking zone to bring up the Power Level popup.

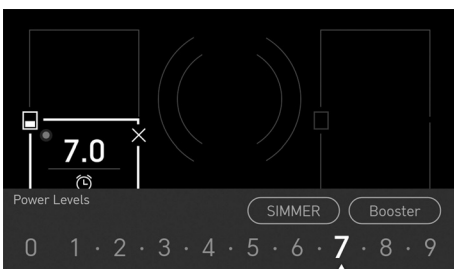

- 2 Touch the desired level in the Power Level popup. If no selection is made, the Power Level popup disappears after 3 seconds and the power level remains the same.

Turning OFF the Cooking Zone

- 1 After the cooking is complete, touch the **x** icon to turn off the cooking zone.



- 2 The corresponding cooking zone display will turn off.

- 3 To turn off all cooking zones, touch the **POWER** key.

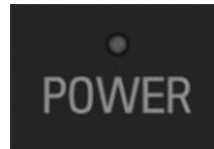

WARNING

Your cooktop has a residual heat indicator for each Cooking Zone. This indicator will warn that this area has been used and is still giving off enough heat to cause burns. Avoid touching the cooking zone when this indicator is shown. Although the cooktop is OFF, the popup message will stay lit until the cooktop has cooled down.

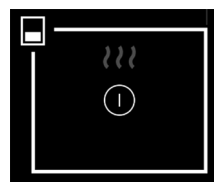

The heating zone is still hot.

Setting	Function	Suggested Use
9	Fast heating	Bringing liquids to a boil.
7-9	Heating, browning, deep fat frying	Browning meats, heating oil for deep-fat frying, sautéing, maintaining a fast boil for large amounts of liquids.
6-7	Roasting, frying	Frying meats, chops, pancakes, sausages, eggs.
4-5	Boiling, general cooking	Cooking larger quantities, soups and stews, steaming potatoes, cooking meat stock or bouillon.
3-4	Steaming	Steaming vegetables, braising meats.
2-3	Simmering	Simmering rice or milk-based dishes, steaming smaller quantities of potatoes and vegetables, heating ready-to-serve meals.
1-2	Melting	Fluffy omelettes, keeping dishes warm, melting butter or chocolate.

NOTE

These settings are recommended guidelines for cooking. You may need to adjust the power level for the type of food and pan.

Using the Cook Modes

SIMMER

Use SIMMER to simmer sauces or stews.

Turning Simmer On

Place the cookware on any cooking zone except for the rear right cooking zone. Activate the Power Level popup and touch the SIMMER key.



MELT

Use MELT to melt items such as chocolate or butter without scorching.

Turning Melt On

Place the cookware on the rear right cooking zone. Activate the Power Level popup and touch the MELT key.

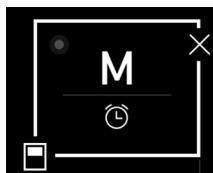

Booster

Use the Booster function to boil water or heat up large quantities of food quickly.

Turning Booser On

Place the cookware on a cooking zone. Activate the Power Level popup and touch the Booster key.

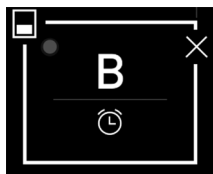

Using the Flex Cooking Zones

Adjoining cooking zones can be combined to create one large cooking zone with the Flex function. This is especially convenient when cooking in Dutch ovens or other large oblong pans.

Activating the Flex Cooking Zone

- 1 Place the cookware over 2 side cooking zones and make sure both cooking zones are activated. The Flex icon will show 2 divided zones.

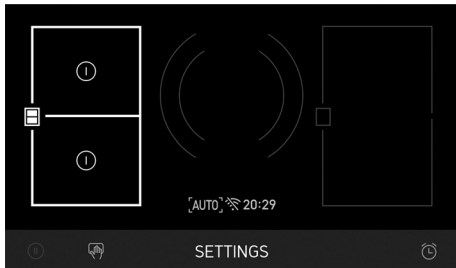

- 2 To merge the 2 cooking zones, touch the Flex icon. The icon will change to show one combined zone.

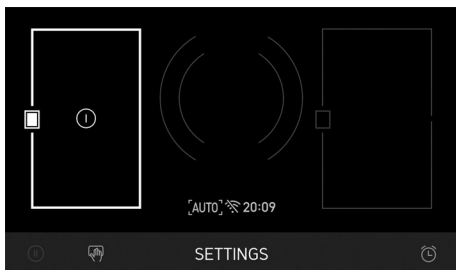

- 3 Select the desired power level.
- 4 Touch the Flex icon again to turn off Flex mode.



Using the Cook Mode Function

The Dual Element, located in the center position, offers two different sized elements to accommodate different pan sizes. Use the smaller inner section or the larger outer section depending on your pan size.



Activating the Dual Cooking Zone

- 1 To activate the larger cooking zone, place a pan that is at least 9" (23 cm) in diameter on the cooking zone.
- 2 Select the desired power level.

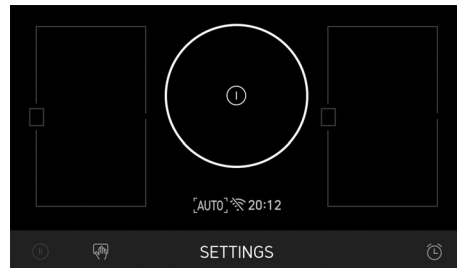

Other Functions

Hold

The Hold function reduces the power level of a cooking zone to level 1 and maintains it at that level until deactivated. This has a similar effect to moving the pan off the burner, without having to move the pan. This is convenient when using large or heavy cookware. When Hold is deactivated, the cooking zone returns to the previous power level.



Clean Lock

Use this function when cleaning the screen area of the cooktop. Touch the Clean Lock icon to lock the controls for 30 seconds. To unlock the controls, wait 30 seconds or touch the Clean Lock icon again.

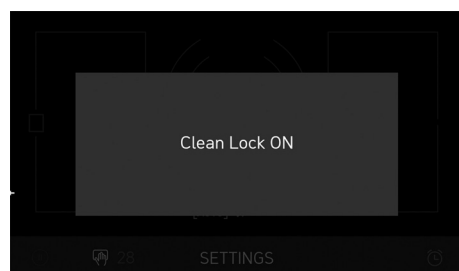
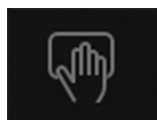

Timer

The Timer acts as a simple kitchen timer and does not turn off the cooking zone.

- If the cooking zone is not in use, touch the Timer icon. Scroll (or use the keypad icon) to set the desired hours, minutes, and seconds, then touch OK.

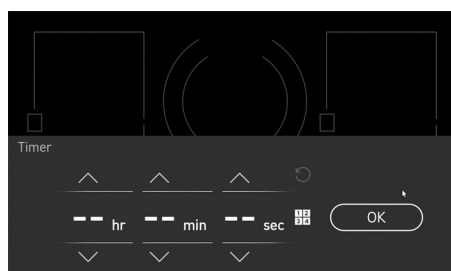
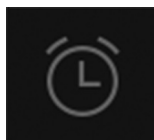

- If the cooking zone is in use, touch the Timer icon on the active cooking zone. Scroll (or use the keypad icon) to set the desired hours, minutes, and seconds, then touch OK.

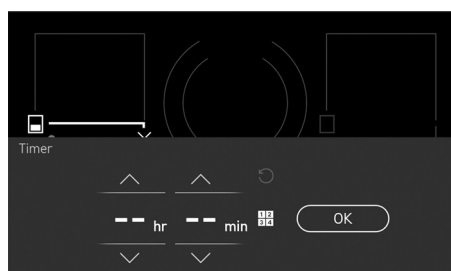

WARNING

The Timer function does not automatically turn off the cooktop or cooking zones. Be sure to touch the Power key to turn the cooktop off after cooking.

Automatic Power Level Control

The power level displayed may be different from the actual power level at the high end of the temperature range. To prevent the cooktop from overheating, the power level is controlled automatically.

SMART FUNCTIONS

SIGNATURE KITCHEN SUITE

Application

The SIGNATURE KITCHEN SUITE application allows you to communicate with the appliance using a smartphone.

Before Using SIGNATURE KITCHEN SUITE

- 1 Use a smartphone to check the strength of the wireless router (Wi-Fi network) near the appliance.
 - If the distance between the appliance and the wireless router is too far, the signal strength becomes weak. It may take a long time to register or installation may fail.
- 2 Turn off the **Mobile data** or **Cellular Data** on your smartphone.
 - For iPhones, turn data off by going to **Settings** → **Cellular** → **Cellular Data**.

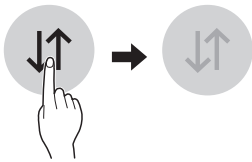

- 3 Connect your smartphone to the wireless router.

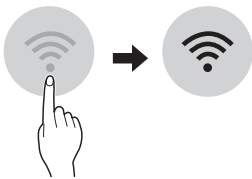

NOTE

- To verify the Wi-Fi connection, check that **Wi-Fi**  icon on the control panel is lit.
- The appliance supports 2.4 GHz Wi-Fi networks only. To check your network frequency, contact your Internet service provider or refer to your wireless router manual.
- SIGNATURE KITCHEN SUITE is not responsible for any network connection problems or any faults, malfunctions, or errors caused by network connection.
- The surrounding wireless environment can make the wireless network service run slowly.
- If the appliance is having trouble connecting to the Wi-Fi network, it may be too far from the router. Purchase a Wi-Fi repeater (range extender) to improve the Wi-Fi signal strength.
- The network connection may not work properly depending on the Internet service provider.
- The Wi-Fi connection may not connect or may be interrupted because of the home network environment.
- If the appliance cannot be registered due to problems with the wireless signal transmission, unplug the appliance and wait about a minute before trying again.
- If the firewall on your wireless router is enabled, disable the firewall or add an exception to it.
- The wireless network name (SSID) should be a combination of English letters and numbers. (Do not use special characters.)
- Smartphone user interface (UI) may vary depending on the mobile operating system (OS) and the manufacturer.
- If the security protocol of the router is set to **WEP**, network setup may fail. Change the security protocol (**WPA2** is recommended), and register the product again.

Installing the SIGNATURE KITCHEN SUITE Application

Search for the SIGNATURE KITCHEN SUITE application from the Google Play Store or Apple App Store on a smart phone. Follow instructions to download and install the application.

SIGNATURE KITCHEN SUITE

Application Features

Monitoring

Use this function to check the current status and operating time from one screen.

Push Alerts

Turn on the Push Alerts to receive appliance status notifications.

The notifications are triggered even if the SIGNATURE KITCHEN SUITE application is off.

Interworking Function

Signature Kitchen Suite hood automatically turn on/off the vent fan and cooktop lamp when paired with the cooktop. Both products must be registered through the Signature Kitchen Suite application and have an interworking function

NOTE

- The appliance is not intended to be operated by means of remote control system.
- To disconnect the appliance from the Wi-Fi network, delete the cooktop from the list of registered products in the Signature Kitchen Suite application.

Open Source Software Notice Information

To obtain the source code under GPL, LGPL, MPL, and other open source licenses, that is contained in this product, please visit <http://opensource.signaturekitchensuite.com>. In addition to the source code, all referred license terms, warranty disclaimers and copyright notices are available for download.

SIGNATURE KITCHEN SUITE will also provide open source code to you on CD-ROM for a charge covering the cost of performing such distribution (such as the cost of media, shipping, and handling) upon email request to opensource@signaturekitchensuite.com. This offer is valid for a period of three years after our last shipment of this product. This offer is valid to anyone in receipt of this information.

Wireless module (LCW-009) Specifications

Frequency Range	2400~2483 MHz
Output Power (max.)	IEEE 802.11 b : 20 dBm
	IEEE 802.11 g : 18 dBm
	IEEE 802.11 n : 17 dBm

FCC Notice (For transmitter module contained in this product)

This equipment has been tested and found to comply with the limits for a Class B digital device, pursuant to Part 15 of the FCC Rules. These limits are designed to provide reasonable protection against harmful interference in a residential installation. This equipment generates, uses, and can radiate radio frequency energy and, if not installed and used in accordance with the instructions, may cause harmful interference to radio communications. However, there is no guarantee that interference will not occur in a particular installation. If this equipment does cause harmful interference to radio or television reception, which can be determined by turning the equipment off and on, the user is encouraged to try to correct the interference by one or more of the following measures:

- Reorient or relocate the receiving antenna.
- Increase the separation between the equipment and the receiver.
- Connect the equipment to an outlet on a circuit different from that to which the receiver is connected.
- Consult the dealer or an experienced radio/TV technician for help.

This device complies with part 15 of the FCC Rules. Operation is subject to the following two conditions:

- 1) this device may not cause harmful interference and
- 2) this device must accept any interference received, including interference that may cause undesired operation of the device.

Any changes or modifications in construction of this device which are not expressly approved by the party responsible for compliance could void the user's authority to operate the equipment.

FCC RF Radiation Exposure Statement

This equipment complies with FCC radiation exposure limits set forth for an uncontrolled environment. This transmitter must not be co-located or operating in conjunction with any other antenna or transmitter.

This equipment should be installed and operated with minimum distance 20 cm (7.8 inches) between the antenna and your body. Users must follow the specific operating instructions for satisfying RF exposure compliance.

CARE AND CLEANING

Cleaning the Cooktop

Normal Daily Use Cleaning

ONLY use Ceramic Cooktop Cleaner on the glass cooktop. Other creams may not be as effective or they might damage the surface with scratches or permanent staining.

To maintain and protect the surface of the glass cooktop, follow these steps:

- 1 Before using the cooktop for the first time, clean it with Ceramic Cooktop Cleaner. This helps protect the top and makes cleanup easier.
- 2 Daily use of Ceramic Cooktop Cleaner will help keep the cooktop looking new.
- 3 Shake the cleaning cream well. Apply a few drops of cleaner directly to the cooktop.
- 4 Use a paper towel to clean the entire cooktop surface.
- 5 Rinse with clear water and use a dry cloth or paper towel to remove all cleaning residue.

NOTE

It is very important that you **DO NOT** heat the cooktop until it has been cleaned thoroughly.



CAUTION

- **DO NOT use scrub pads or abrasive cleaning pads.** They may damage the glass cooktop surface.
- For your safety please wear an oven mitt or pot holder while cleaning the hot cooking surface.

Burned -On Residue

- 1 If spilled food becomes burned on to the glass-ceramic cooking surface, use a suitable metal razor scraper to remove it. Hold the scraper at approximately a 30-degree angle to the surface. The scraper will not damage the cooking surface.

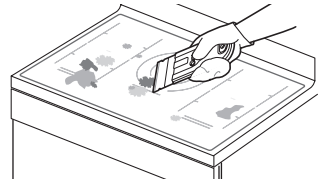

NOTE

- Do not use a dull or nicked blade. For your safety, wear an oven mitt or pot holder while using the metal scraper.

- 2 When the cooking surface has cooled down apply a few dime-sized dabs of an approved cleaner in each burner area. Work the cleaning cream over the cooktop surface with a damp paper towel as if you were cleaning a window.

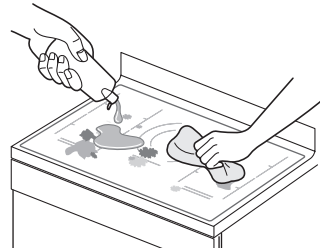

NOTE

Approved Cleaners

- Weiman CookTop Cleaning Cream (www.weiman.com)
- Cerama Bryte (www.ceramabryte.com)
- Easy-Off 3 in 1 Glass Top Cleaner Spray (www.easyoff.us)

24 CARE AND CLEANING

- 3** As a final step, rinse with clear water and wipe the cooktop surface with a clean, dry paper towel.

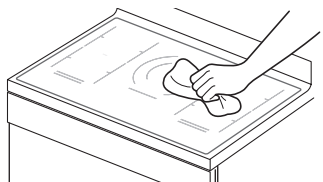

IMPORTANT

If any sugar or food containing sugar (preserves, ketchup, tomato sauce, jellies, fudge, candy, syrups, chocolate, etc.), a plastic item or kitchen foil accidentally melts on the hot surface of the cooktop, remove the molten material **IMMEDIATELY** with a metal razor scraper **while the cooking surface is still hot** to avoid the risk of damage to the glass-ceramic surface. **For your safety wear an oven mitt or pot holder while cleaning the hot cooking surface.**

Metal Marks and Scratches

- Be careful not to slide pots and pans across the cooktop. Doing so will leave metal markings on the cooktop surface. These marks are removable using the Ceramic Cooktop Cleaner with a cleaning pad designed for use with glass-ceramic cooktops.
- If pots with a thin overlay of aluminum or copper are allowed to boil dry, the overlay may leave black discoloration on the cooktop. This should be removed immediately before heating again or the discoloration may be permanent.

INSTALLATION INSTRUCTIONS

Installation and service must be performed by qualified personnel.

IMPORTANT:

Save these instructions for local electrical inspector's use. Read and save these instructions for future reference.

Before You Begin

Read these instructions completely and carefully.

Notes to Installer:

- Read through the entire installation instructions before installing the cooktop.
- Remove all packing material before connecting the electrical supply to the cooktop.
- Observe all governing codes and ordinances.
- Only certain cooktop models may be installed over certain built-in electric oven models.
- Be sure to leave these instructions with the consumer.

Note to Consumer:

Keep the User's Guide and Installation Instructions for future reference.

NOTE

- This appliance must be properly grounded.
- Damage caused by failure to follow these instructions is not covered by the cooktop warranty.

Unpacking the Cooktop

- 1** Unpack and visually inspect the cooktop for any damage or missing components.
- 2** Be sure the bottle of cleaner and conditioner packed in the literature bag is left where the user can find it easily. It is important that the ceramic-glass cooktop be pretreated before use. See **CARE AND CLEANING**.

Technical Specifications

Models		HN951VA	
Description		Induction Cooktop	
Electrical Specifications	Connection voltage	240/208 VAC 60 Hz., 46.3 A / 45.7 A	
	Maximum connected power load	11100 W / 9500 W	
Cooktop Dimensions		36 ⁵ / ₈ " (930 mm) (W) × 4 ¹ / ₄ " (108 mm) (H) × 21 ⁹ / ₁₆ " (547 mm) (D)	
Countertop Cutout Dimensions		Standard Installation - 34 ⁹ / ₁₆ " (878mm) (W) × 4 ¹ / ₄ " (108mm) (H) × 19 ¹¹ / ₁₆ " (500mm) (D) Flush Installation - 36 ³ / ₄ " (934mm) (W) × 4 ¹⁷ / ₃₂ " (115mm) (H) × 21 ¹¹ / ₁₆ " (551mm) (D)	
Cooking Zones	Position	Size	Power
	Front Left	8 ¹ / ₂ " × 7 ³ / ₃₂ " (216×180 mm)	1600/3200 W (208 V) 1800/3700 W (240 V)
	Front Right	8 ¹ / ₂ " × 7 ³ / ₃₂ " (216×180 mm)	1600/3200 W (208 V) 1800/3700 W (240 V)
	Flex Left	8 ¹ / ₂ " × 14 ¹¹ / ₆₄ " (216×360 mm)	2900/3200 W (208 V) 3300/3700 W (240 V)
	Rear Left	8 ¹ / ₂ " × 7 ³ / ₃₂ " (216×180 mm)	1600/3200 W (208 V) 1800/3700 W (240 V)
	Rear Right	8 ¹ / ₂ " × 7 ³ / ₃₂ " (216×180 mm)	1600/3200 W (208 V) 1800/3700 W (240 V)
	Flex Right	8 ¹ / ₂ " × 14 ¹¹ / ₆₄ " (216×360 mm)	2900/3200 W (208 V) 3300/3700 W (240 V)
	Center	11", 7" (280, 178 mm)	Inner Burner : 1600/3200 W (208 V) 1800/3700 W (240 V) Dual Burner : 3100/6100 W (208 V) 3700/7000 W (240 V)

Preparing the Installation Location

Important Installation Information

- All electric cooktops run off a single phase, three-wire or four-wire cable, 240/208 volt, 60 hertz, AC-only electrical supply with ground.
- Minimum distance between cooktop and overhead cabinetry is 30" (762 mm).
- Make sure the cabinets and wall coverings around the cooktop can withstand the temperatures (up to 93°C [200°F]) generated by the cooktop.

1. Standard Installation

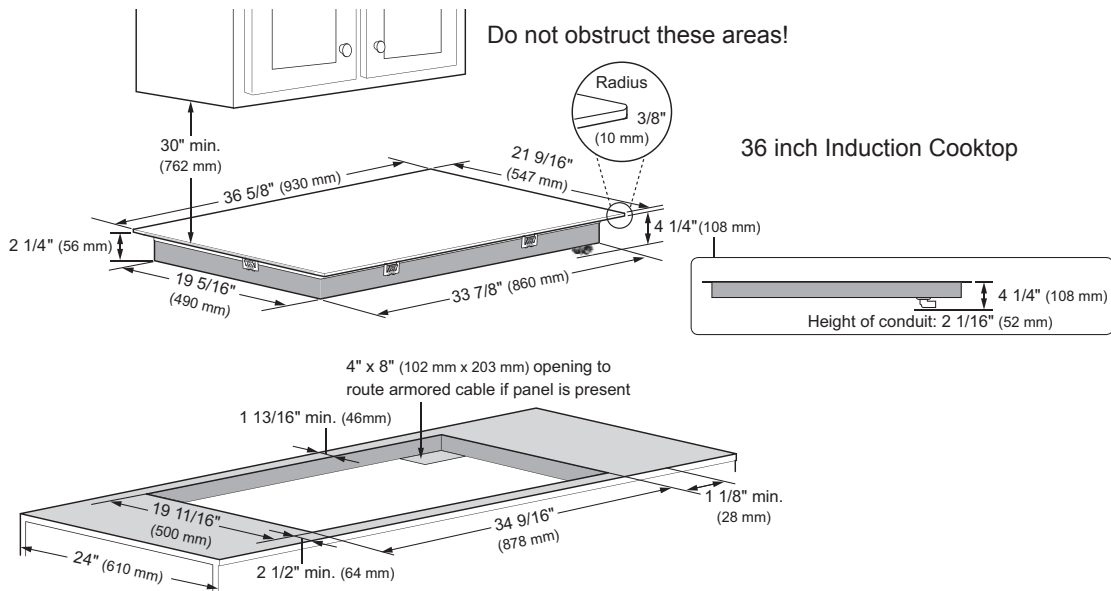

2. Flush Installation

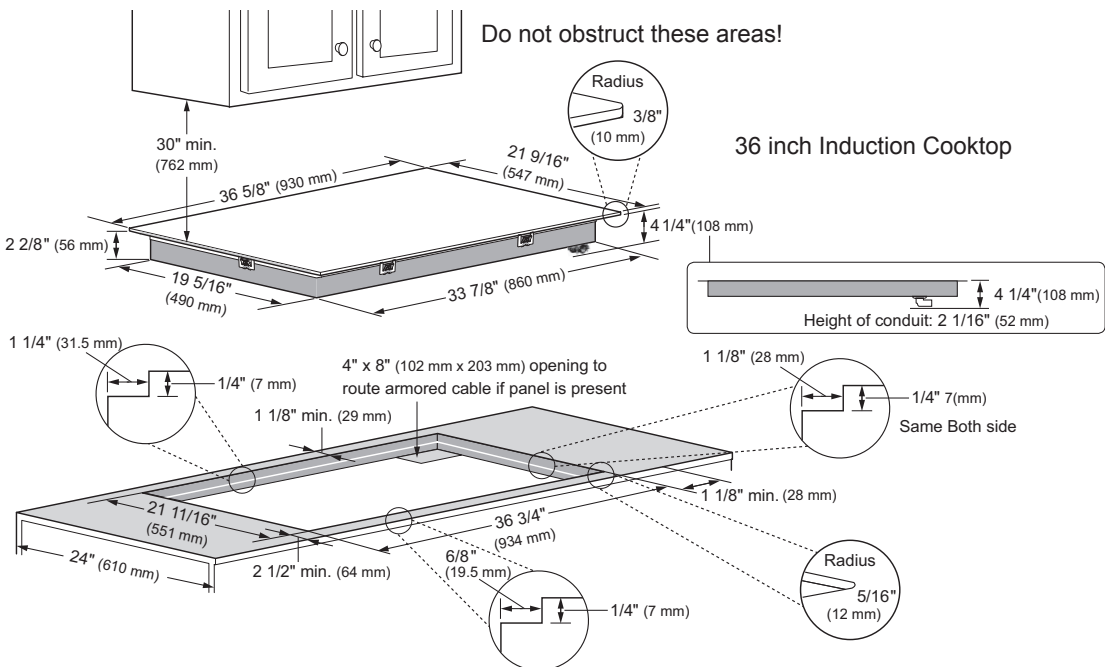

- All dimensions are stated in inches and millimeters (mm).
- Allow 2" (50 mm) space below the armored cable opening to clear the electric cable and allow space for installation of the junction box on the wall at the back of the cooktop.

Dimensions and Clearances

CAUTION

To eliminate the risk of burns or fire by reaching over heated surfaces, cabinet storage space located above the cooktop should be avoided.
 If cabinet storage is provided, risk can be reduced by installing a range hood that projects horizontally a minimum of 5" (127 mm) beyond the face of the cabinets.

Overhead cabinet should not exceed a maximum depth of 13" (330 mm).

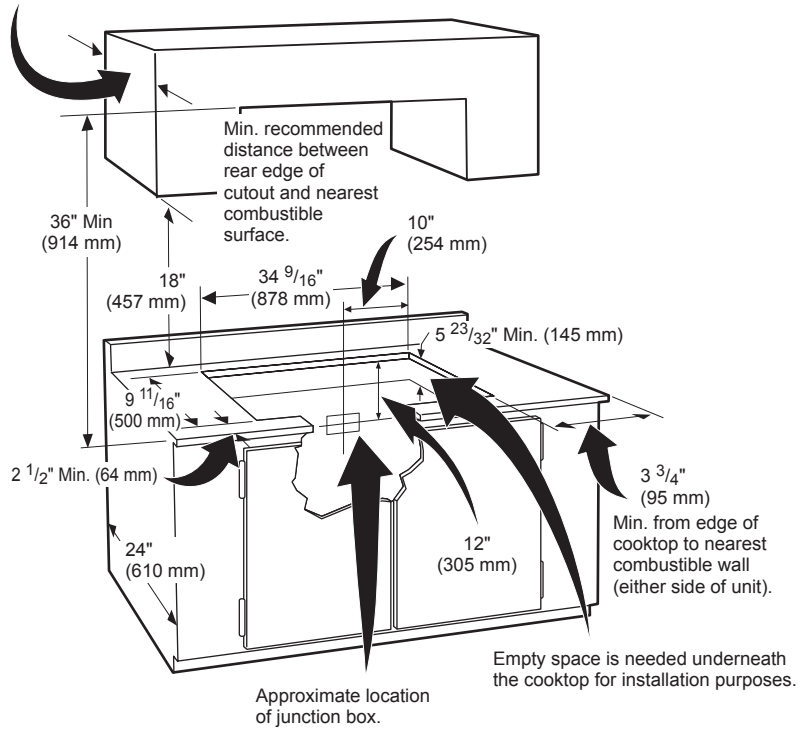

Recommended Spacing between Cooktop and Oven

CAUTION

It is very important to keep 2 3/4" (70 mm) distance between the cooktop and the oven.

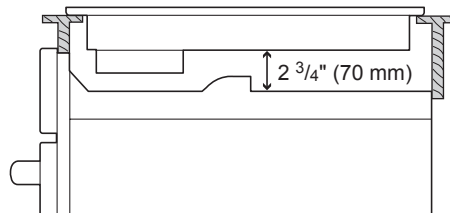

Electrical Connections

Important Safety Instructions

- Be sure the cooktop is installed and grounded properly by a qualified installer or service technician.
- This cooktop must be electrically grounded in accordance with local codes or, in their absence, with the National Electrical Code ANSI/NFPA No. 70, latest edition in the United States.

WARNING

The electrical power to the cooktop must be shut off while line connections are being made. Failure to do so could result in serious injury or death.

Providing the Electrical Connection

Install the junction box under the cabinet and run 120/240 or 120/208 Volt, AC wire from the main circuit panel.

NOTE

DO NOT connect the wire to the circuit panel at this time.

Electrical Requirements

Observe all governing codes and local ordinances.

- 1 A 3-wire or 4-wire single-phase 120/240 or 120/208 Volt, 60 Hz AC-only electrical supply is required on a separate circuit fused on both sides of the line (time-delay fuse or circuit breaker is recommended). DO NOT fuse neutral. The fuse size must not exceed the circuit rating of the appliance specified on the nameplate.
- 2 36" Induction cooktop can consume up to 10,500W at 240 VAC. A 50 Amp circuit breaker with wire gauge #8 AWG must be used.

NOTE

Wire sizes and connections must conform with the fuse size and rating of the appliance in accordance with the National Electrical Code ANSI/NFPA No. 70, latest edition, and local codes and ordinances.

WARNING

Do not use an extension cord with this appliance. Such use may result in a fire, electrical shock, or other personal injury.

- 3 The appliance should be connected to the fused disconnect (or circuit breaker) box through flexible armored or nonmetallic sheathed cable. The flexible armored cable extending from this appliance should be connected directly to the grounded junction box. The junction box should be located as shown on page 28 with as much slack as possible remaining in the cable between the box and the appliance, so it can be moved if servicing is ever necessary.
- 4 A suitable strain relief must be provided to attach the flexible armored cable to the junction box.

Electrical Connection

Connect the flexible armored cable that extends from the surface unit to the junction box using a suitable strain relief at the point the armored cable enters the junction box. Then make the electrical connection as follows.

Electrical ground is required on this appliance.

This appliance is manufactured with a supply wire and a frame-connected green or bare copper grounding wire.

NOTE TO ELECTRICIAN

The armored cable leads supplied with the appliance are UL-listed for connection to larger gauge household wiring. The insulation of the leads is rated at temperatures much higher than the temperature rating of household wiring. The current-carrying capacity of the conductor wire is governed by the temperature rating of the insulation around the wire, rather than the wire gauge alone.

WARNING

- **DO NOT** ground to a gas supply pipe. DO NOT connect to electrical power supply until appliance is permanently grounded. Connect the ground wire before turning on the power.
- This appliance is equipped with a copper conductor flexible cable. If connection is made to aluminum house wiring, use only special connectors which are approved for joining copper and aluminum wires in accordance with the National Electrical Code and local codes and ordinances. Improper connection of aluminum house wiring to copper leads can result in a short circuit or fire. Follow the connector manufacturer's recommended procedure closely.

Where Local Codes Permit Connecting the Appliance-Grounding Conductor to the Neutral (White) Wire

Observe all governing codes and local ordinances.

- 1 Disconnect the power supply.
- 2 At the circuit breaker box, fuse box or junction box, connect appliance and power supply cable wires as shown.

⚠ WARNING

You may not ground the cooktop through the neutral (white) wire if cooktop is used in a new branch circuit installation (1996 NEC), mobile home, recreational vehicle, or where local codes do not permit grounding to the neutral (white) wire. When grounding to the neutral (white) wire is prohibited, you must use a 4-wire power supply cable. Failure to heed this warning may result in electrocution or other serious personal injury.

If Cooktop is Used in a New Branch Circuit Installation (1996 NEC), Mobile Home, Recreational Vehicle, or where Local Codes Do Not Permit Grounding to the Neutral (White) Wire

Observe all governing codes and local ordinances.

- 1 Disconnect the power supply.
- 2 At the circuit breaker box, fuse box or junction box, connect appliance and power supply cable wires as shown.

⚠ WARNING

If connecting to a 4-wire power supply cable electrical system, the appliance frame connected ground wire **MUST NOT** be connected to the neutral wire of the 4-wire electrical system.

3-Wire Grounded Junction Box

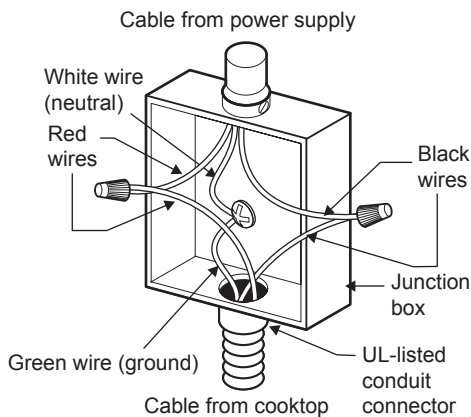

4-Wire Grounded Junction Box

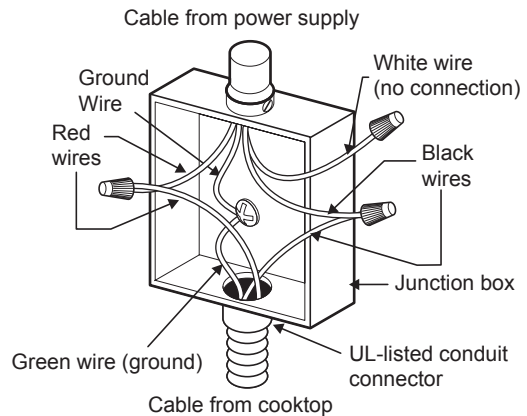

Cooktop Installation

- 1 Visually inspect the cooktop for damage. Make sure all cooktop screws are tight (see below for locations).

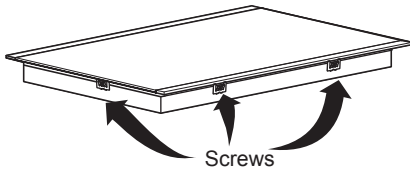

- 2 Carefully lower the cooktop into the counter-top cutout, making sure not to trap any wires.

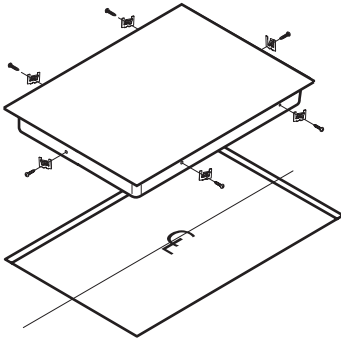

NOTE

Do not use caulking compound. The cooktop must be removable, should service be required.

- 3 Install the retainer brackets to the bottom of the cooktop; then snug the bolts against the bottom of the countertop as shown.

NOTE

The retainer brackets **MUST** be installed to meet local codes or, in their absence, with the National Electrical Code ANSI/NFPA No. 70, latest edition.

Preferred installation

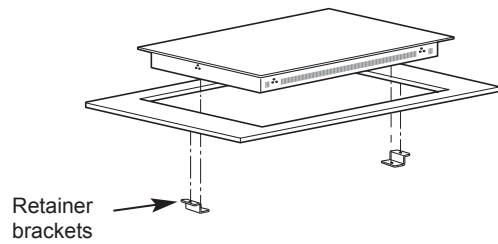

Alternative installation

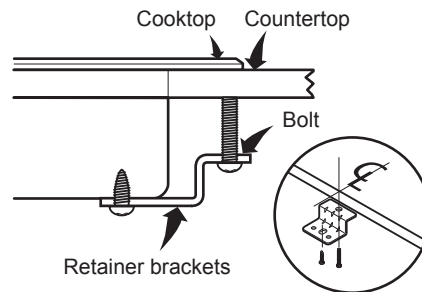
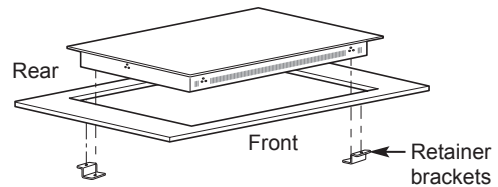

Final Check

Perform a final operational check of the cooktop, making sure the cooktop powers on properly and that each cooking zone operates correctly.

Refer to the Operating Instructions in this guide for details.

Model and Serial Number Location

The model and serial numbers are located on a plate on the bottom of the cooktop. Please record them in this guide; you will need them for warranty registration.

CAUTION

Do not touch cooktop glass or cooking zones. They may be hot enough to cause burns.

TROUBLESHOOTING

Before Calling for Service

Before you call for service, review this list. It may save you time and expense. This list includes common occurrences that are not the result of a defect in workmanship or materials.

Symptoms	Possible Cause / Solutions
Cooktop does not work	<ul style="list-style-type: none"> • Cooktop controls are locked. <ul style="list-style-type: none"> - See USING LOCK OUT to turn off the LOCK OUT feature. • Circuit breaker has tripped or fuse is blown. <ul style="list-style-type: none"> - Reset the circuit breaker. • Power outage. <ul style="list-style-type: none"> - Check house lights to confirm power outage. • Installation wiring not complete. <ul style="list-style-type: none"> - Contact the installer or dealer.
Cooktop does not heat	<ul style="list-style-type: none"> • Incorrect cooking zone selected. <ul style="list-style-type: none"> - Make sure the correct control is ON for the cooking zone being used. • No power to cooktop. <ul style="list-style-type: none"> - See “Cooktop does not work” above.
Element turns off while cooking.	<ul style="list-style-type: none"> • Cooktop inner temperature too High. <ul style="list-style-type: none"> - Check that cooktop has been installed according to the installation instructions.
Elements do not get hot enough.	<ul style="list-style-type: none"> • Touch controls may not be set properly. <ul style="list-style-type: none"> - Check the power level. • Cookware may not be flat or the correct shape or size. <ul style="list-style-type: none"> - Use the recommended cookware. See pages 9-10.
A fan sound can be heard.	<ul style="list-style-type: none"> • Cooktop inner temperature is High. <ul style="list-style-type: none"> - This is normal. The cooling fan will run when any element is turned on. With heavy use the fan may continue to run after the controls are turned off until the cooktop has cooled.

WARRANTY (USA)

SIGNATURE KITCHEN SUITE will repair or replace the product, at SIGNATURE KITCHEN SUITE option, if it proves to be defective in material or workmanship under normal use, during the warranty period set forth below, effective from the date of original consumer purchase of the product. This limited warranty is good only to the original purchaser of the product and effective only when used in U.S.A.

WARRANTY PERIOD	WHAT IS COVERED
Three years from date of original purchase	Any part of the cooktop which fails due to a defect in materials or workmanship. During this full Three-years warranty , SIGNATURE KITCHEN SUITE will also provide, free of charge , all labor and in-home service to replace the defective part.

Please retain dealer's dated bill of sale as evidence of the Date of Purchase for proof of warranty, and submit a copy of the bill of sale to the service person at the time warranty service is provided.

Please call **1-855-790-6655** and choose the appropriate option to locate your nearest SIGNATURE KITCHEN SUITE Authorized Service Center. Or visit our Web site at www.signaturekitchensuite.com

THIS WARRANTY IS IN LIEU OF ANY OTHER WARRANTIES, EXPRESS OR IMPLIED, INCLUDING WITHOUT LIMITATION, ANY WARRANTY OF MERCHANTABILITY OR FITNESS FOR A PARTICULAR PURPOSE. TO THE EXTENT ANY IMPLIED WARRANTY IS REQUIRED BY LAW, IT IS LIMITED IN DURATION TO THE EXPRESS WARRANTY PERIOD ABOVE. SIGNATURE KITCHEN SUITE WILL NOT BE LIABLE FOR ANY CONSEQUENTIAL, INDIRECT, OR INCIDENTAL DAMAGES OF ANY KIND, INCLUDING LOST REVENUES OR PROFITS, IN CONNECTION WITH THE PRODUCT. SOME STATES DO NOT ALLOW LIMITATION ON HOW LONG AN IMPLIED WARRANTY LASTS OR THE EXCLUSION OF INCIDENTAL OR CONSEQUENTIAL DAMAGES, SO THE ABOVE LIMITATIONS OR EXCLUSIONS MAY NOT APPLY TO YOU.

THIS LIMITED WARRANTY DOES NOT APPLY TO:

- Service calls to correct the installation of the appliance, to instruct in use of the appliance, to replace house fuses or correct house wiring, or to replace owner-accessible light bulbs.
- Repairs when the appliance is used in other than normal, single-family household use.
- Pickup and delivery. The appliance is designed to be repairable in the home.
- Damage resulting from accident, alteration, misuse, abuse, fire, flood, improper installation, acts of God, or use of products not approved by SIGNATURE KITCHEN SUITE Corporation.
- Repairs to parts or systems resulting from unauthorized modifications made to the appliance.
- Replacement parts or repair labor costs for units operated outside the United States.
- Any labor costs during the limited warranty period.

This warranty is extended to the original purchaser and for products purchased for home use within the USA. In Alaska, the warranty excludes the cost of shipping or service calls to your home. Some states do not allow the exclusion or limitation of incidental or consequential damages, so this exclusion or limitation may not apply to you. This warranty gives you specific legal rights, and you may also have other rights which vary from state to state. To know what your legal rights are, consult your local or state consumer affairs or your states Attorney General.

MEMO



Customer Information Center

For inquiries or comments, call:

1-855-790-6655 USA