

Warning



WARNING:

TO REDUCE THE RISK OF ELECTRIC SHOCK DO NOT REMOVE COVER (OR BACK). NO USER SERVICEABLE PARTS INSIDE. REFER TO QUALIFIED SERVICE PERSONNEL.



The lightning flash with arrowhead symbol, within an equilateral triangle, is intended to alert the user to the presence of uninsulated "dangerous voltage" within the product's enclosure that may be of sufficient magnitude to constitute a risk of electric shock to persons.



The exclamation point within an equilateral triangle is intended to alert the user to the presence of important operating and maintenance (servicing) instructions in the literature accompanying the appliance.

WARNING:

TO PREVENT FIRE OR SHOCK HAZARDS, DO NOT EXPOSE THIS PRODUCT TO RAIN OR MOISTURE.

NOTE TO CABLE/TV INSTALLER:

This reminder is provided to call the CATV system installer's attention to Article 820-40 of the National Electric Code (U.S.A.). The code provides guidelines for proper grounding and, in particular, specifies that the cable ground shall be connected to the grounding system of the building, as close to the point of the cable entry as practical.

REGULATORY INFORMATION

This equipment has been tested and found to comply with the limits for a Class B digital device, pursuant to Part 15 of the FCC Rules. These limits are designed to provide reasonable protection against harmful interference in a residential installation. This equipment generates, uses and can radiate radio frequency energy and, if not installed and used in accordance with the instructions, may cause harmful interference to radio communications. However, there is no guarantee that interference will not occur in a particular installation. If this equipment does cause harmful interference to radio or television reception, which can be determined by turning the equipment off and on, the user is encouraged to try to correct the interference by one or more of the following measures:

- Reorient or relocate the receiving antenna.
- Increase the separation between the equipment and receiver.
- Connect the equipment into an outlet on a circuit different from that to which the receiver is connected.
- Consult the dealer or an experienced radio/TV technician for help.

Any changes or modifications not expressly approved by the party responsible for compliance could void the user's authority to operate the equipment.

CAUTION:

Do not attempt to modify this product in any way without written authorization.
Unauthorized modification could void the user's authority to operate this product.

Safety Instructions

* Safety instructions have two kinds of information, and each meaning of it is as below.

 **WARNING** The violation of this instruction may cause serious injuries and even death.

 **NOTES** The violation of this instruction may cause light injuries or damage of the product.

 Take care of danger that may happen under specific condition.

WARNING

1. **Do not place the product in direct sunlight or near heat sources such as heat registers, stove and so on.**

This may cause a fire.

2. **Do not use the product in damp place such as a bathroom or any place where it is likely to get wet.**

This may cause a fire or could give an electric shock.

3. **Bend antenna cable between inside and outside building to prevent rain from flowing in.**

This may cause water damaged inside the product and could give an electric shock.

4. **Earth wire should be connected.**

- If the earth wire is not connected, there is possible a danger of electric shock caused by the current leakage.
- If grounding methods are not possible, a separate circuit breaker should be employed and installed by a qualified electrician.
- Do not connect ground to telephone wires, lightning rods or gas pipe.

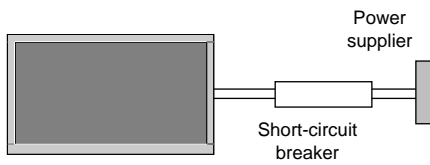

5. **Do not placing anything containing liquid on top of the product.**

This may cause a fire or could give an electric shock.

6. **Do not insert any object into the exhaust vent.**

This may cause a fire or could give an electric shock.

7. **Do not place heavy objects on the product.**

This may cause serious injury to a child or adult.

8. **Do not use water the product while cleaning.**

This may cause damaged the product or could give an electric shock.

9. **In case of smoke or strange smell from the product, switch it off ,unplug it from the wall outlet and contact your dealer or service center.**

This may cause a fire or could give an electric shock.

10. **Do not attempt to service the product yourself. Contact your dealer or service center.**

This may cause damaged the product or could give an electric shock.

11. **During a lightning thunder, unplug the product from the wall outlet and don't touch an antenna cable.**

This may cause damaged the product or could give an electric shock.

NOTE

- 1. Never touch the power plug with a wet hand.**

This may cause an electric shock.

- 2. Disconnect from the mains and remove all connections before moving.**

- 3. Do not place the product in a built-in installation such as a bookcase or rack.**

Ventilation required.

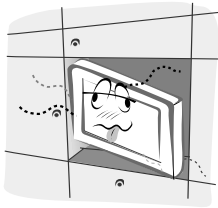

- 4. When installing the product on a table, be careful not to place the edge of its stand.**

This may cause the product to fall, causing serious injury to a child or adult, and serious damage to the product.



- 5. Do not place an outside antenna in the vicinity of overhead power lines or other electric light or power circuits.**

This may cause an electric shock.

- 6. There should be enough distance between an outside antenna and power lines to keep the former from touching the latter even when the antenna falls.**

This may cause an electric shock.

- 7. Do not pull the cord but the plug when unplugging.**

This may cause a fire.

- 8. Ensure the power cord doesn't trail across any hot objects like a heater.**

This may cause a fire or an electric shock.

- 9. Do not plug when the power cord or the plug is damaged or the connecting part of the power outlet is loose.**

This may cause a fire or an electric shock.

- 10. Dispose of used batteries carefully to protect a child from eating them.**

In case that it eats them, take it to see a doctor immediately.

- 11. When moving the product assembled with speakers do not carry holding the speakers.**

This may cause the product to fall, causing serious injury to a child or adult, and serious damage to the product.

- 12. Unplug this product from the wall outlet before cleaning. Do not use liquid cleaners or aerosol cleaners.**

This may cause damaged the product or could give an electric shock.

- 13. Contact the service center once a year to clean the internal part of the product.**

Accumulated dust can cause mechanical failure.

- 14. The distance between eyes and the screen should be about 5 ~ 7 times as long as diagonal length of the screen.**

If not, eyes will strain.

- 15. Unplug the product from the wall outlet when it is left unattended and unused for long periods of time.**

Accumulated dust may cause a fire or an electric shock from deterioration or electric leakage.

- 16. Only use the specified batteries.**

This make cause damaged the product or could give an electric shock.

Contents

Safety Instructions	2-3
Introduction	
Controls	6
Connection Options	7
Remote Control Key Functions	8
Installation	
Installation Instruction	9
External Equipment Connections	10-14
Antenna Connection	10
VCR Setup / Cable TV Setup	11
External A/V Source Setup	12
DVD Setup	12
DTV Setup / Monitor Out Setup	13
PC Setup	14
Operation	
Turning the TV On	15
On-screen Menus Language Selection	15
Channel Menu Options	
Auto Program: Channel Search	16
Manual Program: Adding/Deleting Channels	16
Fine Tuning Adjustment	16
Signal Reception Booster	17
Favorite Channel Memory	17
Picture Menu Options	
APC (Auto Picture Control)	18
XD	18
Color Temperature Control	18
Fleshtone	19
sRGB	19
Manual Picture Control(User option)	19
Sound Menu Options	
DASP (Digital Auto Sound Processing)	20
BBE	20
AVL (Auto Volume Leveler)	20
Manual Sound Control (User option)	21
Stereo/SAP Broadcasts Setup	21
Timer Menu Options	
Clock Setup	22
On/Off Timer Setup	22
Auto Off / Sleep Timer	23
Special Menu Features	
Key Lock	23
ISM (Image Sticking Minimization) Method	23
Low Power	24
XD Demo	24
Closed Captions	25
Captions	25
Caption/Text	25
Screen Menu Features	
Auto Adjustment	26
Setting Picture Format	26
Screen Position	26
Manual Configure	27
Screen VGA Mode	27
Screen Adjustments	27
Cinema Mode Setup	27
Luminance Noise Reduction	28
Initializing (Reset to original factory value)	28
Split Zoom	28
PIP (Picture-In-Picture)/Double Window Feature	
Watching PIP/Double Window	29
Swapping the PIP/Double Window	29
TV Program selection for PIP	29
Selecting an Input Signal Source for PIP/Double Window	29
Moving the PIP sub picture	29
PIP Size	29
PIP Transparency (PIP Mode only)	29
External Control Device Setup	30-35
IR Codes	36-37
Troubleshooting Checklist	38
Product Specifications	39

After reading this manual, keep it handy for future reference.

Introduction

What is a Plasma Display Panel (PDP)?

A plasma display panel is the latest display technology and the best way to achieve flat panel displays with excellent image quality and large screen sizes that are easily viewable. The PDP can be thought of as a descendant of the neon lamp and it can be also be viewed as a series of fluorescent lamps.

How does it work?

PDP is an array of cells, known as pixels, which are comprised of 3 sub pixels, corresponding to the colors red, green, and blue. Gas in a plasma state is used to react with phosphors in each sub-pixel to produce colored light (red, green, or blue). These phosphors are the same types used in Cathode Ray Tube (CRT) devices such as televisions and common computer monitors.

You get the rich, dynamic colors that you expect. Each sub-pixel is individually controlled by advanced electronics to produce over 16 million different colors. All of this means that you get perfect images that are easily viewable in a display that is less than 5 inches thick.

160° - Wide angle range of vision

Your flat panel plasma screen offers an exceptionally broad viewing angle -- over 160 degrees. This means that the display is clear and visible to viewers anywhere in the room who can see the screen.

Wide Screen

The screen of the Plasma Display is so wide that your viewing experience is as if you are in a theater.

Multimedia

Connect your plasma display to a PC and you can use it for conferencing, games, and Internet browsing. The Picture-in-Picture feature allows you to view your PC and video images simultaneously.

Versatile

The light weight and thin size makes it easy to install your plasma display in a variety of locations where conventional TVs will not fit.

The PDP Manufacturing Process: a few minute colored dots may be present on the PDP screen

The PDP (Plasma Display Panel), which is the display device of this product is composed of 0.9 to 2.2 million cells. A few cell defects will normally occur in the PDP manufacturing process. Several tiny, minute colored dots visible on the screen should be acceptable. This also occurs in other PDP manufacturers' products. The tiny dots appearing does not mean that this PDP is defective. Thus a few cell defects are not sufficient cause for the PDP to be exchanged or returned. Our production technology minimizes these cell defects during the manufacture and operation of this product.

Cooling Fan Noise

In the same way that a fan is used in a PC computer to keep the CPU (Central Processing Unit) cool, the PDP is equipped with cooling fans to cool the Monitor and improve its reliability. Therefore, a certain level of noise could occur while the fans are operating and cooling the PDP.

The fan noise doesn't have any negative effect on the PDP's efficiency or reliability. The noise from these fans is normal during the operation of this product. We hope you understand that a certain level of noise from the cooling fans is acceptable and is not sufficient cause for the PDP to be exchanged or returned.

Controls

- This is a simplified representation of front panel.
- Here shown may be somewhat different from your TV.
- This manual explains the features available on the RP-42PX10 TVs.

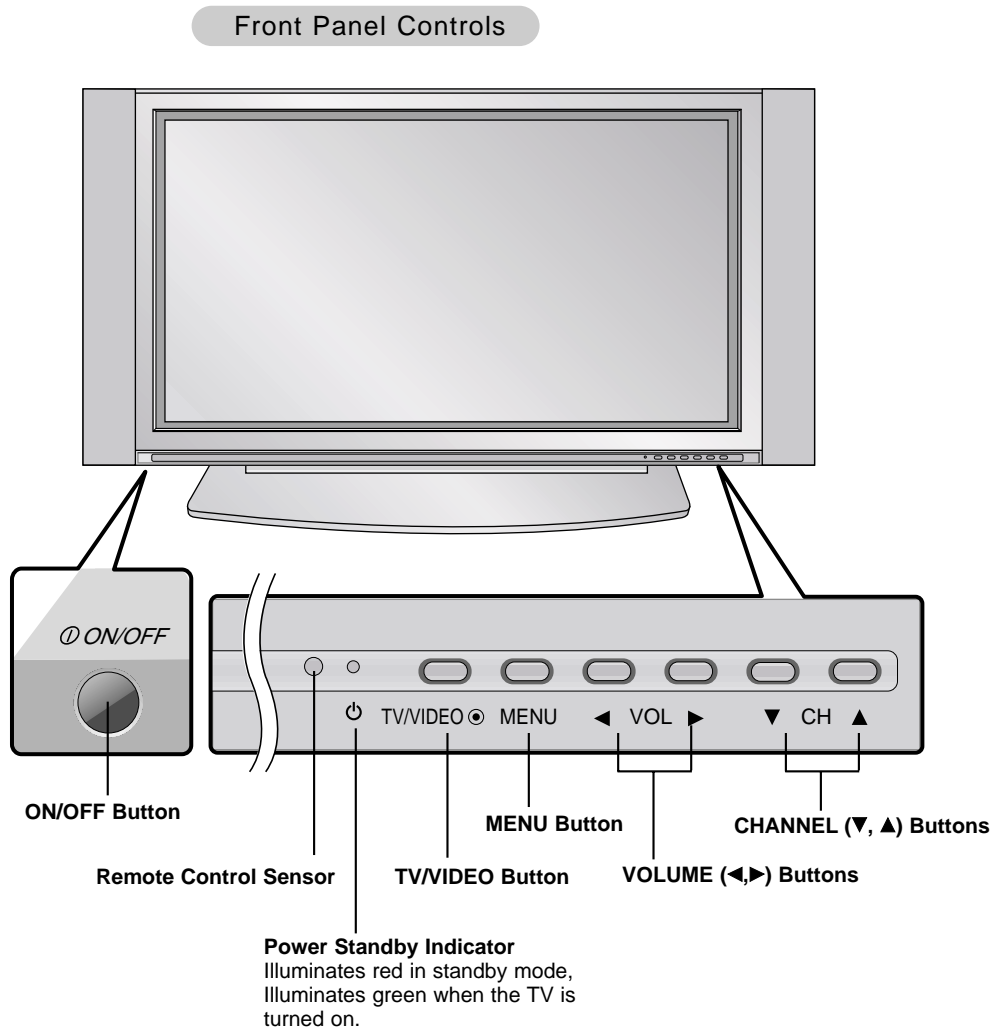

Connection Options

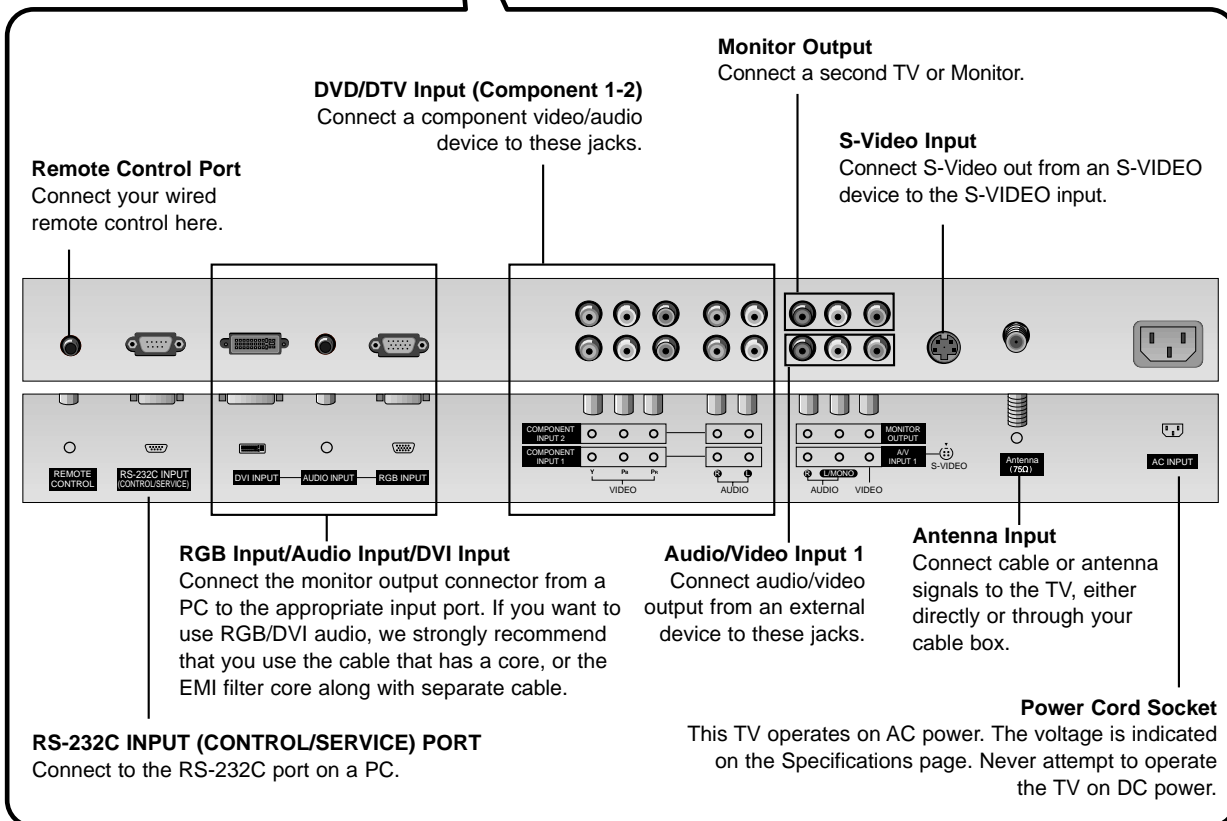
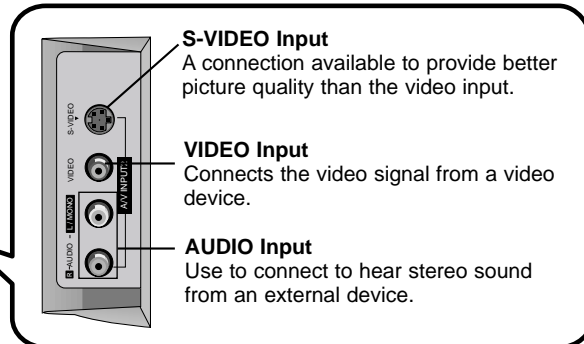
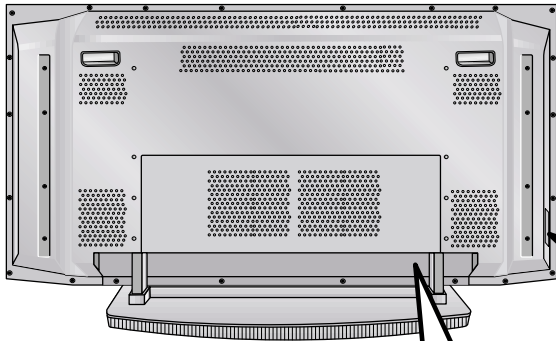

Remote Control Key Functions

- When using the remote control, aim it at the remote control sensor on the TV.

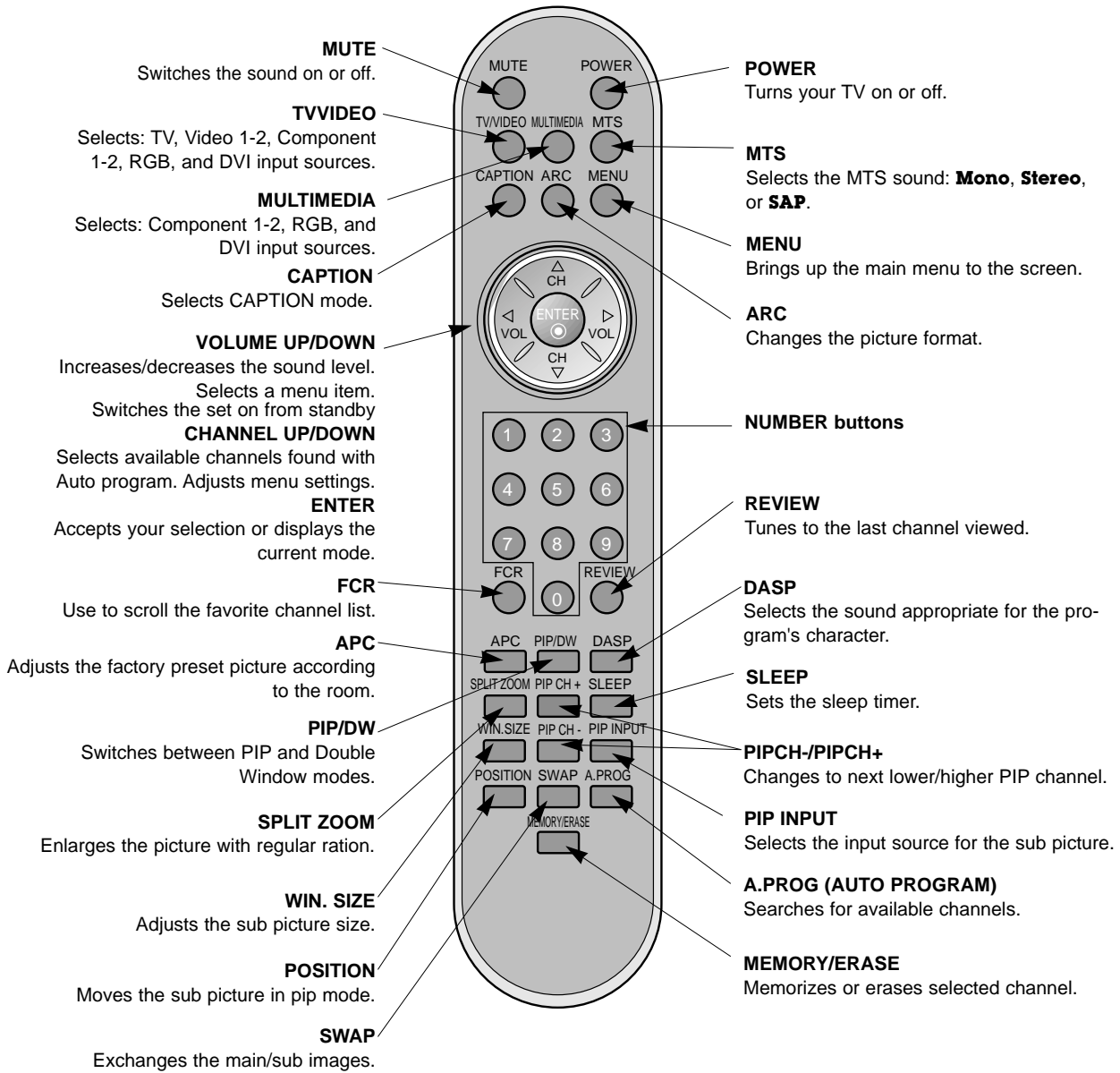

Installing Batteries

- Open the battery compartment cover on the back side and install the batteries matching correct polarity (+ with +, - with -).
- Install two 1.5V AAA batteries. Don't mix old or used batteries with new ones. Replace cover.

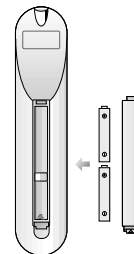

Installation

Installation Instructions

- The TV can be installed in various ways such as on a wall, or on a desktop etc.
- The TV is designed to be mounted horizontally. The speakers shown are optional.
- It is recommended that RP-42PX10 model only be used at an altitude of less than 3281 feet (1000m) to get the best quality picture and sound.
- It is recommended that RP-42PX10H model only be used at an altitude of less than 6561 feet (2000m) to get the best quality picture and sound.

GROUNDING

Ensure that you connect the grounding / earth wire to prevent possible electric shock. If grounding methods are not possible, have a qualified electrician install a separate circuit breaker. Do not try to ground the unit by connecting it to telephone wires, lightening rods, or gas pipes.

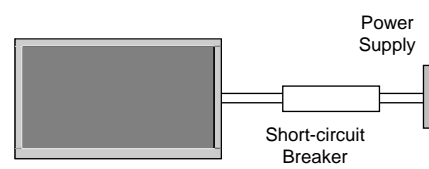

Ensure that the following accessories are included with your plasma display. If an accessory is missing, please contact the dealer where you purchased the product.

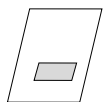

Owner's Manual

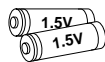

Batteries



Remote Control



2-TV bracket bolts



Power Cord

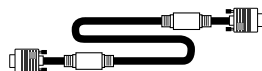

D-sub 15 pin cable



DVI Cable

2-TV brackets
2-Wall brackets

Option Extras

- Optional extras can be changed or modified for quality improvement without any notification new optional extras can be added.
- Contract your dealer for buying these items.

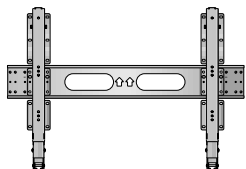

Tilt wall mounting bracket

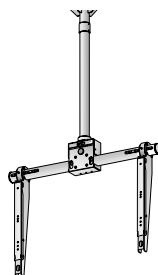

Ceiling mounting bracket



Video cables



Audio cables

Attaching the TV assembly to the wall

- Secure the TV assembly by attaching it to a wall for additional support.

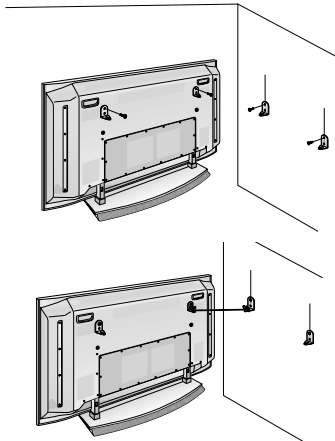

- Install the TV brackets on the TV as shown. Insert the 2 bolts and tighten securely, in the upper holes on the bracket. Install the wall brackets on the wall with 4 bolts*, (not supplied with the product), as shown. Match the height of the TV brackets and the wall brackets. Check to be sure the brackets are tightened securely.

- Secure the TV assembly to the wall with strong strings or wound wire cables, (not supplied with the product), as shown.

External Equipment Connections

Antenna Connection

- Antenna or Cable Service without a Cable Box Connections
- For optimum picture quality, adjust antenna direction if needed.

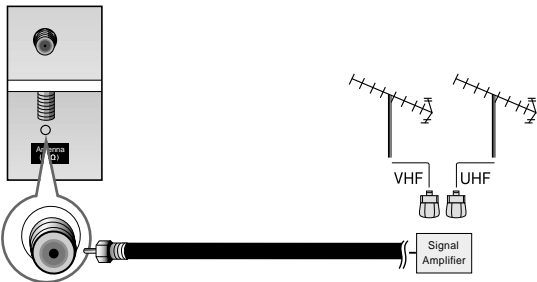
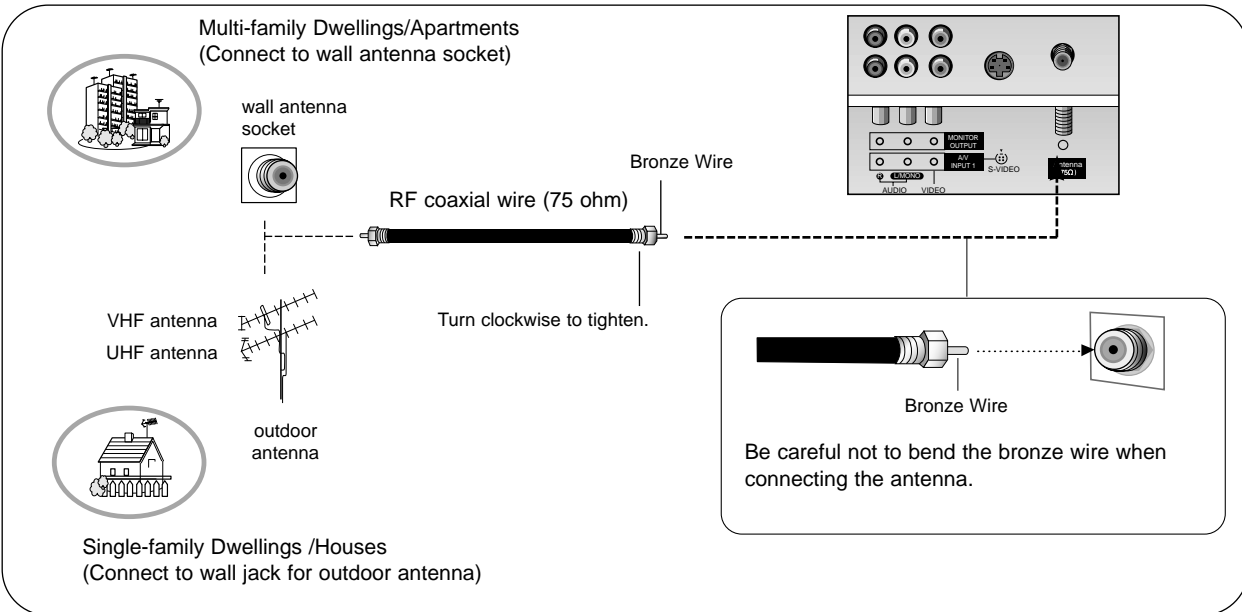

- In a poor signal area to improve picture quality, purchase and install a signal amplifier.
- If the antenna needs to be split for two TV's, install a "2-Way Signal Splitter" in the connections.
- If the antenna is not installed properly, contact your dealer for assistance.

NOTE: All cables shown are not included with the TV

VCR Setup

- To avoid picture noise (interference), leave an adequate distance between the VCR and TV
- Use the ISM Method (on the Option menu) feature to avoid having a fixed image remain on the screen for a long period of time. Typically a frozen still picture from a VCR. If the 4:3 picture format is used; the fixed images on the sides of the screen may remain visible on the screen.

Connection Option 1

Set VCR output switch to 3 or 4 and then tune TV to the same channel number.

Connection Option 2

1. Connect the audio and video cables from the VCR's output jacks to the TV input jacks, as shown in the figure.
When connecting the TV to VCR, match the jack colors (Video = yellow, Audio Left = white, and Audio Right = red).
If you connect an S-VIDEO output from VCR to the S-VIDEO input, the picture quality is improved; compared to connecting a regular VCR to the Video input.
2. Insert a video tape into the VCR and press PLAY on the VCR. (Refer to the VCR owner's manual.)
3. Select the input source with using the **TV/VIDEO** button on the remote control. (If connected to A/V INPUT 1, select **Video 1** input source)

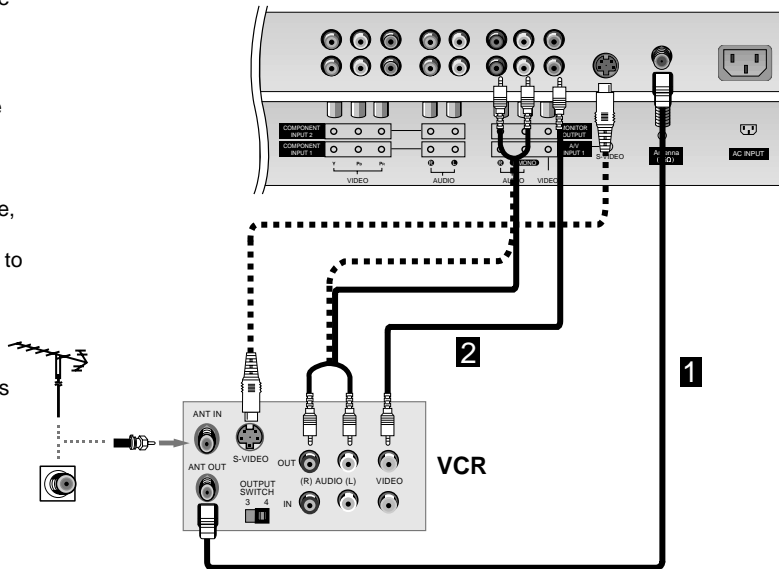

Do not connect to both Video and S-Video at the same time. In the event that you connect both Video and the S-Video cables, only the S-Video will work.)

Cable TV Setup

- After subscribing to a cable TV service from a local provider and installing a converter, you can watch cable TV programming. The TV cannot display TV programming unless a TV tuner device or cable TV converter box is connected to the TV.
- For further information regarding cable TV service, contact your local cable TV service provider(s).

Connection Option 1

1. Select 3 or 4 with channel switch on cable box.
2. Tune the TV channel to the same selected output channel on cable box.
3. Select channels at the cable box or with the cable box remote control.

Connection Option 2

1. Connect the audio and video cables from the Cable Box's output jacks to the TV input jacks, as shown in the figure.
When connecting the TV to a Cable Box, match the jack colors (Video = yellow, Audio Left = white, and Audio Right = red).
2. Select the input source with using the **TV/VIDEO** button on the remote control. (If connected to A/V INPUT 1, select **Video 1** input source)
3. Select your desired channel with the remote control for cable box.

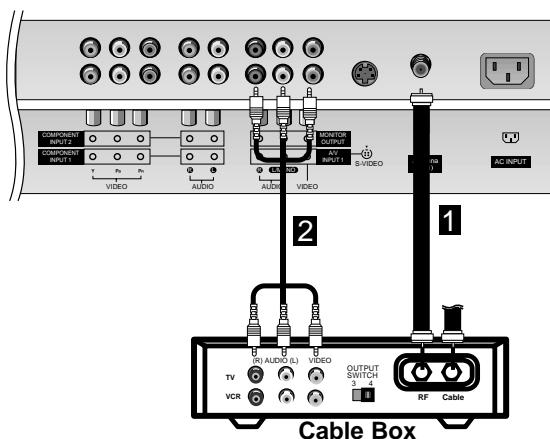

External A/V Source Setup

How to connect

Connect the audio and video cables from the external equipment's output jacks to the TV input jacks, as shown in the figure.

When connecting the TV to external equipment, match the jack colors (Video = yellow, Audio Left = white, and Audio Right = red).

How to use

1. Select the input source with using the **TV/VIDEO** button on the remote control. (If connected to A/V INPUT 1, select **Video 1** input source).
2. Operate the corresponding external equipment. Refer to external equipment operating guide.

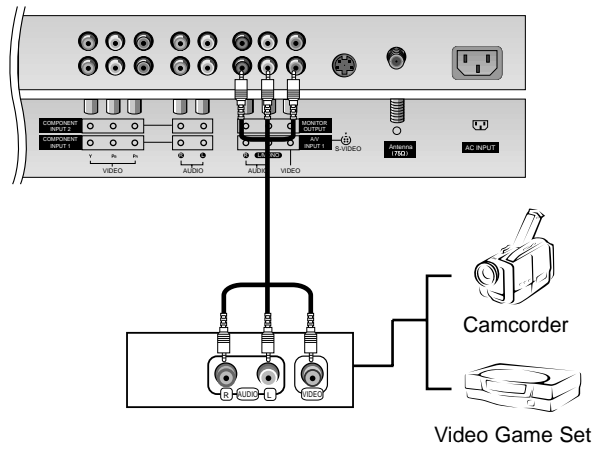

DVD Setup

How to connect

1. Connect the DVD video outputs (Y, P_B, P_R) to the COMPONENT (Y, P_B, P_R) INPUT jacks on the TV and connect the DVD audio outputs to the AUDIO INPUT jacks on the TV, as shown in the figure.
2. If your DVD only has an S-Video output jack, connect this to the S-VIDEO input on the TV and connect the DVD audio outputs to the AUDIO INPUT jacks on the TV, as shown in the figure.

NOTE: If your DVD player does not have component video output, use S-Video.

How to use

1. Turn on the DVD player, insert a DVD.
2. Use the **TV/VIDEO** or **MULTIMEDIA** button on the remote control to select **Component 1** or **Component 2**. (If connected to S-VIDEO, select the **Video 1** or **Video 2** external input source.)
3. Refer to the DVD player's manual for operating instructions.

• **Component Input ports**

To get better picture quality, connect a DVD player to the component input ports as shown below.

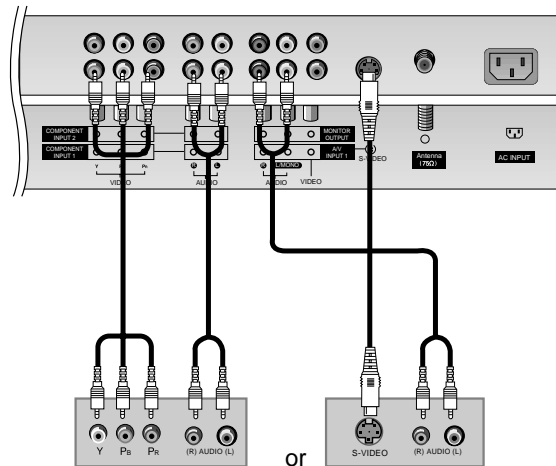

DVD

Component ports on the TV	Y	P _B	P _R
---------------------------	---	----------------	----------------

Video output ports on DVD player	Y	P _B	P _R
	Y	B-Y	R-Y
	Y	C _b	C _r
	Y	P _B	P _R

DTV Setup

- To watch digitally broadcast programs, purchase and connect a digital set-top box.

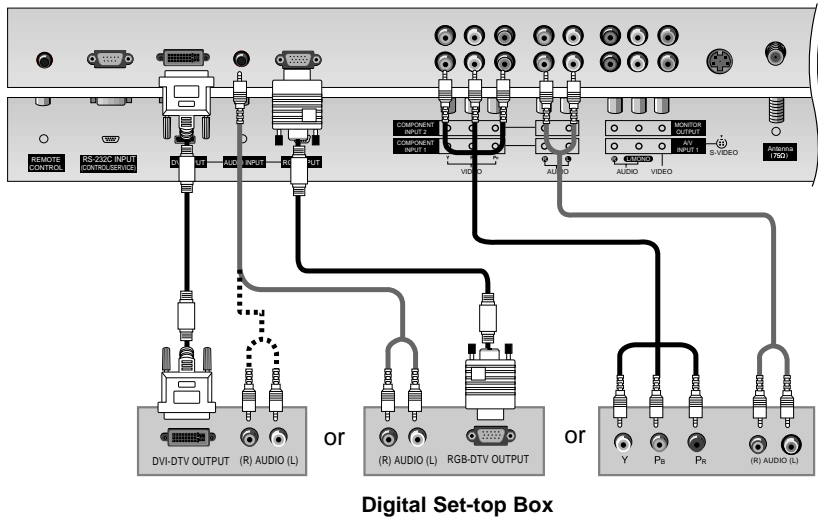

How to connect

Use the TV's COMPONENT (Y, Pb, Pr) INPUT, RGB or DVI jack for video connections, depending on your set-top box connector. Then, make the corresponding audio connections.

How to use

1. Turn on the digital set-top box. (Refer to the owner's manual for the digital set-top box.)
2. Use **TV/VIDEO** or **MULTIMEDIA** on the remote control to select **Component 1, Component 2, RGB, or DVI** source.

Signal	Component 1/2	RGB,DVI
480i	Yes	No
480p	Yes	Yes
720p	Yes	Yes
1080i	Yes	Yes

Monitor Out Setup

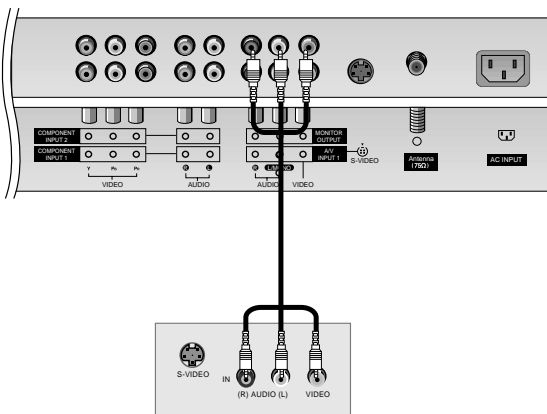

The TV has a special signal output capability which allows you to hook up a second TV or monitor.

Connect the second TV or monitor to the TV's MONITOR OUTPUT. See the Operating Manual of the second TV or monitor for further details regarding that device's input settings.

NOTE

- Component, RGB-PC/RGB-DTV, DVI-PC/DVI-DTV input sources cannot be used for Monitor out.

PC Setup

How to connect

1. To get the best picture quality, adjust the PC graphics card to 640x 480, 60Hz.
2. Use the TV's RGB INPUT or DVI (Digital Visual Interface) INPUT port for video connections, depending on your PC connector.
 - If the graphic card on the PC does not output analog and digital RGB simultaneously, connect only one of either RGB INPUT or DVI INPUT to display the PC on the TV.
 - If the graphic card on the PC does output analog and digital RGB simultaneously, set the TV to either RGB or DVI; (the other mode is set to Plug and Play automatically by the TV.)
3. Then, make the corresponding audio connection. If using a sound card, adjust the PC sound as required.

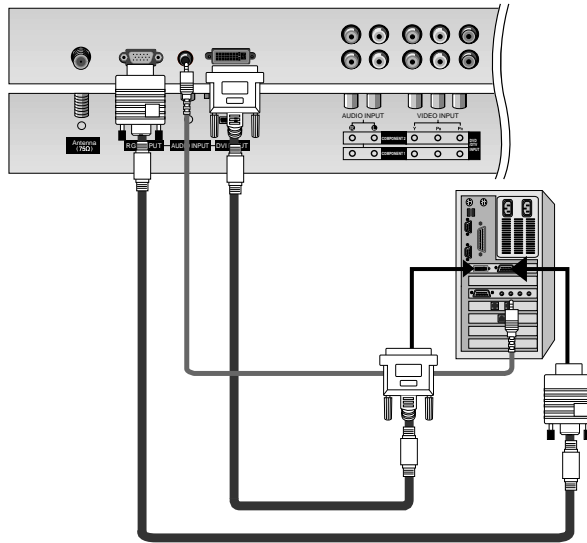

How to use

1. Turn on the PC and the TV.
2. Turn on the display by pressing the POWER button on the TV's remote control.
3. Use **TV/VIDEO** or **MULTIMEDIA** on the remote control to select **RGB**, or **DVI** source.
4. Check the image on your TV. There may be noise associated with the resolution, vertical pattern, contrast or brightness in PC mode. If noise is present, change the PC mode to another resolution, change the refresh rate to another rate or adjust the brightness and contrast on the menu until the picture is clear. If the refresh rate of the PC graphic card can not be changed, change the PC graphic card or consult the manufacturer of the PC graphic card.

- NOTES:**
- Use a DVI cable.
 - Avoid keeping a fixed image on the TV's screen for a long period of time. The fixed image may become permanently imprinted on the screen. Use the Orbiter screen saver when possible.
 - The synchronization input form for Horizontal and Vertical frequencies is separate.

Monitor Display Specifications (RGB / DVI Mode)

Resolution	Horizontal Frequency(KHz)	Vertical Frequency(Hz)	Resolution	Horizontal Frequency(KHz)	Vertical Frequency(Hz)
640x350	31.468	70.09	800x600	35.156	56.25
	37.861	85.08		37.879	60.31
720x400	31.469	70.08	832x624	48.077	72.18
	37.927	85.03		46.875	75.00
640x480	31.469	59.94	1024x768	53.674	85.06
	35.000	66.66		49.725	74.55
	37.861	72.80		48.363	60.00
848x480	37.500	75.00	1152x864	56.476	70.06
	43.269	85.00		60.023	75.02
	31.500	60.00		68.677	85.00
852x480	37.799	70.00	1152x870	54.348	60.05
	39.375	75.00		63.995	70.01
852x480	31.500	60.00	1280x960	67.500	75.00
	37.799	70.00		77.487	85.00
	39.375	75.00		68.681	75.06
			1280x1024	60.023	60.02
				63.981	60.02

→ RGB Mode Only

Operation

Turning the TV On

* In this manual, the OSD (On Screen Display) may be different from your TV's because it is just an example to help you with the TV operation.

Turning on the TV just after installation

1. Connect power cord correctly.
2. Press the **⓪ ON/OFF** button on the TV. At this moment, the TV is switched to standby mode. Press the **TV/VIDEO, CH (▲ / ▼)** button on the TV or press the **POWER, TV/VIDEO, MULTIMEDIA, Number (0 ~ 9)** button on the remote control and then the TV will turn on.

Turning on the TV (power cord is still connected)

1. If the TV was turned off with the **⓪ ON/OFF** button on the TV
 - Press the **⓪ ON/OFF** button on the TV to turn the TV on.
2. If the TV was turned off with the remote control and then the **⓪ ON/OFF** button on the TV
 - Press the **⓪ ON/OFF** button on the TV and then press the **TV/VIDEO, CH (▲ / ▼)** button on the TV or press the **POWER, TV/VIDEO, MULTIMEDIA, Number (0 ~ 9)** button on the remote control to turn the TV on.

NOTE

- If you intend to be away on vacation, disconnect the power plug from the wall power outlet.

Menu Language Selection

- The menus can be shown on the screen in the selected language. First select your language.

1. Press the **MENU** button and then use **▲ / ▼** button to select the **SPECIAL** menu.
2. Press the **▶** button and then use **▲ / ▼** button to select **Language**.
3. Press the **▶** button and then use **▲ / ▼** button to select your desired language.
From this point on, the on-screen menus will be shown in the language of your choice.
4. Press the **ENTER** button to save.

Channel Menu Options

Auto Program should be used to memorize all the active channels in your area before you are able to use the TV.

There are two ways of storing channels in the TV's memory. You can use either.

One is called AUTO PROGRAM and the other is called MANUAL PROGRAM.

In AUTO PROGRAM mode, the TV will memorize the channels in ascending numerical order. If there are additional channels you want to add or delete, you can manually add or delete those channels with Manual Program.

Auto Program: Channel Search

- Redo Auto Program if the Plasma Display is ever moved to another location.
- Auto Program will search for channels only through the ANT IN jack.
- If channels numbers for broadcast over-the air TV and cable TV are duplicated where different channels have the same number, press the same number buttons again to toggle between:



(For example, press 17 to go to the channel, press 17 again to go to the duplicated channel.)

1. Press the **A.PROG** button and then press the **▶** button. AUTO PROGRAM starts the channel search. If you want to stop auto programming, press the **ENTER** button. Only the channels found up to at that time are memorized.
 - You can also select the **Auto program** option and do a channel search in the **CHANNEL** menu.



Manual Program: Adding/Deleting Channels

- You can add or delete channels from the channel scan manually.
1. Use the **▲ / ▼** or **NUMBER** buttons to select the channel number you want to add or delete.
 2. Press the **MEMORY/ERASE** button.
 3. Use the **MEMORY/ERASE** button to select **Memory** or **Erase**.
 4. Press the **ENTER** button.
 - You can also do **Manual program** with the **CHANNEL** menu.

Fine Tuning Adjustment

- Use this function to correct the picture's instability and condition if it is poor.
1. Press the **MENU** button and then use **▲ / ▼** button to select the **CHANNEL** menu.
 2. Press the **▶** button and then use **▲ / ▼** button to select **Manual program**.
 3. Press the **▶** button and then use **▲ / ▼** button to select **Fine**.
 4. Use the **◀ / ▶** button to adjust the picture to your preference.
 5. Press the **ENTER** button to save.

Notes

- To remove fine tuning from a channel, reprogram the finely-tuned channel with Auto program or Manual Program.
- If a finely-tuned channel is memorized, the color of the channel number changes to yellow.

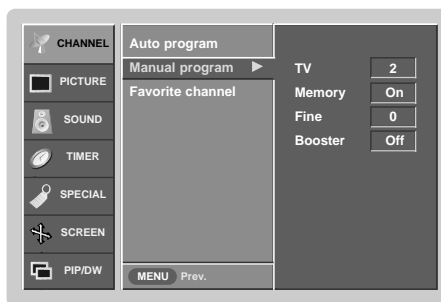

Signal Reception Booster

- If TV signal reception is poor because you are in a fringe area, set Booster to On. If the picture condition is good, set Booster to Off.
- Adjustments for one channel don't affect the adjustment for other channels. Set booster to on or off for each channel separately.

1. Press the **MENU** button and then use **▲ / ▼** button to select the **CHANNEL** menu.
2. Press the **▶** button and then use **▲ / ▼** button to select **Manual program**.
3. Press the **▶** button and then use **▲ / ▼** button to select **Booster**.
4. Use **◀ / ▶** button to select **On** or **Off**.
5. Press the **ENTER** button to save.

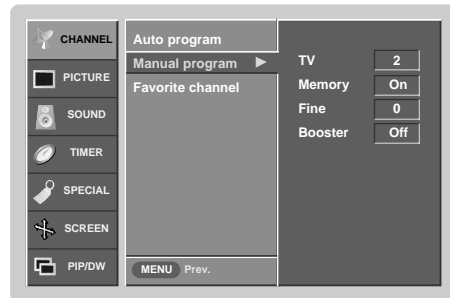

Favorite Channels Setup

- Favorite Channels is a convenient feature that lets you quickly scan up to 8 channels of your choice without having to wait for the TV to scan through all the in-between channels.

1. Press the **MENU** button and then use **▲ / ▼** button to select the **CHANNEL** menu.
2. Press the **▶** button and then use **▲ / ▼** button to select **Favorite channel**.
3. Press the **▶** button and then use **▲ / ▼** button to select the first favorite channel position.
4. Use the **◀ / ▶** button to set the desired channel number for first favorite channel.
5. Repeat steps 3 to 4 to memorize other favorite channels.
6. Press the **ENTER** button to save.
 - To tune to a favorite channel, press the **FCR** (Favorite Channel Review) button repeatedly. The eight favorite channels appear on the screen in numerical order.

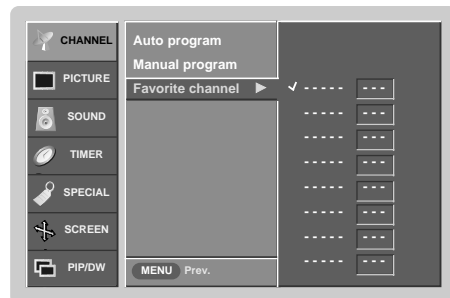

Picture Menu Options

APC (Auto Picture Control)

- APC adjusts the TV to the best picture appearance.
- If adjusting picture options (contrast, brightness, color, sharpness, or tint) manually, APC automatically changes to **Off**.

1. Press the **APC** button repeatedly to select the picture appearance setup option as shown below.



- You can also adjust **APC** in the **PICTURE** menu.
- **Daylight**, **Optimum**, and **Night time** settings are preset for good picture quality at the factory and cannot be changed.

XD

- XD is LG Electronic's unique picture improving technology to display a real HD source through an advanced digital signal processing algorithm.
- When selecting APC options (Daylight, Optimum and Night time), XD is automatically change to On.

1. Press the **MENU** button and then use **▲ / ▼** button to select the **PICTURE** menu.
2. Press the **▶** button and then use **▲ / ▼** button to select **XD**.
3. Press the **▶** button and then use **▲ / ▼** button to set **On** or **Off**.
4. Press the **ENTER** button to save.

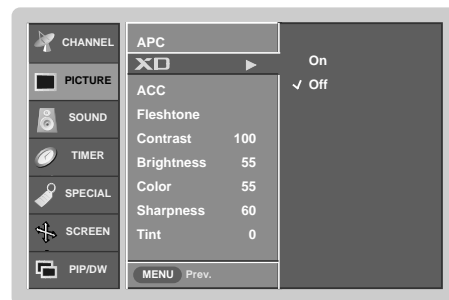

Color Temperature Control

Auto Color Temperature Control

- To initialize values (reset to default settings), select the **Normal** option.

1. Press the **MENU** button and then use **▲ / ▼** button to select the **PICTURE** menu.
2. Press the **▶** button and then use **▲ / ▼** button to select **ACC**.
3. Press the **▶** button and then use **▲ / ▼** button to select either: **Cool** (Preset), **Normal** (Default), or **Warm** (Preset).
4. Press the **ENTER** button to save.

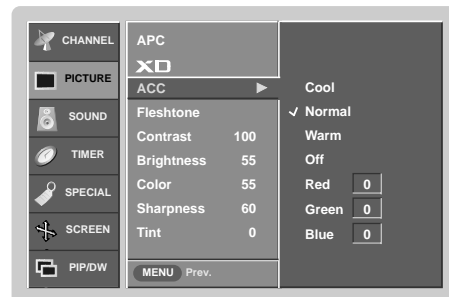

Manual Color Temperature Control (ACC set to Off option)

- You can adjust red, green, or blue to any color temperature you prefer.

1. Press the **MENU** button and then use **▲ / ▼** button to select the **PICTURE** menu.
2. Press the **▶** button and then use **▲ / ▼** button to select **ACC**.
3. Press the **▶** button and then use **▲ / ▼** button to select **Off**.
4. Press the **▶** button and then use **▲ / ▼** button to select **Red**, **Green** or **Blue**.
5. Use the **◀ / ▶** button to make appropriate adjustments.
 - The adjustment range of **Red**, **Green**, and **Blue** is -30 ~ +30.
6. Press the **ENTER** button to save.

Fleshtone (TV, Video1-2, Component 1-2, RGB-DTV, and DVI-DTV Mode only)

- Use Fleshtone to select the desired skin color option.

1. Press the **MENU** button and then use **▲ / ▼** button to select the **PICTURE** menu.
2. Press the **▶** button and then use **▲ / ▼** button to select **Fleshtone**.
3. Press the **▶** button and then use **◀ / ▶** button to make appropriate adjustments.
 - The adjustment range is 0 ~ 3.
4. Press the **ENTER** button to save.

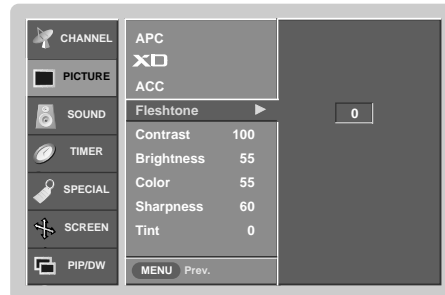

sRGB (only RGB-PC, DVI-PC Modes)

- If the TV is connected to external equipment using sRGB, set sRGB to On to adjust for the color difference.

1. Press the **MENU** button and then use **▲ / ▼** button to select the **PICTURE** menu.
2. Press the **▶** button and then use **▲ / ▼** button to select **sRGB**.
3. Press the **▶** button and then use **▲ / ▼** button to select **On** or **Off**.
4. Press the **ENTER** button to save.



Manual Picture Control (**APC** set to set to **Off** option)

- You can adjust picture contrast, brightness, color, sharpness, and tint options to the levels you prefer.

1. Press the **MENU** button and then use **▲ / ▼** button to select the **PICTURE** menu.
2. Press the **▶** button and then use **▲ / ▼** button to select the desired picture option (**Contrast**, **Brightness**, **Color**, **Sharpness**, **Tint**).
3. Press the **▶** button and then use **◀ / ▶** button to make appropriate adjustments.
4. Press the **ENTER** button to save.

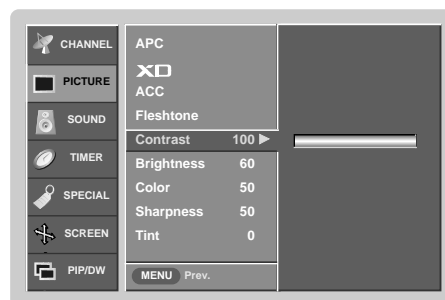

Sound Menu Options

DASP (Digital Auto Sound Processing)

- This function lets you enjoy the best sound without any special adjustment because the TV has the appropriate sound options based on the program content.
- If you adjust sound options (Treble and Bass) manually, DASP automatically changes to **Off**.

1. Press the **DASP** button repeatedly to select the appropriate sound setup as shown below.



- You can also adjust **DASP** in the **SOUND** menu.
- **SRS TSXT**, **Flat**, **Music**, **Movie**, and **Sports** are preset for good sound quality at the factory and cannot be changed.
- **SRS** is a trademark of SRS Labs, Inc.
- TruSurround XT technology is incorporated under license from SRS Labs, Inc.

BBE

- BBE High Definition Sound restores clarity and presence for better speech intelligibility and music realism.

1. Press the **MENU** button and then use **▲ / ▼** button to select the **SOUND** menu.
2. Press the **▶** button and then use **▲ / ▼** button to select **BBE**.
3. Press the **▶** button and then use **▲ / ▼** button to select **On** or **Off**.
4. Press the **ENTER** button to save.

- **BBE**. Manufactured under license from BBE Sound, Inc.
- Treble, Bass or BBE aren't suitable for **SRS TSXT** mode.

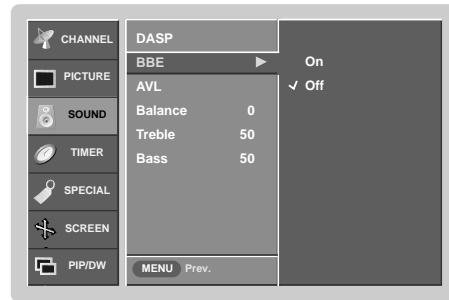

AVL (Auto Volume Leveler)

- AVL maintains an equal sound level; even if you change channels.

1. Press the **MENU** button and then use **▲ / ▼** button to select the **SOUND** menu.
2. Press the **▶** button and then use **▲ / ▼** button to select **AVL**.
3. Press the **▶** button and then use **▲ / ▼** button to select **On** or **Off**.
4. Press the **ENTER** button to save.

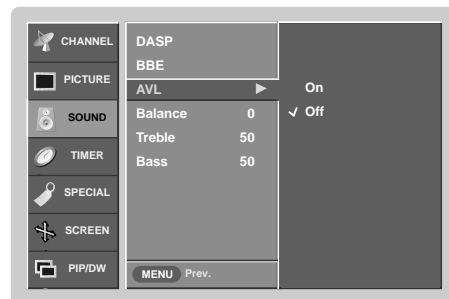

Manual Sound Control (**DASP off** option and balance)

- You can adjust sound options Balance, Treble, and Bass to the levels you prefer.

1. Press the **MENU** button and then use **▲ / ▼** button to select the **SOUND** menu.
2. Press the **▶** button and then use **▲ / ▼** button to select the desired sound option (**Balance, Treble, Bass**).
3. Press the **▶** button and then use **◀ / ▶** button to make appropriate adjustments.
4. Press the **ENTER** button to save.

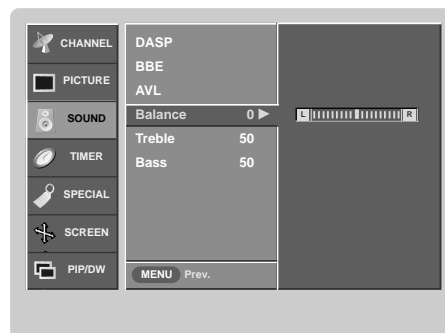

Stereo/SAP Broadcasts Setup

- The TV can receive MTS stereo programs and any SAP (Secondary Audio Program) that accompanies the stereo program; if the broadcaster transmits one additional sound signal in addition to the original one.
- Mono: The primary language is heard from left and right speakers. Signal mode is mono.
- Stereo: The primary language is heard from left and right speakers. Signal mode is stereo.
- SAP: The secondary language is heard from left and right speakers in mono sound.

1. Press the **MTS** button repeatedly.



- Select mono sound mode if the signal is not clear or in poor signal reception areas.
- **Stereo, SAP** modes are available only if included on the broadcast signal.

Timer Menu Options

Clock Setup

- If current time setting is wrong, reset the clock manually.
1. Press the **MENU** button and then use **▲ / ▼** button to select the **TIMER** menu.
 2. Press the **▶** button and then use **▲ / ▼** button to select **Clock**.
 3. Press the **▶** button and then use **▲ / ▼** button to set the hour.
 4. Press the **▶** button and then use **▲ / ▼** button to set the minutes.
 5. Press the **ENTER** button to save.

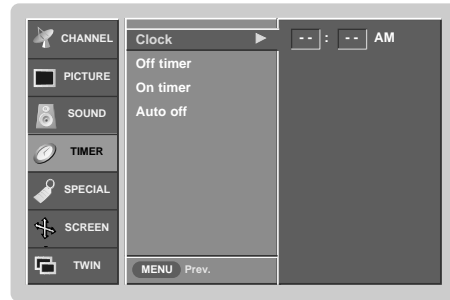

On/Off Timer Setup

- Timer function operates only if current time has been set.
- Off-Timer function overrides On-Timer function if they are set both set to the same time.
- The TV must be in standby mode for the On-Timer to work.
- If you do not press any button within 2 hours after the TV turns on with the On Timer function, the TV will automatically revert to standby mode.

1. Press the **MENU** button and then use **▲ / ▼** button to select the **TIMER** menu.
2. Press the **▶** button and then use **▲ / ▼** button to select **Off timer** or **On timer**.
3. Press the **▶** button and then use **▲ / ▼** button to select **On**.
 - To cancel **On/Off timer** function, select **Off**.
4. Press the **▶** button and then use **▲ / ▼** button to set the hour.
5. Press the **▶** button and then use **▲ / ▼** button to set the minutes.
6. **For only On timer function**
 - Press the **▶** button and then use **▲ / ▼** button to select the channel at turn-on.
 - Press the **▶** button and then use **▲ / ▼** button to set the sound level at turn-on.
7. Press the **ENTER** button to save.

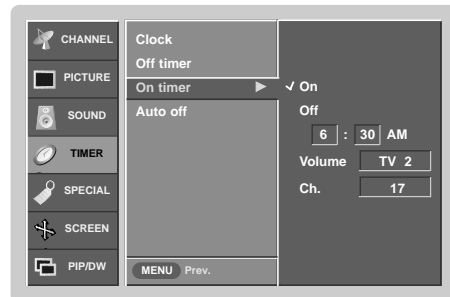

Auto Off

- If set to on and there is no input signal, the TV turns off automatically after 10 minutes.
1. Press the **MENU** button and then use **▲ / ▼** button to select the **TIMER** menu.
 2. Press the **▶** button and then use **▲ / ▼** button to select **Auto off**.
 3. Press the **▶** button and then use **▲ / ▼** button to select **On** or **Off**.
 4. Press the **ENTER** button to save.

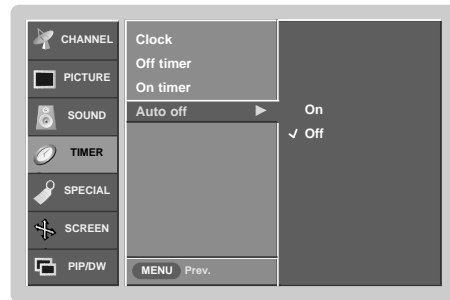

Sleep Timer

- The Sleep Timer turns the TV off at the preset time. Note that this setting is cleared when the TV is turned off.
1. Press the **SLEEP** button repeatedly to select the number of minutes. First the **Off** option appears on the screen, followed by the following sleep timer options: 10, 20, 30, 60, 90, 120, 180, and 240 minutes.
 2. When the number of minutes you want is displayed on the screen, press the **OK** button. The timer begins to count down from the number of minutes selected.
 3. To check the remaining minutes before the TV turns off, press the **SLEEP** button once.
 4. To cancel the Sleep Timer, press the **SLEEP** button repeatedly to select **Off**.

Special Menu Options

Key Lock

- The TV can be set up so that it can only be used with the remote control.
- This feature can be used to prevent unauthorized viewing by locking out the front panel controls.
- This TV is programmed to remember which option it was last set to even if you turn the TV off.

1. Press the **MENU** button and then use **▲ / ▼** button to select the **SPECIAL** menu.
2. Press the **▶** button and then use **▲ / ▼** button to select **Key lock**.
3. Press the **▶** button and then use **▲ / ▼** button to select **On** or **Off**.
4. Press the **ENTER** button to save.

- With the Key lock On, the display '▲ Key lock' appears on the screen if any button on the front panel is pressed.

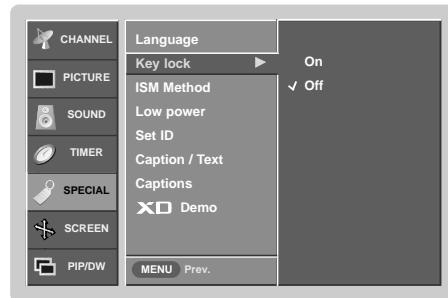

ISM (Image Sticking Minimization) Method

- A frozen still picture from a PC/video game displayed on the screen for prolonged periods will result in a ghost image remaining even when you change the image. Avoid allowing a fixed image to remain on the TV's screen for a long period of time.

1. Press the **MENU** button and then use **▲ / ▼** button to select the **SPECIAL** menu.
2. Press the **▶** button and then use **▲ / ▼** button to select **ISM Method**.
3. Press the **▶** button and then use **▲ / ▼** button to select either **Normal**, **White wash**, **Orbiter** or **Inversion**.

• Normal

If image sticking is never a problem, ISM is not necessary - set to Normal.

• White wash

White Wash removes permanent images from the screen. Note: An excessive permanent image may be impossible to clear entirely with White Wash. To return to normal viewing, press any button.

• Orbiter

Orbiter may help prevent ghost images. However, it is best not to allow any fixed image to remain on the screen. To avoid a permanent image on the screen, the image will move every 2 minutes: Right → Right → Downside → Downside → Left → Left → Upside → Upside.

• Inversion

Inversion will automatically invert the TV panel color every 30 minutes.

4. Press the **ENTER** button to save.

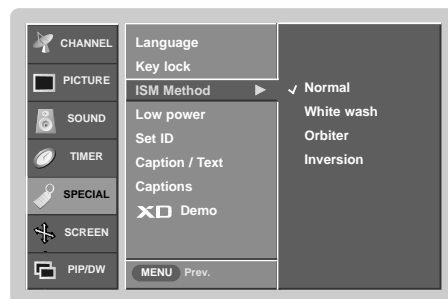

Special Menu Options continued

Low Power

- Low power reduces the plasma display power consumption.
1. Press the **MENU** button and then use ▲ / ▼ button to select the **SPECIAL** menu.
 2. Press the ► button and then use ▲ / ▼ button to select **Low power**.
 3. Press the ► button and then use ▲ / ▼ button to select **On** or **Off**.
 - When you select **On**, the screen darkens.
 4. Press the **ENTER** button to save.

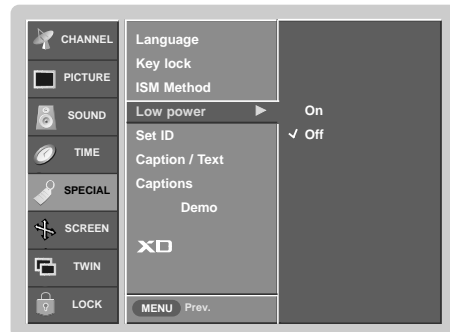

XD Demo

- Use it to see the difference between XD Demo on and XD Demo off.
1. Press the **MENU** button and then use ▲ / ▼ button to select the **SPECIAL** menu.
 2. Press the ► button and then use ▲ / ▼ button to select **XD Demo**.
 3. Press the ► button to begin **XD Demo**.
 4. Press the **MENU** button to stop **XD Demo**.

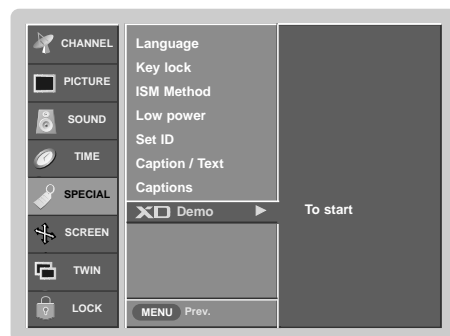

Closed Captions

Closed captioning is a process which converts the audio portion of a television program into written words which then appear as subtitles on the television screen. Closed captions allow viewers to read the dialogue and narration of television programs.

Using Closed Captions

Captions are the subtitles of the dialogue and narration of television programs. For prerecorded programs, program dialogue can be arranged into captions in advance. Its possible to caption a live program by using a process called real-time captioning, which creates captions instantly. Real-time captioning is normally done by professional reporters using a machine shorthand system and computer for translation into English.

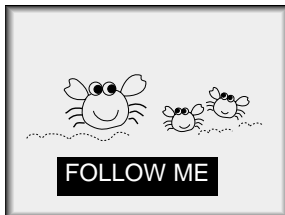

Captioning is an effective system for the hearing-impaired, and it can also aid in teaching language skills.

- The picture at left shows a typical caption.

Caption Tips

- Not all TV broadcasts include closed caption signals.
- Sometimes TV stations broadcast four different caption signals on the same channel. By selecting **CC 1 to CC 2**, you can choose which signal you view. **CC 1** is usually the signal with the captions, while **Another mode** might show demonstration or programming information.
- Your TV might not receive caption signals normally in the following situations.

1. Poor reception conditions are encountered:



• IGNITION:

Picture may flutter, drift, suffer from black spots, or horizontal streaking. Usually caused by interference from automobile ignition systems, neon lamps, electrical drills, and other electrical appliances.



• GHOSTS:

Ghosts are caused when the TV signal splits and follows two paths. One is the direct path and the other is reflected off tall buildings, hills or other objects. Changing the direction or position of the antenna may improve reception.



• SNOW:

If your receiver is located at the weak, fringe area of a TV signal, your picture may be marred by small dots. It may be necessary to install a special antenna to improve the picture.

2. An old, bad, or illegally recorded tape is being played.
3. Strong, random signals from a car or airplane interfere with the TV signal.
4. The signal from the antenna is weak.
5. The program wasn't captioned when it was produced, transmitted, or taped.

Captions

1. Use the **CAPTION** button repeatedly to select Caption **Off**, **EZ Mute**, or **On**.
 - **EZ Mute** shows the selected captions option (if available on program) when the TV sound is muted.
2. Press the **ENTER** button to save.

Caption/Text

- Low power reduces the plasma display power consumption.

1. Press the **MENU** button and then use **▲ / ▼** button to select the **OPTION** menu.
2. Press the **▶** button and then use **▲ / ▼** button to select **Caption / Text**.
3. Press the **▶** button and then use **▲ / ▼** button to select caption: **CC1**, **CC2**, **CC3**, **CC4**, **Text1**, **Text2**, **Text3**, or **Text4**.

• CAPTION

The term for the words that scroll across the bottom of the TV screen; usually the audio portion of the program provided for the hearing impaired.

• TEXT

The term for the words that appear in a large black frame and almost cover the entire screen; usually messages provided by the broadcaster.

4. Press the **ENTER** button to save.

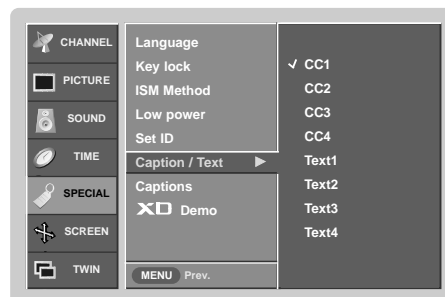

Screen Menu Options

Auto Adjustment

- RGB (PC) mode only; This function doesn't work for RGB-DTV mode.
- Automatically adjusts picture position and minimizes image shaking.
- After adjustment, if the image is still not correct, your TV is functioning properly but needs further adjustment.
- The **Auto config.** and **Manual config.** are not active in DVI mode.

1. Press the **MENU** button and then use **▲ / ▼** button to select the **SCREEN** menu.
2. Press the **▶** button and then use **▲ / ▼** button to select **Auto config.**
3. Press the **▶** button to run Auto configure.
 - When **Auto config.** has finished, **OK** will be shown on screen.
 - If the position of the image is still not correct, try Auto adjustment again.
4. In RGB (PC) mode, if the image needs to be adjusted more after using **Auto config.**, you can make further adjustments with the **Manual config.** option.

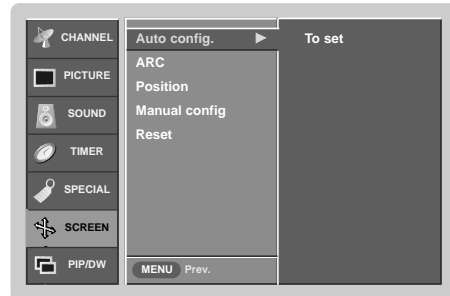

Setting Picture Format

- Caution: If a 4:3 fixed image is on the screen for a long time, it may remain visible.
- Set every aspect ratio for TV, Video, Component 480i sources.
- Use 4:3, or 16:9 for other RGB-PC and DVI-PC sources.
- Horizon is not available for Component (480p,720p,1080i), DTV (480p,720p,1080i) sources.

1. Press the **ARC** button repeatedly to select the desired picture format. You can also adjust **ARC** in the **SCREEN** menu.
 - **4:3**
Choose **4:3** when you want to view a picture with an original 4:3 aspect ratio, with black bars appearing at both the left and right sides.
 - **16:9**
Choose **16:9** when you want to adjust the picture horizontally, in a linear proportion to fill the entire screen.
 - **Horizon**
Choose **Horizon** when you want to adjust the picture in a non-linear proportion, that is, more enlarged at both sides, to create a spectacular view.
 - **Zoom**
Choose **Zoom** when you want to view the picture without any alteration. However, the top and bottom portions of the picture will be cropped.

Screen Position

- This function works in the following modes:
RGB-PC, RGB-DTV (480p,720p,1080i), DVI-DTV (480p,720p,1080i), COMPONENT (480p,720p,1080i).

1. Press the **MENU** button and then use **▲ / ▼** button to select the **SCREEN** menu.
2. Press the **▶** button and then use **▲ / ▼** button to select **Position**.
3. Press the **▶** button and then use **▲ / ▼ / ◀ / ▶** button to adjust the position.
4. Press the **ENTER** button to save.

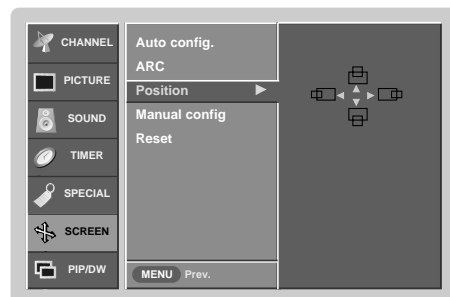

Manual Configure (RGB-PC mode only)

- If the image still isn't clear after auto adjustment and especially if characters are still jittery, adjust the picture Phase manually.
- To correct the screen size, adjust **Clock**.

1. Press the **MENU** button and then use **▲ / ▼** button to select the **SCREEN** menu.
2. Press the **▶** button and then use **▲ / ▼** button to select **Manual config.**
3. Press the **▶** button and then use **▲ / ▼** button to select **Phase** or **Clock**.
4. Use the **◀ / ▶** button to make appropriate adjustments.
 - The **Phase** adjustment range is 0 ~ 30.
 - The **Clock** adjustment range is -127 ~ +128.
5. Press the **ENTER** button to save.



Selecting VGA mode (RGB-PC mode only)

- To see a normal picture, match the resolution of RGB mode and selection of VGA mode.

1. Press the **MENU** button and then use **▲ / ▼** button to select the **SCREEN** menu.
2. Press the **▶** button and then use **▲ / ▼** button to select **VGA Mode**.
3. Press the **▶** button and then use **▲ / ▼** button to select the desired VGA resolution.
4. Press the **ENTER** button to save.

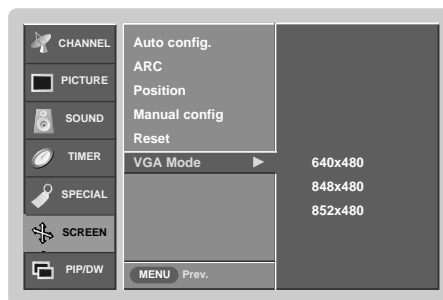

Screen Adjustments (TV, Video1-2 and Component 480i mode only)

- Use this function to correct jittering or picture instability while viewing a video tape.

1. Press the **MENU** button and then use **▲ / ▼** button to select the **SCREEN** menu.
2. Press the **▶** button and then use **▲ / ▼** button to select **Screen adj.**
3. Press the **▶** button and then use **▲ / ▼** button to select **TV** or **VCR**.
 - Select the **VCR** option if watching a VCR.
 - Select the **TV** option for other equipment. (Except VCR)
4. Press the **ENTER** button to save.

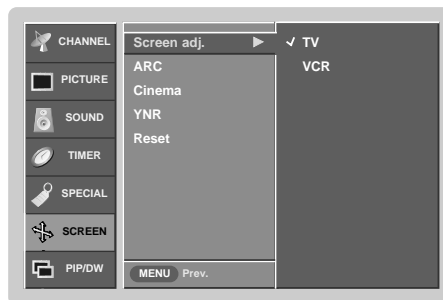

Cinema Mode Setup (TV, Video1-2 and Component 480i mode only)

- Sets up the TV for the best picture appearance for viewing movies.

1. Press the **MENU** button and then use **▲ / ▼** button to select the **SPECIAL** menu.
2. Press the **▶** button and then use **▲ / ▼** button to select **Cinema**.
3. Press the **▶** button and then use **▲ / ▼** button to select **On** or **Off**.
4. Press the **ENTER** button to save.



Screen Menu Options continued

Luminance Noise Reduction (TV, Video 1-2 and Component 480i modes only)

- Use YNR to reduce the picture noise that may appear on the screen.

1. Press the **MENU** button and then use **▲ / ▼** button to select the **SCREEN** menu.
2. Press the **▶** button and then use **▲ / ▼** button to select **YNR**.
3. Press the **▶** button and then use **▲ / ▼** button to select **On** or **Off**.
4. Press the **ENTER** button to save.

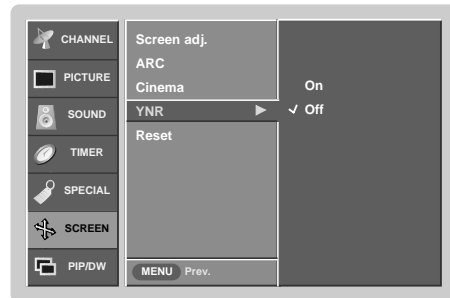

Initializing (Reset to original factory value)

- Reset is unique to each function: Manual config., Position, Split zoom, PIP position and sub picture size for double window.
- Use the Reset option to initialize the adjusted settings.

1. Press the **MENU** button and then use **▲ / ▼** button to select the **SCREEN** menu.
2. Press the **▶** button and then use **▲ / ▼** button to select **Reset**.
3. Press the **▶** button.
 - You can initialize Position, Split zoom, PIP Transparency, PIP position, PIP size and sub picture size for double window.



Split Zoom

- Enlarges the picture in correct proportions.
- Split Zoom can be used for all input sources.
- In 2-Split Zoom mode, you can only move the image up or down.
- If an image is enlarged, a section can be viewed without using Split Zoom.

1. Press the **SPLIT ZOOM** button repeatedly to select either 2, 4, or 9 Split Zoom.

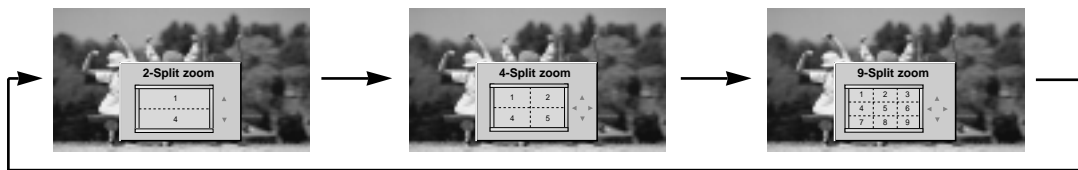

2. Press the number button corresponding to the section you wish to enlarge. You can move within the enlarged picture using the **▲ / ▼ / ◀ / ▶** button. To return to normal viewing, press the **SPLIT ZOOM** button again.

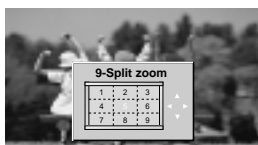

Example of choosing 5.



Section 5 is enlarged to fill the screen.

PIP (Picture-In-Picture)/Double Window Feature

- PIP lets you view 2 different inputs pictures (sources) on your TV screen at the same time. One source will be large, and the other source will show a smaller inset image.
- Double Window mode splits the screen into 2, allowing 2 picture sources to be shown on the TV screen at the same time. Each source is given half the screen.

Watching PIP/Double Window

Press the **PIP/DW** button to access the sub picture. Each press of PIP changes the PIP options as shown below.

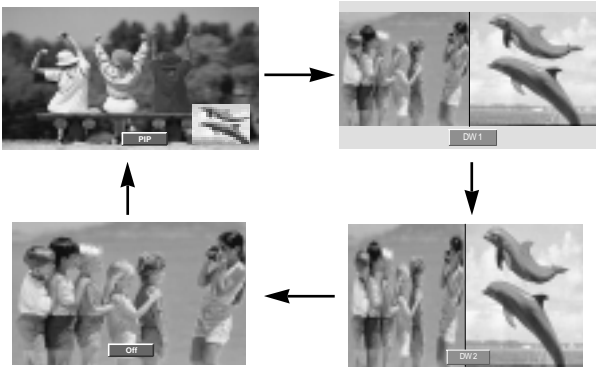

Swapping the PIP/Double Window

Use the **SWAP** button to switch the main and sub pictures.

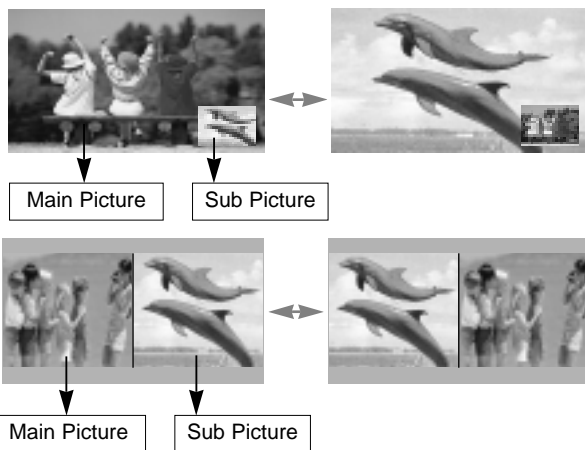

TV Program selection for PIP

Press the **PIPCH+** / **PIPCH-** button to select a channel for the sub picture in PIP mode.

Selecting an Input Signal Source for PIP/Double Window

Use the **PIP INPUT** button to select the input source for the sub picture. Each press of **PIP INPUT** button changes the PIP source.

Main Picture Source	Available Sub Picture Sources
TV, Video 1-2, Component 480i	TV, Video 1-2, Component 480i/480p/720p/1080i, RGB and DVI
Component 480p/720p/1080i, RGB and DVI	TV, Video 1-2, Component 480i

Moving the PIP (PIP Mode only)

Press the **POSITION** button.

Press the **▲ / ▼ / ◀ / ▶** button repeatedly until desired position is achieved. The sub picture moves up/down/left/right.

- You can also move the PIP position with **Win.position** in the **PIP/DW** menu.



PIP Size

Press the **WIN.SIZE** button and then use **◀ / ▶** button to change the sub picture size.

- Using the Win.size function in Double Window mode, main and sub picture sizes are changed simultaneously.
- Using the Win.size function in PIP mode, sub picture size is changed.

- You can also change the sub picture size with **Win.size** in the **PIP/DW** menu.



PIP Transparency (PIP Mode only)

- To make the PIP clear or opaque

1. Press the **MENU** button and then use **▲ / ▼** button to select the **PIP/DW** menu.
2. Press the **▶** button and then use **▲ / ▼** button to select **PIP Transparency**.
3. Press the **▶** button and then use **▲ / ▼** button to adjust PIP transparency.
4. Use the **◀ / ▶** button to make appropriate adjustments.
 - The adjustment range of **PIP Transparency** is 0 ~ 10.
5. Press the **ENTER** button to save.

External Control Device Setup

- Connect the RS-232C input jack to an external control device (such as a computer or an A/V control system) and control the Monitor's functions externally.
- Connect the serial port of the control device to the RS-232C jack on the Monitor back panel.
- RS-232C connection cables are not supplied with the Monitor.

RS-232C Setup

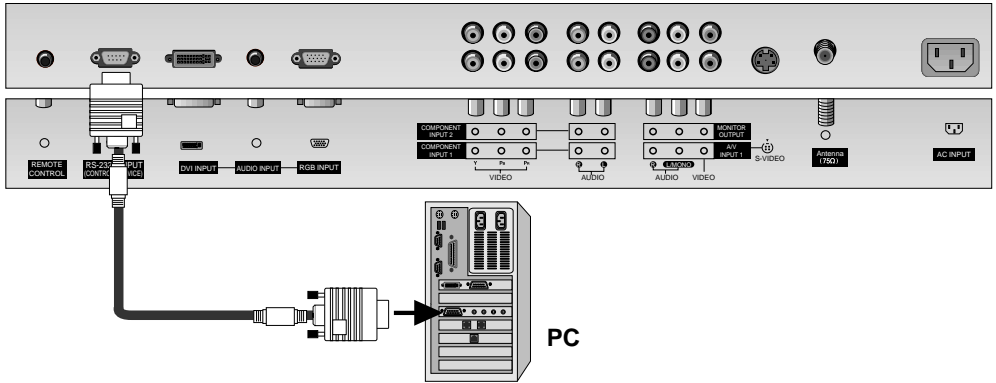

Type of Connector; D-Sub 9-Pin Male

No.	Pin name
1	No connection
2	RXD (Receive data)
3	TXD (Transmit data)
4	DTR (DTE side ready)
5	GND
6	DSR (DCE side ready)
7	RTS (Ready to send)
8	CTS (Clear to send)
9	No Connection

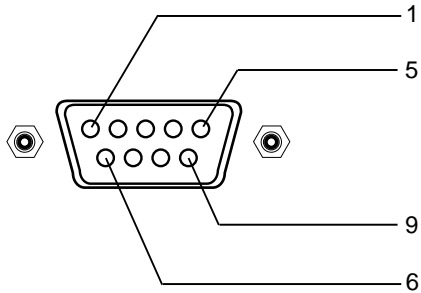

RS-232C Configurations

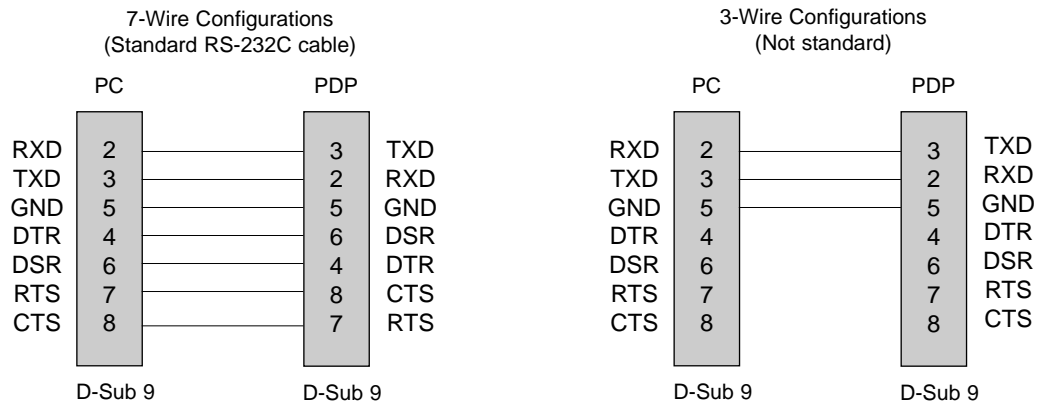

Set ID

- Use this function to specify a monitor ID number.
- Refer to 'Real Data Mapping 1'. See page 32.

1. Press the **MENU** button and then use **▲ / ▼** button to select the **SPECIAL** menu.
2. Press the **▶** button and then use **▲ / ▼** button to select **Set ID**.
3. Press the **▶** button and then use **◀ / ▶** button to adjust **Set ID** to choose the desired monitor ID number. The adjustment range of **Set ID** is 1 ~ 99.
4. Press the **ENTER** button to save.

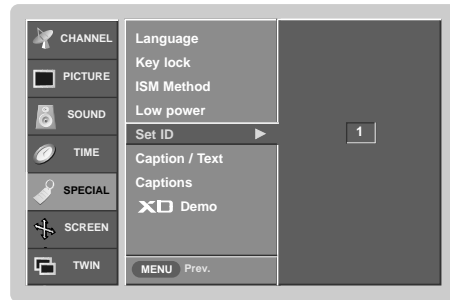

Communication Parameters

- Baud rate :9600 bps (UART)
- Data length : 8 bits
- Parity : None
- Stop bit : 1 bit
- Communication code : ASCII code

* Use a crossed (reverse) cable.

Command Reference List

	COMMAND 1	COMMAND 2	DATA (Hexadecimal)
01. Power	k	a	0 ~ 1
02. Input Select	k	b	0 ~ 6
03. Aspect Ratio	k	c	0 ~ 3
04. Screen Mute	k	d	0 ~ 1
05. Volume Mute	k	e	0 ~ 1
06. Volume Control	k	f	0 ~ 64
07. Contrast	k	g	0 ~ 64
08. Brightness	k	h	0 ~ 64
09. Color	k	i	0 ~ 64
10. Tint	k	j	0 ~ 64
11. Sharpness	k	k	0 ~ 64
12. OSD Select	k	l	0 ~ 1
13. Remote Control Lock Mode	k	m	0 ~ 1
14. PIP/DW	k	n	0 ~ 3
15. Split Zoom	k	p	0 ~ 99
16. PIP Position	k	q	0 ~ 3
17. Treble	k	r	0 ~ 64
18. Bass	k	s	0 ~ 64
19. Balance	k	t	0 ~ 64
20. Color Temperature	k	u	0 ~ 3
21. Red Adjustment	k	v	0 ~ 3C
22. Green Adjustment	k	w	0 ~ 3C
23. Blue Adjustment	k	\$	0 ~ 3C
24. PIP Input Source	k	y	0 ~ 6
25. Abnormal State	k	z	0 ~ a
26. ISM Method	j	p	0 ~ 3
27. Low Power	j	q	0 ~ 1
28. Orbiter Time Setting	j	r	1 ~ FE
29. Orbiter Pixel Setting	j	s	1~9
30. Picture Size	j	t	0 ~ 14
31. Auto Config	j	u	1

	COM- MAND 1	COM- MAND 2	DATA 0 (Hexadecimal)	DATA 1 (Hexadecimal)	DATA 2 (Hexadecimal)	DATA 3 (Hexadecimal)
32. Tune Command	m	a	01 ~ 7D	0	0	mainsub/TuneBand
33. Channel Add/Del	m	b	0 ~ 1			
34. Key	m	c	Key code			

Transmission / Receiving Protocol

Transmission

[Command1][Command2][][Set ID][][Data][Cr]

- * [Command 1]: First command to control PDP set. (j, k or m)
- * [Command 2]: Second command to control PDP set.
- * [Set ID]: You can adjust the set ID to choose desired monitor ID number in Special menu. Adjustment range is 1 ~ 99. When selecting Set ID '0', every connected PDP set is controlled. Set ID is indicated as decimal (1~99) on menu and as Hexa decimal (0x0~0x63) on transmission/receiving protocol.
- * [DATA]: To transmit command data.
Transmit 'FF' data to read status of command.
- * [Cr]: Carriage Return
ASCII code '0x0D'
- * []: ASCII code 'space (0x20)'

OK Acknowledgement

[Command2][][Set ID][][OK][Data][x]

- * The Monitor transmits ACK (acknowledgement) based on this format when receiving normal data. At this time, if the data is data read mode, it indicates present status data. If the data is data write mode, it returns the data of the PC computer.

Error Acknowledgement

[Command2][][Set ID][][NG][Data][x]

- * The Monitor transmits ACK (acknowledgement) based on this format when receiving abnormal data from non-viable functions or communication errors.

- Data 1: Illegal Code
2: Not supported function
3: Wait more time

01. Power (Command2:a)

- ▶ To control Power On/Off of the TV.

Transmission

```
[k][a][ ][Set ID][ ][Data][Cr]
```

Data 0 : Power Off 1 : Power On

Acknowledgement

```
[a][ ][Set ID][ ][OK][Data][x]
```

* In a like manner, if other functions transmit 'FF' data based on this format, Acknowledgement data feedback presents status about each function.

02. Input Select (Command2:b) (Main Picture Input)

- ▶ To select input source for the TV.
You can also select an input source using the TV/VIDEO button on the TV's remote control.

Transmission

```
[k][b][ ][Set ID][ ][Data][Cr]
```

Data 0 : TV 4 : Component 2
1 : Video 1 5 : RGB
2 : Video 2 6 : DVI
3 : Component 1

Acknowledgement

```
[b][ ][Set ID][ ][OK][Data][x]
```

03. Aspect Ratio (Command2:c) (Main picture format)

- ▶ To adjust the screen format.
You can also adjust the screen format using the ARC (Aspect Ratio Control) button on remote control or in the Screen menu.

Transmission

```
[k][c][ ][Set ID][ ][Data][Cr]
```

Data 0 : Normal screen (4:3)
1 : Wide screen (16:9)
2 : Horizon
3 : Zoom

Acknowledgement

```
[c][ ][Set ID][ ][OK][Data][x]
```

04. Screen Mute (Command2:d)

- ▶ To select screen mute on/off.

Transmission

```
[k][d][ ][Set ID][ ][Data][Cr]
```

Data 0 : Screen mute off (Picture on)
1 : Screen mute on (Picture off)

Acknowledgement

```
[d][ ][Set ID][ ][OK][Data][x]
```

05. Volume Mute (Command2:e)

- ▶ To control volume mute on/off.
You can also adjust mute using the MUTE button on remote control.

Transmission

```
[k][e][ ][Set ID][ ][Data][Cr]
```

Data 0 : Volume mute on (Volume off)
1 : Volume mute off (Volume on)

Acknowledgement

```
[e][ ][Set ID][ ][OK][Data][x]
```

06. Volume Control (Command2:f)

- ▶ To adjust volume.
You can also adjust volume with the volume buttons on remote control.

Transmission

```
[k][f][ ][Set ID][ ][Data][Cr]
```

Data Min : 0 ~ Max : 64

- Refer to 'Real data mapping 1' as shown below.

Acknowledgement

```
[f][ ][Set ID][ ][OK][Data][x]
```

07. Contrast (Command2:g)

- ▶ To adjust screen contrast.
You can also adjust contrast in the Picture menu.

Transmission

```
[k][g][ ][Set ID][ ][Data][Cr]
```

Data Min : 0 ~ Max : 64

- Refer to 'Real data mapping 1' as shown below.

Acknowledgement

```
[g][ ][Set ID][ ][OK][Data][x]
```

08. Brightness (Command2:h)

- ▶ To adjust screen brightness.
You can also adjust brightness in the Picture menu.

Transmission

```
[k][h][ ][Set ID][ ][Data][Cr]
```

Data Min : 0 ~ Max : 64

- Refer to 'Real data mapping 1' as shown below.

Acknowledgement

```
[h][ ][Set ID][ ][OK][Data][x]
```

* Real data mapping 1

0 : Step 0
⋮
A : Step 10 (SET ID 10)
⋮
F : Step 15 (SET ID 15)
10 : Step 16 (SET ID 16)
⋮
63 : Step 99 (SET ID 99)
64 : Step 100

09. Color (Command2:i)

- ▶ To adjust the screen color.
You can also adjust color in the Picture menu.

Transmission

[k][i][][Set ID][][Data][Cr]

Data Min : 0 ~ Max : 64

- Refer to 'Real data mapping 1'. See page 32.

Acknowledgement

[i][][Set ID][][OK][Data][x]

10. Tint (Command2:j)

- ▶ To adjust the screen tint.
You can also adjust tint in the Picture menu.

Transmission

[k][j][][Set ID][][Data][Cr]

Data Red : 0 ~ Green : 64

- Refer to 'Real data mapping 1'. See page 32.

Acknowledgement

[j][][Set ID][][OK][Data][x]

11. Sharpness (Command2:k)

- ▶ To adjust the screen sharpness.
You can also adjust sharpness in the Picture menu.

Transmission

[k][k][][Set ID][][Data][Cr]

Data Min: 0 ~ Max: 64

- Refer to 'Real data mapping 1'. See page 32.

Acknowledgement

[k][][Set ID][][OK][Data][x]

12. OSD Select (Command2:l)

- ▶ To select OSD (On Screen Display) on/off.

Transmission

[k][l][][Set ID][][Data][Cr]

Data 0: OSD off 1: OSD on

Acknowledgement

[l][][Set ID][][OK][Data][x]

13. Remote Control Lock Mode (Command2:m)

- ▶ To lock the remote control and the front panel controls on the monitor.

Transmission

[k][m][][Set ID][][Data][Cr]

Data 0: Lock off 1: Lock on

Acknowledgement

[m][][Set ID][][OK][Data][x]

- If you're not using the remote control and front panel controls on the monitor, use this mode. When main power is on/off, remote control lock is released.

14. PIP / DW (Command2:n)

- ▶ To control the PIP (Picture In picture)/DW (Double Window).
You can also control the PIP/DW using the PIP/DW button on the remote control or in the PIP/DW menu.

Transmission

[k][n][][Set ID][][Data][Cr]

Data 0: PIP/DW off 2: DW1
1: PIP 3: DW2Acknowledgement

[n][][Set ID][][OK][Data][x]

15. Split Zoom (Command2:p)

- ▶ To operate split zoom function and select the split zoom section number.

Transmission

[k][p][][Set ID][][Data][Cr]

Data Min: 0 ~ Max:99

- Refer to 'Real data mapping 2'.

Acknowledgement

[p][][Set ID][][OK][Data][x]

* **Real data mapping 2**

- 0 : Reset split zoom
- 21: Selection 1 of 2 split zoom
- 24: Selection 4 of 2 split zoom
- 41: Selection 1 of 4 split zoom
- 42: Selection 2 of 4 split zoom
- 44: Selection 4 of 4 split zoom
- 45: Selection 5 of 4 split zoom
- 91: Selection 1 of 9 split zoom
- ⋮
- 99: Selection 9 of 9 split zoom

16. PIP Position (Command2:q)

- ▶ To select sub picture position for PIP.
You can also adjust the sub picture position using WIN.POSITION on the remote control or in the PIP/DW menu.

Transmission

[k][q][][Set ID][][Data][Cr]

Data 0: Right down on screen
1: Left down on screen
2: Left up on screen
3: Right up on screenAcknowledgement

[q][][Set ID][][OK][Data][x]

17. Treble (Command2:r)

- ▶ To adjust treble.
You can also adjust treble in the Sound menu.

Transmission

[k][r][][Set ID][][Data][Cr]

Data Min: 0 ~ Max: 64

- Refer to 'Real data mapping 1'. See page 32.

Acknowledgement

[r][][Set ID][][OK][Data][x]

18. Bass (Command2:s)

- ▶ To adjust bass.
You can also adjust bass in the Sound menu.

Transmission

```
[k][s][ ][Set ID][ ][Data][Cr]
```

Data Min: 0 ~ Max: 64

- Refer to 'Real data mapping 1'. See page 32.

Acknowledgement

```
[s][ ][Set ID][ ][OK][Data][x]
```

19. Balance (Command2:t)

- ▶ To adjust balance.
You can also adjust balance in the Sound menu.

Transmission

```
[k][t][ ][Set ID][ ][Data][Cr]
```

Data Min: 0 ~ Max: 64

- Refer to 'Real data mapping 1'. See page 32.

Acknowledgement

```
[t][ ][Set ID][ ][OK][Data][x]
```

20. Color Temperature (Command2:u)

- ▶ To adjust color temperature.
You can also adjust ACC in the Picture menu.

Transmission

```
[k][u][ ][Set ID][ ][Data][Cr]
```

Data 0: Cool 1: Normal 2: Warm 3: Off

Acknowledgement

```
[u][ ][Set ID][ ][OK][Data][x]
```

21. Red Adjustment (Command2:v)

- ▶ To adjust red in color temperature.

Transmission

```
[k][v][ ][Set ID][ ][Data][Cr]
```

Data Min: 0 ~ Max: 3C

- Refer to 'Real data mapping 3' as shown right.

Acknowledgement

```
[v][ ][Set ID][ ][OK][Data][x]
```

22. Green Adjustment (Command2:w)

- ▶ To adjust green in color temperature.

Transmission

```
[k][w][ ][Set ID][ ][Data][Cr]
```

Data Min: 0 ~ Max: 3C

- Refer to 'Real data mapping 3' as shown right.

Acknowledgement

```
[w][ ][Set ID][ ][OK][Data][x]
```

23. Blue Adjustment (Command2:\$)

- ▶ To adjust blue in color temperature.

Transmission

```
[k][$][ ][Set ID][ ][Data][Cr]
```

Data Min: 0 ~ Max: 3C

- Refer to 'Real data mapping 3' as shown below.

Acknowledgement

```
[$][ ][Set ID][ ][OK][Data][x]
```

*** Real data mapping 3**

```
0 : -30
1 : -29
2 : -28
⋮
1E : 0
⋮
3A : +28
3B : +29
3C : +30
```

24. PIP Input Select (Command2:y)

- ▶ To select input source for sub picture in PIP mode.

Transmission

```
[k][y][ ][Set ID][ ][Data][Cr]
```

```
Data 0 : TV 4 : Component 2
1 : Video 1 5 : RGB
2 : Video 2 6 : DVI
3 : Component 1
```

Acknowledgement

```
[y][ ][Set ID][ ][OK][Data][x]
```

25. Abnormal State (Command2:z)

- ▶ To recognize an abnormal state.

Transmission

```
[k][z][ ][Set ID][ ][FF][Cr]
```

Data FF:Read

Acknowledgement

```
[z][ ][Set ID][ ][OK][Data][x]
```

```
Data 0: Normal (Power on and signal exist)
1: No signal (Power on).
2: Turn the monitor off with remote control.
3: Turn the monitor off with Sleep Time function.
4: Turn the monitor off with RS-232C function.
5: 5V down.
6: AC down.
7: Turn the monitor off with Fan Alarm function.
8: Turn the monitor off with Off Time function.
9: Turn the monitor off with Auto Off function.
a: Turn the monitor off with On Time function.
```

IR Codes

How to Connect

- ▶ Connect your wired remote control to the Remote Control port on the Monitor.

Remote Control IR Code

▶ Output waveform

Single pulse, modulated with 37.917KHz signal at 455KHz

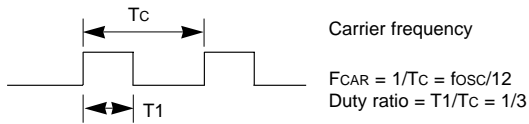

▶ Configuration of frame

- 1st frame

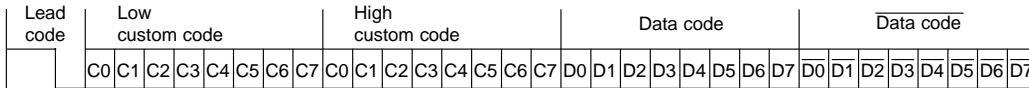

- Repeat frame

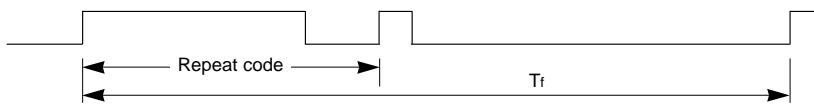

▶ Lead code



▶ Repeat code

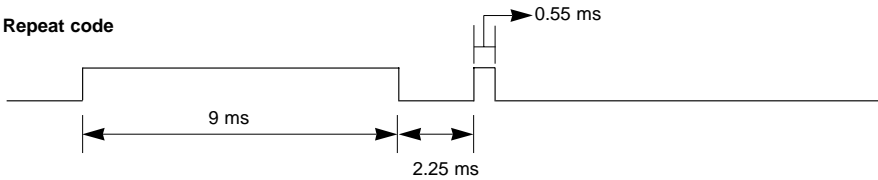

▶ Bit description

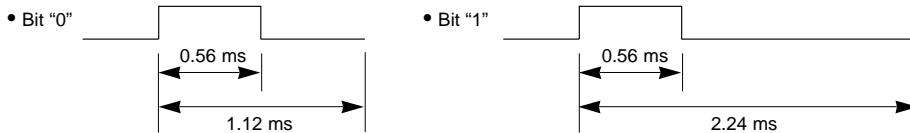

▶ Frame interval : Tf

The waveform is transmitted as long as a key is depressed.

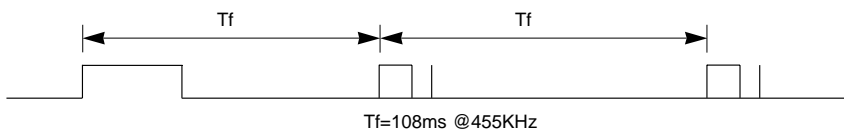

Code (Hexa)	Function	Note
00H	CH (▲)	R/C Button
01H	CH (▼)	R/C Button
02H	VOL (▶)	R/C Button
03H	VOL (◀)	R/C Button
08H	POWER	R/C Button (Power On/Off)
C4H	POWER ON	Discrete IR Code (Only Power On)
C5H	POWER OFF	Discrete IR Code (Only Power Off)
09H	MUTE	R/C Button
10H	Number Key 0	R/C Button
11H	Number Key 1	R/C Button
12H	Number Key 2	R/C Button
13H	Number Key 3	R/C Button
14H	Number Key 4	R/C Button
15H	Number Key 5	R/C Button
16H	Number Key 6	R/C Button
17H	Number Key 7	R/C Button
18H	Number Key 8	R/C Button
19H	Number Key 9	R/C Button
0BH	TV/VIDEO	R/C Button
98H	MULTIMEDIA	R/C Button
D6H	TV	Discrete IR Code (Input TV Selection)
5AH	VIDEO1	Discrete IR Code (Input VIDEO1 Selection)
D0H	VIDEO2	Discrete IR Code (Input VIDEO2 Selection)
BFH	COMPONENT1	Discrete IR Code (Input COMPONENT1 Selection)
D4H	COMPONENT2	Discrete IR Code (Input COMPONENT2 Selection)
C6H	DVI	Discrete IR Code (Input DVI Selection)
D5H	RGB	Discrete IR Code (Input RGB Selection)
0EH	SLEEP	R/C Button
43H	MENU	R/C Button
44H	ENTER	R/C Button
4DH	APC	R/C Button
52H	DASP	R/C Button
60H	PIP/DW	R/C Button
61H	PIP INPUT	R/C Button
63H	SWAP	R/C Button
64H	WIN.SIZE	R/C Button
62H	POSITION	R/C Button
71H	PIP CH+	R/C Button
72H	PIP CH-	R/C Button
7BH	SPLIT ZOOM	R/C Button
79H	ARC	R/C Button
76H	ARC (4:3)	Discrete IR Code (Only 4:3 mode)
77H	ARC (16:9)	Discrete IR Code (Only 16:9 mode)
AFH	ARC (Zoom)	Discrete IR Code (Only Zoom mode)
1EH	FCR	R/C Button
1AH	REVIEW	R/C Button
54H	AUTO PROGRAM	R/C Button
55H	MEMORY/ERASE	R/C Button
0AH	MTS	R/C Button
39H	CAPTION	R/C Button
99H	AUTO CONFIG	Discrete IR Code

Troubleshooting Checklist

No picture & No sound	<ul style="list-style-type: none">• Check whether the TV is turned on.• Is the power cord inserted into wall power outlet?• Test the wall power outlet, plug another product's power cord into the outlet where the TV's power cord was plugged in.
Picture OK & No sound	<ul style="list-style-type: none">• Press the VOLUME (▶) button.• Sound muted? Press MUTE button.
The remote control doesn't work	<ul style="list-style-type: none">• Check to see if there is any object between the TV and the remote control causing obstruction.• Are batteries installed with correct polarity (+ to +, - to -)? (Refer to p.9)• Correct remote operating mode set: TV, VCR etc.?• Install new batteries. (Refer to p.8)
Picture appears slowly after switching on	<ul style="list-style-type: none">• This is normal, the image is muted during the TV startup process. Please contact your service center, if the picture has not appeared after five minutes.
No or poor color or poor picture	<ul style="list-style-type: none">• Select Color in the Picture menu and press the VOLUME (▶) button. (Refer to p.18)• Keep a sufficient distance between the TV and the VCR.• Activate any function to restore the brightness of the picture. (If still picture is on the screen for more than 5 minutes, the screen gets dark.)
Horizontal/vertical bars or picture shaking	<ul style="list-style-type: none">• Check for local interference such as an electrical appliance or power tool.
No output from one of the speakers	<ul style="list-style-type: none">• Adjust Balance in the Sound menu. (Refer to p.20)
Unusual sound from inside the TV	<ul style="list-style-type: none">• A change in ambient humidity or temperature may result in an unusual noise when the plasma display is turned on or off and does not indicate a fault with the TV.

Product Specifications

MODELS	RP-42PX10/10H/20/20H	RP-50PX10/10H/20/20H
Width (inches / mm)	48.4 / 1210	56 / 1400
Height (inches / mm)	27.6 / 701	30.4 / 761.5
Depth (inches / mm)	11.4 / 290	11.4 / 290
Weight (pounds / kg)	66 / 22.9	66 / 29.9
Resolution	852 x 480 (Dot)	1366 x 768 (Dot)
Power requirement	AC100-240V, 50/60Hz	
Television System	NTSC	
Program Coverage	VHF 2 ~ 13, UHF 14 ~ 69, CATV 1 ~ 125	
External Antenna Impedance	75 Ω	
Color	16,770,000 (256 steps of each R, G and B)	
Operating Temperature Range	32 ~ 104°F (0 ~ 40°C)	
Operating Humidity Range	Less than 80%	

- The specifications shown above may be changed without notice for quality improvement.