



PLASMA TV OWNER'S MANUAL

MODEL : 42PY1R-UA / RU-42PY10X

Please read this manual carefully and completely before operating your TV.

Retain this manual for future reference.

Record model number and serial number of the TV in the spaces provided below.

See the label attached on the back cover and relate this information to your dealer if you require service.

Model Number :

Serial Number :

Warning/Caution



WARNING/CAUTION
RISK OF ELECTRIC SHOCK
DO NOT OPEN



WARNING/CAUTION:

TO REDUCE THE RISK OF ELECTRIC SHOCK DO NOT REMOVE COVER (OR BACK). NO USER SERVICEABLE PARTS INSIDE. REFER TO QUALIFIED SERVICE PERSONNEL.



The lightning flash with arrowhead symbol, within an equilateral triangle, is intended to alert the user to the presence of uninsulated "dangerous voltage" within the product's enclosure that may be of sufficient magnitude to constitute a risk of electric shock to persons.



The exclamation point within an equilateral triangle is intended to alert the user to the presence of important operating and maintenance (servicing) instructions in the literature accompanying the appliance.

WARNING/CAUTION:

TO PREVENT FIRE OR SHOCK HAZARDS, DO NOT EXPOSE THIS PRODUCT TO RAIN OR MOISTURE.

FCC NOTICE

• A Class B digital device

This equipment has been tested and found to comply with the limits for a Class B digital device, pursuant to Part 15 of the FCC Rules. These limits are designed to provide reasonable protection against harmful interference in a residential installation. This equipment generates, uses and can radiate radio frequency energy and, if not installed and used in accordance with the instructions, may cause harmful interference to radio communications. However, there is no guarantee that interference will not occur in a particular installation. If this equipment does cause harmful interference to radio or television reception, which can be determined by turning the equipment off and on, the user is encouraged to try to correct the interference by one or more of the following measures:

- Reorient or relocate the receiving antenna.
- Increase the separation between the equipment and receiver.
- Connect the equipment into an outlet on a circuit different from that to which the receiver is connected.
- Consult the dealer or an experienced radio/TV technician for help.

• Any changes or modifications not expressly approved by the party responsible for compliance could void the user's authority to operate the equipment.

CAUTION:

Do not attempt to modify this product in any way without written authorization from LG Electronics. Unauthorized modification could void the user's authority to operate this product.

COMPLIANCE:

The responsible party for this product's compliance is:

LG Electronics U.S.A., Inc
1000 Sylvan Avenue, Englewood Cliffs, NJ 07632
1-800-243-0000
<http://www.lgusa.com>

WARNING/CAUTION

TO REDUCE THE RISK OF FIRE AND ELECTRIC SHOCK, DO NOT EXPOSE THIS PRODUCT TO RAIN OR MOISTURE.

Safety Instructions

IMPORTANT SAFETY INSTRUCTIONS

Important safety instructions shall be provided with each apparatus. This information shall be given in a separate booklet or sheet, or be located before any operating instructions in an instruction for installation for use and supplied with the apparatus.

This information shall be given in a language acceptable to the country where the apparatus is intended to be used.

The important safety instructions shall be entitled "Important Safety Instructions". The following safety instructions shall be included where applicable, and, when used, shall be verbatim as follows. Additional safety information may be included by adding statements after the end of the following safety instruction list. At the manufacturer's option, a picture or drawing that illustrates the intent of a specific safety instruction may be placed immediately adjacent to that safety instruction :

1. **Read these instructions.**
2. **Keep these instructions.**
3. **Heed all warnings.**
4. **Follow all instructions.**
5. **Do not use this apparatus near water.**
6. **Clean only with dry cloth.**
7. **Do not block any ventilation openings. Install in accordance with the manufacturer's instructions.**
8. **Do not install near any heat sources such as radiators, heat registers, stoves, or other apparatus (including amplifiers) that produce heat.**
9. **Do not defeat the safety purpose of the polarized or grounding-type plug. A polarized plug has two blades with one wider than the other. A grounding type plug has two blades and a third grounding prong, The wide blade or the third prong are provided for your safety. If the provided plug does not fit into your outlet, consult an electrician for replacement of the obsolete outlet.**
10. **Protect the power cord from being walked on or pinched particularly at plugs, convenience receptacles, and the point where they exit from the apparatus.**
11. **Only use attachments/accessories specified by the manufacturer.**
12. **Use only with the cart, stand, tripod, bracket, or table specified by the manufacturer, or sold with the apparatus. When a cart is used, use caution when moving the cart/apparatus combination to avoid injury from tip-over.**



PORTABLE CART WARNING

Safety Instructions continued

13. Unplug this apparatus during lightning storms or when unused for long periods of time.

14. Refer all servicing to qualified service personnel. Servicing is required when the apparatus has been damaged in any way, such as power-supply cord or plug is damaged, liquid has been spilled or objects have fallen into the apparatus, the apparatus has exposed to rain or moisture, does not operate normally, or has been dropped.

15. CAUTION concerning the Power Cord :

Most appliances recommend they be placed upon a dedicated circuit; that is, a single outlet circuit which powers only that appliance and has no additional outlets or branch circuits. Check the specification page of this owner's manual to be certain.

Do not overload wall outlets. Overloaded wall outlets, loose or damaged wall outlets, extension cords, frayed power cords, or damaged or cracked wire insulation are dangerous. Any of these conditions could result in electric shock or fire. Periodically examine the cord of your appliance, and if its appearance indicates damage or deterioration, unplug it, discontinue use of the appliance, and have the cord replaced with an exact replacement part by an authorized servicer.

Protect the power cord from physical or mechanical abuse, such as being twisted, kinked, pinched, closed in a door, or walked upon. Pay particular attention to plugs, wall outlets, and the point where the cord exits the appliance.

16. Outdoor Use Marking :

WARNING - To Reduce The Risk Of Fire Or Electric Shock, Do Not Expose This Appliance To Rain Or Moisture.

17. Wet Location Marking :

Apparatus shall not be exposed to dripping or splashing and no objects filled with liquids, such as vases, shall be placed on the apparatus.

Contents

Warning/Caution	2	On/Off Timer Setup	23
Safety Instructions	3~4	Sleep Timer / Auto Off	24
Introduction		Special Menu Features	
Controls	7	Key Lock	25
Connection Options	8	ISM (Image Sticking Minimization) Method	25
Remote Control Key Functions	9	Low Power	26
Installation		XD Demo	26
Installation Instruction	10	Closed Captions	27
Attaching the TV assembly to the wall	10	Captions	27
External Equipment Connections	11	Caption/Text	27
Antenna Connection	11	Screen Menu Features	
VCR Setup / Cable TV Setup	12	Auto Adjustment	28
External A/V Source Setup	13	Setting Picture Format	28
DVD Setup	13	Screen Position	28
DTV Setup / Monitor Out Setup	14	Manual Configure	29
PC Setup	15	Setting VGA Mode	29
Operation		Screen Adjustments	29
Turning the TV On	16	Cinema Mode Setup	29
Menu Language Selection	16	Luminance Noise Reduction	30
Channel Menu Options		Initializing (Reset to original factory value)	30
Auto Program: Channel Search	17	Split Zoom	30
Manual Program: Adding/Deleting Channels	17	Lock Menu Options	
Fine Tuning Adjustment	17	Parental Lock Setup	31
Signal Reception Booster	18	PIP (Picture-In-Picture)/Double Window Feature	
Favorite Channels Setup	18	Watching PIP/Double Window	32
Picture Menu Options		Swapping the PIP/Double Window	32
APC (Auto Picture Control)	19	TV Program selection for PIP	32
XD	19	Selecting an Input Signal Source for PIP/Double Window	32
Color Temperature Control	19	Moving the PIP	32
Fleshtone	20	PIP Size	32
sRGB	20	PIP Transparency	32
Manual Picture Control (Off option)	20	External Control Device Setup	33~38
Sound Menu Options		IR Codes	39~40
DASP (Digital Auto Sound Processing)	21	Troubleshooting Checklist	41
BBE	21	Maintenance	42
AVL (Auto Volume Leveler)	21	Product Specifications	42
Manual Sound Control (Off option)	22	Warranty	43~44
Stereo/SAP Broadcasts Setup	22		
Timer Menu Options			
Auto Clock Setup	23		
Manual Clock Setup	23		

Setup and Operation Checklist

Setup and Operation Checklist

(See pages 11~15 for available connection and operational setup options.)

1. Unpack TV and all accessories.
2. Connect all external video and audio equipment.
see pages 12 ~ 14.
3. Install batteries in remote control.
See page 9.
4. Turn TV on.
See page 16.
5. Turn video source equipment on.
6. Select viewing source for TV.
See page 9.
7. Fine-tune source image and sound to your personal preference or as required by source.
See pages 19 ~ 22.
8. Additional features set up
See Contents above.

Introduction

What is a Plasma Display Panel (PDP)?

A plasma display panel is the latest display technology. It is currently the best way to achieve flat panel displays with excellent image quality and large screen sizes, that are easily viewable. The PDP can be thought of as a descendant of the neon lamp and it can be also be viewed as a series of fluorescent lamps.

How does it work?

PDP is an array of cells, known as pixels, which are comprised of 3 sub pixels, corresponding to the colors red, green, and blue. Gas in a plasma state is used to react with phosphors in each sub-pixel to produce colored light (red, green, or blue). These phosphors are the same types used in Cathode Ray Tube (CRT) devices such as televisions and common computer monitors.

You get the rich, dynamic colors that you expect. Each sub-pixel is individually controlled by advanced electronics to produce over 16 million different colors. All of this means that you get perfect images that are easily viewable in a display that is less than 5 inches thick.

160° - Wide angle range of vision

Your flat panel plasma screen offers an exceptionally broad viewing angle -- over 160 degrees. This means that the display is clear and visible to viewers anywhere in the room who can see the screen.

Wide Screen

The screen of the Plasma Display is so wide that your viewing experience is as if you are in a theater.

Multimedia

Connect your plasma display to a PC and you can use it for conferencing, games, and Internet browsing. The Picture-in-Picture feature allows you to view your PC and video images simultaneously.

Versatile

The light weight and thin size makes it easy to install your plasma display in a variety of locations where conventional TVs will not fit.

The PDP Manufacturing Process: a few minute colored dots may be present on the PDP screen

The PDP (Plasma Display Panel), which is the display device of this product is composed of 0.9 to 2.2 million cells. A few cell defects will normally occur in the PDP manufacturing process. Several tiny, minute colored dots visible on the screen should be acceptable. This also occurs in other PDP manufacturers' products. The tiny dots appearing does not mean that this PDP is defective. Thus a few cell defects are not sufficient cause for the PDP to be exchanged or returned. Our production technology minimizes these cell defects during the manufacture and operation of this product.

Cooling Fan Noise (RU-50PX10/10C/10H/11/11C/11H only)

In the same way that a fan is used in a PC computer to keep the CPU (Central Processing Unit) cool, the PDP is equipped with cooling fans to cool the Monitor and improve its reliability. Therefore, a certain level of noise could occur while the fans are operating and cooling the PDP.

The fan noise doesn't have any negative effect on the PDP's efficiency or reliability. The noise from these fans is normal during the operation of this product. We hope you understand that a certain level of noise from the cooling fans is acceptable and is not sufficient cause for the PDP to be exchanged or returned.

Controls

- This is a simplified representation of front panel.
Here shown may be somewhat different from your TV.
- This manual explains the features available on the RU-42PX10 series TVs.

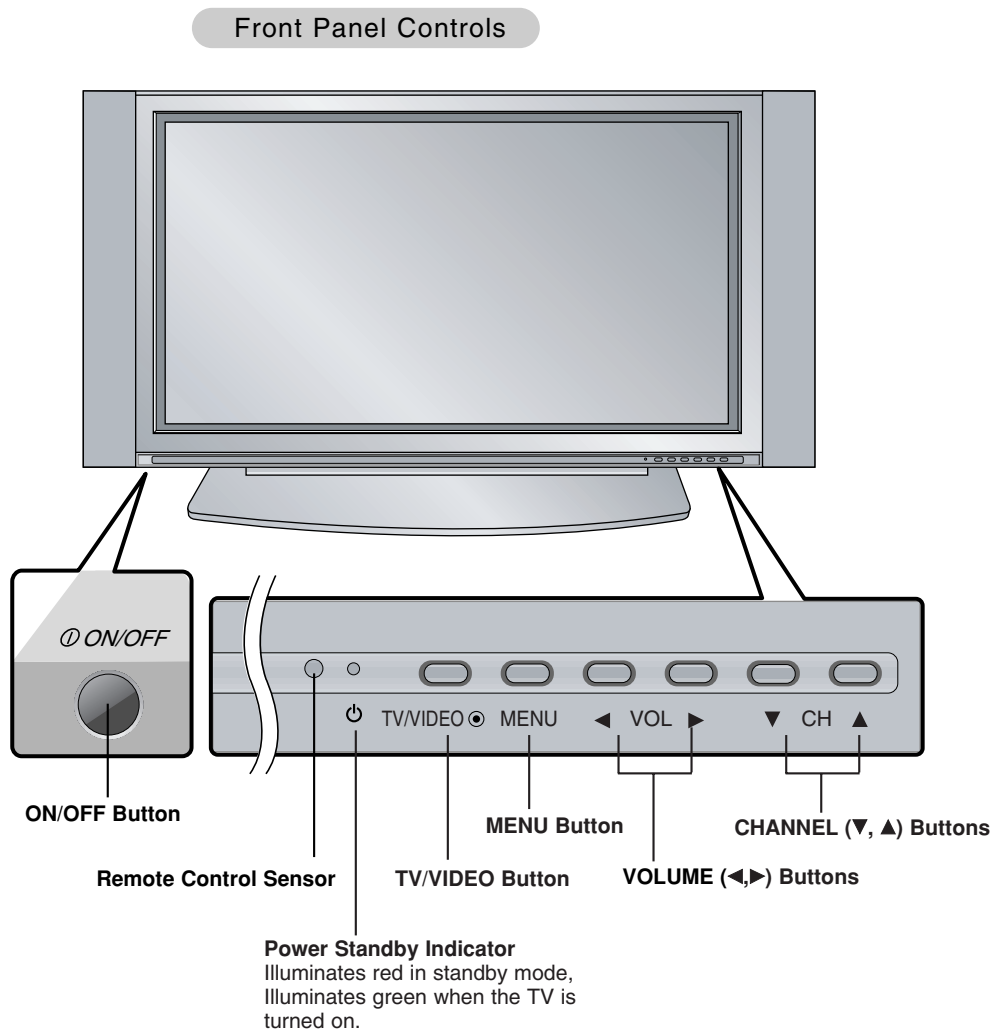

Connection Options

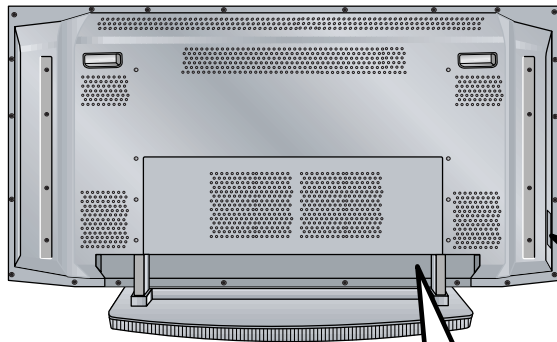

S-VIDEO Input
A connection available to provide better picture quality than the video input.

VIDEO Input
Connects the video signal from a video device.

AUDIO Input
Use to connect to hear stereo sound from an external device.

Remote Control Port
Connect your wired remote control here.

DVD/DTV Input (Component 1-2)
Connect a component video/audio device to these jacks.

Monitor Output
Connect a second TV or Monitor.

S-Video Input
Connect S-Video out from an S-VIDEO device to the S-VIDEO input.

RGB Input/Audio Input/DVI Input
Connect the monitor output connector from a PC to the appropriate input port. If you want to use RGB/DVI audio, we strongly recommend that you use the cable that has a core, or the EMI filter core along with separate cable.

Audio/Video Input 1
Connect audio/video output from an external device to these jacks.

Antenna Input
Connect cable or antenna signals to the TV, either directly or through your cable box.

Power Cord Socket
This TV operates on AC power. The voltage is indicated on the Specifications page. Never attempt to operate the TV on DC power.

RS-232C INPUT (CONTROL/SERVICE) PORT
Connect to the RS-232C port on a PC.

Remote Control Key Functions

- When using the remote control, aim it at the remote control sensor on the TV.

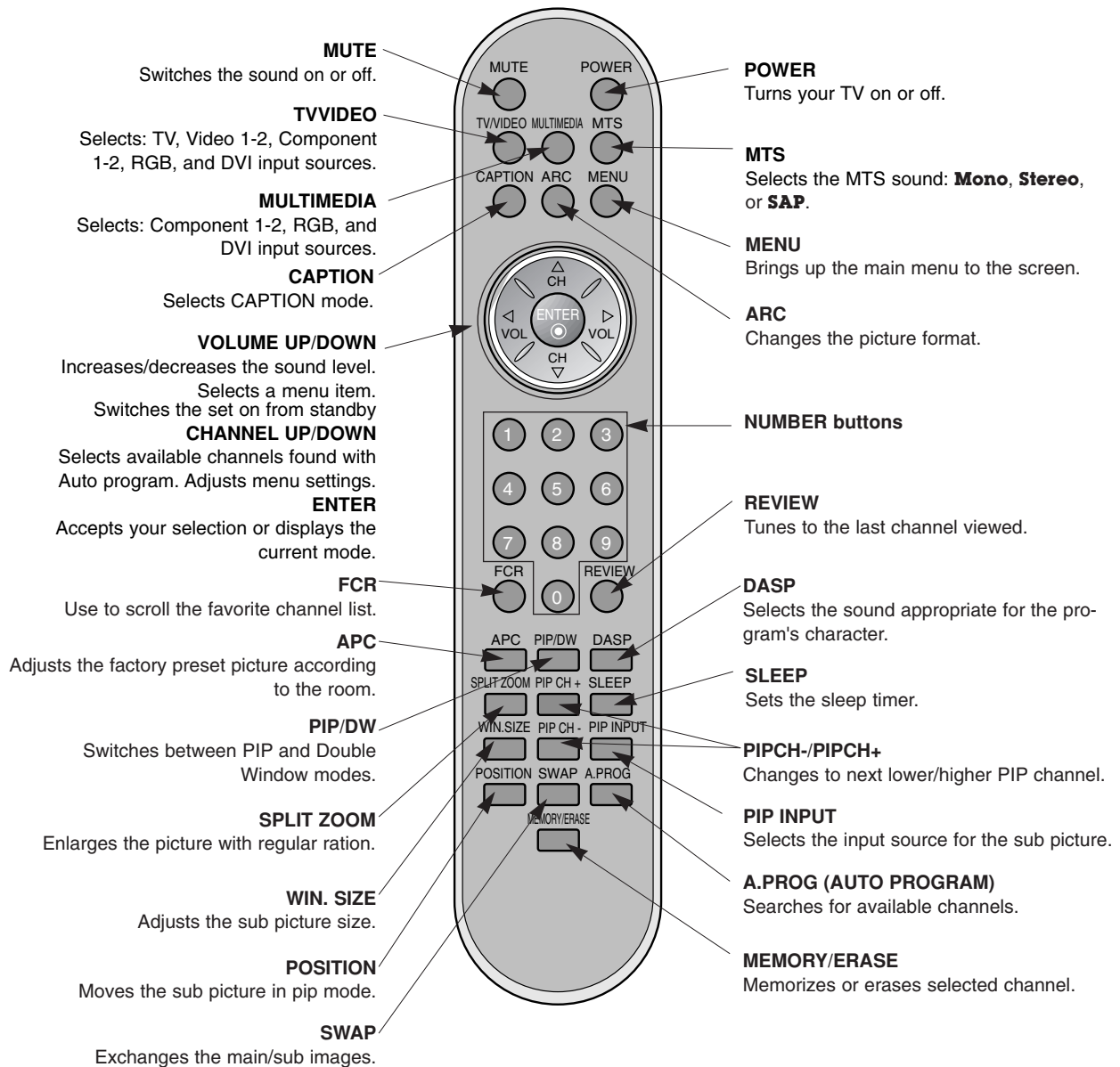

Installing Batteries

- Open the battery compartment cover on the back side and install the batteries matching correct polarity (+ with +, - with -).
- Install two 1.5V AAA batteries. Don't mix old or used batteries with new ones. Replace cover.

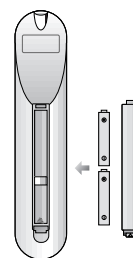

Installation

Installation Instructions

- The TV can be installed in various ways such as on a wall, or on a desktop etc.
- The TV is designed to be mounted horizontally. The speakers shown are optional.
- It is recommended that RU-42/50PX10/10C/11/11C model only be used at an altitude of less than 3281 feet (1000m) to get the best quality picture and sound.
- It is recommended that RU-42/50PX10H/11H model only be used at an altitude of less than 6561 feet (2000m) to get the best quality picture and sound.

GROUNDING

Ensure that you connect the grounding / earth wire to prevent possible electric shock. If grounding methods are not possible, have a qualified electrician install a separate circuit breaker. Do not try to ground the unit by connecting it to telephone wires, lightening rods, or gas pipes.

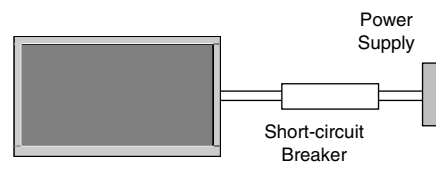

Ensure that the following accessories are included with your plasma display. If an accessory is missing, please contact the dealer where you purchased the product.

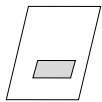

Owner's Manual

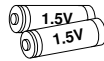

Batteries



Remote Control



Power Cord



2-Eye Bolts (option)



2-Wall brackets (option)



2-TV bracket bolts (option)



2-TV brackets
2-Wall brackets (option)

Joining the TV assembly to the wall to protect the set tumbling

- Secure the set assembly by joining it to a wall by using the TV (or Eye Bolts)/Wall brackets.
- Here shown may be somewhat different from your TV.

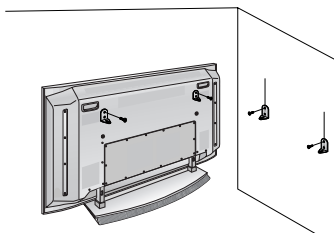

- If the set will be mounted on a desk top, insert the 2-Eye Bolts (or 2-TV bracket bolts with 2-TV brackets) and tighten them securely in the upper holes as shown. Install the wall brackets on the wall with bolts, (not supplied with the product), as shown. Match the height of the TV brackets (or Eye Bolts) and the wall brackets. Check to be sure the brackets are tightened securely.

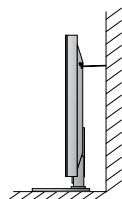

- Secure the TV assembly to the wall with strong strings or wire cables, (not supplied with the product), as shown.

External Equipment Connections

Antenna Connection

- Antenna or Cable Service without a Cable Box Connections
- For optimum picture quality, adjust antenna direction if needed.

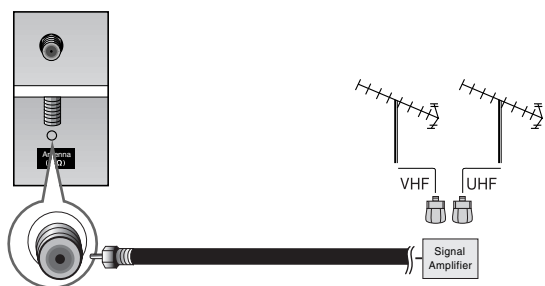
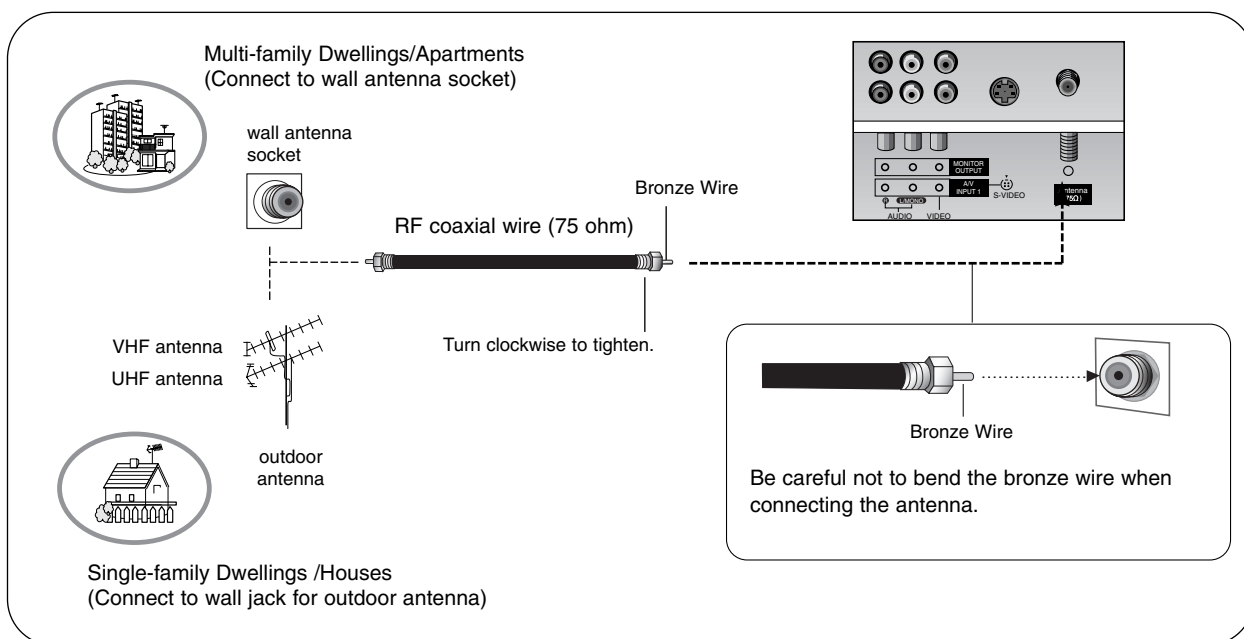

- To improve picture quality in a poor signal area, purchase and install a signal amplifier.
- If the antenna needs to be split for two TV's, install a "2-Way Signal Splitter" in the connections.
- If the antenna is not installed properly, contact your dealer for assistance.

NOTE: All cables shown are not included with the TV

VCR Setup

- To avoid picture noise (interference), leave an adequate distance between the VCR and TV
- Use the ISM Method (on the Option menu) feature to avoid having a fixed image remain on the screen for a long period of time. Typically a frozen still picture from a VCR. If the 4:3 picture format is used; the fixed images on the sides of the screen may remain visible on the screen.

Connection Option 1

Set VCR output switch to 3 or 4 and then tune TV to the same channel number.

Connection Option 2

1. Connect the audio and video cables from the VCR's output jacks to the TV input jacks, as shown in the figure.
When connecting the TV to VCR, match the jack colors (Video = yellow, Audio Left = white, and Audio Right = red).
If you connect an S-VIDEO output from VCR to the S-VIDEO input, the picture quality is improved; compared to connecting a regular VCR to the Video input.
2. Insert a video tape into the VCR and press PLAY on the VCR. (Refer to the VCR owner's manual.)
3. Select the input source by the **TV/VIDEO** button on the remote control. (If connected to A/V INPUT 1, select **Video 1** input source)

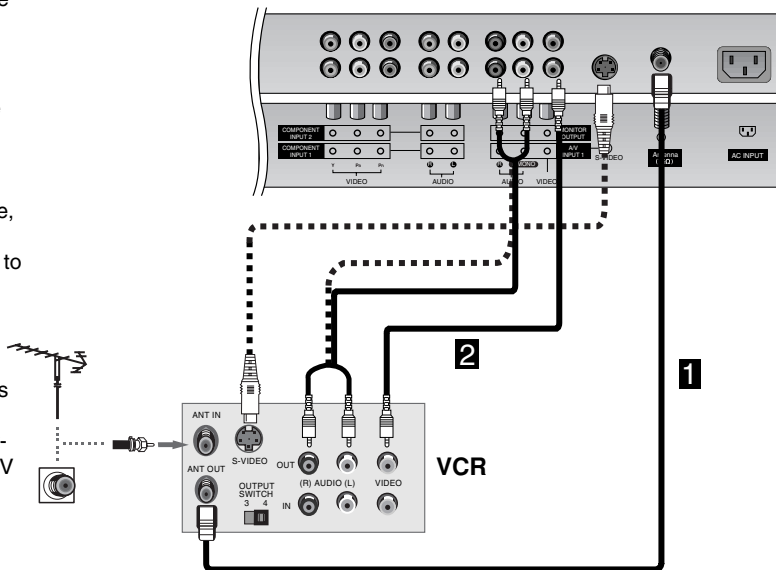

Do not connect to both Video and S-Video at the same time. In the event that you connect both Video and the S-Video cables, only the S-Video will work.)

Cable TV Setup

- After subscribing to a cable TV service from a local provider you can watch cable TV programming. The TV cannot display TV programming unless a TV tuner device or cable TV converter box is connected to the TV.
- For further information regarding cable TV service, contact your local cable TV service provider(s).

Connection Option 1

1. Select 3 or 4 with channel switch on cable box.
2. Tune the TV channel to the same selected output channel on cable box.
3. Select channels at the cable box or with the cable box remote control.

Connection Option 2

1. Connect the audio and video cables from the Cable Box's output jacks to the TV input jacks, as shown in the figure.
When connecting the TV to a Cable Box, match the jack colors (Video = yellow, Audio Left = white, and Audio Right = red).
2. Select the input source by using the **TV/VIDEO** button on the remote control. (If connected to A/V INPUT 1, select **Video 1** input source)
3. Select your desired channel with the remote control for cable box.

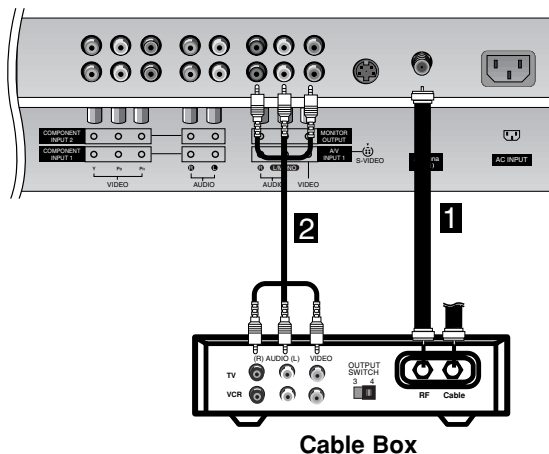

External A/V Source Setup

How to connect

Connect the audio and video cables from the external equipment's output jacks to the TV input jacks, as shown in the figure.

When connecting the TV to external equipment, match the jack colors (Video = yellow, Audio Left = white, and Audio Right = red).

How to use

1. Select the input source by using the **TV/VIDEO** button on the remote control. (If connected to A/V INPUT 1, select **Video 1** input source).
2. Operate the corresponding external equipment. Refer to external equipment operating guide.

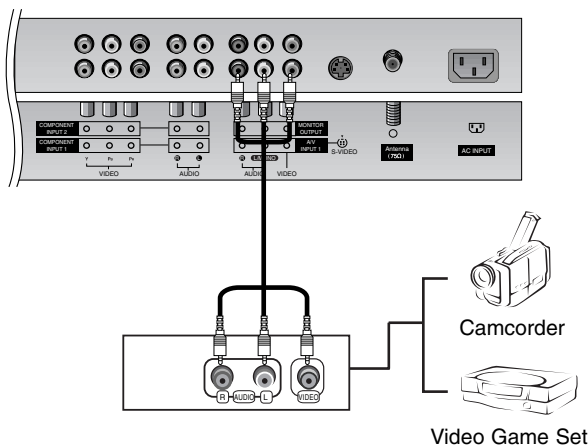

DVD Setup

How to connect

1. Connect the DVD video outputs (Y, P_B, P_R) to the COMPONENT (Y, P_B, P_R) INPUT jacks on the TV and connect the DVD audio outputs to the AUDIO INPUT jacks on the TV, as shown in the figure.
2. If your DVD only has an S-Video output jack, connect this to the S-VIDEO input on the TV and connect the DVD audio outputs to the AUDIO INPUT jacks on the TV, as shown in the figure.

NOTE: If your DVD player does not have component video output, use S-Video.

How to use

1. Turn on the DVD player, insert a DVD.
2. Use the **TV/VIDEO** or **MULTIMEDIA** button on the remote control to select **Component 1** or **Component 2**. (If connected to S-VIDEO, select the **Video 1** or **Video 2** external input source.)
3. Refer to the DVD player's manual for operating instructions.

• **Component Input ports**

To get better picture quality, connect a DVD player to the component input ports as shown below.

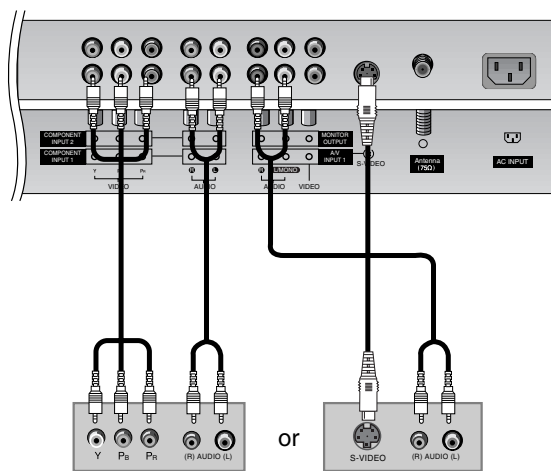

DVD

Component ports on the TV	Y	P _B	P _R
---------------------------	---	----------------	----------------

Video output ports on DVD player	Y	P _b	P _r
	Y	B-Y	R-Y
	Y	C _b	C _r
	Y	P _B	P _R

DTV Setup

- To watch digitally broadcast programs, purchase and connect a digital set-top box.

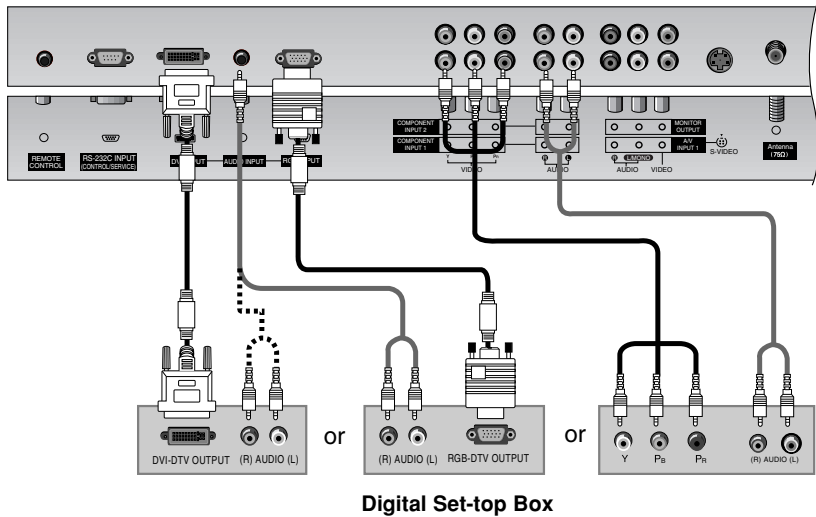

How to connect

Use the TV's COMPONENT (Y, Pb, Pr) INPUT jacks, RGB or DVI port for video connections, depending on your set-top box connections available. Then, make the corresponding audio connections.

How to use

1. Turn on the digital set-top box. (Refer to the owner's manual for the digital set-top box.)
2. Use **TV/VIDEO** or **MULTIMEDIA** on the remote control to select **Component 1**, **Component 2**, **RGB**, or **DVI** source.

Signal	Component 1/2	RGB,DVI
480i	Yes	No
480p	Yes	Yes
720p	Yes	Yes
1080i	Yes	Yes

Monitor Out Setup

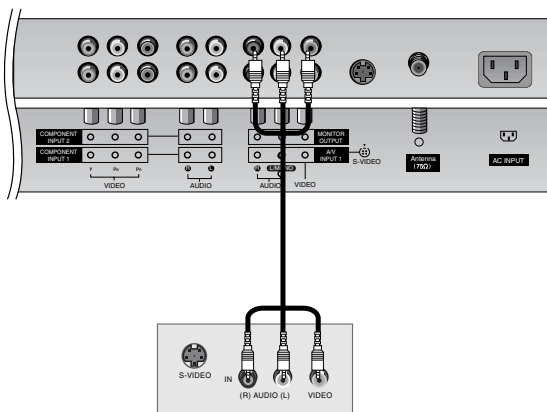

The TV has a special signal output capability which allows you to hook up a second TV or monitor.

Connect the second TV or monitor to the TV's MONITOR OUTPUT. See the Operating Manual of the second TV or monitor for further details regarding that device's input settings.

NOTE

- Component, RGB, DVI input sources cannot be used for Monitor out.

PC Setup

How to connect

1. To get the best picture quality, adjust the PC graphics card to 640x 480, 60Hz.
2. Use the TV's RGB INPUT or DVI (Digital Visual Interface) INPUT port for video connections, depending on your PC connector.
 - If the graphic card on the PC does not output analog and digital RGB simultaneously, connect only one of either RGB INPUT or DVI INPUT to display the PC on the TV.
 - If the graphic card on the PC does output analog and digital RGB simultaneously, set the TV to either RGB or DVI; (the other mode is set to Plug and Play automatically by the TV.)
3. Then, make the corresponding audio connection. If using a sound card, adjust the PC sound as required.

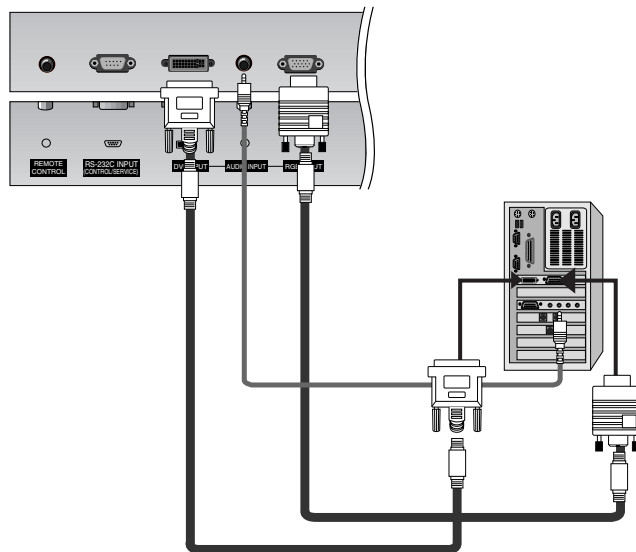

How to use

1. Turn on the PC and the TV.
2. Turn on the display by pressing the POWER button on the TV's remote control.
3. Use **TV/VIDEO** or **MULTIMEDIA** on the remote control to select **RGB**, or **DVI** source.
4. Check the image on your TV. There may be noise associated with the resolution, vertical pattern, contrast or brightness in PC mode. If noise is present, change the PC mode to another resolution, change the refresh rate to another rate or adjust the brightness and contrast on the menu until the picture is clear. If the refresh rate of the PC graphic card can not be changed, change the PC graphic card or consult the manufacturer of the PC graphic card.

- NOTES:**
- Use a DVI cable.
 - Avoid keeping a fixed image on the TV's screen for a long period of time. The fixed image may become permanently imprinted on the screen. Use the Orbiter screen saver when possible.
 - The synchronization input form for Horizontal and Vertical frequencies is separate.

Monitor Display Specifications (RGB / DVI Mode)

Resolution	Horizontal Frequency(KHz)	Vertical Frequency(Hz)	Resolution	Horizontal Frequency(KHz)	Vertical Frequency(Hz)
640x350	31.468	70.09	800x600	35.156	56.25
	37.861	85.08		37.879	60.31
720x400	31.469	70.08		48.077	72.18
	37.927	85.03		46.875	75.00
640x480	31.469	59.94		53.674	85.06
	35.000	66.66		832x624	49.725
	37.861	72.80	1024x768	48.363	60.00
	37.500	75.00		56.476	70.06
43.269	85.00	60.023		75.02	
848x480	31.500	60.00	68.677	85.00	
	37.799	70.00	1152x864	54.348	60.05
39.375	75.00	63.995		70.01	
852x480	31.500	60.00		67.500	75.00
	37.799	70.00	77.487	85.00	
	39.375	75.00	1152x870	68.681	75.06
			1280x960	60.023	60.02
			1280x1024	63.981	60.02

→ RGB Mode Only

Operation

Turning the TV On

* In this manual, the OSD (On Screen Display) may be different from your TV's because it is just an example to help you with the TV operation.

Turning on the TV just after installation

1. Connect power cord correctly.
2. Press the **⓪ ON/OFF** button on the TV. At this moment, the TV is switched to standby mode. Press the **TV/VIDEO, CH (▲ / ▼)** button on the TV or press the **POWER, TV/VIDEO, MULTIMEDIA, Number (0 ~ 9)** button on the remote control and then the TV will turn on.

Turning on the TV (power cord is still connected)

1. If the TV was turned off with the **⓪ ON/OFF** button on the TV
 - Press the **⓪ ON/OFF** button on the TV to turn the TV on.
2. If the TV was turned off with the remote control and then the **⓪ ON/OFF** button on the TV
 - Press the **⓪ ON/OFF** button on the TV and then press the **TV/VIDEO, CH (▲ / ▼)** button on the TV or press the **POWER, TV/VIDEO, MULTIMEDIA, Number (0 ~ 9)** button on the remote control to turn the TV on.

NOTE

- If you intend to be away on vacation, disconnect the power plug from the wall power outlet.

Menu Language Selection

- The menus can be shown on the screen in the selected language. First select your language.

1. Press the **MENU** button and then use **▲ / ▼** button to select the **SPECIAL** menu.
2. Press the **▶** button and then use **▲ / ▼** button to select **Language**.
3. Press the **▶** button and then use **▲ / ▼** button to select your desired language.
From this point on, the on-screen menus will be shown in the language of your choice.
4. Press the **ENTER** button to save.

Channel Menu Options

Auto Program should be used to memorize all the active channels in your area before you are able to use the TV.

There are two ways of storing channels in the TV's memory. You can use either.

One is called AUTO PROGRAM and the other is called MANUAL PROGRAM.

In AUTO PROGRAM mode, the TV will memorize the channels in ascending numerical order. If there are additional channels you want to add or delete, you can manually add or delete those channels with Manual Program.

Auto Program: Channel Search

- Redo Auto Program if the Plasma Display is ever moved to another location.
- Auto Program will search for channels only through the ANT IN jack.
- If channels numbers for broadcast over-the air TV and cable TV are duplicated where different channels have the same number, press the same number buttons again to toggle between:



(For example, press 17 to go to the channel, press 17 again to go to the duplicated channel.)

1. Press the **A.PROG** button and then press the **▶** button. AUTO PROGRAM starts the channel search. If you want to stop auto programming, press the **ENTER** button. Only the channels found up to that time are memorized.
 - You can also select the **Auto program** option and do a channel search in the **CHANNEL** menu.

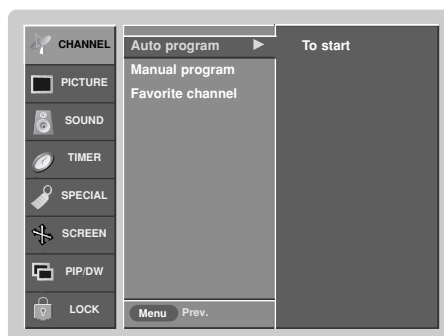

Manual Program: Adding/Deleting Channels

- You can add or delete channels from the channel scan manually.
1. Use the **▲ / ▼** or **NUMBER** buttons to select the channel number you want to add or delete.
 2. Press the **MEMORY/ERASE** button.
 3. Use the **MEMORY/ERASE** button to select **Memory** or **Erase**.
 4. Press the **ENTER** button.
 - You can also do **Manual program** with the **CHANNEL** menu.

Fine Tuning Adjustment

- Use this function to correct the picture's instability and condition if it is poor.
1. Press the **MENU** button and then use **▲ / ▼** button to select the **CHANNEL** menu.
 2. Press the **▶** button and then use **▲ / ▼** button to select **Manual program**.
 3. Press the **▶** button and then use **▲ / ▼** button to select **Fine**.
 4. Use the **◀ / ▶** button to adjust the picture to your preference.
 5. Press the **ENTER** button to save.

Notes

- To remove fine tuning from a channel, reprogram the finely-tuned channel with Auto program or Manual Program.
- If a finely-tuned channel is memorized, the color of the channel number changes to yellow.



Channel Menu Options continued

Signal Reception Booster

- If TV signal reception is poor because you are in a fringe area, set Booster to On. If the picture condition is good, set Booster to Off.
- Adjustments for one channel don't affect the adjustment for other channels. Set booster to on or off for each channel separately.

1. Press the **MENU** button and then use ▲ / ▼ button to select the **CHANNEL** menu.
2. Press the ► button and then use ▲ / ▼ button to select **Manual program**.
3. Press the ► button and then use ▲ / ▼ button to select **Booster**.
4. Use ◀ / ▶ button to select **On** or **Off**.
5. Press the **ENTER** button to save.



Favorite Channels Setup

- Favorite Channels is a convenient feature that lets you quickly scan up to 8 channels of your choice without having to wait for the TV to scan through all the in-between channels.

1. Press the **MENU** button and then use ▲ / ▼ button to select the **CHANNEL** menu.
2. Press the ► button and then use ▲ / ▼ button to select **Favorite channel**.
3. Press the ► button and then use ▲ / ▼ button to select the first favorite channel position.
4. Use the ◀ / ▶ button to set the desired channel number for first favorite channel.
5. Repeat steps 3 to 4 to memorize other favorite channels.
6. Press the **ENTER** button to save.

- To tune to a favorite channel, press the **FCR** (Favorite Channel Review) button repeatedly. The eight favorite channels appear on the screen in numerical order.

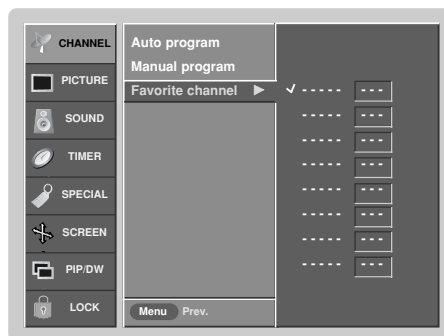

Picture Menu Options

APC (Auto Picture Control)

- APC adjusts the TV to the best picture appearance.
- If adjusting picture options (contrast, brightness, color, sharpness, or tint) manually, APC automatically changes to **Off**.

1. Press the **APC** button repeatedly to select the picture appearance setup option as shown below.



- You can also adjust **APC** in the **PICTURE** menu.
- **Daylight**, **Optimum**, and **Night time** settings are preset for good picture quality at the factory and cannot be changed.

XD

- XD is LG Electronic's unique picture improving technology to display a real HD source through an advanced digital signal processing algorithm.
- When selecting APC options (Daylight, Optimum and Night time), XD is automatically change to On.

1. Press the **MENU** button and then use **▲ / ▼** button to select the **PICTURE** menu.
2. Press the **▶** button and then use **▲ / ▼** button to select **XD**.
3. Press the **▶** button and then use **▲ / ▼** button to set **On** or **Off**.
4. Press the **ENTER** button to save.

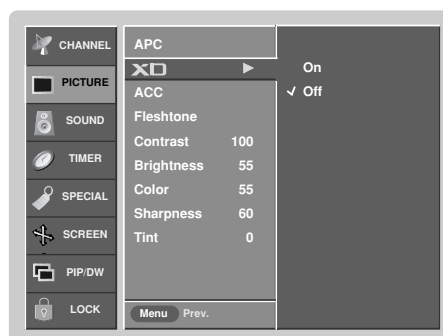

Color Temperature Control

Auto Color Temperature Control

- To initialize values (reset to default settings), select the **Normal** option.

1. Press the **MENU** button and then use **▲ / ▼** button to select the **PICTURE** menu.
2. Press the **▶** button and then use **▲ / ▼** button to select **ACC**.
3. Press the **▶** button and then use **▲ / ▼** button to select either: **Cool** (Preset), **Normal** (Default), or **Warm** (Preset).
4. Press the **ENTER** button to save.

Manual Color Temperature Control (ACC set to Off option)

- You can adjust red, green, or blue to any color temperature you prefer.

1. Press the **MENU** button and then use **▲ / ▼** button to select the **PICTURE** menu.
2. Press the **▶** button and then use **▲ / ▼** button to select **ACC**.
3. Press the **▶** button and then use **▲ / ▼** button to select **Off**.
4. Press the **▶** button and then use **▲ / ▼** button to select **Red**, **Green** or **Blue**.
5. Use the **◀ / ▶** button to make appropriate adjustments.

- The adjustment range of **Red**, **Green**, and **Blue** is -30 ~ +30.

6. Press the **ENTER** button to save.

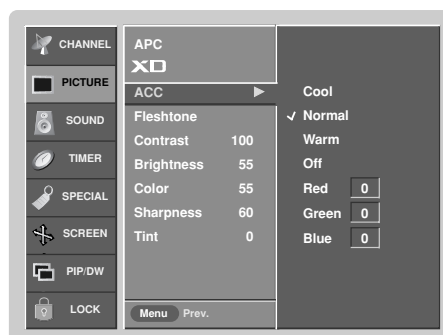

Picture Menu Options continued

Fleshtone (TV, Video1-2, Component 1-2, RGB-DTV, and DVI-DTV Mode only)

- Use Fleshtone to select the desired skin color option.

1. Press the **MENU** button and then use **▲ / ▼** button to select the **PICTURE** menu.
2. Press the **▶** button and then use **▲ / ▼** button to select **Fleshtone**.
3. Press the **▶** button and then use **◀ / ▶** button to make appropriate adjustments.
 - The adjustment range is 0 ~ 3.
4. Press the **ENTER** button to save.

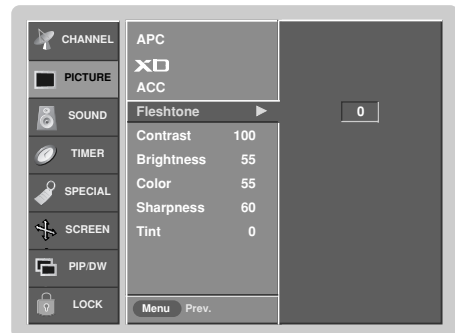

sRGB (only RGB-PC, DVI-PC Modes)

- If the TV is connected to external equipment using sRGB, set sRGB to On to adjust for the color difference.

1. Press the **MENU** button and then use **▲ / ▼** button to select the **PICTURE** menu.
2. Press the **▶** button and then use **▲ / ▼** button to select **sRGB**.
3. Press the **▶** button and then use **▲ / ▼** button to select **On** or **Off**.
4. Press the **ENTER** button to save.



Manual Picture Control (APC set to set to Off option)

- You can adjust picture contrast, brightness, color, sharpness, and tint options to the levels you prefer.

1. Press the **MENU** button and then use **▲ / ▼** button to select the **PICTURE** menu.
2. Press the **▶** button and then use **▲ / ▼** button to select the desired picture option (**Contrast, Brightness, Color, Sharpness, Tint**).
3. Press the **▶** button and then use **◀ / ▶** button to make appropriate adjustments.
4. Press the **ENTER** button to save.





Sound Menu Options

DASP (Digital Auto Sound Processing)

- This function lets you enjoy the best sound without any special adjustment because the TV has the appropriate sound options based on the program content.
- If you adjust sound options (Treble and Bass) manually, DASP automatically changes to **Off**.

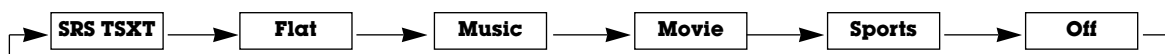
1. Press the **DASP** button repeatedly to select the appropriate sound setup as shown below.



- You can also adjust **DASP** in the **SOUND** menu.
- **SRS TSXT**, **Flat**, **Music**, **Movie**, and **Sports** are preset for good sound quality at the factory and cannot be changed.
-  is a trademark of SRS Labs, Inc.
- TruSurround XT technology is incorporated under license from SRS Labs, Inc.

BBE

- BBE High Definition Sound restores clarity and presence for better speech intelligibility and music realism.

1. Press the **MENU** button and then use **▲** / **▼** button to select the **SOUND** menu.
2. Press the **▶** button and then use **▲** / **▼** button to select **BBE**.
3. Press the **▶** button and then use **▲** / **▼** button to select **On** or **Off**.
4. Press the **ENTER** button to save.

- **BBE**. Manufactured under license from BBE Sound, Inc.
- Treble, Bass or BBE aren't suitable for **SRS TSXT** mode.

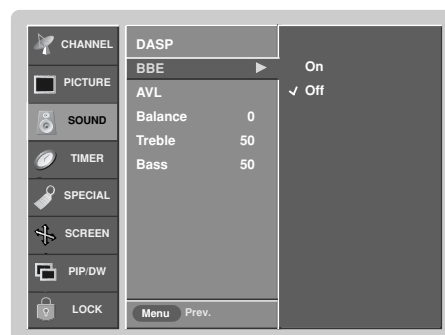

AVL (Auto Volume Leveler)

- AVL maintains an equal sound level; even if you change channels.

1. Press the **MENU** button and then use **▲** / **▼** button to select the **SOUND** menu.
2. Press the **▶** button and then use **▲** / **▼** button to select **AVL**.
3. Press the **▶** button and then use **▲** / **▼** button to select **On** or **Off**.
4. Press the **ENTER** button to save.

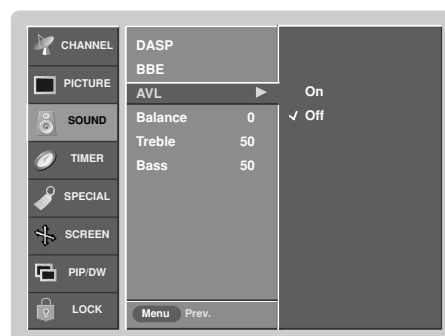

Sound Menu Options continued

Manual Sound Control (**DASP off** option and balance)

- You can adjust sound options Balance, Treble, and Bass to the levels you prefer.

1. Press the **MENU** button and then use **▲ / ▼** button to select the **SOUND** menu.
2. Press the **▶** button and then use **▲ / ▼** button to select the desired sound option (**Balance, Treble, Bass**).
3. Press the **▶** button and then use **◀ / ▶** button to make appropriate adjustments.
4. Press the **ENTER** button to save.

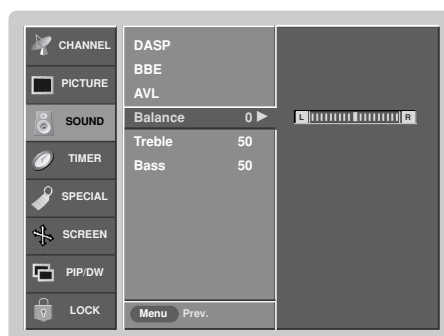

Stereo/SAP Broadcasts Setup

- The TV can receive MTS stereo programs and any SAP (Secondary Audio Program) that accompanies the stereo program; if the broadcaster transmits one additional sound signal in addition to the original one.
- Mono: The primary language is heard from left and right speakers. Signal mode is mono.
- Stereo: The primary language is heard from left and right speakers. Signal mode is stereo.
- SAP: The secondary language is heard from left and right speakers in mono sound.

1. Press the **MTS** button repeatedly.



- Select mono sound mode if the signal is not clear or in poor signal reception areas.
- **Stereo, SAP** modes are available only if included on the broadcast signal.

Timer Menu Options

Auto Clock Setup

- Set the time automatically through the PBS broadcast signal.
- The PBS channel signal includes information for the current time.
- Set the clock manually, if the current time is set incorrectly programmed by the auto clock function.

1. Press the **MENU** button and then use **▲ / ▼** button to select the **TIMER** menu.
2. Press the **▶** button and then use **▲ / ▼** button to select **Clock**.
3. Press the **▶** button and then use **▲ / ▼** button to select **Auto**.
4. Press the **▶** button and then use **▲ / ▼** button to select the time zone for your viewing area. Your choices are: **Auto**, **E.S.T.** (Eastern Standard Time), **C.S.T.** (Central Standard Time), **M.S.T.** (Mountain Standard Time), **P.S.T.** (Pacific Standard Time), **Alaska**, and **Hawaii**.
5. Press the **▶** button and then use **▲ / ▼** button to set **PBS Channel**.
6. Press the **▶** button and then use **▲ / ▼** button to set Daylight Saving Time **Auto**, **On** or **Off**, depending on whether or not your viewing area observes Daylight Saving Time.
7. Press the **ENTER** button to save.

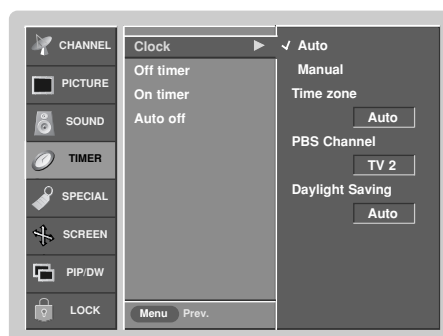

Manual Clock Setup

- If current time setting is wrong, reset the clock manually.

1. Press the **MENU** button and then use **▲ / ▼** button to select the **TIMER** menu.
2. Press the **▶** button and then use **▲ / ▼** button to select **Clock**.
3. Press the **▶** button and then use **▲ / ▼** button to select **Manual**.
4. Press the **▶** button and then use **▲ / ▼** button to set the hour.
5. Press the **▶** button and then use **▲ / ▼** button to set the minutes.
6. Press the **ENTER** button to save.

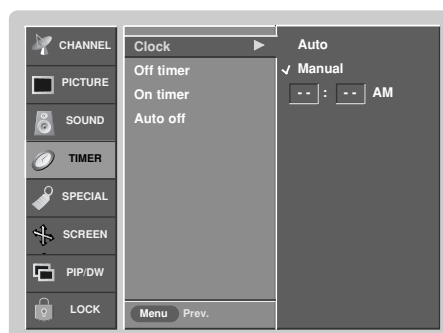

On/Off Timer Setup

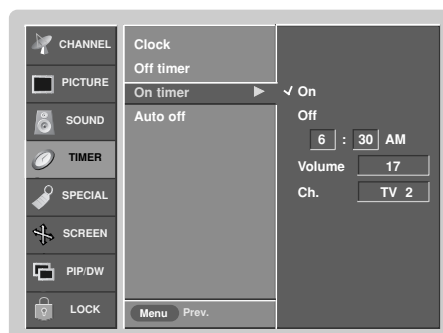

- Timer function operates only if current time has been set.
- Off-Timer function overrides On-Timer function if they are set both set to the same time.
- The TV must be in standby mode for the On-Timer to work.
- If you do not press any button within 2 hours after the TV turns on with the On Timer function, the TV will automatically revert to standby mode.

1. Press the **MENU** button and then use **▲ / ▼** button to select the **TIMER** menu.
2. Press the **▶** button and then use **▲ / ▼** button to select **Off timer** or **On timer**.
3. Press the **▶** button and then use **▲ / ▼** button to select **On**.
 - To cancel **On/Off timer** function, select **Off**.
4. Press the **▶** button and then use **▲ / ▼** button to set the hour.
5. Press the **▶** button and then use **▲ / ▼** button to set the minutes.
6. **For only On timer function**
 - Press the **▶** button and then use **▲ / ▼** button to set the sound level at turn-on.
 - Press the **▶** button and then use **▲ / ▼** button to select the channel at turn-on.
7. Press the **ENTER** button to save.



Timer Menu Options continued

Sleep Timer

- The Sleep Timer turns the TV off at the preset time. Note that this setting is cleared when the TV is turned off.
1. Press the **SLEEP** button repeatedly to select the number of preset minutes. First the  **Min** option appears on the screen, followed by the following sleep timer turn off times:
10, 20, 30, 60, 90, 120, 180, and 240 minutes.
 2. When the number of minutes you want is displayed on the screen, press the **ENTER** button. The timer begins to count down from the number of minutes selected.
 3. To check the remaining minutes before the TV turns off, press the **SLEEP** button once.
 4. To cancel the Sleep Timer, press the **SLEEP** button repeatedly until  **Min** appears.

Auto Off

- If set to on and there is no input signal, the TV turns off automatically after 10 minutes.
1. Press the **MENU** button and then use **▲ / ▼** button to select the **TIMER** menu.
 2. Press the **▶** button and then use **▲ / ▼** button to select **Auto off**.
 3. Press the **▶** button and then use **▲ / ▼** button to select **On** or **Off**.
 4. Press the **ENTER** button to save.

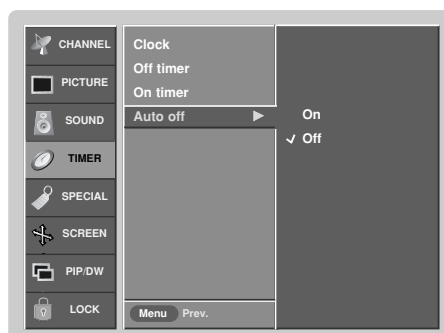

Special Menu Options

Key Lock

- The TV can be set up so that it can only be used with the remote control.
- This feature can be used to prevent unauthorized viewing by locking out the front panel controls.
- This TV is programmed to remember which option it was last set to even if you turn the TV off.

1. Press the **MENU** button and then use **▲ / ▼** button to select the **SPECIAL** menu.
2. Press the **▶** button and then use **▲ / ▼** button to select **Key lock**.
3. Press the **▶** button and then use **▲ / ▼** button to select **On** or **Off**.
4. Press the **ENTER** button to save.

- With the Key lock On, the display '▲ Key lock' appears on the screen if any button on the front panel is pressed.

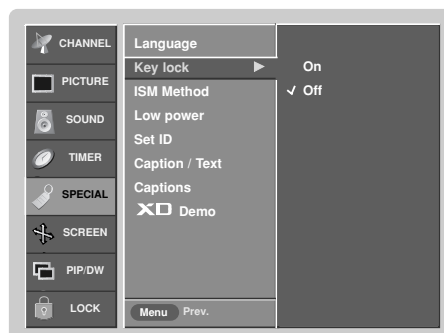

ISM (Image Sticking Minimization) Method

- A frozen still picture from a PC/video game displayed on the screen for prolonged periods will result in a ghost image remaining even when you change the image. Avoid allowing a fixed image to remain on the TV's screen for a long period of time.

1. Press the **MENU** button and then use **▲ / ▼** button to select the **SPECIAL** menu.
2. Press the **▶** button and then use **▲ / ▼** button to select **ISM Method**.
3. Press the **▶** button and then use **▲ / ▼** button to select either **Normal**, **White wash**, **Orbiter** or **Inversion**.

• Normal

If image sticking is never a problem, ISM is not necessary - set to Normal.

• White wash

White Wash removes permanent images from the screen. Note: An excessive permanent image may be impossible to clear entirely with White Wash. To return to normal viewing, press any button.

• Orbiter

Orbiter may help prevent ghost images. However, it is best not to allow any fixed image to remain on the screen. To avoid a permanent image on the screen, the image will move every 2 minutes: Right → Right → Downside → Downside → Left → Left → Upside → Upside.

• Inversion

Inversion will automatically invert the TV panel color every 30 minutes.

4. Press the **ENTER** button to save.

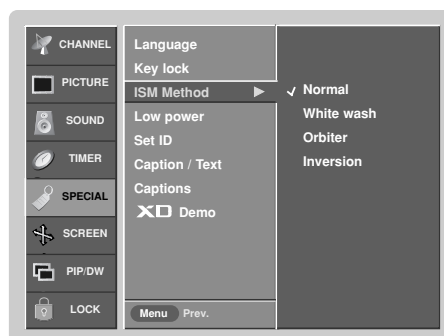

Special Menu Options continued

Low Power

- Low power reduces the plasma display power consumption.

1. Press the **MENU** button and then use **▲ / ▼** button to select the **SPECIAL** menu.
2. Press the **▶** button and then use **▲ / ▼** button to select **Low power**.
3. Press the **▶** button and then use **▲ / ▼** button to select **On** or **Off**.
 - When you select **On**, the screen darkens.
4. Press the **ENTER** button to save.

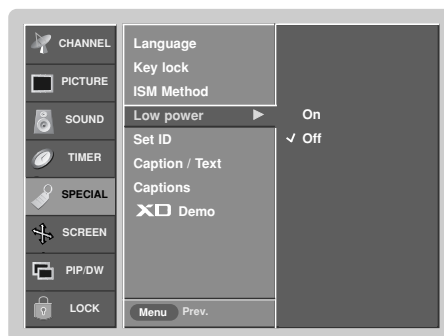

XD Demo

- Use it to see the difference between XD Demo on and XD Demo off.

1. Press the **MENU** button and then use **▲ / ▼** button to select the **SPECIAL** menu.
2. Press the **▶** button and then use **▲ / ▼** button to select **XD Demo**.
3. Press the **▶** button to begin **XD Demo**.
4. Press the **MENU** button to stop **XD Demo**.

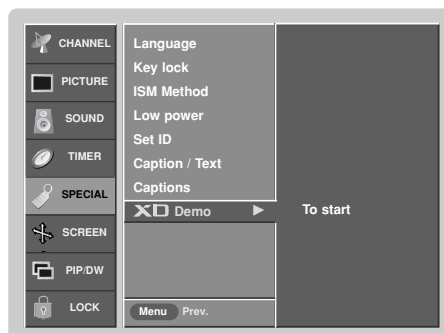

Closed Captions

Closed captioning is a process which converts the audio portion of a television program into written words which then appear as subtitles on the television screen. Closed captions allow viewers to read the dialogue and narration of television programs.

Using Closed Captions

Captions are the subtitles of the dialogue and narration of television programs. For prerecorded programs, program dialogue can be arranged into captions in advance. It's possible to caption a live program by using a process called real-time captioning, which creates captions instantly. Real-time captioning is normally done by professional reporters using a machine shorthand system and computer for translation into English.

Captioning is an effective system for the hearing-impaired, and it can also aid in teaching language skills.

- The picture at left shows a typical caption.

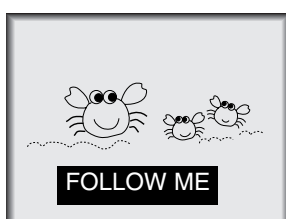

Caption Tips

- Not all TV broadcasts include closed caption signals.
- Sometimes TV stations broadcast four different caption signals on the same channel. By selecting **CC 1 to CC 2**, you can choose which signal you view. **CC 1** is usually the signal with the captions, while **Another mode** might show demonstration or programming information.
- Your TV might not receive caption signals normally in the following situations.

1. Poor reception conditions are encountered:



• IGNITION:

Picture may flutter, drift, suffer from black spots, or horizontal streaking. Usually caused by interference from automobile ignition systems, neon lamps, electrical drills, and other electrical appliances.



• GHOSTS:

Ghosts are caused when the TV signal splits and follows two paths. One is the direct path and the other is reflected off tall buildings, hills or other objects. Changing the direction or position of the antenna may improve reception.



• SNOW:

If your receiver is located at the weak, fringe area of a TV signal, your picture may be marred by small dots. It may be necessary to install a special antenna to improve the picture.

2. An old, bad, or illegally recorded tape is being played.
3. Strong, random signals from a car or airplane interfere with the TV signal.
4. The signal from the antenna is weak.
5. The program wasn't captioned when it was produced, transmitted, or taped.

Captions

1. Use the **CAPTION** button repeatedly to select Caption **Off**, **EZ Mute**, or **On**.
 - **EZ Mute** shows the selected captions option (if available on program) when the TV sound is muted.
2. Press the **ENTER** button to save.

Caption/Text

1. Press the **MENU** button and then use **▲ / ▼** button to select the **SPECIAL** menu.
2. Press the **▶** button and then use **▲ / ▼** button to select **Caption / Text**.
3. Press the **▶** button and then use **▲ / ▼** button to select caption: **CC1**, **CC2**, **CC3**, **CC4**, **Text1**, **Text2**, **Text3**, or **Text4**.

• CAPTION

The term for the words that scroll across the bottom of the TV screen; usually the audio portion of the program provided for the hearing impaired.

• TEXT

The term for the words that appear in a large black frame and almost cover the entire screen; usually messages provided by the broadcaster.

4. Press the **ENTER** button to save.

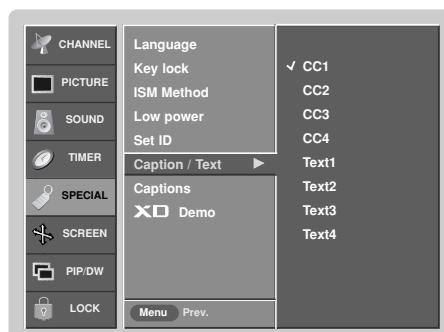

Screen Menu Options

Auto Adjustment

- RGB (PC) mode only; This function doesn't work for RGB-DTV mode.
- Automatically adjusts picture position and minimizes image shaking.
- After adjustment, if the image is still not correct, your TV is functioning properly but needs further adjustment.
- The **Auto config.** and **Manual config.** are not active in DVI mode.

1. Press the **MENU** button and then use **▲** / **▼** button to select the **SCREEN** menu.
2. Press the **▶** button and then use **▲** / **▼** button to select **Auto config.**
3. Press the **▶** button to run Auto configure.
 - When **Auto config.** has finished, **OK** will be shown on screen.
 - If the position of the image is still not correct, try Auto adjustment again.
4. In RGB (PC) mode, if the image needs to be adjusted more after using **Auto config.**, you can make further adjustments with the **Manual config.** option.

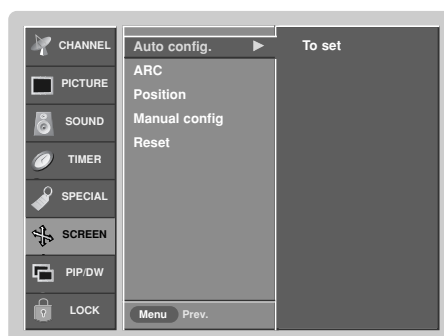

Setting Picture Format

- Caution: If a 4:3 fixed image is on the screen for a long time, it may remain visible.
- Set every aspect ratio for TV, Video, Component 480i sources.
- Use 4:3, or 16:9 for other RGB-PC and DVI-PC sources.
- Horizon is not available for Component (480p,720p,1080i), DTV (480p,720p,1080i) sources.

1. Press the **ARC** button repeatedly to select the desired picture format. You can also adjust **ARC** in the **SCREEN** menu.

• 4:3

Choose **4:3** when you want to view a picture with an original 4:3 aspect ratio, with black bars appearing at both the left and right sides.

• 16:9

Choose **16:9** when you want to adjust the picture horizontally, in a linear proportion to fill the entire screen.

• Horizon

Choose **Horizon** when you want to adjust the picture in a non-linear proportion, that is, more enlarged at both sides, to create a spectacular view.

• Zoom

- Choose **Zoom** when you want to view the picture without any alteration. However, the top and bottom portions of the picture will be cropped.

Screen Position

- This function works in the following modes: RGB-PC, RGB-DTV (480p,720p,1080i), DVI-DTV (480p,720p,1080i), COMPONENT (480p,720p,1080i).

1. Press the **MENU** button and then use **▲** / **▼** button to select the **SCREEN** menu.
2. Press the **▶** button and then use **▲** / **▼** button to select **Position**.
3. Press the **▶** button and then use **▲** / **▼** / **◀** / **▶** button to adjust the position.
4. Press the **ENTER** button to save.

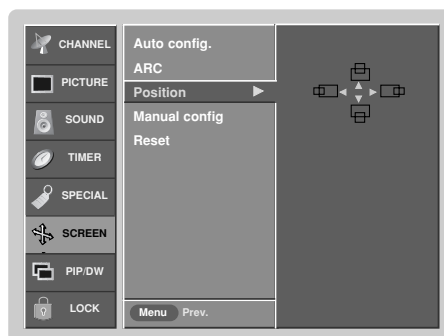

Manual Configure (RGB-PC mode only)

- If the image still isn't clear after auto adjustment and especially if characters are still jittery, adjust the picture Phase manually.
- To correct the screen size, adjust **Clock**.

1. Press the **MENU** button and then use **▲ / ▼** button to select the **SCREEN** menu.
2. Press the **▶** button and then use **▲ / ▼** button to select **Manual config.**
3. Press the **▶** button and then use **▲ / ▼** button to select **Phase** or **Clock**.
4. Use the **◀ / ▶** button to make appropriate adjustments.
 - The **Phase** adjustment range is 0 ~ 30.
 - The **Clock** adjustment range is -127 ~ +128.
5. Press the **ENTER** button to save.

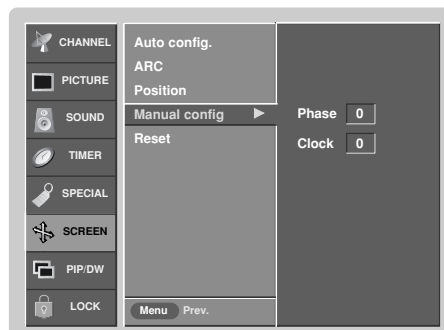

Selecting VGA mode (RGB-PC mode only)

- To see a normal picture, match the resolution of RGB mode and selection of VGA mode.

1. Press the **MENU** button and then use **▲ / ▼** button to select the **SCREEN** menu.
2. Press the **▶** button and then use **▲ / ▼** button to select **VGA Mode**.
3. Press the **▶** button and then use **▲ / ▼** button to select the desired VGA resolution.
4. Press the **ENTER** button to save.

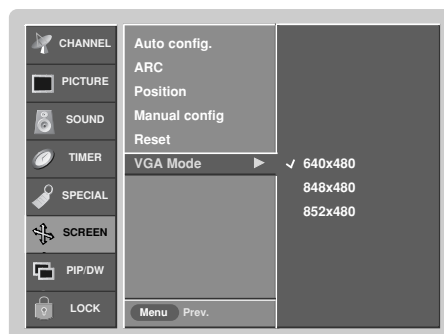

Screen Adjustments (TV, Video1-2 and Component 480i mode only)

- Use this function to correct jittering or picture instability while viewing a video tape.

1. Press the **MENU** button and then use **▲ / ▼** button to select the **SCREEN** menu.
2. Press the **▶** button and then use **▲ / ▼** button to select **Screen adj.**
3. Press the **▶** button and then use **▲ / ▼** button to select **TV** or **VCR**.
 - Select the **VCR** option if watching a VCR.
 - Select the **TV** option for other equipment. (Except VCR)
4. Press the **ENTER** button to save.

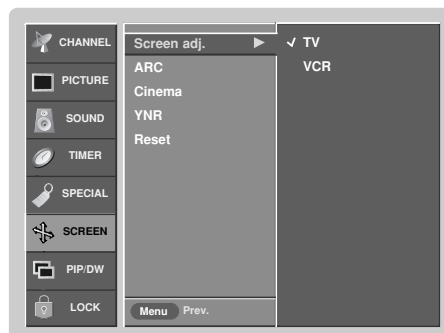

Cinema Mode Setup (TV, Video1-2 and Component 480i mode only)

- Sets up the TV for the best picture appearance for viewing movies.

1. Press the **MENU** button and then use **▲ / ▼** button to select the **SPECIAL** menu.
2. Press the **▶** button and then use **▲ / ▼** button to select **Cinema**.
3. Press the **▶** button and then use **▲ / ▼** button to select **On** or **Off**.
4. Press the **ENTER** button to save.

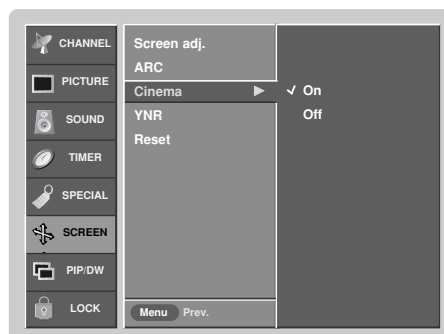

Screen Menu Options continued

Luminance Noise Reduction (TV, Video 1-2 and Component 480i modes only)

- Use YNR to reduce the picture noise that may appear on the screen.

1. Press the **MENU** button and then use **▲ / ▼** button to select the **SCREEN** menu.
2. Press the **▶** button and then use **▲ / ▼** button to select **YNR**.
3. Press the **▶** button and then use **▲ / ▼** button to select **On** or **Off**.
4. Press the **ENTER** button to save.

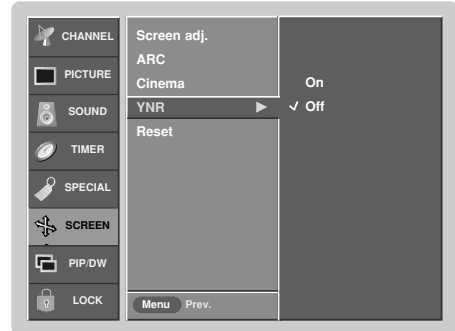

Initializing (Reset to original factory value)

- Reset is unique to each function: Manual config., Position, Split zoom, PIP position and sub picture size for double window.
 - Use the Reset option to initialize the adjusted settings.

1. Press the **MENU** button and then use **▲ / ▼** button to select the **SCREEN** menu.
2. Press the **▶** button and then use **▲ / ▼** button to select **Reset**.
3. Press the **▶** button.
 - You can initialize Position, Split zoom, PIP Transparency, PIP position, PIP size and sub picture size for double window.



Split Zoom

- Enlarges the picture in correct proportions.
 - Split Zoom can be used for all input sources.
 - In 2-Split Zoom mode, you can only move the image up or down.
 - If an image is enlarged, a section can be viewed without using Split Zoom.

1. Press the **SPLIT ZOOM** button repeatedly to select either 2, 4, or 9 Split Zoom.

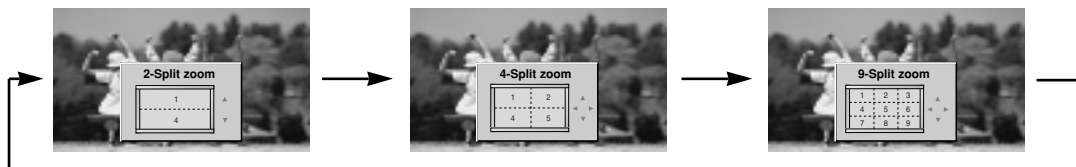

2. Press the number button corresponding to the section you wish to enlarge. You can move within the enlarged picture using the **▲ / ▼ / ◀ / ▶** button. To return to normal viewing, press the **SPLIT ZOOM** button again.

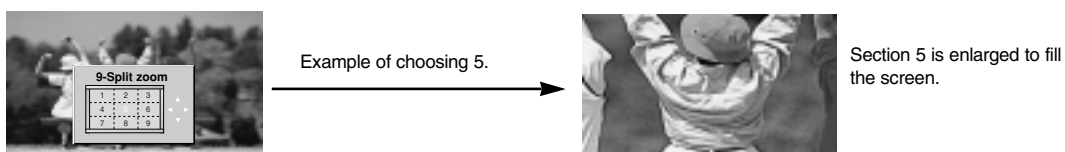

Lock Menu Options

Parental Control can be used to block specific channels, ratings and other viewing sources.

The Parental Control Function (V-Chip) is used to block program viewing based on the ratings sent by the broadcasting station. The default setting is to allow all programs to be viewed. Viewing can be blocked by the type of program and by the categories chosen to be blocked. It is also possible to block all program viewing for a time period. To use this function, the following must be done :

1. Set ratings and categories to be blocked.
2. Specify a password
3. Enable the lock

V-Chip rating and categories

Rating guidelines are provided by broadcasting stations. Most television programs and television movies can be blocked by TV Rating and/or Individual Categories. Movies that have been shown at the theaters or direct-to-video movies use the Movie Rating System (MPAA) only.

Ratings for Movies previously shown in theaters:

Movie Ratings :

- Blocking Off (Permits all programs)
- G (General audience)
- PG (Parental guidance suggested)
- PG-13 (Parents strongly cautioned)
- R (Restricted)
- NC-17 (No one 17 and under admitted)
- X (Adult only)

If you set PG-13 : G and PG movies will be available , PG-13, R, NC-17 and X will be blocked.

Ratings for Television programs including made-for-TV movies :

General TV Ratings:

- Blocking Off
- TV-G (general audience) (individual categories do not apply)
- TV-PG (parental guidance suggested)
- TV-14 (14 years and older)
- TV-MA (mature audience)

Children TV Ratings:

- Blocking Off
- TV-Y (youth) (individual content categories do not apply)
- TV-Y7 (youth, 7 years and up)

Content Categories:

- Dialog - sexual dialogue (applies to TV-PG, TV-14)
- Language - adult language (applies to TV-PG, TV-14, TV-MA)
- Sex scenes - sexual situations (applies to TV-PG, TV-14, TV-MA)
- Violence (applies to TV-PG, TV-14, TV-MA)
- F Violence - fantasy violence (applies only to TV-Y7)

Aux. Block

- Video 1, 2 (On, Off)
- Component 1, 2 (On, Off)
- RGB, DVI (On, Off)

Parental Lock Setup

- Lets you set up blocking schemes to block specific channels, ratings, and external viewing sources.
- A password is required to gain access to this menu if the Lock System is turned on

1. Press the **MENU** button and then use **▲ / ▼** button to select the **LOCK** menu. Then, press the **▶** button

- If **Lock** is already set, enter the password as requested.
- The TV is set up with the initial password "0-0-0-0".

2. Use the **▲ / ▼** button to choose from the following Lock Menu options. Once the option is selected, change the settings to your preference.

- **Lock on/off:** Activates or disables the blocking scheme you set up previously.
- **Set Password:** Change the password by inputting a new password twice.
- **MPAA (Movie Rating):** Blocks movies according to the movie ratings limits specified, so children cannot view certain movies. You can set the ratings limit by blocking out all the movies with the ratings above a specified level. Keep in mind that the movie ratings limit only applies to movies shown on TV, not TV programs, such as soap operas.
- **TV Rating-Children:** Prevents children from watching certain children's TV programs, according to the ratings limit set. The children rating does not apply to other TV programs. Unless you block certain TV programs intended for mature audiences in the TV Rating - sub menu, your children can view those programs.
- **TV Rating-General:** Based on the ratings, blocks certain TV programs that you and your family do not want to view.
- **Aux. Block:** Enables you to select a source to block from the external source devices you have hooked up.

3. Press the **ENTER** button to save.

Note

- If you ever forget your password, key in '7', '7', '7', '7' on the remote control.

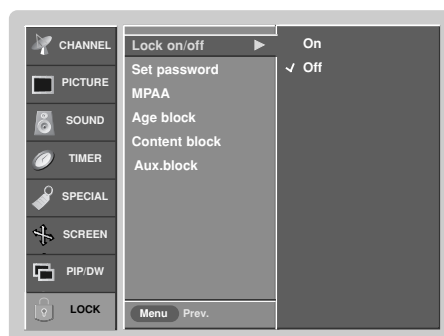

PIP (Picture-In-Picture)/Double Window Feature

- PIP lets you view 2 different inputs pictures (sources) on your TV screen at the same time. One source will be large, and the other source will show a smaller inset image.
- Double Window mode splits the screen into 2, allowing 2 picture sources to be shown on the TV screen at the same time. Each source is given half the screen.

Watching PIP/Double Window

Press the **PIP/DW** button to access the sub picture. Each press of PIP changes the PIP options as shown below.

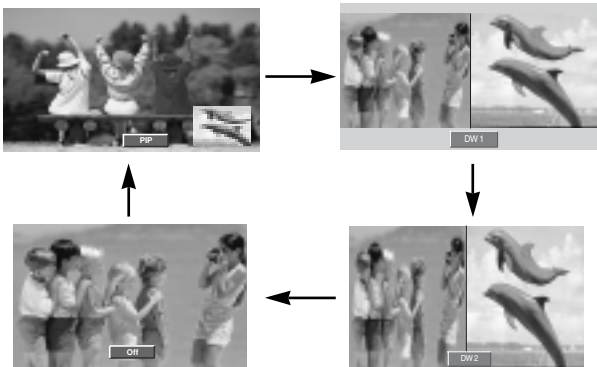

Swapping the PIP/Double Window

Use the **SWAP** button to switch the main and sub pictures.

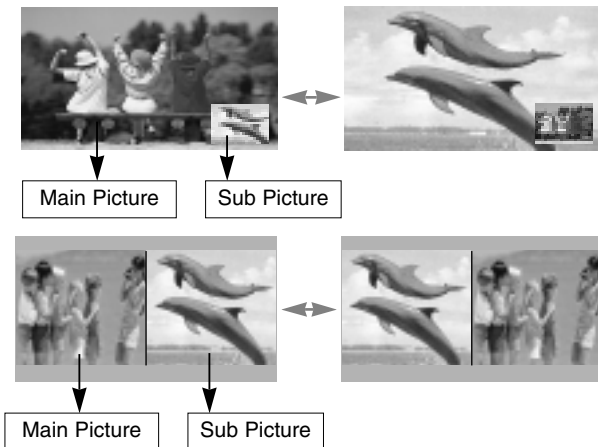

TV Program selection for PIP

Press the **PIPCH+** / **PIPCH-** button to select a channel for the sub picture in PIP mode.

Selecting an Input Signal Source for PIP/Double Window

Use the **PIP INPUT** button to select the input source for the sub picture. Each press of **PIP INPUT** button changes the PIP source.

Main Picture Source	Available Sub Picture Sources
TV, Video 1-2, Component 480i	TV, Video 1-2, Component 480i/480p/720p/1080i, RGB and DVI
Component 480p/720p/1080i, RGB and DVI	TV, Video 1-2, Component 480i

Moving the PIP (PIP Mode only)

Press the **POSITION** button.

Press the **▲ / ▼ / ◀ / ▶** button repeatedly until desired position is achieved. The sub picture moves up/down/left/right.

- You can also move the PIP position with **Win.position** in the **PIP/DW** menu.



PIP Size

Press the **WIN.SIZE** button and then use **◀ / ▶** button to change the sub picture size.

- Using the Win.size function in Double Window mode, main and sub picture sizes are changed simultaneously.
- Using the Win.size function in PIP mode, sub picture size is changed.
- You can also change the sub picture size with **Win.size** in the **PIP/DW** menu.



PIP Transparency (PIP Mode only)

- To make the PIP clear or opaque

1. Press the **MENU** button and then use **▲ / ▼** button to select the **PIP/DW** menu.
2. Press the **▶** button and then use **▲ / ▼** button to select **PIP Transparency**.
3. Press the **▶** button and then use **▲ / ▼** button to adjust PIP transparency.
4. Use the **◀ / ▶** button to make appropriate adjustments.
 - The adjustment range of **PIP Transparency** is 0 ~ 10.
5. Press the **ENTER** button to save.

External Control Device Setup

- Connect the RS-232C input jack to an external control device (such as a computer or an A/V control system) and control the Monitor's functions externally.
- Connect the serial port of the control device to the RS-232C jack on the Monitor back panel.
- RS-232C connection cables are not supplied with the Monitor.

RS-232C Setup

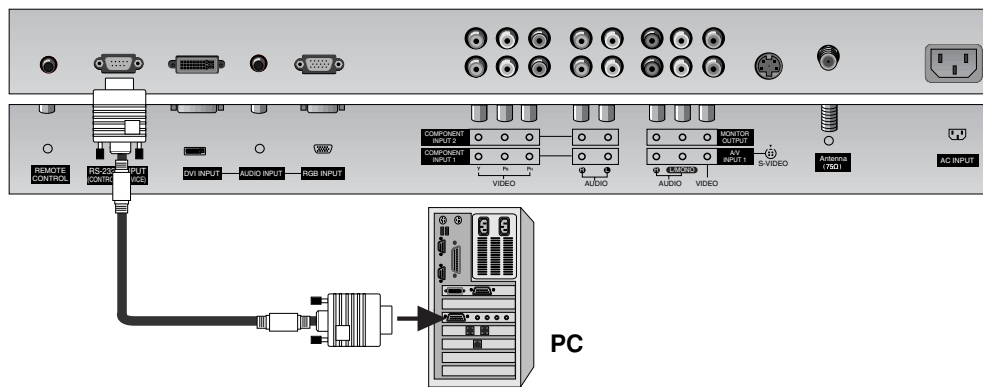

Type of Connector; D-Sub 9-Pin Male

No.	Pin name
1	No connection
2	RXD (Receive data)
3	TXD (Transmit data)
4	DTR (DTE side ready)
5	GND
6	DSR (DCE side ready)
7	RTS (Ready to send)
8	CTS (Clear to send)
9	No Connection

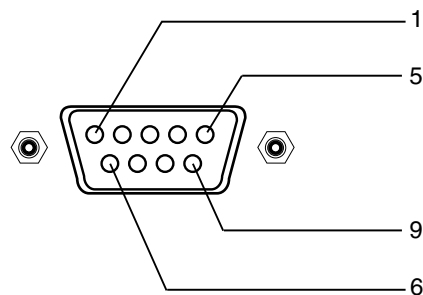

RS-232C Configurations

7-Wire Configurations (Standard RS-232C cable)

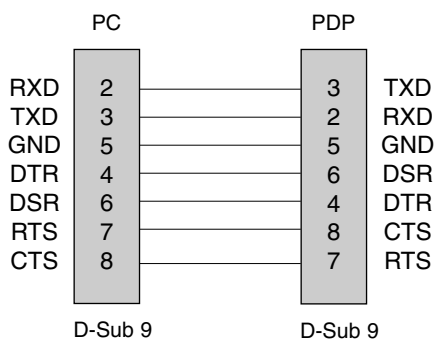

3-Wire Configurations (Not standard)

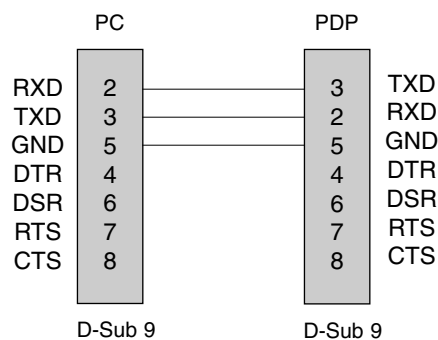

Set ID

- Use this function to specify a monitor ID number.
- Refer to 'Real Data Mapping 1'. See page 35.

1. Press the **MENU** button and then use **▲ / ▼** button to select the **SPECIAL** menu.
2. Press the **▶** button and then use **▲ / ▼** button to select **Set ID**.
3. Press the **▶** button and then use **◀ / ▶** button to adjust **Set ID** to choose the desired monitor ID number. The adjustment range of **Set ID** is 1 ~ 99.
4. Press the **ENTER** button to save.

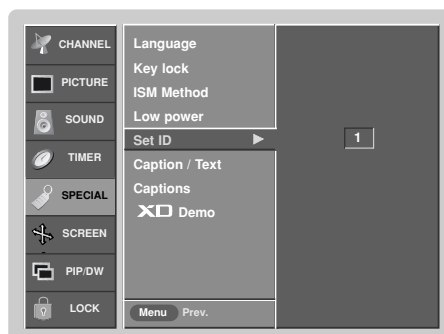

Communication Parameters

- Baud rate :9600 bps (UART)
- Data length : 8 bits
- Parity : None
- Stop bit : 1 bit
- Communication code : ASCII code

* Use a crossed (reverse) cable.

Command Reference List

	COMMAND 1	COMMAND 2	DATA (Hexadecimal)
01. Power	k	a	0 ~ 1
02. Input Select	k	b	0 ~ 6
03. Aspect Ratio	k	c	0 ~ 3
04. Screen Mute	k	d	0 ~ 1
05. Volume Mute	k	e	0 ~ 1
06. Volume Control	k	f	0 ~ 64
07. Contrast	k	g	0 ~ 64
08. Brightness	k	h	0 ~ 64
09. Color	k	i	0 ~ 64
10. Tint	k	j	0 ~ 64
11. Sharpness	k	k	0 ~ 64
12. OSD Select	k	l	0 ~ 1
13. Remote Control Lock Mode	k	m	0 ~ 1
14. PIP/DW	k	n	0 ~ 3
15. Split Zoom	k	p	0 ~ 99
16. PIP Position	k	q	0 ~ 3
17. Treble	k	r	0 ~ 64
18. Bass	k	s	0 ~ 64
19. Balance	k	t	0 ~ 64
20. Color Temperature	k	u	0 ~ 3
21. Red Adjustment	k	v	0 ~ 3C
22. Green Adjustment	k	w	0 ~ 3C
23. Blue Adjustment	k	\$	0 ~ 3C
24. PIP Input Source	k	y	0 ~ 6
25. Abnormal State	k	z	0 ~ a
26. ISM Method	j	p	0 ~ 3
27. Low Power	j	q	0 ~ 1
28. Orbiter Time Setting	j	r	1 ~ FE
29. Orbiter Pixel Setting	j	s	1~9
30. Picture Size	j	t	0 ~ 14
31. Auto Config	j	u	1

	COM- MAND 1	COM- MAND 2	DATA 0 (Hexadecimal)	DATA 1 (Hexadecimal)	DATA 2 (Hexadecimal)	DATA 3 (Hexadecimal)
32. Tune Command	m	a	01 ~ 7D	0	0	mainsub/TuneBand
33. Channel Add/Del	m	b	0 ~ 1			
34. Key	m	c	Key code			

Transmission / Receiving Protocol

Transmission

[Command1][Command2][][Set ID][][Data][Cr]

- * [Command 1]: First command to control PDP set. (j, k or m)
- * [Command 2]: Second command to control PDP set.
- * [Set ID]: You can adjust the set ID to choose desired monitor ID number in Special menu. Adjustment range is 1 ~ 99. When selecting Set ID '0', every connected PDP set is controlled. Set ID is indicated as decimal (1~99) on menu and as Hexa decimal (0x0~0x63) on transmission/receiving protocol.
- * [DATA]: To transmit command data.
Transmit 'FF' data to read status of command.
- * [Cr]: Carriage Return
ASCII code '0x0D'
- * []: ASCII code 'space (0x20)'

OK Acknowledgement

[Command2][][Set ID][][OK][Data][x]

- * The Monitor transmits ACK (acknowledgement) based on this format when receiving normal data. At this time, if the data is data read mode, it indicates present status data. If the data is data write mode, it returns the data of the PC computer.

Error Acknowledgement

[Command2][][Set ID][][NG][Data][x]

- * The Monitor transmits ACK (acknowledgement) based on this format when receiving abnormal data from non-viable functions or communication errors.

- Data 1: Illegal Code
2: Not supported function
3: Wait more time

01. Power (Command2:a)

- ▶ To control Power On/Off of the TV.

Transmission

```
[k][a][ ][Set ID][ ][Data][Cr]
```

Data 0 : Power Off 1 : Power On

Acknowledgement

```
[a][ ][Set ID][ ][OK][Data][x]
```

* In a like manner, if other functions transmit 'FF' data based on this format, Acknowledgement data feedback presents status about each function.

02. Input Select (Command2:b) (Main Picture Input)

- ▶ To select input source for the TV.
You can also select an input source using the TV/VIDEO button on the TV's remote control.

Transmission

```
[k][b][ ][Set ID][ ][Data][Cr]
```

Data 0 : TV 4 : Component 2
1 : Video 1 5 : RGB
2 : Video 2 6 : DVI
3 : Component 1

Acknowledgement

```
[b][ ][Set ID][ ][OK][Data][x]
```

03. Aspect Ratio (Command2:c) (Main picture format)

- ▶ To adjust the screen format.
You can also adjust the screen format using the ARC (Aspect Ratio Control) button on remote control or in the Screen menu.

Transmission

```
[k][c][ ][Set ID][ ][Data][Cr]
```

Data 0 : Normal screen (4:3)
1 : Wide screen (16:9)
2 : Horizon
3 : Zoom

Acknowledgement

```
[c][ ][Set ID][ ][OK][Data][x]
```

04. Screen Mute (Command2:d)

- ▶ To select screen mute on/off.

Transmission

```
[k][d][ ][Set ID][ ][Data][Cr]
```

Data 0 : Screen mute off (Picture on)
1 : Screen mute on (Picture off)

Acknowledgement

```
[d][ ][Set ID][ ][OK][Data][x]
```

05. Volume Mute (Command2:e)

- ▶ To control volume mute on/off.
You can also adjust mute using the MUTE button on remote control.

Transmission

```
[k][e][ ][Set ID][ ][Data][Cr]
```

Data 0 : Volume mute on (Volume off)
1 : Volume mute off (Volume on)

Acknowledgement

```
[e][ ][Set ID][ ][OK][Data][x]
```

06. Volume Control (Command2:f)

- ▶ To adjust volume.
You can also adjust volume with the volume buttons on remote control.

Transmission

```
[k][f][ ][Set ID][ ][Data][Cr]
```

Data Min : 0 ~ Max : 64

- Refer to 'Real data mapping 1' as shown below.

Acknowledgement

```
[f][ ][Set ID][ ][OK][Data][x]
```

07. Contrast (Command2:g)

- ▶ To adjust screen contrast.
You can also adjust contrast in the Picture menu.

Transmission

```
[k][g][ ][Set ID][ ][Data][Cr]
```

Data Min : 0 ~ Max : 64

- Refer to 'Real data mapping 1' as shown below.

Acknowledgement

```
[g][ ][Set ID][ ][OK][Data][x]
```

08. Brightness (Command2:h)

- ▶ To adjust screen brightness.
You can also adjust brightness in the Picture menu.

Transmission

```
[k][h][ ][Set ID][ ][Data][Cr]
```

Data Min : 0 ~ Max : 64

- Refer to 'Real data mapping 1' as shown below.

Acknowledgement

```
[h][ ][Set ID][ ][OK][Data][x]
```

* Real data mapping 1

0 : Step 0
⋮
A : Step 10 (SET ID 10)
⋮
F : Step 15 (SET ID 15)
10 : Step 16 (SET ID 16)
⋮
63 : Step 99 (SET ID 99)
64 : Step 100

09. Color (Command2:i)

- ▶ To adjust the screen color.
You can also adjust color in the Picture menu.

Transmission

[k][i][][Set ID][][Data][Cr]

Data Min : 0 ~ Max : 64

- Refer to 'Real data mapping 1'. See page 35.

Acknowledgement

[i][][Set ID][][OK][Data][x]

10. Tint (Command2:j)

- ▶ To adjust the screen tint.
You can also adjust tint in the Picture menu.

Transmission

[k][j][][Set ID][][Data][Cr]

Data Red : 0 ~ Green : 64

- Refer to 'Real data mapping 1'. See page 35.

Acknowledgement

[j][][Set ID][][OK][Data][x]

11. Sharpness (Command2:k)

- ▶ To adjust the screen sharpness.
You can also adjust sharpness in the Picture menu.

Transmission

[k][k][][Set ID][][Data][Cr]

Data Min: 0 ~ Max: 64

- Refer to 'Real data mapping 1'. See page 35.

Acknowledgement

[k][][Set ID][][OK][Data][x]

12. OSD Select (Command2:l)

- ▶ To select OSD (On Screen Display) on/off.

Transmission

[k][l][][Set ID][][Data][Cr]

Data 0: OSD off 1: OSD on

Acknowledgement

[l][][Set ID][][OK][Data][x]

13. Remote Control Lock Mode (Command2:m)

- ▶ To lock the remote control and the front panel controls on the monitor.

Transmission

[k][m][][Set ID][][Data][Cr]

Data 0: Lock off 1: Lock on

Acknowledgement

[m][][Set ID][][OK][Data][x]

- If you're not using the remote control and front panel controls on the monitor, use this mode. When main power is on/off, remote control lock is released.

14. PIP / DW (Command2:n)

- ▶ To control the PIP (Picture In picture)/DW (Double Window).
You can also control the PIP/DW using the PIP/DW button on the remote control or in the PIP/DW menu.

Transmission

[k][n][][Set ID][][Data][Cr]

Data 0: PIP/DW off 2: DW1
1: PIP 3: DW2

Acknowledgement

[n][][Set ID][][OK][Data][x]

15. Split Zoom (Command2:p)

- ▶ To operate split zoom function and select the split zoom section number.

Transmission

[k][p][][Set ID][][Data][Cr]

Data Min: 0 ~ Max:99

- Refer to 'Real data mapping 2'.

Acknowledgement

[p][][Set ID][][OK][Data][x]

* Real data mapping 2

0 : Reset split zoom
21 : Selection 1 of 2 split zoom
24 : Selection 4 of 2 split zoom
41 : Selection 1 of 4 split zoom
42 : Selection 2 of 4 split zoom
44 : Selection 4 of 4 split zoom
45 : Selection 5 of 4 split zoom
91 : Selection 1 of 9 split zoom
⋮
99 : Selection 9 of 9 split zoom

16. PIP Position (Command2:q)

- ▶ To select sub picture position for PIP.
You can also adjust the sub picture position using WIN.POSITION on the remote control or in the PIP/DW menu.

Transmission

[k][q][][Set ID][][Data][Cr]

Data 0: Right down on screen
1: Left down on screen
2: Left up on screen
3: Right up on screen

Acknowledgement

[q][][Set ID][][OK][Data][x]

17. Treble (Command2:r)

- ▶ To adjust treble.
You can also adjust treble in the Sound menu.

Transmission

[k][r][][Set ID][][Data][Cr]

Data Min: 0 ~ Max: 64

- Refer to 'Real data mapping 1'. See page 35.

Acknowledgement

[r][][Set ID][][OK][Data][x]

18. Bass (Command2:s)

- ▶ To adjust bass.
You can also adjust bass in the Sound menu.

Transmission

[k][s][][Set ID][][Data][Cr]

Data Min: 0 ~ Max: 64

- Refer to 'Real data mapping 1'. See page 35.

Acknowledgement

[s][][Set ID][][OK][Data][x]

19. Balance (Command2:t)

- ▶ To adjust balance.
You can also adjust balance in the Sound menu.

Transmission

[k][t][][Set ID][][Data][Cr]

Data Min: 0 ~ Max: 64

- Refer to 'Real data mapping 1'. See page 35.

Acknowledgement

[t][][Set ID][][OK][Data][x]

20. Color Temperature (Command2:u)

- ▶ To adjust color temperature.
You can also adjust ACC in the Picture menu.

Transmission

[k][u][][Set ID][][Data][Cr]

Data 0: Cool 1: Normal 2: Warm 3: Off

Acknowledgement

[u][][Set ID][][OK][Data][x]

21. Red Adjustment (Command2:v)

- ▶ To adjust red in color temperature.

Transmission

[k][v][][Set ID][][Data][Cr]

Data Min: 0 ~ Max: 3C

- Refer to 'Real data mapping 3' as shown right.

Acknowledgement

[v][][Set ID][][OK][Data][x]

22. Green Adjustment (Command2:w)

- ▶ To adjust green in color temperature.

Transmission

[k][w][][Set ID][][Data][Cr]

Data Min: 0 ~ Max: 3C

- Refer to 'Real data mapping 3' as shown right.

Acknowledgement

[w][][Set ID][][OK][Data][x]

23. Blue Adjustment (Command2:\$)

- ▶ To adjust blue in color temperature.

Transmission

[k][\$][][Set ID][][Data][Cr]

Data Min: 0 ~ Max: 3C

- Refer to 'Real data mapping 3' as shown below.

Acknowledgement

[\$][][Set ID][][OK][Data][x]

*** Real data mapping 3**

0 : -30

1 : -29

2 : -28

⋮

1E : 0

⋮

3A : +28

3B : +29

3C : +30

24. PIP Input Select (Command2:y)

- ▶ To select input source for sub picture in PIP mode.

Transmission

[k][y][][Set ID][][Data][Cr]

Data 0 : TV	4 : Component 2
1 : Video 1	5 : RGB
2 : Video 2	6 : DVI
3 : Component 1	

Acknowledgement

[y][][Set ID][][OK][Data][x]

25. Abnormal State (Command2:z)

- ▶ To recognize an abnormal state.

Transmission

[k][z][][Set ID][][FF][Cr]

Data FF:Read

Acknowledgement

[z][][Set ID][][OK][Data][x]

Data 0: Normal (Power on and signal exist)
 1: No signal (Power on).
 2: Turn the monitor off with remote control.
 3: Turn the monitor off with Sleep Time function.
 4: Turn the monitor off with RS-232C function.
 5: 5V down.
 6: AC down.
 7: Turn the monitor off with Fan Alarm function.
 8: Turn the monitor off with Off Time function.
 9: Turn the monitor off with Auto Off function.
 a: Turn the monitor off with On Time function.
 (If you do not press any button within 2 hours after the TV turns on with the On Timer function, the TV will automatically revert to standby mode.)

IR Codes

How to Connect

- ▶ Connect your wired remote control to the Remote Control port on the Monitor.

Remote Control IR Code

▶ Output waveform

Single pulse, modulated with 37.917KHz signal at 455KHz

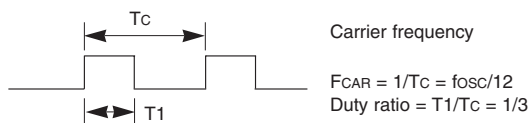

▶ Configuration of frame

- 1st frame



- Repeat frame

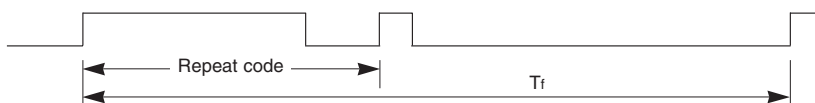

▶ Lead code



▶ Repeat code

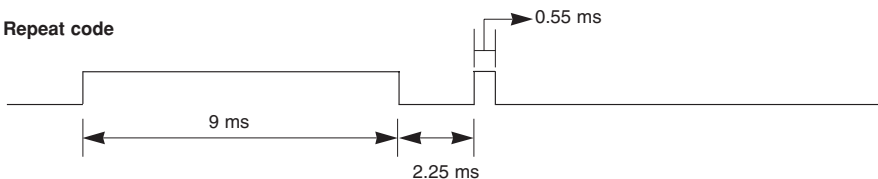

▶ Bit description

- Bit "0"

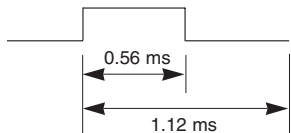

- Bit "1"

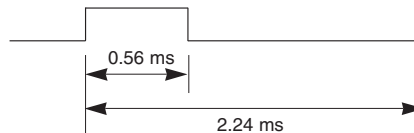

▶ Frame interval : Tf

The waveform is transmitted as long as a key is depressed.

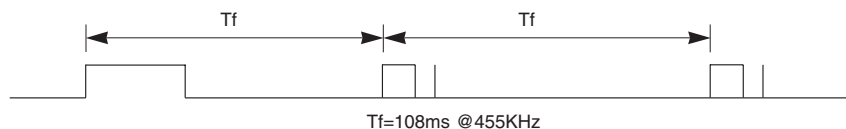

Code (Hexa)	Function	Note
00	CH (▲)	R/C Button
01	CH (▼)	R/C Button
02	VOL (▶)	R/C Button
03	VOL (◀)	R/C Button
08	POWER	R/C Button (Power On/Off)
C4	POWER ON	Discrete IR Code (Only Power On)
C5	POWER OFF	Discrete IR Code (Only Power Off)
09	MUTE	R/C Button
10	Number Key 0	R/C Button
11	Number Key 1	R/C Button
12	Number Key 2	R/C Button
13	Number Key 3	R/C Button
14	Number Key 4	R/C Button
15	Number Key 5	R/C Button
16	Number Key 6	R/C Button
17	Number Key 7	R/C Button
18	Number Key 8	R/C Button
19	Number Key 9	R/C Button
0B	TV/VIDEO	R/C Button
98	MULTIMEDIA	R/C Button
D6	TV	Discrete IR Code (Input TV Selection)
5A	VIDEO1	Discrete IR Code (Input VIDEO1 Selection)
D0	VIDEO2	Discrete IR Code (Input VIDEO2 Selection)
BF	COMPONENT1	Discrete IR Code (Input COMPONENT1 Selection)
D4	COMPONENT2	Discrete IR Code (Input COMPONENT2 Selection)
C6	DVI	Discrete IR Code (Input DVI Selection)
D5	RGB	Discrete IR Code (Input RGB Selection)
0E	SLEEP	R/C Button
43	MENU	R/C Button
44	ENTER	R/C Button
4D	APC	R/C Button
52	DASP	R/C Button
60	PIP/DW	R/C Button
61	PIP INPUT	R/C Button
63	SWAP	R/C Button
64	WIN.SIZE	R/C Button
62	POSITION	R/C Button
71	PIP CH+	R/C Button
72	PIP CH-	R/C Button
7B	SPLIT ZOOM	R/C Button
79	ARC	R/C Button
76	ARC (4:3)	Discrete IR Code (Only 4:3 mode)
77	ARC (16:9)	Discrete IR Code (Only 16:9 mode)
AF	ARC (Zoom)	Discrete IR Code (Only Zoom mode)
1E	FCR	R/C Button
1A	REVIEW	R/C Button
54	AUTO PROGRAM	R/C Button
55	MEMORY/ERASE	R/C Button
0A	MTS	R/C Button
39	CAPTION	R/C Button
99	AUTO CONFIG	Discrete IR Code

Troubleshooting Checklist

<p>No picture & No sound</p>	<ul style="list-style-type: none"> • Check whether the TV is turned on. • Is the power cord inserted into wall power outlet? • Test the wall power outlet, plug another product's power cord into the outlet where the TV's power cord was plugged in.
<p>Picture OK & No sound</p>	<ul style="list-style-type: none"> • Press the VOLUME (▶) button. • Sound muted? Press MUTE button.
<p>The remote control doesn't work</p>	<ul style="list-style-type: none"> • Check to see if there is any object between the TV and the remote control causing obstruction. • Are batteries installed with correct polarity (+ to +, - to -)? (Refer to p.9) • Correct remote operating mode set: TV, VCR etc.? • Install new batteries. (Refer to p.9)
<p>Picture appears slowly after switching on</p>	<ul style="list-style-type: none"> • This is normal, the image is muted during the TV startup process. Please contact your service center, if the picture has not appeared after five minutes.
<p>No or poor color or poor picture</p>	<ul style="list-style-type: none"> • Select Color in the Picture menu and press the VOLUME (▶) button. (Refer to p.20) • Keep a sufficient distance between the TV and the VCR. • Activate any function to restore the brightness of the picture. (If still picture is on the screen for more than 5 minutes, the screen gets dark.)
<p>Horizontal/vertical bars or picture shaking</p>	<ul style="list-style-type: none"> • Check for local interference such as an electrical appliance or power tool.
<p>No output from one of the speakers</p>	<ul style="list-style-type: none"> • Adjust Balance in the Sound menu. (Refer to p.22)
<p>Unusual sound from inside the TV</p>	<ul style="list-style-type: none"> • A change in ambient humidity or temperature may result in an unusual noise when the plasma display is turned on or off and does not indicate a fault with the TV.

Maintenance

- Early malfunctions can be prevented. Careful and regular cleaning can extend the amount of time you will have your new TV. Be sure to turn the power off and unplug the power cord before you begin any cleaning.

Cleaning the Screen

1. Here's a great way to keep the dust off your screen for a while. Wet a soft cloth in a mixture of lukewarm water and a little fabric softener or dish washing detergent. Wring the cloth until it's almost dry, and then use it to wipe the screen.
2. Make sure the excess water is off the screen, and then let it air-dry before you turn on your TV.

Cleaning the Cabinet

To remove dirt or dust, wipe the cabinet with a soft, dry, lint-free cloth. Please be sure not to use a wet cloth.

Extended Absence



If you expect to leave your TV dormant for a long time (such as a vacation), it's a good idea to unplug the power cord to protect against possible damage from lightning or power surges.

Product Specifications

MODELS	42PY1R-UA / RU-42PY10X	
Width (inches / mm)	48 / 1216	
Height (inches / mm)	27 / 691	
Depth (inches / mm)	10.7 / 271.4	
Weight (pounds / kg)	86.4 / 39.2	
Resolution	1024 x 768(Dot)	
Power requirement	AC100-240V ~ 50/60Hz	
Television System	NTSC	
Program Coverage	VHF 2 ~ 13, UHF 14 ~ 69, CATV 1 ~ 125	
External Antenna Impedance	75 Ω	
Operating Temperature Range	32 ~ 104°F (0 ~ 40°C)	
Operating Humidity Range	Less than 80%	

- The specifications shown above may be changed without notice for quality improvement.



LG ELECTRONICS, INC.
PLASMA TV — U.S. LIMITED WARRANTY

Your LG Plasma TV will be repaired or replaced in accordance with the terms of this warranty, at LGE's option, if it proves to be defective in material or workmanship under normal use, during the warranty period ("Warranty Period") listed below, effective from the date ("Date of Purchase") of original consumer purchase of the product. This warranty is good only to the original purchaser of the product and effective only when used in the United States, including Alaska, Hawaii, and U.S. Territories.

WARRANTY PERIOD:

LABOR and PARTS: 2 YEARS from the Date of Purchase. Your unit will be repaired or replaced with a new, substitute model or factory reconditioned unit, at LGE's option. If repaired, parts used in the repair may be new or remanufactured. Replacement Units and Repair Parts are warranted for the remaining portion of the original unit's warranty period.

EFFECTIVE DATE OF WARRANTY: Your warranty period begins on the date of sale to the original consumer/end user. KEEP THE DEALER'S DATED BILL OF SALE OR PROOF OF DELIVERY as evidence of the purchase date. You will be required to submit a legible copy of your bill of sale or proof of delivery when requesting warranty service.

HOW SERVICE IS HANDLED:

In-Home Service: Please retain dealer's dated bill of sale or delivery ticket as evidence of the Date of Purchase for proof of warranty, and submit a copy of the bill of sale to the service person at the time warranty service is provided.

Please call 1-800-243-0000 to locate your nearest LGE Authorized Service Center.

Visit our website at:
<http://www.lgservice.com>

THIS WARRANTY IS IN LIEU OF ANY OTHER WARRANTY, EXPRESS OR IMPLIED, INCLUDING WITHOUT LIMITATION, ANY WARRANTY OF MERCHANTABILITY OR FITNESS FOR A PARTICULAR PURPOSE. TO THE EXTENT ANY IMPLIED WARRANTY IS REQUIRED BY LAW, IT IS LIMITED IN DURATION TO THE EXPRESS WARRANTY PERIOD ABOVE. NEITHER THE MANUFACTURER NOR ITS U.S. DISTRIBUTOR SHALL BE LIABLE FOR ANY INCIDENTAL, CONSEQUENTIAL, INDIRECT, SPECIAL, OR PUNITIVE DAMAGES OF ANY NATURE, INCLUDING WITHOUT LIMITATION, LOST PROFITS, LOST OR CORRUPTED PROGRAMMING OR DATA, OR ANY OTHER DAMAGE WHETHER BASED IN CONTRACT, TORT, OR OTHERWISE. Some states do not allow the exclusion or limitation of incidental or consequential damages or limitations on how long an implied warranty lasts, so the above exclusion or limitation may not apply to you. This warranty gives you specific legal rights and you may also have other rights that vary from state to state.

CONCERNING PIXEL FUNCTIONALITY: Your Plasma TV contains about one million individual pixels. Plasma TV typically contain a small number of pixels that do not function normally. Your display has been inspected and is in compliance with manufacturer's specifications, indicating that any pixel defects do not effect the operation or use of your display.

IMPORTANT: Please fill out and mail in your Product Registration Card or go to www.lgservice.com to register your product online. This information will allow us to reach you promptly should we discover a safety or reliability problem that could affect you.

THIS LIMITED WARRANTY DOES NOT APPLY TO:

<ul style="list-style-type: none">● damage caused in shipping or transit● service required as a result of improper installation, including incorrect or insufficient AC supply (please consult the owner's manual for power supply requirements)● installation or repair of antenna systems, cable converters, cable company supplied equipment, or other components in a video system● set-up or adjustment on consumer controls, or damage caused by improper adjustments● damage caused by other system components● any panel that has been modified or incorporated into any other product● replacement of batteries on the remote control.● damage (including cosmetic damage), failure, loss or personal injury due to misuse, abuse, negli-	<p>gence, improper maintenance or storage, or to acts of nature or other causes beyond our control. (Causes beyond our control include but are not limited to lightning strike, power surges, power outages and water damage.)</p> <ul style="list-style-type: none">● image burn-in● repair or replacement of warranted parts by other than LGE authorized service centers.● units purchased or serviced outside of the coverage area.● product where the original factory serial numbers have been removed, defaced or changed in any way.● product sold and labeled as "as is, where is" or similar disclaimer.
---------------------------------------------------------------------------------------------------------------------------------------------------------------------------------------------------------------------------------------------------------------------------------------------------------------------------------------------------------------------------------------------------------------------------------------------------------------------------------------------------------------------------------------------------------------------------------------------------------------------------------------------------------------------------------------------------------------------------------------------------------------------------------------------------------------------------------	----------------------------------------------------------------------------------------------------------------------------------------------------------------------------------------------------------------------------------------------------------------------------------------------------------------------------------------------------------------------------------------------------------------------------------------------------------------------------------------------------------------------------------------------------------------------------------------------------------------------------------------------------------------------

The cost of repair or replacement under these excluded circumstances shall be borne by the consumer.

CUSTOMER INTERACTIVE CENTER NUMBERS:

<p>To obtain customer assistance, product information or Dealer or Service locations</p>	<p>Call 1-800-243-0000 24 hours a day, 365 days per year</p>
-------------------------------------------------------------------------------------------------	-------------------------------------------------------------------------

FOR SERVICE:

Before you call for warranty service, check your operating guide – you may avoid a service call.

For warranty service information, please contact the LGE Customer Interactive Center telephone number.

When calling for service, **please have your product model number, serial number and the date of purchase or the date of original installation available.**

If a replacement unit is required, under some circumstances you may be asked to provide a reserve deposit to the LGE Service Center against a credit card number as surety for advanced shipment. Your credit card will not be charged if you return the defective unit within 10 working days.

If a replacement unit is received, please use the carton and packaging from that unit in returning the defective unit to the LG®Brand Service Center.

Parts and service in accordance with the LGE warranty are LGE's responsibility and will be provided without charge. Other service requirements will be at the owner's expense. If you have problems in obtaining satisfactory warranty service, write or call the LGE Customer Interactive Center. Service may be provided by independently owned and operated service organizations.

To assure proper credit and avoid unnecessary charges, you must obtain an LGE Return Authorization before returning any product to the LGE Service Center. Contact the Customer Interactive Center for details.

TO CONTACT THE LGE CUSTOMER SERVICE CENTER BY MAIL:

LGE Customer Interactive Center
P.O. Box 240007
201 James Record Road
Huntsville, Alabama 35824
<http://www.lgservice.com>