



User Guide

LG-VS500

User Guide

MFL69440201 (1.0) ME

LG-VS500



Guía del Usuario

LG-VS500

 This booklet is printed with soy ink. Printed in Mexico



*Copyright©2016 LG Electronics, Inc. All rights reserved.
LG and the LG logo are registered trademarks of LG Corp.
V5500 is a trademark of LG Electronics, Inc.
All other trademarks are the property of their respective
owners.*

Before you begin using your new phone

Included in the box with your phone are separate information leaflets. These leaflets provide you with important information regarding your new device. Please read all of the information provided. This information will help you to get the most out of your phone, reduce the risk of injury, avoid damage to your device, and make you aware of legal regulations regarding the use of this device.

It's important to review the Product Safety and Warranty Information guide before you begin using your new phone. Please follow all of the product safety and operating instructions and retain them for future reference. Observe all warnings to reduce the risk of injury, damage, and legal liabilities.

2 Table of Contents

Important Customer Information.....	1
Table of Contents	2
The Basics	5
Phone Overview.....	5
Help	7
Setting Up Your Phone	8
Removing the Battery and SIM Card	10
Inserting and Removing a Memory Card.....	11
Charging Your Phone	12
Optimizing Battery Life	13
Turning Your Phone On and Off	15
Your Google Account	18
Touch Screen	19
Getting to Know the Home Screen	20
Apps: How to View, Open, and Switch	26
Capturing a Screenshot.....	33
Phone's Status Icons	33
Managing Notifications	35
Searching Your Phone and the Web.....	38
Setting Your Lock Screen	40
Dual Window.....	42
Connecting to Networks and Devices	44
Wi-Fi.....	44
Wi-Fi Direct	44
Bluetooth.....	45
SmartShare	46
PC connections with a USB cable	47
PC connections with a USB cable for Mac OS X users	48
Calls	49
Placing and Ending Calls	49
Answering or Rejecting Calls.....	52
Working With the Recent Tab	54
Calling Your Contacts.....	56
Options During a Call	57

Managing Multiple Calls.....	57
Listening to Your Voice mail.....	59
Web.....	61
Chrome.....	61
Communication.....	64
Contacts.....	64
Messaging.....	70
Email.....	74
Voice mail.....	76
Gmail.....	77
Hangouts.....	84
Entertainment.....	86
Camera.....	86
Gallery.....	96
Music.....	100
Play Store.....	105
YouTube™.....	107
Tools.....	108
Capture+.....	108
QSlide.....	109
QuickRemote.....	111
Clock.....	113
Calculator.....	114
Calendar.....	115
Maps.....	117
Voice Mate.....	118
Voice Search.....	119
Voice Recorder.....	120
File Manager.....	122
Settings.....	123
Safety.....	144
Consumer Information About Radio Frequency Emissions.....	146

4 **Table of Contents**

Consumer Information on SAR	151
FCC Hearing-Aid Compatibility (HAC) Regulations for Wireless Devices.	152
Caution:	
Avoid potential hearing loss.....	154
TIA Safety Information.....	156
Safety Information	159
FDA Consumer Update	163

Phone Overview

Front View

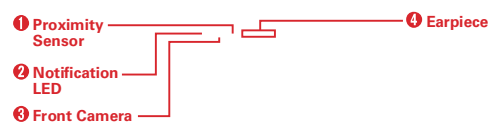

- NOTES**
- All screen shots in this guide are simulated. Actual displays may vary.
 - Instructions to perform tasks in this guide are based on the default settings and may change depending on the mode and software version on your phone.

1. **Proximity Sensor** Senses proximity toward other objects (such as your head) so that tap commands are not accidentally activated during a call or when carried inside a pocket. It also employs an ambient sensor which measures the surrounding light and adjusts the LCD brightness to provide a vivid screen.
NOTE Don't block the sensor or near the sensor to avoid problems with the touch screen.
2. **Notification LED** Flashes to alert you for notifications (e.g., incoming call, new text message, screen unlock, etc.).
3. **Front Camera** Use to take pictures and record videos of yourself. You can also use this for video chatting. Keep it clean for optimal performance.
4. **Earpiece** Lets you hear callers and automated prompts.

6 The Basics

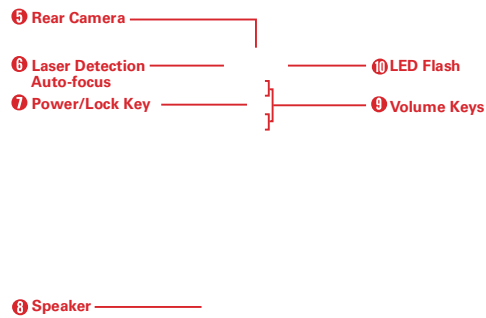

Rear View



5. **Rear Camera** Use to take photos and record videos. Keep it clean for optimal performance.
6. **Laser Detection Auto-focus** Detects the distance between the rear camera lens and nearby objects using laser technology. This feature helps the camera to focus quickly and accurately at short or long distances.

NOTE Don't cover the Proximity Sensor and Laser Detection Auto-focus with a protection film, pouch, or protection case not authorized by LG as they may cause the device to malfunction.

7. **Power/Lock Key** Press to turn off the screen backlight and lock the screen, or turn the screen backlight back on. Press and hold to turn the phone on/off, restart it, and activate/deactivate Airplane mode.
8. **Speaker** Use to listen to audio (e.g., music, videos, sound clips, speakerphone, etc.) from the rear speaker instead of the earpiece.
9. **Volume Keys** Press to adjust the ringer, the media volumes, or the in-call volume during a call. They also access shortcuts when enabled in the Settings menu.

- TIPS**
- With the screen backlight off (asleep), you can press the **Volume Down Key**  twice to activate the **Camera** app.
 - With the screen backlight off (asleep), you can press the **Volume Up Key**  twice to access the **Capture+** app.

10. **LED Flash** Brightens up the captured image or recorded video when you turn on the flash.

Top and Bottom View

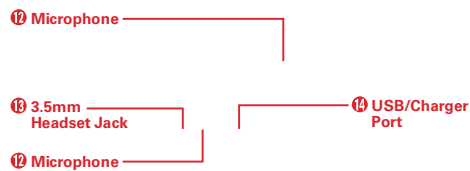

12. **Microphone** Transmits your voice to the other caller. It's also used for voice-activated functions.
13. **3.5mm Headset Jack** Allows you to plug in an optional headset for convenient, hands-free conversations. You can also plug in headphones to listen to music.
14. **USB/Charger Port** Allows you to connect the phone and the USB cable for use with the charger adapter, or other compatible accessories.

Help

The Help app allows you to quickly and conveniently view information about your phone, including how-to videos, Icon glossary, etc.

To access Help, tap the **Home Button**  > the **Apps icon**  > **Help** .

Setting Up Your Phone

Step 1. Remove the Back Cover

With the phone facing down, insert your fingernail into the slot located on the lower left of the back cover and lift the cover up gently.

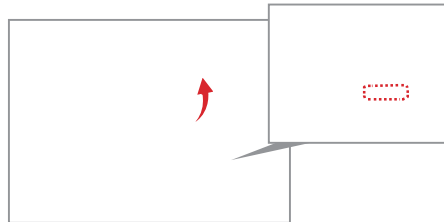

Step 2. Insert the Battery

Insert the battery, making sure to align the gold contacts. Press down gently to secure the battery.

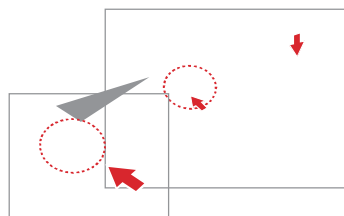

Step 3. Replace the Back Cover

Place the cover over the back of the phone, then press down along the edges to secure the cover.



Step 4. Charge the Phone

Before turning on your phone, fully charge the battery. Be sure to use the USB cable and charger adapter that came with your phone. Correctly orient the USB cable plug before inserting it in the USB/Charger Port to avoid damage to your phone. See **Charging Your Phone** on pages 12 and 13 for more information.



NOTE It's important to fully charge the battery before initial use of the phone to maximize the battery's lifetime.

Removing the Battery and SIM Card

Removing the battery

1. With the phone facing down, insert your fingernail into the slot located on the lower left of the back cover and lift the cover up gently.



2. Use the fingertip cutout at the bottom of the battery compartment to lift the battery out.

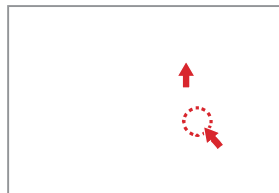

SIM card/microSD card slot location

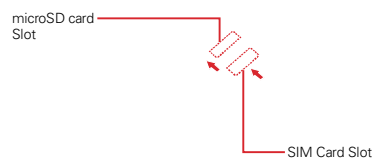

Removing the SIM card

The SIM card is pre-installed in your smartphone. If you need to replace your SIM card, refer to the following instructions.

1. Turn the phone off, then remove the back cover and the battery (as demonstrated in the previous instructions).
2. Locate the slot for the SIM card (the lower of the two slots above the upper-right corner of the battery compartment) and gently slide the SIM card out to remove it.

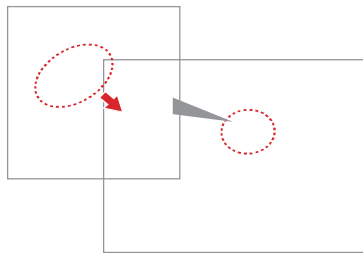

CAUTION If a microSD card is inserted in your phone, please remove it from the upper slot before trying to remove the SIM card.

Inserting and Removing a Memory Card

Inserting a microSD card

1. Remove the back cover (as demonstrated in the previous instructions) and locate the dual slot just above the upper-right corner of the battery compartment. (microSD is inscribed near the slot opening.)
2. Position the microSD card (sold separately) with the label side facing up and the gold contacts toward the slot, then carefully slide it into the upper slot until it's secured in place.



12 The Basics

NOTE The microSD card can be easily damaged by improper operation. Please be careful when inserting, removing, or handling it.

To remove the microSD card

1. Unmount the microSD card.
 - ▶ Tap the **Home Button** ○ > touch and hold the **Recent Apps Button** □ > **Settings** > **Storage & USB** > ▲.
2. Remove the back cover and locate the microSD card slot (as demonstrated in the previous instructions).
3. Carefully pull the microSD card out to remove it.



To unmount the microSD card

It's important to unmount the microSD card prior to removing it from the phone to avoid damage to it or the data saved on the card.

1. Tap the **Home Button** ○ > touch and hold the **Recent Apps Button** □.
2. Tap **Settings** > **Storage & USB**.
3. Tap ▲.

Charging Your Phone

Your phone comes with a USB cable and a charger adapter. You can connect them together and charge from a power outlet, or you can use the USB cable alone to charge from your computer. Correctly orient the plugs before insertion to avoid damaging your phone and cable.

NOTE Please only use an approved charging accessory to charge your LG phone. Improper handling of the USB/Charger Port, as well as the use of an incompatible charger, may cause damage to your phone and void the warranty.

1. Correctly orient the USB cable with the charger adapter, and connect them. As shown below, both the USB logo on the USB cable and the LG logo on the adapter will face toward you.



2. The USB/Charger Port is located at the bottom of the phone. Correctly orient the cable's plug with the port before plugging it in. As shown below, the USB logo on the cable will face upward.
3. Plug the charger adapter into an electrical outlet to begin charging.

Charging with the USB Cable



NOTE

Make sure to correctly orient the cable's plug with the port before plugging it in. When the phone is facing upward, the USB logo on the cable will also face upward.

You can use your computer to charge your phone. To be able to charge with the USB cable, you need to have the necessary USB drivers installed on your PC first. Connect one end of the USB cable to the USB/Charger Port on your phone (as shown above) and connect the other end to a USB port on your PC. It's best to use the rear USB port when connecting to a desktop PC. The USB hub should be powered by an external power source.

NOTE You may experience a slower charging rate when charging from your computer.

Optimizing Battery Life

You can extend your battery's life between charges by turning off features that run in the background. You can also monitor how apps and system resources consume battery power.

Tips to extend the life of your battery

- ▶ Reduce the screen brightness and set a shorter screen timeout.



14 The Basics

- ▶ Turn off radio communications (such as Wi-Fi, Bluetooth®, GPS, etc.) that you're not actively using. (Note that the GPS receiver is only turned on when you're using an app that makes use of it.)

Turn off automatic syncing for Gmail, Calendar, Contacts, and other apps if you don't need it.

- NOTES**
- Allowing other devices to use your device's hotspot connection will drain your battery more quickly.
 - If you accidentally press the **Power/Lock Key** while the phone is in your pocket, the proximity sensor prevents the screen from turning on in order to save battery power.



To check the battery charge level

Tap the **Home Button**  > touch and hold the **Recent Apps Button**  > **Settings** > **Battery**.



- ▶ The battery level (as a percentage of fully charged) and the battery status (Charging or Discharging) is displayed at the top of the screen.
- ▶ Checkmark the **Battery percentage on Status Bar** checkbox to display the percentage of remaining battery charge on the Status Bar next to the battery icon.
- ▶ Tap **Battery saver** to view and/or modify your Battery saver settings.

To monitor and control what uses the battery

The Battery usage screen allows you to see which apps are consuming the most battery power. Information on this screen allows you to identify downloaded apps you may want to turn off when not being used, so you can get the most out of your battery power.

- ▶ Tap the **Home Button**  > touch and hold the **Recent Apps Button**  > **Settings** > **Battery** > **Battery usage**.

OR



- ▶ Tap the **Home Button**  > touch and hold the **Recent Apps Button**  > **Settings** > **About phone** > **Battery** > **Battery usage**.

The top of the Battery usage screen displays a usage graph and below it, battery usage times. It lists all of the apps or services using battery power from the greatest amount of energy used to the least amount.

- ▶ Tap an app or service in the Battery usage screen to see details about its power consumption. Different apps or services offer different kinds of information, and they may even include options to modify the settings so you can reduce power consumption by that app (or stop running the app).

Battery saver

Battery saver changes certain settings to conserve battery power until you can recharge your phone. If you turn Battery saver **On**, it will automatically activate when the battery charge level drops to the level you set. If Battery saver is off, you'll be prompted to turn on Battery saver when the battery reaches low levels.

- ▶ Tap the **Home Button**  > touch and hold the **Recent Apps Button**  > **Settings** > **Battery** > **Battery saver**.
- ▶ From the Battery saver screen, select to activate Battery saver immediately, or when the charge drops to 5% or 15%. If you turn off Battery saver, when the battery charge becomes low, a notification prompts you to turn it on.
- ▶ After you modify the Battery saver settings to your preferences, tap the switch  to toggle it On (blue) or Off (gray).

Turning Your Phone On and Off

Turning your phone on

- ▶ Press and hold the **Power/Lock Key**  on the back of the phone for a couple of seconds until the screen turns on.

Turning your phone off

1. Press and hold the **Power/Lock Key**  on the back of the phone until the Phone options menu appears.
2. Tap **Power off** in the Phone options menu.
3. Tap **OK** to confirm that you want to turn off the phone.

Turning the screen on using the KnockON feature

The KnockON feature allows you to double-tap the screen to easily turn the screen on or off.



- ▶ Quickly double-tap the center of the dark screen to turn on the backlight and display the Lock screen.

Quickly double-tap the Status Bar, an empty area on the Home screen, or the Lock screen to turn the screen off.

- NOTES**
- The backlight will not turn on if the proximity sensor is covered.
 - When the screen is off and you double-tap the screen with Knock Code activated, the Knock Code grid is displayed for you to enter your Knock Code.



Turning the screen on using the Knock Code feature

If your Lock screen unlock sequence is set to a Knock Code, tap your Knock Code on the darkened screen to automatically turn on the backlight and unlock the screen at the same time.

- TIP** When the screen is in timeout and a Knock Code is set, pressing the **Power/Lock Key**  (on the back of the phone) displays the Lock screen (e.g., to check the time). You can tap your Knock Code to unlock the screen or press the **Power/Lock Key**  again (or double-tap the Status Bar) to turn the backlight back off.

- NOTES**
- Entering the incorrect Knock Code 6 times and you'll be prompted you to enter your backup PIN to unlock your phone.
 - Use a fingertip instead of a fingernail to tap your Knock code on the screen.

Setting up the Knock Code feature

1. Tap the **Home Button**  > touch and hold the **Recent Apps Button**  > **Lock screen settings**.
2. Tap **Select screen lock** > **Knock Code**.
3. Tap the squares in a pattern (from 6 to 8 taps) to set your Knock Code, tap **DONE**, enter it again, then tap **CONFIRM**.

To unlock the phone

If you don't use the phone for a while, the screen and backlight will turn off to conserve battery power. To unlock the phone's default Lock screen:

NOTE The default Lock screen simply locks the screen to prevent unintentional actions. For more security to guard against unauthorized use, you can set an unlock requirement (such as a Knock Code, pattern, PIN, password) that will need to be entered to unlock it.

1. Turn the screen on.

Press the **Power/Lock Key**  (on the back of the phone).

NOTE Avoid covering the proximity sensor when turning the screen on. Doing so, immediately turns the screen off.

OR

- ▶ Quickly double-tap the center of the screen (KnockON).

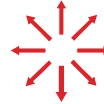

2. From the center of the screen, swipe in any direction to unlock it.

- ▶ To use a shortcut, swipe the shortcut icon (at the bottom of the screen) in any direction. The screen will unlock and launch the app.

Your Google Account

You must sign into a Google Account to use Gmail, Hangouts, Google Calendar, and other Google apps; to download apps from Play Store; to back up your settings to Google servers; and to take advantage of other Google services on your phone.

IMPORTANT

- If you don't sign into a Google Account during setup, you're prompted to sign in or to create a Google Account the first time you start an app that requires one, such as Gmail or Play Store.
- When you sign in, you're prompted to enter your username and password using the on-screen keyboard.
- After you sign in, your contacts, Gmail messages, Calendar events, and other information from these apps and services on the web are synchronized with your phone.
- If you have an enterprise account through your company or other organization, your IT department may have special instructions on how to sign in to that account.

Setting up your Google Account

If you use Setup Wizard to set up your Google Account, it guides you through the following steps.

1. On your phone, launch an application that requires a Google Account (such as Play Store or Gmail).
2. Enter your email and tap **NEXT**.

NOTE If you don't already have a Google Account, tap **Create a New Account** and follow the on-screen prompts to create your new account.

3. Enter your password and tap **NEXT**.
4. Follow the rest of the instructions on the screen.

Your Gmail, Google Contacts, and Google Calendar events will all be synchronized with your phone automatically.

Touch Screen

Your touch screen provides an excellent way to interact with and use your Android™ phone. With the touch of your finger, you can download and use available apps, make menu selections, and access data saved to your phone.

Touch or tap A single finger touch selects items. For example, tap an icon (e.g., an app, widget, or folder), tap words (e.g., menu selection or to answer an on-screen question), or touch letters and numbers to type.

NOTE Don't press too hard on the screen. It's sensitive enough to detect a light, firm tap.

Touch and hold Touch an item on the screen and don't lift your finger until an action occurs. For example, to open a context menu for a contact, touch and hold the contact entry until the menu pops up.

Drag Touch and hold an item for a moment and then, without lifting your finger, move your finger on the screen until you reach the target position. For example, you can drag items on the Home screen to reposition them.

Swipe, slide, or flick Move your finger quickly across the surface of the screen, without pausing when you first touch it (so you don't drag an item instead). For example, you can browse through the Home screens by swiping left and right, slide the screen up or down to scroll through a list, or remove an app from the Recent apps screen by flicking its graphic off the screen.

Double-tap Tap the screen twice quickly to zoom, highlight text, or turn the screen on/off. For example, quickly double-tap a section of a web page to zoom that section to fit the width of the screen and control the zoom in Maps and in other apps. Double-tap a word to highlight it. Double-tap can also activate the KnockON feature to turn the screen on or off. Double-tap also activates a new event in the Calendar app.

NOTE The Accessibility settings shortcuts and Touch zoom accessibility features use a triple-tap.

Pinch-to-zoom Use your index finger and thumb in a pinch motion (to zoom out) or spread motion (to zoom in) when using Chrome, a map, photos, the rear camera lens, the Contacts list, the Favorites list, the

Groups list, the Messaging list, and a music list. Spread apart to make screen information larger (easier to see and read), or pinch together to view more area and information. The pinch gesture also changes the Home screen. Pinch in on the Home screen to change to mini panel view, then spread apart to return to the full screen view. Spread apart on the Home screen to hide all of your Home screen items, then pinch in to redisplay them.

Rotate the screen From many apps and menus, the orientation of the screen adjusts to the phone's physical orientation by rotating the screen. You can deactivate this function in the Display settings menu.

Getting to Know the Home Screen

The Home screen is your starting point to access all of the features on your phone using simple motions on the screen. It's comprised of multiple panels (swipe horizontally to switch). You can customize all of your Home screen panels with app shortcuts, icons, widgets, and other features.

Status Bar 
Shows device status information, including the time, signal strength, battery status, and notification icons.

App Icon 
Tap an icon (app, widget, folder, etc.) to open and use it.

Quick Access Bar 
Icons that provide easy, one-touch access to the functions used most often.

Apps Icon 
Tap here to open the Applications screen to view all of your installed apps.

Home Touch Buttons 
Displayed on all screens, these buttons allow you to easily navigate within the device software.

Quick Access Bar icons

The Quick Access Bar is located on all of your Home screen panels to allow quick and easy access to the apps you use most often.

Modifying the Quick Access Bar icons

- ▶ **Rearrange:** Touch and hold the icon to move, then drag it to another position in the Quick Access Bar.
- ▶ **Add:** Open the Applications screen, then drag the icon you want onto the Quick Access Bar.
- ▶ **Delete:** Touch and hold the icon to delete, then drag it to the Remove bar that appears at the top of the screen.

Home Touch Buttons

The Home Touch Buttons are displayed in a bar at the bottom of all of the screens to provide easy navigation within the device software.

- ◀ **Back Button:** Tap to back up one step at a time and close on-screen items such as pop-up messages, the on-screen keyboard, etc.
- **Home Button:** Tap to immediately return to the Home screen. Touch and hold it to access the Google Now shortcut.
- **Recent Apps Button:** Tap to display the apps you recently used as well as all of your open websites. Touch and hold it to access available options for the current screen or app.

Modifying the Home Touch Buttons

You can change which buttons are displayed in the Home Touch Buttons Bar, as well as how they're displayed.

1. Tap the **Home Button** ○ > touch and hold the **Recent Apps Button** □ > **Settings > Display > Home touch buttons.**
2. Select the modification you want to change.
 - ▶ Tap **Button combination** to select which Home Touch Buttons you want in the bar and their location within the bar. Choose from the **Back Button**, the **Home Button**, the **Recent Apps Button**, the **Notifications Button**, the **Capture+ Button**, the **QSlide Button**, and the **Dual window Button**.
 - ▶ Tap **Color** to set the button color. Choose **White** or **Black**.

22 The Basics

- ▶ Tap **Hide Home touch buttons** to hide the Home Touch Buttons on the apps you select. To access the Home Touch Button Bar from those apps, swipe upward from the bottom of the screen to temporarily redisplay them.

To return to the Home screen

- ▶ Tap the **Home Button**  at any time, from any app.

To view other Home screen panels

Swipe (or flick) your finger left or right across the Home screen. The Home screen is comprised of four sliding panels, but you can add up to eight panels to allow more space for icons, widgets, shortcuts, and other items.

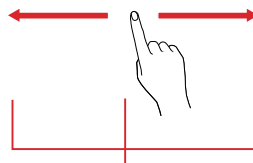

Home Screen Panel Indicator

The white dot (above the Quick Access Bar) indicates the current Home screen panel.

- ▶ Tap any of the Home screen panel indicator dots (above the Quick Access Bar) to immediately jump to that panel.
- ▶ Pinch in on the Home screen to display the mini panel view, then tap the Home screen panel you want to access.

Mini Panel View

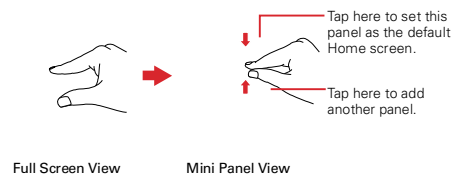



Full Screen View

Mini Panel View

Mini panel view allows direct access to any of the Home screen panels and also allows you to manage them. You can add, delete, and rearrange the panel order as well as set the default Home screen panel.

Pinch in on any of the Home screen panels to change from full screen view to mini panel view. From mini panel view you have the following options:

- ▶ To go directly to any panel, simply tap the one you want.
- ▶ To add another panel, tap the **Add panel** icon .
- ▶ To delete a panel, touch and hold the panel to delete, drag it to the Remove bar at the top of the screen, then lift your finger.
- ▶ To rearrange your panels, touch and hold the panel to move, drag it on top of the panel position where you want it, then lift your finger. The moved panel takes that position and the remaining panels shift accordingly.
- ▶ To set another panel as the default Home screen, tap the **Default** icon  at the upper-right corner of the mini panel you want to be your default Home screen panel.

NOTE Changing the default Home screen panel does not change its position with the other panels, but its **Default** icon turns blue.

Hiding items on the Home screen

Place two fingers on the screen, then spread them apart to hide the items on your Home screen so that only your wallpaper, the Status Bar, and the Home Touch Buttons Bar are displayed. To redisplay your Home screen with all of its icons and widgets, pinch in on the screen or tap the **Back Button** ◀.

NOTE The device automatically reverts to the full screen view after screen timeout.

Using Dual View

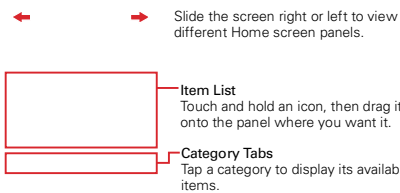

Dual view allows you to easily add items to any of the Home screen panels. Touch and hold an empty spot on a Home screen panel to view your Home screen on top and selections (**Apps** tab, **Widgets** tab, or **Wallpapers** tab) on the bottom. Flick sideways to scroll through the Home screen panels to display the panel you want. Tap the type of item you want to add (from the categories tabs at the bottom of the screen), then flick sideways to scroll through the available choices. Simply tap the item you want to automatically add it to the panel viewed at the top of the screen.

NOTE The Quick Access Bar isn't displayed while in Dual view.

To return to the full screen view, tap the **Back Button** ◀ or tap one of the Home screen panels.

NOTE The device automatically reverts to full screen view after screen timeout.

Home screen version

EasyHome is a more simplified version of the Home screen that you can choose to use on your phone.

Tap the **Home Button** ○ > touch and hold the **Recent Apps Button** □ > **Home screen settings** > **Select Home** > **EasyHome**.

The EasyHome Home screen has three panels.

Its main panel has 12 application icons that you can use with a single tap. Touch and hold one to remove or replace it. The top right of the screen displays the date and time. Tap it to access the **Clock** app. The top left of the screen displays a **Weather** widget. Tap it to access the **Weather** app.

- ▶ Swipe to the right on the main panel to access a panel you can customize with call/text message shortcuts for the contacts you set and also open your call history. Tap **Call logs** to open the Phone app's **Recent** tab that lists all of your recent calls. Tap one of the 12 Contact shortcut locations, then tap the contact you want to set. After a shortcut is set, tap it to use it or delete it.
- ▶ Swipe to the left on the main panel to access a panel you can customize with additional app shortcuts and also open the Applications screen. Tap **View all apps** to open the Applications screen with all of your installed apps. To add an app icon, tap the **Add** icon +, then tap the app you want.

To change back to the Android Home screen

Tap the **Home Button** ○ > touch and hold the **Recent Apps Button** □ > **System settings** > **Home screen** > **Select Home** > **Home**.

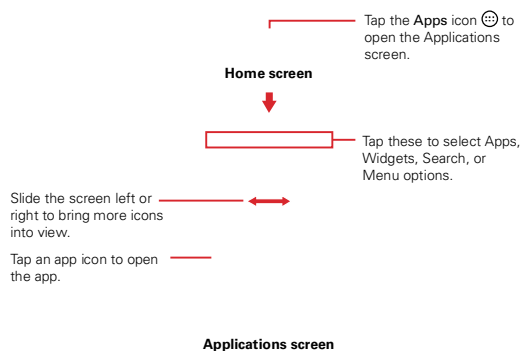

Apps: How to View, Open, and Switch

All of the apps on your phone, including any apps that you downloaded and installed from Play Store or other sources, are grouped together on the Applications screen, which you access from your Home screen. If you have more apps than can fit on the Applications screen, you can slide the screen left or right to view more.



Applications screen options

You can change the look of your Applications screen.

1. Tap the **Home Button**  > the **Apps icon** , then tap the **Apps tab**, if necessary.
2. Tap the **Menu icon**  to access the following Applications screen options:
 - ▶ **View apps by:** Tap to sort your apps either in alphabetical order, by downloaded date, or custom.



- ▶ **Show small/large icons:** Tap to change the size (large or small) for the icons displayed in the Applications screen.
- ▶ **Hide/Show apps:** Tap to set which app icons will be displayed in your Applications screen. Checkmark the icons you want to hide, then tap the Checkmark icon .
- ▶ **Edit/Uninstall apps:** Tap to view app information or move apps on the screen. Tap an app icon to view its information. Touch and hold an app, then drag it to move it.
- ▶ **Home screen settings:** Tap to access the Home screen settings menu.

Opening an app



- ▶ Open an app simply by tapping its icon on the screen.

TIP You can customize your Home screen with the app icons you use most often. Apps are located on the Applications screen, but you can copy any app icon to your Home screen for faster, more convenient access. No matter where the icon is, on the Applications screen or your Home screen, just tap it to open and use it.

Opening multiple apps



1. Tap an app icon to open it.
2. Tap the **Home Button** .
- NOTE** If the app icon you want is on your Home screen, simply tap the icon to open and use it.
3. Tap the **Apps** icon .
4. Tap the **Apps** tab (if necessary), then tap the icon for the other app you want to open.

Switching between multiple apps

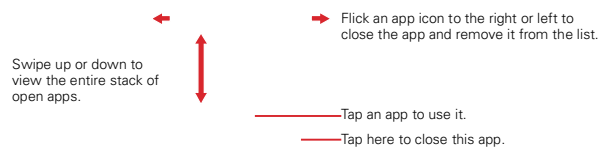
1. Tap the **Recent Apps Button** . A screen opens and displays screenshot tabs of all of the apps (and websites) that are currently open.
2. Tap the app you want to use, tap the **Close** icon  on the app to close it, or tap the **Back Button**  to return to the current screen.



Adding items to the Home screen

1. Tap the **Home Button**  > the **Apps icon** , then tap the **Apps tab**, if necessary.

NOTE You can tap the **Widgets** tab (at the top of the screen) to place a widget on the Home screen.

2. Touch and hold the icon you want to add to your Home screen. The Applications screen closes and the Home screen is displayed.
3. Drag the icon to where you want it on the screen, then lift your finger.

Moving apps to other Home screen panels

You can move app icons to any Home screen panel. Touch and hold, then drag the icon to the left or right edge of the screen to advance to the other panels before lifting your finger.

Customizing an app icon on your Home screen

You can create your own custom app icon(s) using the images in your Gallery. Your customized app icon(s) are only applied to icons on your Home screen. The Applications screen is not affected.

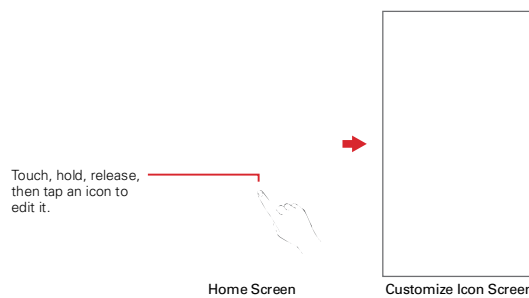



1. Touch and hold the icon you want to customize, then release the icon. An editing icon  appears at the upper-right corner of the app icon.

NOTE If an icon you placed can be resized, you'll see a blue box around the icon after you touch, hold and release it. Drag the edges of the box to resize it.

2. Tap the app icon (while the edit icon is still displayed).
3. Tap the icon design you want from the available icon choices, then tap **OK**.

OR

Tap the **Add new icon**  set the size for the icon, then tap **OK**. Select the image you want to use for the app, crop the image (if necessary), then tap **OK**.

NOTE Your custom photo icons are saved so you can easily select them for any of your icon images. Tap the **Delete icon**  to remove any of your custom photo icons.

Changing an icon into a widget



Some app icons can be resized into a widget. Touch and hold the icon you want, then release the icon. A blue frame appears around the icon if it can be resized (if it can't, only the Edit icon is displayed). Drag the corners of the frame to size it as you want.

Text Input Methods

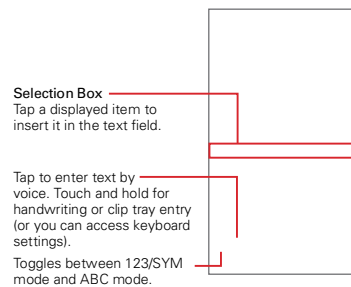
The on-screen keyboard displays automatically on the screen when you need to enter text. To manually display the on-screen keyboard, simply tap a text field where you want to enter text.

















Modifying your LG keyboard characteristics

Tap the **Home Button**  > touch and hold the **Recent Apps Button**  > **Settings** > **Language & keyboard** > **LG Keyboard** > **Keyboard height and layout**.



- ▶ The **QWERTY layout** setting allows you to select the default buttons on either side of the Space button.
- ▶ The **Extended keyboard** setting displays numeric buttons on the top row of the keyboard.
- ▶ The **Keyboard height** setting allows you to change the size ratio between the keyboard (including the size of its buttons) and the screen.
- ▶ The **Keyboard type in landscape** setting allows you to choose the type of keyboard you want to use when the phone is in landscape mode.
- ▶ The **Split keyboard** setting allows you to split the keyboard in half by spreading two fingers horizontally on the landscape keyboard. This makes it easier to type using your thumbs.

- ▶ The **One-handed operation** setting allows you to swipe the keyboard left or right to adjust the position of the LG keyboard to use just one hand to type.

Typing tips	
Enter other characters	Tap the Numbers/Symbols button  to display its keyboard. Tap the Arrow buttons   on the left side of the keyboard to view additional symbols. From the Numbers/Symbols keyboard, you can also tap the Graphics button  to enter graphics into your text. To enter foreign characters, touch and hold the associated button to display a pop-up of character choices (e.g., the “a” button also includes an accent mark “á”), drag your finger to the character you want, then lift your finger.
Enter one capital letter	Tap the Shift button  to capitalize the next letter. The button changes to  .
Enter all capital letters	Double-tap the Shift button  to set caps lock. The button changes to  . Tap again to revert to lowercase.
Highlight text	Double-tap a word to highlight it. To highlight a range of text, double-tap a word, then drag the blue highlight markers to highlight the text you want.
Cut or copy selected text	Highlight the desired text, then tap CUT or COPY in the action box above the highlighted text.
Paste cut or copied text	Tap the location where you want to paste the text, then tap the marker  . Tap PASTE in the action box that appears.
Delete a character	Tap the Delete button  .
Entering text using handwriting	Touch and hold the Voice input button  , then drag your finger to the Handwriting icon  (in the pop-up that appears).

Accessing the Clip Tray and keyboard settings	Touch and hold the Voice input button  , then drag your finger to the Clip Tray icon  or the Settings icon  (in the pop-up that appears).
Path input text entry	Swipe your finger through all of the letters of the word you want to automatically enter it (instead of tapping each letter separately). NOTE Enable the Path input setting to use this feature.



Text input settings

To change your text input settings and see the dictionary of terms you've used, tap the **Home Button**  > touch and hold the **Recent Apps Button**  > **Settings** > **Language & keyboard**. From this menu you can change the language for your phone's software, set your keyboard input (including setting multiple languages and how it reacts), set Google voice settings, set your voice search and text-to-speech output preferences, as well as the set the pointer reaction time. See the Settings section for more information about the keyboard settings.



Languages

You can set only one default language for your phone, but you can set multiple languages used for the on-screen keyboard.



To change the default language



- ▶ Tap the **Home Button**  > touch and hold the **Recent Apps Button**  > **Settings** > **Language & keyboard** > **Language** > tap the language you want.

To add additional languages for your keyboard

- ▶ Tap the **Home Button**  > touch and hold the **Recent Apps Button**  > **Settings** > **Language & keyboard**. Tap **LG Keyboard**, tap **Input language and keyboard layout**, then checkmark the languages you want the keyboard to be able to use.

Capturing a Screenshot

Press and hold the **Volume Down Key**  and the **Power/Lock Key**  at the same time for 2 seconds to capture a screenshot of the current screen.

To view the captured image, tap the **Home Button**  > the **Apps icon**  > **Gallery**  > the **Screenshots** folder.

Using Capture+ to capture a screenshot

On the screen you want to capture, drag the Status Bar downward and tap the **Capture+ icon**  (in the Quick settings bar).

Phone's Status Icons





The Status Bar appears at the top of every screen. It displays icons indicating that you've received notifications (on the left) and icons indicating the phone's status (on the right), along with the current time.









If you have more notifications than can fit in the Status Bar, the **More notifications icon**  is displayed as an indicator to open the Notifications panel to view them all.

The following icons may appear in the Status Bar.



















Call icons

	In call		Missed call
	Speakerphone is on		Microphone is muted
	Video call		













Sound icons

	Silent mode		Do not disturb - Priority only
	Vibrate mode		Do not disturb - Total silence
	Music is playing		Music is paused







Network icons

	3G connection		3G in use
	4G LTE connection		4G LTE in use
	Wi-Fi connection		Signal strength
	No signal		Roaming
	Network Extender		No SIM card
	Unknown SIM card		Airplane mode is activated
	GPS is on		App update is available
	App update successful		Downloading
	Uploading		Download successful
	Emergency Alert		

Connectivity icons

	Syncing		Mobile Hotspot is on
	USB connected		USB debugging mode
	USB tethering		Bluetooth device connected
	Bluetooth is on		Bluetooth headset full battery
	Bluetooth headset low battery		
	Headset is connected		Headset with microphone is connected
	Internal storage is full		Miracast connected





Email and Messaging icons

	New email		New Gmail message
	New message		New Verizon message
	New voice mail		Email not sent
	Message not sent		



Calendar and Alarm icons

	Alarm is set		Upcoming event
---	--------------	---	----------------





Battery icons

	Full battery		Charging battery
	Low battery		Empty battery
	Not Charging		

Other icons

	More notifications available		Screenshot saved
	Keyboard		

Calling icons

	Incoming call		Outgoing call
	Missed call		Rejected call

Managing Notifications

Notification icons report the arrival of new messages, calendar events, alarms, as well as ongoing events, such as when you're on a call. When you receive a notification, the notification icon will be displayed in the Status Bar. You can open the Notifications panel to view a list of all of your recent notifications. Depending on your settings, you may hear a notification sound, and/or see a notification light (at the upper-left corner of the phone), and/or the phone may vibrate.

To open the Notifications panel

Touch and drag the Status Bar to the bottom of the screen.

The Notifications panel displays a list of your current notifications, organized into ongoing and event-based notifications. The Quick settings bar (at the top of the panel) allows you to quickly and easily change commonly used settings.

NOTE You can also access the complete Settings menu from this panel by tapping the **Settings icon** 

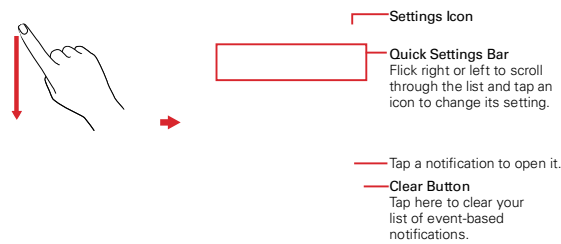

Home Screen

Notifications Panel

To respond to a notification

1. Open the Notifications panel. Your current notifications are listed in the panel, each with a brief description.
2. Tap a notification to view it.



The Notifications panel will close and the app that corresponds to your selection will open. For example, new voice mail notifications dial your voice mail box and Gmail notifications open the Gmail app so you can read your new messages.

Quick settings on the Notifications panel

The top of the Notifications panel includes a Quick settings bar. The icons in this bar provide a quick, convenient way to change settings without accessing any apps. If you set more than five icons on the bar, swipe left and right to scroll through the list.

Customizing the Quick settings bar icons

You can set the order of the icons displayed in the Quick settings bar as well as which icons are displayed.

1. Open the Notifications panel, then tap the **Edit** icon  (at the right side of the Quick settings bar).
 - ▶ Drag one of the icon handles  at the right side of the screen to move its icon to another position in the Quick settings bar.
 - ▶ Checkmark each of the items you want to appear in the Quick settings bar.

NOTE Changing the checkmarks reorganizes the icons in the Quick settings bar.

2. Tap the **Back Button**  to return to the Notifications panel.

QSlide apps on the Notifications panel

You can choose to display QSlide apps in a bar on the Notifications panel below the Quick settings bar. These icons provide a quick, convenient way to multi-task on the same screen (similar to picture-in-picture on a TV). QSlide displays a small app window on the screen that can be moved, resized, or made transparent.

Tap any of the QSlide apps in the bar to activate it. You can open up to two QSlide windows at a time.

Searching Your Phone and the Web

You can search for information on your phone and on the web using the **Google search** app.

Some apps, such as Gmail, Contacts, and Chrome, have the ability to search for contents within those specific apps.

You can conduct the search by typing in the search terms or saying what you're looking for. As you enter text, the search app can provide suggestions so you don't necessarily have to type out your full request.

Phone and Web search using text entry

1. Tap the **Google Search Widget**  on the Home screen.

Google Now opens automatically and you can use the on-screen keyboard to search or tap the **Microphone** icon  to say what you're looking for.

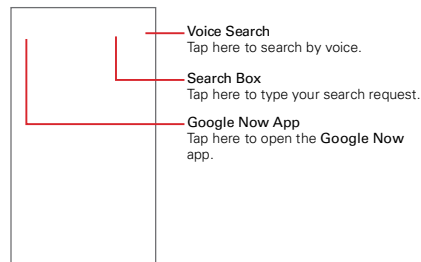

2. Enter the text you're searching for in the search box.

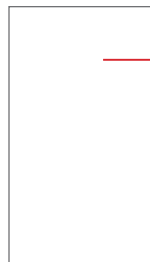

As you type, search results from your phone, previous search terms, and web search suggestions appear. Tap an item to activate that search result.

3. Tap the **Search button**  on the on-screen keyboard to search for the text you entered in the search box.

TIP The bottom of the search results screen includes a search category bar. You can scroll through them, then tap one to display your results using only that category.

Google Search Options menu

From the Search app, touch  to access **Settings**, **Send feedback**, and **Help**.

Search preference settings



You can use the Search preference settings to configure some aspects of web search and what phone features you want to include in your searches. To access these settings:

1. From the Search app, touch  > **Settings**.
2. Select **Accounts & privacy**, **Search language**, **Voice**, **Phone search**, or **Now cards**, then adjust the settings as necessary.

Setting Your Lock Screen

There are several Lock screen types allowing you to lock your phone so that only you can unlock it to make calls, access your data, buy apps, and otherwise prevent unauthorized use.

Setting a Screen Lock for the First Time

1. Tap the **Home Button**  > touch and hold the **Recent Apps Button**  > **Lock screen settings**.
2. Tap **Select screen lock**.
3. Tap **Swipe, Knock Code, Pattern, PIN, or Password**.

Swipe: A swipe motion in any direction on the screen will unlock the screen. This is the default Lock screen that simply guards against unintentional actions.

Knock Code: Unlocks the screen using a tapping a sequence on the screen's 2x2 grid. (When the screen is in timeout, the 2x2 grid is invisible, but the grid is displayed on the Knock Code Lock screen.) The first time you set a Knock Code, you'll see a tutorial with instructions on how to create it. Tap a sequence on the 2x2 grid (from 6 to 8 taps), then tap **DONE**. Tap your sequence again and tap **CONFIRM**.

NOTE You're prompted to create a Backup PIN as a safety measure in case you forget your Knock Code unlock sequence.

Pattern: Unlocks the screen using a pattern you draw with your finger. The first time you set an unlock pattern, you'll see a tutorial with instructions on how to create it. Read the tutorial, then tap **NEXT**. Draw your pattern (connect at least 4 dots) and tap **NEXT**. Then redraw your pattern and tap **CONFIRM**.



NOTE You're prompted to create a Backup PIN as a safety measure in case you forget your unlock pattern sequence.

PIN Unlocks the screen with a number sequence. Enter a PIN (at least 4 digits) and tap **NEXT**. Reenter your PIN and tap **OK** to confirm it.

Password Unlocks the screen with an alphanumeric sequence. Enter a password (at least 4 characters) and tap **NEXT**. Re-enter your password and tap **OK** to confirm it.

From then on, any time you want to unlock the screen, you'll need to perform the unlock action you set (swipe, Knock Code, pattern, PIN, or password) to gain access to it.

Changing Your Screen Lock



1. Tap the **Home Button**  > touch and hold the **Recent Apps Button**  > **Lock screen settings**.
2. Tap **Select screen lock**.
3. Confirm your unlock information (if necessary).
4. Tap the desired screen lock option.
5. You're prompted to enter your screen unlock sequence (and Backup PIN, if necessary).

NOTES

- If you've set up a Microsoft Exchange account, you might only be able to use a password.
- After 5 unsuccessful attempts to unlock your phone, you're prompted to enter a text phrase to confirm that you're trying to unlock your phone.
- You have 10 opportunities to enter your unlock sequence. After 10 unsuccessful attempts, your phone will automatically perform a factory data reset and all of your personal files will be erased. You will be warned after the 9th unsuccessful attempt.
- If you've set a Knock Code, after 6 unsuccessful attempts, you're prompted to enter your Backup PIN to unlock your phone.



The Lock screen wallpaper

You can set the Lock screen wallpaper separately from your Home screen wallpaper.

1. Tap the **Home Button**  > touch and hold the **Recent Apps Button**  > **Lock screen settings**.
2. Tap **Wallpaper**.
 - ▶ Tap **Wallpaper gallery** to select one of the available wallpaper images.
 - ▶ Tap **Gallery** to select an image from your Gallery.



Security lock timer

If a security lock is enabled, you can set the delay time after the screen darkens due to inactivity before the screen automatically locks and requires you to enter your unlock sequence.

1. Tap the **Home Button**  > touch and hold the **Recent Apps Button**  > **Lock screen settings**.
2. Tap **Security lock timer**, then tap the setting you want to use.

Power button instantly locks



If a security lock is enabled, checkmark the **Power button instantly locks** checkbox to override the Security lock timer setting and lock the screen as soon as you press the **Power/Lock Key**  (on the back of the phone).

1. Tap the **Home Button**  > touch and hold the **Recent Apps Button**  > **Lock screen settings**.
2. Checkmark the **Power button instantly locks** checkbox.



Dual Window

The Dual window function splits the screen to enable multi-tasking, drag and drop interaction, auto-linking, and recently used apps.







To activate the Dual window function

1. Tap the **Home Button**  > touch and hold the **Recent Apps Button**  > **Settings** > **Dual window**.
2. Tap the **Dual window** switch  to toggle it On (blue).
 - ▶ Checkmark the **Auto-open** checkbox to automatically open the Dual window function when you tap a link on the full screen or tap an email image attachment.

Using the Dual window function

1. Tap the **Home Button**  > the **Recent Apps Button**  > **Dual window** to split the screen.

TIP While viewing an app, you can tap the **Recent Apps Button**  > **Dual window** to automatically set that app in the top window, then select the second app.

2. Tap the app icon you want to use. The first app you tap opens in a window at the top of the screen. The second app opens in the bottom window.
3. Tap a window to select and use it.
 - ▶ A blue box appears around the selected window with a blue semi-circle handle between the windows.
 - ▶ Drag the blue handle to change the window sizes (one larger and one smaller).
4. Tap the blue handle  to access the Dual window options.
 - ▶ Tap the **Swap** icon  to switch (flip) the app positions.
 - ▶ Tap the **View app list** icon  to redisplay the apps list so you can change the app for the selected window.
 - ▶ Tap the **Open full screen** icon  to open the selected app in full screen. Drag the blue handle (or tap the **Close full screen** icon ) to return to Dual window.
 - ▶ Tap the **Close** icon  to close the selected window.





Wi-Fi

With Wi-Fi, you can use high-speed Internet access within the coverage of the wireless access point (AP). Enjoy wireless Internet using Wi-Fi, without extra charges.

Connecting to Wi-Fi networks

To use Wi-Fi on your phone you need to access a wireless access point or 'hotspot'. Some access points are open and you can simply connect to them. Others are hidden or use security features. You must configure your phone to be able to connect to them. Turn off Wi-Fi when you're not using it to extend the life of your battery.

Turning Wi-Fi on and connecting to a Wi-Fi network





1. Tap the **Home Button**  > tap **Apps** icon  > **Settings**  > **Wi-Fi**.
2. Tap the **Wi-Fi** switch  to turn Wi-Fi on and start scanning for available Wi-Fi networks.
3. Tap **SEARCH** to see a list of active and in-range Wi-Fi networks.
 - ▶ Secured networks are indicated by a lock icon.
4. Tap a network to connect to it.
 - ▶ If the network is secured, you're prompted to enter a password or other credentials. (Ask your network administrator for details.)

The Status Bar displays icons that indicate your Wi-Fi status.

Wi-Fi Direct

Wi-Fi Direct provides a direct connection between Wi-Fi enabled devices without requiring an access point.

Turning on Wi-Fi Direct

1. Tap the **Home Button**  > the **Apps** icon  > **Settings**  > **Wi-Fi**.
2. Tap the **Menu** icon  > **Advanced Wi-Fi** > **Wi-Fi Direct**.

NOTE When in this menu, your device is visible to other visible Wi-Fi Direct devices nearby.





Bluetooth

You can use Bluetooth to send data by running a corresponding application, but not from the Bluetooth menu as on most other mobile phones.

- NOTES**
- LG is not responsible for the loss, interception, or misuse of data sent or received via the Bluetooth wireless feature.
 - Always ensure that you share and receive data with devices that are trusted and properly secured. If there are obstacles between the devices, the operating distance may be reduced.
 - Some devices, especially those that are not tested or approved by Bluetooth SIG, may be incompatible with your device.

Turning on Bluetooth and pairing your phone with a Bluetooth device

You must pair your device with a Bluetooth device before you connect to it.

1. Tap the **Home Button**  > the **Apps icon**  > **Settings**  > **Bluetooth**.
2. Tap the **Bluetooth** switch  to turn Bluetooth on, then tap **SEARCH** to view the devices within your phone's range.
3. Choose the device you want to pair with from the list.

Once the pairing is successful, your device will connect to the device.

- NOTE** Your phone doesn't support the hands-free profile. Therefore, the use of call features with some accessories, such as Bluetooth headsets or Bluetooth-enabled devices, may not be available for this device.

Send data using the Bluetooth wireless feature

1. Open the item you want to send, then tap the **Sharing icon** .

OR

Touch and hold the item you want to send, then select **Share**.

OR





Open the item you want to send, then tap the **Menu icon**  > **Share**.

2. Tap **Bluetooth** to share via Bluetooth.

- NOTE** The method for selecting an option may vary by data type.



3. Search for and pair with a Bluetooth-enabled device.

Receive data using the Bluetooth wireless feature

1. Tap the **Home Button**  > the **Apps icon**  > **Settings**  > **Bluetooth**.
2. Tap the **Bluetooth** switch  to turn Bluetooth on.
3. Pair the devices and tap **Accept** when you receive a Bluetooth Authorization Request to accept the file(s).

SmartShare

SmartShare allows you to send and receive multimedia content between compatible devices.

1. While viewing the content you want to share, tap the **SmartShare** icon  or tap the **Menu** icon  > **SmartShare**.
2. Tap the device you want to share from the list.
 - ▶ If the device isn't displayed on the list, make sure that Wi-Fi, Wi-Fi Direct, or Bluetooth is turned on. Then tap **RESCAN**.
3. Tap **Send** to share the files.

Enjoying content from nearby devices

1. To connect nearby devices to your device, tap the **Nearby devices** option in the **Gallery** and **Music** apps (swipe from the left edge of the screen to the right).
 - ▶ Make sure that your device and nearby devices are connected to the same Wi-Fi network and that the DLNA service on the nearby device is turned on.
2. Tap the device you wish to connect to.
 - If the device isn't listed, tap **Search nearby devices**.
3. After a connection is established, you can access the content on your device.

PC connections with a USB cable

You can connect your phone to your PC to charge it and transfer items to the PC from the phone (and vice versa).

Synchronize with Windows Media Player

Ensure that Windows Media Player is installed on your PC.

1. Use the USB Cable to connect the phone to a PC on which Windows Media Player has been installed.
2. When connected, a pop-up window will appear on the PC. Select the Windows Media Player option to synchronize music files.
3. Edit or enter your device's name in the pop-up window (if necessary).
4. Select and drag music files to the sync list.
5. Start synchronization.

- ▶ The following requirements must be satisfied to synchronize with Windows Media Player.

Item	Requirements
OS	Microsoft Windows XP SP2, Vista or higher
Window Media Player version	Windows Media Player 10 or higher

- ▶ If the Windows Media Player version is older than 10, install version 10 or newer.

PC connections with a USB cable for Mac OS X users



You can transfer media contents to your Mac OS X PC from the phone and vice versa by setting up the Android File Transfer program.

1. Download and install the Android File Transfer program from the android.com website for Mac Users (<http://www.android.com/filetransfer/>).
2. Connect your phone to your computer, and double click the AFT (Android File Transfer program) application to start it up.
3. You can view the media contents, drag and drop the media file to and from the phone (or PC).

Placing and Ending Calls

The Phone app allows you to dial phone numbers manually or make calls from your phone's memory. Manually dial calls using the Dial tab. Dial from your phone's memory using the Recent calls tab, the Contacts tab, the Favorites tab, or the Groups tab.

To open the Phone app





- ▶ Tap the **Home Button**  > the **Phone icon** .

Moving between the Phone app tabs



Tap any of the Phone app tabs (Dial, Recent, Contacts, Favorites, and Groups) at the top of the screen to view that tab. You can also swipe the screen horizontally to scroll to the other tabs. The current tab is displayed in white.

Modifying the Phone app tabs





You can rearrange the order of the Phone app tabs and/or delete the Favorites and Groups tabs.

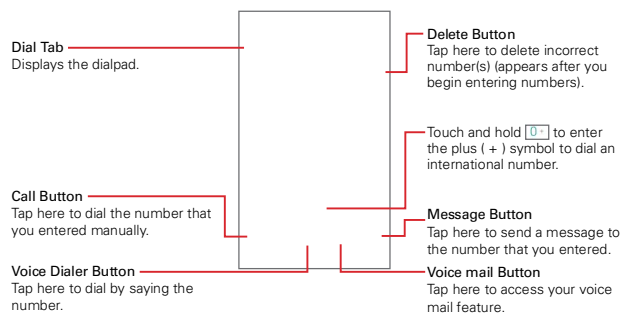

1. Tap the **Home Button**  > the **Phone icon** .
2. Tap the **Menu icon** , then tap **Edit tabs**.
 - ▶ Drag a tab handle  to move it to the position where you want it in the list.
 - ▶ Tap the **Favorites** or **Groups** checkbox (checkmark displays the tab, no checkmark deletes it from the Phone app tabs bar).
3. When you're finished making changes, tap the **Back Button** .

To place a call by dialing

1. Tap the **Home Button**  > the **Phone icon**  > **Dial tab**.



2. Use the dialpad to enter the number you want to call.
 - ▶ Tap the **Delete** button  to erase digits one by one.
 - ▶ To erase the entire number, touch and hold the **Delete** button .
 - ▶ To dial an international number, touch and hold  to enter the plus (+) symbol. Then enter the international prefix for the country, followed by the full phone number.
3. Tap the **Call** button  (on the dialpad) to dial the number that you entered.
 - ▶ Press the **Volume Keys** to adjust the call volume.
 - ▶ Use the on-screen buttons to enter additional numbers, place the call on hold to take another incoming call, add another call, use the speakerphone, end the call, and other options.
 - ▶ You can use other phone features while the call is underway. If you open another app, the **Ongoing call** icon appears on the screen for the duration of the call.

NOTE If you opened other apps while on a call, you'll need to return to the Call screen to end the call. To return to the Call screen, simply tap the **Ongoing call** icon (at the upper-left corner of the screen). You can also tap the **Home Button** , then tap the **Phone** icon  or drag the Status Bar down and tap the Current call notification on the Notifications panel.



You can make High Definition Voice and Video calls as well as calls over Wi-Fi when you add Advanced Calling to your line.

Visit [VerizonWireless.com/Advanced Calling](http://VerizonWireless.com/AdvancedCalling) to learn how.

To end a call

- ▶ Simply tap the **End** button  on the Call screen to end the call.

If you accessed other device functions while the call was in progress, there are several ways to return to the Call screen to end the call.

- ▶ Tap the **Ongoing call** icon (at the upper-left corner of the screen).
- ▶ Tap the **Home Button** , then tap the **Phone** icon .

TIP If necessary, you can drag the **Ongoing call** icon to move it somewhere else the screen while using other device functions.

Drag the Status Bar down, then tap the Current call notification on the Notifications panel.



NOTE You can also press the **Power/Lock Key**  to end the call, if you activated this feature in the Call settings (tap the **Menu** icon  in the Phone app).

Calling numbers in your phone's memory

You can place calls using information stored in your phone. Anywhere you see a **Call** icon  next to a number, tap it to automatically dial it.

Speed dialing

If you set up Speed dials in the Contacts app, you can dial a number by simply touching and holding the Speed dial number on the dialpad.

- ▶ Tap the **Home Button**  > the **Phone** icon  > **Dial** tab, then touch and hold the Speed dial number.

Direct dialing

A Direct dial widget is like a speed dial button on your Home screen. Tap it to automatically call the number you set (for example, your home phone number).

To place a Direct dial widget on your Home screen



1. Touch and hold an empty area on your Home screen.
2. Tap the **Widgets** tab > **Direct dial**.
3. Tap the contact in your Contacts list.

TIP You can change the look of each Direct dial widget for easy identification. Touch, hold, and release the Direct Dial widget, then tap it. Select a theme icon or a photo icon, then tap **OK**.

Answering or Rejecting Calls

When you receive a phone call, the Incoming call screen opens with the caller ID and any additional information about the caller that you've saved in the Contacts list. All incoming calls are recorded in the **Recent** tab.



To answer a call

- ▶ If the screen is unlocked, simply tap the **Answer** icon .
- ▶ If the screen is locked, swipe the **Answer** icon  in any direction to answer the call.
- ▶ If you were already on a call, tap the **Answer** icon  which places the first call on hold and connects the new call.

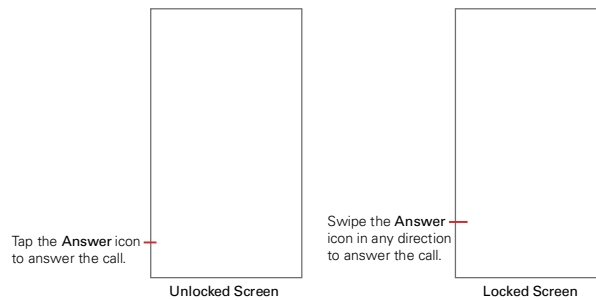
NOTE To silence the incoming call ringer, press either of the **Volume Keys**.



To ignore a call and divert it to voice mail

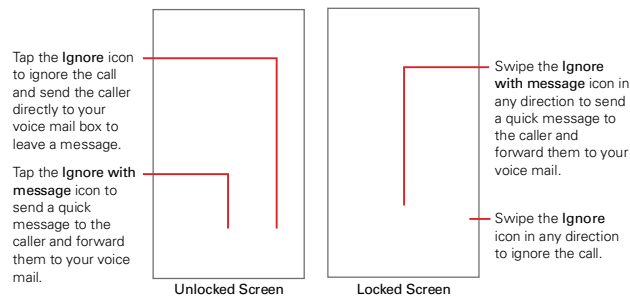

- ▶ If the screen is unlocked, simply tap the **Ignore** icon .
- ▶ If the screen is locked, swipe the **Ignore** icon  in any direction to ignore the call.
- ▶ The caller is sent directly to your voice mail box to leave a message.



NOTE To silence the incoming call ringer, press either of the **Volume Keys**.

To ignore a call and send a text message

To display the Ignore with message option on the incoming call screen, enable it in the Settings menu.

1. Tap the **Home Button**  > the **Phone icon**  > the **Menu icon**  > **Call settings**.
2. Tap the **Allow ignore with message** switch to toggle it On (blue).

TIP Tap **Allow ignore with message** to manage your text message choices.

To use the Ignore with message option, select it (tap or swipe its icon) on the incoming call screen, then tap the **Send icon**  next to the text message you want to send in place of answering the call.

TIP If you tap one of the text messages instead, the Messaging app opens so you can modify the text before sending it to the caller.

NOTE This feature can only be used to send a message to another mobile phone. It's not applicable to incoming landline calls.

Working With the Recent Tab

The Recent tab records all of the calls you've dialed, received, or missed. It offers a convenient way to redial a number, return a call, or add a number to your Contacts.



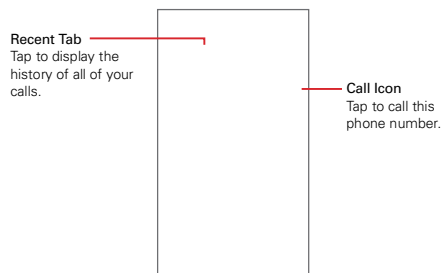

To open the Recent tab

- ▶ Tap the **Home Button**  > the **Phone icon** .

The Recent tab lists your calls chronologically by phone number. The number in parenthesis indicates the number of calls recorded for that phone number.



Viewing call entry details

Open the **Recent** tab, then tap an entry to view all of the entries for that phone number. Calls are listed chronologically and each one includes the call type (received , dialed , missed , and ignored ) , the date, the time of the call, and the phone number's home location.

Filtering your list of calls

To view a specific call list, from the **Recent** tab, tap the **Menu** icon , then tap **Filter**. Tap the call type you want to view.

Tap the **Back Button**  to return to the Recent tab screen.

To dial a number in the Recent tab

- ▶ From the **Recent** tab, tap the **Call** icon  at the right of the call entry.
- ▶ From the **Recent** tab, tap the image to the left of the call entry to view all of the contact's numbers saved in your phone's memory. Tap a phone number to dial it.

TIP To insert an area code when you're traveling, touch and hold the entry, then tap **Copy call number** in the context menu. Change to the **Dial** tab, touch and hold the phone number field, tap **PASTE**, then edit the number as necessary before tapping the **Call** button  on the keypad.

To add a number from the Recent tab to your Contacts

1. Open the **Recent** tab, then touch and hold the call entry.
2. Tap **Add to Contacts** in the context menu.
3. Tap **New contact** or **Update contact** and save it as necessary.

Clearing your Recent calls

You can delete the entire list of Recent calls at once or selectively delete entries.

1. Open the **Recent** tab.
2. Tap the **Menu** icon .
 - ▶ Tap **Clear** to select entries to remove from the list. Checkmark the entries to delete, tap **CLEAR**, then **YES**.
 - ▶ Tap **Clear all** to remove all of the entries from the list. Tap **YES** to confirm you want to Clear the entire list.



NOTE You can also select a specific number to be deleted. Touch and hold an entry in the **Recent** tab. Tap **Clear all logs of this number**, then tap **YES** to confirm.

Calling Your Contacts

Instead of manually dialing phone numbers using the dialpad, you can use your Contacts list to dial quickly and easily. You can also quickly call a contact using Quick Contact or Direct dial icons that you placed on your Home screen.



If you have contacts on the web, they're synchronized with your phone when you first synchronize with your Google™ Account.

To call a contact

1. Tap the **Home Button**  > the **Contacts** icon .
2. Tap the contact you want to call, then tap the contact's phone number you want to call.

TIP If the entry only has one phone number saved, simply tap the **Call** icon  next to the entry to dial it.

To call a favorite contact

1. Tap the **Home Button**  > the **Contacts** icon , then tap the **Favorites** tab.
2. Tap the contact you want to call.
3. Tap the contact's phone number you want to call.

Instant List

Instant list is displayed on the Dial tab to help you use the information stored in your phone without needing to search for it first. Once you begin entering numbers, Instant list displays entries from your Contacts list or Recent calls that match the sequence you entered.

Sequence matches

Your phone searches for the entered sequence within the area code, prefix, or last digits. The matching number sequence is displayed within the number in blue text. The name and type of number (i.e., Mobile, Work, etc.) associated with the number you entered is displayed above the dialpad. When there are multiple matches, the Instant list displays the number of

matches in your phone's memory. Tap the Instant list icon  on the right side of the screen to view the entire list of matching entries.

Selecting an Instant list entry

Tap an entry in the Instant list to insert it on the dialpad and tap the Call button  (on the dialpad) to dial it.

Options During a Call

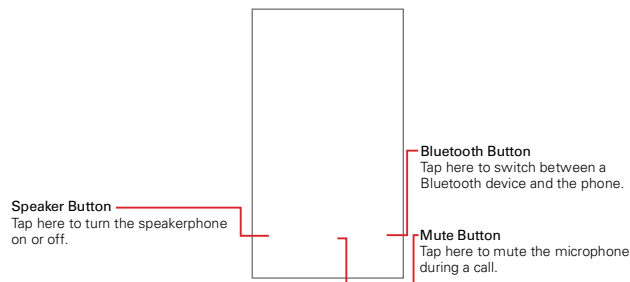

Managing Multiple Calls

Contact your wireless service provider to find out which call services are supported.

To switch between current calls



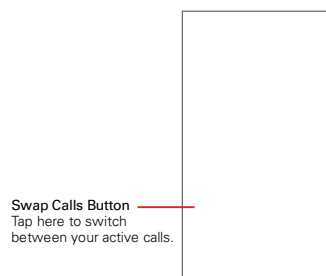

- ▶ Tap the **Swap calls** button  on the Call screen.

The current call will be placed on hold and you'll be connected with the other call.





To set up a conference call

Contact your wireless service provider to find out whether they support conference calls and how many participants you can include.

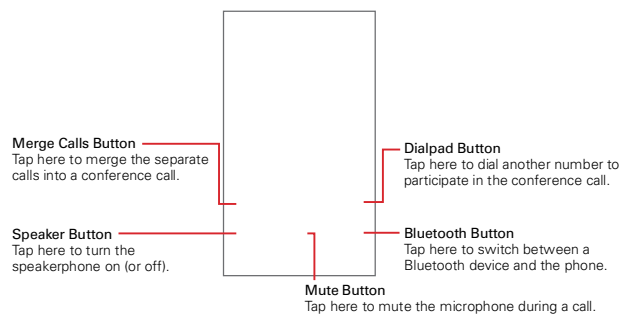



1. Place a call to the first participant.
2. When you're connected, tap the **Add call** button  on the Call screen.
3. Enter a phone number.
 - ▶ Use the **Phone** app tabs to select a saved number, then tap the **Call** icon .
 - OR**
 - ▶ Use the buttons on the dialpad to manually enter a number, then tap the **Call** button .
4. After you're connected, tap the **Merge calls** button  (on the Call screen). The participant is added to the conference call.



Listening to Your Voice mail



When you have a new voice mail message, the **Voice mail notification icon**  appears in the Status Bar. If you haven't set up your voice mail number, or if you need to change it, you can do that in the Call settings (tap the **Menu icon**  in the **Phone** app).

To listen to your Voice mail

- ▶ Open the Notifications panel and tap **New voice mail**.
- OR
- ▶ Tap the **Voice mail icon**  on the Home screen.
- OR
- ▶ Tap the **Home Button**  > the **Phone icon**  > **Dial tab** > the **Voice mail button**  (on the dialpad).

To set up your Voice mail

Typically, your carrier's voice mail system guides you through the process of listening to and managing your voice mail. The first time you call your voice mail, it also guides you through the process of recording greetings, setting a password, etc.

1. Tap the **Home Button**  > the **Phone icon**  > **Dial tab**.

60 Calls





2. Tap the **Voice mail** button  (on the dialpad) to dial your voice mailbox.
3. Follow the setup tutorial.
 - ▶ Enter a password.
 - ▶ Record a voice signature and greetings for your voice mailbox.

Chrome

The Chrome app allows you to access the Internet from your phone. Access and selections within this feature are dependent upon your service provider. For specific information on Internet access through your phone, contact your service provider.

- NOTES**
- You may incur additional charges for accessing the web and downloading media. For details, contact your service provider.
 - Chrome may differ from this user guide due to updates via Play Store.

Viewing web pages

1. Tap the **Home Button**  > the **Apps icon**  > **Chrome**  or tap the **Chrome icon** directly on the Quick Access Bar.
 2. Tap the URL input field to access a web page. Enter the web address (URL) of the web page, then tap the **Go button**  on the on-screen keyboard.
- ▶ When you begin entering text in the URL input field, suggestions appear below the address bar.

NOTE You can change the search engine for your searches. From the **Chrome** app, tap the **Menu icon**  > **Settings** > **Search engine**. Tap the search engine you want to use.

URL Input Field (address bar)



Tap here to enter a web address for the web page you want to access.





Menu Icon

Tap here to access various options for Chrome.



Search within a web page

1. While viewing the page, tap the **Menu icon**  > **Find in page**.
2. Type the text you're looking for in the find bar at the top of the screen.
Matches are highlighted on the page (current match in orange and other found matches in yellow).
 - ▶ The find bar displays the total number of matches. Tap the up  and down  arrows in the find bar to go to each match.
 - ▶ Found matches are also indicated in the scroll column along the right side of the screen. Tap any of the highlights to jump directly to that match.

Searching the web by voice

Tap the address bar, tap the **Close icon**  in the bar, tap the **Microphone icon** , say a keyword, then tap one of the search results that appear.

Adding and viewing bookmarks

To add bookmarks, while viewing the page you want to bookmark, tap the **Menu icon** , then tap the **Bookmark icon** .

To open a bookmarked web page, tap the **Menu icon**  > **Bookmarks** and select the desired page.

Browse with tabs

You can easily browse several web pages simultaneously. Create multiple tabs for the sites you want, then tap the **Recent Apps Button**  and tap the tab you want to access to switch between them.

Create a new tab

From the **Chrome** app, tap the **Menu icon**  then tap **New tab** (or **New incognito tab**).

The New Tab page





Tap an icon at the bottom of the new tab screen to help you open the page that you want quickly.



- ▶ ☆ **Bookmarks** The sites that you've bookmarked are listed here. Tap one to visit the site using the new tab you created. Touch and hold a bookmark to open a context menu to access Open in new tab, Open in incognito tab, Edit bookmark, and Delete bookmark.
- ▶ ⌚ **Recent tabs** Your recent websites are listed here including the ones on this device, recently closed, and on your other devices.

Download files

1. Touch and hold a download link.
2. In the context menu that appears, tap **Save link**.

To view downloaded files:

Tap the **Home Button**  > the **Apps icon**  > the **Tools folder**  > **Downloads** .

- ▶ To open a downloaded file, tap it.
- ▶ To view earlier downloads, tap the heading date you want to view.
- ▶ To share downloads, tap the **Share icon** , checkmark the ones to share, then tap **SHARE** and choose a sharing method from the list.
- ▶ To clear files from your download history, tap the **List icon**  > checkmark the entries to clear, tap **CLEAR**, then **YES** to confirm.
- ▶ Tap the **Menu icon**  (at the upper-left of the screen) to switch the download file sort criteria.

Chrome Settings

To access the settings specific to the **Chrome** app:



1. From the **Chrome** app, tap the **Menu icon** .
2. Tap **Settings**.

Contacts

The Contacts app allows you to store names, phone numbers, and other information in your phone's memory. Entries are listed alphabetically. You can scroll through the list, or select the **Favorites** tab or **Groups** tab.

Use the Contacts app to add, view, and communicate with your friends, acquaintances, and associates.

To open your Contacts app

- ▶ Tap the **Home Button**  > the **Contacts** icon .

NOTE You can also tap the **Contacts** tab from the **Phone** app.



If you have a new phone and haven't added any contacts yet, hints will be displayed to help you start adding contacts to your phone.

Contacts list

When you open the Contacts app, your contacts list is displayed. The alphabet is displayed vertically along the right side of the screen with a blue bar that indicates where you are in the list.

In case of Emergency contacts is displayed above your list of contacts. Add up to 5 emergency entries from your contacts list. These are entries that someone can contact on your behalf in the event of an emergency, whether or not the phone is locked.



To add ICE entries

1. Tap the **Home Button**  > the **Contacts** icon .
2. Tap **In Case of Emergency contacts** (at the top of the list).
3. Tap the **Add entry** icon .
4. Checkmark the entry (or entries) to add to your ICE list, then tap **DONE**.



ICE Information

In addition to your emergency contacts, you can enter personal information about you (such as medical record number, allergies, medications, special

instructions, etc.) that can be accessed in case of an emergency. To add your personal information:

1. From the emergency contacts screen, tap the **Information** icon .
2. Tap the **Add** icon , enter your information, then tap **SAVE**.

To search for a contact

1. Tap the **Home Button**  > the **Contacts** icon .
2. Tap the **Search contacts** box and enter the contact name. Matches are displayed as you begin to type.

Searching your online contacts simultaneously

You can search for your contacts simultaneously from all of your online accounts.

To set your phone to search simultaneously, open the **Contacts** app, tap the **Menu** icon  > **Contacts settings** > checkmark the **Online search** checkbox.

To open a list of your favorite contacts

- ▶ Open the **Contacts** app and tap the **Favorites** tab.

Favorites lists the contacts you've designated as your favorites (at the top of the screen) and entries you've contacted frequently (at the bottom of the screen). While viewing the **Favorites** tab, tap the **Menu** icon  then tap **Grid view** (or **List view**) to change how your favorites are displayed.

To open your groups list





- ▶ Open the **Contacts** app and tap the **Groups** tab.

Groups displays your contacts by category (at the top of the screen) and your accounts (at the bottom of the screen).

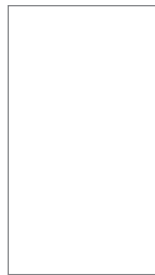
To view details about a contact

1. Open the **Contacts** app.
2. Tap the contact whose details you want to view.



3. The information you entered for the contact is displayed. The following options are available (depending on the types of information saved).
- ▶ The **Dial** icon  places a call to the number.
 - ▶ The **Message** icon  starts a message.
 - ▶ The **Video call** icon  places a video call to the number.
 - ▶ The **Email** icon  starts an email.
 - ▶ The **Menu** icon  accesses the following menu options: **Refresh**, **Delete**, **Share**, **Forward**, **Merge**, **Set as default**, **Export**, **Add to Home screen**, and **All calls to voice mail**.

Adding Contacts



You can add contacts on your phone and synchronize them with the contacts in your Google™ Account, Microsoft Exchange account, or other accounts that support syncing contacts.

Since your contacts can come from a variety of sources, the Contacts app attempts to join new information with existing similar contact entries to create a single entry. You can also manage that process manually by joining or splitting entries.

To add a new contact

1. Open the **Contacts** app.
2. Tap the **New contact** icon .
3. If you have more than one account with contacts, select the account where you want to save the contact by tapping the **Accounts** field (at the top of the screen).

NOTE To change the account later, edit the entry, tap the account (at the top of the screen), then tap the account you want it assigned to.

4. Enter the contact's name.
5. Tap a category of contact information, such as phone number or email address, to enter that kind of information about your contact.
 - ▶ Tap a category's **Add new** icon  to add more than one entry for that category. For example, in the phone number category, enter a work number and add a home number. Tap the label field to the right of the entered information to open a drop-down menu of preset labels. For example, **HOME** or **WORK** for a phone number.
 - ▶ Tap **Add another field**  to add additional fields including **Phonetic name**, **Organization**, **IM**, **Notes**, **Nickname**, **Website**, and **Events**.
6. Personalize the contact entry.
 - ▶ Set a ringtone to identify calls from this contact.
 - ▶ Set the color of the notification LED (located at the upper-left corner of your phone) to identify notifications from this contact.
 - ▶ Tap the **Picture frame** icon  to select a picture to identify the name in your list of contacts and in other apps.
7. When you're finished, tap **SAVE**.

Editing a Contacts entry

1. Open the **Contacts** app, then tap the contact entry you want to edit.
2. Tap the **Edit** icon .
3. Edit the entry as needed, then tap **SAVE**.

Favorites Contacts

The Favorites tab contains a short list of the contacts you communicate with most often.

Adding or removing contacts in your Favorites list

1. Open the **Contacts** app, then tap a contact to view its details.
2. Tap the star at the top right of the screen.
 - ▶ A gold-colored star indicates a Favorite.
 - ▶ A gray-colored star indicates a normal contact.

Merging and separating contacts

When you have two or more entries for the same contact, you can merge them into a single entry. You can also separate contacts that were merged.

1. Open the **Contacts** app, then tap the contact entry you want to join with another entry.
2. Tap the **Menu** icon .
3. Tap **Merge**.
4. Tap a suggested entry or tap **Show all contacts** to select another entry.

Once entries have been merged, **Separate** is included in the Options menu to allow you to separate the joined entries.

1. Open the **Contacts** app, then tap the contact entry you want to separate.
2. Tap the **Menu** icon .
3. Tap **Separate**.
4. Tap **YES**.

Setting Speed Dials

Designating multiple speed dials

1. Open the **Contacts** app, then tap the **Menu icon** .
2. Tap **Speed dial**.
3. Tap the speed dial number to assign, then tap the Contact entry for it.
4. Repeat selecting a speed dial number and the desired Contact entry as necessary.

Setting a single Speed dial

The **Speed dial** icon  in the contact entry allows you to set speed dials for selected phone numbers either when creating it or while editing it later.

1. From the contact entry, tap the **Speed dial** icon  to the right of the phone number you want to set with a speed dial.
2. Tap the speed dial number to assign to it.
3. Tap **SAVE**.







Transfer type

When you want to send your contacts entries, you can combine them all into one file or you can send separate vCard files.





To set the transfer type, from the **Contacts** app, tap the **Menu icon**  > **Contacts settings** > **Transfer type**.

- ▶ **Send as one file:** This setting combines all of your contacts into one file. It allows a faster transfer, but some devices can't receive contact information sent using this option.
- ▶ **Send separately:** This setting sends each contact as a separate vCard file. It allows all devices to receive your files.

Messaging

Three apps are preloaded on your phone that allow you to send messages. The **Messaging** app , the **Message+** app , and the **Hangouts** app . Only one can be set as your default messaging app. Tap the **Home Button**  > the **Apps** icon  > **Settings**  > **More** > **Default message app** to set your choice.

To open the Messaging app

- ▶ Tap the **Home Button**  > the **Apps** icon  > **LG** folder  > **Messaging** .

NOTE The Messaging app must be set as the default messaging app in order to use it. If Messaging is not your default app, a pop-up will appear. Tap **YES** to set it.

Using the Messaging app

To use the Messaging features, you must set it as the default messaging app.

NOTE You can view your messages in the **Messaging** app without setting it as your default app, but you can't create a message.

- ▶ Tap the **New message** icon  to start a new text or multimedia message.

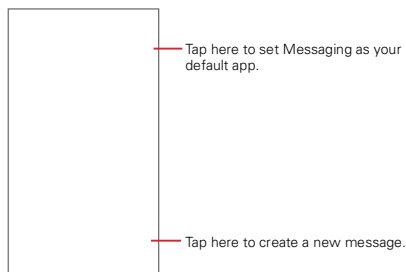



- ▶ Tap an existing message thread to open it.
- ▶ Tap the **Menu** icon  to access **Search**, **Delete**, and **Settings**.

NOTE Pinch in (or spread apart) on your list of messages to resize it for easier viewing or navigation.

To delete a message thread from the Messaging window



1. Touch and hold the message thread.
2. Tap **Delete** in the context menu that opens.
3. Tap **YES** to confirm you want to delete the message thread.

To send a text message

1. Open the **Messaging** app (set it as your default, if necessary), then tap the **New message** icon .
2. Enter the recipient(s) in the **To** box.
 - ▶ Tap the **Contacts icon**  then select one or more entries from your Contacts list.
 - ▶ Enter a name (or a partial number) then tap a suggestion displayed from your Contacts list.
 - ▶ Enter a number manually for phone numbers not in your Contacts list.
3. Tap the text box, then enter your message.

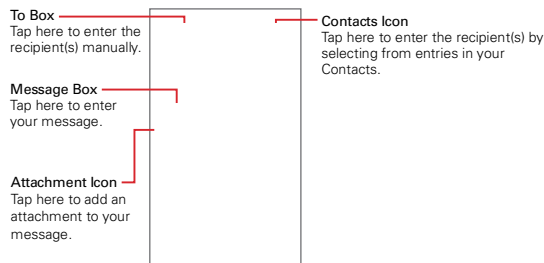
A character counter is displayed in the message box to let you know how many more characters you can type and also the number of pages in the message.







If you tap the **Back Button**  while composing a message, it's automatically saved as a draft. The **Draft icon**  on the right side of the

message thread indicates a pending draft message to the recipient. Tap the message to resume composing it.

4. Tap the **Send** button to send the message.
Your message is displayed and responses appear in the same window, creating a message thread with that contact.

To create and send a multimedia message

1. Open the **Messaging** app (set it as your default messaging app, if necessary), then tap the **New message** icon .
2. Enter the recipient(s) in the **To** box.
 - ▶ Tap the **Contacts** icon  then select one or more entries from your Contacts list.
 - ▶ Enter a name (or a partial number or email address), then tap a suggestion displayed from your Contacts list.
 - ▶ Enter a number or email address manually.
3. Tap the text box, then enter your message.
4. Tap the **Menu** icon  > **Add subject** to add a message subject.
The subject text appears above the body text in bold letters.
5. Tap the **Attachment** icon  to open a dialog box where you can choose the type of media file to attach to the message.
NOTE To delete an attachment, simply tap the **Delete** icon  on the attached file.
6. Tap the **Send MMS** button to send the message.

Receiving and viewing messages

If you're working in a message window, messages that you receive from that contact are displayed. Otherwise, you receive a new message notification and a new message icon  appears in the Status Bar. When you tap the new message notification, the Message screen opens where you can reply to the message. If the **New message pop-up** setting is activated, you'll receive a pop-up notification on the current screen which you can use to directly reply.

If the Auto-retrieve setting isn't checkmarked, tap **Download** to view the full message.

If the message contains a media file, tap the **Play** button to view, watch, or listen to it. Touch and hold the media file to open a context menu with additional options.

To respond to messages you receive

While viewing the received message, tap the text box at the bottom of the screen, complete your response as necessary, then tap the **Send** button.

Changing Messaging Settings

- ▶ To change the Messaging settings, open the **Messaging** app (set it as your default, if necessary), tap the **Menu** icon  > **Settings**.

The **Notifications settings** menu includes the following options: **Notifications**, **New message pop-up**, **Preview**, **Notification sound**, **Vibrate**, and **Repeat alert**.

The **Text messages** menu includes the following options: **Delivery reports**, **Manage SIM card messages**, **Priority**, **Read reports** and **Allow read reports**.

The **Multimedia messages** menu includes the following options: **Delivery reports**, **Allow delivery reports**, **Auto-retrieve**, **Roaming auto-retrieve**, and **Priority**.





Group Conversation: Allows you to enable/disable group conversations.

The **General settings** menu includes the following options: **Conversation theme**, **Quick messages**, **Send message with Enter key**, **Signature**, **Callback number**, **Delete old messages**, **Text message limit**, **Multimedia message limit**, and **Save to**.

Email

The Email app allows you to read email from services other than Gmail™. The following account types are supported: Microsoft Exchange, Outlook, Yahoo! Mail, AOL Mail, Verizon, and other accounts.

To open the Email app

Tap the **Home Button**  > the **Apps icon**  > **Email**  or tap the **Email icon**  directly from the Home screen.

The first time you open the Email app, a setup wizard opens to help you add an email account. After the initial setup, the Email app displays the contents of your Inbox.

NOTE You can also add your email account(s) using the Accounts menu in the Settings app.





The Accounts list

The Accounts list displays all of your email accounts.

Open the **Email** app. Tap the **Accounts List icon**  (at the upper-left corner of the screen) to display a list of all of your email accounts. You can also swipe horizontally from the left side of the screen to open your Accounts list.

- ▶ A identifying color is displayed on the left of each account. Tap an account to toggle between displaying and hiding its folders. The number of unread mail is displayed next to each account's Inbox.

Using the Email app

- ▶ Tap the **Compose icon**  to compose a new message.
- ▶ Tap the **Accounts List icon**  to switch between your email accounts.
- ▶ Touch and hold a message, then you can tap **MARK AS READ/UNREAD**, **MOVE TO**, or **DELETE**. You can also tap the **Select all icon**  to select all of your messages at once, then tap the action to apply to all of them.
- ▶ Tap the **Favorite icon**  next to an email message to designate it as an important or favorite message.

- ▶ Swipe a message off the screen to the left or right to delete the message.
- ▶ Tap the **Menu** icon  to open the Options menu to access **Select**, **QSlide**, **Sort by**, and **Settings**.
- ▶ Drag downward from the top of the Inbox list to refresh the list.

Message search

Tap the **Search** icon  enter the text you're looking for, then tap one of the displayed results.

Reading Your Email

You can read your email from the Inbox, or from other folders within each individual account. Tap a message entry to open it.

NOTE If you enable the Auto-rotate screen setting, the Email app is displayed in a split-screen format when the phone is held horizontally. Your Inbox (or any other selected folder) is displayed on the left side of the screen. Tap an email to open and display its contents on the right side of the screen.

To read an email

1. Open the **Email** app, then tap the **Accounts list** icon .
2. Tap **Inbox** under **Combined view** to display all of your messages from all of your accounts together or tap **Inbox** under the account you want to view.

NOTE When new email arrives, a notification appears in the Status Bar. Drag the Status Bar downward and tap the email notification.

To add an account

- ▶ From the **Email** app, tap the **Menu** icon  > **Settings** > **Add account**. Then, configure the new email account settings as necessary.

Changing Email Settings

- ▶ To change the Email settings, open the **Email** app, tap the **Menu icon**  > **Settings**.

General settings

The **General settings** menu includes the following options: **Email preview**, **Conversation view**, **Split view**, **Set default account**, **VIP settings**, **Save to**, **Ask before deleting**, **Auto-advance**, and **Load images**.

Accounts



Tap an account in the list to modify the settings that apply only to that account including **Account name**, **Your name**, **Signature**, **Edit signature**, **Notifications**, **Notification sound**, **Vibrate**, **Auto-sync email**, **Sync schedule**, **Email sync period**, **Message size limit**, and **Advanced settings**.

Voice mail

The Voice mail app allows the management of voice mail directly from the phone rather than accessing voice mail via traditional methods.

Voice mail can display a list of your messages allowing you to choose which message(s) to listen to or delete, without having to dial into your mailbox and listen to voice instructions or prior messages.

To be able to use Voice mail

1. Tap the **Home Button**  > the **Apps icon**  > the **Verizon folder**  > **Voice Mail**  or tap **Voice Mail**  directly on the Home screen.

NOTE Listening to voice mail and setting up your voice mail service depends on subscription to the visual mail service. When you tap the Voice mail button  on the dialpad, and you've subscribed to the visual mail service, the Visual Voice mail app will be launched. If you're not subscribed, you'll be dialed into your traditional voice mail box.

2. The first time you access the Voice mail app, you'll have to subscribe to the Visual Voice mail service to be able to use it.
3. After subscription to the Visual Voice mail service, you'll be prompted to enter the password. To change the password, call voice mail (dial *86).

4. After entering the password, your voice mail entries will be displayed in your Inbox.







While viewing the voice mail list, you can select an entry (see step 5). For additional options, tap the **Menu** icon . The following options are available: **Search**, **Save**, **Set as heard**, **Sort by**, **Saved Voice Mail**, **Refresh**, and **Settings**.

5. Tap a voice mail entry to listen to it. Then you can tap **Call back**, **Save**, **Delete**, or **Speaker**.
6. If you decide to reply with a voice mail or forward it, record a message. The buttons at the bottom of the screen allow you to record, stop, re-record, or cancel the message.

Gmail

When you open the Gmail app, the most recent conversations are displayed at the top of your Inbox list. All of your conversations are displayed in your Inbox unless you delete, archive, or filter them.

To open the Gmail app

Tap the **Home Button**  > the **Apps** icon  > the **Google** folder  > **Gmail**  or tap the **Google** folder  > **Gmail**  on the Home screen.

Your Gmail Inbox

The current Google Account is displayed in the header at the top of the Inbox. If you have more than one account, you can switch accounts to view the messages in each Inbox.



Conversations with new messages are displayed with bold subject lines. To read a message in a conversation, tap its subject line text.

The letter icon (or contact photo) next to a Gmail message allows you to select it and choose an action from the icons at the top of the screen.

The Favorite icon  next to a Gmail message allows you to designate it as a favorite message.



Gmail Inbox icons

Use the following icons while viewing your Gmail label, access Gmail **Settings**, and view **Help & feedback**.



- ▶  **Accounts and labels:** Tap to change to another account or label.
- ▶  **Compose:** Tap to begin a new Gmail message.
- ▶  **Search:** Tap to search within your Gmail messages.

NOTE You can also drag the screen downward from the top of the Gmail message list to refresh and check for new email.

Message search

Tap the **Search** icon , enter the text you're looking for, then tap the Search button  on the on-screen keyboard.

Adding another Google Account

- ▶ Tap the **Home Button**  > touch and hold the **Recent Apps Button**  > **Settings** > **Accounts** > **ADD ACCOUNT** > **Google**. Enter your Google Account information, as necessary.

To switch accounts

Gmail displays conversations and messages from one account at a time. If you set up more than one email account on your phone, you can easily switch between them.



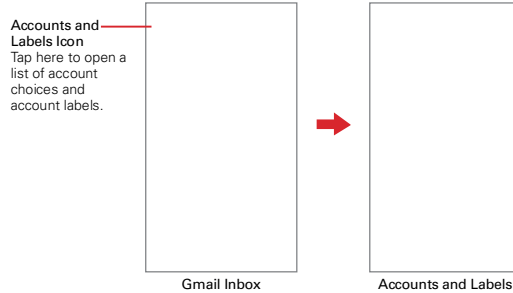

- ▶ From your Gmail Inbox, tap the **Accounts and labels** icon  (at the upper-left corner of the Inbox header), tap the current account, then tap the account that contains the email you want to read.

NOTE The number of unread messages is displayed to the right of each account and folder.







Navigating in the Gmail app

While viewing your Inbox:

- ▶ Swipe the screen up and down to scroll through your list of messages.
- ▶ Tap the **Compose** icon  to start a new Gmail message.
- ▶ Tap the **Search** icon  to search within the Gmail app.
- ▶ Swipe a Gmail message off the screen to the left or right to quickly and easily archive the message. Tap **UNDO** to restore it to your Inbox.
- ▶ Tap the letter icon (or contact photo) to the left of one or more messages, then tap the **Delete** icon  to delete the selected messages.
- ▶ Tap the letter icon (or contact photo) to the left of one or more messages, then tap the **Menu** icon  to select **Move to**, **Change labels**, **Add star**, **Mark important**, **Mute**, or **Report spam**.

While viewing a message, swipe the screen left and right to scroll through all of your messages and use the icons in the header at the top of the screen:

- ▶ Tap the **Gmail** icon  to return to your Gmail Inbox.
- ▶ Tap the **Delete** icon  to move the email to the trash folder.
- ▶ Tap the **Mark unread** icon  to return the message to an unread state.

- ▶ Tap the **Menu icon**  to access **Move to, Change labels, Mark important** (or **Mark not important**), **Mute, Print, and Report spam**.

If you're viewing a message or another label, tap the **Back Button**  until you return to your Inbox.

Reading Your Messages



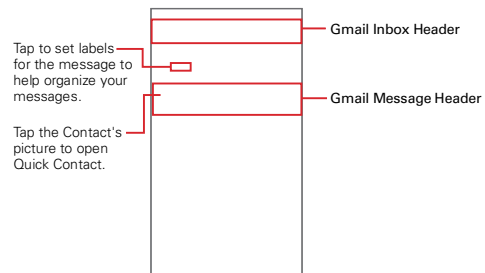

From your Gmail Inbox, tap a conversation that contains the message you want to read.

The conversation opens to the first new (unread) message, or to the first starred message, if you've previously starred a message in the conversation.





While viewing a message, you can tap the message action icons on the Gmail Inbox header or the message header to access the following options:

Gmail Inbox header icons

The Gmail Inbox header icons include the **Gmail Inbox icon** , the **Archive icon** , the **Delete icon** , the **Mark read/unread icon**  and the **Menu icon** .

Gmail message header icons

- ▶ Tap the Contact's picture to open the Quick Contact options.
- ▶ Tap the **Favorite icon**  to mark it as a favorite.

- ▶ Tap the **Reply** icon  to reply to the sender.
- ▶ Tap the **Menu** icon  to reply to all, forward the message, star the message, or print the message.

To reread a message

When you open a conversation, messages that you've already read are minimized into a tab that indicates the number of hidden messages.





1. From your Gmail Inbox, tap the conversation you want to view.
2. Tap the contact name to open that message.

While reading a message you can tap the **Mark unread** icon  (in the Gmail Inbox header) to return a read message to the unread state. For example, to remind yourself to read it again later.

Composing and Sending a Message

You can compose and send a message to people or groups with Gmail addresses or other email addresses.

To compose and send a message



1. Tap the **Home Button**  > the **Google folder**  > **Gmail**  > the **Compose icon** .

NOTE If you set up more than one email account on your phone and want to send the message from a different account, tap the current Google Account (at the top of the screen), then tap the account you want to use.

2. Enter a recipient's address.
As you enter text, matching addresses are offered from your Contacts list. You can tap a suggested address or continue entering text to enter a new one.
3. Tap the **Arrow** icon  (in the **To** field), to add Cc and Bcc fields so you can copy or blind copy additional recipients.
4. Enter a subject for the message in the Subject field.
5. Enter your email text in the Compose email field (below the Subject).

6. Tap the **Attachment** icon , then tap **Attach file** to add an attachment from your phone's memory. Tap **Insert from Drive** to insert files from Google Drive. Tap the **Remove** icon  on the attachment to remove it from your message.

7. Tap the **Send** icon  to send your message.



NOTE If you aren't ready to send the message, tap the **Menu** icon , then tap **Save draft** or simply tap the **Back Button** .

Replying to or Forwarding a Message

Continue an email conversation by replying to a message or by forwarding it without changing the Subject text. Change the Subject text to start a new conversation.

NOTE The conversation text and previous messages are also included in your reply (or forwarded) message.

To reply to or forward a message

1. Open the message you want to reply to or forward.
2. On the message header, tap the **Reply** icon  or tap the **Menu** icon , then tap **Reply all** or **Forward**.





▶ Add others to an ongoing conversation by replying to all and then adding the new person's address(es) to the reply.

3. Compose your Gmail message as necessary.

4. Tap the **Send** icon  to send your Gmail message.

NOTE You can change the message action after you've started the message. Simply tap the current action (at the top left of the message header), then tap the one you want. For example, if you chose Reply but decide you want to Reply all instead.

Gmail account settings

1. Tap the **Home Button**  > the **Google** folder  > **Gmail**  > the **Accounts and labels** icon  (at the upper-left corner of the screen).

2. Tap **Settings**.

3. Tap **General settings** to change the settings for all accounts. Tap an account to change the settings that only apply to it.

- ▶ The **General settings** menu includes the following options: **Gmail default action**, **Conversation view**, **Swipe actions**, **Sender image**, **Reply all**, **Auto-fit messages**, **Auto-advance**, **Confirm before deleting**, **Confirm before archiving**, and **Confirm before sending**.

Tap the **Menu icon**  in the **General settings** to access **Manage Accounts** and **Help & feedback**.

- ▶ Specific Gmail account settings include the following options: **Inbox type**, **Inbox categories**, **Notifications**, **Inbox sound & vibrate**, **Signature**, **Vacation responder**, **Sync Gmail**, **Days of mail to sync**, **Manage labels**, **Download attachments**, and **Images**.

NOTE Other email accounts may have additional specific settings.

Tap the **Menu icon**  in the account's settings to access **Manage Accounts** and **Help & feedback**.

Hangouts

Use the Hangouts app to have real-time text conversations with your friends.



To Open the Hangouts app

- ▶ Tap the **Home Button**  > the **Google folder**  > **Hangouts** .



To sign out of Hangouts

- ▶ Tap the **Hangouts Options icon**  > **Settings** > tap your account > **Sign out**.

Navigating in Hangouts

- ▶ Tap the **Hangouts Options icon**  to access **Status**, **Snooze notifications**, **Contacts**, **Invites**, **Archived**, **Blocked people**, **Settings**, and **Help & feedback**.
- ▶ The main screen displays your conversations. Tap one to open it.
- ▶ Tap  to start a new conversation.

Chatting with Friends



1. Tap the **Home Button**  > the **Google folder**  > **Hangouts** .
2. Select a friend from the Chatting list.
 - ▶ Tap the name of the person in your contacts list. If your friend is not yet on Hangouts, your friend will receive an SMS inviting them to Hangouts.

OR

- ▶ Tap the text field to enter a name, email, number, or circle.
3. Tap the message box, then enter your message.





NOTE Before you enter the text for your message, you can tap the **Attach icon**  (to the right of the message) to attach a photo, video, location, or sticker.

4. Tap the **Send icon**  (on the right side of the message).

NOTE You can tap the **Call icon**  to call the friend, or tap the **Video icon**  to start a video chat with your friend.

Managing chats



Touch and hold a friend's name in the Chats screen, then you can use the following options (at the top of the screen).

	Tap to turn notifications from that friend off (or on )
	Tap to archive the conversation.
	Tap to delete the conversation.

Chat Options menu

From a chat, tap the **Menu** icon  to access the following options: **People & options**, **New group conversation**, **Turn history off**, **Archive**, **Delete**, and **Help & feedback**.

Blocking your Friends

- ▶ To block a friend from exchanging messages with you, tap the friend in the Chats screen. Tap the **Menu** icon  > **People & options**. Tap **Block** next to the contact's name, then tap **BLOCK**.
- ▶ To remove a friend from the blocked list, tap the **Hangouts Options** icon . Tap **Blocked people**, then tap **Unblock** next to the friend.

NOTE You can also unblock a friend by tapping **Archived**. Tap the blocked friend in the archived conversations list, then tap **UNBLOCK**.

Changing Hangouts Settings

To change the Hangouts settings, open the Hangouts app, tap the **Hangouts Options** icon  > **Settings**.



- ▶ **Enable merged conversations:** Enable this setting to merge your contact conversations from both SMS and Hangouts together.
- ▶ Tap **SMS** to change its settings including **SMS enabled** (or **disabled**), **Default SMS Messaging Account**, **Blocked people**, **Sound**, **Vibrate**, **Delete old messages**, **Delivery reports**, **Auto retrieve MMS**, and **Roaming auto-retrieve**.
- ▶ Tap your Google Account to access **Profile photo**, **Share your status**, **Hangouts messages & invites**, **Video calls**, **Customize invites**, **Join Google+** (or **Google+ profile**), **Verified phone number(s)**, **Hidden contacts**, **Sign out**, and **Improve Hangouts**.

Camera

You can use the Camera app to take and share pictures and videos. The video feature is integrated on the camera viewfinder to take pictures and record video with a single tap. Your phone comes with a 16 megapixel camera that lets you capture sharp pictures and videos. It has many state-of-the-art features such as laser auto-focus, dual camera mode, still photo capture while recording video, and much more. These features will allow you to easily and creatively capture your world.

NOTE Be sure to clean the protective lens cover with a microfiber cloth before taking pictures. A lens cover with smudges from fingers can cause blurry pictures with a "halo" effect.

To open the Camera app

- ▶ Tap the **Home Button**  > the **Apps icon**  > **Camera** .

OR

- ▶ Tap **Camera**  from the Home screen.

OR

With the backlight off, press the **Volume Down Key**  twice.

TIP If you've set your phone to use the Swipe unlock method, from the Lock screen, simply drag the **Camera icon**  upward to open the **Camera app**.



Camera mode options

The Camera app has three Camera modes available allowing you to choose the level of shot expertise for your photos and videos. Tap the **Options icon**  to display the mode options, then tap **Simple**, **Auto**, or **Manual**.

▶ Simple mode

Simple mode  allows you to take quick, no fuss photos. There are no any additional settings and video capture is not available in this mode.

▶ Auto mode

Auto mode  allows you to apply commonly-used photography settings. This mode has both a **Capture button**  and a **Record button**  to immediately switch from taking photos to recording videos and

visa versa. It also allows you to set a sharing method to immediately share your photo or video.

► **Manual mode**

Manual mode  allows you to use professional-type settings to capture exactly the shot you want and allows you to record video as well.

The Auto camera viewfinder icons

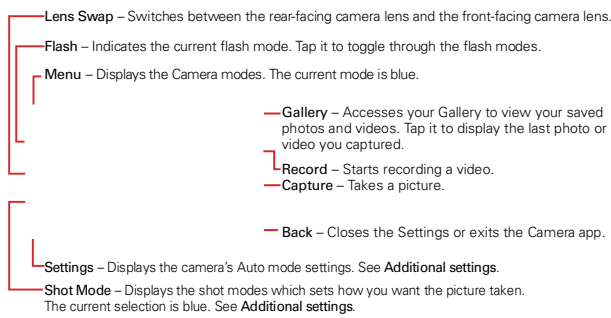

The Manual camera mode viewfinder

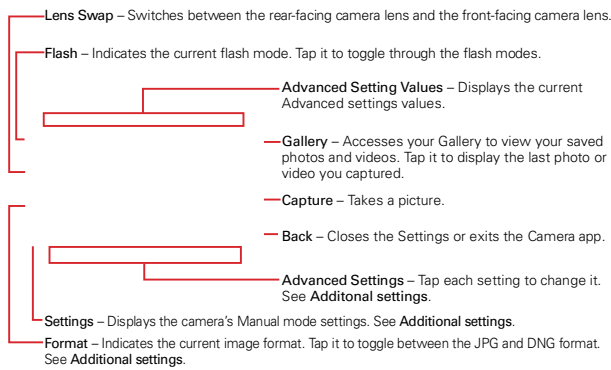



Taking Pictures

Taking pictures with your phone's built-in camera is as simple as choosing a subject, pointing the lens, and tapping a button icon. When you take a picture, the Multi-point Auto-focus (AF) function operates automatically to allow you to capture a clear image.

To take a picture:

1. Tap the **Home Button**  > **Camera** .

NOTE If necessary, tap the camera mode you want to use (Simple mode , Auto camera mode , or Manual camera mode .

2. Frame your subject on the screen.

▶ The green squares indicate that the camera has focused.

Place two fingers on the screen and spread them apart to zoom in (a zoom bar indicates the zoom level) and pinch in to zoom back out.



3. Tap the **Capture** button , if available. Otherwise, tap the subject to take the picture. Your picture will be automatically saved to the Gallery.

NOTE The captured image retains the orientation in which it was taken. If you hold the phone both vertically and horizontally to take pictures, you'll need to rotate the phone to view full screen images in the Gallery app.

TIP While viewing a photo, you can tap the **Menu** icon , then tap **Rotate right/left** to manually change its orientation.

Taking a Quick Shot



Quick Shot is a shortcut that immediately takes a picture when you press the **Down Volume Key**  twice while the phone is in timeout.

Activate the Quick Shot feature in the **Settings** app. Tap the **Home Button**  > touch and hold the **Recent Apps Button**  > **Settings** > **Shortcut key** > mark the **Quick Shot** checkbox to enable this feature.

Interval shot

You can take Interval shots from the Auto camera mode using the front camera lens. Touch and hold the **Capture** button  to automatically take 4 selfies in a row.

Burst shot

You can take Burst shots from the Auto camera mode using the rear camera lens. Touch and hold the **Capture** button  to take a barage of photos in a row until the Capture button is released. The viewfinder displays the number of shots taken. When viewing Burst shots in the Gallery, tap the **Burst play** icon  to display each shot in sequence (similar to a viewing flipbook).

Gesture shot

The Gesture shot feature allows you to take a picture with a hand gesture using the front camera.

To take photos with a gesture







1. Activate the front camera lens.
2. Activate a gesture shot by raising your hand, with an open palm, until the front camera detects it (a box appears on the screen).
3. Make a fist.
 - ▶ Make a fist to start a countdown before a single shot is taken.
 - ▶ Make 2 fists actions to take multiple shots.

NOTE You can also take a single photo by making a fist, then opening your palm.



Record Videos

In addition to taking pictures, you can record, view, and send videos with your phone's built-in video camera.

1. Tap the **Home Button**  > **Camera** .
2. Frame your subject on the screen.
3. Tap the **Video Capture** button  to start recording the video.
 - ▶ The length of the recording is displayed at the upper-right corner of the screen.
 - ▶ You can tap the **Capture** button  to take pictures while you're recording video.
 - ▶ You can use the pinch gesture to use the dynamic zoom feature while you're recording video. Spread your fingers on the screen to zoom in and pinch to zoom back out.
 - ▶ You can tap the **Pause** button  to pause your video recording. Then, resume your recording by tapping the **Record** button .
4. Tap the **Stop** button  to stop recording. Your video will be automatically saved to the Gallery.

Shot mode

Shot mode  is only available on the Auto camera mode viewfinder. It sets how the picture will be taken.



- ▶ **Auto** takes a normal shot.
- ▶ **Panorama** allows you to pan your phone slowly in one direction to take continuous photos which the camera combines into a single wide photo.
- ▶ **Dual** allows you to activate the front and rear camera lens in one screen so that you can take a picture using both lenses.
- ▶ **Slo-Mo** allows you to take pictures in slow motion.

Image format

Image format  is only available on the Manual camera mode viewfinder. It sets the format for the image.

- ▶ **JPG** sets the image to the standard JPG format.
- ▶ **RAW JPG** sets the camera to save the image in JPG and DNG formats. This allows for more control when editing, but it can take up more space.

Additional Settings

The camera is set to automatically take high quality photos and videos, but additional adjustments can be made when using Auto mode or Manual mode. Tap the **Settings** icon  to access these additional settings. Tap one to toggle through its available settings. Tap the **Settings** icon  again to exit the settings.

The HDR feature takes multiple photos and combines them to create the best possible photo. This setting is only available in Auto camera mode.



Enables the HDR feature.



Sets the HDR feature to automatically enable.



HDR is disabled.

NOTE When the HDR setting is enabled, the auto mode flash is disabled.



Indicates the aspect ratio set for the photo or video.

For photos, choose from 1:1, 4:3, and 16:9.

For videos, choose from HD, FHD, and UHD.



Enables the Voice command function.



Disables the voice command function.



Enables a 3 second delay after the **Capture** button  is tapped.



Enables a 10 second delay after the **Capture** button  is tapped.



Disables the delay capture function.

NOTE When you exit the Camera application, this setting is turned off automatically in the Basic camera mode settings, but remains the same in Manual camera mode.

Auto camera mode

 Displays an overlay grid to help you align your photos and videos horizontally and/or vertically for better composition. Tap it to toggle it on or off.

Manual camera mode

 Displays a horizon indicator for composition alignment.

 Disables the composition guides.

The Scenery feature sets the camera to take scenery shots. This setting is only available in Manual camera mode.

 Enables the Scenery feature.

 Disables the Scenery feature.

NOTE Tap the **Help** icon  to view additional information to help you use the camera.

Additional Manual camera mode viewfinder icons

Additional manual camera settings are available along the lower (landscape) edge of the viewfinder when using the Manual camera mode. Current settings are displayed in their corresponding positions along the upper (landscape) edge of the viewfinder. Tap a setting, then use its slide bar displayed along the right side of the screen to set it.

NOTE Tap the **Auto Expose Lock** switch  at the lower-right corner of the viewfinder to toggle it on or off. On resets the ISO, shutter speed, and brightness (and also disables the brightness setting).

 Tap to manually set the white balance. Tap **AUTO** at the top of its slide bar to set auto white balance.

 Tap to manually set the focus. Tap **AUTO** at the top of its slide bar to set auto focus.

 Tap to manually set the brightness. To reset it to normal, tap the AE-L switch.

 Tap to manually set the ISO. To reset it to normal, tap the AE-L switch.

 Tap to manually set the shutter speed. To reset it, tap the AE-L switch.

8x zoom



You can change the zoom level for your photos using the pinch-to-zoom feature. Spread your fingers on the screen to zoom in and pinch in to zoom back out.

The zoom feature gives you the ability to zoom up to 8 times the normal view. This feature operates automatically while zooming in and out.

NOTE Use a steady hand. This feature does not work with some functions. Objects can be overlapped when taking a picture of fast-moving subjects.









View Your Pictures

The Gallery is where you can access your gallery of stored camera images. You can view them in a slideshow, share them with your friends, as well as delete and edit them.

1. Tap the **Home Button**  > the **Apps** icon  > **Gallery** .
2. Select an album and tap an image to view your picture.





Dual Feature

The Dual feature allows you to take a picture or record video with the front and rear camera lens at the same time. A smaller image window overlays the main image (similar to picture-in-picture). You can resize and move the overlay image window, as well as swap the lens for either view.

1. Tap the **Home Button**  > **Camera** .
2. Tap the **Camera Options** icon  then tap the **Auto** camera icon .
3. Tap the **Mode** icon  > the **Dual** icon 
 - ▶ Drag the overlay window to move it where you want it on the screen.
 - ▶ Touch and hold the overlay window to resize it.
 - ▶ Tap the overlay window to switch its lens.
 - ▶ Tap the **Capture** button  to take a dual photo.
 - ▶ Tap the **Video capture** button  to record a dual video, then tap the **Stop** button  to stop recording.

Viewing your pictures and videos

The Gallery is where you can access your gallery of stored camera images. You can view your photos in a slideshow, create a collage, share your photos and videos with your friends, as well as manage them (delete, edit, etc.). You can access your photos and videos stored in your phone's internal memory, microSD card (external memory), or albums connected with your Google Account.

1. Tap the **Home Button**  > the **Apps icon**  > **Gallery** .
 - ▶ Swipe up or down to view more albums.
 - ▶ Tap the **Gallery Menu icon**  (at the upper-left corner of the screen) to access **Albums**, **Timeline**, **Videos**, **Memories**, **Favorites**, and **Nearby devices** to view your images and videos.
2. Tap an album to open it and view its contents. (The pictures and videos in the album are displayed in chronological order.)
3. Tap an image to view it. Then you can swipe horizontally to browse through your images.

To share a your pictures and videos





1. Open an album to view its contents, then tap the **Share icon** .
2. Tap each file you want to share. When the checkmarks are set, tap **SHARE**, select how to share the file(s), then complete as necessary.

To delete pictures and videos

1. Open an album to view its contents, then tap the **Delete icon** .

2. Tap each file you want to delete. When the checkmarks are set, tap **DELETE**, then tap **YES** to confirm.

To play a video

1. Tap the **Home Button**  > the **Apps icon**  > **Gallery** .
 - ▶ Scroll up or down to view more albums.
2. Tap a video in an album to play it.
 - ▶ Tap the video while it's playing to view the playback controls.
 - ▶ While playing a video, the timeline allows you to jump to that part of the video. When using the Photos app, simply tap the timeline. When using the Videos app, tap the timeline, then tap the preview window.
 - ▶ While playing a video, press the **Volume Keys**  to adjust the volume.

NOTE The recording retains the orientation in which it was taken. If you hold the phone both vertically and horizontally to take pictures and record video, you'll need to rotate the phone to view full screen images in the **Gallery** app.

Live Zoom

Live Zoom is available when using the Videos app for playback. It allows you to zoom in or zoom out on a portion of a video while it's being played to make the desired section appear larger or smaller.

While viewing a video, use your index finger and thumb in a pinching or spreading motion on the screen to zoom in or out.



NOTE You don't need to press too hard; the screen is sensitive enough to pick up a light, but firm touch.

Dual Play



Dual Play connects two devices using a wired (Slimport-HDMI) cable or a wireless connection (Miracast) allowing you to view content on a different screen. The connectable device can be a TV or a monitor supported by an HDMI cable or Miracast. Viewable content can come from the Gallery app however not all videos are supported by Dual Play.

To start Dual Play, tap the **Home Button**  once when the two devices are connected and their displays are a different status (i.e. the monitor is playing a video and your phone's Video app is displaying an empty screen).

Gallery



Open the **Gallery** app to view albums of your pictures and videos.

To open the Gallery app

- ▶ Tap the **Home Button**  > the **Apps** icon  > **Gallery** .

Viewing your albums

The Gallery app presents all of the pictures and videos stored in your phone, including those you've taken with the Camera app and those you downloaded from the web or other locations. When another app saves a picture, it automatically creates a download folder to contain the picture (e.g., capturing a screen shot creates the Screenshot folder).

- ▶ Tap an album to open it and view its contents.
- ▶ Tap a picture or video in an album to view it.
- ▶ Tap the **Menu** icon  to open the Options menu to access **Cloud**, **New album**, **Delete**, **Set preferred albums**, **Show locked files**, **Settings**, and **Help**.
- ▶ Tap the **Camera** icon  to return to the Camera app.
- ▶ Tap the **Gallery Menu** icon  (in the upper-left corner of the screen) to open the Gallery menu to access **Albums**, **Timeline**, **Videos**, **Memories**, **Favorites**, and **Nearby devices**.

To share an album

You can share the entire contents of your albums.

1. Tap the **Home Button** ○ > the **Apps** icon ☰ > **Gallery** 🖼️.
2. Touch and hold the desired album, tap **Share**, select the app to use to share your images, then complete the sending method as necessary.











Gallery Options

The **Gallery** app allows you to easily manage and use your image files.

1. Tap the **Home Button** ○ > the **Apps** icon ☰ > **Gallery** 🖼️ to view the images stored in your phone's internal memory and on a microSD card (external storage).
 - ▶ Drag up or down to view more albums.
2. Tap an album to open it and view its contents (in chronological order).
 - ▶ While viewing an album, tap a picture to view it or tap a video to play it.







- ▶ While viewing an album the following icons are displayed at the top of the screen:
 - ◀ **Back**: Goes back to the previous screen.
 - 📷 **Camera**: Opens the **Camera**.

-  **Share:** Allows you to select one (or more) photos to share. After selecting the file(s), tap **SHARE** to open the available sharing options (such as Messaging or Bluetooth), then complete as necessary.
 -  **Delete:** Allows you to select one (or more) photos to delete. After selecting the file(s), tap **DELETE**, then **YES** to delete the selected picture(s).
 -  **Options:** Opens its Options menu which includes **Move, Copy, Make collage, Lock, Show locked files, Slideshow, and Rotate.**
- ▶ Tap a picture in an album, then tap the screen to display the following icons (only that image will be affected):
-  **Back:** Goes back to the album view.
 -  **Edit:** Opens the Edit function.
 -  **Camera:** Opens the **Camera** app.
 -  **Share:** Displays a pop-up for you to select a sharing method.
 -  **Delete:** Immediately deletes the image.
 -  **Options:** Opens its Options menu which includes: **Smartshare, Set image as, Move, Copy, Copy to Clip Tray, Lock, Slideshow, Rotate, Crop, Add location, Show on map, Rename, Print, and Details.**
 -  **Favorite:** Marks it (or removes it) as a favorite displayed in your Favorites album.

Assign Pictures

After taking a picture, assign it as a picture ID for a Contacts entry or as the background image (wallpaper) for your Home screen or Lock screen.









1. Tap the **Home Button**  > the **Apps** icon  > **Gallery** .
2. Tap an album and tap an image to view it.
3. With the picture displayed, tap the **Menu** icon  > **Set image as.**
4. Select an option.

- ▶ **Contact photo** assigns the picture to a Contact entry as a picture ID. Tap an entry from Contacts, crop the image, then tap **DONE** to assign the picture.
- ▶ **Home screen** assigns the picture as the background image. Crop the image and tap **DONE** to assign the picture.
- ▶ **Wallpaper** assigns the picture as the background image. Tap **SET WALLPAPER** to assign the picture.
- ▶ **Lock screen wallpaper** assigns the picture as the background image for your Lock screen. Crop the image, then tap **DONE** to assign the picture.

Working with photos

Use the **Gallery** app to view your pictures and edit them.



To view and browse photos

1. Tap the **Home Button**  > the **Apps icon**  > **Gallery** .
2. Open an album and tap a picture.
3. Tap the screen to display the icon bar and the Home Touch Buttons Bar. The following options are available.
 - ▶ Tap the **Menu icon**  to open the Options menu to access **SmartShare, Set image as, Move, Copy, Copy to Clip Tray, Lock, Slideshow, Rotate, Crop, Add/Remove location, Show on map, Rename, Print, or Details.**
 - ▶ Tap the **Delete icon**  to delete the picture.
 - ▶ Tap the **Share icon** , tap the sharing method, then complete as necessary to share the picture.
 - ▶ Tap the **Camera icon**  to switch to camera mode.
 - ▶ Tap the **Edit icon**  to open the editing screen which allows you to change the picture (such as cropping, rotating, tuning, adding effects, and more).

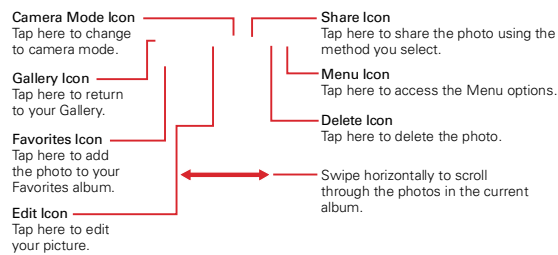
▶ Tap the **Favorites icon**  to set the picture to your Favorites folder.



Music

Your phone has a music player that lets you play all of your favorite tracks. To access the music player, tap the **Home Button**  > the **Apps icon**  > **Music** .

Add music files to your phone

Start by transferring music files to your phone:

- ▶ Transfer music using Media sync (MTP).
- ▶ Download from the Web.
- ▶ Synchronize your phone to a computer.
- ▶ Receive files via Bluetooth.

Transfer music using Media sync (MTP)

1. Connect the phone to your PC using the USB Cable.
2. Select the **Media sync (MTP)** option. Your phone will appear as another hard drive on your computer. Click on the drive to view it. Copy the files from your PC to the drive folder.

- When you're finished transferring files, swipe the Status Bar downward and tap **USB connected** > **Charge phone**. You may now safely unplug your phone.

Playing a song









- Tap the **Home Button** ○ > the **Apps icon** ☰ > **Music** 🎵.
- Tap the **Songs** tab (Music tabs are displayed across the top of the screen).
- Tap the song you want to play.

TIP To find a song, you can tap the **Search icon** 🔍 at the top of the screen or tap the letter the song begins with using the alphabet listed along the right side of the screen.

Music player icons



1		Tap to share your music via the SmartShare function.
2		Tap to set the current song as a favorite (toggle it on or off).
3		Tap to see the current playlist.
4		Tap to access the Music player Options menu.
5		Tap to set the shuffle mode (toggle it on or off).

6		Tap to set the repeat mode (on, off, or same song).
7		Tap to manage the music volume. The pop-up window also allows you to modify all phone sounds  and set music interruptions. The Volume Keys on the back of the phone will also adjust the volume.
8		Tap to go back to the beginning of the song. Tap 3 times to return to the previous song. Touch and hold to rewind in 3 second increments.
9		Tap to pause playback.
		Tap to resume playback.
10		Tap to skip to the next track on the album or in the playlist. Touch and hold to fast-forward in 3 second increments.
11		Tap to set available audio effects.

Other music player options

- ▶ Touch and hold any song in the music library to access its context menu which can include:

Play, Add to playlist, Delete, Share, Set as ringtone, and Search.

Tap the **Menu icon**  in the music library to access its Options menu which can include: **Cloud, Select to play, Add to playlist, Delete, Share, Settings, and Help.**

Turning the music player off

To stop the music player, swipe the Status Bar downward, then tap the **Close icon**  in the upper-right corner of the Music notification.

- NOTES**
- Some file formats are not supported, depending on the device software.
 - If the file size exceeds the available memory, an error can occur when you open files.
 - Music file copyrights may be protected by international treaties and national copyright laws. Therefore, it may be necessary to obtain permission or a license to reproduce or copy music. In some countries, national laws prohibit private copying of copyrighted material. Before downloading or copying the file, check the national laws of the relevant country concerning the use of such material.

To use a song as a ringtone

You can use a song as your phone ringtone, in place of one of the ringtones that come with the phone.

- ▶ Touch and hold a song in the Music library list. In the context menu that opens, tap **Set as ringtone**, then tap **Phone ringtone** or **Caller ringtones**.



OR

- ▶ On the music player screen, tap the **Menu** icon  tap **Set as ringtone**, then tap **Phone ringtone** or **Caller ringtones**.

Working with Playlists

You can create playlists to organize your music files into sets of songs, which you can play in the order you set or in a shuffle.

To create a playlist

1. From the Music library, tap the **Music Menu** icon  (in the upper-left corner of the screen), then tap **Playlists**.
2. Tap the **New** icon .
3. Enter a name for the playlist and tap **OK**.
4. Select the songs you want to add to a playlist, then tap **ADD**. The new playlist is added to the Playlist tab.

To add a song to a playlist

1. From the Music library, touch and hold the song you want to add to a playlist.
2. In the context menu that opens, tap **Add to playlist**, then tap the name of the playlist you want to add it to.

To remove a song from a playlist

1. Open a playlist.
2. Touch and hold the song you want to remove, then tap **Remove from playlist** in the context menu that appears.

To delete a playlist

1. Open the Playlists library.
2. Touch and hold the playlist, then tap **Delete** in the context menu that appears.
3. Tap **YES** to confirm.

To rename a playlist

1. Open the Playlists library.
2. Touch and hold the playlist, then tap **Rename** in the context menu that appears.
3. Enter a name, then tap **OK**.

To delete multiple songs





- ▶ Open the Music library screen, tap the **Songs** tab, tap the **Menu** icon , then tap **Delete**. Checkmark each of the songs you want to delete, tap **DELETE**, then tap **YES** to confirm.

NOTE Tap the **Menu** icon  from another Music tab to delete one or more of the items in that selected tab.

Play Store

Play Store allows you to browse and search for free and paid applications.

To open the Play Store app

- ▶ Tap the **Home Button**  > the **Apps** icon  > **Play Store**  or tap the **Play Store** icon  on the Home screen.

To get help with Play Store

Play Store Help web pages are available from all Play Store screens.

- ▶ Swipe from the left edge of the screen to the right, then tap **Help & Feedback**.

The Chrome app opens to the Play Store Help page, with links to many help topics.

To open a screen with details about an app

- ▶ At any time while browsing in Play Store, tap an app to open its details screen.

The App details screen includes a description, ratings, comments, and related information about the app. From this screen, you can download, install, uninstall, rate the app, and more.



Downloading and Installing Apps

When you find an app you want, you can install it on your phone.

To download and install an app

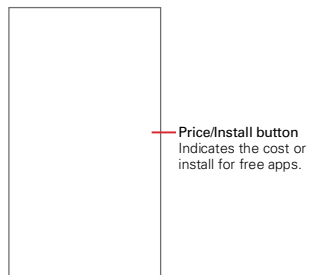
NOTE Before you can download a paid app, you must set up a billing arrangement.



1. Tap the **Home Button**  > **Play Store** .
2. Tap a category from the homepage or tap the **Search** icon  (in the top right corner of the screen) to search for an app.
3. Tap **INSTALL** or the **Price** button to download the selected app.
4. If you agree with the app's access requirements, tap **ACCEPT**.
5. The app will be downloaded and installed.

Play Store Options

On the Play Store homepage, drag the left edge of the screen to the right to access **Apps & Games**, **Entertainment**, **Movies & TV**, **Music**, **Books**, **Newsstand**, **My account**, **My wishlist**, **Redeem**, **People**, **Settings**, **Help & Feedback**, **Parent Guide**, and **About Google**.

Your Wishlist



While viewing an app (or music, games, etc.), tap the **Wishlist** icon  at the top of the screen to add it to your wishlist for future reference.

YouTube™

Opening YouTube and Watching Videos



You can browse, search for, view, upload, and rank YouTube videos on your phone with the YouTube app.

To open the YouTube app

Tap the **Home Button**  > the **Apps icon**  > **YouTube** .

- ▶ Search for and tap a video to watch it.
- ▶ Tap the **Menu icon**  for the YouTube Options menu (**Settings, Privacy policy, Help & feedback and Sign out**).

To search for videos

1. Tap the **Search icon**  (at the top of the main YouTube screen).
2. Enter the text to search for or tap the **Microphone icon**  to search by voice.
3. Tap a suggestion below the search box or tap the **Search button**  on the keyboard.
4. Scroll through the search results and tap a video to watch it.

Capture+

Use the Capture+ feature to capture a screen shot and use it to write a memo.

To access the Capture+ feature





1. While viewing the screen you want to capture, drag the Status Bar downward, then tap the Capture+ icon .



2. Select the desired tool from the toolbar (**Pen type**, **Color**, and **Eraser**). Then create a memo using a fingertip to draw or erase pen marks (don't use your fingernail or any other rigid object).











3. Tap the **Save** icon  to save the memo or tap the **Back Button**  to exit at anytime without saving it.



NOTE Tap the toolbar handle  (at the top of the screen) to display or hide the Capture+ toolbar options.

Using Capture+ options

The following options are available when using Capture+.

	Tap to save your memo.
	Tap to undo the most recent action.
	Tap to redo the most recently deleted action.
	Tap to insert text into your memo.
	Tap to crop the image of memo.
	Tap to select the pen type, color, and transparency.
	Tap to erase pen marks you've made on the memo.
	Tap to hide or display the toolbar.

Viewing saved memos

Tap the **Home Button**  > the **Apps icon**  > **Gallery**  and then select the **Capture+** album.

OR

Access **QuickMemo+**  in the Applications screen and select the desired memo.

Capturing a screen shot

To capture a screen shot without the Capture+ feature, press both the **Power/Lock Key**  (on the back of the phone) and the **Volume Down Key** (on the back of the phone) at the same time. The captured image is automatically saved in the **Gallery** app in the **Screenshots** folder.

QSlide

The QSlide function enables an overlay window on your phone's display for easy multi-tasking. The overlay window can be moved, resized, or made transparent. QSlide windows can be opened from the **QSlide apps bar** on

the Notifications panel, or directly from the apps that support the QSlide function.

To open a QSlide window

1. Drag the Status Bar downward, tap , then tap the desired app on the QSlide apps bar.





OR

While using an app that supports QSlide, tap the **Menu** icon , then tap QSlide.

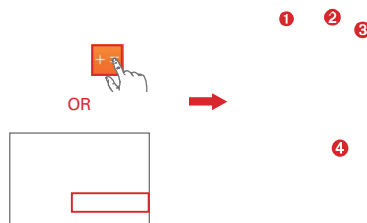
Using QSlide

The QSlide function opens the associated app in a window in the foreground, allowing you to access other applications in the background. It's displayed continuously on the screen until you close it.





1		Tap to return to full window view.
2		Slide to adjust the transparency.
3		Tap to exit the QSlide function.
4		Drag to adjust the size of the QSlide window.

NOTE The QSlide function can support up to two windows at the same time. QSlide only supports the following apps: Video, Phone, Contacts, Messaging, Calendar, Calculator, Email, and File Manager.

Customizing the QSlide bar icons

You can set the order of the icons displayed in the QSlide bar, as well as which icons are displayed.









1. Open the Notifications panel and swipe to the left on the QSlide apps bar, then tap the **Edit** icon 
 - ▶ Drag one of the icon handles  at the left side of the screen to move its icon to another position in the QSlide icon bar.
 - ▶ Checkmark the icons you want to display and remove the checkmark for the ones you want to remove.
2. Tap the **Back Button**  to return to the Notifications panel.

QuickRemote

QuickRemote turns your phone into a Universal Remote for your home TV or Set Top Box.

NOTE QuickRemote may not be available for some devices and areas.

Set up QuickRemote

1. Tap the **Home Button**  > the **Apps** icon  > the **LG** folder  > **QuickRemote** 
 - NOTE** You can also perform the initial set up of your QuickRemote from the Notifications panel. Swipe the Status Bar downward, tap the **QuickRemote** icon  (in the Quick settings bar), then tap **ADD REMOTE**. After initial set up, to set up additional devices from the Notifications panel, tap the **Full screen** icon , then tap the **New** icon  in the top right corner of the QuickRemote screen.
2. Tap the **Location** icon  (at the top left corner of the screen) to select a room type, then tap the **New** icon  to add the device.

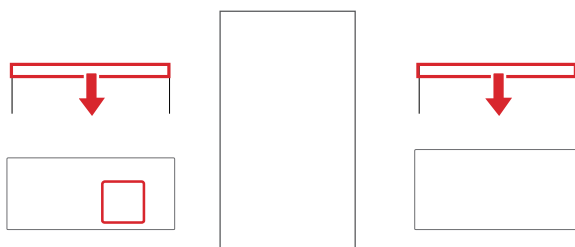

3. Select the type and brand of device, then follow the on-screen instructions to configure the device(s).

NOTE The QuickRemote operates the same way as an ordinary infrared (IR) remote control in your region or country. Be careful not to cover the infrared sensor at the top of the phone when you use the QuickRemote function. This function may not be supported depending on the model, the manufacturer, or service company.

Using QuickRemote

1. Open the **QuickRemote** app and choose the room where you configured the remote.
2. Select the remote you want to use by tapping its type/name on the QuickRemote bar along the left side of the screen.
3. Tap the buttons on the displayed remote.

NOTE When adding the TV remote control, QuickRemote could use the INPUT button to configure the appropriate remote control. When configuring the INPUT button, the TV input source could be changed. To reset the TV input source, tap the INPUT button on QuickRemote several times (depending on the number of devices connected to the TV).





QuickRemote options

To access the QuickRemote Options menu, tap the **Menu** icon  to select options including **Magic Remote setting** (only for LG tvs), **Edit remote name**, **Learn remote**, **Move remote**, **Delete remote**, **Settings** and **Help**.

Clock

You use the Clock app to access the Alarms, Timer, World clock, and Stopwatch functions. Access these functions by tapping the tabs across the top of the screen or swiping horizontally across the screen.

Setting an alarm

1. Tap the **Home Button**  > the **Apps icon**  > **Clock**  > the **Alarms tab** > the **Add icon** .
2. Set the desired alarm time. Tap the hour (or minutes), then tap the time you want on the clock graphic. Tap the **Keypad icon**  to set the time using a keypad instead of the clock graphic.
3. Set **Repeat**, **Snooze duration**, **Alarm with vibration**, **Alarm sound**, **Alarm volume**, **Auto-start app**, **Puzzle lock**, and **Memo**.
4. Tap **SAVE**.

NOTE To access (and change) the alarm settings from the alarm list screen, tap the **Menu icon**  then tap **Settings**.

Activating your alarm(s)

1. Open the **Clock** app and tap the **Alarms** tab (if necessary).
2. Tap the gray **Alarm clock icon**  to the right side of the alarm you want to activate. The icon turns blue when it's set.

Timer

The Timer tab can alert you with an audible signal when a set amount of time has passed.

1. Open the **Clock** app, then select the **Timer** tab.
2. Set the desired time on the timer.
3. Tap the **Start** button to start the timer.
4. Tap the **Stop** button to stop the timer.

Setting the World Clock

The World clock tab allows you to set up a list of cities to easily check current times in other time zones with a quick glance.

1. Open the **Clock** app, then select the **World clock** tab.
2. Tap the **New City** icon , search through the available cities, then tap the one you want.









Stopwatch



The Stopwatch tab allows you to use your device as a stopwatch.

1. Open the **Clock** app, then select the **Stopwatch** tab.
2. Tap the **Start** button to initiate the stopwatch.
 - ▶ Tap the **Lap** button to record lap times.
3. Tap the **Stop** button to stop timing.

Calculator

Using your calculator

1. Tap the **Home Button**  > the **Apps** icon  > the **Tools** folder  > **Calculator** .
2. Tap the number keys to enter numbers.
3. For simple calculations, tap the numbers and function (, ,  or ), then tap the **Result** button .

- NOTES**
- For more complex calculations, you can switch to the Scientific calculator. Simply rotate the phone sideways, or tap the **Menu** icon  then tap **Scientific calculator**.
 - To view the calculation history, tap the **Menu** icon  then tap **Calculation history**.





Calendar

Viewing Your Calendar and Events

The Calendar app allows you to track your schedule of events (that you created or that you've been invited to), organized by day, week, month, year, or agenda. Tap the **Calendar Menu** icon  to switch calendar views or access your Tasks list.

When you first set up your phone, you configured it to use an existing Google Account or you created a new account. The first time you open the Calendar app on your phone, it displays any existing calendar events from your Google Account on the web.





Adding an event to your calendar

1. Tap the **Home Button**  > the **Apps** icon  > **Calendar** .
2. Tap the **Calendar menu** icon  at the upper-left corner to change the calendar view (Day, Week, Month, Year, or Agenda).
3. Tap the date you want to add an event to and tap the **New event** icon .
4. Tap the **Event name** field and enter the event name.
5. Tap the **Location** field and enter the location. Check the date and enter the time you wish your event to start and finish.
6. Mark the **All day** box, if applicable.
7. Tap **More** to enter additional options such as **Repeat**, **Repeat until**, **Guests**, **Description**, **Reminders**, **Show me as**, and **Privacy**, as necessary.
8. Tap **SAVE** to save the event in the calendar.

TIP To quickly save an event, simply touch and hold the date on the calendar.

Using Event pocket

Use the Event pocket feature to easily add events to your Calendar. You can add events using images, text, memos, tasks, location, and also invites and events from your Facebook account.

1. Open the **Calendar** app, then tap the **Event pocket** icon  to split the screen (Calendar on the left and Pocket on the right).
2. Tap a pocket type to view the items saved in it, then drag an item on to the date you want it added to in your Calendar.
 - ▶  displays files and images.
 - ▶  displays events from your Facebook account.
 - ▶  displays location markers from the Maps app.
 - ▶  displays your saved tasks.
3. The event is automatically saved. You can edit the event to add additional details.

NOTE When entering text in Calendar, tap **POCKET** (at the top of the on-screen keyboard) to save it in the Pocket folder.

QSlide for the Calendar app



You can view your month calendar in a QSlide window allowing you to easily check dates, obligations, etc. while using other apps at the same time.

1. Open the **Calendar** app.
2. Tap the **Menu** icon  then tap **QSlide** to display the month Calendar in a QSlide window.
 - ▶ Swipe left and right to scroll through the months.
 - ▶ Tap a date to view the events for that day in your Day calendar.

Maps

The Maps app allows you to find places and get directions.

To open the Maps app

- ▶ Tap the **Home Button**  > the **Apps icon**  > **Maps** .

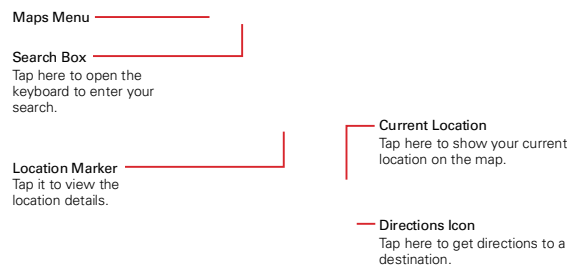

Maps navigation

- ▶ Tap the **Maps Menu** icon  (at the left side of the search box) to access **Your places**, **Your timeline**, **Your contributions**, **Offline areas**, **Explore**, **Traffic**, **Public transit**, **Bicycling**, **Satellite**, **Terrain**, **Google Earth**, **Update to the latest version**, **Tips and Tricks**, **Add a missing business**, **Settings**, **Help**, and **Send feedback**.
- ▶ Drag across the screen to move across a displayed map.
- ▶ Pinch-to-zoom to zoom in or out of the map view.







Maps icons

Tap **Search Box** to open the keyboard to enter your search request.

- ▶ Red markers indicate search matches.
- ▶ Tap a marker to view the location information. You can call the establishment, save the location as a favorite, and view its website.

Tap the **Menu** icon  to Add label, Share, add a photo, Claim this business.

 Tap to get directions to a destination.

- ▶ Use the starting point to insert **Your location** or select from recent Map history.
- ▶ Get directions by **Car** , **Transit** , **Walking**  or **Bicycling** .
- ▶ Tap the estimated time to view the directions in text format (instead of map view).
- ▶ Once starting and destination points are entered, you can tap the reverse icon  (on the right side of the screen) to reverse the directions.
- ▶ When viewing directions, tap the **Menu** icon  to change the map view (Reverse, Share directions, All traffic, Satellite, Terrain, and Route options).

 Tap to access map layers, Settings, Help, Send feedback, and Tips and Tricks.

 Tap to display your current location on the map.

Voice Mate

You can ask Voice Mate to perform phone functions using your voice, such as calling a contact, setting alarms, or searching the web. You can say “help” to help you get started.

NOTE The Voice Search app will also perform phone functions from your verbal command.

To open the Voice Mate app

▶ Tap the **Home Button**  > the **Apps** icon  > the **LG folder**  > **Voice Mate** .

OR

▶ Open the Notifications panel and tap the **Voice Mate** icon in the Quick Settings bar.



Using the Voice Mate app

1. Open the **Voice Mate** app.
2. The **Speak** icon  illuminates. Say what you want it to do for you.
 - ▶ If you say “Call Rachel”, Voice Mate will call your contact Rachel.

NOTE Voice Mate confirms found match requests before executing it. To skip confirmation for exact matches (name or number), access the Voice Mate settings and checkmark **Skip confirmation**.

Voice Mate Icons

The following Voice Mate icons are displayed at the bottom of the screen:

- ▶  Tap to display the Voice Mate user guide with help and examples.
- ▶  Tap to say a voice command to execute.
- ▶  Tap to type a command to execute.

Voice Mate settings





Open the Voice Mate app, then tap the **Settings** icon . Voice Mate settings include **Skip confirmation**, **Voice feedback**, **Save events to**, **Voice activation**, **Button vibration**, **Voice launch command**, **Voice launch on Lock screen**, **Skip secured Lock screen** and **Voice launch when charging**.

- NOTES**
- When the language setting for Voice Mate is not the same as the default language setting on your phone, some commands such as launching apps may not work.
 - When entering text, you can only use letters or numbers.
 - Voice Mate recognizes your speech better when you speak slowly.

Voice Search

You can also use the Voice Search app to perform phone functions using your voice.







To open the Voice Search app

- ▶ Tap the **Home Button**  > the **Apps icon**  > the **Google folder**  > **Voice Search** .

Voice Recorder







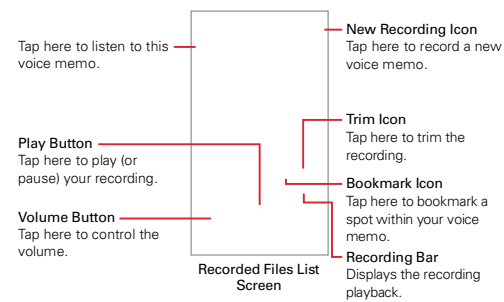
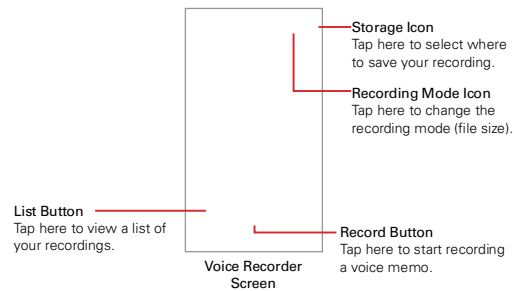



The Voice Recorder app records audible files. Use them to simply remind you about something you don't want to forget (like a grocery list) or record sound effects that you can attach to a message.

Record a Voice Memo

1. Tap the **Home Button**  > the **Apps icon**  > the **Tools folder**  > **Voice Recorder** .
 2. Tap the **Record button**  to start recording, then speak into the microphone.
 3. When you're finished, tap the **Stop button** .
- The recording is automatically saved to your recordings list.





Play a Voice Memo

1. Tap the **Home Button**  > the **Apps icon**  > the **Tools folder**  > **Voice Recorder** .
2. Tap the **List button** .
3. Tap the voice memo you want to play.
4. Use the following options while listening to a voice memo.
 - ▶ Tap the **Pause button**  to pause the recording.
 - ▶ Tap the **Stop button**  to end the playback and return to the List screen.
 - ▶ Tap the **Volume button**  to increase or decrease the volume. It also allows you to modify all phone volumes and sets allowed interruptions to your current task.
 - ▶ Tap on the slider recording bar to listen to a specific part of the recording.
 - ▶ Tap the **Bookmark icon**  to mark a place within the recording so you can jump directly to that spot when you play the recording.
 - ▶ Tap the **Trim icon**  to trim away segments at the beginning or end of the recording.

Managing your Voice memos

From the Recorded files list screen:





- ▶ Tap the **Share icon**  to share the voice memo using the available choices.
- ▶ Tap the **Delete icon**  to select the voice memo(s) you want to delete.
- ▶ Touch and hold a voice memo to open a context menu to select **Share**, **Delete**, **Rename**, **Trim**, or **Details**.

File Manager

Use the File Manager app to manage your folders and files stored in your phone.





File Manager makes it easy to view and manage your files. Simply tap a file type (All files, Music files, Image files, Video files, Document files, or Cloud storage), then tap on the necessary folders to find your files.

To open the File Manager app

Tap the **Home Button**  > the **Apps icon**  > the **Tools folder**  > **File Manager** .

File Manager Options

Open the **File Manager** app > tap **All files** > the **Internal storage** or **SD card** folder to access to the following File Manager options (at the bottom of the screen):

- ▶ : Allows you to create a new folder.
- ▶ : Allows you to move files and folders to another folder.
- ▶ : Allows you to copy files and folders to another folder.
- ▶ : Allows you to delete files and folders.

Tap the **Menu icon**  to access the **Sort by**, **View by**, **Share**, **Zip**, **Show/Hide hidden files**, and **Exit**.

Searching in File Manager



Open the **File Manager** app, tap **All files**, then tap the **Search icon**  to search for your files or information.

Settings



The Settings app allows you to customize and personalize your phone by setting how its screens look, how it notifies you, how it reacts, and a lot more.

NOTE Settings that are specific to an app are accessed through its own Settings menu within the app. For example, the Chrome app has settings specific to your Internet access.

To open the Settings app

- ▶ Tap the **Home Button**  > the **Apps icon**  > **Settings** .

OR

- ▶ Tap the **Home Button**  > touch and hold the **Recent Apps Button**  > **Settings**.

Viewing settings

Tap the **Menu icon**  at the upper-right corner of the **Settings** app, then tap **Tab view** (or **List view**).

- ▶ **List view** Scroll up and down through the list.
- ▶ **Tab view** Swipe left and right or tap the tab you want.

NOTE The instructions to perform tasks in this guide are based on the default **List view** setting.

WIRELESS NETWORKS

The Wireless Networks category allows you to configure and manage your device's wireless radio communications.

Airplane mode

Tap the switch  to toggle it On or Off. On disables all wireless connections.

Wi-Fi

Tap the switch  to toggle it On or Off. On connects to a Wi-Fi network (from your list of available, detected networks). Tap **Wi-Fi** to access the following settings to manage your Wi-Fi connection(s).

WI-FI NETWORKS

Displays all of the Wi-Fi networks that are within access range.

Tap one to connect to it. Touch and hold one to open its Options menu.

SEARCH Searches for nearby Wi-Fi networks.

Menu icon  Accesses the Wi-Fi Options menu.

Add Wi-Fi Allows you to manually add a Wi-Fi network by entering its name (SSID), security, and password.

Saved Wi-Fi Displays your saved Wi-Fi networks allowing you to manage them.

Advanced Wi-Fi Provides additional specific Wi-Fi connection settings.

NOTIFICATIONS

Wi-Fi notifications Enable this option to be notified if Wi-Fi networks are available nearby.

Show Wi-Fi pop-up Enable this option to be notified when a Wi-Fi network is available when you launch an app.

USEFUL SETTINGS

Manage networks Allows you to specify the order in which your Wi-Fi networks will be detected.

Keep Wi-Fi on when screen is off Allows you to set the Wi-Fi status when the screen is off.

Avoid bad Wi-Fi connections Enable this option to use the mobile network whenever the Wi-Fi network you're connected to doesn't have an internet connection. (Data usage may apply.)

CONNECTION

Wi-Fi Direct Allows you to connect with Wi-Fi devices without any access point.

Connect by WPS button Provides information to connect to a secured Wi-Fi network with a WPS button.

Connect by WPS PIN Provides the WPS PIN to connect to a secured Wi-Fi network.

PERSONAL

Install certificates Allows you to install certificates from storage.

INFORMATION

MAC address Displays your phone's MAC address (which may need to be entered in the router to connect to some wireless networks with MAC filters).

IP address Displays your phone's IP address.

Help Displays information about Wi-Fi networks.

Bluetooth

Tap the switch  to toggle it On or Off. On allows you to pair and connect with other Bluetooth devices.

Tap **Bluetooth** (with Bluetooth on) to use and manage your Bluetooth devices.

G4 Displays your phone's name and visibility status.

AVAILABLE DEVICES

Displays all of the Bluetooth devices that are within your phone's range. Tap one to pair and connect.

SEARCH Searches for nearby Bluetooth devices.

Menu icon  Accesses the Bluetooth Options menu.

Edit phone name Allows you to change your phone name for easy identification when pairing and connecting.

Received files Displays a list of the files received via a Bluetooth device.

Ready to connect Allows you to set whose Bluetooth devices can connect with your phone even if your Bluetooth is off.

Help Displays information about Bluetooth features.

 **Data usage**

Mobile data Tap the switch to toggle your mobile data connection On or Off. Off disconnects you from the mobile network. This allows you to manage your mobile data usage. You can use a Wi-Fi network connection for data instead.

Limit mobile data usage Enable this option so you can set the amount of data that can be used during your cycle date. When that amount is reached, your mobile data network connection will be disabled.

Alert me about data usage Enable this option so you can set the amount of data that will trigger an alert.

Cycle date The date displayed is your current data usage cycle. Tap it to change it.

Graph Displays a visual of your data usage. Limit lines are displayed if the data usage boxes are marked.

Apps list All of the apps that use data are listed.

Menu icon  Accesses the Data usage Options menu.

Display in MB/GB Changes the data usage units.

Restrict background data Enable this option to restrict the data that runs in the background.

Show Wi-Fi usage Displays a Wi-Fi tab (in addition to the Mobile tab) to view your Wi-Fi data usage.

Mobile hotspots Displays the networks that can be used as mobile hotspots. Turn on Wi-Fi and search, if necessary.

Mobile networks Allows you to set specific Mobile network settings.

 **Advanced Calling**

Allows you to learn about HD calls using your device, then activate Advanced Calling on your phone. You can make High Definition Voice and Video calls as well as calls over Wi-Fi when you add Advanced Calling to your line. Visit VerizonWireless.com/AdvancedCalling to learn how.

 Share & connect

DATA SHARE

TAP & PAY

Tap & pay Accesses the tap & pay app(s) you've downloaded to your phone which allow you to pay for items just by touching your phone to a reader at a register. If your phone doesn't have a default app, you can browse Play Store for other payment apps.

Android Beam Tap the switch to toggle it On or Off. On allows you to beam app content or files to other mobile devices by holding them close together. Tap **Android Beam** to view information on how to use it.

SmartShare Beam Tap the switch to toggle it On or Off. On allows you to receive multimedia content via SmartShare Beam from another LG phone or tablet.

G4 Allows you to change your phone's name for easy identification when setting up your devices for beaming.

Storage Allows you to select where files are stored.

File transfer history Displays all of the files sent and received via SmartShare Beam.

Help Displays information regarding how to use SmartShare Beam.

Media server Allows you to share the phone's multimedia content with nearby DLNA-compatible devices.

Content sharing Enable this option to allow nearby devices to access your content.

YOUR PHONE

G4 Allows you to change your phone's name to easily identify it. Tap the Image icon  to set an image to identify your phone.

Content to share Allows you to set the type of content you want to share between your devices.

Receive content Enable this option to allow nearby devices to send content to your phone.

NEARBY DEVICES

Allowed devices Displays the nearby devices that can access your phone.

Not-allowed devices Displays the nearby devices that will be denied access to your phone.

NOTE Tap the **Menu** icon  to use the DLNA feature.

SCREEN SHARE

Miracast Allows you to project your phone's content on a compatible TV.

Tap the switch at the top of the Miracast screen to toggle it On or Off.

G4 Allows you to change your phone's name to easily identify it.

AVAILABLE DEVICES

Displays all of the devices that can project your content via Miracast.

SEARCH FOR DEVICES Refreshes the available devices list.

HELP Displays information regarding how to use Miracast.

CONNECTION

Printing Allows you to set up wireless printer(s).

PRINT SERVICES

Cloud print Searches for available printers.

More

TETHERING

USB tethering Tap the switch to toggle it On or Off. On allows you to share your phone's mobile data connection using a USB connection. This setting is gray if not connected via USB.

Mobile Hotspot Tap the switch to toggle it On or Off. On allows you to use your device as a Mobile Hotspot for other devices to use your mobile network connection.

Set up Mobile Hotspot Allows you to enter the SSID and key for your mobile hotspot.

Manage connections Allows you to control which devices can connect.

Timeout Allows you to set when to turn off your hotspot.

CONNECTED DEVICES

Displays all connected devices.

Bluetooth tethering Tap the switch to toggle it On or Off. On shares the phone's Internet connection with other Bluetooth devices.

Help Displays help information regarding connecting other devices to your phone's Internet connection.

NETWORK

Mobile networks Allows you to set various mobile network settings.

Mobile data Enable this option to allow data access over the mobile network.

Data roaming access Allows you to set when to allow data roaming.

System select Allows you to set your network mode and CDMA roaming mode.

Network type and strength Displays the current network type and the signal strength.

Access point names Allows you to set up APNs for data service.

Roaming state Displays your current roaming state.

Default message app Allows you to set which app to use as your default messaging app.

VPN Allows you to set up VPNs (Virtual Private Networks). Choose **Basic VPN** or **LG VPN**.

NOTE Tap the **Menu** icon  to access additional settings. From the **Basic VPN** setting, it accesses **Always on VPN**. From the **LG VPN** screen, it accesses **Import certificates**, **Settings**, and **About**.

DEVICE

The **Device** category allows you to configure and manage the general device functions such as sound and display options.

 **Sound & notification****BASIC**

Sound profile Allows you to set the sound profile to **Sound**, **Vibrate only**, or **Silent**.

SOUND

Volume Allows you to set individual volume levels for ringtone and notifications, touch feedback, and other media.

Ringtone Allows you to set the ringtone for calls. You can also add and delete ringtones.

Ringtone ID Tap the switch to toggle it on or off. On allows you to set calls to play a specially composed ringtone.

VIBRATION

Vibration strength Allows you to set the vibration strength for calls and notifications and touch feedback.

Sound with vibration Enable this option to emit sound as well as vibration.

Vibration type Allows you to set the vibration pattern.

NOTIFICATIONS

Do not disturb Allows you to set a schedule when to prevent interruptions from notifications. You can set to allow certain features to interrupt when Priority only is set.

Lock screen Allows you to set the level of privacy for notifications displayed on your Lock screen.

Apps Allows you to set notifications for individual apps including preventing them from displaying notifications and setting priority.

Notification light Tap the switch to toggle it On or Off. On activates the LED light for the notifications you select, in the colour you set for each.

ADVANCED SETTINGS

Notification sound Allows you to set the sound heard for new notifications. You can also add and delete notification sounds.

Vibrate on tap Enable this option to feel a vibration when you tap the screen.

Sound effects Allows you to set when a sound is emitted to notify you of an event. Enable **Dialpad touch sounds**, **Touch sound**, **Screen lock sound**, **Sound when roaming**, and set the emergency tone behavior.

Message/call voice notifications Tap the switch to toggle it on or off. On allows your phone to automatically read your incoming calls and/or messages outloud. Tap **Message/call voice notifications** to modify your

notification settings for Calls, Messages, Read messages, and Language.

 **Display**

FONT

Font type Allows you to set the type used for the phone software.

Font size Allows you to set the size of the type used for the phone software.

BASIC SETTINGS

Brightness Allows you to set the brightness for the screen or you can checkmark its automatic setting.

Auto-rotate screen Enable this option to allow the screen to rotate automatically based on its orientation.

Screen timeout Allows you to set the amount of time before the screen times out due to inactivity to your conserve power.

Home touch buttons Allows you to set the buttons displayed at the bottom of all screens. Set which ones are displayed, their position, and what they look like.

ADVANCED SETTINGS

Daydream Tap the switch to toggle it on or off. Tap **Daydream** to choose which screensaver is displayed when the phone is sleeping while docked and/or charging.

Motion sensor calibration Allows you to improve the accuracy of the tilt and speed of the phone's sensor.

 **Home screen**

Select Home Allows you to set the layout (standard Android layout or a simplified layout) for the Home screen.

Smart Bulletin Tap the switch to toggle it On or Off. On displays an additional Home screen panel with the selected information. Tap **Smart Bulletin** to checkmark the information you want displayed on the panel.

SCREEN

Wallpaper Allows you to set your Home screen background (wallpaper). Select it from Wallpaper gallery, Gallery, Live wallpapers, Multi-photo, and Photos.

Screen swipe effect Allows you to set the effect when you swipe to change screens.

Allow Home screen looping Enable this option to allow continuous Home screen panel scrolling (loop back to the first panel after the last panel).

Allow apps list looping Enable this option to allow continuous Applications screen scrolling (loop back to the first screen after the last screen).

TIPS

Help Displays information regarding the Home screen items and functions.

Lock screen

SCREEN SECURITY

Select screen lock Allows you to set how to secure your phone from unintentional and/or unauthorized use.

Smart Lock Allows you to set trusted devices, places and/or face or voice or on-body detection. That will allow your phone will remain unlocked.

The Security lock settings depend on the Lock type. The following settings may also be displayed.

Hidden pattern Enable this option to display the unlock dot pattern when (and where) you tap the Lock screen.

Make pattern visible Enable this option to make your pattern visible while drawing it.

Screen swipe effect Allows you to set the effect seen when you swipe across the Lock screen.

Hidden PIN Enable this option to display the keypad when you tap the Lock screen.

Randomize PIN entry Sets the keypad to random numbers so that someone watching cannot detect your PIN from your hand movements.

Hidden password Enable this option to display the keyboard when you tap the Lock screen.

CUSTOMIZE

Wallpaper Allows you to set the background for your Lock screen.

Shortcuts Allows you to set the shortcuts at the bottom of the Swipe Lock screen.

Weather animation Enable this option to show weather animation for your current location or primary city set in the Weather app.

Contact info for lost phone Allows you to set text to be displayed on the Lock screen to easily identify the phone's owner.

LOCK TIME

Security lock timer Allows you to set the amount of time before the screen automatically locks after the backlight turns off (timeout due to inactivity).

Power button instantly locks Enable this option to instantly lock the screen when the Power/Lock Key is pressed. This setting overrides the Security lock timer setting.

Storage & USB

INTERNAL STORAGE

Total space Displays the total amount of space and the available space in your phone's internal memory in text and with a color-coded bar graph (unused space is gray). Corresponding apps and the amount of space they use is listed under each device user.

SD CARD

Total space Displays the total amount of space and the remaining available space in your memory card.

▲ Allows you to mount or unmount your microSD card.

To format the memory card, tap **MicroSD > Menu icon**  **> Settings > Format**.

Battery

BATTERY INFORMATION

The current battery status is displayed including the percentage of remaining charge and charging state.

Battery usage Displays battery usage information including a graph and app usage details.

Battery percentage on Status Bar Enable this option to display the battery level as a percentage on the Status Bar next to the battery icon.

BATTERY SAVER

Battery saver Tap the switch to toggle it On or Off. Tap **Battery saver** to adjust its settings.

Game optimizer Adjusts the video quality in games to save battery.

Smart cleaning

Smart cleaning displays the space in use and free space in your phone and allows you to selectively clean up your files.

Tap a folder location, checkmark the appropriate boxes, tap **CLEAN**, then tap **YES**.

Tap the **Menu icon**  **> Settings** to set the idle time period and notification interval.

Application manager

Swipe left and right to view the **DOWNLOADED** tab, **ON SD CARD** tab, **RUNNING** tab, or **ALL** tab.

Tap an entry to view more information, tap **Stop** (or **Force stop**), then **OK** to stop the app from running.

Tap the **Menu icon**  to access **Configure apps**, **Show system**, **Reset app preferences**, **Reset default apps** and **Uninstall apps**.

Dual window

Tap the switch at the top of its screen to toggle it On or Off.

Auto-open Enable this option to automatically open the Dual window feature when you tap a link on the full screen or tap an email image attachment.

Help Displays help information about using the Dual window feature.

PERSONAL

The Personal category allows you to configure, manage, and secure your personal information.

Location

Tap the switch at the top of its screen to toggle it On or Off.

On enables sharing your location when you search for information and use location-based apps, such as Maps.

E911 Location E911 Location cannot be turned off on any mobile phone.

Mode Allows you to set the mode that establishes your location. This setting is gray if the Location switch is off.

RECENT LOCATION REQUEST

Displays all of the apps that have requested access to your location. Tap one to view details.

LOCATION SERVICES

Camera Enable this option to automatically tag photos and videos with their location as identified by your phone.

Google Location History Allows you to enable or disable **Location History**. When enabled, Google periodically stores and uses your phone's most recent location data in connection with your Google Account.

Security

Content lock Allows you to set a lock type (password or pattern) for your Gallery and QuickMemo+ files. Once set, you can change it and backup your account from here.

ENCRYPTION

Encrypt phone Allows you to encrypt your phone data for security. Each time you turn on your phone, a PIN or password will be required to decrypt your data.

Encrypt SD card storage Allows you to encrypt or decrypt external microSD card data. Encrypted data is not accessible on other devices.

SIM CARD LOCK

Set up SIM card lock Allows you to lock your SIM card with a PIN or password. After it's set, you can change it from here.

PASSWORDS

Password typing visible Enable this option to briefly show each character of the password as you type it so you can see what you've entered.

PHONE ADMINISTRATION

Phone administrators Allows you to view and selectively deactivate phone administrators.

Unknown sources Enable this option to allow installation of non-Play Store apps.

Verify apps Enable this option to disallow or warn before installation of apps that may cause harm to your phone.

CREDENTIAL STORAGE

Storage type Displays the current storage type.

Certificate management Allows you to manage your security certificates.

Trusted credentials Allows apps to access your phone's encrypted store of secure certificates, related passwords, and other credentials. It includes a **System** tab and a **User** tab. Credential storage is used to establish some kinds of VPN and Wi-Fi connections.

Install from storage Allows you to install a secure certificate from storage.

Clear credentials Allows you to delete all secure certificates and related credentials and erases the secure storage's own password. You're prompted to confirm you want to clear this data.

ADVANCED SETTINGS

Trust agents Allows you to view and selectively deactivate Trust agents.

Screen pin Tap the switch at the top of its screen to toggle it on or off. On allows only the current app to be used. This is helpful when allowing children to use your phone.

App usage access Allows you to enable or disable the apps that can view your phone's app usage.

Accounts

Auto-sync data Enable this option to automatically sync all accounts you've added on your phone.

ACCOUNTS

Displays all of your added accounts. Tap one to view and/or manage (e.g., change details, access, sync settings, etc.) it.

ADD ACCOUNT Allows you to add accounts to your phone.

Language & keyboard

Language Allows you to set the language for your phone's software.

KEYBOARD & INPUT METHODS

Current keyboard Displays the name of the default keyboard.

LG Keyboard Tap to change the LG keyboard settings.

Google voice typing Enable this option to enable voice input. Tap to change its settings.

SPEECH

Text-to-speech output Allows you to set the preferred speech engine, speech rate, and pitch change. You can listen to an example and view the default language status.

MOUSE/TRACKPAD

Pointer speed Allows you to set the pointer speed on a slide bar.

Reverse buttons Reverse the mouse buttons to use primary button on right.

Backup & reset

LG BACKUP

LG Backup Allows you to copy data from a previous device to a new device. You can also back up data or restore data from a previous backup.

GOOGLE BACKUP

Back up my data Enable this option to automatically backup your data to Google servers.

Backup account Allows you to identify which account(s) to backup. You can also add new accounts.

Automatic restore Enable this option to automatically restore your device to its previous state when you reinstall an app.

Network settings reset Allows you to reset all of the network settings.

RESET

Factory data reset Allows you to erase all of the data on the phone. Read the warning, then tap **RESET PHONE**. Tap **Delete all** to confirm and reset the phone.

Reset settings Allows you to restore the default system settings.

 **Google**

Allows you to manage your Google apps and account settings.

SYSTEM

 **Shortcut key**

Tap the switch at the top of its screen to toggle it On or Off. On enables shortcuts activated by the **Volume Keys** . When this setting is enabled and the phone is locked or in timeout:

- ▶ Press the **Volume Up Key** twice to open the **Capture+** app.
- ▶ Press the **Volume Down Key** twice to launch the **Camera** app.

Quick Shot Enable this option to immediately take a photo when the **Volume Down Key** is pressed twice.

 **Date & time**

BASIC

Enable the **Auto-date & time** option or tap **Set date** and/or **Set time** to use a date/time other than the one provided by the network.

Enable the **Auto-time zone** option or tap **Select time zone** to use a time zone other than the one provided by the network.

TIME FORMAT

Use 24-hour format Enable this option to display the time using the 24-hour format (e.g., 13:00 instead of 1:00 PM).

 **Accessibility**

CATEGORIES

Vision Sets options for people with impaired sight.

TalkBack Tap the switch to toggle it On or Off. On provides verbal feedback when you tap the screen. To select an item, tap it, then double-tap it. To scroll, use three fingers to swipe across the screen. Tap **TalkBack** to access and adjust the TalkBack settings.

NOTE When a headset is connected, passwords can be heard as they are entered unless the settings are changed to read passwords aloud without a headset.

Message/call voice notifications Tap the switch to toggle it On or Off. On enables your phone to automatically read your incoming calls and/or messages aloud. Tap **Message/call voice notifications** to modify your notification settings for Calls, Messages, Read messages, and Language.

Lower screen brightness Enable this option to dim the backlight.

Font size Allows you to set the size of the text.

Touch zoom Tap the switch to toggle it On or Off. On allows you to triple-tap the screen to zoom in and out.

Screen color inversion Enable this option to invert the screen colors for higher contrast.

Screen color adjustment Tap the switch to toggle it On or Off. On allows you to adjust the screen's hue and contrast. Tap **Screen color adjustment** to adjust it.

Screen color filter Tap the switch to toggle it On or Off. On allows you to change color filters.

Power key ends call Enable this option to enable the **Power/Lock Key** to end a call.

Hearing Sets options for people with impaired hearing.

Captions Tap the switch to toggle it On or Off. On allows your phone to display caption text. Tap **Captions** to access and adjust its settings.

Notification light Tap the switch to toggle it On or Off. On enables the notification lights you set. Tap **Notification light** to set its notification options.

Flash alerts Enable this option to enable the camera's flash to blink to notify you of incoming calls and notifications.

Turn off all sounds Enable this option to silence all phone sounds including sounds from the earpiece.

Audio type Allows you to set the audio type.

Sound balance Move the slider on the bar to set the sound balance between the left and right channel.

Dexterity and interaction Sets options for people with impaired motor skills.

DEXTERITY

Touch feedback time Allows you to set the touch and hold delay time.

Touch assistant Tap the switch to toggle it On or Off. On displays a Touch assistant icon  which allows you to use its touch icons instead of hardware keys.

Screen timeout Allows you to set the amount of time before the backlight turns off automatically.

INTERACTION

Touch control areas Tap the switch to toggle it On or Off. On allows you to restrict access to a select portion of the screen.

GENERAL

Accessibility features shortcut Tap the switch to toggle it On or Off. On allows quick, easy access to selected features when you triple-tap the Home Button . Tap **Accessibility** to set the features you want activated.

Auto-rotate screen Enable this option to automatically rotate the screen based on the phone's orientation.

SERVICES

Switch Access Tap the switch at the top of its screen to toggle it On or Off. On allows you to enable switch access to selected features. Tap **OK**, then tap **SETTINGS** to set it up.

QuickCircle case

Tap the switch at the top of its screen to toggle it On or Off.

Select apps Allows you to set the apps that can be used directly in the QuickCircle case's window without opening it.

NOTE Tap the **Download** icon  at the upper-right corner of the Select apps screen to download other apps you can use with QuickCircle case.

Help Displays information regarding using your QuickCircle case with your phone.

About phone

View information about your phone including **Phone name**, **Network**, **Status**, **Battery**, **Hardware info**, **Software info**, **Legal info**, and **Patent information**.

System updates

Check for new system update Allows you to check for any available updates for your phone.

Show system update history Allows you to view your system update history.

LAST SYSTEM UPDATE Displays your last update information.

WARNING: This product contains chemicals known to the State of California to cause cancer and birth defects or reproductive harm.

Call (800) 243-0000 for more information.

Wash hands after handling.

HAC

This phone has been tested and rated for use with hearing aids for some of the wireless technologies that it uses. However, there may be some newer wireless technologies used in this phone that have not been tested yet for use with hearing aids. It is important to try the different features of this phone thoroughly and in different locations, using your hearing aid or cochlear implant, to determine if you hear any interfering noise. Consult your service provider or the manufacturer of this phone for information on hearing aid compatibility. If you have questions about return or exchange policies, consult your service provider or phone retailer.

Any changes or modifications not expressly approved in this user guide could void your warranty for this equipment. Use only the supplied antenna. Use of unauthorized antennas (or modifications to the antenna) could impair call quality, damage the phone, void your warranty and/or violate FCC regulations.

Don't use the phone with a damaged antenna. A damaged antenna could cause a minor skin burn. Contact your local dealer for a replacement antenna.

FCC RF Exposure Information

WARNING! Read this information before operating the phone.

In August 1996, the Federal Communications Commission (FCC) of the United States, with its action in Report and Order FCC 96-326, adopted an updated safety standard for human exposure to Radio Frequency (RF) electromagnetic energy emitted by FCC regulated transmitters. Those guidelines are consistent with the safety standard previously set by both U.S. and international standards bodies. The design of this phone complies with the FCC guidelines and these international standards.

Body-worn Operation

This device was tested for typical body-worn operations with the back of the phone kept 0.39inches (1cm) between the user's body and the back of the phone. To comply with FCC RF exposure requirements, a minimum separation distance of 0.39 inches (1cm) must be maintained between the user's body and the back of the phone. **Any belt-clips, holsters, and similar accessories containing metallic components may not be used.** Body-worn accessories that cannot maintain 0.39 inches (1cm) separation distance between the user's body and the back of the phone, and have not been tested for typical body-worn operations may not comply with FCC RF exposure limits and should be avoided.

Part 15.19 statement

This device complies with part 15 of the FCC Rules. Operation is subject to the following two conditions:

- (1) This device may not cause harmful interference.
- (2) This device must accept any interference received, including interference that may cause undesired operation.

Part 15.21 statement

Changes or modifications that are not expressly approved by the manufacturer could void the user's authority to operate the equipment.

Part 15.105 statement

This equipment has been tested and found to comply with the limits for a Class B digital device, pursuant to part 15 of the FCC Rules. These limits are designed to provide reasonable protection against harmful interference

in a residential installation. This equipment generates, uses and can radiate radio frequency energy and, if not installed and used in accordance with the instructions, may cause harmful interference to radio communications. However, there is no guarantee that interference will not occur in a particular installation.

If this equipment does cause harmful interference to radio or television reception, which can be determined by turning the equipment off and on, the user is encouraged to try to correct the interference by one or more of the following measures:

- Reorient or relocate the receiving antenna.
- Increase the separation between the equipment and receiver.
- Connect the equipment into an outlet on a circuit different from that to which the receiver is connected.
- Consult the dealer or an experienced radio/TV technician for help.

The phone by LG operates on Verizon's 4G LTE network, based on Long Term Evolution (LTE) technology and Mobile Broadband 4G networks in the United States*. Now you can connect easily at high speeds to the Internet, your corporate Intranet, and your email while you're away from the office.

* Service not available everywhere. Visit website (verizonwireless.com/4G) for a complete list of available areas.

* Information subject to change.

Consumer Information About Radio Frequency Emissions

Your wireless phone, which contains a radio transmitter and receiver, emits radio frequency energy during use. The following consumer information addresses commonly asked questions about the health effects of wireless phones.

Are wireless phones safe?

Scientific research on the subject of wireless phones and radio frequency ("RF") energy has been conducted worldwide for many years, and continues. In the United States, the Food and Drug Administration ("FDA") and the Federal Communications Commission ("FCC") set policies and procedures for wireless phones. The FDA issued a website publication on health issues related to cell phone usage where it states, "The scientific community at large ... believes that the weight of scientific evidence does not show an association between exposure to radiofrequency (RF) from cell phones and adverse health outcomes. Still the scientific community does recommend conducting additional research to address gaps in knowledge. That research is being conducted around the world and the FDA continues to monitor developments in this field. You can access the joint FDA/FCC website at <http://www.fda.gov> (under "c" in the subject index, select Cell Phones > Research). You can also contact the FDA toll-free at (888) 463-6332 or (888) INFO-FDA. In June 2000, the FDA entered into a cooperative research and development agreement through which additional scientific research is being conducted. The FCC issued its own website publication stating that "there is no scientific evidence that proves that wireless phone usage can lead to cancer or a variety of other problems, including headaches, dizziness or memory loss." This publication is available at <http://www.fcc.gov/cgb/cellular.html> or through the FCC at (888) 225-5322 or (888) CALL-FCC.

What does "SAR" mean?

In 1996, the FCC, working with the FDA, the U.S. Environmental Protection Agency, and other agencies, established RF exposure safety guidelines for wireless phones in the United States. Before a wireless phone model is available for sale to the public, it must be tested by the manufacturer and certified to the FCC that it does not exceed limits established by the FCC. One of these limits is expressed as a Specific Absorption Rate, or "SAR." SAR is a measure of the rate of absorption of RF energy in the body. Tests for SAR are conducted with the phone transmitting at its highest power level in all tested frequency bands. Since 1996, the FCC has required that

the SAR of handheld wireless phones not exceed 1.6 watts per kilogram, averaged over one gram of tissue.

Although the SAR is determined at the highest power level, the actual SAR value of a wireless phone while operating can be less than the reported SAR value. This is because the SAR value may vary from call to call, depending on factors such as proximity to a cell site, the proximity of the phone to the body while in use, and the use of hands-free devices. For more information about SARs, see the FCC's OET Bulletins 56 and 65 at http://www.fcc.gov/Bureaus/Engineering_Technology/Documents/bulletins or visit the Cellular Telecommunications Industry Association website at http://www.ctia.org/consumer_info/index.cfm/AID/10371. You may also wish to contact the manufacturer of your phone.

Can I minimize my RF exposure?

If you are concerned about RF, there are several simple steps you can take to minimize your RF exposure. You can, of course, reduce your talk time. You can place more distance between your body and the source of the RF, as the exposure level drops off dramatically with distance. The FDA/FCC website states that "hands-free kits can be used with wireless phones for convenience and comfort. These systems reduce the absorption of RF energy in the head because the phone, which is the source of the RF emissions, will not be placed against the head. On the other hand, if the phone is mounted against the waist or other part of the body during use, then that part of the body will absorb more RF energy. Wireless phones marketed in the U.S. are required to meet safety requirements regardless of whether they are used against the head or against the body. Either configuration should result in compliance with the safety limit." Also, if you use your wireless phone while in a car, you can use a phone with an antenna on the outside of the vehicle. You should also read and follow your wireless phone manufacturer's instructions for the safe operation of your phone.

Do wireless phones pose any special risks to children?

The FDA/FCC website states that "the scientific evidence does not show a danger to users of wireless communication devices, including children."

The FDA/FCC website further states that "some groups sponsored by other national governments have advised that children be discouraged from using wireless phones at all". For example, the Stewart Report from the United Kingdom ["UK"] made such a recommendation in December 2000. In this report a group of independent experts noted that no evidence exists that using a cell phone causes brain tumors or other ill effects. [The UK's recommendation to limit cell phone use by children was strictly precautionary; it was not based on scientific evidence that any health hazard exists. A copy of the UK's leaflet is available at <http://www.dh.gov.uk> (search "mobile"), or you can write to: NRPB, Chilton, Didcot, Oxon OX11 0RQ, United Kingdom. Copies of the UK's annual reports on mobile phones and RF are available online at www.iegmp.org.uk and <http://www.hpa.org.uk/radiation/> (search "mobile"). Parents who wish to reduce their children's RF exposure may choose to restrict their children's wireless phone use.

Where can I get further information about RF emissions?

For further information, see the following additional resources (websites current as of April 2005):

U.S. Food and Drug Administration

FDA Consumer magazine November-December 2000

Telephone: (888) INFO-FDA

<http://www.fda.gov> (Under "c" in the subject index, select Cell Phones > Research.)

U.S. Federal Communications Commission

445 12th Street, S.W. Washington, D.C. 20554

Telephone: (888) 225-5322

<http://www.fcc.gov/oet/rfsafety>

Independent Expert Group on Mobile Phones

<http://www.iegmp.org.uk>

Royal Society of Canada Expert Panels on Potential Health Risks of Radio Frequency Fields from Wireless Telecommunication Devices

283 Sparks Street Ottawa, Ontario K1R 7X9 Canada

Telephone: (613) 991-6990

http://www.rsc.ca/index.php?page=Expert_Panels_RF&Lang_id=120

World Health Organization

Avenue Appia 20 1211 Geneva 27 Switzerland

Telephone: 011 41 22 791 21 11

<http://www.who.int/mediacentre/factsheets/fs193/en/>

International Commission on Non-Ionizing Radiation Protection

c/o Bundesamt für Strahlenschutz Ingolstaedter Landstr. 1 85764
Oberschleissheim Germany

Telephone: 011 49 1888 333 2156

<http://www.icnirp.de>

American National Standards Institute

1819 L Street, N.W., 6th Floor Washington, D.C. 20036

Telephone: (202) 293-8020

<http://www.ansi.org>

National Council on Radiation Protection and Measurements

7910 Woodmont Avenue, Suite 800 Bethesda, MD 20814-3095

Telephone: (301) 657-2652

<http://www.ncrponline.org>

**Engineering in Medicine and Biology Society, Committee on Man and
Radiation (COMAR) of the Institute of Electrical and Electronics Engineers**

<http://ewh.ieee.org/soc/embs/comar/>

Consumer Information on SAR

(Specific Absorption Rate)

This model phone meets the government's requirements for exposure to radio waves. Your wireless phone is a radio transmitter and receiver. It is designed and manufactured not to exceed the emission limits for exposure to Radio Frequency (RF) energy set by the Federal Communications Commission of the U.S. Government. These limits are part of comprehensive guidelines and establish permitted levels of RF energy for the general population. The guidelines are based on standards that were developed by independent scientific organizations through periodic and thorough evaluation of scientific studies. The standards include a substantial safety margin designed to assure the safety of all persons, regardless of age and health.

The exposure standard for wireless mobile phones employs a unit of measurement known as the Specific Absorption Rate, or SAR. The SAR limit set by the FCC is 1.6 W/kg. Tests for SAR are conducted using standard operating positions specified by the FCC with the phone transmitting at its highest certified power level in all tested frequency bands. Although SAR is determined at the highest certified power level, the actual SAR level of the phone while operating can be well below the maximum value. Because the phone is designed to operate at multiple power levels to use only the power required to reach the network, in general, the closer you are to a wireless base station antenna, the lower the power output.

Before a phone model is available for sale to the public, it must be tested and certified to the FCC that it does not exceed the limit established by the government-adopted requirement for safe exposure. The tests are performed in positions and locations (e.g., at the ear and worn on the body) as required by the FCC for each model.

While there may be differences between SAR levels of various phones and at various positions, they all meet the government requirement for safe exposure.

The FCC has granted an Equipment Authorization for this model phone with all reported SAR levels evaluated as in compliance with the FCC RF emission guidelines. SAR information on this model phone is on file with the FCC and can be found under the Display Grant section of <http://www.fcc.gov/oet/ea/fccid> after searching on FCC ID **ZNFVS500**. Additional information on Specific Absorption Rates (SAR) can be found on the Cellular Telecommunications Industry Association (CTIA) website at <http://www.ctia.org/>.

* In the United States and Canada, the SAR limit for mobile phones used by the public is 1.6 watts/kg (W/kg) averaged over one gram of tissue. The standard incorporates a substantial margin of safety to give additional protection for the public and to account for any variations in measurements.

FCC Hearing-Aid Compatibility (HAC) Regulations for Wireless Devices

On July 10, 2003, the U.S. Federal Communications Commission (FCC) Report and Order in WT Docket 01-309 modified the exception of wireless phones under the Hearing Aid Compatibility Act of 1988 (HAC Act) to require digital wireless phones be compatible with hearing-aids. The intent of the HAC Act is to ensure reasonable access to telecommunications services for persons with hearing disabilities.

While some wireless phones are used near some hearing devices (hearing aids and cochlear implants), users may detect a buzzing, humming, or whining noise. Some hearing devices are more immune than others to this interference noise, and phones also vary in the amount of interference they generate.

The wireless telephone industry has developed a rating system for wireless phones, to assist hearing device users to find phones that may be compatible with their hearing devices. Not all phones have been rated. Phones that are rated have the rating on their box or a label located on the box.

The ratings are not guarantees. Results will vary depending on the user's hearing device and hearing loss. If your hearing device happens to be vulnerable to interference, you may not be able to use a rated phone successfully. Trying out the phone with your hearing device is the best way to evaluate it for your personal needs.

M-Ratings: Phones rated M3 or M4 meet FCC requirements and are likely to generate less interference to hearing devices than phones that are not labeled. M4 is the better/higher of the two ratings.

T-Ratings: Phones rated T3 or T4 meet FCC requirements and are likely to generate less interference to hearing devices than phones that are not labeled. T4 is the better/ higher of the two ratings.

Hearing devices may also be rated. Your hearing device manufacturer or hearing health professional may help you find this rating. Higher ratings mean that the hearing device is relatively immune to interference noise. The hearing aid and wireless phone rating values are then added together. A sum of 5 is considered acceptable for normal use. A sum of 6 is considered for best use.

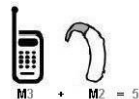

In the above example, if a hearing aid meets the M2 level rating and the wireless phone meets the M3 level rating, the sum of the two values equal M5. This should provide the hearing aid user with "normal usage" while using their hearing aid with the particular wireless phone. "Normal usage" in this context is defined as a signal quality that's acceptable for normal operation.

The M mark is intended to be synonymous with the U mark. The T mark is intended to be synonymous with the UT mark. The M and T marks are recommended by the Alliance for Telecommunications Industries Solutions (ATIS). The U and UT marks are referenced in Section 20.19 of the FCC Rules. The HAC rating and measurement procedure are described in the American National Standards Institute (ANSI) C63.19 standard.

To ensure that the Hearing Aid Compatibility rating for your phone is maintained, secondary transmitters such as Bluetooth and WLAN components must be disabled during a call.

For information about hearing aids and digital wireless phones:

Wireless Phones and Hearing Aid Accessibility

<http://www.accesswireless.org/>

Gallaudet University, RERC

<http://tap.gallaudet.edu/Voice/>

FCC Hearing Aid Compatibility and Volume Control

<http://www.fcc.gov/cgb/dro/hearing.html>

The Hearing Aid Compatibility FCC Order

http://hraunfoss.fcc.gov/edocs_public/attachmatch/FCC-03-168A1.pdf

Hearing Loss Association of America [HLAA]

<http://hearingloss.org/content/telephones-and-mobile-devices>

Caution:
Avoid potential hearing loss.

Prolonged exposure to loud sounds (including music) is the most common cause of preventable hearing loss. Some scientific research suggests that using portable audio devices, such as portable music players and cellular telephones, at high volume settings for long durations may lead to permanent noise-induced hearing loss. This includes the use of headphones (including headsets, earbuds and Bluetooth® or other wireless

devices). Exposure to very loud sound has also been associated in some studies with tinnitus (a ringing in the ear), hypersensitivity to sound and distorted hearing. Individual susceptibility to noise-induced hearing loss and other potential hearing problems varies.

The amount of sound produced by a portable audio device varies depending on the nature of the sound, the device, the device settings and the headphones. You should follow some commonsense recommendations when using any portable audio device:

- Set the volume in a quiet environment and select the lowest volume at which you can hear adequately.
- When using headphones, turn the volume down if you cannot hear the people speaking near you or if the person sitting next to you can hear what you are listening to.
- Do not turn the volume up to block out noisy surroundings. If you choose to listen to your portable device in a noisy environment, use noise-cancelling headphones to block out background environmental noise.
- Limit the amount of time you listen. As the volume increases, less time is required before your hearing could be affected.
- Avoid using headphones after exposure to extremely loud noises, such as concerts, that might cause temporary hearing loss. Temporary hearing loss might cause unsafe volumes to sound normal.
- Do not listen at any volume that causes you discomfort. If you experience ringing in your ears, hear muffled speech or experience any temporary hearing difficulty after listening to your portable audio device, discontinue use and consult your doctor.

TIA Safety Information

The following is the complete TIA Safety Information for wireless handheld phones.

Exposure to Radio Frequency Signal

Your wireless handheld portable phone is a low power radio transmitter and receiver. When ON, it receives and sends out Radio Frequency (RF) signals.

In August, 1996, the Federal Communications Commissions (FCC) adopted RF exposure guidelines with safety levels for handheld wireless phones.

Those guidelines are consistent with the safety standards previously set by both U.S. and international standards bodies:

ANSI C95.1 (1992) *

NCRP Report 86 (1986)

ICNIRP (1996)

* American National Standards Institute; National Council on Radiation Protection and Measurements; International Commission on Non-Ionizing Radiation Protection.

Those standards were based on comprehensive and periodic evaluations of the relevant scientific literature. For example, over 120 scientists, engineers, and physicians from universities, government health agencies, and industry reviewed the available body of research to develop the ANSI Standard (C95.1).

The design of your phone complies with the FCC guidelines (and those standards)

Tips on Efficient Operation

For your phone to operate most efficiently:

Don't touch the antenna unnecessarily when the phone is in use. Contact with the antenna affects call quality and may cause the phone to operate at a higher power level than otherwise needed.

Electronic Devices

Most modern electronic equipment is shielded from RF signals. However, certain electronic equipment may not be shielded against the RF signals from your wireless phone.

Pacemakers

The Health Industry Manufacturers Association recommends that a minimum separation of six (6) inches be maintained between a handheld wireless phone and a pacemaker to avoid potential interference with the pacemaker. These recommendations are consistent with the independent research by and recommendations of Wireless Technology Research.

Persons with pacemakers:

- Should ALWAYS keep the phone more than six (6) inches from their pacemaker when the phone is turned ON;
- Should not carry the phone in a breast pocket;
- Should use the ear opposite the pacemaker to minimize the potential for interference;
- Should turn the phone OFF immediately if there is any reason to suspect that interference is taking place.

Hearing Aids

Some digital wireless phones may interfere with some hearing aids. In the event of such interference, you may want to consult your service provider (or call the customer service line to discuss alternatives).

Other Medical Devices

If you use any other personal medical device, consult the manufacturer of your device to determine if it is adequately shielded from external RF

energy. Your physician may be able to assist you in obtaining this information.

Health Care Facilities

Turn your phone OFF in health care facilities when any regulations posted in these areas instruct you to do so. Hospitals or health care facilities may use equipment that could be sensitive to external RF energy.

Vehicles

RF signals may affect improperly installed or inadequately shielded electronic systems in motor vehicles. Check with the manufacturer or its representative regarding your vehicle. You should also consult the manufacturer of any equipment that has been added to your vehicle.

Posted Facilities

Turn your phone OFF in any facility where posted notices so require.

Aircraft

FCC regulations prohibit using your phone while in the air. Switch OFF your phone before boarding an aircraft.

Blasting Areas

To avoid interfering with blasting operations, turn your phone OFF when in a "blasting area" or in areas posted: "Turn off two-way radio". Obey all signs and instructions.

Potentially Explosive Atmosphere

Turn your phone OFF when in any area with a potentially explosive atmosphere and obey all signs and instructions. Sparks in such areas could cause an explosion or fire resulting in bodily injury or even death.

Areas with a potentially explosive atmosphere are often, but not always marked clearly. Potential areas may include: fueling areas (such as gasoline stations); below deck on boats; fuel or chemical transfer or storage facilities; vehicles using liquefied petroleum gas (such as propane or butane); areas where the air contains chemicals or particles (such as grain,

dust, or metal powders); and any other area where you would normally be advised to turn off your vehicle engine.

For Vehicles Equipped with an Air Bag

An air bag inflates with great force. DO NOT place objects, including either installed or portable wireless equipment, in the area over the air bag or in the air bag deployment area. If in-vehicle wireless equipment is improperly installed and the air bag inflates, serious injury could result.

Safety Information

Please read and observe the following information for safe and proper use of your phone and to prevent damage.

 Caution

Violation of the instructions may cause minor or serious damage to the product.

- Do not disassemble or open crush, bend or deform, puncture or shred.
- Do not modify or remanufacture, attempt to insert foreign objects into the battery, immerse or expose to water or other liquids, expose to fire, explosion or other hazard.
- Only use the battery for the system for which it is specified.
- Only use the battery with a charging system that has been qualified with the system per CTIA Certification Requirements for Battery System Compliance to IEEE1725. Use of an unqualified battery or charger may present a risk of fire, explosion, leakage, or other hazard.
- Do not short circuit a battery or allow metallic conductive objects to contact battery terminals.
- Replace the battery only with another battery that has been qualified with the system per this standard, IEEE-Std-1725. Use of an unqualified battery may present a risk of fire, explosion, leakage or other hazard. Only authorized service providers shall replace battery (If the battery is non-user replaceable).

- Promptly dispose of used batteries in accordance with local regulations.
- Battery usage by children should be supervised.
- Avoid dropping the phone or battery. If the phone or battery is dropped, especially on a hard surface, and the user suspects damage, take it to a service center for inspection.
- Improper battery use may result in a fire, explosion or other hazard.

Charger and Adapter Safety

- The charger and adapter are intended for indoor use only.
- Insert the battery charger vertically into the wall power socket.
- Only use the LG-approved battery charger. Otherwise, you may cause serious damage to your phone.
- Use the correct adapter for your phone when using the battery charger abroad.

Battery Information and Care

- Always unplug the charger from the wall socket after the phone is fully charged to save unnecessary power consumption of the charger.
- If you need to replace the battery, take it to the nearest authorized LG Electronics service point or dealer for assistance.
- Please read the manual for the specified charger to learn how to charge it.
- Do not damage the power cord by bending, twisting, or heating. Do not use the plug if it is loose as it may cause electric shock or fire.
- Do not place any heavy items on the power cord. Do not allow the power cord to be crimped as it may cause electric shock or fire.
- Unplug the power cord prior to cleaning your phone, and clean the power plug pin when it's dirty. When using the power plug, ensure that it's firmly connected. If not, it may cause excessive heat or fire. If you put your phone in a pocket or bag without covering the receptacle of the phone

(power plug pin), metallic articles (such as a coin, paperclip or pen) may short-circuit the phone. Always cover the receptacle when not in use.

- Recharge the battery after long periods of non-use to maximize battery life. Battery life will vary due to usage pattern and environmental conditions.
- Please use only an approved charging accessory to charge your LG phone. Improper handling of the charging port, as well as the use of an incompatible charger, may cause damage to your phone and void the warranty.
- The charging temperature range is regulated between 32°F (0°C) and 104°F (40°C). Do not charge the battery outside of the recommended temperature range. Charging outside this range might cause excessive heat generation, serious battery damage, and deterioration of battery's characteristics and cycle life.
- Do not use or leave the phone in direct sunlight or in a car heated by sunshine. The battery may generate excessive heat, smoke, or flame. It also might cause deterioration of battery's characteristics or cycle life.
- If skin or clothing is smeared with liquid from the battery, wash with fresh water. It may cause the skin inflammation.
- Please take your phone to an authorized service center immediately if this occurs.
- Do not handle the phone with wet hands while charging. It may cause an electric shock or seriously damage your phone.
- Do not place or answer calls while charging the phone as it may short-circuit the phone and/or cause electric shock or fire.
- The charger and adapter are intended for indoor use only.
- Insert the battery charger horizontally into the wall power socket.
- Talking on your phone for an extended period of time may reduce call quality due to heat generated during use.

- Do not use harsh chemicals (such as alcohol, benzene, thinners, etc.) or detergents to clean your phone as this could cause a fire.
- Do not place or answer calls while charging the phone as it may short-circuit the phone and/or cause electric shock or fire.

Explosion, Shock, and Fire Hazards

- Do not put your phone in a place subject to excessive dust and keep the minimum required distance between the power cord and heat sources.
- Unplug the power cord prior to cleaning your phone, and clean the power plug pin when it's dirty.
- When using the power plug, ensure that it's firmly connected. If not, it may cause excessive heat or fire.
- If you put your phone in a pocket or bag without covering the receptacle of the phone (power plug pin), metallic articles (such as a coin, paperclip or pen) may short-circuit the phone and may cause an explosion. Always cover the receptacle when not in use.

General Notice

- Do not place items containing magnetic components such as a credit card, phone card, bank book, or subway ticket near your phone. The magnetism of the phone may damage the data stored in the magnetic strip.
- Talking on your phone for a long period of time may reduce call quality due to heat generated during use.
- When the phone is not used for a long period time, store it in a safe place with the power cord unplugged.
- Using the phone in proximity to receiving equipment (i.e., TV or radio) may cause interference to the phone.
- Do not use the phone if the antenna is damaged. If a damaged antenna contacts skin, it may cause a slight burn. Please contact an LG Authorized Service Center to replace the damaged antenna.

- Do not immerse your phone in water, liquid, or expose to high humidity. If the phone is exposed to liquid, turn it off immediately and bring it to an LG Authorized Service Center.
- Do not paint your phone.
- The data saved in your phone might be deleted due to careless use, repair of the phone, or upgrade of the software. Please backup your important phone numbers (Ringtones, text messages, voice messages, pictures, and videos could also be deleted.) The manufacturer is not liable for damage due to the loss of data.
- When you use the phone in public places, set the ringtone to vibration so you don't disturb others.
- Do not turn your phone on or off when putting it to your ear.
- Use accessories, such as earphones and headsets, with caution. Ensure that cables are tucked away safely.

FDA Consumer Update



The U.S. Food and Drug Administration's Center for Devices and Radiological Health Consumer Update on Mobile Phones:

1. Do wireless phones pose a health hazard?

The available scientific evidence does not show that any health problems are associated with using wireless phones. There is no proof, however, that wireless phones are absolutely safe. Wireless phones emit low levels of Radio Frequency (RF) energy in the microwave range while being used. They also emit very low levels of RF when in standby mode. Whereas high levels of RF can produce health effects (by heating tissue), exposure to low level RF that does not produce heating effects causes no known adverse health effects. Many studies of low level RF exposures have not found any biological effects. Some studies have suggested that some biological effects may occur, but such findings have not been confirmed by additional research. In some cases, other researchers have had difficulty in reproducing those studies, or in determining the reasons for inconsistent results.

2. What is the FDA's role concerning the safety of wireless phones?

Under the law, the FDA does not review the safety of radiation-emitting consumer products such as wireless phones before they can be sold, as it does with new drugs or medical devices. However, the agency has authority to take action if wireless phones are shown to emit Radio Frequency (RF) energy at a level that is hazardous to the user. In such a case, the FDA could require the manufacturers of wireless phones to notify users of the health hazard and to repair, replace, or recall the phones so that the hazard no longer exists.

Although the existing scientific data do not justify FDA regulatory actions, the FDA has urged the wireless phone industry to take a number of steps, including the following:

- Support needed research into possible biological effects of RF of the type emitted by wireless phones;
- Design wireless phones in a way that minimizes any RF exposure to the user that is not necessary for device function; and
- Cooperate in providing users of wireless phones with the best possible information on possible effects of wireless phone use on human health.

The FDA belongs to an interagency working group of the federal agencies that have responsibility for different aspects of RF safety to ensure coordinated efforts at the federal level. The following agencies belong to this working group:

- National Institute for Occupational Safety and Health
- Environmental Protection Agency
- Occupational Safety and Health Administration
- National Telecommunications and Information Administration

The National Institutes of Health participates in some interagency working group activities, as well.

The FDA shares regulatory responsibilities for wireless phones with the Federal Communications Commission (FCC). All phones that are sold in the

United States must comply with FCC safety guidelines that limit RF exposure. The FCC relies on the FDA and other health agencies for safety questions about wireless phones.

The FCC also regulates the base stations that the wireless phone networks rely upon. While these base stations operate at higher power than do the wireless phones themselves, the RF exposures that people get from these base stations are typically thousands of times lower than those they can get from wireless phones. Base stations are thus not the subject of the safety questions discussed in this document.

3. What kinds of phones are the subject of this update?

The term “wireless phone” refers here to handheld wireless phones with built-in antennas, often called “cell”, “mobile”, or “PCS” phones. These types of wireless phones can expose the user to measurable Radio Frequency (RF) energy because of the short distance between the phone and the user’s head.

These RF exposures are limited by FCC safety guidelines that were developed with the advice of the FDA and other federal health and safety agencies. When the phone is located at greater distances from the user, the exposure to RF is drastically lower because a person’s RF exposure decreases rapidly with increasing distance from the source. The so-called “cordless phones,” which have a base unit connected to the telephone wiring in a house, typically operate at far lower power levels, and thus produce RF exposures far below the FCC safety limits.

4. What are the results of the research done already?

The research done thus far has produced conflicting results, and many studies have suffered from flaws in their research methods. Animal experiments investigating the effects of Radio Frequency (RF) energy exposures characteristic of wireless phones have yielded conflicting results that often cannot be repeated in other laboratories. A few animal studies, however, have suggested that low levels of RF could accelerate the development of cancer in laboratory animals. However, many of the studies that showed increased tumor development used animals that had been genetically engineered or treated with cancer-causing chemicals so as to be

pre-disposed to develop cancer in the absence of RF exposure. Other studies exposed the animals to RF for up to 22 hours per day. These conditions are not similar to the conditions under which people use wireless phones, so we do not know with certainty what the results of such studies mean for human health. Three large epidemiology studies have been published since December 2000. Between them, the studies investigated any possible association between the use of wireless phones and primary brain cancer, glioma, meningioma, or acoustic neuroma, tumors of the brain or salivary gland, leukemia, or other cancers. None of the studies demonstrated the existence of any harmful health effects from wireless phone RF exposures. However, none of the studies can answer questions about long-term exposures, since the average period of phone use in these studies was around three years.

5. What research is needed to decide whether RF exposure from wireless phones poses a health risk?

A combination of laboratory studies and epidemiological studies of people actually using wireless phones would provide some of the data that are needed. Lifetime animal exposure studies could be completed in a few years. However, very large numbers of animals would be needed to provide reliable proof of a cancer promoting effect if one exists. Epidemiological studies can provide data that is directly applicable to human populations, but ten or more years follow-up may be needed to provide answers about some health effects, such as cancer. This is because the interval between the time of exposure to a cancer-causing agent and the time tumors develop — if they do — may be many, many years. The interpretation of epidemiological studies is hampered by difficulties in measuring actual RF exposure during day-to-day use of wireless phones. Many factors affect this measurement, such as the angle at which the phone is held, or which model of phone is used.

6. What is the FDA doing to find out more about the possible health effects of wireless phone RF?

The FDA is working with the U.S. National Toxicology Program and with groups of investigators around the world to ensure that high priority animal

studies are conducted to address important questions about the effects of exposure to Radio Frequency (RF) energy.

The FDA has been a leading participant in the World Health Organization International Electro Magnetic Fields (EMF) Project since its inception in 1996. An influential result of this work has been the development of a detailed agenda of research needs that has driven the establishment of new research programs around the world. The project has also helped develop a series of public information documents on EMF issues.

The FDA and the Cellular Telecommunications & Internet Association (CTIA) have a formal Cooperative Research And Development Agreement (CRADA) to do research on wireless phone safety. The FDA provides the scientific oversight, obtaining input from experts in government, industry, and academic organizations. CTIA-funded research is conducted through contracts with independent investigators. The initial research will include both laboratory studies and studies of wireless phone users. The CRADA will also include a broad assessment of additional research needs in the context of the latest research developments around the world.

7. How can I find out how much Radio Frequency energy exposure I can get by using my wireless phone?

All phones sold in the United States must comply with Federal Communications Commission (FCC) guidelines that limit Radio Frequency (RF) energy exposures. The FCC established these guidelines in consultation with the FDA and the other federal health and safety agencies. The FCC limit for RF exposure from wireless phones is set at a Specific Absorption Rate (SAR) of 1.6 watts per kilogram (1.6 W/kg). The FCC limit is consistent with the safety standards developed by the Institute of Electrical and Electronic Engineering (IEEE) and the National Council on Radiation Protection and Measurement. The exposure limit takes into consideration the body's ability to remove heat from the tissues that absorb energy from the wireless phone and is set well below levels known to have effects. Manufacturers of wireless phones must report the RF exposure level for each model of phone to the FCC. The FCC website (<http://www.fcc.gov/oet/rfsafety>) gives directions for locating the FCC identification

number on your phone so you can find your phone's RF exposure level in the online listing.

8. What has the FDA done to measure the Radio Frequency energy coming from wireless phones?

The Institute of Electrical and Electronic Engineers (IEEE) is developing a technical standard for measuring the Radio Frequency (RF) energy exposure from wireless phones and other wireless handsets with the participation and leadership of FDA scientists and engineers. The standard, "Recommended Practice for Determining the Spatial-Peak Specific Absorption Rate (SAR) in the Human Body Due to Wireless Communications Devices: Experimental Techniques", sets forth the first consistent test methodology for measuring the rate at which RF is deposited in the heads of wireless phone users. The test method uses a tissue-simulating model of the human head. Standardized SAR test methodology is expected to greatly improve the consistency of measurements made at different laboratories on the same phone. SAR is the measurement of the amount of energy absorbed in tissue, either by the whole body or a small part of the body. It is measured in watts/kg (or milliwatts/g) of matter. This measurement is used to determine whether a wireless phone complies with safety guidelines.

9. What steps can I take to reduce my exposure to Radio Frequency energy from my wireless phone?

If there is a risk from these products — and at this point we do not know that there is — it is probably very small. But if you are concerned about avoiding even potential risks, you can take a few simple steps to minimize your exposure to Radio Frequency (RF) energy. Since time is a key factor in how much exposure a person receives, reducing the amount of time spent using a wireless phone will reduce RF exposure. If you must conduct extended conversations by wireless phone every day, you could place more distance between your body and the source of the RF, since the exposure level drops off dramatically with distance. For example, you could use a headset and carry the wireless phone away from your body or use a wireless phone connected to a remote antenna. Again, the scientific data does not demonstrate that wireless phones are harmful. But if you are

concerned about the RF exposure from these products, you can use measures like those described above to reduce your RF exposure from wireless phone use.

10. What about children using wireless phones?

The scientific evidence does not show a danger to users of wireless phones, including children and teenagers. If you want to take steps to lower exposure to Radio Frequency (RF) energy, the measures described above would apply to children and teenagers using wireless phones. Reducing the time of wireless phone use and increasing the distance between the user and the RF source will reduce RF exposure.

Some groups sponsored by other national governments have advised that children be discouraged from using wireless phones at all. For example, the government in the United Kingdom distributed leaflets containing such a recommendation in December 2000. They noted that no evidence exists that using a wireless phone causes brain tumors or other ill effects. Their recommendation to limit wireless phone use by children was strictly precautionary; it was not based on scientific evidence that any health hazard exists.

11. What about wireless phone interference with medical equipment?

Radio Frequency (RF) energy from wireless phones can interact with some electronic devices. For this reason, the FDA helped develop a detailed test method to measure Electro Magnetic Interference (EMI) of implanted cardiac pacemakers and defibrillators from wireless telephones. This test method is now part of a standard sponsored by the Association for the Advancement of Medical Instrumentation (AAMI). The final draft, a joint effort by the FDA, medical device manufacturers, and many other groups, was completed in late 2000. This standard will allow manufacturers to ensure that cardiac pacemakers and defibrillators are safe from wireless phone EMI.

The FDA has tested hearing aids for interference from handheld wireless phones and helped develop a voluntary standard sponsored by the Institute of Electrical and Electronic Engineers (IEEE). This standard specifies test methods and performance requirements for hearing aids and wireless

phones so that no interference occurs when a person uses a “compatible” phone and a “compatible” hearing aid at the same time. This standard was approved by the IEEE in 2000.

The FDA continues to monitor the use of wireless phones for possible interactions with other medical devices. Should harmful interference be found to occur, the FDA will conduct testing to assess the interference and work to resolve the problem.

12. Where can I find additional information?

For additional information, please refer to the following resources:

FDA web page on wireless phones
(<http://www.fda.gov/cellphones/>)

Federal Communications Commission (FCC) RF Safety Program
(<http://www.fcc.gov/oet/rfsafety>)

International Commission on Non-Ionizing Radiation Protection
(<http://www.icnirp.de>)

World Health Organization (WHO) International EMF Project
(<http://www.who.int/emf>)

National Radiological Protection Board (UK)
(<http://www.hpa.org.uk/radiation/>)

Driving

Check the laws and regulations on the use of wireless phones in the areas where you drive and always obey them. Also, if using your phone while driving, please observe the following:

- Give full attention to driving -- driving safely is your first responsibility;
- Use hands-free operation, if available;
- Pull off the road and park before making or answering a call if driving conditions or the law require it.

10 Driver Safety Tips

Your wireless phone gives you the powerful ability to communicate by voice almost anywhere, anytime. An important responsibility accompanies the benefits of wireless phones, one that every user must uphold.

When operating a car, driving is your first responsibility. When using your wireless phone behind the wheel of a car, practice good common sense and remember the following tips:

1. Get to know your wireless phone and its features such as speed dial and redial. Carefully read your instruction manual and learn to take advantage of valuable features most phones offer, including automatic redial and memory. Also, work to memorize the phone keypad so you can use the speed dial function without taking your attention off the road.
2. When available, use a hands-free device. A number of hands-free wireless phone accessories are readily available today. Whether you choose an installed mounted device for your wireless phone or a speaker phone accessory, take advantage of these devices if available to you.
3. Make sure you place your wireless phone within easy reach and where you can reach it without removing your eyes from the road. If you get an incoming call at an inconvenient time, if possible, let your voice mail answer it for you.
4. Suspend conversations during hazardous driving conditions or situations. Let the person you are speaking with know you are driving; if necessary, suspend the call in heavy traffic or hazardous weather conditions. Rain, sleet, snow, and ice can be hazardous, but so is heavy traffic. As a driver, your first responsibility is to pay attention to the road.
5. Don't take notes or look up phone numbers while driving. If you are reading an address book or business card, or writing a "to-do" list while driving a car, you are not watching where you are going. It is common sense. Do not get caught in a dangerous situation because you are reading or writing and not paying attention to the road or nearby vehicles.

6. Dial sensibly and assess the traffic; if possible, place calls when you are not moving or before pulling into traffic. Try to plan your calls before you begin your trip or attempt to coincide your calls with times you may be stopped at a stop sign, red light, or otherwise stationary. But if you need to dial while driving, follow this simple tip – dial only a few numbers, check the road and your mirrors, then continue.
7. Do not engage in stressful or emotional conversations that may be distracting. Stressful or emotional conversations and driving do not mix; they are distracting and even dangerous when you are behind the wheel of a car. Make people you are talking with aware you are driving and if necessary, suspend conversations which have the potential to divert your attention from the road.
8. Use your wireless phone to call for help. Your wireless phone is one of the greatest tools you can own to protect yourself and your family in dangerous situations – with your phone at your side, help is only three numbers away. Dial 911 or other local emergency number in the case of fire, traffic accident, road hazard, or medical emergency. Remember, it's a free call on your wireless phone!
9. Use your wireless phone to help others in emergencies. Your wireless phone provides you a perfect opportunity to be a "Good Samaritan" in your community. If you see an auto accident, crime in progress or other serious emergency where lives are in danger, call 911 or other local emergency number, as you would want others to do for you.
10. Call roadside assistance or a special wireless non-emergency assistance number when necessary. Certain situations you encounter while driving may require attention, but are not urgent enough to merit a call for emergency services. But you can still use your wireless phone to lend a hand. If you see a broken-down vehicle posing no serious hazard, a broken traffic signal, a minor traffic accident where no one appears injured or a vehicle you know to be stolen, call roadside assistance or other special non-emergency wireless number

The above tips are meant as general guidelines. Before deciding to use your mobile device while operating a vehicle, it is recommended that you consult your applicable jurisdiction's local laws or other regulations regarding such use. Such laws or other regulations may prohibit or

otherwise restrict the manner in which a driver may use his or her phone while operating a vehicle.

Cautions

- ▶ The user interface of Google apps (Google Search, Google Maps, Navigation, etc.) can vary depending on its software version.
 - ▶ Locations are inaccurate when GPS and Wi-Fi are not set.
 - ▶ With the Android operating system, some available Play Store apps only operate correctly with phones that have a specific screen resolution. Please be advised that some of the apps on Play Store may not be available for your phone due to an LCD resolution requirement that doesn't match your phone. In addition, please be aware that third party apps with programming defects may cause issues with your phone, including lock ups and resets.
 - ▶ All of the phone's contents, including content which you create or download, will be deleted after a Factory Reset.
-
- ▶ Use your phone in temperatures between 0°C and 40°C, if possible. Exposing your phone to extremely low or high temperatures may result in damage, malfunction, or even explosion.
 - ▶ There is risk of explosion if the battery is replaced with an incorrect type.
 - ▶ Dispose of used batteries according to the manufacturer's instructions. Please recycle when possible. Don't dispose as household waste.