



Advantium™ Oven

Advantium

Advantium Quick Start10
Cooking controls13
Customer information8
Oven features12
What is Advantium?9
Safety2-7

Speedcooking

Cooking tips15
Custom speedcook recipes18, 19
Custom speedcook recipe log20
Manual speedcook17
Power level16
Repeat last15
Resume feature15
Speedcook cookware17
Speedcook menu guide11
Speedcook-safe cookware5
Things that are normal21
Using a pre-set speedcook menu . . .14

Microwaving

Cooking tips23
Custom microwave recipes24, 25
Custom microwave recipe log24
Defrost (auto)26
Defrost (time)26
Defrosting tips27
Micro Express23
Microwave power levels23
Microwave-safe cookware6
Precautions to avoid possible exposure to excessive microwave energy2
Sensor cooking28, 29
Things that are normal30
Time cook23
Using pre-set microwave selections . .22

Other Features

Auto night light32
Automatic fan35
Beeper volume32
Child lockout34
Clock10, 32
Delay start35
Display ON/OFF32
Help33
Reminder35
Review32
Scroll speed32
Surface light34
Timer34
Vent fan34

Care and Cleaning

Cleaning the inside36, 37
Cleaning the outside38
Filters39, 40
Lamp covers37
Optional accessories40
Replacing lights38

Troubleshooting

Problem Solver41, 42

Customer Service

Customer information8
Service phone numbersBack Cover
Warranty47

Owner's Manual

SCA2000
SCA2001



IMPORTANT SAFETY INSTRUCTIONS

Advantium Oven

PRECAUTIONS TO AVOID POSSIBLE EXPOSURE TO EXCESSIVE MICROWAVE ENERGY

- (a) Do Not Attempt** to operate this oven with the door open since open-door operation can result in harmful exposure to microwave energy. It is important not to defeat or tamper with the safety interlocks.
- (b) Do Not Place** any object between the oven front face and the door or allow soil or cleaner residue to accumulate on sealing surfaces.
- (c) Do Not Operate** the oven if it is damaged. It is particularly important that the oven door close properly and that there is no damage to the:
- (1) door (bent),
 - (2) hinges and latches (broken or loosened),
 - (3) door seals and sealing surfaces.
- (d) The Oven Should Not** be adjusted or repaired by anyone except properly qualified service personnel.

IMPORTANT SAFETY INSTRUCTIONS

Advantium Oven

▲ WARNING! *To reduce the risk of burns, electric shock, fire, injury to persons, or exposure to excessive microwave energy:*

SAFETY PRECAUTIONS

- **Read all instructions before using this appliance. When using electrical appliances, basic safety precautions should be followed, including the following:**
- Read and follow the specific precautions in the *PRECAUTIONS TO AVOID POSSIBLE EXPOSURE TO EXCESSIVE MICROWAVE ENERGY* section on page 2.
- Be sure your appliance is properly installed and grounded by a qualified technician in accordance with the provided installation instructions.
- Install or locate this appliance only in accordance with the provided installation instructions.
- Some products such as whole eggs and sealed containers—for example, closed jars—are able to explode and should not be heated in this oven. Such use of the oven could result in injury.
- Do not mount this appliance over a sink.
- This oven is not approved or tested for marine use.
- This oven is UL listed for installation over electric and gas ranges.
- This oven was designed for use over ranges no wider than 36". It may be installed over both gas and electric cooking equipment.
- Do not operate this appliance if it has a damaged power cord or plug, if it is not working properly, or if it has been damaged or dropped.
- As with any appliance, close supervision is necessary when used by children.
- Use this appliance only for its intended use as described in this manual.
- Do not use corrosive chemicals or vapors in this appliance.
- This oven is specifically designed to heat, dry or cook food, and is not intended for laboratory or industrial use.
- This appliance must only be serviced by qualified service personnel. Contact nearest authorized service facility for examination, repair or adjustment.
- Do not cover or block any openings on the appliance.
- Do not store this appliance outdoors. Do not use this product near water—for example, in a wet basement, near a swimming pool, near a sink or in similar locations.
- Keep power cord away from heated surfaces.
- Do not immerse power cord or plug in water.
- See door surface cleaning instructions in the *Care and Cleaning of the Oven* section of this manual.
- To reduce the risk of fire in the oven cavity:
 - Do not overcook food. Carefully attend appliance when paper, plastic or other combustible materials are placed inside the oven while cooking.
 - Remove wire twist-ties and metal handles from paper or plastic containers before placing them in the oven.
 - Do not use the oven for storage purposes. Do not leave paper products, cooking utensils or food in the oven when not in use.
 - If materials inside the oven ignite, keep the oven door closed, turn the oven off and disconnect the power cord, or shut off power at the fuse or circuit breaker panel. If the door is opened, the fire may spread.
 - Do not use the Sensor Features twice in succession on the same food portion. If food is undercooked after the first countdown, use *TIME COOK* for additional cooking time.

IMPORTANT SAFETY INSTRUCTIONS

Advantium Oven

▲ WARNING!

SAFETY PRECAUTIONS

- Do not operate the oven without the oven rack (turntable) in place. The oven rack (turntable) must be unrestricted so it can turn.
- During and after use, do not touch, or let clothing or other flammable materials contact any interior area of the oven; allow sufficient time for cooling first.
- Do not store anything directly on top of the oven surface when the oven is in operation.
- Cook meat and poultry thoroughly—meat to at least an INTERNAL temperature of 160°F, and poultry to at least an INTERNAL temperature of 180°F. Cooking to these temperatures usually protects against foodborne illness.
- Keep the oven free from grease buildup.
- Potentially hot surfaces include the oven door, floor, walls and oven rack (turntable).

ARCING

Arcing can occur during both speedcooking and microwave cooking. If you see arcing, press the CLEAR/OFF pad and correct the problem.

Arcing is the microwave term for sparks in the oven. Arcing is caused by:

- Metal or foil touching the side of the oven.
- Foil not molded to food (upturned edges act like antennas).
- Metal cookware used during either speedcook or microwave cooking (except for the pans provided with the oven).
- Metal, such as twist-ties, poultry pins, or gold-rimmed dishes, in the oven.
- Recycled paper towels containing small metal pieces being used in the oven.
- Use foil only as recommended in this guide.

THE VENT FAN

- The fan will operate automatically under certain conditions (see the *Automatic Fan* section). Take care to prevent the starting and spreading of accidental cooking fires while the vent fan is in use.
- Clean the underside of the oven often. Do not allow grease to build up on the oven or the fan filters.
- In the event of a grease fire on the surface units below the oven, smother a flaming pan on the surface unit by covering the pan completely with a lid, a cookie sheet or a flat tray.
- Use care when cleaning the vent fan filters. Corrosive cleaning agents, such as lye-based oven cleaners, may damage the filters.
- When preparing flaming foods under the oven, turn the vent fan on.
- Never leave surface units beneath your oven unattended at high heat settings. Boilovers cause smoking and greasy spillovers that may ignite and spread if the oven vent fan is operating. To minimize automatic fan operation, use adequate sized cookware and use high heat on surface units only when necessary.

IMPORTANT SAFETY INSTRUCTIONS

Advantium Oven

▲ **WARNING!**

FOODS

- When microwaving, place all foods and containers on the white ceramic tray.
- Do not pop popcorn in your oven unless in a special microwave popcorn accessory or unless you use popcorn labeled for use in microwave ovens.
- Do not boil eggs in this oven. Pressure will build up inside egg yolk and will cause it to burst, possibly resulting in injury.
- Do not operate the oven without food inside. This may cause damage to the oven. It increases the heat around the magnetron and can shorten the life of the oven.
- Foods with unbroken outer “skin” such as potatoes, hot dogs, sausages, tomatoes, apples, chicken livers and other giblets, and egg yolks should be pierced to allow steam to escape during cooking.

■ **SUPERHEATED WATER**

Liquids, such as water, coffee or tea, are able to be overheated beyond the boiling point without appearing to be boiling. Visible bubbling or boiling when the container is removed from the microwave oven is not always present. THIS COULD RESULT IN VERY HOT LIQUIDS SUDDENLY BOILING OVER WHEN THE CONTAINER IS DISTURBED OR A SPOON OR OTHER UTENSIL IS INSERTED INTO THE LIQUID.

To reduce the risk of injury to persons:

- Do not overheat the liquid.
- Stir the liquid both before and halfway through heating it.
- Do not use straight-sided containers with narrow necks.
- After heating, allow the container to stand in the microwave oven for a short time before removing the container.
- Use extreme care when inserting a spoon or other utensil into the container.

Speedcook oven-safe cookware



The oven rack (turntable) must always be in place when using the oven.

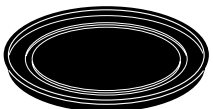

Put food directly on the black metal flat tray to speedcook.



Put food directly on the black metal grill tray to speedcook foods you would normally cook on the grill.

- **The oven and door will get very hot when speedcooking.**
- **Cookware will become hot** because of heat transferred from the heated food. Oven mitts will be needed to handle the cookware.
- Do not use coverings, containers or cooking/roasting bags made of foil, plastic, wax or paper when speedcooking.
- Do not cover the oven rack (turntable), trays or any part of the oven with metal foil. This will cause arcing in the oven.
- Use the black metal flat tray in the same way you would use a shallow baking pan or baking tray.
- Use the black grill tray for cooking steaks, fish and poultry.
- Place food directly on the trays when cooking.
- Any oven-safe dish can be used in your oven. Recipes in the Advantium Cookbook were tested in Pyrex® and Anchor Hocking® glass cookware and Corningware® ceramic casseroles. Cooktimes and results may vary when using other types of oven-safe dishes. Place them directly on the oven rack (turntable).
- Do not use the oven to dry newspapers.
- Use of the white ceramic tray when speedcooking will result in inferior cooking performance.

IMPORTANT SAFETY INSTRUCTIONS

Advantium Oven

▲ **WARNING!**

Microwave-safe cookware



The oven rack (turntable) must always be in place when using the oven.

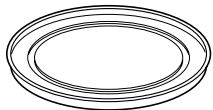

The white ceramic tray should always be in place when microwaving.

Make sure to use suitable cookware during microwave cooking. Most glass casseroles, cooking dishes, measuring cups, custard cups, pottery or china dinnerware which does not have metallic trim or glaze with a metallic sheen can be used. Some cookware is labeled “suitable for microwaving.”

- Place food or microwavable container directly on the white ceramic tray to cook your food.
- Use of either black metal tray during microwave cooking will result in inferior cooking performance.
- If you are not sure if a dish is microwave-safe, use this test: Place in the oven both the dish you are testing and a glass measuring cup filled with 1 cup of water—set the measuring cup either in or next to the dish. Microwave 30–45 seconds at high. If the dish heats, it should not be used for microwaving. If the dish remains cool and only the water in the cup heats, then the dish is microwave-safe.
- Cookware may become hot because of heat transferred from the heated food. Oven mitts may be needed to handle the cookware.
- Do not use recycled paper products. Recycled paper towels, napkins and waxed paper can contain metal flecks which may cause arcing or ignite. Paper products containing nylon or nylon filaments should be avoided, as they may also ignite.
- Use foil only as directed in this guide. TV dinners may be microwaved in foil trays less than 3/4" high; remove the top foil cover and return the tray to the box. When using foil in the oven, keep the foil at least 1" away from the sides of the oven.
- Do not use the oven to dry newspapers.
- If you use a meat thermometer while cooking, make sure it is safe for use in microwave ovens.
- Some styrofoam trays (like those that meat is packaged on) have a thin strip of metal embedded in the bottom. When microwaved, the metal can burn the floor of the oven or ignite a paper towel.
- Paper towels, waxed paper and plastic wrap can be used to cover dishes in order to retain moisture and prevent spattering. Be sure to vent plastic wrap so steam can escape.
- Not all plastic wrap is suitable for use in microwave ovens. Check the package for proper use.
- “Boilable” cooking pouches and tightly closed plastic bags should be slit, pierced or vented as directed by package. If they are not, plastic could burst during or immediately after cooking, possibly resulting in injury. Also, plastic storage containers should be at least partially uncovered because they form a tight seal. When cooking with containers tightly covered with plastic wrap, remove covering carefully and direct steam away from hands and face.
- Plastic cookware—Plastic cookware designed for microwave cooking is very useful, but should be used carefully. Even microwave-safe plastic may not be as tolerant of overcooking conditions as are glass or ceramic materials and may soften or char if subjected to short periods of overcooking. In longer exposures to overcooking, the food and cookware could ignite.

Follow these guidelines:

1. Use microwave-safe plastics only and use them in strict compliance with the cookware manufacturer’s recommendations.
2. Do not microwave empty containers.
3. Do not permit children to use plastic cookware without complete supervision.

IMPORTANT SAFETY INSTRUCTIONS

Advantium Oven

▲ WARNING!

SAFETY PRECAUTIONS

- Don't defrost frozen beverages in narrow-necked bottles (especially carbonated beverages). Even if the container is open, pressure can build up. This can cause the container to burst, possibly resulting in injury.
- Foods cooked in liquids (such as pasta) may tend to boil more rapidly than foods containing less moisture. Should this occur, refer to the *Care and Cleaning of the oven* section for instructions on how to clean the inside of the oven.
- Hot foods and steam can cause burns. Be careful when opening any containers of hot food, including popcorn bags, cooking pouches and boxes. To prevent possible injury, direct steam away from hands and face.
- Do not overcook potatoes. They could dehydrate and catch fire, causing damage to your oven.
- Avoid heating baby food in glass jars, even with the lid off. Make sure all infant food is thoroughly cooked. Stir food to distribute the heat evenly. Be careful to prevent scalding when warming formula. The container may feel cooler than the formula really is. Always test the formula before feeding the baby.
- Do not attempt to deep fry in the oven.

SAVE THESE INSTRUCTIONS

Introduction

Congratulations! You are now part of the cooking revolution!

As part of the vision to help consumers live better, easier lives, GE Appliances introduces the revolutionary GE Advantium oven with Speedcook technology. This new oven roasts, grills, bakes, browns and broils, just like your conventional oven—only faster—and with delicious results. You also save time because Advantium requires no preheating.

The information on the following pages will help you operate and maintain your new Advantium oven. We appreciate your purchase, and hope you will continue to rely on us whenever you need quality appliances for your home. We thank you for buying GE.

Product registration

Fill out the Consumer Product Registration Card.

Two Easy Ways To Register Your Appliance!

- Through the internet at www.geappliances.com.
 - Complete and mail the enclosed Product Registration Card.
-

Write down the model & serial numbers

You can find them on a label, behind the open oven door, on the front face.

These numbers are also on the Consumer Product Ownership Registration Card packed separately with your oven.

Proof of the original purchase date is needed to obtain service under the warranty.

For future reference, please write these numbers here:

Model Number

Serial Number

Read this manual

Inside you will find many helpful hints on how to use and maintain your oven properly. Just a little preventive care on

your part can save you a great deal of time and money over the life of your oven.

If you need service

You'll find many answers to common problems in the *Before You Call For Service* section. If you review our chart of *Troubleshooting Tips* first, you may not need to call for service at all.

If you do need service, you can relax knowing help is only a phone call away. A list of toll-free customer service numbers is included in the back section.

What is Advantium?

Advantium Oven

Getting to know Advantium

The new Advantium oven uses breakthrough Speedcook technology to harness the power of light. The Advantium oven cooks the outside of foods much like conventional radiant heat, while also penetrating

the surface so the inside cooks simultaneously. While halogen light is the primary source of power, a “microwave boost” is added with certain foods. Foods cook evenly and fast, retaining their natural moisture.

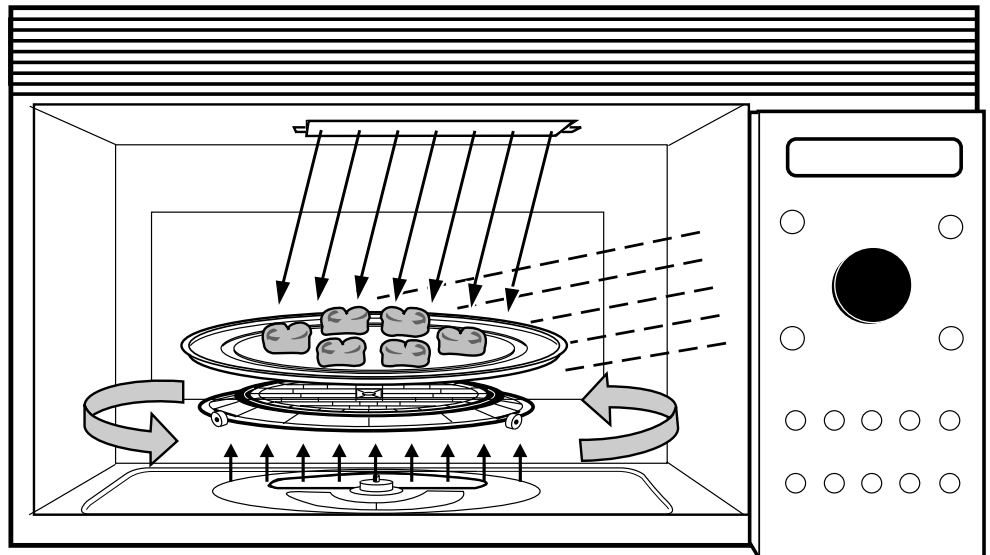

Turntable

- The oven rack (turntable) rotates to ensure even cooking.

Controls

- The oven control contains preset recipes.
- Turn and press dial makes menu selection easy.

Halogen Lamps

- Two 1500 watt halogen bulbs cook food from above.
- One 1500 watt halogen bulb cooks food from below.

Microwave

- A microwave “boost” is automatically added with certain foods.
- The oven can also be used as a 950 watt microwave oven.

Vent

- The oven and vent fan emit air from the upper grill area.

Set the clock

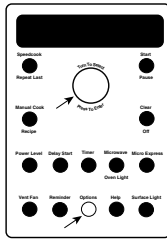

When you first plug in the oven or after a power outage:

1. Turn the selector dial to set the hour. Press the dial to enter.
2. Turn the dial to set the minute. Press the dial to enter.
3. Turn the dial to select AM or PM. Press the dial to enter.

To change the time:

1. Press the OPTIONS button.
2. Turn the dial to CLOCK. Press the dial to enter and follow the display directions to set.

Begin speedcooking

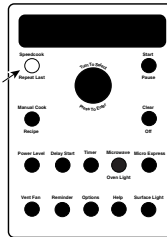

Step 1:

Press the SPEEDCOOK button.



The oven rack (turntable) must always be in place when using the oven.

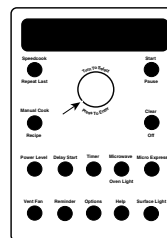

Step 2:

Turn the dial to select the type of food category you want. Press the dial to enter it.

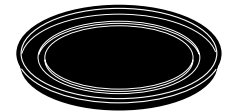

Put food directly on the black metal tray to speedcook.

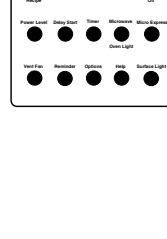

Step 3:

Turn the dial to select the specific food. Press the dial to enter it.



As a great option, put food directly on the black metal grill tray to speedcook foods you would normally cook on the grill.

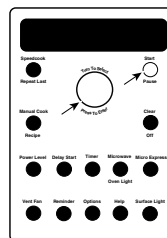

Step 4:

Turn the dial to select the amount, size, and/or doneness (if required, the oven will prompt you). Press the dial after each selection.

Step 5:

Once the display shows *ADJUST TIME OR START*, either press the dial or start button to start cooking.

■ Press CLEAR/OFF at any time to stop cooking.

Microwaving with Micro Express

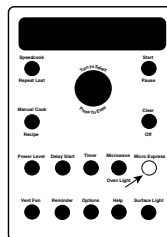

Press MICRO EXPRESS repeatedly for 30 second increments of microwave cooking time.

The oven starts immediately.



The oven rack (turntable) must always be in place when using the oven.

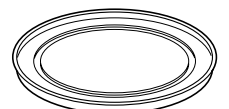

The white ceramic tray should always be in place when microwaving.

Speedcook Menu Guide

Speedcook Oven

Display prompts

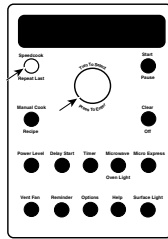

After pressing the SPEEDCOOK button, the oven will prompt you to make several selections, such as the example below.

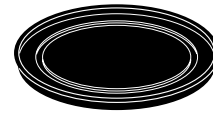

NOTE: When speedcooking, use black trays.

1. Turn the dial until *CHICKEN* appears. Press the dial to enter.
2. Turn the dial until *BONELESS BREASTS* appears. Press the dial to enter.
3. Turn the dial to *Select SIZE:*
Small (3-4 oz)
Large (5+ oz)
Press the dial to enter.
4. Turn the dial to *Select amount:*
1-2 pieces
3-4 pieces
Press the dial to enter.
5. Use *ROUND METAL TRAY* is displayed.

Pre-set speedcook menu selections

■ After a cooking cycle has been completed, use the Resume feature to cook for additional time.

■ To review settings during cooking, press the selector dial.

<i>Food Category</i>	<i>Menu Selection</i>	<i>Food Category</i>	<i>Menu Selection</i>
<i>Appetizers and Snacks</i>	<i>Bagel Bites</i> <i>Cheese Sticks, Froz</i> <i>Jalapeno Poppers</i> <i>Mini Egg Rolls, Froz</i> <i>Mini Nachos, Froz</i> <i>Onion Rings, Frozen</i> <i>Other Bite Size</i> <i>Pizza Rolls, Froz</i>	<i>Desserts</i>	<i>Churros, Frozen</i> <i>Cookie Dough, Froz</i> <i>Cookie Dough, Refr</i> <i>Pie Crust, Refr</i> <i>Turnovers, Frozen</i> <i>Turnovers, Refr</i>
<i>Breads</i>	<i>Biscuits, Refrig.</i> <i>Biscuits, Blueberry</i> <i>Breadsticks, Ref</i> <i>Cheese Loaf, Frozen</i> <i>Cornbread Sticks, Ref</i> <i>Crescent Rolls</i> <i>French Bread, Ref</i> <i>Garlic/Cheese Bread</i> <i>Loaf, Refrig</i> <i>Texas Toast</i>	<i>Fish and Seafood</i>	<i>Breaded Fish, Frozen</i> <i>Fish Sticks, Frozen</i> <i>Salmon Steaks</i> <i>Shellfish</i> <i>Swordfish Steaks</i> <i>Tuna Steaks</i> <i>Whitefish Fillets</i>
<i>Breakfast</i>	<i>Belgian Waffles</i> <i>Breakfast Burritos</i> <i>Breakfast Pizza</i> <i>Cinnamon Rolls, Refr</i> <i>French Toast, Froz</i> <i>Pancakes, Frozen</i> <i>Sausage Links</i> <i>Sausage Patties</i> <i>Strudels, Froz</i> <i>Waffles, Froz</i> <i>Waffle Sticks, Froz</i>	<i>Meats</i>	<i>Filet Mignon</i> <i>Hamburger</i> <i>Lamb Chops</i> <i>Pork Chops</i> <i>Steaks-Ribeye</i> <i>Steaks-Sirloin</i> <i>Steaks-Strip</i> <i>Steaks-T-bone</i>
<i>Chicken</i>	<i>Bone-In Pieces</i> <i>Boneless Breasts</i> <i>Fingers, Frozen</i> <i>Fried Chicken, Froz</i> <i>Nuggets, Frozen</i> <i>Patties, Frozen</i> <i>Tenders, Frozen</i> <i>Whole Chicken</i> <i>Wings, Frozen</i>	<i>Pizza</i>	<i>Deli/Fresh</i> <i>Pizza Shell, Filled</i> <i>Reg. Crust, Frozen</i> <i>Rising Crust, Frozen</i>
		<i>Potatoes</i>	<i>Baked Potatoes</i> <i>Frozen French Fries</i> <i>Frozen Tater Tots</i>
		<i>Recipe</i>	<i>Personal Recipes</i>
		<i>Sandwiches</i>	<i>Burritos, Frozen</i> <i>Corn Dogs, Frozen</i> <i>Cres Roll/Hot Dogs</i> <i>Grilled Sandwiches</i> <i>Pocket Sandwiches</i>

Oven features

Throughout this manual, features and appearance may vary from your model.

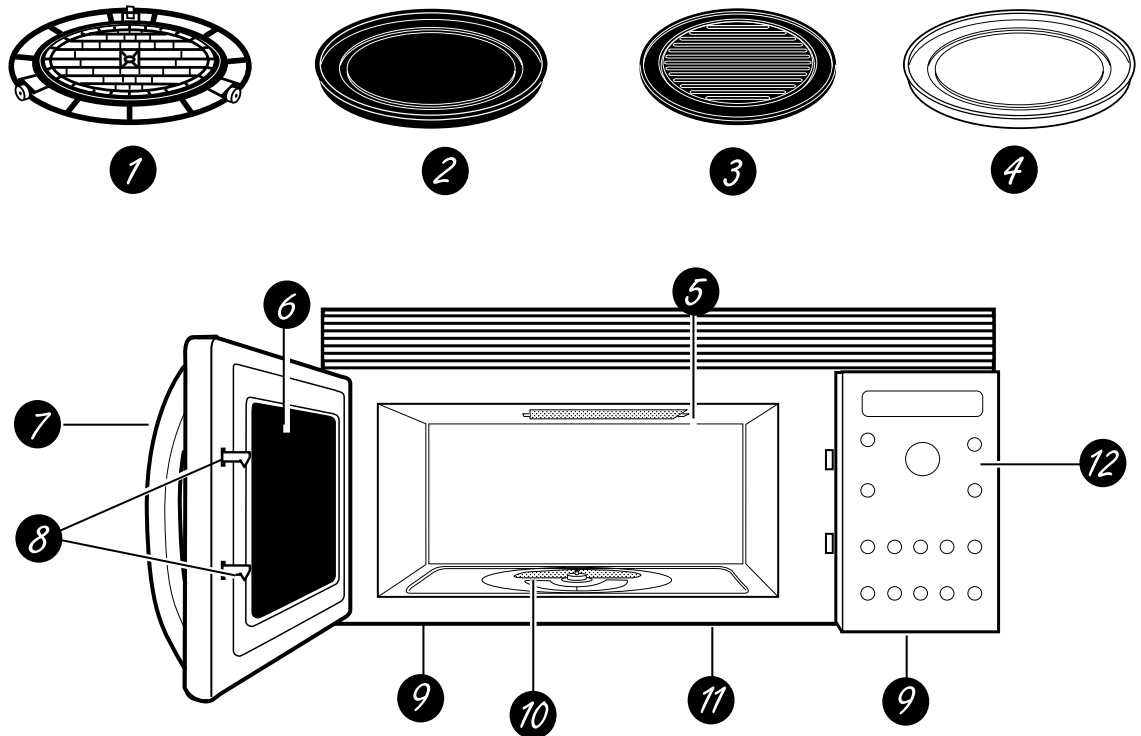

- 1** *Oven Rack (Turntable)*
The oven rack (turntable) must always be in place, on the oven floor, for all cooking. Be sure the oven rack (turntable) is seated securely over the square spindle in the center of the oven.
- 2** *Black Metal Tray/Baking Sheet*
Put food directly on the black metal tray and place on the oven rack (turntable) when using the speedcook features.
- 3** *Black Metal Grill Tray/Baking Sheet*
Put food directly on the black metal grill tray and place on the oven rack (turntable) when speedcooking foods you would normally cook on the grill.
- 4** *White Ceramic Tray*
Place on the oven rack (turntable) when using the microwave features. Place food or microwave-safe cookware directly on the tray.
- 5** *Upper Halogen Lamps*
Operate when using speedcook.
- 6** *Window*
Allows cooking to be viewed while keeping microwaves confined in the oven.
- 7** *Door Handle*
Pull to open the door. The door must be securely latched for the oven to operate.
- 8** *Door Latches*
- 9** *Vent Fan*
Press the VENT FAN button to remove steam and other vapors from surface cooking.
- 10** *Lower Halogen Lamp*
Operates when using speedcook.
- 11** *Cooktop Light*
Press the SURFACE LIGHT button to turn the cooktop light on and off.
- 12** *Control Panel*
The buttons used to operate the oven are located on the control panel.

Cooking controls

With your Advantium oven, you can cook with high-intensity halogen lights and/or conventional microwave energy.

SPEEDCOOK/REPEAT LAST

Press this button to access the pre-set speedcook menu. Press and hold for 3 seconds to repeat the last cooking selection.

MANUAL COOK/RECIPE

Press this button to set your own speedcook program.

SELECTOR DIAL—Turn to select, Press to enter
First turn then press the dial to make food selections. Also use the dial to increase (turn clockwise) or decrease (turn counterclockwise) cooking times.

START/PAUSE

Press this button to start or pause any cooking function.

CLEAR/OFF

Press this button to cancel **ALL** oven programs except the clock, timer and reminder.

POWER LEVEL

Press this button and turn/press the selector dial to change the speedcook upper lamps, lower lamp and microwave power level before and during cooking.

DELAY START

Press this button to set the oven to start automatically at a time you set.

TIMER

Press this button to set the minute timer.

MICROWAVE/OVEN LIGHT

Press this button to operate the microwave. Press while microwave cooking to light the oven cavity. The light will come on for several seconds.

MICRO EXPRESS

Press for 30 seconds of microwave cooking time. Each time the button is pressed adds an additional 30 seconds to the remaining cooking time. The oven starts immediately.

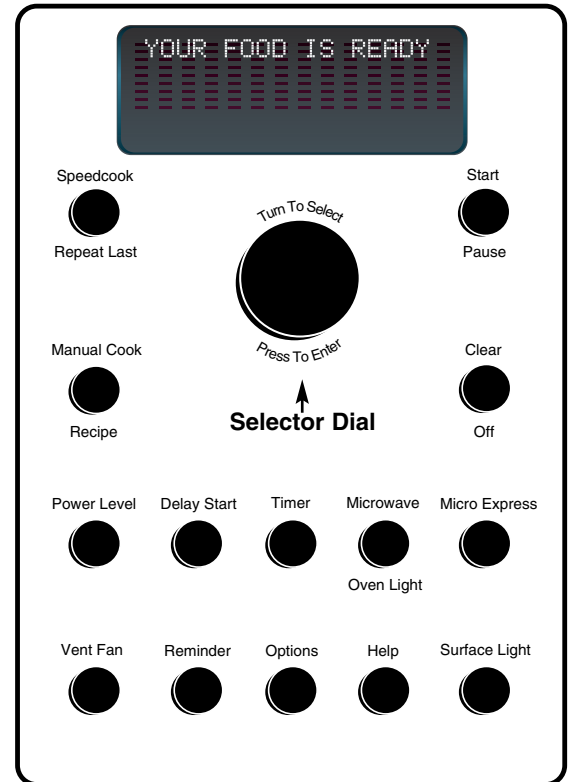

VENT FAN

Press this button to remove steam and other vapors from surface cooking.

REMINDER

Can be used like an alarm clock and can be used at any time, even when the oven is operating. It can be set to beep at a certain time, up to 24 hours later.

OPTIONS

Press this button to set the **Clock** and access the **Auto Night Light**, **Beeper Volume**, **Clock Display ON/OFF**, **Display Scroll Speed** features.

HELP

Press this button to find out more about your oven's features.

SURFACE LIGHT

Press this button to turn the cooktop light on and off.

Using speedcook features

CAUTION: When using speedcook programs, remember that the oven, door and dishes will be very hot!

Prior to the first use of your oven, the clock must be set. See the Advantium Quick Start section.

Before you begin, make sure the oven rack (turntable) is in place. Use the black metal tray (baking sheet), the black grill tray (baking sheet) or your own glass or ceramic cookware.

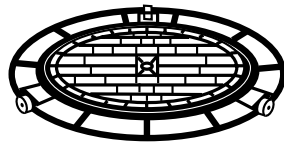

The oven rack (turntable) must always be in place when using the oven.

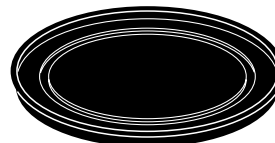

Put food directly on the black metal flat tray to speedcook.

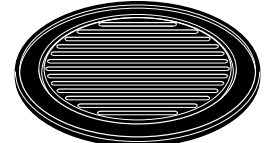

Put food directly on the black metal grill tray to speedcook foods you would normally cook on the grill.

SPEEDCOOK PRE-SET FOOD SELECTIONS:

- | | | | |
|-----------------------|------------------|------------|--------------|
| ■ Appetizers & Snacks | ■ Chicken | ■ Meats | ■ Recipe |
| ■ Breads | ■ Desserts | ■ Pizza | ■ Sandwiches |
| ■ Breakfast | ■ Fish & Seafood | ■ Potatoes | |

To use a pre-set speedcook menu

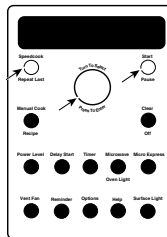

Advantium is already pre-set to cook over 100 popular dishes.

1. Press the speedcook button.
If no selection is made within 15 seconds, the display will revert back to the time of day.
2. Turn the selector dial to select the type of food category you want. Press the dial to enter.
3. Turn the selector dial to select the specific food (menu selection). Press the dial to enter.
4. Turn the selector dial to select amount, size, and/or doneness (if required, the oven will prompt you.) Press the dial after each selection.

5. Once the display shows: **ADJUST TIME OR START** either press start or the selector dial to start cooking.

*Turn the food over when the oven signals **TURN FOOD OVER** (for certain foods).*

*When the oven signals **CHECK for DONENESS**, check to see if your food is done to your liking (for certain foods).*

To review settings during cooking, press the selector dial.

*If you enter an undesired selection at any time, simply press the **CLEAR/OFF** button and re-enter the desired selections.*

- *Early in a speedcook program, you will see **OPTIMIZING COOK TIME** in the display. The oven automatically senses the electrical voltage level in your home and adjusts the cooking time up or down for proper cooking.*
- *If the door is opened during cooking, the oven will stop and **PAUSE** will appear in the display. Close the door and press the **START/PAUSE** button to resume cooking.*
- *At anytime during cooking you can turn the selector dial to change the*

*cooking time. You can change power levels by pressing **POWER LEVEL**.*

- *To assure consistent cooking results, the oven may adjust power levels downward if the oven is hot at the beginning of a program.*
- *At the end of cooking, the automatic fan will continue to run for a short time to cool internal components.*
- *To cook for additional time after a cooking cycle has been completed, use the resume feature.*

Cooking tips for great tasting results

To ensure consistent and even browning when cooking foods directly on the black metal tray, arrange food as shown below.

Foods can touch but should not overlap.

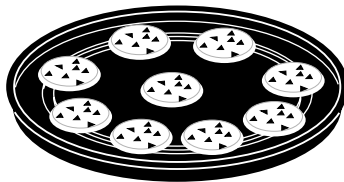

Circular pattern
(Example: biscuits, cookies)

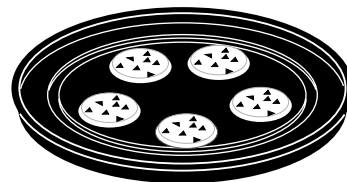

Circular pattern
(Example: biscuits, cookies, meats)

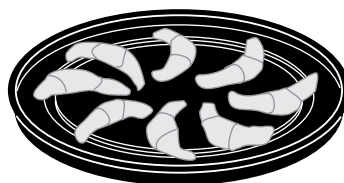

Spoke pattern
(Example: crescent rolls, breadsticks)

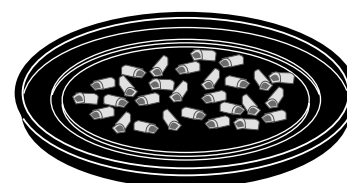

Single layer
(Example: appetizers)

Fresh meat, chicken, fish or seafood that has been frozen should be **thawed before cooking** (the microwave defrost feature can be used). For other frozen prepackaged foods, follow package directions.

Repeat last

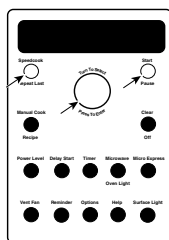

Use this time saving feature for cooking repetitive items like cookies or appetizers.

NOTE: The last program used is stored for two hours.

1. Press and hold the SPEEDCOOK/REPEAT LAST button for about 3 seconds.
2. The last pre-set food will be displayed.
3. Press the START/PAUSE button or the selector dial to start cooking.

Resume feature

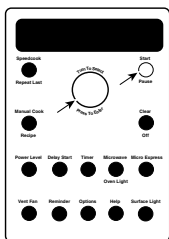

1. If your food needs to cook a bit longer, you can restart the oven by pressing the START button or selector dial.
2. **RESUME COOKING** will be displayed and the oven will restart immediately at 10% of the original time.

The program stays in memory for 10 minutes. After that you will need to begin the program again. See *To use a pre-set speedcook menu.*

Speedcook power level

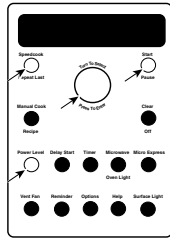

Advantium uses power from high intensity halogen lights and microwaves to cook food from the top, bottom and interior simultaneously to seal in moisture and flavor.

When using the pre-set menu foods, the power levels are already selected for you. However, power levels can be adjusted when cooking both pre-set menu foods and manual cooking.

Each power level gives you halogen lamp power and microwave energy for a certain percentage of the time.

U=07 Upper halogen lamp on **70%** of the time.

L=07 Lower halogen lamp on **70%** of the time.

M=05 Microwave on **50%** of the time.

NOTE: Be careful when adjusting power levels so that you do not over- or under-cook your food.

1. Press the SPEEDCOOK button and select your food (follow instructions from *To use a pre-set speedcook menu*).
2. When display shows *ADJUST TIME* or *START*, press the POWER LEVEL button.
3. Turn the dial clockwise to increase or counterclockwise to decrease the upper power level. Press the dial to enter.
4. Turn the dial to change the lower power level. Press the dial to enter.
5. Turn the dial to change the microwave power level. Press the dial to enter.
6. Press the START/PAUSE button or the selector dial to start cooking.

If you do not want to change one of the settings, just press the dial to move to the next selection.

Follow these general guidelines when selecting the best U=, L=, M= settings for your favorite recipes:

U = Select a higher setting for thin foods requiring a golden brown top (example: fish fillets, toast, boneless chicken breasts). Select a lower setting for thicker foods and foods with high sugar or fat content (example: cakes, roasts).

L = Select a higher setting for thick or dense foods that may not cook quickly in the center (example: casseroles). Select a lower setting for thin foods (example: cookies) and foods containing high fat or sugar content (example: pastry, cakes).

M = Select a higher setting to shorten cooking time for dense or heavy foods (example: casseroles, whole chicken). Select a lower setting for delicate foods (example: cakes, breads, souffles) or foods requiring longer cook times for tender results (example: stew, pot roast).

Speedcook cookware

- Follow cookware suggestions on the oven display or in the Cookbook or Cooking guide.
- Cookware will become hot because of heat transferred from the heated food. Oven mitts will be needed to handle the cookware.
- Place food directly on the black trays when cooking.
- Use the black metal flat tray in the same way you would use a shallow baking pan or baking tray.
- Use the black grill tray for cooking steaks, fish and poultry.
- In addition to the cookware provided, you can use non-metal casserole dishes, pie plates and other heat-safe cookware. Place them directly on the oven rack (turntable).

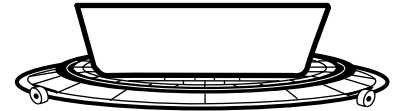

- Be sure to select a size that will rotate easily.
- Place the black metal tray, glass, or ceramic cookware directly on the oven rack (turntable).
- Do not use cookware or coverings made of paper, plastic, or foil when cooking during a speedcook cycle.

Manual speedcook

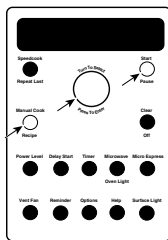

Advantium gives you the flexibility to cook your favorite dishes.

If you want to cook a food item that is not among the pre-set selections, use manual speedcook.

1. Press the MANUAL COOK/RECIPE button.

If no entries are made within 15 seconds, the display will revert back to the time of day.

2. Turn the selector dial to select the cooking time. Press the dial to enter.

The display will prompt you to select UPPER POWER, LOWER POWER, and MICROWAVE POWER.

3. Turn the dial clockwise to increase or counterclockwise to decrease the upper power level. Press the dial to enter.

4. Turn the dial to change the lower power level. Press the dial to enter.
5. Turn the dial to change the microwave power level. Press the dial to enter.
6. Press the START/PAUSE button or press the selector dial to start cooking.

For power level and cooking time suggestions, use your cooking guide or cook book.

Speedcook recipe—to enter and save

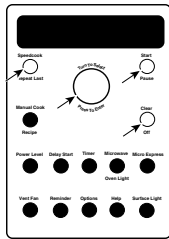

Create up to 30 of your own Speedcook recipes, or customize an existing custom recipe to suit your tastes. Once it's done, your food cooks just the way you want it every time!

1. Press the SPEEDCOOK button.
2. Turn the dial until *RECIPE* appears. Press the dial to enter.
3. Turn the dial until *CUSTOM #:* *EMPTY* appears. Press the dial to enter.
4. *ENTER COOK TIME* appears. Turn the dial to select the cooking time. Press the dial to enter.

The display will prompt you to select UPPER POWER, LOWER POWER and MICROWAVE POWER.

5. Turn the dial clockwise to increase or counterclockwise to decrease the upper power level. Press the dial to enter.

6. Turn the dial to change the lower power level. Press the dial to enter.
7. Turn the dial to change the microwave power level. Press the dial to enter.
8. *CATEGORY* appears. Turn the dial to select one of 30 categories that best describes this new Speedcook program. Press the dial to enter.
9. *Recipe Added. Press START to Run* appears. To begin cooking press the START/PAUSE button. To store the recipe without cooking, press the CLEAR/OFF button.

For power level and cooking time suggestions, use your cooking guide or cook book.

Speedcook recipe—to find and use

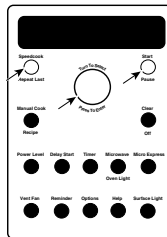

To find and use stored custom speedcook recipes:

1. Press the SPEEDCOOK button.
2. Turn dial to *RECIPE* and press to enter.
3. *CUSTOM#:* and the categories you entered will appear.

4. Turn dial until the recipe you want is displayed and press the dial to enter.
5. Press the START/PAUSE button or press the selector dial to start cooking.

Speedcook recipe—to adjust or change

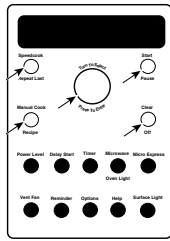

To adjust or change stored custom speedcook recipes:

1. Press the SPEEDCOOK button.
2. Turn the dial until *RECIPE* appears. Press the dial to enter.
3. Turn the dial to the recipe you want to change. Press the dial to enter. *ADJUST TIME* or *START* appears.
4. Press the MANUAL COOK/RECIPE button.
5. The display will prompt you to *ADJUST COOK TIME*, then select *UPPER POWER*, *LOWER POWER*, *MICROWAVE POWER*, and *CATEGORY*. Turn the dial and press to enter the appropriate settings.

(For more detailed instructions, follow steps 4 through 8 in the section *Speedcook recipe—to enter and save*.)

6. *Recipe Added*. Press *START* to Run appears. To begin cooking press the *START/PAUSE* button. To store the recipe without cooking, press the *CLEAR/OFF* button.

For power level and cooking time suggestions, use your cooking guide or cook book.

Speedcook recipe—to delete

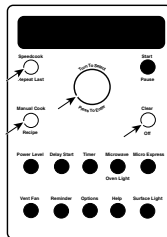

To delete stored custom speedcook recipes:

1. Press the SPEEDCOOK button.
2. Turn the dial until *RECIPE* appears and press the dial to enter.
3. Turn dial to the recipe you want to delete and press the dial to enter.

4. *ADJUST TIME* or *START* appears. Press and hold the MANUAL COOK/RECIPE button for 3 seconds. This deletes the recipe. You may now enter and save a new recipe or press *CLEAR/OFF* to return to the clock display.

Speedcooking

Advantium Oven

*Custom
speedcook
recipes*

Custom Recipe Number/Name	Cook Time	Power Level			Category	Comments
		U	L	M		
1.						
2.						
3.						
4.						
5.						
6.						
7.						
8.						
9.						
10.						
11.						
12.						
13.						
14.						
15.						
16.						
17.						
18.						
19.						
20.						
21.						
22.						
23.						
24.						
25.						
26.						
27.						
28.						
29.						
30.						

Things that are normal

Cooking Times

- When speedcooking preprogrammed foods, you may see *OPTIMIZING COOK TIME* in the display several seconds after you press **START**. The oven automatically senses the electrical voltage level in your home and adjusts the cooking time up or down for proper cooking.

Fan/Vent

- The fan will be on during cooking. At the end of cooking, the automatic fan will continue to run for a short time, and the display will read *Oven is Cooling*. The fan will automatically shut off when the internal parts of the oven have cooled.
- The exhaust fan may come on automatically if the cooktop is in use.
- The oven vent will emit warm air while the oven is on.

Lights

- When the oven is on, light may be visible around the door or outer case.
- The halogen lights will dim and cycle on and off during a speedcook cycle, sometimes even at full power levels. This is normal. The oven senses the heat level and adjusts automatically.

Oven Heat

- No preheating time is required. The oven begins cooking immediately.
- The door and inside of the oven will be very hot. Use caution when opening the door and removing food.
- Do not use cookware or coverings made of paper, plastic, or foil when cooking during a speedcook cycle.
- When cooking for an extended period of time, the oven may automatically reduce the power levels to maintain the appropriate level of oven heat.

Sounds

- Clicks and a fan blowing are normal sounds during cooking. The relay board is turning components on and off.

Using the microwave features

Make sure the oven rack (turntable) and white ceramic tray are in place. Place food or microwavable container directly on the white ceramic tray to cook your food.

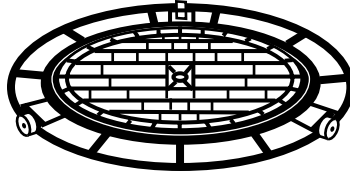

The oven rack (turntable) must always be in place when using the oven.

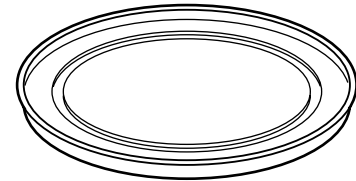

The white ceramic tray should always be in place when microwaving.

Cookware

- Make sure that cookware is suitable for microwaving.
- Place food or microwavable container directly on the white ceramic tray to cook your food.

MICROWAVE PRE-SET FOOD SELECTIONS:

- | | | |
|---------------------------|------------------------|--------------------------------------|
| ■ Bacon | ■ Popcorn | ■ Soup |
| ■ Beverage | ■ Recipe | ■ Time cook |
| ■ Defrost (Auto and Time) | ■ Reheat (one serving) | ■ Vegetables (fresh, frozen, canned) |

How to use pre-set microwave selections

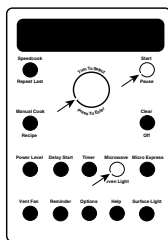

1. Press the MICROWAVE/OVEN LIGHT button.

If no selection is made within 15 seconds, the display will revert back to the time of day.

2. Turn the dial to find the food you want to cook. Press the dial to enter.
3. Turn the selector dial to select amount, weight or size. (If required, the oven will prompt you). Press the dial after each selection.
4. Press the dial or the START/PAUSE button to start cooking.

To review settings during cooking, press the selector dial.

If the door is opened during cooking, the oven will stop and PAUSE will appear in the display. Close the door and press START/ PAUSE to resume cooking.

NOTE: There is no light that automatically comes on during microwaving.

To see the food that is cooking, press MICROWAVE/OVEN LIGHT. One halogen lamp will come on for about 5 seconds.

If you enter an undesired selection at any time, simply press the CLEAR/OFF button and re-enter the desired selections.

Time Cook

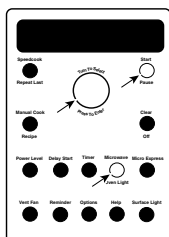

Use Time Cook to microwave food that is not in the recipe section.

■ The power level is automatically set at high, but you can change it for more flexibility.

1. Press the MICROWAVE button.
2. Turn the dial to TIME COOK and press the dial to enter.
3. Turn the dial to set the time and press the dial to enter.

4. To change the power level if you don't want full power, press the POWER LEVEL button. Turn the dial to select. Press the dial to enter.

5. Press the dial or the START/PAUSE button to start cooking.

You may open the door during TIME COOK to check the food. Close the door and press START to resume cooking.

Micro Express

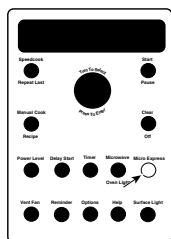

Press MICRO EXPRESS repeatedly for 30 second increments of microwave cooking time. Oven starts immediately.

Microwave power level

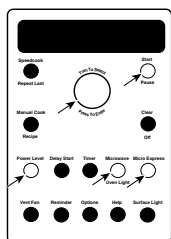

1. First, follow directions for TIME COOK, TIME DEFROST or MICRO EXPRESS.

2. Press the POWER LEVEL button.
3. Turn the dial clockwise to increase and counterclockwise to decrease the power level. Press the dial to enter.

4. Press the dial or the START/PAUSE button to start cooking.

■ *You can change the power level before or during a cooking program (except when using MICRO EXPRESS).*

Here are some examples of uses for various power levels:

High 10: Fish, bacon, vegetables, boiling liquids.

Med-High 7: Gentle cooking of meat and poultry; baking casseroles and reheating.

Medium 5: Slow cooking and tenderizing for stews and less tender cuts of meat.

Low 2 or 3: Defrosting; simmering; delicate sauces.

Warm 1: Keeping food warm; softening butter.

Cooking tips

■ When cooking bacon, layer strips on a plate. Cover each layer with a paper towel.

■ When cooking vegetables, use a microwave-safe casserole or bowl. Cover with a lid or vented plastic wrap.

■ For frozen vegetables, follow the package instructions for adding water.

■ For fresh vegetables, add 2 tablespoons of water for each serving.

Microwave recipe—to enter and save

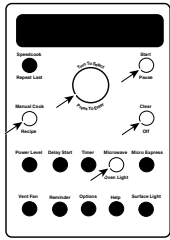

Create and store up to 10 of your own microwave recipes.

1. Press the MICROWAVE/OVEN LIGHT button.
2. Turn dial until *RECIPE* appears. Press the dial to enter.
3. Turn dial until *CUSTOM#:EMPTY* appears. Press the dial to enter.
4. *ENTER COOK TIME* appears. Turn the dial to select the cooking time you want. Press the dial to enter.
5. Select *POWER LEVEL*. Turn the dial and press the dial to enter.
6. *CATEGORY* appears. Turn the dial to select a category that best describes your desired microwave program.
7. *Recipe Added. Press START to Run* appears. To begin cooking, press the START/ PAUSE button or press the CLEAR/OFF button to store the recipe without cooking.

Microwave recipe—to find and use

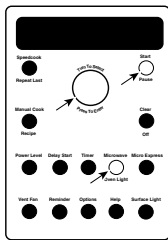

To find and use stored custom microwave recipes:

1. Press the MICROWAVE/OVEN LIGHT button.
2. Turn dial to *RECIPE* and press the dial to enter.
3. *CUSTOM#:* and the categories you entered will appear.
4. Turn dial to your recipe and press the dial to enter.
5. Press the START/PAUSE button or the selector dial to start cooking.

Custom microwave recipes

Custom Recipe Number/Name	Cook Time	Power Level Microwave	Category	Comments
1.	_____	_____	_____	_____
2.	_____	_____	_____	_____
3.	_____	_____	_____	_____
4.	_____	_____	_____	_____
5.	_____	_____	_____	_____
6.	_____	_____	_____	_____
7.	_____	_____	_____	_____
8.	_____	_____	_____	_____
9.	_____	_____	_____	_____
10.	_____	_____	_____	_____

Microwave recipe—to adjust or change

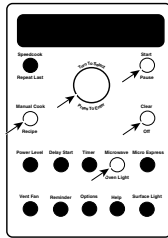

To adjust or change stored custom microwave recipes:

1. Press the MICROWAVE/OVEN LIGHT button.
2. Turn dial to *RECIPE* and press the dial to enter.
3. Turn the dial to the recipe you want to change. Press the dial to enter.
4. *ADJUST TIME* or *START* appears.
5. Press the MANUAL COOK/RECIPE button. Turn the dial to select the cook time and press the dial to enter.
6. Turn the dial to select the *POWER LEVEL* and press the dial to enter.
7. *Recipe Added*. Press *START* to Run appears. To begin cooking, press the START/PAUSE button or press the CLEAR/OFF button to store the recipe without cooking.

Microwave recipe—to delete

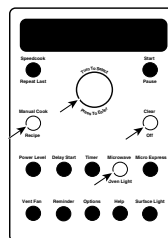

To delete stored custom microwave recipes:

1. Press the MICROWAVE/OVEN LIGHT button.
2. Turn dial to *RECIPE* and press the dial to enter.
3. Turn the dial to the recipe you want to delete. Press the dial to enter.
4. *ADJUST TIME OR START* appears. When prompted to press the START button, press and hold the MANUAL COOK/RECIPE button for 3 seconds. You may now enter and save a new recipe or press CLEAR/OFF to return to the clock display.

Auto defrost

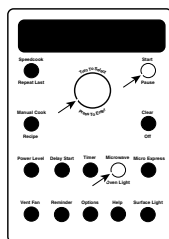

Auto Defrost automatically sets the defrosting times and power levels to give even defrosting results for meats, poultry and fish weighing up to 6 pounds.

1. Remove food from the package and place it on a microwave-safe dish.
2. Press the MICROWAVE / OVEN LIGHT button.
3. Turn the dial to *DEFROST (AUTO)*. Press the dial to enter.
4. Turn the dial to the food weight, using the Conversion Guide at right. For example, dial 1.2 for 1.2 pounds (1 pound, 3 oz.) Press the dial to enter.
5. Press the dial or START/PAUSE button to start defrosting.
6. Turn the food over when the oven signals *TURN FOOD OVER*.

- Remove defrosted meat or shield warm areas with small pieces of foil for even defrosting.
- After defrosting, most meats need to stand 5 minutes to complete defrosting. Large roasts should stand for about 30 minutes.

Conversion Guide

If the weight of food is stated in pounds and ounces, the ounces must be converted to tenths (.1) of a pound.

Weight of Food in Ounces	Enter Food Weight (tenths of a pound)
1-2	.1
3	.2
4-5	.3
6-7	.4
8	.5
9-10	.6
11	.7
12-13	.8
14-15	.9

Time defrost

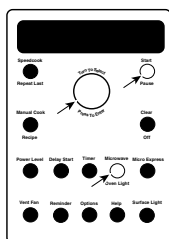

Use Time Defrost to defrost for a selected length of time.

1. Press the MICROWAVE / OVEN LIGHT button.
2. Turn the selector dial to *DEFROST (TIME)*. Press the dial to enter.
3. Turn the dial to select the time you want. Press the dial to enter.
4. Press the dial or START/PAUSE button to start defrosting.
5. Turn the food over when the oven signals *TURN FOOD OVER*.

Power level is automatically set at 3, but can be changed. To change the power levels, see the Microwave Power Level section. You can defrost small items quickly by raising the power level after entering the time. Power level 7 cuts the total defrosting time in about half; power level 10 cuts the total time to about 1/3. When defrosting at high power levels, food will need more frequent attention than usual.

Defrosting tips

Use AUTO DEFROST for meat, poultry and fish. Use TIME DEFROST for most other frozen foods.

- Foods frozen in paper or plastic can be time defrosted in the package, but foods should be taken out of the package when using *DEFROST (AUTO)*. Closed packages should be slit, pierced or vented **after** food has partially defrosted. Plastic storage containers should be partially uncovered.
- Family-size, prepackaged frozen dinners can be defrosted and microwaved. If the food is in a foil container, transfer it to a microwave-safe dish.
- Foods that spoil easily should not be allowed to sit out for more than one hour after defrosting. Room temperature promotes the growth of harmful bacteria.
- For more even defrosting of larger foods, such as roasts, use *DEFROST (AUTO)*. Be sure large meats are completely defrosted before cooking.
- When defrosted, food should be cool but softened in all areas. If still slightly icy, return to the microwave very briefly, or let it stand a few minutes.

Microwave sensor cooking

The sensor feature detects the increasing humidity released during cooking. The oven automatically adjusts the cooking time to various types and amounts of food.

Do not use the Sensor Features twice in succession on the same food portion—it may result in severely overcooked or burnt food. If food is undercooked after the first countdown, use *TIME COOK* for additional cooking time.

The proper containers and covers are essential for best sensor cooking.

- Always use microwave-safe containers and cover them with lids or vented plastic wrap. Never use tight sealing plastic containers—they can prevent steam from escaping and cause food to overcook.
- Be sure the outside of the cooking containers and the inside of the oven are dry before placing food in the oven. Beads of moisture turning into steam can mislead the sensor.
- Beverages are best heated uncovered.

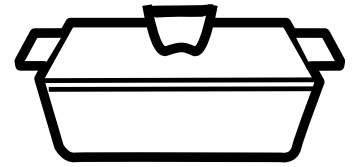

Covered

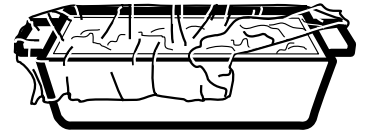

Vented

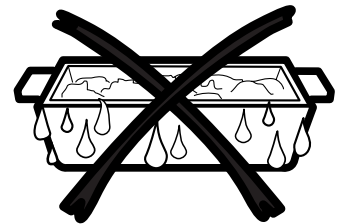

Dry off dishes so they don't mislead the sensor.

MICROWAVE SENSOR PROGRAMS:

- **Beverage**
- **Popcorn** – Prepackaged microwave popcorn, 1.5 oz. to 3.5 oz.
- **Reheat** – Single servings (4 to 6 oz.) of leftovers.
- **Soup**

*To use all
sensor
programs*

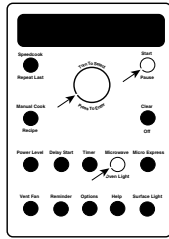

Advantium's microwave mode features sensor cooking. The oven automatically senses when food is done and shuts itself off—eliminating the need to program cooktimes and power levels.

1. Press the MICROWAVE button.
2. Turn the dial to select the food you want. Press the dial to enter.
3. Press the dial or press the START/PAUSE button to start cooking.

Do not open the oven door until time is counting down in the display. If the door is opened, close it and press START/PAUSE immediately. If the food is not done enough, use *TIME COOK* in the microwave selector to cook for more time.

NOTE: Do not use the Sensor Features twice in succession on the same food portion—it may result in severely overcooked or burnt food.

- If you have been speedcooking and the oven is already hot, it may indicate that it is too hot for sensor cooking. Of course, you can always continue with *TIME COOK* or *SPEEDCOOK*.
- To shorten or lengthen the cook time, wait until the time countdown shows in the display. Then turn the dial to add or subtract time.
- Drinks heated with the *BEVERAGE* feature may be very hot. Remove the container with care.

- If you open the door while *SENSOR Cooking*, *SENSOR ERROR* will appear. Close the door, press *START* to begin again.

Notes about the Reheat program:

Reheated foods may have wide variations in temperature. Some areas may be extremely hot.

It is best to use *TIME COOK* and not *REHEAT* for these foods:

- Bread products
- Food that must be reheated uncovered.
- Foods that need to be stirred or turned.
- Foods calling for a dry look or crisp surface after reheating.

*Things that
are normal*

Interference

- TV/radio interference might be noticed while using the microwave. Similar to the interference caused by other small appliances, it does not indicate a problem with the microwave. Move the radio or TV as far away from the microwave as possible, or check the position of the TV/radio antenna.

Lights

- The oven light will not come on during a microwave cooking cycle. For about 5 seconds of light, press the MICROWAVE/OVEN LIGHT pad. The oven light will come on automatically when the door is opened.

Oven Heat

- Cookware may become hot because of heat transferred from the heated food. Oven mitts may be needed to handle the cookware.
- Steam or vapor may escape from around the door.

Sounds

- You may hear a dull thumping sound while the oven is operating.

“YOUR FOOD IS READY”

To remind you that you have food in the oven, the oven will display *YOUR FOOD IS READY* and beep once a minute until you either open the oven door or press the CLEAR/OFF button.



Features under the OPTIONS button

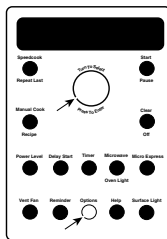

Clock:

The clock must be set before you can use your oven for the first time (see *Quick Start* for instructions).

1. To change the clock time, press the OPTIONS pad and turn the dial to *CLOCK*. Press the dial to enter.
2. Turn the dial to set hours. Press the dial to enter.
3. Turn the dial to set minutes. Press the dial to enter.
4. Turn the dial to select AM or PM. Press the dial to enter.

Clock Display ON/OFF:

Use this feature to turn your clock display on or off. Press the OPTIONS button, turn the dial to select *CLOCK DISPLAY ON/OFF*. Turn the dial to select *ON* or *OFF*. Press the dial to enter.

Auto Night Light:

Use this feature to program the on-off time for an automatic night light. Press the OPTIONS button, turn the dial to select *AUTO NIGHT LIGHT*, press the dial to enter, and follow the display directions.

Beeper Volume:

Use this feature to adjust the volume of the beeper. You can even turn it off. Press the OPTIONS button, turn the dial to select *BEEPER VOLUME*, press the dial to enter, and follow the display directions.

Scroll Speed:

Is the message scroll too slow or too fast? Change it! Press the OPTIONS button, turn the dial to select *DISPLAY SCROLL SPEED*, press the dial to enter, and follow the display directions.

Review

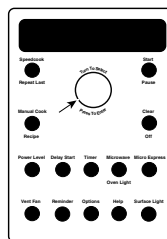

Use this feature to review the current cooking selections you have set.

Press the selector dial during speedcooking or microwave cooking.

Help

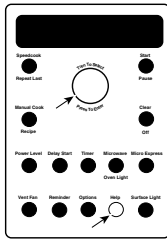

Use this feature to find out more about your oven and its features.

1. Press the HELP button.
2. Turn the dial to select the feature name. Press the dial to enter.

The display will show a description for the program you have chosen.

Features found in the HELP function.

Adjust
Auto Night Light
Bacon
Beeper Volume
Beverage
Child Lockout
Clear/Off
Clock
Clock Display On/Off
Defrost (Auto)
Defrost (Time)
Delayed Start
Help
Manual Speedcook
Microwave Cooking
Microwave Express
Options
Oven Light
Popcorn

Power Level
Recipe
Reheat—One Serving
Reminder
Repeat Last
Resume
Review
Scroll Speed
Soup
Start/Pause
Speedcook
Surface Light
Time Cook
Timer On/Off
Vegetables (Canned)
Vegetables (Fresh)
Vegetables (Frozen)
Vent Fan

Child lock-out

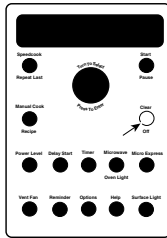

You may lock the control panel to prevent the oven from being accidentally started or used by children.

Press and hold CLEAR/OFF for about 3 seconds to lock and unlock.

When the control panel is locked, **CONTROL IS LOCKED** will be displayed briefly anytime a button or dial is pressed.

Surface light

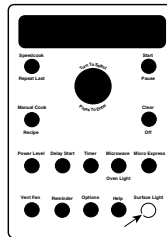

Use to light your cooktop.

Press the SURFACE LIGHT button to select the proper setting.

Continue pressing to change from bright to nightlight to off.

Vent fan

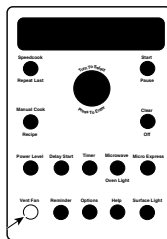

The vent fan removes steam and other vapors from surface cooking.

Press the VENT FAN button to select the fan speed.

Continue pressing to change from high to low to off.

Timer

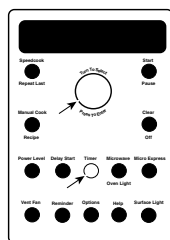

Use this feature anytime you need a general purpose timer. It can even be used while cooking in the oven.

1. Press the TIMER button.
2. Turn the dial to select the minutes. Press the dial to enter.

3. Turn the dial to select the seconds. Press the dial to enter.

To pause, press TIMER. To restart, press TIMER again.

To cancel, press and hold the TIMER button down for about 3 seconds.

Reminder

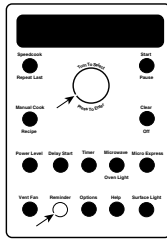

Use this feature like an alarm clock to help you keep up with things to do.

1. Press the REMINDER button and select reminder time. Follow the directions in the display:
 - A. Turn the dial to set hours. Press the dial to enter.
 - B. Turn the dial to set minutes. Press the dial to enter.
 - C. Turn the dial to select AM or PM. Press the dial to enter.

To cancel, press and hold the REMINDER button for about 3 seconds.

Delay start

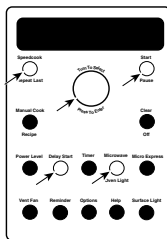

DELAY START allows you to set the oven to delay cooking up to 24 hours.

1. Press the DELAY START button.
2. Turn the dial to select start time and press the dial to enter. Follow the directions in the display.
 - A. Turn the dial to set hours. Press the dial to enter.
 - B. Turn the dial to set minutes. Press the dial to enter.
 - C. Turn the dial to select AM or PM. Press the dial to enter.

3. When prompted, press the SPEEDCOOK/REPEAT LAST or MICROWAVE button and enter a cooking program. See the *Speedcooking* or *Microwaving* sections for instructions.
4. Press the dial or press the START/PAUSE button.

The DELAY START time will be displayed. The oven will automatically start the cooking program at the delayed time.

NOTE: You cannot use DELAY START with the BEVERAGE, POPCORN, REHEAT or SOUP program.

Automatic fan

An automatic fan feature protects the oven from too much heat rising from the cooktop below it and from too much heat inside the oven cavity.

It automatically turns on at low speed if it senses too much heat.

If you have turned the fan on you may find that you cannot turn it off. The fan will automatically turn off when the internal parts are cool. It may stay on for 30 minutes or more after the cooktop and oven controls are turned off.

Helpful hints

An occasional thorough wiping with a solution of baking soda and water keeps the inside fresh.

Be certain the oven control is turned off before cleaning any part of this oven.



How to clean the inside

Clean the inside of the oven after each use for proper heating performance.

Some spatters can be removed with a paper towel, others may require a warm soapy cloth. Remove greasy spatters with a sudsy cloth, then rinse with a damp cloth.

Do not use abrasive cleaners or sharp utensils on oven walls.

Never use a commercial oven cleaner on any part of your oven.

Do not clean the inside of the oven with metal scouring pads. Pieces can break off the pad, causing electrical shock.

Do not remove the halogen lamp glass covers.

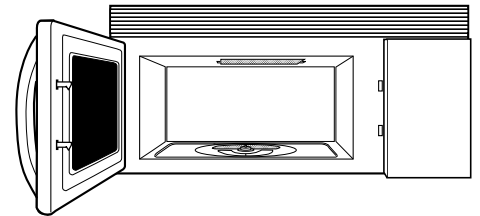

Walls, Floor, Inside Window, Metal and Plastic Parts on the Door

Removable oven rack (turntable)

The area underneath the oven rack (turntable) should be cleaned frequently to avoid odors and smoking during a cooking cycle.

The oven rack (turntable) can be broken if dropped. Wash carefully in warm, sudsy water. Dry completely and replace.

To replace the oven rack (turntable), place its center over the square spindle in the center of the oven and turn it until it seats into place.

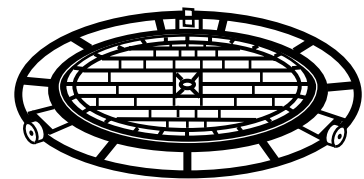

Oven Rack (Turntable)

Do not use the oven without the oven rack (turntable) in place.

Baking sheets (cooking trays)

To prevent breakage, allow the trays to cool completely before cleaning. Wash carefully in warm, sudsy water or in the dishwasher.

Do not use metal scouring pads or abrasives, as they may damage the finish.

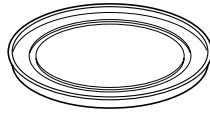

White ceramic tray for microwaving

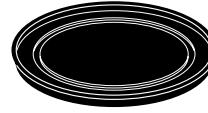

Black metal tray for speedcooking



Metal grill tray for speedcooking

Halogen lamp covers

Both the upper and lower halogen lamp covers **must** be kept free of grease and food splatterings in order to operate effectively.

Clean the lamp glass covers often to avoid excess smoking and decreased cooking power.

Do not remove the halogen lamp glass covers.

To clean the upper and lower lamp covers: Allow the oven rack (turntable) and glass covers to cool completely. Remove the oven rack (turntable) and wipe clean with a warm soapy cloth or plastic scrubbie. Replace the oven rack (turntable).

For heavy burned on soil, a cleaning scraper may be used to clean the halogen lamp covers. Wearing an oven mitt, hold the cleaning scraper at a 30° angle. Scrape the glass clean and wipe up excess soil.

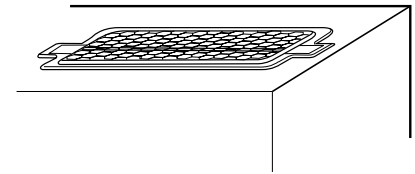

Upper halogen lamp cover

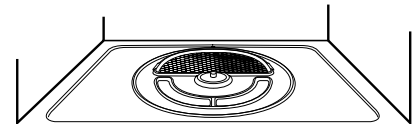

*Lower halogen lamp cover
(with turntable removed)*

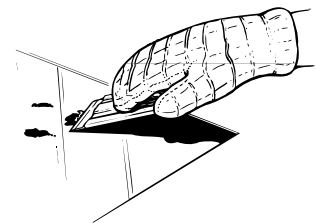

For heavy or burned on soil

How to clean the outside

We recommend against using cleaners with ammonia or alcohol, as they can damage the appearance of the microwave oven. If you choose to use a common household cleaner, first apply the cleaner directly to a clean cloth, then wipe the soiled area.

Case

Clean the outside with a sudsy cloth. Rinse and then dry. Wipe the window clean with a damp cloth.

Glass Control Panel and Door (on some models)

Wipe with a clean damp sponge. Dry thoroughly. Do not use cleaning sprays, large amounts of soap and water, abrasives or sharp objects on the panel—they can damage it.

Stainless Steel Control Panel and Door (on some models)

Do not use a steel wool pad; it will scratch the surface.

Clean with hot soapy water. Rinse and dry.

After cleaning, use a stainless steel polish such as Stainless Steel Magic[®], Revere Copper and Stainless Steel Cleaner[®], or Wenol All Purpose Metal Polish[®]. Follow the product instructions for cleaning the stainless steel surface.

Bottom

Clean off the grease and dust on the bottom often. Use a solution of warm water and detergent.

Vent Grill

Use warm soapy water and a dishcloth to wipe off the grill. Use cotton swabs to get in between the grill louvers.

Door Frame

It's important to keep the area clean where the door seals against the oven. Use only mild, non-abrasive detergents applied with a clean sponge or soft cloth. Rinse well.

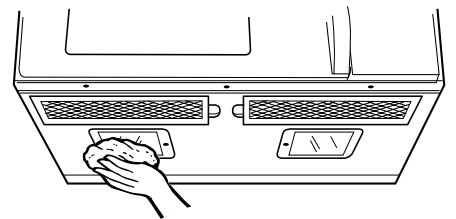
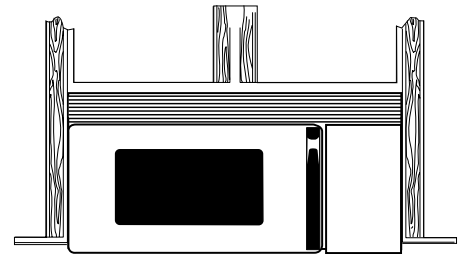

The vent fan

The vent fan has 2 metal reusable vent filters.

Models that recirculate air back into the room also use a charcoal filter.

Charcoal Filter (on some models)

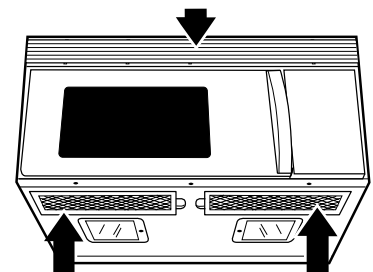

Reusable Vent Filters (on all models)

Cooktop light/ night light

1. To replace the cooktop light/
night light, first disconnect the
power at the main fuse or circuit
breaker panel.
2. Remove the screws from the
side of the light compartment
cover and lower the cover until
it stops.
3. Be sure the bulb(s) to be replaced
are cool before removing. Break
the adhesive seal by gently
unscrewing the bulb(s).

*Replace with 40-watt (max.) incandescent
bulbs. Order WB02X4253 from your GE
supplier. High-intensity 40-watt bulbs
(40S11N/1), available in supermarkets
and hardware stores, may also be used for
replacements.*

4. Raise the light cover and replace
the screws. Connect electrical
power to the oven.

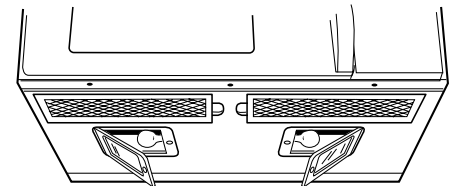
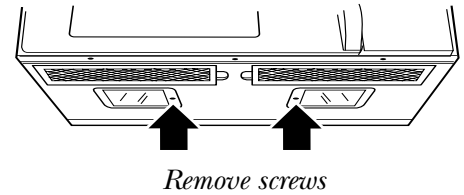

Reusable vent filters

The metal filters trap grease released
by foods on the cooktop. They also
prevent flames from foods on the
cooktop from damaging the inside
of the oven.

For this reason, the filters must
always be in place when the hood
is used. The vent filters should be
cleaned once a month, or as needed.

Removing and cleaning the filters

To remove, slide them to the side
using the tabs. Pull down and out.

To clean the vent filters, soak them
and then swish around in hot water
and detergent. Don't use ammonia
or ammonia products because
they will darken the metal. Light
brushing can be used to remove
embedded dirt.

Rinse, shake and let dry before
replacing.

To replace, slide the filters into
the frame slots on the side of each
opening. Press up and to the side
to lock into place.

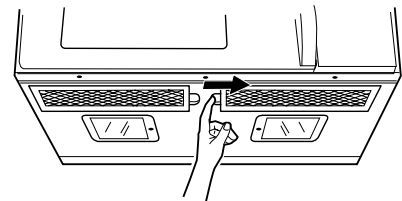

Charcoal filter (JX81A)

*The charcoal filter cannot be cleaned. It must be replaced. Order Part No. **WB02X9883** from your GE supplier.*

If the model is not vented to the outside, the air will be recirculated through a disposable charcoal filter that helps remove smoke and odors.

The charcoal filter should be replaced when it is noticeably dirty or discolored (usually after 6–12 months, depending on usage).

To remove the charcoal filter

To remove the charcoal filter, **first disconnect power at the main fuse.**

Remove the top grille by removing the 2 screws that hold it in place.

You may need to open the cabinet doors to remove the screws.

Slide the filter towards the front of the oven and remove it.

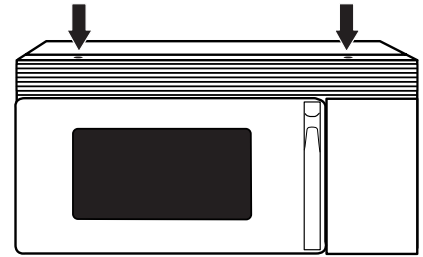

*Remove 2 grille screws to
remove the grille.*

To install the charcoal filter

To install a new filter, remove plastic and other outer wrapping from the new filter.

Insert the filter into the top opening of the oven as shown. It will rest at an angle on 2 side support tabs and in front of the right rear tab. Replace the grille and 2 screws. Reconnect power at the main fuse.

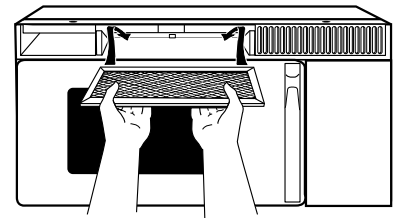

Optional kits

Available at extra cost from your GE supplier.

Filler Panel Kits

- *JX40AL—Almond*
- *JX40CT—Bisque*
- *JX40WH—White*
- *JX41—Black*

When replacing a 36" range hood, filler panel kits fill in the additional width to provide a custom built-in appearance.

For installation between cabinets only; not for end-of-cabinet installation. Each kit contains two 3" wide filler panels.

Filter Kits

- *JX81A—Recirculating Charcoal Filter Kit*

Filter kits are used when the oven cannot be vented to the outside.

*Questions?
Use this
problem
solver*

Problem	Possible Causes	What To Do/Explanation
LIGHTS		
There is no oven light on during microwave cooking	This is normal. The glass is too dark for a microwave light.	<ul style="list-style-type: none"> • Press MICROWAVE/OVEN LIGHT button to light the oven for several seconds.
Light during a speedcook cycle dims and cycles on and off, even at full power levels	This is normal. Power level has been automatically reduced because the oven is hot.	<ul style="list-style-type: none"> • This is normal. The oven senses the heat level and adjusts automatically.
Light visible around the door and outer case while speedcooking	This is normal.	<ul style="list-style-type: none"> • When the oven is on, light may be visible around the door and outer case.
FAN		
Fan continues to run after cooking stops	The oven is cooling.	<ul style="list-style-type: none"> • The fan will automatically shut off when the internal parts of the oven have cooled.
Oven vent emits warm air while oven is on	This is normal.	
Fan comes on automatically when oven not in use	This is normal.	<ul style="list-style-type: none"> • If the cooktop gets too hot, the vent fan comes on.
Fan comes on automatically when using the microwave	This is normal.	<ul style="list-style-type: none"> • If the microwave is used after speedcook and the oven senses that it is too hot, the vent fan comes on to cool the oven.
COOKING		
The oven makes unusual sounds while cooking	Clicks and fans blowing are normal. The relay board is turning the components on and off.	<ul style="list-style-type: none"> • These sounds are normal.
Smoke comes out of the oven when I open the door	Food is high in fat content. Aerosol spray used on the pans.	<ul style="list-style-type: none"> • Smoke is normal when cooking high-fat foods. Use vegetable oil or olive oil on the meat itself instead of coating the entire pan.
Food is not fully cooked or browned at the end of a cooking program	Programmed times may not match the size or amount of food you are cooking.	<ul style="list-style-type: none"> • Increase or decrease time for doneness or adjust the upper or lower lamps for browning; change the microwave power for doneness.
	There may be grease build-up on the glass covers.	<ul style="list-style-type: none"> • Clean the light covers with a scraper.

Questions?
Use this
problem
solver

Problem	Possible Causes	What To Do/Explanation
DISPLAY		
The display is blank	The clock display has been turned off.	<ul style="list-style-type: none"> • Check the OPTIONS menu for clock display settings. Turn the display on.
“CONTROL IS LOCKED” appears in display	The control has been locked.	<ul style="list-style-type: none"> • Press and hold CLEAR/OFF for about 3 seconds to unlock the control.
Control display is lighted yet oven will not start	Clock is not set.	<ul style="list-style-type: none"> • Set the clock.
	Door not securely closed.	<ul style="list-style-type: none"> • Open the door and close securely.
	START/PAUSE button not pressed after entering cooking selection.	<ul style="list-style-type: none"> • Press START/PAUSE.
	Another selection already entered in oven and CLEAR/OFF button not pressed to cancel it.	<ul style="list-style-type: none"> • Press CLEAR/OFF.
	Size, quantity, or cooking time not entered after selecting <i>VEGETABLES (FRESH, FROZEN, CANNED)</i> , <i>BACON, DEFROST (TIME)</i> or <i>TIME COOK</i> .	<ul style="list-style-type: none"> • Make sure you have entered cooking time after selecting.
	CLEAR/OFF was pressed accidentally.	<ul style="list-style-type: none"> • Reset cooking program and press START/PAUSE.
	Food weight not entered after selecting DEFROST (AUTO).	<ul style="list-style-type: none"> • Make sure you have entered food weight after selecting DEFROST (AUTO).
OTHER PROBLEMS		
The door and inside of the oven feels hot	The heat lamps produce intense heat in a small space.	<ul style="list-style-type: none"> • This is normal. • Use oven mitts to remove food when ready.
Floor of the oven is warm, even when the oven has not been used	The cooktop light is located below the oven floor. When the light is on, the heat it produces may make the oven floor get warm.	<ul style="list-style-type: none"> • This is normal.
Oven will not start	A fuse in your home may be blown or the circuit breaker tripped.	<ul style="list-style-type: none"> • Replace fuse or reset circuit breaker.
	Power surge.	<ul style="list-style-type: none"> • Unplug the oven, then plug it back in.
	Plug not fully inserted into wall outlet.	<ul style="list-style-type: none"> • Make sure the plug on the oven is fully inserted into wall outlet.

GE Service Protection Plus™

GE, a name recognized worldwide for quality and dependability, offers you Service Protection Plus™—comprehensive protection on all your appliances—**No Matter What Brand!**

Benefits Include:

- Backed by GE
- All brands covered
- Unlimited service calls
- All parts and labor costs included
- No out-of-pocket expenses
- No hidden deductibles
- One 800 number to call

***We'll Cover Any Appliance.
Anywhere. Anytime.****

You will be completely satisfied with our service protection or you may request your money back on the remaining value of your contract. No questions asked. It's that simple.

Protect your refrigerator, dishwasher, washer and dryer, range, TV, VCR and much more—**any brand!** Plus there's no extra charge for emergency service and low monthly financing is available. Even icemaker coverage and food spoilage protection is offered. You can rest easy, knowing that all your valuable household products are protected against expensive repairs.

Place your confidence in GE and call us in the U.S. toll-free at **800.626.2224** for more information.

*All brands covered, up to 20 years old, in the continental U.S.

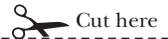

Please place in envelope and mail to:

General Electric Company
Warranty Registration Department
P.O. Box 32150
Louisville, KY 40232-2150

Consumer Product Ownership Registration

Dear Customer:

Thank you for purchasing our product and thank you for placing your confidence in us.

We are proud to have you as a customer!

Follow these three steps to protect your new appliance investment:

1

Complete and mail your Consumer Product Ownership Registration today. Have the peace of mind of knowing we can contact you in the unlikely event of a safety modification.

2

After mailing the registration below, store this document in a safe place. It contains information you will need should you require service. Our service number is 800 GE CARES (800.432.2737).

3

Read your Owner's Manual carefully. It will help you operate your new appliance properly.

Model Number

Serial Number

Important: If you did not get a registration card with your product, detach and return the form below to ensure that your product is registered, or register online at www.GEAppliances.com.



Consumer Product Ownership Registration



Model Number

Serial Number

Mr. Ms. Mrs. Miss

First Name

Last Name

Street Address

Apt. #

E-mail Address

City

State

Zip Code

Date Placed In Use
Month

Day

Year

Phone Number --

Occasionally, we may allow selected companies to send you information.

Check here if you do not want this information.

FAILURE TO COMPLETE AND RETURN THIS CARD DOES NOT DIMINISH YOUR WARRANTY RIGHTS.

For more information about GEA's privacy and data usage policy, go to www.GEAppliances.com and click on "Privacy Policy" or call 800.626.2224.



GE Appliances

GE Consumer Products
General Electric Company
Louisville, Kentucky
www.GEAppliances.com

Advantium Oven Warranty

Advantium Oven

All warranty service provided by an authorized Customer Care® technician. To schedule service, online, 24 hours a day, contact us at www.GEAppliances.com, or call 800.GE.CARES.

For The Period Of:	GE Will Replace:
One Year <i>From the date of the original purchase</i>	<i>Any part</i> of the oven which fails due to a defect in materials or workmanship. During this full one-year warranty , GE will also provide, free of charge , all labor and in-home service to replace the defective part.
Ten Years <i>From the second through the tenth year from the date of original purchase</i>	<i>The halogen speedcook lamps</i> , if the halogen lamps fail due to a defect in materials or workmanship. During this full ten-year warranty , GE will also provide, free of charge , all labor and in-home service to replace the defective part.
Ten Years <i>From the second through the tenth year from the date of original purchase</i>	<i>The magnetron tube</i> , if the magnetron tube fails due to a defect in materials or workmanship. During this additional nine-year limited warranty , you will be responsible for any labor or in-home service costs.

What GE Will Not Cover:

- Service trips to your home to teach you how to use the product.
- Replacement of house fuses or resetting of circuit breakers.
- Improper installation, delivery or maintenance.
- Damage to the product caused by accident, fire, floods or acts of God.
- Failure of the product or damage to the product if it is abused, misused (for example, cavity arcing from wire rack or metal/foil), or used for other than the intended purpose or used commercially.
- Incidental or consequential damage caused by possible defects with this appliance.
- Damage caused after delivery.
- Replacement of the cooktop light bulbs.

This warranty is extended to the original purchaser and any succeeding owner for products purchased for home use within the USA. In Alaska, the warranty excludes the cost of shipping or service calls to your home. Proof of the original purchase date is needed to obtain service under the warranty.

Some states do not allow the exclusion or limitation of incidental or consequential damages. This warranty gives you specific legal rights, and you may also have other rights which vary from state to state. To know what your legal rights are, consult your local or state consumer affairs office or your state's Attorney General.

Warrantor: General Electric Company. Louisville, KY 40225

GE Appliances Web site

www.GEAppliances.com

Have a question or need assistance with your appliance? Try the GE Appliances Web site 24 hours a day, any day of the year! For greater convenience and faster service, you can now download Owner's Manuals, order parts, catalogs, or even schedule service on-line. You can also "Ask Our Team of Experts™" your questions, and so much more...

Schedule Service

www.GEAppliances.com

Expert GE repair service is only one step away from your door. Get on-line and schedule your service at your convenience 24 hours any day of the year! Or call 800.GE.CARES (800.432.2737) during normal business hours.

Real Life Design Studio

www.GEAppliances.com

GE supports the Universal Design concept—products, services, and environments that can be used by people of all ages, sizes, and capabilities. We recognize the need to design for a wide range of physical and mental abilities and impairments. For details of GE's Universal Design applications, including kitchen design ideas for people with disabilities, check out our Web site today. For the hearing impaired, please call 800.TDD.GEAC (800.833.4322).

Extended Warranties

www.GEAppliances.com

Purchase a GE extended warranty and learn about special discounts that are available while your warranty is still in effect. You can purchase it on-line anytime or call 800.626.2224 during normal business hours. GE Consumer Home Services will still be there after your warranty expires.

Parts and Accessories

www.GEAppliances.com

Individuals qualified to service their own appliances can have parts or accessories sent directly to their homes (VISA, MasterCard, and Discover cards are accepted). Order on-line today, 24 hours every day, or by phone at 800.626.2002 during normal business hours.

Instructions contained in this manual cover procedures to be performed by any user. Other servicing generally should be referred to qualified service personnel. Caution must be exercised, since improper servicing may cause unsafe operation.

Contact Us

www.GEAppliances.com

If you are not satisfied with the service you receive from GE, contact us on our Web site with all the details, including your phone number, or write to: General Manager, Customer Relations
GE Appliances, Appliance Park
Louisville, KY 40225

Register Your Appliance

www.GEAppliances.com

Register your new appliance on-line—at your convenience! Timely product registration will allow for enhanced communication and prompt service under the terms of your warranty, should the need arise. You may also mail in the preprinted registration card included in the packing material.