



GE Profile Advantium® Oven

Advantium
 Cooking controls..... 12
 Getting to know the Advantium..... 10
 Oven features..... 11
 Safety 2-9

Speedcooking
 Cooking tips 14
 Custom speedcook..... 17
 My Recipes..... 18, 19
 Power level 16
 Repeat last..... 17
 Resume feature..... 17
 Speedcook cookware..... 14
 Speedcook-safe cookware..... 7
 Things that are normal..... 13
 Using the pre-set speedcook menu..... 15

Other Cooking Functions
 Broiling and toasting 21
 Convection baking..... 20
 Warming and proofing..... 22

Microwaving
 Cook by time..... 24
 Cooking tips 23
 Defrost by food type..... 26
 Defrost by time..... 25
 Defrosting tips..... 25
 Micro 30 Secs..... 25
 My Recipes..... 25
 Microwave power level(s) 24
 Microwave-safe cookware 8
 Precautions to avoid possible exposure to excessive microwave energy..... 2
 Sensor cooking..... 27, 28
 Things that are normal..... 23
 Using pre-set microwave selections..... 24

Other Features
 Automatic fan 31
 Automatic Night Light..... 30
 Auto Conversion..... 29
 Beeper volume..... 29
 Control lockout 31
 Clock..... 29
 Cook time completed 28
 Delay Start..... 30
 Display ON/OFF 29
 Help..... 31
 Reminder 29
 Surface Light 32
 Timer..... 31
 Turntable On/Off..... 29
 Vent Fan..... 32

Care and Cleaning
 Cleaning the inside..... 32
 Cleaning the outside..... 34
 Cooking trays and baking sheet..... 33
 Removable turntable..... 33
 Replacing the cavity light..... 35
 Replacing the surface light..... 35

Troubleshooting
 Problem Solver..... 37, 38

Consumer Support
 Consumer Support..... Back Cover
 Warranty 39

Owner's Manual

PSA2200
PSA2201

Write the model and serial numbers here:

Model # _____

Serial # _____

Find these numbers on a label inside the oven.

IMPORTANT SAFETY INSTRUCTIONS

READ ALL INSTRUCTIONS BEFORE USING

Advantium Oven

When using electrical appliances basic safety precautions should be followed, including the following:

⚠️ WARNING: To reduce the risk of burns, electric shock, fire, injury to persons, or exposure to excessive microwave energy:

PRECAUTIONS TO AVOID POSSIBLE EXPOSURE TO EXCESSIVE MICROWAVE ENERGY

- (a) **Do Not Attempt** to operate this oven with the door open since open-door operation can result in harmful exposure to microwave energy. It is important not to defeat or tamper with the safety interlocks.
- (b) **Do Not Place** any object between the oven front face and the door or allow soil or cleaner residue to accumulate on sealing surfaces.
- (c) **Do Not Operate** the oven if it is damaged. It is particularly important that the oven door close properly and that there is no damage to the:
- (1) door (bent),
 - (2) hinges and latches (broken or loosened),
 - (3) door seals and sealing surfaces.
- (d) **The Oven Should Not** be adjusted or repaired by anyone except properly qualified service personnel.

- **Read all instructions before using this appliance. When using electrical appliances, basic safety precautions should be followed, including the following:**
- Read and follow the specific precautions in the Precautions to Avoid Possible Exposure to Excessive Microwave Energy section above.
- This appliance must be grounded. Connect only to a properly grounded outlet. See the Grounding Instructions section on page 8.
- This microwave oven is UL listed for installation over both gas (less than 60,000BTU) and electric ranges.
- This over-the-range oven is designed for use over ranges no wider than 36." It may be installed over both gas and electric cooking equipment.
- Do not operate this appliance if it has a damaged power cord or plug, if it is not working properly, or if it has been damaged or dropped. If the power cord is damaged, it must be replaced by General Electric Service or an authorized service agent using a power cord available from General Electric.
- To reduce the risk of fire in the oven cavity:
 - Do not overcook food. Carefully attend appliance when paper, plastic or other combustible materials are placed inside the oven while cooking.
 - Remove wire twist-ties and metal handles from paper or plastic containers before placing them in the oven.
 - Do not use the oven for storage purposes. Do not leave paper products, cooking utensils or food in the oven when not in use.
 - Do not pop popcorn in your microwave oven unless in a special microwave popcorn accessory or unless you use popcorn labeled for use in microwave ovens.
 - If materials inside the oven ignite, keep the oven door closed, turn the oven off and disconnect the power cord, or shut off power at the fuse or circuit breaker panel. If the door is opened, the fire may spread.
 - Do not use the Sensor Features twice in succession on the same food portion. If food is undercooked after the first countdown, use **COOK BY TIME** for additional cooking time.
 - Do not use the oven to dry newspaper.

SAVE THESE INSTRUCTIONS

IMPORTANT SAFETY INSTRUCTIONS

READ ALL INSTRUCTIONS BEFORE USING

Advantium Oven

IMPORTANT SAFETY INSTRUCTIONS

- Be sure your appliance is properly installed and grounded by a qualified technician in accordance with the provided installation instructions.
- Install or locate this appliance only in accordance with the provided installation instructions.
- Some products such as whole eggs and sealed containers—for example, closed jars—are able to explode and should not be heated in this oven. Such use of the oven could result in injury.
- Do not mount this appliance over a sink.
- This oven is not approved or tested for marine use.
- This oven is UL listed for standard wall installation above 36 inches.
- Do not operate this appliance if it has been damaged or dropped.
- As with any appliance, close supervision is necessary when used by children.
- Use this appliance only for its intended use as described in this manual.
- Do not use corrosive chemicals or vapors in this appliance.
- This oven is specifically designed to heat, dry or cook food, and is not intended for laboratory or industrial use.
- This appliance must only be serviced by qualified service personnel. Contact nearest authorized service facility for examination, repair or adjustment.
- Do not cover or block any openings on the appliance.
- Do not store this appliance outdoors. Do not use this product near water—for example, in a wet basement, near a swimming pool, near a sink or in similar locations.
- See door surface cleaning instructions in the *Care and Cleaning of the Oven* section of this manual.
- If materials inside the oven ignite, keep the oven door closed, turn the oven off and shut off power at the fuse or circuit breaker panel. If the door is opened, the fire may spread.
- The wire oven rack should not be used for speedcook or microwave cooking to prevent arcing.
- Do not cover racks or any other part of the oven with metal foil. This will cause overheating of the oven.
- Oversized foods or oversized metal utensils should not be used in oven as they may create a fire or risk of electric shock.
- Do not use paper products when appliances is operated in modes other than microwave.

SAVE THESE INSTRUCTIONS

IMPORTANT SAFETY INSTRUCTIONS

READ ALL INSTRUCTIONS BEFORE USING

Advantium Oven

IMPORTANT SAFETY INSTRUCTIONS

- Thermometer—Do not use regular cooking or oven thermometers when cooking by microwave. The metal and mercury in these thermometers could cause arcing and possible damage to the oven. Do not use a thermometer in food you are microwaving unless the thermometer is designed or recommended for use in the microwave oven.
- Do not clean with metal scouring pads. Pieces can burn off the pad and touch electrical parts involving risk of electric shock.
- Do not store any materials, other than our recommended accessories, in this oven when not in use.
- Do not let cord hang over edge of table or counter.
- Keep power cord away from heated surfaces.
- Do not immerse power cord or plug in water.
- Do not operate the oven without the turntable in place. The turntable must be unrestricted so it can turn.
- During and after use, do not touch, or let clothing or other flammable materials contact any interior area of the oven; allow sufficient time for cooling first.
- Potentially hot surfaces include the oven door, floor, walls, oven rack and turntable.
- It is important to keep the area clean where the door seals against the microwave. Use only mild, non-abrasive detergents applied with a clean sponge or soft cloth. Rinse well.
- Do not store anything directly on top of the microwave oven surface when the microwave oven is in operation.
- Keep the oven free from grease buildup.
- Per USDA, cook meat to an INTERNAL temperature of at least 160°F, and poultry to an INTERNAL temperature of at least 180°F. Cooking to these temperatures usually protects against foodborne illness. For more information, see www.foodsafety.gov.

ARCING

Arcing can occur during both speedcooking and microwave cooking. If you see arcing, press the CLEAR/OFF pad and correct the problem.

Arcing is the microwave term for sparks in the oven. Arcing is caused by:

Do not store rack in microwave. Rack is ONLY to be used for Convection Bake, Warm and Proof.

- Metal or foil touching the side of the oven.
- Foil not molded to food (upturned edges act like antennas).
- Use foil only as recommended in this manual.
- Metal, such as twist-ties, poultry pins, or gold-rimmed dishes, in the oven.
- Metal cookware or the wire oven rack used during either speedcook or microwave cooking (except for the pans provided with the oven).
- Recycled paper towels containing small metal pieces being used in the oven.

IMPORTANT SAFETY INSTRUCTIONS

READ ALL INSTRUCTIONS BEFORE USING

Advantium Oven

FOODS

- When microwaving, place all foods and containers on the clear glass tray.
- Do not pop popcorn in your oven unless in a special microwave popcorn accessory or unless you use popcorn labeled for use in microwave ovens.
- Do not boil eggs in this oven. Pressure will build up inside egg yolk and will cause it to burst, possibly resulting in injury.
- Do not operate oven without food inside. This may cause damage to the oven. It increases the heat around the magnetron and can shorten the life of the oven.
- Foods with unbroken outer “skin” such as potatoes, hot dogs, sausages, tomatoes, apples, chicken livers and other giblets, and egg yolks should be pierced to allow steam to escape during cooking.
- Don't defrost frozen beverages in narrow-necked bottles (especially carbonated beverages). Even if the container is open, pressure can build up. This can cause the container to burst, possibly resulting in injury.
- Foods cooked in liquids (such as pasta) may tend to boil more rapidly than foods containing less moisture. Should this occur, refer to the Care and Cleaning of the oven section for instructions on how to clean the inside of the oven.
- Hot foods and steam can cause burns. Be careful when opening any containers of hot food, including popcorn bags, cooking pouches and boxes. To prevent possible injury, direct steam away from hands and face.
- Do not overcook potatoes. They could dehydrate and catch fire, causing damage to your oven.
- Avoid heating baby food in glass jars, even with the lid off. Make sure all infant food is thoroughly cooked. Stir food to distribute the heat evenly. Be careful to prevent scalding when warming formula. The container may feel cooler than the formula really is. Always test the formula before feeding the baby.
- Do not attempt to deep fry in the oven.
- **SUPERHEATED WATER**
Liquids, such as water, coffee or tea, are able to be overheated beyond the boiling point without appearing to be boiling. Visible bubbling or boiling when the container is removed from the microwave oven is not always present. THIS COULD RESULT IN VERY HOT LIQUIDS SUDDENLY BOILING OVER WHEN THE CONTAINER IS DISTURBED OR A SPOON OR OTHER UTENSIL IS INSERTED INTO THE LIQUID.

To reduce the risk of injury to persons:

- Do not overheat the liquid.
- Stir the liquid both before and halfway through heating it.
- Do not use straight-sided containers with narrow necks.
- After heating, allow the container to stand in the microwave oven for a short time before removing the container.
- Use extreme care when inserting a spoon or other utensil into the container.

SAVE THESE INSTRUCTIONS

IMPORTANT SAFETY INSTRUCTIONS

READ ALL INSTRUCTIONS BEFORE USING

Advantium Oven

Microwave-safe cookware

⚠ WARNING!

Make sure to use suitable cookware during microwave cooking. Most glass casseroles, cooking dishes, measuring cups, custard cups, pottery or china dinnerware which does not have metallic trim or glaze with a metallic sheen can be used. Some cookware is labeled "suitable for microwaving."

- Do not use the wire oven rack for microwave.
- Place food or microwavable container directly on the clear glass tray to cook your food.
- Use of a metal tray during microwave cooking will result in inferior cooking performance.

- If you are not sure if a dish is microwave-safe, use this test: Place both the dish you are testing and a glass measuring cup filled with 1 cup of water in the oven. Set the measuring cup either in or next to the dish. Microwave 30-45 seconds at high. If the dish heats, it should not be used for microwaving.

If the dish remains cool and only the water in the cup heats, then the dish is microwave-safe.

⚠ CAUTION: Burn Risk

- Cookware may become hot because of heat transferred from the heated food. Oven mitts may be needed to handle the cookware.
- Use foil only as directed in this manual. When using foil in the oven, keep the foil at least 1" away from the sides of the oven.
- If you use a meat thermometer while cooking, make sure it is safe for use in microwave ovens.
- Some foam trays (like those that meat is packaged on) have a thin strip of metal embedded in the bottom. When microwaved, the metal can burn the floor of the oven or ignite a paper towel.

- Do not use recycled paper products. Recycled paper towels, napkins and waxed paper can contain metal flecks which may cause arcing or ignite. Paper products containing nylon or nylon filaments should be avoided, as they may also ignite.
- Paper towels, waxed paper and plastic wrap can be used to cover dishes in order to retain moisture and prevent spattering. Be sure to vent plastic wrap so steam can escape.
- Not all plastic wrap is suitable for use in microwave ovens. Check the package for proper use.
- "Boilable" cooking pouches and tightly closed plastic bags should be slit, pierced or vented as directed by package instructions. If they are not, plastic could burst during or immediately after cooking, possibly resulting in injury. Also, plastic storage containers should be at least partially uncovered because they form a tight seal. When cooking with containers tightly covered with plastic wrap, remove covering carefully and direct steam away from hands and face.
- Plastic cookware—Plastic cookware designed for microwave cooking is very useful, but should be used carefully. Even microwave-safe plastic may not be as tolerant of overcooking conditions as glass or ceramic materials. Plastic may soften or char if subjected to short periods of overcooking. In longer exposures to overcooking, the food and cookware could ignite.

Follow these guidelines:

1. Use microwave-safe plastics only, and use them in strict compliance with the cookware manufacturer's recommendations.
2. Do not microwave empty containers.
3. Do not permit children to use plastic cookware without adult supervision.



The turntable must always be in place when using the oven.



The clear glass tray should always be in place when microwaving.



How to test for a microwave-safe dish.

IMPORTANT SAFETY INSTRUCTIONS

READ ALL INSTRUCTIONS BEFORE USING

Advantium Oven

Oven-safe cookware for Speedcooking



The turntable must always be in place when using the oven.



Put food directly on the metal grill tray to speedcook.



Put food directly on the metal tray to speedcook, convection bake, warm or toast.

▲ CAUTION: Burn Risk

■ The oven and door will get very hot when speedcooking.

■ Cookware will become hot. Oven mitts will be needed to handle the cookware.

▲ WARNING: Fire Risk

■ Do not use coverings, containers or cooking/roasting bags made of foil, plastic, wax or paper when speedcooking.

■ Do not cover the turntable, metal trays or any part of the oven with metal foil. This will cause arcing in the oven.

■ Use the metal tray in the same way you would use a shallow baking pan or baking tray.

■ Do not use the wire oven rack for speedcook.

■ Place food directly on the metal trays when cooking unless prompted by the oven to do otherwise.

■ Any non-metal oven-safe dish can be used in your oven. Place them directly on the trays.

■ Use of the clear glass tray when speedcooking will result in inferior cooking performance and possible cracking of the glass tray.

■ Use only the metal trays specified for use with this oven. Other metal trays are not designed for use with this oven and will result in inferior cooking performance.

Oven-safe cookware for Convection Baking, Broiling, Warming, Proofing & Toasting

▲ CAUTION: Burn Risk

■ The oven and door will get very hot when convection baking, broiling, warming or toasting.

■ Cookware will become hot. Oven mitts will be needed to handle the cookware.

▲ WARNING: Fire Risk

■ Do not cover dishes or use plastic containers, plastic cooking/roasting bags, plastic wrap, wax paper or paper when broiling or toasting.

■ Use the metal tray in the same way you would use a shallow baking pan or baking tray.

■ Use the wire oven rack when convection baking or warming.

■ Place food directly on the metal trays when cooking unless the recipe requires a dish.

■ Any oven-safe dish can be used in your oven. Place them directly on the trays.

■ Use of the clear glass tray when convection baking, broiling, warming or toasting will result in inferior cooking performance.



The turntable must always be in place when using the oven.



Put food directly on the metal grill tray as required to broil.



Put food directly on the metal tray or in the appropriate dish and place on wire oven rack when baking or warming.



Put food or oven-safe cookware directly on the metal tray to convection bake, warm or toast.

SAVE THESE INSTRUCTIONS

IMPORTANT SAFETY INSTRUCTIONS

READ ALL INSTRUCTIONS BEFORE USING

Advantium Oven

Grounding Instructions

⚠ WARNING!

Improper use of the grounding plug can result in a risk of electric shock.

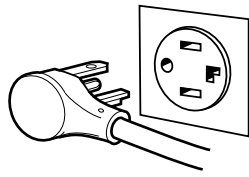

Ensure proper ground exists before use.

This appliance must be grounded. In the event of an electrical short circuit, grounding reduces the risk of electric shock by providing an escape wire for the electric current.

This appliance is equipped with a power cord having a grounding wire with a grounding plug. The plug must be plugged into an outlet that is properly installed and grounded.

Consult a qualified electrician or service technician if the grounding instructions are not completely understood, or if doubt exists as to whether the appliance is properly grounded.

If the outlet is a standard 3-prong wall outlet, it is your personal responsibility and obligation to have it replaced with a properly grounded 30 ampere, 4-prong wall outlet.

Do not under any circumstances cut or remove the ground prong from the power cord.

Do not use an adapter plug with this appliance.

Do not use an extension cord with this appliance. If the power cord is too short, have a qualified electrician or service technician install an outlet near the appliance.

For best operation, plug this appliance into its own electrical circuit to prevent flickering of lights, blowing of fuse or tripping of circuit breaker.

The Vent Fan

The fan will operate automatically under certain conditions (see Vent Fan section). Take care to prevent the starting and spreading of accidental cooking fires while the vent fan is in use.

- Clean the underside of the Advantium often. Do not allow grease to build up on the Advantium or the fan filters.
- In the event of a grease fire on the surface units below the Advantium, smother a flaming pan on the surface unit by covering the pan completely with a lid, a cookie sheet or a flat tray.

- Use care when cleaning the vent fan filters. Corrosive cleaning agents, such as lye-based oven cleaners, may damage the filters.
- When preparing flaming foods under the Advantium, turn the fan on.
- Never leave surface units beneath your Advantium unattended at high heat settings. Boilovers cause smoking and greasy spillovers that may ignite and spread if the Advantium vent fan is operating. To minimize automatic fan operation, use adequate sized cookware and use high heat on surface units only when necessary.

IMPORTANT SAFETY INSTRUCTIONS

READ ALL INSTRUCTIONS BEFORE USING

Advantium Oven

⚠ WARNING

PACEMAKERS

Most pacemakers are shielded from interference from electronic products, including microwaves. However, patients with pacemakers may wish to consult their physicians if they have concerns.

READ AND FOLLOW THIS SAFETY INFORMATION CAREFULLY.

SAVE THESE INSTRUCTIONS

Optional kits

Available at extra cost from your GE supplier.

Filler Panel Kits

- *JX52WH—White*
- *JX52BL—Black*

When replacing a 36" range hood, filler panel kits fill in the additional width to provide a custom built-in appearance.

For installation between cabinets only; not for end-of-cabinet installation. Each kit contains two 3" wide filler panels.

Filter Kits

- *JX81D—Recirculating Charcoal Filter Kit*

Filter kits are used when the oven cannot be vented to the outside.

See back cover to order by phone or at ge.com.

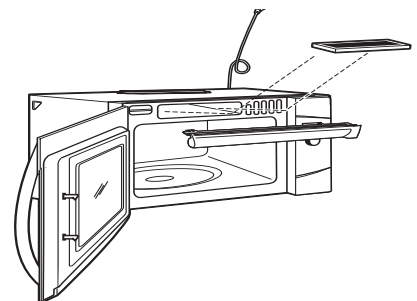

Getting to know the Advantium

The Advantium oven uses breakthrough Speedcook technology to harness the power of light. The Advantium oven cooks the outside of foods much like conventional radiant heat, while also penetrating the surface so the inside cooks simultaneously.

While halogen light is the primary source of power, a convection system and ceramic heater assist in the cooking, with a "microwave boost" added in some cooking algorithms. Food cooks evenly and fast, retaining its natural moisture.

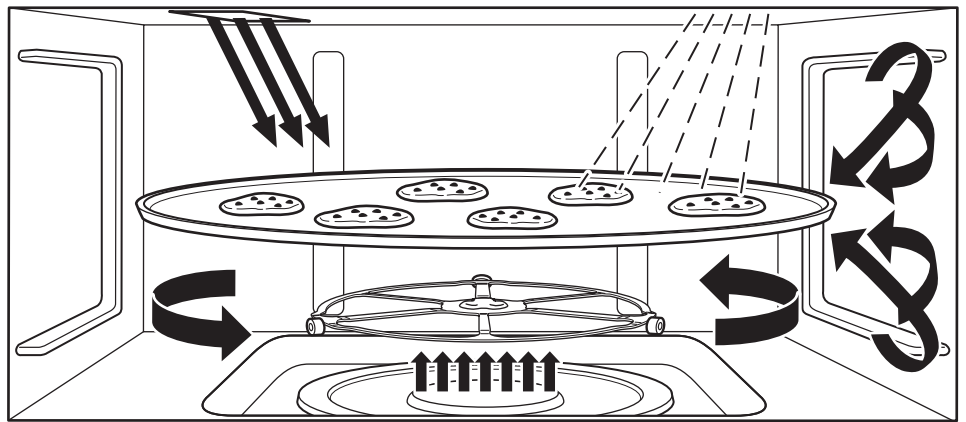

The Advantium oven is capable of speedcooking, convection baking, broiling, toasting, warming, proofing and microwaving. The Speedcook feature is the biggest benefit of the Advantium oven.

No preheating is required to speedcook. Place the food in the oven and start cooking immediately. Time is saved because there is no preheat and because speedcook cooks faster.

Oven Features

Advantium Oven

Oven features

Throughout this manual, features and appearance may vary from your model.

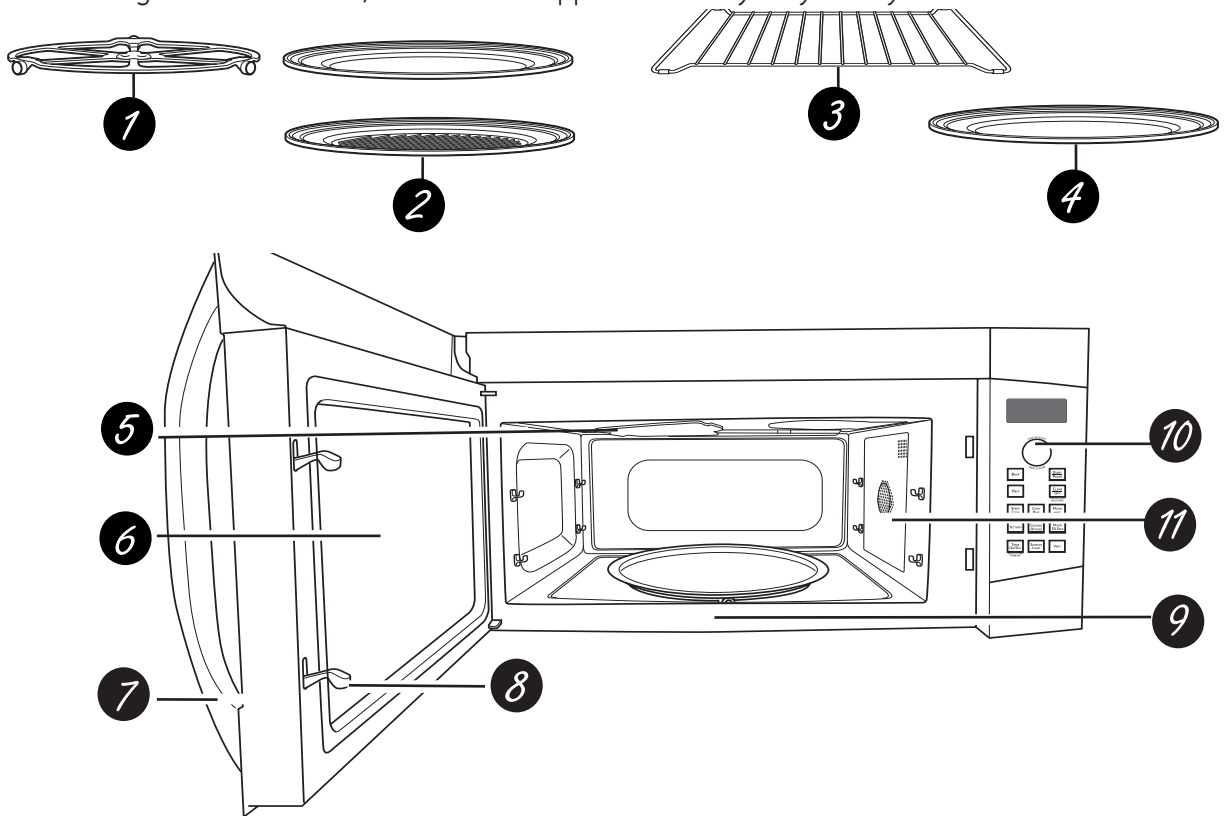

- 1** *Turntable*
The turntable must always be in place, on the oven floor, for all cooking. Be sure the turntable is seated securely over the spindle in the center of the oven.
- 2** *Metal Tray or Metal Grill Tray*
Put food directly on the metal tray or metal grill tray and place on the turntable when using the speedcook, broil, and toast.
- 3** *Wire Oven Rack*
Put food directly on a metal tray or in an oven-safe dish on the wire oven rack only when convection baking or warming.
- 4** *Clear Glass Tray*
Place on turntable when using microwave features. Place food or microwave-safe cookware directly on tray.
- 5** *Upper Halogen Lamps*
Two 1200W halogen lamps cook food from above in speedcook, broil and toast.
- 6** *Window*
Allows cooking to be viewed while keeping microwaves confined in the oven.
- 7** *Door Handle*
Pull to open the door.
- 8** *Door Latches*
The door must be securely latched for the oven to operate.
- 9** *Lower Ceramic Heater*
One 500W ceramic heater cooks food from the bottom in speedcook, broil and toast.
- 10** *Control Panel*
The pads used to operate the oven are located on the control panel.
- 11** *Convection System*
One 1550W heating element cooks food with a convection fan circulating the hot air throughout the cavity in speedcook, broil, convection bake, toast and warm.

Cooking controls

With your Advantium oven, you can cook with high-intensity halogen lights, ceramic heaters, convection heating element, and/or conventional microwave energy.

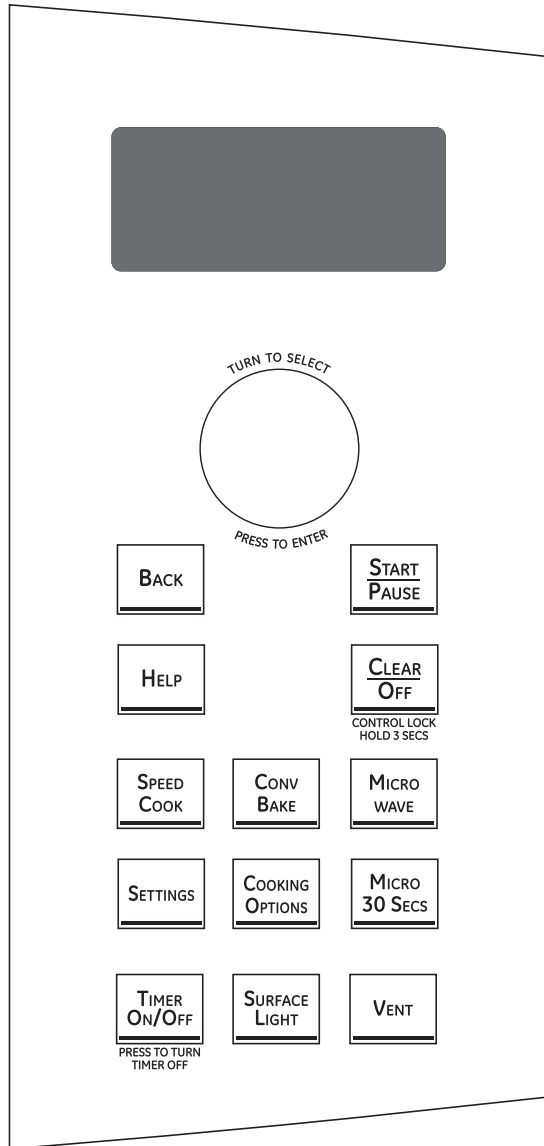

SELECTOR DIAL

Turn to select. Press to enter.
Turn to select food, power level, or temperature selections. Also use the dial to increase (turn clockwise) or decrease (turn counterclockwise) time. Simply press the button to enter the selection.

BACK

Press this pad to step back one or more levels in the programming process.

HELP

Press this pad to find out more about your oven's features.

DISPLAY

Shows feature selections and information about the oven when in use.

START/PAUSE

Press this pad to start or pause any cooking function.

CLEAR/OFF

Press this pad to cancel ALL oven programs except clock, auto night light, timer, vent fan, and surface light.

SPEEDCOOK

Press this pad to access the pre-set speedcook menu or to set your own speedcook program.

CONV BAKE

Press this pad to use convection bake.

MICROWAVE

Press this pad to access the microwave menu or to set your own microwave program.

SETTINGS

Press this pad to set the clock and access Turntable On/Off, Auto Conversion, Auto Nightlight, Beeper Volume, Display On/Off, Reminder, and Temperature Units.

COOKING OPTIONS

Press this pad to access Repeat Last, Broil, Proof, Toast, Warm and Delay Start.

MICRO 30 SEC

Starts the microwave for 30 seconds of cooking time. An additional 30 seconds is added to the remaining cooking time each time the pad is pressed.

TIMER ON/OFF

Press this pad to set a minute and seconds timer.

SURFACE LIGHT

Press this pad to turn the cooktop light on and off.

VENT FAN

Press this pad to turn the vent fan on and off.

Using speedcook features

⚠ CAUTION: Burn Risk

When using speedcook programs, remember that the oven, door and dishes will be very hot!

Prior to the first use of your oven, the clock must be set. See the Clock section.

Before you begin, make sure the turntable is in place. Use the metal tray or metal grill tray and your own glass or ceramic cookware, if needed.



The turntable must always be in place when using the oven.



Put food directly on the metal tray or metal grill tray to speedcook.

- If the door is opened during cooking, the oven will stop and PAUSE will appear in the display. Close the door and press the START/PAUSE pad to resume cooking.
- At any time during cooking you can change time or power levels by selecting EDIT.
- Speedcooking meats in the oven may produce smoke.
- To cook for additional time after a cooking cycle has been completed, use the Resume feature as instructed on the display.

Things that are normal

Cooking Times

- When speedcooking pre-set menu foods, you may see OPTIMIZING COOK TIME in the display several seconds after you press START/PAUSE. The oven automatically senses the electrical voltage level in your home and adjusts the cooking time up or down for proper cooking.

Cooling Fans

- The fans will be on during cooking. At the end of cooking, the fans may continue to run for a short time to cool internal components. The fans will automatically shut off when the internal parts of the oven have cooled. The screen will display "Oven is Cooling".
- The oven vent will emit warm air while the oven is on.
- The exhaust fan may come on automatically if the oven becomes hot. See Automatic fan section.

Lights

- When the oven is on, light may be visible around the door or outer case.
- The halogen lights will dim and cycle on and off during a speedcook cycle, sometimes even at full power levels. This is normal. The oven senses the heat level and adjusts automatically.

Oven Heat

- No preheating time is required during speedcook cycles. The oven begins cooking immediately.
- The door and inside of the oven will be very hot. Use caution when opening the door and removing food. Be cautious of steam or vapor that may escape from around the door.
- Do not use cookware or coverings made of paper, plastic, or foil when speedcooking.
- When cooking for an extended period of time, the oven may automatically reduce the power levels to maintain the appropriate level of oven heat.

Sounds

- Clicks and a fan blowing are normal sounds during cooking. The electronic control is turning components on and off.

Interference

- TV/radio interference might be noticed while using the microwave, similar to the interference caused by other small appliances. It does not indicate a problem with the microwave. Move the radio or TV as far away from the microwave as possible, or check the position of the TV/radio antenna.

Cooking tips for best results

Arrange food on the metal trays as shown to ensure consistent and even browning.

Foods can touch but should not overlap.

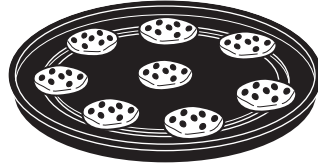

Circular pattern
(Example: biscuits, cookies)



Side by side pattern
(Example: meats and poultry)

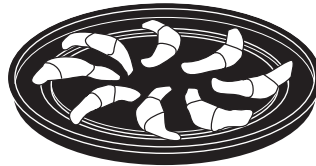

Spoke pattern
(Example: crescent rolls, breadsticks)



Single layer
(Example: appetizers)

Fresh meat, chicken, fish or seafood that has been frozen should be thawed before cooking. (The microwave defrost feature can be used.) For other frozen prepackaged foods, follow package directions.

Speedcook cookware

⚠ CAUTION: Burn Risk

- Cookware will become hot. Oven mitts will be needed to handle the cookware.
- Follow cookware suggestions on the oven display or in the cookbook.
- Place food directly on the metal tray or metal grill tray when cooking, unless prompted by the oven to do otherwise.
- Use the metal tray in the same way you would use a shallow baking pan or baking tray.
- In addition to the cookware provided, you can use non-metal casserole dishes, pie plates and other heat-safe cookware. Place them directly on the metal tray.



- Be sure to select a size that will rotate easily.
- Place the metal tray or metal grill tray on the turntable. Place glass or ceramic cookware on the tray.
- Do not use cookware or coverings made of paper, plastic, or foil when cooking during a speedcook cycle.

Using the pre-set speedcook menu

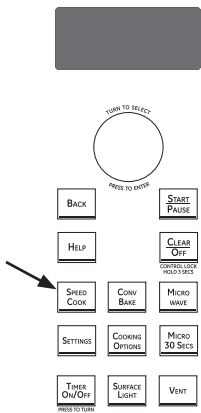

The Advantium is already pre-set to cook over 175 popular foods.

1. Press the SPEEDCOOK pad.
If no selection is made within 15 seconds, the display will revert back to the time of day.
2. Turn the selector dial to select the type of food category you want. Press the dial to enter.
3. Turn the selector dial to select the specific food (menu selection). Press the dial to enter.
4. Turn the selector dial to select amount, size and/or doneness (if required, the oven will prompt you). Press the dial after each selection.

5. Once the display shows: EDIT, SAVE or START press the START/PAUSE pad or the selector dial to start cooking.

Turn the food over when the oven signals TURN FOOD OVER (for certain foods).

When the oven signals CHECK for DONENESS, check to see if your food is done to your liking (for certain foods).

To review settings during cooking, press the selector dial.

If you enter an undesired selection at any time, simply press the BACK pad and re-enter the desired selections.

Speedcooking meats in the oven may produce smoke.

Pre-set speedcook menu selections

Per USDA Guidelines, cook meat to an INTERNAL temperature of at least 160°F, and poultry to an INTERNAL temperature of at least 180°F. Cooking to these temperatures usually protects against foodborne illness. For more information, see www.foodsafety.gov.

Food Category	Menu Selection	Food Category	Menu Selection	Food Category	Menu Selection	
Appetizers	Bagel Bites	Chicken	Bone-In	Sandwich	Corn Dog (frozen)	
	Cheese Sticks		Boneless		Crescent Roll Hot Dog	
	Egg Rolls (Frozen)		Fillet (frozen)		Grilled Sandwich	
	Jalapeño Poppers		Finger (frozen)		Pocket Sandwich	
	Meat Balls (Frozen)		Fried (frozen)		Seafood	Cod Fillets
	Nachos		Nugget (frozen)	Fish Sticks (frozen)		
	Nuts, Roasted		Patty (frozen)	Frozen Breaded		
	Onion Rings		Tender (frozen)	Orange Roughy Fillet		
	Pizza Rolls		Wings (frozen)	Salmon		
	Soft Pretzels (frozen)		Whole	Shellfish		
Taquitos (frozen)	Desserts		Brownie Mix	Swordfish Steak (1")		
Breads			Biscuits	Cookies	Talapia	
			Bread Sticks	Pie (fresh fruit)	Tuna Steaks	
			Cheese Bread	Pie Crust	Whitefish/Cod	
		Crescent Rolls	Rolls (refrigerated)	Side Dish	Casserole	
	Dinner Rolls	Turnovers	Refried Beans (16 oz)			
	Garlic Bread	Entree	Egg Rolls (frozen)		Roasted Asparagus	
Texas Toast	Meatloaf (9x5)		Roasted Bell Pepper			
Breakfast	Belgian Waffles		Taquitos (frozen)		Roasted Chilies (3-6)	
	Breakfast Pizza	Meats	Roasted Corn (1-4)			
	French Toast		Filet Mignon		Roasted Garlic	
	Hashbrown Patties		Hamburger		Roasted Mixed Vegetables	
	Pancakes (frozen)		Lamb Chops		Scalloped Potatoes	
	Rolls (refrigerated)		Pork Chops		Pizza	Deli/Fresh
	Sausage Biscuit		Ribeye Steak	Frozen Pizza		
	Sausage Links		Sirloin Steak	Use Precooked Crust		
	Sausage Patties		Strip Steak	Potatoes		Baked Potato
	Strudel (frozen)		T-Bone Steak			Hashbrown Patties
	Turnovers		Tenderloin			Frozen Fries
Waffles (frozen)	Pizza	Frozen Nugget				
Meats		Deli/Fresh	Sweet Potato/Yam			
		Filet Mignon				
		Hamburger				
	Lamb Chops					
	Pork Chops					
	Ribeye Steak					
	Sirloin Steak					
	Strip Steak					
	T-Bone Steak					
	Tenderloin					

Speedcook power level

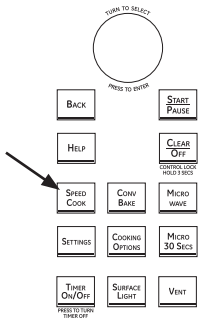

The Advantium uses power from high intensity halogen lamps, a ceramic heater, a convection system and microwaves to cook food from the top, bottom and interior simultaneously to seal in moisture and flavor.

When using the pre-set menu foods, the power levels are already selected for you. However, power levels can be adjusted when using pre-set menu foods and MY RECIPE.

Each power level gives you halogen lamp or ceramic heater power and microwave energy for a certain percentage of the time or provides heating from the convection system.

For example:

- U-07 Upper halogen lamp on 70% of the time.
- L-07 Lower ceramic heater on 70% of the time.
- M-05 Microwave on 50% of the time.
- C-06 Convection element heats oven to 350°F.

NOTE: Be careful when adjusting power levels so that you do not overcook or undercook food.

1. Press the SPEEDCOOK pad and select your food (follow instructions from Using the pre-set speedcook menu).
2. When display shows EDIT, SAVE or START, turn the dial to select EDIT.

If you do not want to change one of the settings, just press the dial to move to the next selection.
3. Press the dial if you do not want to adjust cooking time.
4. Turn the dial clockwise to increase or counterclockwise to decrease the upper power level. Press the dial to enter.
5. Turn the dial to change the lower power level. Press the dial to enter.
6. Turn the dial to change the microwave power level. Press the dial to enter.
7. Turn the dial to change the convection power level. Press the dial to enter.
8. Press the START/PAUSE pad or the selector dial to start cooking.

Follow these general guidelines when selecting the best U=, L=, M= and C= settings for your favorite recipes:

U = Select a higher setting for thin foods requiring a golden brown top (example: fish fillets, toast, boneless chicken breasts). Select a lower setting for thicker foods and foods with high sugar or fat content (example: muffins, roasts, casseroles) or that require a longer cook time.

L = Select a higher setting for thick or dense foods that may not cook quickly in the center (example: steaks, casseroles). Select a lower setting for thin foods (example: cookies).

M = Select a higher setting to shorten cooking time for dense or heavy foods (example: casseroles, whole chicken). Select a lower setting for delicate foods (example: breads) or foods requiring longer cook times for tender results (example: stew, pot roast).

C = Select a lower setting for more delicate foods that cook at lower temperatures. Select a higher setting (6 or above) for more robust foods or foods that cook at temperatures above 350°F.

Repeat last

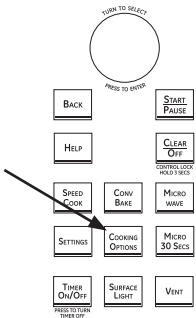

Use this time saving feature for cooking repetitive items like cookies or appetizers.

NOTE: The last program used is stored for two hours.

1. Press COOKING OPTIONS and select REPEAT LAST.
2. The last pre-set food will be displayed.
3. Press the START/PAUSE pad or the selector dial to start cooking.

Resume feature

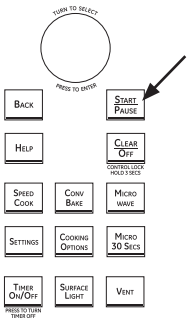

1. If your food needs to cook a bit longer, you can restart the oven by pressing the START/PAUSE pad or selector dial.
2. RESUME COOKING will be displayed and the oven will restart immediately at 10% of the original time.

The program stays in memory for 5 minutes. After that you will need to begin the program again. See Using the pre-set speedcook menu section.

My Recipe - Custom speedcooking

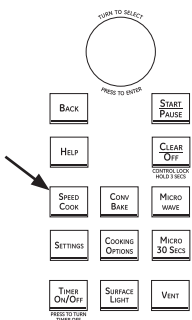

The Advantium gives you the flexibility to cook your favorite dishes.

If you want to cook a food item that is not among the pre-set selections, use My Recipe to custom speedcook.

1. Press the SPEEDCOOK pad and select MY RECIPE. Press the dial to enter. Select NEW RECIPE.

If no entries are made within 15 seconds, the display will revert back to the time of day.

2. Turn the selector dial to select the cooking time. Press the dial to enter.

The display will prompt you to select the power level(s).

3. Turn the dial to select the upper power level. Turn the dial clockwise to increase or counterclockwise to decrease the upper power level. Press the dial to enter.

4. Turn the dial to select the lower power level. Press the dial to enter.
5. Turn the dial to select the microwave power level. Press the dial to enter.
6. Turn the dial to select the convection power level. Press the dial to enter.
7. Press the START/PAUSE pad or press the selector dial to start cooking.

For power level and cooking time suggestions, use your cooking guide, cookbook and the pre-set speedcook menu selections.

My Recipe— to enter and save

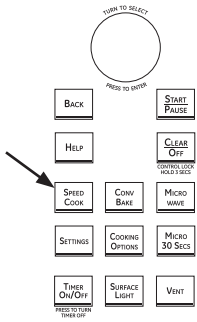

Add and save up to 30 of your own Speedcook or microwave recipes, or pre-set Speedcook menu recipes as a favorite recipe. Once it's done, you can quickly recall your favorite so that your food cooks just the way you want it every time!

1. Press the SPEEDCOOK or MICROWAVE pad.
2. Turn the dial to select MY RECIPE. Press the dial to enter.
3. Turn the dial until NEW RECIPE appears. Press the dial to enter.
4. ENTER COOK TIME appears. Turn the dial to select the cooking time. Press the dial to enter.

The display will prompt you to select the power level(s).

5. Turn the dial clockwise to increase or counterclockwise to decrease the power level(s). Press the dial to enter.

For power level and cooking time suggestions, use your cooking guide or cookbook.

6. Select SAVE from the summary screen.
7. SPELL THE FOOD NAME appears. Turn the dial to the first letter of your food description and press the dial to enter. Continue this process to spell the rest of the food name. Press the START/PAUSE pad to save the recipe and its name.

My Recipe— to find and use

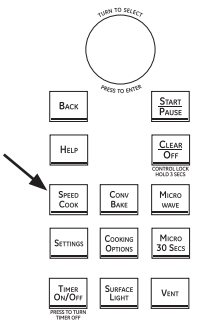

To find and use stored recipes:

1. Press the SPEEDCOOK or MICROWAVE pad.
2. Turn the dial to select MY RECIPE.

3. The recipe names you entered will appear.
4. Turn dial until the recipe you want is displayed and press the dial to enter.
5. Press the START/PAUSE pad or press the selector dial to start cooking.

My Recipe— to adjust or change

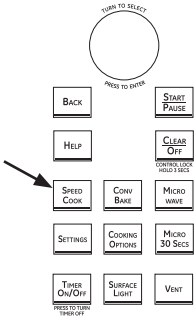

To adjust or change stored recipes:

1. Press the SPEEDCOOK or MICROWAVE pad.
2. Turn the dial to select MY RECIPE.
3. Turn the dial to the recipe you want to change. Press the dial to enter. Current settings appear.
4. Select EDIT.
5. Turn the dial to adjust the cooking time and press the dial to enter.
6. Turn the dial to change the power level(s) and press the dial to enter each power level.

7. Turn the dial to change the recipe name. Press the dial to enter each letter change.
8. Press the START/PAUSE pad to save the revised recipe.

For power level and cooking time suggestions, use your cooking guide or cookbook.

My Recipe— to delete

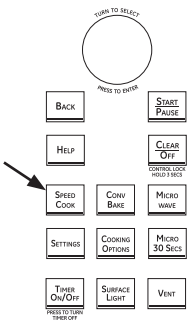

To delete stored recipes:

1. Press the SPEEDCOOK or MICROWAVE pad.
2. Turn the dial to select MY RECIPE.
3. Select the recipe you would like to delete.
4. Turn the dial to select DELETE.

Convection Baking

Convection baking allows you to cook foods the same way as a conventional oven, using an element to heat the air inside the oven. Any oven temperature from 250°F to 450°F may be set.

A fan gently circulates heated air throughout the oven, over and around the food. Because the heated air is kept constantly moving, some foods cook slightly faster than in regular oven cooking.

Before you begin, make sure the metal rack is in place. Both racks may be used for two level cooking.

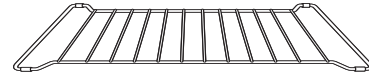

Put food directly on the metal tray or in the appropriate dish and place on wire oven rack when baking or warming.

CAUTION: Burn Risk

When baking, remember that the oven, door and dishes will be very hot!

Per USDA Guidelines, cook meat to an INTERNAL temperature of at least 160°F, and poultry to an INTERNAL temperature of at least 180°F. Cooking to these temperatures usually protects against foodborne illness. For more information, see www.foodsafety.gov.

How to Convection Bake



1. Press CONV BAKE pad.
2. Turn the dial to set the temperature and press the dial to enter.
3. Press the dial to enter and confirm the selection.

To start cook time after preheat, select START PREHEAT. The oven will signal once the oven reaches the cooking temperature. Place the food in the oven and press the START/PAUSE pad. The cook time will begin to count down.

To start immediately without setting a cook time, select START or press the START/PAUSE pad:

If the oven door is opened during cooking, "Pause" or "Oven is Hot" will appear in the display. Close the door and press START/PAUSE pad.

To set a cook time:

1. Turn the dial and select COOK TIME.
2. Turn the dial to set the cook time and press the dial to enter.
3. To start the cook time immediately, place the food in the oven and select START COOK TIME. Then press the dial or the START/PAUSE pad to start. The cook time will immediately start to count down.

Cook times are shown in hours and minutes and can be set to a maximum of 2 hours 59 minutes. Time can be changed during cooking by turning the dial.

Cooking Tips for Convection Baking

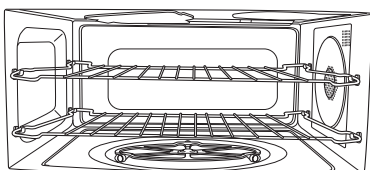

- Metal pans are recommended for all types of baked products, but especially where browning is important.
- Dark or dull finish metal pans are best for breads and pies because they absorb heat and produce crisper crust.
- Shiny aluminum pans are better for cakes, cookies or muffins because they reflect heat and help produce a light tender crust.
- Glass or glass-ceramic casserole or baking dishes are best suited for egg and cheese recipes due to the cleanability of glass.
- When baking on one level, use the lower level. The top clips are to only be used in two level baking.

Broiling and Toasting

Advantium Oven

Broiling and Toasting

Broil and toast use the upper lamps, lower heater and convection system to broil or toast food similar to a conventional oven.

Before you begin, make sure the turntable is in place. Use the metal tray when toasting and the metal tray or metal grill tray when broiling.



The turntable must always be in place when using the oven.

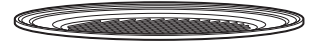

Put food directly on the metal tray or the metal grill tray.

CAUTION: Burn Risk

When broiling or toasting, remember that the oven cavity, the oven door and dishes will be very hot!

How to Broil

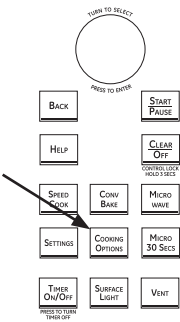

1. Press the COOKING OPTIONS pad.
2. Turn the dial to BROIL and press to enter.
3. Place the food in the oven and select START or press the START/PAUSE pad to start.

If the oven door is opened during cooking, "Pause" or "Oven is Hot" will appear in the display. Close the door and press the START/PAUSE pad.

Cooking Tips for Broiling

- Broiling times may be shorter in the Advantium oven because of the use of halogen lamps. Make sure to monitor food closely to get the desired results.
- For best results when broiling, place food directly on the metal grill tray.
- Broiling meats in the oven may produce smoke.
- If preheating the oven to broil meat, preheat with the metal grill tray in the oven and place food on the hot metal tray for best searing of meat.
- For best performance, preheat the oven for 5 minutes when broiling meat. Chicken performs best with no preheating.
- Foods should be turned halfway through broiling time.
- Remove thinner pieces as needed to prevent overcooking and drying.

How to Toast

1. Press the COOKING OPTIONS pad.
2. Turn the dial to TOAST and press to enter.
3. Turn the dial to set the toast time, place the food in the oven and select START or press the START/PAUSE pad to start.

If the oven door is opened during cooking, "Pause" or "Oven is Hot" will appear in the display. Close the door and press the START/PAUSE pad.

Cooking Tips for Toasting

- For best results when toasting, use the metal tray.
- No turning is necessary for most foods.
- When toasting nuts, stir halfway through the cooking time.
- Toast thicker pieces a longer time, thinner pieces a shorter time.

Warming

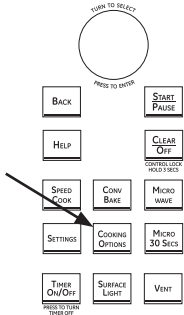

The WARM feature will keep hot, cooked foods at serving temperature. Always start with hot food. Use cookware and utensils that can withstand temperatures up to 230°F.

1. Press the COOKING OPTIONS pad.
2. Turn the dial to select WARM. Press the dial to enter.
3. Turn the dial to select the level of moisture you want. See the chart and tips below. Press the dial to enter.
4. Select START or press the START/PAUSE pad to start. The oven starts warming immediately and shows the amount of warming time to complete.

If the oven door is opened during warming, "Pause" or "Oven is Hot" will appear in the display. Close the door and press the START/PAUSE pad.

To Crisp Stale Items:

- Select the CRISP setting. Preheat the oven for 10 minutes.
 - NOTE:** Only preheat when crisping stale items.
- Place food or dishes directly on the metal tray.
- Check crispness after 45 minutes. Add time as needed.



The turntable must always be in place when using the oven.



Put food or oven-safe cookware directly on the metal tray to warm.

Temperature and Moisture Selection Chart

Food Type	Moisture Setting
Casseroles	MOIST
Chili/Soup	MOIST
Pancakes, waffles	MOIST
Pizza	CRISP
Potatoes, baked	CRISP
Chips/Crackers	CRISP

Tips for Crisp Foods:

- Leave food uncovered.
- Do not use plastic containers or plastic wrap.
- Preheating is not necessary except for crisping stale items. (See To Crisp Stale Items.)

Tips for Moist Foods:

- Cover food with lid or aluminum foil.
- Do not use plastic containers or plastic wrap.
- Preheating is not necessary.

Proofing



The turntable must always be in place when using the oven.



Put bread dough in a bowl/bread pan and place on the metal tray to proof.

The proofing feature automatically provides an appropriate temperature for the proofing process, and therefore does not have a temperature adjustment.

1. Press the COOKING OPTIONS pad.
 2. Turn the dial to select PROOF and press to enter.
 3. Select START or press the START/PAUSE pad to start. The oven starts proofing immediately and shows the amount of proofing time to complete.
- Check bread products early to avoid over-proofing.

- To avoid lowering the oven temperature and lengthening proofing time, do not open the oven door unnecessarily.

NOTES:

- Do not use the proofing mode for warming food or keeping food hot. The proofing oven temperature is not hot enough to hold foods at safe temperatures. Use the WARM feature to keep food warm.
- Proofing will not operate if the oven is too hot. Allow the oven to cool before proofing.

Using the microwave features

Make sure the turntable is in place. Use the clear glass tray.

Place food or microwavable container directly on the clear glass tray to cook your food.



The turntable must always be in place when using the oven.



The clear glass tray should always be in place when microwaving.

Cookware

- Make sure that cookware is suitable for microwaving.

MICROWAVE PRE-SET SELECTIONS

- Cook
 - By Food Type
 - By Time
 - By Time 1 & 2

- Defrost
 - 1.0 lb Quick
 - By Time
 - By Food Type
 - By Weight
 - Melt
 - Soften

- Beverage
 - Water (8 oz)
 - Coffee (8 oz)
 - Tea (8 oz)
 - Milk (8 oz)
 - Hot Cocoa (8 oz)

- Popcorn (2.9 or 3.5 oz)
- Melt
 - Butter
 - Caramel
 - Cheese
 - Chocolate Chips
 - Marshmallow

- Simmer
- Soft
 - Butter
 - Cream Cheese
 - Frosting (16 oz)
 - Ice Cream

- Reheat
 - Beverage
 - Casserole
 - Chicken
 - Pasta
 - Pizza
 - Plate of Food
 - Rice
 - Soup
 - Steaks/Chops
 - Vegetables

Things that are normal

Interference

- TV/radio interference might be noticed while using the microwave, similar to the interference caused by other small appliances. It does not indicate a problem with the microwave. Move the radio or TV as far away from the microwave as possible, or check the position of the TV/radio antenna.

Oven Heat

- Cookware may become hot because of heat transferred from the heated food. Oven mitts may be needed to handle the cookware.
- Steam or vapor may escape from around the door.

Cooking tips

- When cooking bacon, layer strips on a plate. Cover each layer with a paper towel.
- When cooking vegetables, use a microwave-safe casserole or bowl. Cover with a microwave-safe lid or vented plastic wrap.
- For frozen vegetables, follow the package instructions for adding water.
- For fresh vegetables, add 2 tablespoons of water for each serving.

Microwave power level(s)

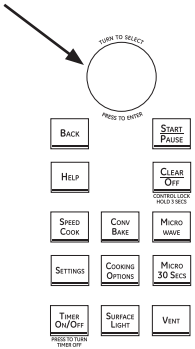

The microwave power level is automatically set on all microwave features but you can change it for COOK BY TIME, COOK BY TIME 1&2, MICRO 30 SEC, and DEFROST BY TIME.

1. First, follow directions for COOK BY TIME, COOK BY TIME 1 & 2, MICRO 30, or DEFROST BY TIME.
2. Select START or press the START/ PAUSE pad to start.
3. Press EDIT to change the cooking time and then the microwave power level. Press the dial to enter cooking time and power level changes.

Here are some examples of uses for various power levels:

High 10: Fish, bacon, vegetables, boiling liquids.

Med-High 7: Gentle cooking of meat and poultry; baking casseroles and reheating.

Medium 5: Slow cooking and tenderizing for stews and less tender cuts of meat.

Low 2 or 3: Defrosting; simmering; delicate sauces.

Warm 1: Keeping food warm; softening butter.

How to use pre-set microwave selections

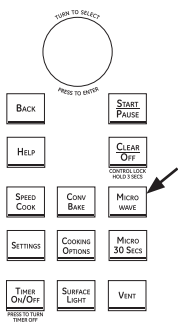

1. Press the MICROWAVE pad.

If no selection is made within 15 seconds, the display will revert back to the time of day.

2. Turn the dial to select COOK, DEFROST, BEVERAGE, POPCORN, MELT, REHEAT, SIMMER and SOFTEN.
3. Turn the dial to find the food you want to cook, defrost or reheat. Press the dial to enter.
4. Turn the selector dial to select the type, amount, weight and/or size as prompted by the oven. Press the dial after each selection.

5. Press the dial or the START/PAUSE pad to start cooking.

To review settings during cooking, press the selector dial.

If the door is opened during cooking, the oven will stop and PAUSE will appear in the display. Close the door and press START/ PAUSE to resume cooking.

If you enter an undesired selection at any time, simply press the BACK pad and re-enter the desired selections.

Cook By Time

Use COOK BY TIME to microwave food that is not in the pre-set microwave selections.

1. Press the MICROWAVE pad.
2. Turn the dial to select COOK BY TIME and press the dial to enter.
3. Turn the dial to set the cook time and press the dial to enter.

4. Turn the dial to set the power level and press the dial to enter.

5. Press the dial or the START/ PAUSE pad to start cooking.

You may open the door during COOK BY TIME to check the food. Close the door and press START/PAUSE to resume cooking.

Cook By Time 1 & 2

Use COOK BY TIME 1 & 2 to microwave food that requires two different times and power levels.

1. Press the MICROWAVE pad.
2. Turn the dial to select COOK and press the dial to enter.
3. Turn the dial to select COOK BY TIME 1 & 2 and press the dial to enter.

4. Turn the dial to set the first time and press the dial to enter. Repeat for the first power level, the second time, and the second power level.

5. Press the dial or the START/PAUSE pad to start cooking.

Micro 30 Secs

Press MICRO 30 SECS repeatedly for 30 second increments of microwave cooking time. Oven starts immediately.

The power level is automatically set at high, but you can change it for more flexibility. See *Microwave power levels* section for instructions.

My Recipes

See the MY RECIPE sections in the Speedcook section of this book for instructions on how to save, use, change or delete a microwave custom recipe.

Defrosting tips

Use DEFROST BY FOOD TYPE for meat, poultry, fish, and bread. Use DEFROST BY TIME for most other frozen foods.

- Foods frozen in paper or plastic can be defrosted in the package when using DEFROST BY TIME. Meats should be taken out of the package when using DEFROST BY FOOD TYPE. Closed packages should be slit, pierced or vented after food has partially defrosted. Plastic storage containers should be partially uncovered.
- Family-size, prepackaged frozen dinners can be defrosted and microwaved. If the food is in a foil container, transfer it to a microwave-safe dish.
- Foods that spoil easily should not be allowed to sit out for more than one hour after defrosting. Room temperature promotes the growth of harmful bacteria.
- When defrosted, food should be cool but softened in all areas. If still slightly icy, return to the microwave very briefly, or let it stand a few minutes.
- When defrosting 3 or more pounds of ground or cubed meat, remove defrosted portions at the turn signals.

Defrost by time

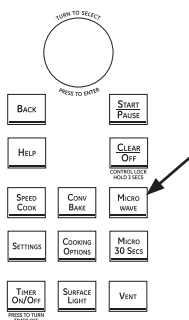

Use DEFROST BY TIME to defrost for a selected length of time.

1. Press the MICROWAVE pad.
2. Turn the selector dial to DEFROST. Press the dial to enter.
3. Turn the dial to DEFROST BY TIME. Press the dial to enter.
4. Turn the dial to select the time you want. Press the dial to enter.
5. Press the dial or START/PAUSE pad to start defrosting.
6. Turn the food over when the oven signals TURN FOOD OVER.

Power level is automatically set at 3, but can be changed. To change the power levels, see Microwave power levels for instructions.

You can defrost small items quickly by raising the power level after entering the time. Power level 7 cuts the total defrosting time in about half; power level 10 cuts the total time to about 1/3. When defrosting at high power levels, food will need more frequent attention than usual and may have some cooking.

Defrost by food type

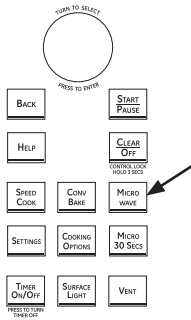

DEFROST BY FOOD TYPE automatically sets the defrosting times and power levels to give even defrosting results for meats, poultry and fish weighing up to 6 pounds.

1. Remove meat from the package and place it on a microwave-safe dish. Bread should be left in the package with any metal twist-ties removed.
2. Press the MICROWAVE pad.
3. Turn the dial to DEFROST. Press the dial to enter.
4. Turn the dial to DEFROST BY FOOD TYPE. Press the dial to enter.
5. Turn the dial to select food type. Press the dial to enter.
6. Turn the dial to the food weight, using the Conversion Guide at right. For example, dial 1.2 for 1.2 pounds (1 pound, 3 oz.) Press the dial to enter.
7. Press the dial or START/PAUSE pad to start defrosting.
8. Turn the food over when the oven signals TURN FOOD OVER.

- Remove defrosted meat or shield warm areas with small pieces of foil for even defrosting.
- After defrosting, most meats need to stand 5 minutes to complete defrosting. Large roasts should stand for about 30 minutes.

Conversion Guide

If the weight of food is stated in pounds and ounces, the ounces must be converted to tenths (.1) of a pound.

Weight of Food in Ounces	Enter Food Weight (tenths of a pound)
1-2	.1
3	.2
4-5	.3
6-7	.4
8	.5
9-10	.6
11	.7
12-13	.8
14-15	.9

Microwave sensor cooking tips

The Advantium’s microwave mode features sensor cooking and reheating. The oven automatically senses when food is done and shuts itself off—eliminating the need to program cook times and power levels.

The sensor feature detects the increasing humidity released during cooking. The oven automatically adjusts the cooking time to various types and amounts of food.

**▲ WARNING:
Fire Risk**

*Do not use the sensor features twice in succession on the same food portion—it may result in severely overcooked or burnt food. If food is undercooked after the first countdown, use **COOK BY TIME** for additional cooking time.*

The proper containers and covers are essential for best sensor cooking.

- Always use microwave-safe containers and cover them with lids or vented plastic wrap. Never use tight sealing plastic containers—they can prevent steam from escaping and cause food to overcook.
- Be sure the outside of the cooking containers and the inside of the oven are dry before placing food in the oven. Beads of moisture turning into steam can mislead the sensor.
- Popcorn and Potatoes are best heated uncovered.

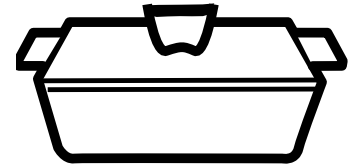

Covered

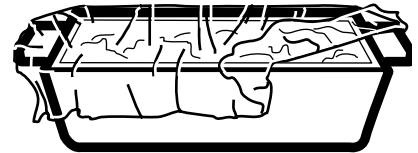

Vented



Dry off dishes so they don't mislead the sensor.

MICROWAVE SENSOR PROGRAMS

- | | |
|--|------------------------|
| ■ Ground Meat | ■ Chicken Reheat |
| ■ Popcorn
(Prepackaged microwave popcorn, 2.9 oz. to 3.5 oz.) | ■ Pasta Reheat |
| ■ Potato | ■ Plate of Food Reheat |
| ■ Rice | ■ Soup Reheat |
| ■ Soup | ■ Vegetable Reheat |
| ■ Vegetables (Canned, Fresh, Frozen) | ■ Simmer |

To use all sensor programs

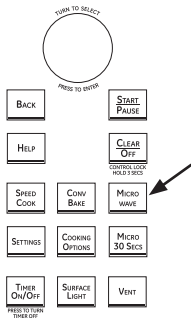

To use the sensor features:

1. Press the MICROWAVE pad.
2. Turn the dial to select COOK BY FOOD (located under COOK), REHEAT, or SIMMER.
3. For COOK BY FOOD and REHEAT, select a food and press the dial to enter. For SIMMER, set the time to simmer after the soup, sauce or stew has come to a boil.
4. Press the dial or press the START/ PAUSE pad to start cooking.

Do not open the oven door until time is counting down on the display. If you open the door while sensor cooking, "Sensor Error - Close door and press START" will appear. Close the door immediately and press the START/PAUSE pad to begin again.

⚠ WARNING:
Fire Risk

Do not use a sensor feature twice in succession on the same food portion—it may result in severely overcooked or burnt food. If the food is not done enough at the end of the sensor cook time, use COOK BY TIME in the microwave selector to cook for more time.

- If you have been cooking and the oven is hot, it may indicate that it is too hot for sensor cooking. In that case, the oven will automatically change to time cooking and may prompt for weights or amounts of food.
- To shorten or lengthen the cook time, wait until the time countdown shows in the display. Then turn the dial to add or subtract time.

Notes about the Reheat program:

Reheated foods may have wide variations in temperature. Some areas may be extremely hot.

It is best to use COOK BY TIME and not REHEAT for these foods:

- Bread products
- Food that must be reheated uncovered
- Foods that need to be stirred or turned
- Foods calling for a dry look or crisp surface after reheating

How to adjust the oven's automatic COOK BY FOOD and REHEAT settings for a shorter or longer cook time (not available for all food types):

To reduce the automatic cooking times: Right after the oven starts, turn the dial counterclockwise until a minus ("-") sign or a double minus ("--") sign appears and press the dial to enter. A minus ("-") sign is a 10% reduction of cooking time and a double minus ("--") sign is a 20% reduction of cooking time.

To increase the automatic cooking times: Right after the oven starts, turn the dial clockwise until a plus ("+") sign or a double plus ("++") sign appears and press the dial to enter. A plus ("+") sign is a 10% increase of cooking time and a double plus ("++") sign is a 20% increase of cooking time.

Cooking Complete

To remind you that you have food in the oven, the oven will display the cooking mode and COOKING COMPLETE and beep

once a minute until you either open the oven door or press the CLEAR/OFF pad.

Other Advantium Features

Advantium Oven

Clock	The clock must be set before you can use your oven for the first time. When setting the clock time for the first time go directly to step two.	<ol style="list-style-type: none">1. To change the clock time, press the SETTINGS pad and turn the dial to CLOCK SETTINGS. Select SET TIME.2. Turn the dial to set hours. Press the dial to enter. Note: Setting hours sets AM/PM.3. Turn the dial to set minutes. Press the dial to enter.
Auto Conversion	Auto conversion automatically reduces the convection baking temperature. You still input the recipe temperature and the oven control does the rest.	To change the setting, press the SETTINGS pad and turn the dial to AUTO CONVERSION. Press the dial to enter. Turn the dial to change the setting to CONVERSION ON or CONVERSION OFF. Press the dial to enter.
Display On/Off	Use this feature to turn your clock display on or off.	Press the SETTINGS pad, turn the dial to select DISPLAY ON/OFF. Turn the dial to select CLOCK DISPLAY ON or CLOCK DISPLAY OFF. Press the dial to enter.
Beeper Volume	Use this feature to adjust the volume of the beeper. You can even turn it off.	Press the SETTINGS pad, turn the dial to select BEEPER VOLUME, press the dial to enter. Select the beeper volume, press the dial to enter.
Reminder	Use this feature to set an alarm beep to sound at a specific time of day. <ol style="list-style-type: none">1. Press the SETTINGS pad, turn the dial to select REMINDER and press the dial to enter.2. Select SET REMINDER and press the dial to enter.3. Turn the dial to set the time hour and minutes, press the dial to enter. NOTE: Setting the hours set AM/PM.	To turn off the Reminder, press the SETTINGS pad, turn the dial to select REMINDER and press the dial to enter. Turn the dial to select CLEAR REMINDER and press the dial to enter. To check the Reminder time, press the SETTINGS pad, turn the dial to select REMINDER and press the dial to enter. Turn the dial to select REVIEW REMINDER and press the dial to enter. The display will show the Reminder time.
Turntable On/OFF	Use this feature to keep the turntable from turning when using a dish is too large to rotate in the cavity. Press the SETTINGS pad, turn the dial to select TURNTABLE ON/OFF and press the dial to enter. Turn the dial to select TURNTABLE ON or TURNTABLE OFF, press the dial to enter.	Note: <ul style="list-style-type: none">• The turntable will not turn off in Speedcook, Broil, Toast, or Microwave Sensor modes.• If TURNTABLE OFF is selected while cooking, the turntable will be shut off until the end of the cooking time. The turntable will turn back on the next cooking cycle and if the RESUME feature is used.• If TURNTABLE OFF is selected before starting cooking, the turntable will remain off for any cooking that starts within the next 5 minutes. After 5 minutes, the turntable will automatically return to TURNTABLE ON.

Auto Night Light

Use this feature to set the surface light to come on and go off at a certain time.

1. Press the SETTINGS pad, turn the dial to select AUTO NIGHT LIGHT and press the dial to enter.
2. Select SET ON TIME and press the dial to enter.
3. Turn the dial to set on time hour and minutes, press the dial to enter. Turn the dial to set off time hour and minutes, press the dial to enter. Note: Setting the hours sets AM/PM.

To permanently turn off the Auto Night Light, press the SETTINGS pad, turn the dial to select AUTO NIGHT LIGHT and press the dial to enter. Turn the dial to select DEACTIVATE and press the dial to enter.

To check the Auto Night Light on and off times, press the SETTINGS pad, turn the dial to select AUTO NIGHT LIGHT and press the dial to enter. Turn the dial to select REVIEW ON/OFF TIMES and press the dial to enter. The display will show the on and off time for the Auto Night light.

Note:

If the SURFACE LIGHT pad is pressed while the Auto Night Light is on, the surface light is taken out of Auto Night Light for that one time. The SURFACE LIGHT pad must be pressed to turn off the surface light. Auto Night Light will turn on again at the next scheduled time.

If the surface light is already on when Auto Night Light is scheduled to turn on, the surface light will not use the Auto Night Light settings. The SURFACE LIGHT pad must be pressed to turn off the surface light. Auto Night Light will turn on again at the next scheduled time.

Temperature Units

To change temperature units, press the SETTINGS pad and select TEMPERATURE UNITS. Turn the dial to select F or C and press the dial to enter.

Delay Start

Use this feature to delay when the oven will start cooking in CONV BAKE, COOK BY TIME, COOK BY TIME 1&2, DEFROST BY TIME, or DEFROST BY WEIGHT.

1. Press the COOKING OPTIONS pad.
2. Turn the dial to select DELAY START and press the dial to enter.
3. Turn the dial to set the start time hour and minutes, press the dial to enter. NOTE: Setting the hours sets AM/PM.
4. Set the cooking mode.

The oven will start the programmed cooking mode when the clock time and the delay start time are the same.

Help

Use this feature to find out more about your oven and its features.

The display will show a description for the program you have chosen. Use the dial to scroll up or down to read the description.

1. Press the HELP pad.
2. Turn the dial to select the feature name. Press the dial to enter.

Features found in the HELP function.

Adding Time	Cooking Options	Repeat Last
Auto Conversion	Defrost	Resume
Auto Night Light	Defrost by Food	Sensor Cooking
Back	Defrost by Time	Simmer
Beeper Volume	Defrost by Weight	Soften
Beverage	Delay Start	Speed Cook
Broil	Display ON/OFF	Start/PAUSE
Clear/Off	Edit	Temperature Units
Clock	Help	Timer On/Off
Control Lockout	Melt	Turntable ON/OFF
Conv Bake	Micro 30 Secs	Toast
Cook	Microwave	Warm
Cook by Food Type	My Recipes	
Cook by Time	Proof	
Cook by Time 1 & 2	Reheat	
	Reminder	

Control lock-out

You may lock the control panel to prevent the oven from being accidentally started during cleaning or being used by children.

When the control panel is locked, CONTROL IS LOCKED will be displayed briefly anytime a pad or dial is pressed.

Press and hold CLEAR/OFF for 3 seconds to lock and unlock.

Timer

Use this feature anytime you need a general purpose timer. It can even be used while cooking in the oven.

3. Turn the dial to select the seconds. Press the dial to enter.

1. Press the TIMER pad.
2. Turn the dial to select the minutes. Press the dial to enter.

To cancel, press the TIMER pad.

Automatic fans

Cooling fans automatically turn on as required to keep the internal oven components and control from overheating.

The fans will automatically turn off when the internal parts are cool. One or more may stay on for 5 minutes or more after the oven control is turned off.

The vent fan may come on automatically if the oven gets too hot, even if the oven isn't running. The screen will display: "Normal Operation. Fan is on due to high heat. Fan will shut off automatically."

Surface Light

Use to light your cooktop.
Press the SURFACE LIGHT pad to change from bright to night to off.

Vent Fan

The vent fan removes steam and other vapors from surface cooking.
Press the VENT FAN pad to change from high to medium to low to off.

The vent fan may come on automatically if the oven gets too hot, even if the oven isn't running. The screen will display: "Normal Operation. Fan is on due to high heat. Fan will shut off automatically."

How to clean the inside of the oven

Be certain the oven control is turned off and the oven is warm or cool to the touch before cleaning any part of this oven.

Clean the inside of the oven often for proper heating performance.

Some spatters can be removed with a paper towel, others may require a warm soapy cloth. Remove greasy spatters with a sudsy cloth, then rinse with a damp cloth.

If the dirt and spatter do not come off easily with a warm sudsy cloth, place a medium sized bowl full of water in the unit on the metal tray and press the SPEEDCOOK pad. Select MY RECIPE and set for 10 minutes at U=10, L=10, M=7, C=10. This should loosen the dirt in the oven so that it can be removed with a warm sudsy cloth.

If you notice yellowing on the metal inside the oven that cannot be removed with a warm sudsy cloth, use a stainless steel cleaner that removes heat discoloration and/or tarnishing. You can then clean the inside of the oven as you normally do.

Do not use abrasive cleaners or sharp utensils on oven walls.

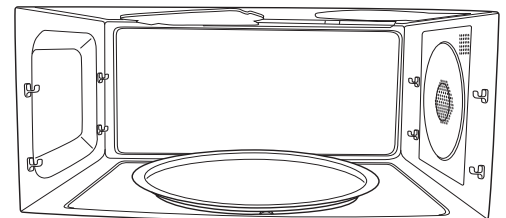

Never use a commercial oven cleaner on any part of your oven.

Do not clean the inside of the oven with metal scouring pads. Pieces can break off the pad inside the oven, causing electrical shock as well as damaging the inside surface finish of the oven.

Removable turntable

The area underneath the turntable should be cleaned frequently to avoid odors and smoking during a cooking cycle.

The turntable can be broken if dropped. Wash carefully in warm, sudsy water. Dry completely and replace.

To replace the turntable, place its center over the spindle in the center of the oven and turn it until it seats into place.



Turntable

Do not use the oven without the turntable in place.

Cooking trays and wire oven rack

To prevent breakage, allow the trays to cool completely before cleaning. Wash carefully in hot, sudsy water or in the dishwasher.

Do not use abrasives to clean the glass tray or wire oven rack, as they may damage the finish.

A plastic scrubbing pad may be used to clean the metal trays.



Clear glass tray

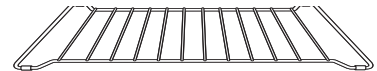

Wire oven rack



Metal tray



Metal grill tray

Halogen lamp cover and mica sheet

Do not remove the halogen lamp glass cover or the mica sheet.

The upper halogen lamp cover must be kept free of grease and food splatterings in order to operate effectively.

Clean the lamp glass cover and mica sheet often to avoid excess smoking and decreased cooking power.

To clean the upper lamp cover: Allow the oven and glass cover to cool completely. Wipe clean with a warm soapy cloth or plastic scrubbie.

For heavy burned on soil, a cleaning scraper may be used to clean the halogen lamp cover. Hold the cleaning scraper at a 30° angle. Scrape the glass clean and wipe up excess soil.

To clean the mica sheet: Allow the oven to cool completely. Wipe clean with a warm soapy cloth.

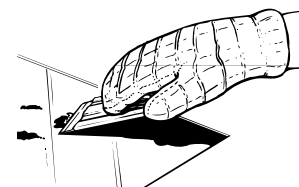
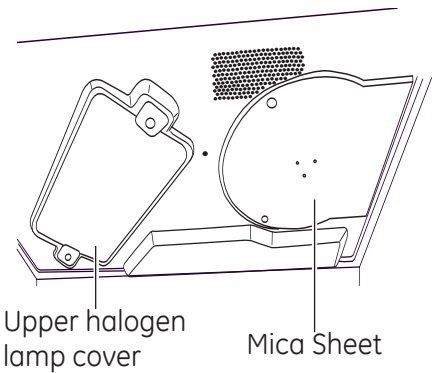

For heavy or burned on soil

How to clean the outside of the oven

We recommend against using cleaners with ammonia or alcohol, as they can damage the appearance of the oven. If you choose to use a common household cleaner, first apply the cleaner directly to a clean cloth, then wipe the soiled area.

Case

Clean the outside of the microwave with a sudsy cloth. Rinse and then dry. Wipe the window clean with a damp cloth.

Control Panel

Wipe with a damp cloth. Dry thoroughly. Do not use cleaning sprays, large amounts of soap and water, abrasives or sharp objects on the panel - they can damage it. Some paper towels can also scratch the control panel.

Stainless Steel Surfaces (on some models)

The stainless steel panel can be cleaned with Stainless Steel Magic or a similar product using a clean, soft cloth. Apply stainless cleaner carefully, avoiding the surrounding plastic or glass parts. Do not use appliance wax, polish, bleach or products containing chlorine on stainless steel.

Plastic Color Panels (on some models)

Use a clean, soft, lightly dampened cloth, then dry thoroughly.

Door Seal

It's important to keep the area clean where the door seals against the oven. Use only mild, non-abrasive detergents applied with a clean sponge or soft cloth. Rinse well.

Bottom

Clean off the grease and dust on the bottom often. Use a solution of warm water and detergent.

Surface light

1. To replace the surface light, first disconnect the power at the main fuse or circuit breaker panel.
2. Remove the screw from the side of the light compartment cover and lower the cover until it stops.
3. Be sure the bulb to be replaced is cool before removing. Gently pull the bulb from the receptacle.

Replace with a 120 volt, 50-watt halogen bulb. Order WB08X10051 from your GE supplier.

4. Raise the light cover and replace the screw. Connect electrical power to the oven.

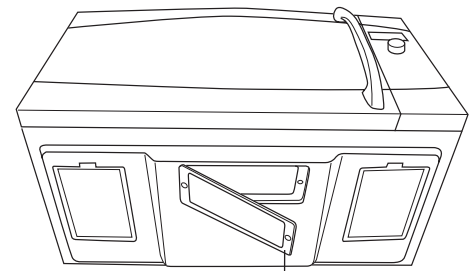

Remove screw

Removing and cleaning the filters

1. The metal filters trap grease released by foods on the cooktop. They also prevent flames from foods on the cooktop from damaging the inside of the oven.
2. For this reason, the filters must always be in place when the hood is used. The vent filters should be cleaned once a month, or as needed.
3. To remove, slide them to the rear using the tabs. Pull down and out.
4. To clean the vent filters, soak them and then swish around in hot water and detergent. Don't use ammonia or ammonia products because they will darken the metal. Light brushing can be used to remove embedded dirt.
5. Rinse, shake and let dry before replacing.
6. To replace, slide the filters into the frame slots on the back of each opening. Press up and to the front to lock into place.

To replace oven cavity lamp

1. Disconnect power at the main fuse or circuit breaker panel.
2. Remove the top grill by removing the two screws that hold it in place.
3. Remove charcoal filter if present. Slide the filter toward the left and pull toward the front to remove.
NOTE: Charcoal filter is an optional kit, you may not have one.
4. Remove the screw holding the lamp shield in place.
5. Pull the lamp shield out. Pull the light bulb out and replace with the 120V-130V, 20W halogen bulb. Order WB25X10019 from your GE supplier.
6. Return the lamp and lamp shield to original position and replace screw and charcoal filter.
7. Replace the grill and 2 screws. Reconnect power to the oven

Charcoal filter (JX81D - optional kit)

If the model is not vented to the outside, the air will be recirculated through a disposable charcoal filter that helps remove smoke and odors.

The charcoal filter cannot be cleaned. It must be replaced. Order Part No. WB2X9883 from your GE supplier.

The charcoal filter should be replaced when it is noticeably dirty or discolored (usually after 6 to 12 months, depending on usage).

To install the charcoal filter

To install a new filter:

1. Remove plastic and other outer wrapping from the new filter.
2. Remove the top grill by removing the two screws that hold it in place.
3. Insert the filter into the top opening of the oven as shown.
4. It will rest at an angle on two back support tabs and in front by two tabs.
5. Replace the grill and two screws.

To remove the filter, repeat step 2 above, remove the filter and repeat step 5.

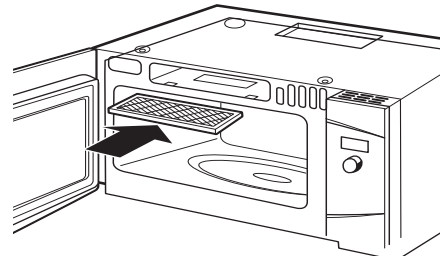

Questions?
Use this
problem
solver

Problem	Possible Causes	What To Do/Explanation
LIGHTS		
Light during a speedcook cycle dims and cycles on and off, even at full power levels.	This is normal. Power level has been automatically reduced because the oven is hot.	<ul style="list-style-type: none"> This is normal. The oven senses the heat level and adjusts automatically.
Light visible around the door and outer case while speedcooking.	This is normal.	<ul style="list-style-type: none"> When the oven is on, light may be visible around the door and outer case.
FAN		
Fan continues to run after cooking stops.	The oven is cooling.	<ul style="list-style-type: none"> The fan will automatically shut off when the internal parts of the oven have cooled.
Oven vent emits warm air while oven is on.	This is normal.	
Vent fan comes on automatically when oven not in use.	This is normal.	<ul style="list-style-type: none"> If the cooktop or oven gets hot enough the vent fan comes on. (see <i>Automatic Fan section</i>.)
Fan comes on automatically when using the microwave.	This is normal.	<ul style="list-style-type: none"> If the microwave is used after speedcook and the oven senses that it is too hot, the vent fan comes on to cool the oven.
The oven makes unusual sounds while cooking.	Clicks and fans blowing are normal. The relay board is turning the components on and off.	<ul style="list-style-type: none"> These sounds are normal.
Fan sound changes while cooking.	This is normal.	<ul style="list-style-type: none"> Fan may turn on or off during cooking to maintain cooking temperature.
COOKING		
Smoke comes out of the oven when the door is opened.	Food is high in fat content. Aerosol spray used on the pans.	<ul style="list-style-type: none"> Smoke is normal when cooking high-fat foods. Use vegetable oil or olive oil on the meat itself instead of coating the entire pan.
Food is not fully cooked or browned at the end of a cooking program.	Programmed times may not match the size or amount of food you are cooking.	<ul style="list-style-type: none"> Increase or decrease time for doneness or adjust the upper or lower lamps for browning.

Questions?
Use this
problem
solver

Problem	Possible Causes	What To Do/Explanation
DISPLAY		
The display is blank.	The display has been turned off.	<ul style="list-style-type: none"> Check the SETTINGS menu for clock display settings. Turn the display on.
“Control Panel LOCKED” appears in display.	The control has been locked.	<ul style="list-style-type: none"> Press and hold CLEAR/OFF for about 3 seconds to unlock the control. See <i>Other Features Section</i>.
Control display is lighted yet oven will not start.	Clock is not set.	<ul style="list-style-type: none"> Follow prompts to set the clock.
	Door not securely closed.	<ul style="list-style-type: none"> Open the door and close securely.
	START/PAUSE pad not pressed after entering cooking selection.	<ul style="list-style-type: none"> Follow prompts
	Delay Start was accidentally set.	<ul style="list-style-type: none"> Press CLEAR/OFF and reset.
	Oven is in DEMO Mode	<ul style="list-style-type: none"> Unplug the oven for 1 minute, plug the oven back into the wall DO NOT set the oven clock, press and hold the HELP and START/PAUSE pads for 3 seconds. The control should exit DEMO mode. Set clock and continue.
	CLEAR/OFF was pressed accidentally.	<ul style="list-style-type: none"> Reset cooking program and press START/PAUSE.
OTHER PROBLEMS		
The door and inside of the oven feels hot.	The oven produces intense heat in a small space.	<ul style="list-style-type: none"> This is normal. Use oven mitts to remove food when ready.
Floor of the oven is warm, even when the oven has not been used.	The cooktop light is located below the oven floor. When the light is on, the heat it produces may make the oven floor get warm.	<ul style="list-style-type: none"> This is normal.
Oven will not start.	A fuse in your home may be blown or the circuit breaker tripped.	<ul style="list-style-type: none"> Replace fuse or reset circuit breaker.
	Power surge.	<ul style="list-style-type: none"> Unplug the oven, then plug it back in.
	Plug not fully inserted into wall outlet.	<ul style="list-style-type: none"> Make sure the plug on the oven is fully inserted into wall outlet.
Glass microwave tray does not lock into center hub.		<ul style="list-style-type: none"> Align the protrusions on the bottom of the glass microwave tray with the indentation in the turntable. This fit is not tight, some movement is normal.

Advantium Oven Warranty

Advantium Oven

All warranty service provided by our Factory Service Centers, or an authorized Customer Care® technician. To schedule service, online, contact us at GEAppliances.com, or call 800.GE.CARES (800.432.2737). Please have serial and model numbers available when calling for service.

Staple your receipt here. Proof of the original purchase date is needed to obtain service under the warranty.

For The Period Of:	GE Will Replace:
One Year From the date of the original purchase	Any part of the oven which fails due to a defect in materials or workmanship. During this limited one-year warranty , GE will also provide, free of charge , all labor and related service costs to replace the defective part.
Five Years From the date of the original purchase	The magnetron tube, if the magnetron tube fails due to a defect in materials or workmanship. During this five-year limited warranty, you will be responsible for any labor or in-home service costs.

What GE Will Not Cover:

- Service trips to your home to teach you how to use the product.
- Improper installation, delivery or maintenance.
- Product not accessible to provide required service.
- Failure of the product or damage to the product if it is abused, misused (for example, cavity arcing from wire rack or metal/foil), or used for other than the intended purpose or used commercially.
- Replacement of house fuses or resetting of circuit breakers.
- Replacement of the cooktop light bulbs.
- Damage to the product caused by accident, fire, floods or acts of God.
- Incidental or consequential damage caused by possible defects with this appliance.
- Damage caused after delivery.

EXCLUSION OF IMPLIED WARRANTIES—Your sole and exclusive remedy is product repair as provided in this Limited Warranty. Any implied warranties, including the implied warranties of merchantability or fitness for a particular purpose, are limited to one year or the shortest period allowed by law.

This warranty is extended to the original purchaser and any succeeding owner for products purchased for home use within the USA. If the product is located in an area where service by a GE Authorized Servicer is not available, you may be responsible for a trip charge or you may be required to bring the product to an Authorized GE Service Location for service. In Alaska, the warranty excludes the service calls to your home.

Some states do not allow the exclusion or limitation of incidental or consequential damages. This warranty gives you specific legal rights, and you may also have other rights which vary from state to state. To know what your legal rights are, consult your local or state consumer affairs office or your state's Attorney General.

Warrantor: General Electric Company, Louisville, KY 40225

GE Appliances Web site

GEAppliances.com

Have a question or need assistance with your appliance? Try the GE Appliances Web site any day of the year! For greater convenience and faster service, you can now download Owner's Manuals, order parts or even schedule service on-line.

Schedule Service

GEAppliances.com

Expert GE repair service is only one step away from your door. Get on-line and schedule your service at your convenience any day of the year! Or call 800.GE.CARES (800.432.2737) during normal business hours.

Real Life Design Studio

GEAppliances.com

GE supports the Universal Design concept—products, services, and environments that can be used by people of all ages, sizes, and capabilities. We recognize the need to design for a wide range of physical and mental abilities and impairments. For details of GE's Universal Design applications, including kitchen design ideas for people with disabilities, check out our Web site today. For the hearing impaired, please call 800.TDD.GEAC (800.833.4322).

Extended Warranties

GEAppliances.com

Purchase a GE extended warranty and learn about special discounts that are available while your warranty is still in effect. You can purchase it on-line anytime or call 800.626.2224 during normal business hours. GE Consumer Home Services will still be there after your warranty expires.

Parts and Accessories

GEAppliances.com

Individuals qualified to service their own appliances can have parts or accessories sent directly to their homes (VISA, MasterCard, and Discover cards are accepted). Order on-line today, 24 hours every day, or by phone at 800.626.2002 during normal business hours.

Instructions contained in this manual cover procedures to be performed by any user. Other servicing generally should be referred to qualified service personnel. Caution must be exercised, since improper servicing may cause unsafe operation.

Contact Us

GEAppliances.com

If you are not satisfied with the service you receive from GE, contact us on our Web site with all the details, including your phone number, or write to:

General Manager, Customer Relations
GE Appliances, Appliance Park
Louisville, KY 40225

Register Your Appliance

GEAppliances.com

Register your new appliance on-line—at your convenience! Timely product registration will allow for enhanced communication and prompt service under the terms of your warranty, should the need arise. You may also mail in the preprinted registration card included in the packing material.