

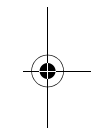

Installation and Operating Guide

Model Numbers | Z32LC6D, Z37LC6D | LCD TV

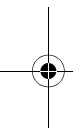

ENERGY STAR is a set of power-saving guidelines issued by the U.S. Environmental Protection Agency (EPA).



As an ENERGY STAR Partner LGE U. S. A., Inc. has determined that this product meets the ENERGY STAR guidelines for energy efficiency.



© Copyright 2008, LG Electronics USA, Inc.



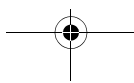
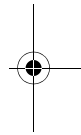
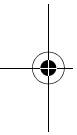

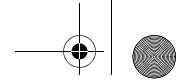



WARNING / CAUTION



WARNING / CAUTION
 RISK OF ELECTRIC SHOCK
 DO NOT OPEN



TO REDUCE THE RISK OF ELECTRIC SHOCK
DO NOT REMOVE COVER (OR BACK). NO
USER SERVICEABLE PARTS INSIDE. REFER TO
QUALIFIED SERVICE PERSONNEL.

 The lightning flash with arrowhead symbol, within an equilateral triangle, is intended to alert the user to the presence of uninsulated "dangerous voltage" within the product's enclosure that may be of sufficient magnitude to constitute a risk of electric shock to persons.

 The exclamation point within an equilateral triangle is intended to alert the user to the presence of important operating and maintenance (servicing) instructions in the literature accompanying the appliance.

WARNING / CAUTION

To prevent fire or shock hazards, do not expose this product to rain or moisture.

FCC NOTICE

Class B digital device

This equipment has been tested and found to comply with the limits for a Class B digital device, pursuant to Part 15 of the FCC Rules. These limits are designed to provide reasonable protection against harmful interference in a residential installation. This equipment generates, uses and can radiate radio frequency energy and, if not installed and used in accordance with the instructions, may cause harmful interference to radio communications. However, there is no guarantee that interference will not occur in a particular installation. If this equipment does cause harmful interference to radio or television reception, which can be determined by turning the equipment off and on, the user is encouraged to try to correct the interference by one or more of the following measures:

- Reorient or relocate the receiving antenna.
- Increase the separation between the equipment and receiver.
- Connect the equipment to an outlet on a circuit different from that to which the receiver is connected.
- Consult the dealer or an experienced radio/TV technician for help.

Any changes or modifications not expressly approved by the party responsible for compliance could void the user's authority to operate the equipment.

WARNING/CAUTION

TO REDUCE THE RISK OF FIRE AND ELECTRIC SHOCK, DO NOT EXPOSE THIS PRODUCT TO RAIN OR MOISTURE.

NOTE TO CABLE/TV INSTALLER

This reminder is provided to call the CATV system installer's attention to Article 820-40 of the National Electric Code (U.S.A.). The code provides guidelines for proper grounding and, in particular, specifies that the cable ground shall be connected to the grounding system of the building, as close to the point of the cable entry as practical.

CAUTION

Do not attempt to modify this product in any way without written authorization from LG Electronics. Unauthorized modification could void the user's authority to operate this product.

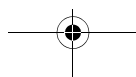
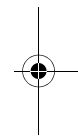
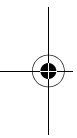

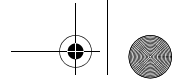

SAFETY INSTRUCTIONS

IMPORTANT SAFETY INSTRUCTIONS

Important safety instructions shall be provided with each apparatus. This information shall be given in a separate booklet or sheet, or be located before any operating instructions in an instruction for installation for use and supplied with the apparatus.

This information shall be given in a language acceptable to the country where the apparatus is intended to be used. The important safety instructions shall be entitled "Important Safety Instructions". The following safety instructions shall be included where applicable, and, when used, shall be verbatim as follows. Additional safety information may be included by adding statements after the end of the following safety instruction list. At the manufacturer's option, a picture or drawing that illustrates the intent of a specific safety instruction may be replaced immediately adjacent to that safety instruction:

Read these instructions.
Keep these instructions.
Heed all warnings.
Follow all instructions.



- 1** Do not use this apparatus near water.

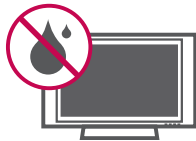

- 2** Clean only with dry cloth.



- 3** Do not block any ventilation openings. Install in accordance with the manufacturer's instructions.

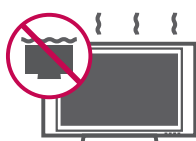

- 4** Do not install near any heat sources such as radiators, heat registers, stoves, or other apparatus (including amplifiers) that produce heat.



- 5** When mounting a TV on the wall, make sure not to install TV by hanging power and signal cables on the back of the TV.

- 6** Do not defeat the safety purpose of the polarized or grounding-type plug. A polarized plug has two blades with one wider than the other. A grounding type plug has two blades and a third grounding prong. The wide blade or the third prong are provided for your safety. If the provided plug does not fit into your outlet, consult an electrician for replacement of the obsolete outlet.



- 7** Protect the power cord from being walked on or pinched particularly at plugs, convenience receptacles, and the point where they exit from the apparatus.



- 8** Only use attachments/accessories specified by the manufacturer.



- 9** Unplug this apparatus when unused for long periods of time.

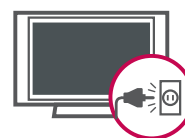

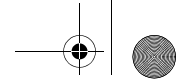

- 10** Use only with the cart, stand, tripod, bracket, or table specified by the manufacturer, or sold with the apparatus. When a cart is used, use caution when moving the cart/apparatus combination to avoid injury from tip-over.



S3125A

- 11** Never touch this apparatus or antenna during a thunder or lightning storm.
- 12** Do not allow an impact shock or any objects to fall into the product, and do not drop onto the screen with something.
- 13** Refer all servicing to qualified service personnel. Servicing is required when the apparatus has been damaged in any way, such as power-supply cord or plug is damaged, liquid has been spilled or objects have fallen into the apparatus, the apparatus has exposed to rain or moisture, does not operate normally, or has been dropped.



- 14** **CAUTION concerning the Power Cord :**
Most appliances recommend they be placed upon a dedicated circuit; that is, a single outlet circuit which powers only that appliance and has no additional outlets or branch circuits. Check the specification page of this owner's manual to be certain.
Do not overload wall outlets. Overloaded wall outlets, loose or damaged wall outlets, extension cords, frayed power cords, or damaged or cracked wire insulation are dangerous. Any of these conditions could result in electric shock or fire. Periodically examine the cord of your appliance, and if its appearance indicates damage or deterioration, unplug it, discontinue use of the appliance, and have the cord replaced with an exact replacement part by an authorized servicer.

Protect the power cord from physical or mechanical abuse, such as being twisted, kinked, pinched, closed in a door, or walked upon. Pay particular attention to plugs, wall outlets, and the point where the cord exits the appliance.



- 15** **Outdoor use marking :**
WARNING - To reduce the risk of fire or electric shock, do not expose this appliance to rain or moisture.



- 16** **Wet Location Marking :** Apparatus shall not be exposed to dripping or splashing and no objects filled with liquids, such as vases, shall be placed on or over apparatus.



- 17** **GROUNDING**
Ensure that you connect the earth ground wire to prevent possible electric shock. If grounding methods are not possible, have a qualified electrician install a separate circuit breaker.
Do not try to ground the unit by connecting it to telephone wires, lightning rods, or gas pipes.

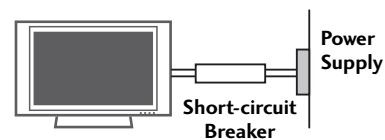

- 18** **DISCONNECTING DEVICE FROM MAINS**
Mains plug is the disconnecting device. The plug must remain readily operable.

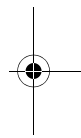
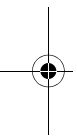

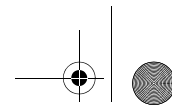

CONTENTS

WARNING / CAUTION1
SAFETY INSTRUCTIONS2
FEATURE OF THIS TV6

PREPARATION

ACCESSORIES7
FRONT PANEL INFORMATION8
BACK PANEL INFORMATION9
STAND INSTALLATION10
VESA WALL MOUNTING11
DESKTOP PEDESTAL INSTALLATION11
CABLE MANAGEMENT12
ATTACHING THE TV TO A DESK13
SECURING THE TV TO THE WALL TO PREVENT FALLING14
ANTENNA OR CABLE CONNECTION15

EXTERNAL EQUIPMENT SETUP

HD RECEIVER SETUP16
DVD SETUP19
VCR SETUP21
OTHER A/V SOURCE SETUP23
PC SETUP24
AUDIO OUT CONNECTION29

WATCHING TV / CHANNEL CONTROL

REMOTE CONTROL FUNCTIONS30
TURNING ON TV32
CHANNEL SELECTION32
VOLUME ADJUSTMENT32
ON-SCREEN MENUS SELECTION33
CHANNEL SETUP34
- Auto Scan (Auto Tuning)34
- Add/Delete Channel (Manual Tuning)35
- Channel Editing36
INPUT LIST37
INPUT LABEL38
KEY LOCK39

PICTURE CONTROL

PICTURE SIZE (ASPECT RATIO) CONTROL40
PRESET PICTURE SETTINGS41
- Picture Mode - Preset41
- Color Tone - Preset42
MANUAL PICTURE ADJUSTMENT43
- Picture Mode - User Mode43
- Color Tone - User Mode44
DB - PICTURE IMPROVEMENT TECHNOLOGY 45
ADVANCED - CINEMA 3:2 PULL DOWN MODE46
ADVANCED - BLACK (DARKNESS) LEVEL47
PICTURE RESET48

SOUND & LANGUAGE CONTROL

AUTO VOLUME LEVELER (AUTO VOLUME)49
PRESET SOUND SETTINGS (SOUND MODE) ...50
SOUND SETTING ADJUSTMENT - USER MODE51
BALANCE52
TV SPEAKERS ON/OFF SETUP53
STEREO/SAP BROADCASTS SETUP54
AUDIO LANGUAGE55
ON-SCREEN MENUS LANGUAGE SELECTION ..56
CAPTION MODE57
- Analog Broadcasting System Captions58
- Digital Broadcasting System Captions59
- Caption Option60



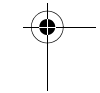
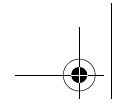

TIME SETTING

CLOCK SETTING 61

- Auto Clock Setup 61
- Manual Clock Setup 62

AUTO ON/OFF TIMER SETTING 63

SLEEP TIME SETTING 64

AUTO SHUT-OFF SETTING 65

PARENTAL CONTROL / RATINGS

SET PASSWORD & LOCK SYSTEM 66

CHANNEL BLOCKING 68

EXTERNAL INPUT BLOCKING 68

MOVIE & TV RATING 69

DOWNLOADABLE RATING 71

APPENDIX

TROUBLESHOOTING 72

MAINTENANCE 74

PRODUCT SPECIFICATIONS 75

PROGRAMMING THE REMOTE CONTROL 76

IR CODES 79

EXTERNAL CONTROL THROUGH RS-232C 81

OPEN SOURCE LICENSE 88

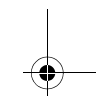
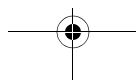
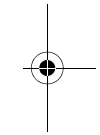
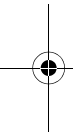



FEATURE OF THIS TV



High-definition television. High-resolution digital television broadcast and playback system composed of roughly a million or more pixels, 16:9 aspect-ratio screens, and AC3 digital audio. A subset of digital television, HDTV formats include 1080i and 720p resolutions.



HDMI™, the HDMI logo and High-Definition Multimedia Interface are trademarks or registered trademarks of HDMI Licensing.”



Manufactured under license from Dolby Laboratories. “Dolby” and the double-D symbol are trademarks of Dolby Laboratories.



SRS is a trademark of SRS Labs, Inc. TruSurround XT technology is incorporated under license from SRS Labs, Inc.

FOR LCD TV

- If the TV feels cold to the touch, there may be a small “flicker” when it is turned on. This is normal, there is nothing wrong with TV.
- Some minute dot defects may be visible on the screen, appearing as tiny red, green, or blue spots. However, they have no adverse effect on the monitor’s performance.
- Avoid touching the LCD screen or holding your finger(s) against it for long periods of time. Doing so may produce some temporary distortion effects on the screen.

On Disposal

The fluorescent lamp used in this product contains a small amount of mercury. Do not dispose of this product with general household waste. Disposal of this product must be carried out in accordance to the regulations of your local authority.



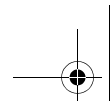

PREPARATION

ACCESSORIES

Ensure that the following accessories are included with your TV. If an accessory is missing, please contact the dealer where you purchased the TV.

The accessories included may differ from the images below.



Owner's Manual



CD Manual

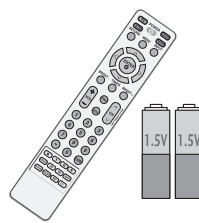

Remote Control, Batteries

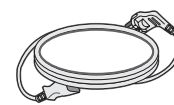

Power Cord



Cable Management Clip



4-Bolts for stand assembly
(Refer to p.10)

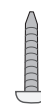

Screw for stand fixing
(Refer to p.13)

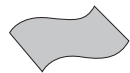

Polishing Cloth

- * Wipe spots on the exterior only with the polishing cloth.
- * Do not wipe roughly when removing stain. Please be cautious of that excessive pressure may cause scratch or discoloration.

Option Extras

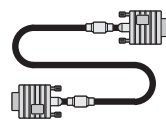

D-sub 15 pin Cable

When using the VGA (D-sub 15 pin cable) PC connection, the user must use shielded signal interface cables with ferrite cores to maintain standards compliance.



PREPARATION

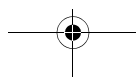
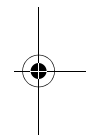
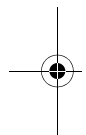

PREPARATION

FRONT PANEL INFORMATION

- Here shown may be somewhat different from your TV.
- **NOTE:** If your product has a protection tape attached, remove the tape. And then wipe the product with a cloth (If a polishing cloth is included with your product, use it).

PREPARATION

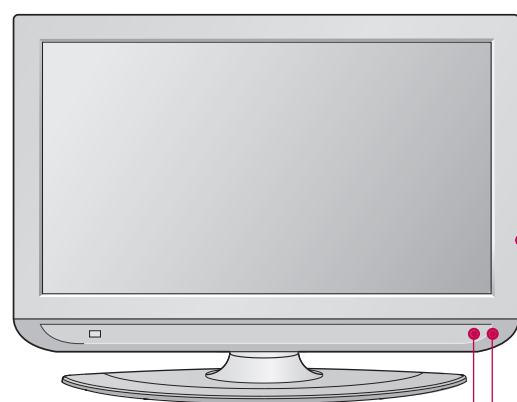

Power/Standby Indicator
Illuminates red in standby mode.
Illuminates green when the set is
switched on.

Remote Control Sensor

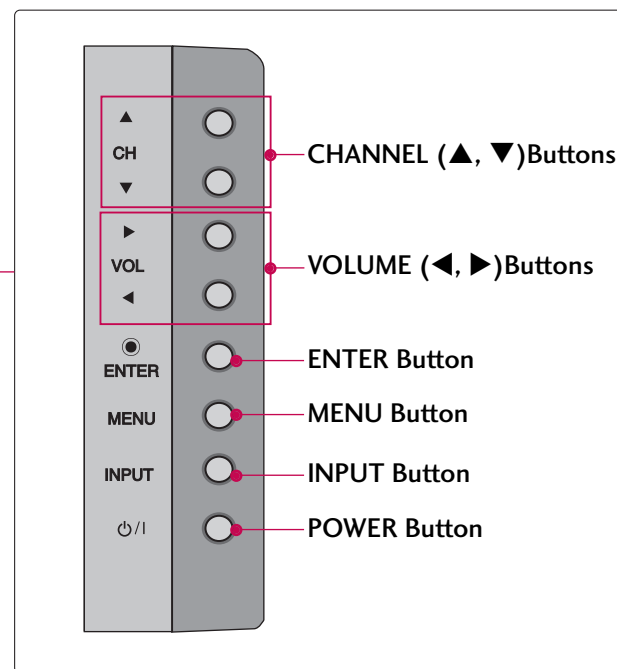

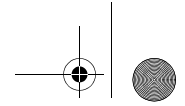

BACK PANEL INFORMATION

■ Here shown may be somewhat different from your TV.

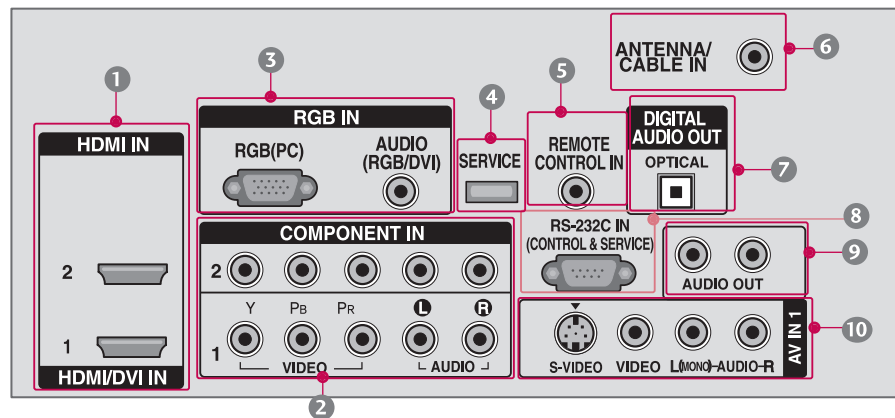
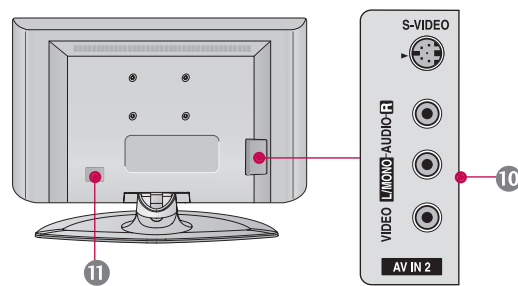

- 1 HDMI/DVI IN, HDMI IN**
Digital Connection.
Supports HD video and Digital audio. Doesn't support 480i.
Accepts DVI video using an adapter or HDMI to DVI cable (not included)
- 2 COMPONENT IN**
Analog Connection.
Supports HD.
Uses a red, green, and blue cable for video & red and white for audio.
- 3 RGB (PC)**
Analog PC Connection. Uses a D-sub 15 pin cable (VGA cable).
AUDIO (RGB/DVI)
1/8" headphone jack for analog PC audio input.
- 4 SERVICE ONLY**
Used for software updates.
- 5 REMOTE CONTROL PORT**
For a wired remote control.
- 6 ANTENNA/CABLE IN**
Connect over-the air signals to this jack.
Connect cable signals to this jack.
- 7 DIGITAL AUDIO OUT**
Digital audio output for use with amps and home theater systems.
Includes an optical and/or coaxial connection.
Note: In standby mode, these ports do not work.
- 8 RS-232C IN (CONTROL & SERVICE) PORT**
Used by third party devices.
- 9 AUDIO OUT**
Analog audio output for use with amps and home theater systems.
- 10 AV (Audio/Video) IN**
Analog composite connection. Supports standard definition video only (480i).
S -VIDEO
Better quality than standard composition.
Supports standard definition video only (480i).
- 11 Power Cord Socket**
For operation with AC power.
Caution: Never attempt to operate the TV on DC power.



PREPARATION

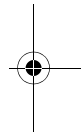
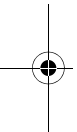

9



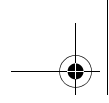

PREPARATION

STAND INSTALLATION

■ Here shown may be somewhat different from your TV.

1 Carefully place the product screen side down on a cushioned surface that will protect product and screen from damage.

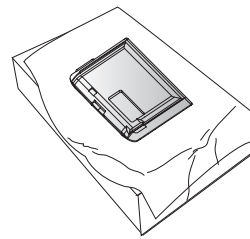

2 Assemble the product stand with the product as shown.

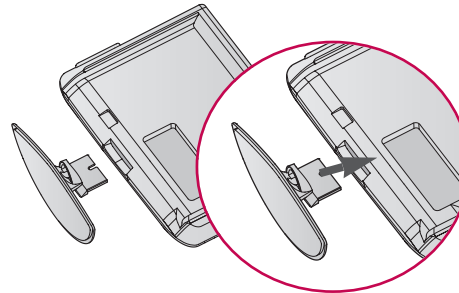

3 Securely install the 4 bolts provided.

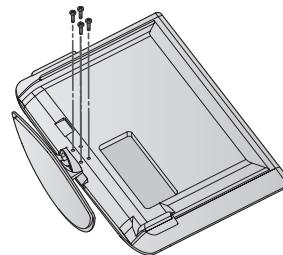

PREPARATION

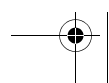
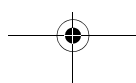
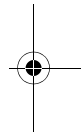
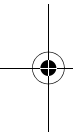

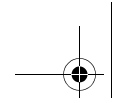

VESA WALL MOUNTING

This TV accepts VESA FDMI compliant mounts via the four screw holes on the back of the TV. These mounts are sold by third parties and not available from LG. Refer to the instructions included with the mount for more info.

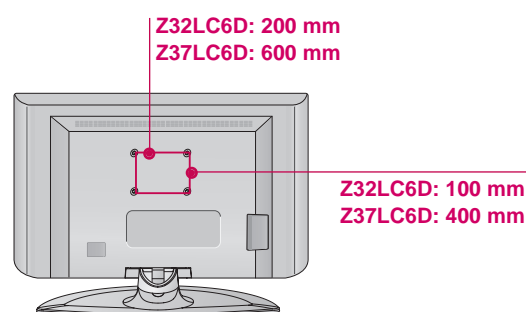

PREPARATION

NOTE

- ▶ Screw length needed depends on the wall mount used. For further information, refer to the instructions included with the mount.

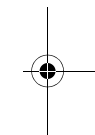
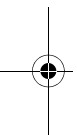

DESKTOP PEDESTAL INSTALLATION

For proper ventilation, allow a clearance of 4 inches on all four sides from the wall.

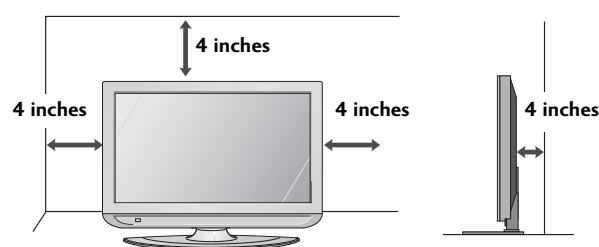

CAUTION

- ▶ Ensure adequate ventilation by following the clearance recommendations.

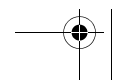
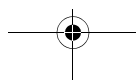

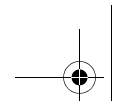

PREPARATION

CABLE MANAGEMENT

■ Here shown may be somewhat different from your TV.

PREPARATION

- 1 Connect the cables as necessary.
To connect an additional equipment, see the **EXTERNAL EQUIPMENT SETUP** section.

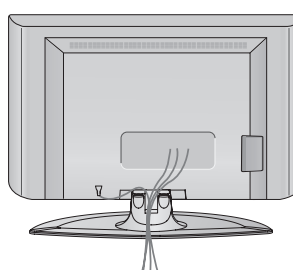

- 2 Install the **CABLE MANAGEMENT CLIP** as shown.

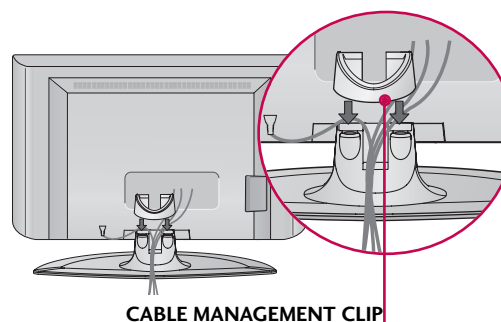

! NOTE

- ▶ Do not hold the **CABLE MANAGEMENT CLIP** when moving the product.
- If the product is dropped, you may be injured or the product may be broken.

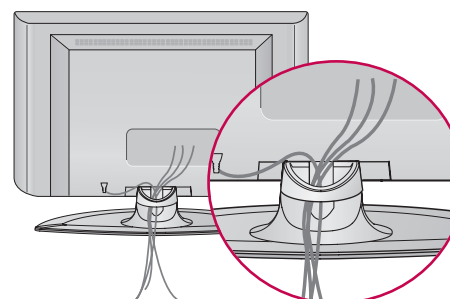

How to remove the **CABLE MANAGEMENT CLIP**

- ▶ Hold the **CABLE MANAGEMENT CLIP** with both hands and pull it backward.

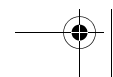
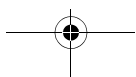
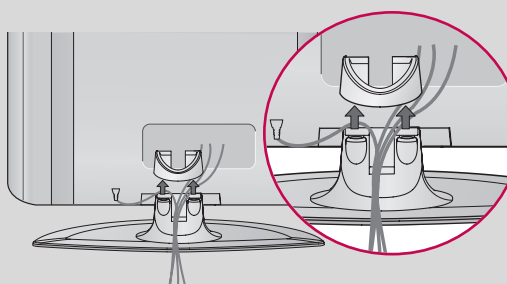

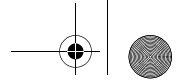

ATTACHING THE TV TO A DESK

The TV must be attached to a desk so it cannot be pulled in a forward/backward direction, potentially causing injury or damaging the product. Use only an attached screw.

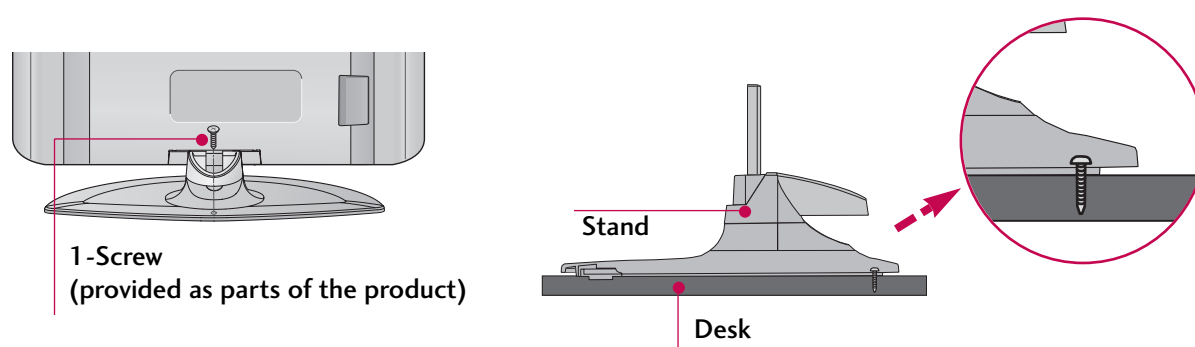

PREPARATION

⚠ WARNING

- ▶ To prevent TV from falling over, the TV should be securely attached to the floor/wall per installation instructions. Tipping, shaking, or rocking the machine may cause injury.

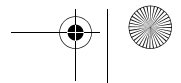
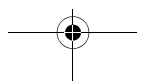
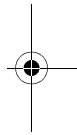
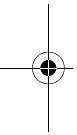

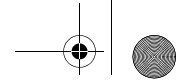

PREPARATION

SECURING THE TV TO THE WALL TO PREVENT FALLING

- You should purchase necessary components to prevent TV from falling off of the stand.
- Image shown may differ from your TV.

PREPARATION

We recommend that you set up the TV close to a wall so it cannot fall over if pushed backwards. Additionally, we recommend that the TV be attached to a wall so it cannot be pulled in a forward direction, potentially causing injury or damaging the product.

Caution: Please make sure that children don't climb on or hang from the TV.

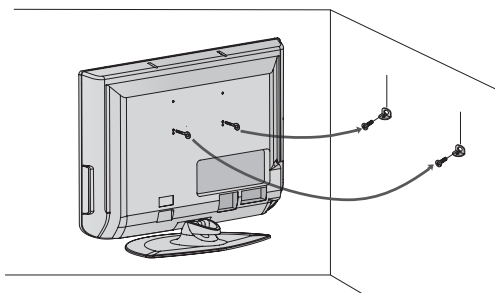

- Insert the eye-bolts (or TV brackets and bolts) to tighten the product to the wall as shown in the picture.
 - * If your product has the bolts in the eye-bolts position before inserting the eye-bolts, loosen the bolts. Secure the wall brackets with the bolts (not provided as parts of the product, must purchase separately) to the wall. Match the height of the bracket that is mounted on the wall to the holes in the product. Ensure the eye-bolts or brackets are tightened securely.

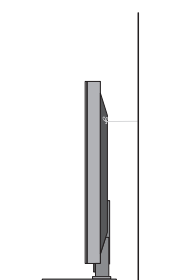

- Use a sturdy rope (not provided as parts of the product, must purchase separately) to tie the product. It is safer to tie the rope so it becomes horizontal between the wall and the product.

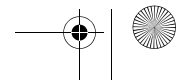
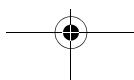

ANTENNA OR CABLE CONNECTION

- To prevent damage do not connect to the power outlet until all connections are made between the devices.

1. Antenna (Analog or Digital)

Wall Antenna Socket or Outdoor Antenna without a Cable Box Connections.
For optimum picture quality, adjust antenna direction if needed.

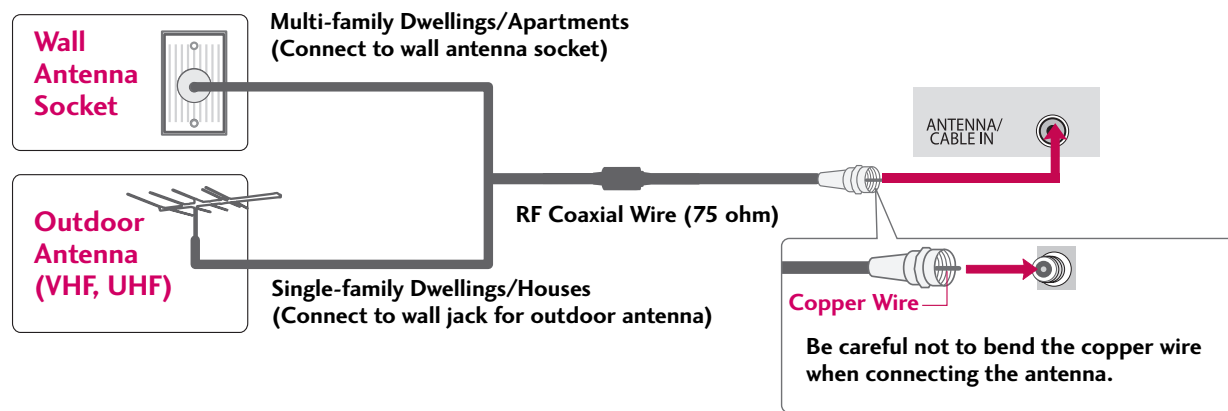

2. Cable

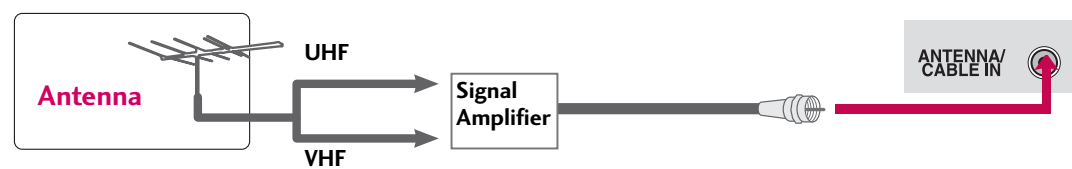
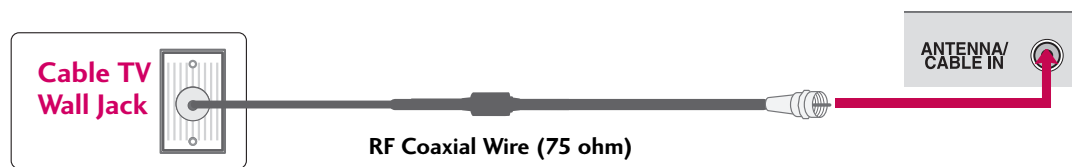

- To improve the picture quality in a poor signal area, please purchase a signal amplifier and install properly.
- If the antenna needs to be split for two TV's, install a 2-Way Signal Splitter.
- If the antenna is not installed properly, contact your dealer for assistance.

PREPARATION

EXTERNAL EQUIPMENT SETUP

- To prevent the equipment damage, never plug in any power cords until you have finished connecting all equipment.
- This part of EXTERNAL EQUIPMENT SETUP mainly use picture for LCD TV model.

HD RECEIVER SETUP

This TV can receive Digital Over-the-air/Cable signals without an external digital set-top box. However, if you do receive digital signals from a digital set-top box or other digital external device, refer to the figure as shown below.

Component Connection

1. How to connect

- 1 Connect the video outputs (Y, Pb, Pr) of the digital set top box to the **COMPONENT IN VIDEO 1** jacks on the set. Match the jack colors (Y = green, Pb = blue, and Pr = red).
- 2 Connect the audio output of the digital set-top box to the **COMPONENT IN AUDIO 1** jacks on the TV.

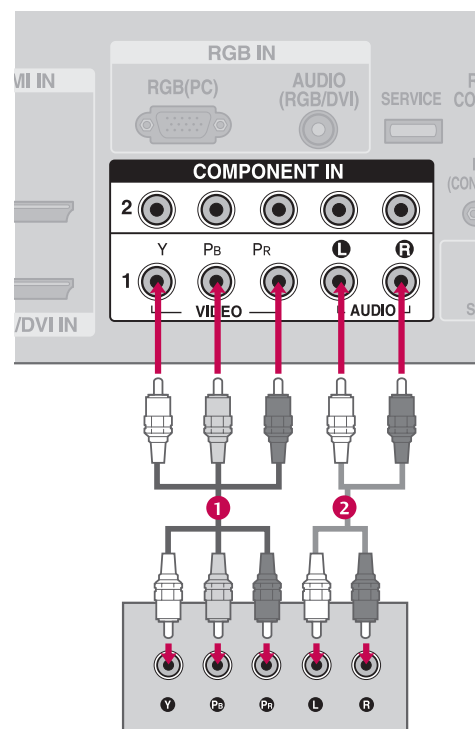

2. How to use

- Turn on the digital set-top box. (Refer to the owner's manual for the digital set-top box operation)
- Select the **Component 1** input source on the TV using the **INPUT** button on the remote control.
- If connected to **COMPONENT IN2** input, select the **Component 2** input source on the TV.

Supported Resolutions

Signal	Component 1/2	HDMI1/2
480i	Yes	No
480p	Yes	Yes
720p	Yes	Yes
1080i	Yes	Yes
1080p	Yes	Yes

Y, CB/PB, CR/PR

Resolution	Horizontal Frequency (KHz)	Vertical Frequency (Hz)
720x480i	15.73	59.94
	15.73	60.00
720x480p	31.47	59.94
	31.50	60.00
1280x720p	44.96	59.94
	45.00	60.00
1920x1080i	33.72	59.94
	33.75	60.00
1920x1080p	26.97	23.976
	27.00	24.00
	33.71	29.97
	33.75	30.00
	67.432	59.94
	67.50	60.00

HDMI Connection

1. How to connect

- 1 Connect the digital set-top box to **HDMI/DVI IN 1** or **HDMI IN 2** jack on the TV.
- 2 No separated audio connection is necessary. HDMI supports both audio and video.

2. How to use

- Turn on the digital set-top box.
(Refer to the owner's manual for the digital set-top box.)
- Select the **HDMI1** or **HDMI2** input source on the TV using the **INPUT** button on the remote control.

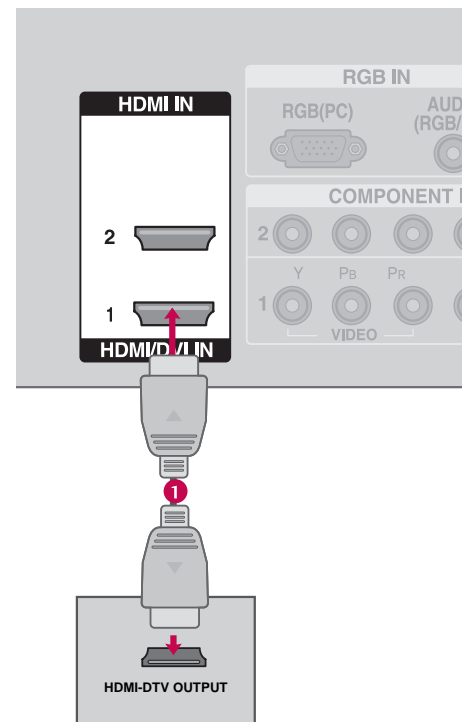

EXTERNAL EQUIPMENT SETUP

HDMI1/DVI-DTV, HDMI2-DTV mode

Resolution	Horizontal Frequency (KHz)	Vertical Frequency (Hz)
720x480p	31.47	59.94
	31.50	60.00
1280x720p	44.96	59.94
	45.00	60.00
1920x1080i	33.72	59.94
	33.75	60.00
1920x1080p	26.97	23.976
	27.00	24.00
	33.71	29.97
	33.75	30.00
	67.432	59.939
	67.50	60.00

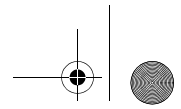

EXTERNAL EQUIPMENT SETUP

DVI to HDMI Connection

EXTERNAL EQUIPMENT SETUP

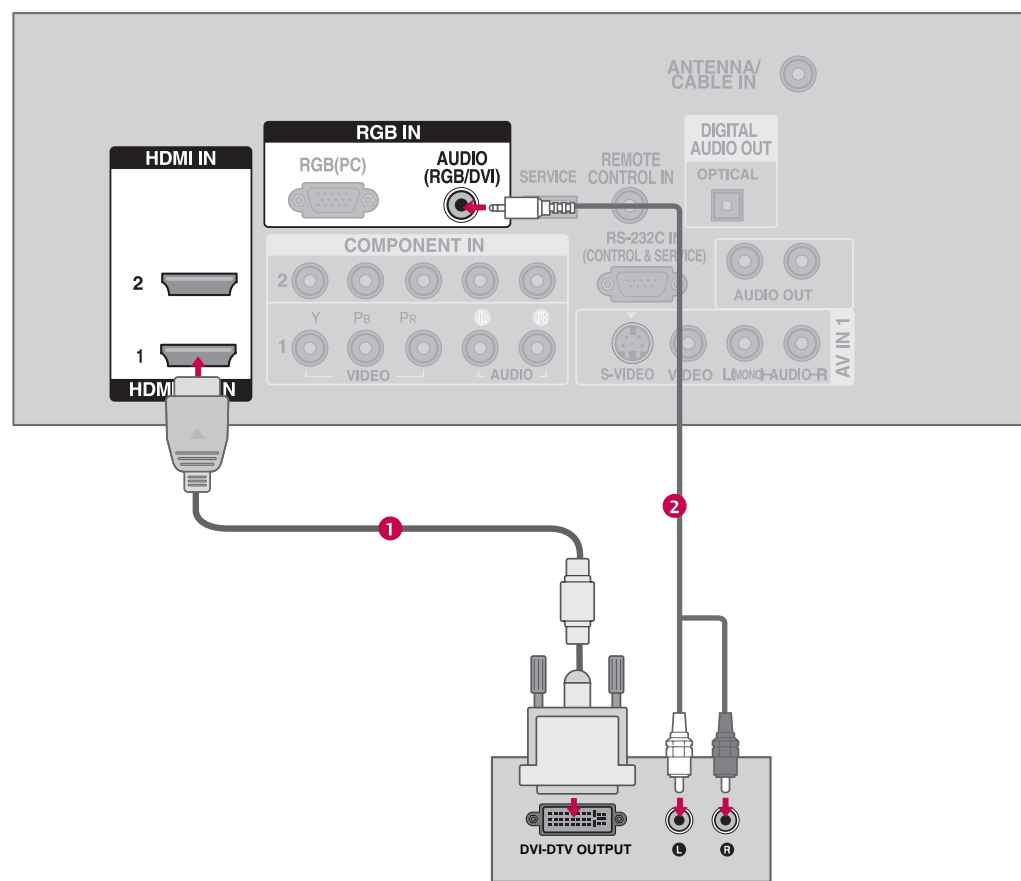

1. How to connect

- 1 Connect the DVI output of the digital set-top box to the **HDMI/DVI IN 1** jack on the TV.
- 2 Connect the audio output of the digital set-top box to the **AUDIO (RGB/DVI)** jack on the TV.

2. How to use

- Turn on the digital set-top box. (Refer to the owner's manual for the digital set-top box.)
- Select the **HDMI1** input source on the TV using the **INPUT** button on the remote control.

NOTE ▶ A DVI to HDMI cable or adapter is required for this connection. DVI doesn't support audio, so a separate audio connection is necessary.

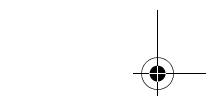
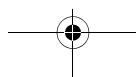

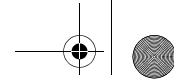

DVD SETUP

Component Connection

1. How to connect

- 1** Connect the video outputs (Y, PB, PR) of the DVD to the **COMPONENT IN VIDEO 1** jacks on the TV.
Match the jack colors
(Y = green, PB = blue, and PR = red).

- 2** Connect the audio outputs of the DVD to the **COMPONENT IN AUDIO 1** jacks on the TV.

2. How to use

- Turn on the DVD player, insert a DVD.
- Select the **Component 1** input source on the TV using the **INPUT** button on the remote control.
- If connected to **COMPONENT IN 2** input, select the **Component 2** input source on the TV.
- Refer to the DVD player's manual for operating instructions.

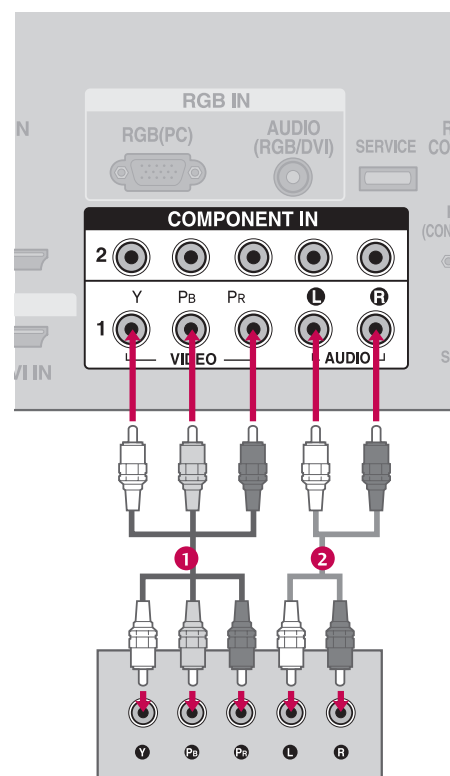

EXTERNAL EQUIPMENT SETUP

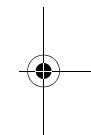
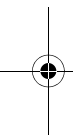

Component Input ports

To get better picture quality, connect a DVD player to the component input ports as shown below.

Component ports on the TV	Y	PB	PR
Video output ports on DVD player	Y	PB	PR
	Y	B-Y	R-Y
	Y	Cb	Cr
	Y	Pb	Pr

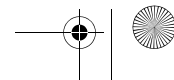
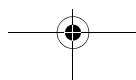

EXTERNAL EQUIPMENT SETUP

S-Video Connection

1. How to connect

- 1 Connect the S-VIDEO output of the DVD to the **S-VIDEO** input on the TV.
- 2 Connect the audio outputs of the DVD to the **AUDIO** input jacks on the TV.

2. How to use

- Turn on the DVD player, insert a DVD.
- Select the **AV 1** input source on the TV using the **INPUT** button on the remote control.
- If connected to **AV IN2**, select **AV 2** input source.
- Refer to the DVD player's manual for operating instructions.

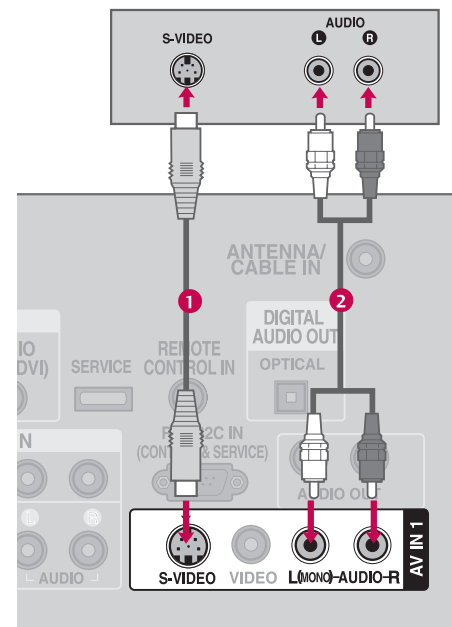

HDMI Connection

1. How to connect

- 1 Connect the HDMI output of the DVD to the **HDMI/DVI IN 1** or **HDMI IN 2** jack on the TV.
- 2 No separated audio connection is necessary. HDMI supports both audio and video.

2. How to use

- Select the **HDMI1** or **HDMI2** input source on the TV using the **INPUT** button on the remote control.
- Refer to the DVD player's manual for operating instructions.

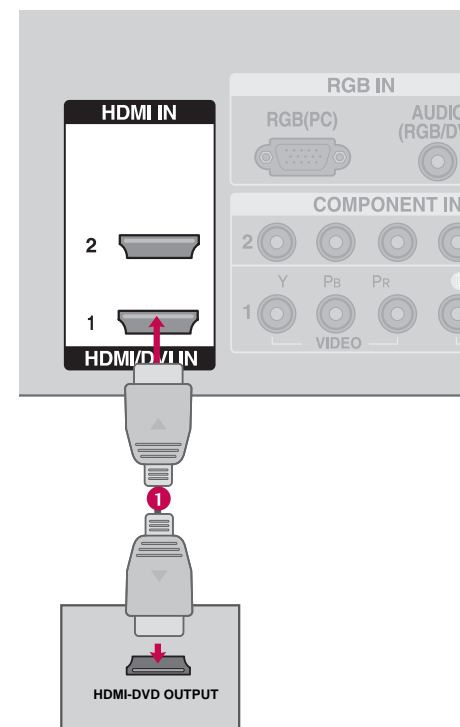

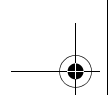

VCR SETUP

- To avoid picture noise (interference), leave an adequate distance between the VCR and TV.
- If the 4:3 picture format is used; the fixed images on the sides of the screen may remain visible on the screen. This phenomenon is common to all TVs and is not covered by warranty.

Antenna Connection

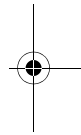
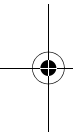
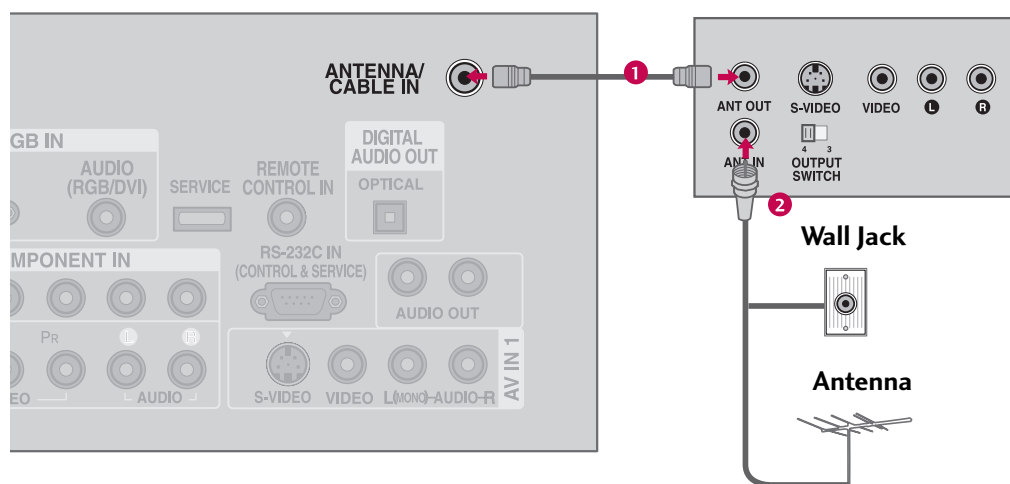

1. How to connect

- 1 Connect the RF antenna out socket of the VCR to the **ANTENNA/CABLE IN** socket on the TV.
- 2 Connect the antenna cable to the RF antenna in socket of the VCR.

2. How to use

- Set VCR output switch to 3 or 4 and then tune TV to the same channel number.
- Insert a video tape into the VCR and press PLAY on the VCR. (Refer to the VCR owner's manual.)



EXTERNAL EQUIPMENT SETUP

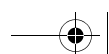

EXTERNAL EQUIPMENT SETUP

Composite (RCA) Connection

1. How to connect

- 1 Connect the **AUDIO/VIDEO** jacks between TV and VCR. Match the jack colors (Video = yellow, Audio Left = white, and Audio Right = red)

2. How to use

- Insert a video tape into the VCR and press PLAY on the VCR. (Refer to the VCR owner's manual.)
- Select the **AV 1** input source on the TV using the **INPUT** button on the remote control.
- If connected to **AV IN2**, select **AV 2** input source.

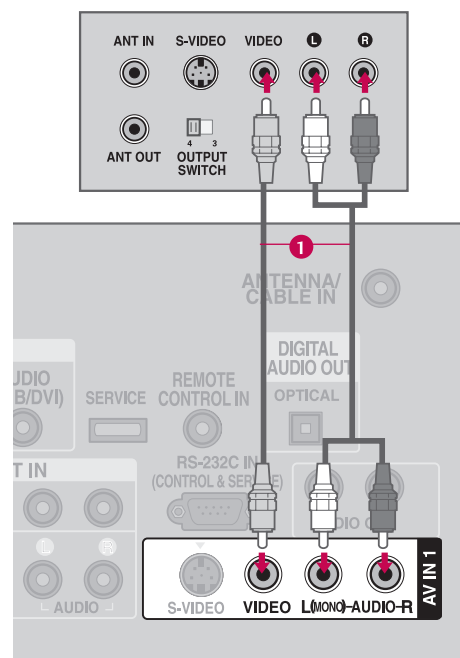

NOTE ▶ If you have a mono VCR, connect the audio cable from the VCR to the **AUDIO L/MONO** jack of the set.

S-Video Connection

1. How to connect

- 1 Connect the S-VIDEO output of the VCR to the **S-VIDEO** input on the TV.
- 2 Connect the audio outputs of the VCR to the **AUDIO** input jacks on the TV.

2. How to use

- Insert a video tape into the VCR and press PLAY on the VCR. (Refer to the VCR owner's manual.)
- Select the **AV 1** input source on the TV using the **INPUT** button on the remote control.
- If connected to **AV IN2**, select **AV 2** input source.

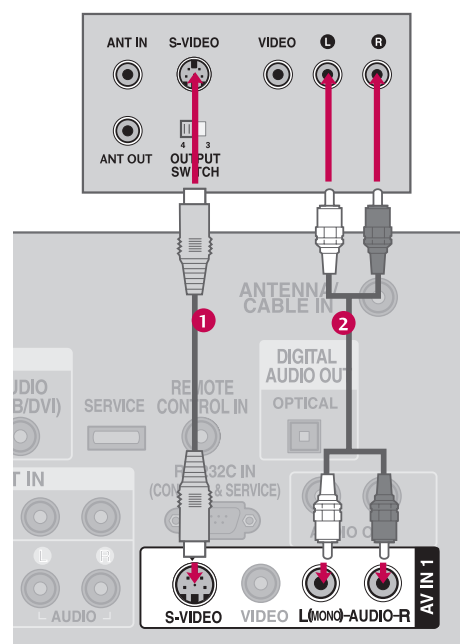

NOTE
▶ S-Video provides better quality than composite. Use it when available.

CAUTION

- ▶ Do not connect to both Video and S-Video at the same time. In the event that you connect both Video and the S-Video cables, only the S-Video will work.

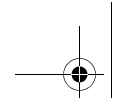

OTHER A/V SOURCE SETUP

1. How to connect

- 1 Connect the **AUDIO/VIDEO** jacks between TV and external equipment. Match the jack colors. (Video = yellow, Audio Left = white, and Audio Right = red)

2. How to use

- Select the **AV 2** input source on the TV using the **INPUT** button on the remote control.
- If connected to **AV IN1** input, select **AV 1** input source.
- Operate the corresponding external equipment.

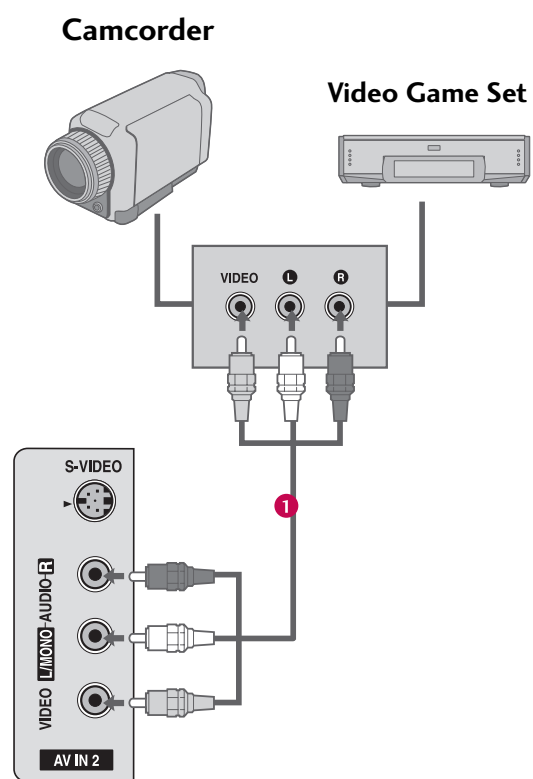

EXTERNAL EQUIPMENT SETUP

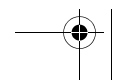
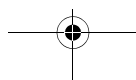
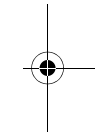
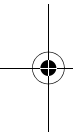

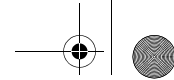

EXTERNAL EQUIPMENT SETUP

PC SETUP

This TV provides Plug and Play capability, meaning that the PC adjusts automatically to the TV's settings.

VGA (D-Sub 15 pin) Connection

1. How to connect

- 1 Connect the VGA output of the PC to the **RGB (PC)** jack on the TV.
- 2 Connect the PC audio output to the **AUDIO (RGB/DVI)** jack on the TV.

2. How to use

- Turn on the PC and the TV.
- Select the **RGB-PC** input source on the TV using the **INPUT** button on the remote control.

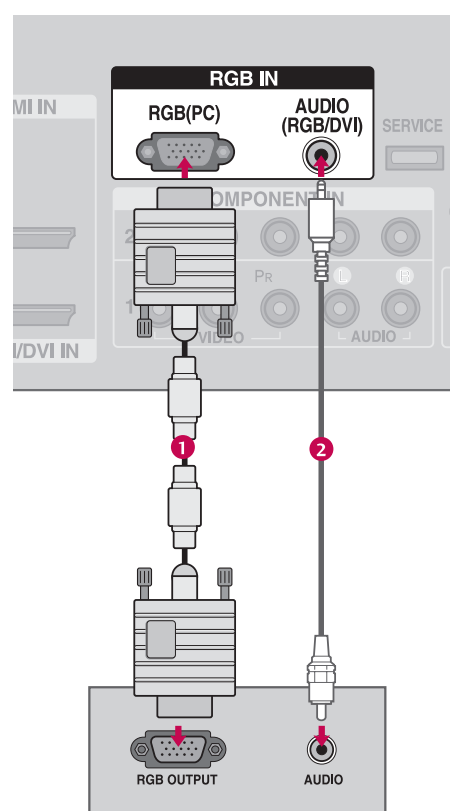

EXTERNAL EQUIPMENT SETUP

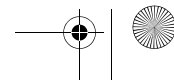
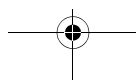
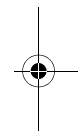
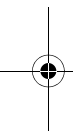

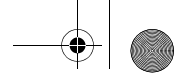

DVI to HDMI Connection

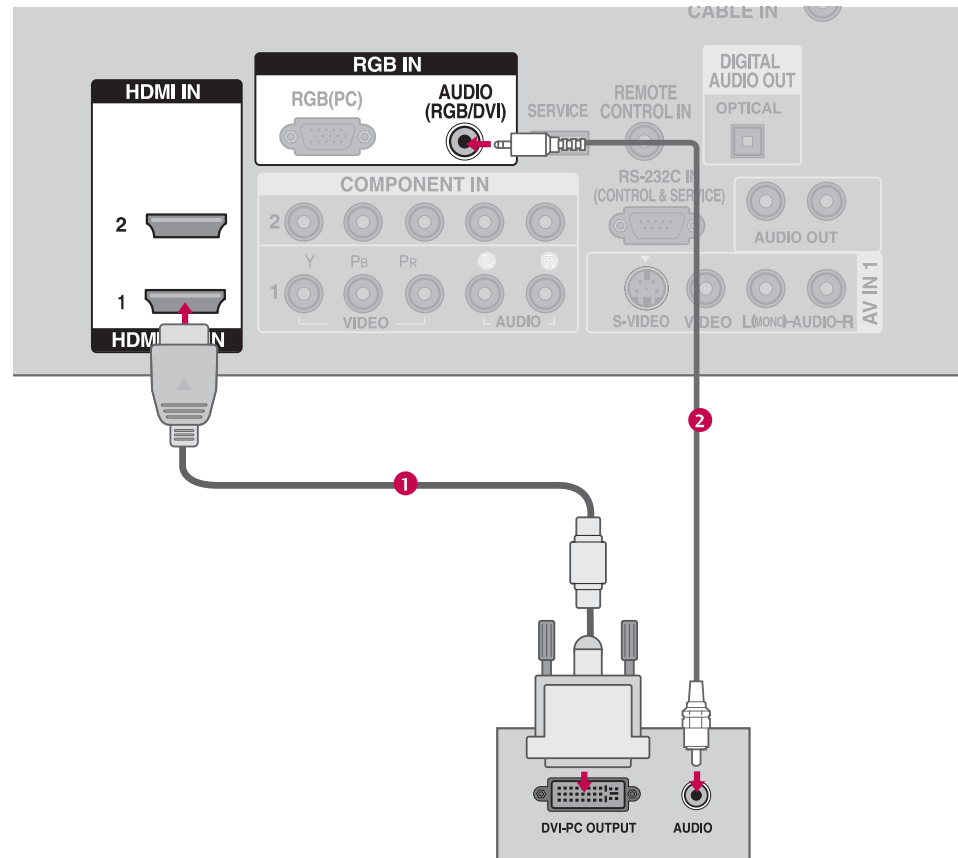

EXTERNAL EQUIPMENT SETUP

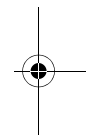
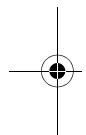

1. How to connect

- 1 Connect the DVI output of the PC to the **HDMI/DVI IN 1** jack on the TV.
- 2 Connect the PC audio output to the **AUDIO (RGB/DVI)** jack on the TV.

2. How to use

- Turn on the PC and the TV.
- Select the **HDMI 1** input source on the TV using the **INPUT** button on the remote control.

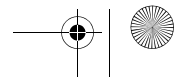
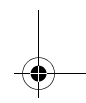
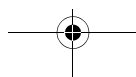
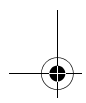

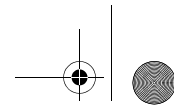

EXTERNAL EQUIPMENT SETUP

NOTES

- ▶ To get the the best picture quality, adjust the PC graphics card to 1366x768.
- ▶ Depending on the graphics card, DOS mode may not work if a HDMI to DVI Cable is in use.
- ▶ In PC mode, there may be noise associated with the resolution, vertical pattern, contrast or brightness. If noise is present, change the PC output to another resolution, change the refresh rate to another rate or adjust the brightness and contrast on the PICTURE menu until the picture is clear.
- ▶ Avoid keeping a fixed image on the screen for a long period of time. The fixed image could become permanently imprinted on the screen.
- ▶ The synchronization input form for Horizontal and Vertical frequencies is separate.
- ▶ Depending on the graphics card, some resolution settings may not allow the image to be positioned on the screen properly.

EXTERNAL EQUIPMENT SETUP

Supported Display Specifications

RGB-PC, HDMI1/DVI-PC mode

Resolution	Horizontal Frequency (KHz)	Vertical Frequency (Hz)
640x350	31.469	70.08
720x400	31.469	70.08
640x480	31.469	59.94
800x600	37.879	60.31
1024x768	48.363	60.00
1280x768	47.776	59.87
1360x768	47.720	59.799
1366x768	47.130	59.65

* RGB-PC mode only

* LCD TV only



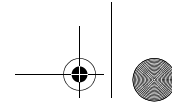

Screen Setup for PC mode

Overview

When the RGB input of the set is connected to a PC Output, Select RGB-PC with using the **INPUT** button on the remote control.

When you change the resolution, select the proper resolution in present input to see the best picture appearance.

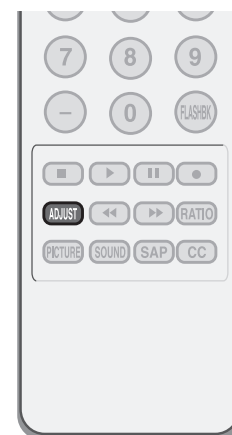

Adjustment for screen Resolution, Position, Size, and Phase

- 1 Press the **ADJUST** button and then use **▲** or **▼** button to select **Resolution, Position, Size, or Phase**.
- 2 Press the **ENTER** button and then use **▲ ▼ ◀ ▶** button to make appropriate adjustments.
 - The **Phase** adjustment range is **-16 ~ +16**.
 - The **Size** adjustment range is **-30 ~ +30**.
- 3 Press the **ENTER** button.

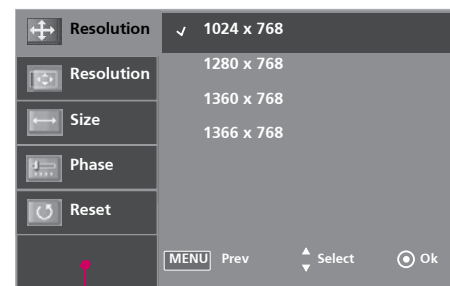

1 2 3

Resolution This function allows you select resolution of XGA/WXGA.

Position This function is to adjust picture to left/right and up/down as you prefer.

Size This function is to minimize any vertical bars or stripes visible on the screen background. And the horizontal screen size will also change.

Phase This function allows you to remove any horizontal noise and clear or sharpen the image of characters.



EXTERNAL EQUIPMENT SETUP

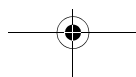
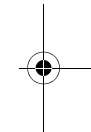
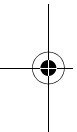

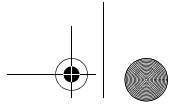

EXTERNAL EQUIPMENT SETUP

Initializing (Reset to original factory values)

To initialize the adjusted values.

- 1 Press the **ADJUST** button and then use **▲** or **▼** button to select **Reset**.
- 2 Press the **ENTER** button and then use **◀** or **▶** button to select **Yes**.
- 3 Press the **ENTER** button.

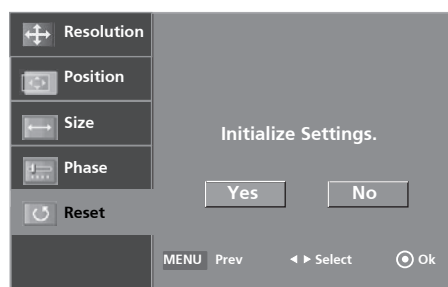

1 2 3

EXTERNAL EQUIPMENT SETUP

- You can also use the **PICTURE** menu to adjust **Screen**.

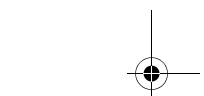
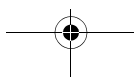
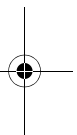
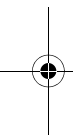
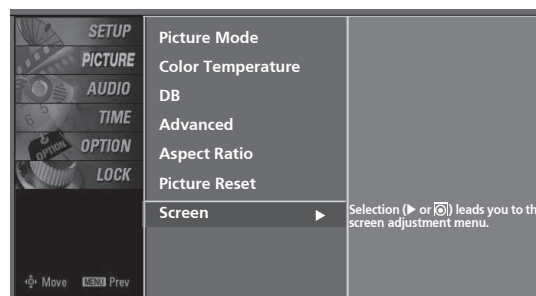
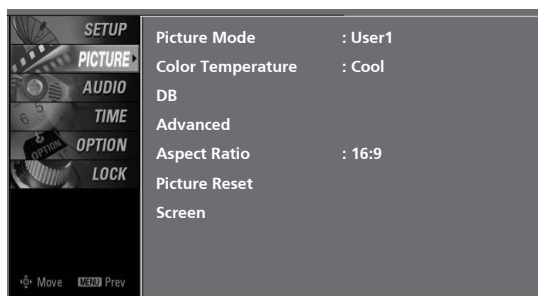

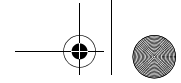

AUDIO OUT CONNECTION

Send the TV's audio to external audio equipment via the Audio Output port.

Analog

1. How to connect

- 1 Connect audio outputs to the TV's **AUDIO OUT** jacks.
- 2 Set the "TV Speaker option - Off" in the AUDIO menu. (▶p.53). See the external audio equipment instruction manual for operation.

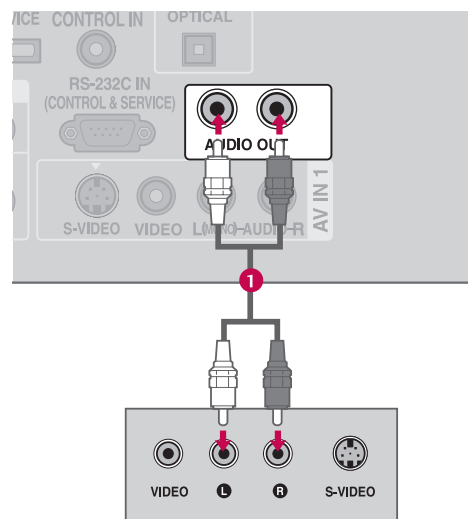

EXTERNAL EQUIPMENT SETUP

Digital

1. How to connect

- 1 Connect one end of the optical cable to the TV's **DIGITAL AUDIO OUT OPTICAL**.
- 2 Connect the other end of the optical cable to the digital audio input on the audio equipment.
- 3 Set the "TV Speaker option - Off" in the AUDIO menu. (▶p.53). See the external audio equipment instruction manual for operation.

NOTE

- ▶ When connecting with external audio equipments, such as amplifiers or speakers, you can turn the TV speakers off in the menu. (▶p.53)

CAUTION

- ▶ Do not look into the optical output port. Looking at the laser beam may damage your vision.
- ▶ Block the SPDIF out (optical) about the contents with ACP(Audio Copy Protection) function.

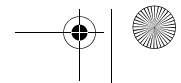
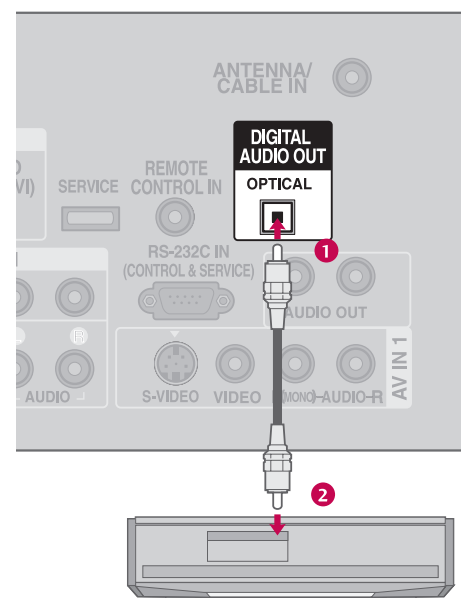

WATCHING TV / CHANNEL CONTROL

REMOTE CONTROL FUNCTIONS

When using the remote control, aim it at the remote control sensor on the TV.

WATCHING TV / CHANNEL CONTROL

- TV/STB/DVD/VCR** Select the remote operating mode: TV, STB, DVD, or VCR.
 - POWER** Turns your TV or any other programmed equipment on or off, depending on the mode.
 - RETURN** Clear all on-screen displays and return to TV viewing from any menu.
 - MENU** Displays the main menu.
Clear all on-screen displays and return to TV viewing from any menu.
 - INPUT** External input modes rotate in regular sequence.
-
- VOLUME UP/DOWN** Increase/decrease the sound level.
 - FAV** Scroll through the programmed Favorite channels. ▶p.36
 - MUTE** Switch the sound on or off. ▶p.32
 - CHANNEL UP/DOWN** Select available channels.
 - PAGE UP/DOWN** Move from one full set of screen information to the next one.
-
- NUMBER button — (DASH)** Used to enter a program number for multiple program channels such as 2-1, 2-2, etc.
 - FLASHBK** Tune to the last channel viewed.
-
- VCR/DVD Control buttons** Control video cassette recorders or DVD players.

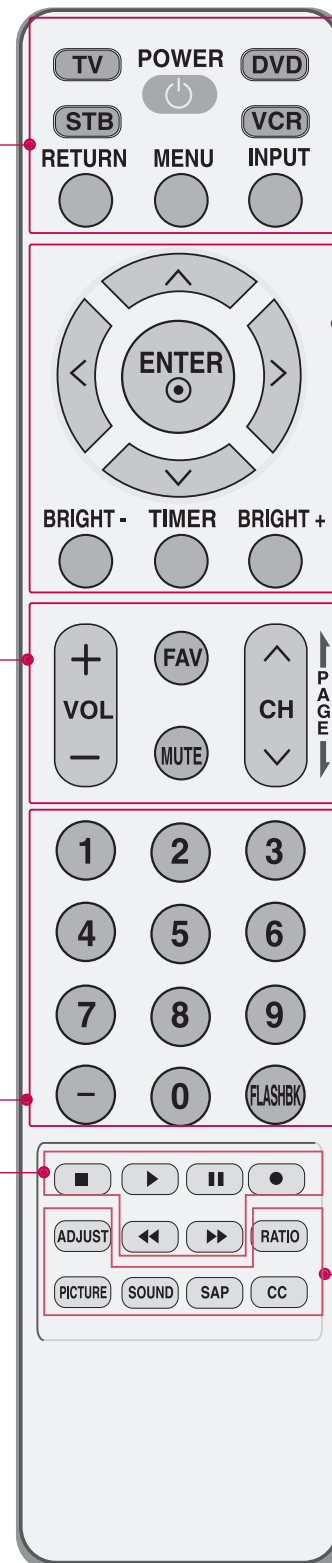



THUMBSTICK (Up/Down/Left Right/ENTER) Navigate the on-screen menus and adjust the system settings to your preference.

BRIGHT -/+ Adjust the brightness on screen.

TIMER Select the amount of time before your TV turns off automatically. ▶p.64

ADJUST Adjust the screen resolution, position, size and phase. ▶p.27-28

PICTURE Selects the factory preset picture depend on the viewing environment. ▶p.41

SOUND Selects the factory preset sound for type of program. ▶p.50

SAP Analog mode: Selects MTS sound (Mono, Stereo, or a SAP) ▶p.54
DTV mode: Changes the audio language.

CC Select a closed caption. ▶p.57

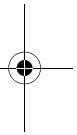
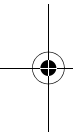

Installing Batteries

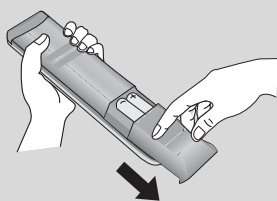

- Open the battery compartment cover on the back side and install the batteries matching correct polarity (+with +, -with -).
- Install two 1.5V AAA batteries. Don't mix old or used batteries with new ones.
- Close cover.

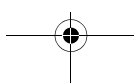



WATCHING TV / CHANNEL CONTROL

TURNING ON TV

- 1 First, connect power cord correctly.
At this moment, the TV switches to standby mode.
 - In standby mode to turn TV on, press the $\phi/1$, **INPUT**, **CH** (\blacktriangle or \blacktriangledown) button on the TV or press the **POWER**, **INPUT**, **CH** (\wedge or \vee), **Number (0~9)** button on the remote control.

- 2 Select the viewing source by using the **INPUT** button on the remote control.
 - This TV is programmed to remember which power state it was last set to, even if the power cord is out.

- 3 When finished using the TV, press the **POWER** button on the remote control. The TV reverts to standby mode.



NOTE

- ▶ If you intend to be away on vacation, disconnect the power plug from the wall power outlet.

CHANNEL SELECTION

- 1 Press the **CH** (\wedge or \vee) or **NUMBER** buttons to select a channel number.



VOLUME ADJUSTMENT

Adjust the volume to suit your personal preference.

- 1 Press the **VOL** (+ or -) button to adjust the volume.

- 2 If you want to switch the sound off, press the **MUTE** button.

- 3 You can cancel the Mute function by pressing the **MUTE** or **VOL** (+ or -) button.



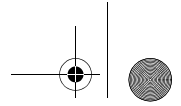

ON-SCREEN MENUS SELECTION

Your TV's OSD (On Screen Display) may differ slightly from what is shown in this manual.

- 1 Press the **MENU** button and then use **^** or **v** button to select each menu.
- 2 Press the **>** button and then use **^** **v** **<** **>** button to display the available menus.

SETUP

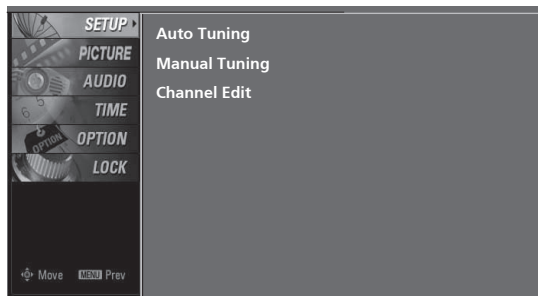

PICTURE

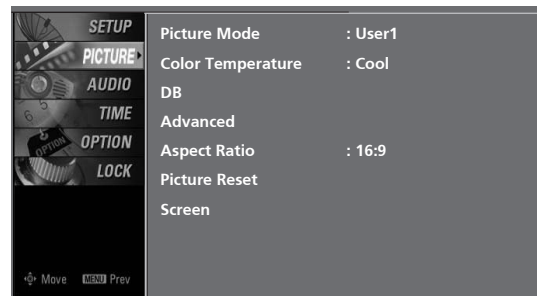

LOCK

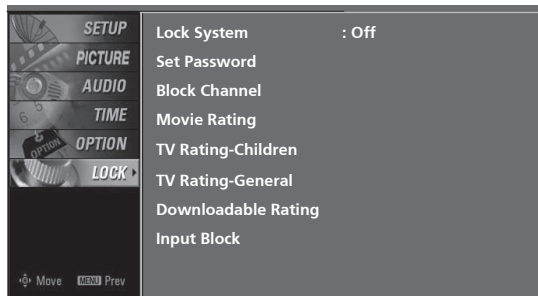

AUDIO

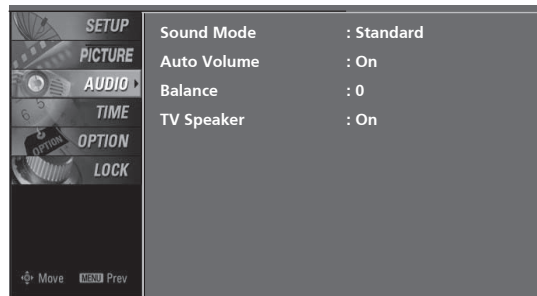

OPTION

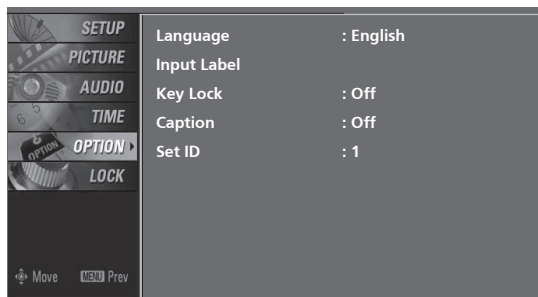

TIME

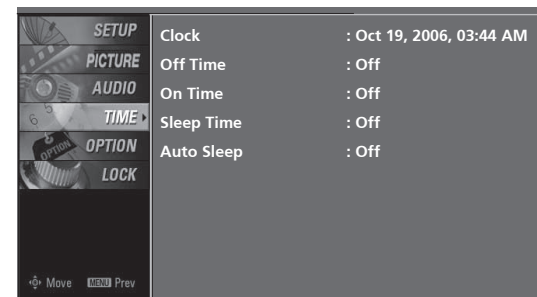

WATCHING TV / CHANNEL CONTROL

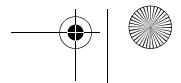
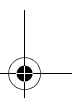
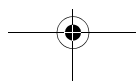
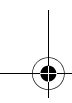
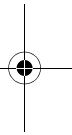
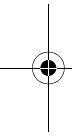

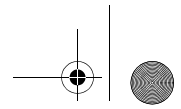

WATCHING TV / CHANNEL CONTROL

CHANNEL SETUP

Auto Scan (Auto Tuning)

Automatically finds all channels available through antenna or cable inputs, and stores them in memory on the channel list.

Run Auto Tuning again after any Antenna/Cable connection changes.

A password is required to gain access to Auto Tuning menu if the Lock System is turned on.

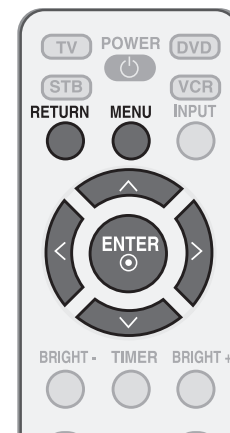

WATCHING TV / CHANNEL CONTROL

- 1 Press the **MENU** button and then use \wedge or \vee button to select the **SETUP** menu.
- 2 Press the $\>$ button and then use \wedge or \vee button to select **Auto Tuning**.
- 3 Press the **ENTER** button to begin the channel search. Allow **Auto Tuning** to complete the channel search cycle for **ANTENNA** and **CABLE**.

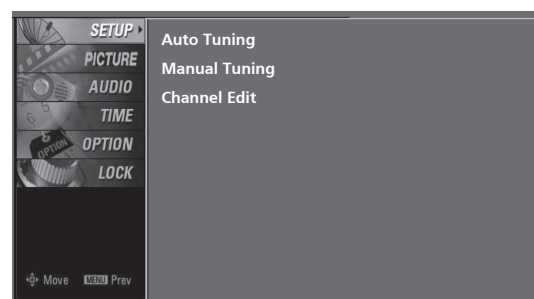

1

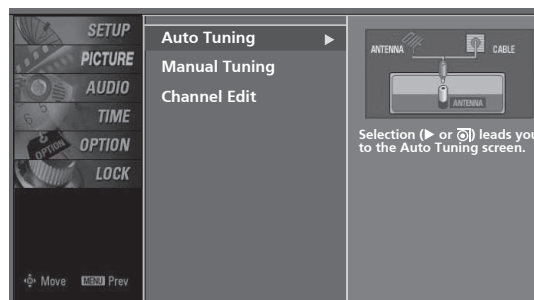

2

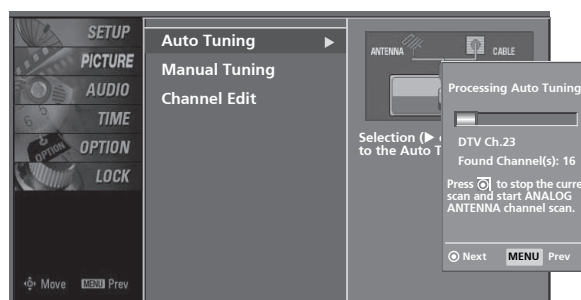

3

NOTE



- DTV (Digital DTV antenna)
- TV (Analog TV antenna)
- CADTV (Digital CADTV cable)
- CATV (Analog CATV cable)

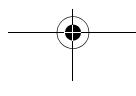

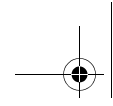

Add/Delete Channel (Manual Tuning)

A password is required to gain access to Manual Tuning menu if the Lock System is turned on.

If selecting DTV or CADTV input signal, you can view the on-screen signal strength monitor to see the quality of the signal being received.

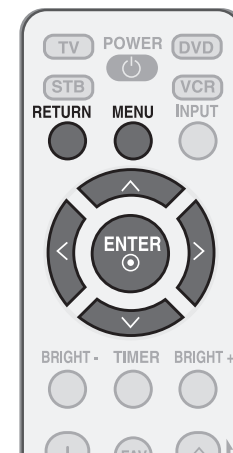

- 1 Press the **MENU** button and then use \wedge or \vee button to select the **SETUP** menu.

- 2 Press the $\>$ button and then use \wedge or \vee button to select **Manual Tuning**.

- 3 Press the $\>$ button and then use \wedge or \vee button to select **TV, DTV, CATV, and CADTV**.

- 4 Press the $\>$ button and then use \wedge or \vee button to select channel you want to add or delete.

- 5 Press the **ENTER** button to add or delete the channel.

- 6 Press **RETURN** button to return to TV viewing or press **MENU** button to return to the previous menu.

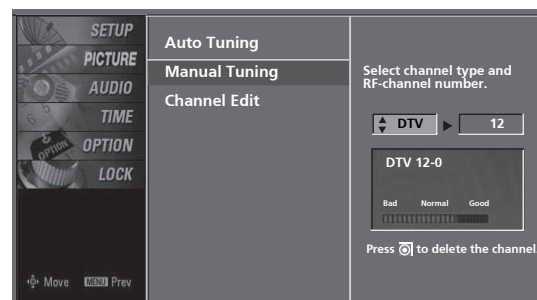
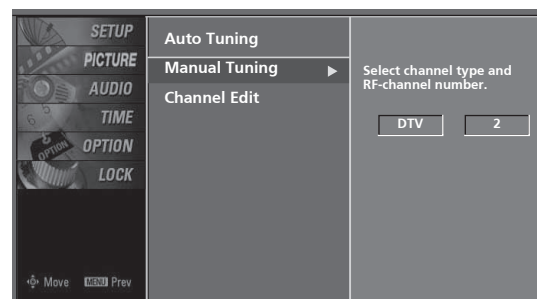
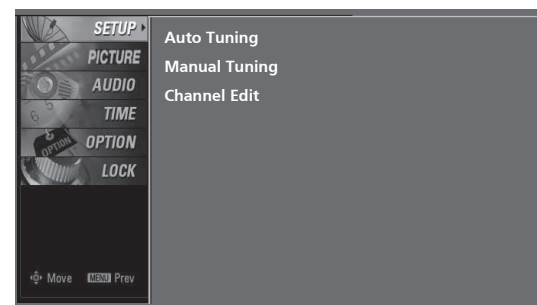

3 4 5



WATCHING TV / CHANNEL CONTROL

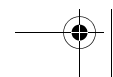
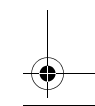
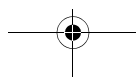
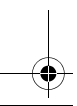
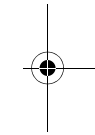
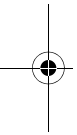

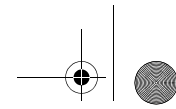

WATCHING TV / CHANNEL CONTROL

Channel Editing

From the default channel list created from the Auto Tuning channel search, you can create two different types of channel lists in memory: "custom list" and "favorite channel list".

A custom list can be created by toggling each channel on or off with **ENTER** button. The channels in the Custom List are displayed in black and the channels deleted from the Custom List are displayed in gray. Once a channel is highlighted you can add or delete the channel by referring to the small window at the top-left corner of the screen.

You can create your own Favorite List. Use the **FAV** button on the remote control when a channel is highlighted and then add or delete the channel to/from your Favorite List.

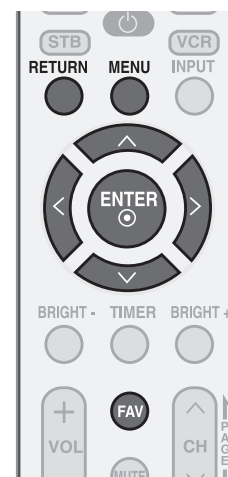

WATCHING TV / CHANNEL CONTROL

1 Press the **MENU** button and then use **^** or **v** button to select the **SETUP** menu.

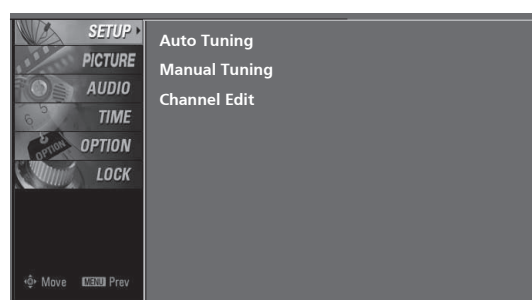

2 Press the **>** button and then use **^** or **v** button to select **Channel Edit**.

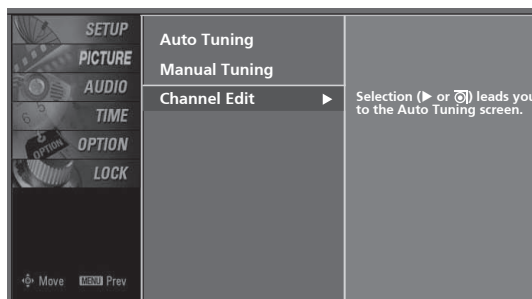

3 Press the **>** button. You will now see a screen filled with channel numbers and a preview picture.

4 Use **^** **v** **<** **>** button to select a channel and then use the **ENTER** button to add or delete it. Press **FAV** button to add the channel to the Favorite List. The surfing icon will appear in front of that channel number.

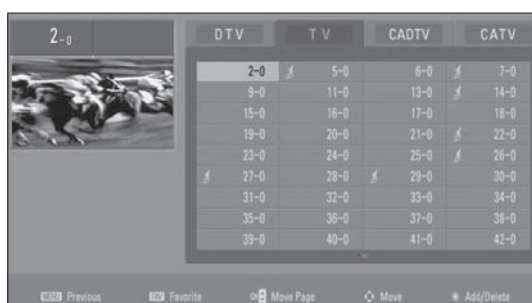

5 Press **RETURN** button to return to TV viewing or press **MENU** button to return to the previous menu.

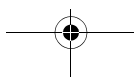

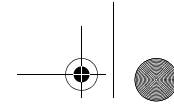

INPUT LIST

Press the **INPUT** button to display external device that is connected to the unit, on screen.

Press the **ENTER** button to change the input to the active external device. Use the **▲** or **▼** button to select the input source.

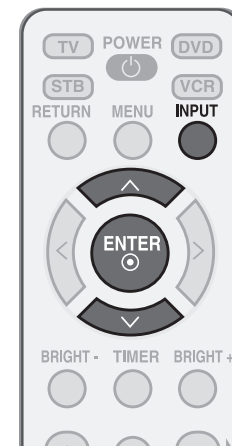
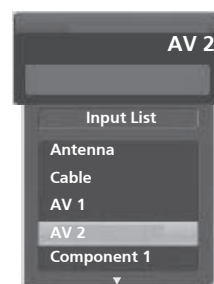

WATCHING TV / CHANNEL CONTROL

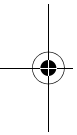

1 If all external input sources are connected:

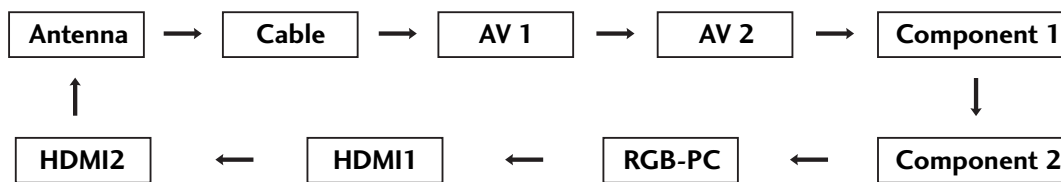

2 If no external input sources are not connected:



3 If there is any external input source connected:
(ex: When connected only to AV 2)

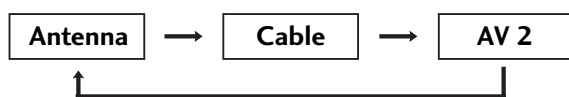

- **Antenna:** Select it to watch over-the-air broadcasts.
- **Cable:** Select it to watch cable and digital cable.
- **AV 1-2:** Select them to watch a VCR or other external equipment.
- **Component 1-2:** Select them to watch DVD or a Digital set-top box.
- **RGB-PC:** Select it to view PC input.
- **HDMI1-2:** Select them to watch high definition devices.



WATCHING TV / CHANNEL CONTROL

INPUT LABEL

You can set a label for each input source when it's not in use.

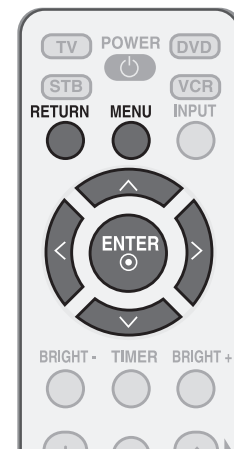

WATCHING TV / CHANNEL CONTROL

- 1 Press the **MENU** button and then use **^** or **v** button to select the **OPTION** menu.

- 2 Press the **>** button and then use **^** or **v** button to select **Input Label**.

- 3 Press the **>** button and then use **^** or **v** button to select the source: AV 1, AV 2, Component 1, Component 2, RGB-PC, HDMI1, or HDMI2.

- 4 Press the **<** or **>** button to select the label.

- 5 Press **RETURN** button to return to TV viewing or press **MENU** button to return to the previous menu.

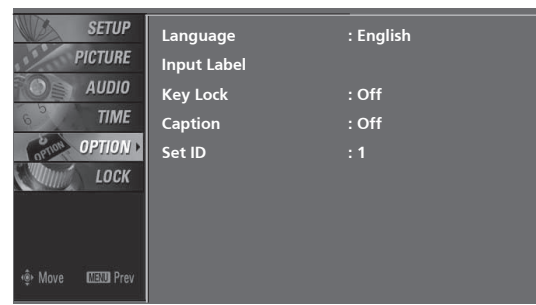

1

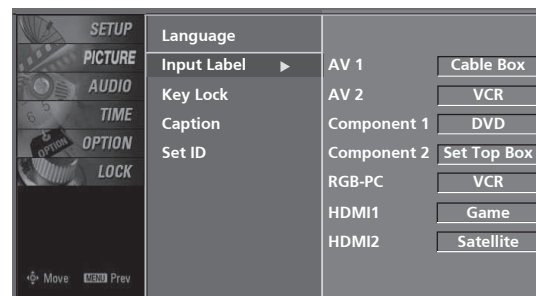

2 3 4