



OWNER'S MANUAL

DUAL FUEL RANGE

Read this owner's manual thoroughly before operating the appliance and keep it handy for reference at all times.

WARNING

If the information in this manual is not followed exactly, a fire or explosion may result causing property damage, personal injury or death.

- **Do not store or use gasoline or other flammable vapors and liquids in the vicinity of this or any other appliance.**
- **WHAT TO DO IF YOU SMELL GAS**
 - **Do not try to light any appliance.**
 - **Do not touch any electrical switch.**
 - **Do not use any phone in your building.**
 - **Immediately call your gas supplier from a neighbor's phone. Follow the gas supplier's instructions.**
 - **If you cannot reach your gas supplier, call the fire department.**
- **Installation and service must be performed by a qualified installer, service agency, or the gas supplier.**

SKSDR480SIS



MFL68920520_00

www.thesignaturekitchen.com

Copyright © 2017 Signature Kitchen Suite. All Rights Reserved.

TABLE OF CONTENTS

4 IMPORTANT SAFETY INSTRUCTIONS

15 PRODUCT OVERVIEW

- 15 Parts
- 15 Accessories

16 INSTALLATION

- 16 Installation Overview
- 16 Product Specifications
- 17 Before Installing the Range
- 19 Ventilation Requirement
- 19 Proper Location
- 22 Gas Supply
- 22 Electrical Supply
- 22 Installing the Range
- 26 Connecting the Range to Gas
- 27 Connecting Electricity
- 30 Engaging the Anti-tip Device
- 31 Test Run
- 31 Checking Ignition of the Surface Burners

33 OPERATION

- 33 Control Panel Overview
- 34 Getting Started
- 34 Changing Oven Settings
- 39 Using the Cooktop
 - 39 Gas Cooktop Module
 - 39 Cooktop Timers
- 40 The Gas Surface Burners
 - 40 Before Use
 - 40 Using the Gas Surface Burners
 - 41 Setting the Flame Size
 - 41 In Case of Power Failure
 - 41 Cookware for Gas Burners
 - 42 Extra Low Simmer (Small Burners Only)
 - 42 Using a Wok
 - 43 Using Stove-Top Grills

- 43 Induction Cooktop (On Some Models)
 - 43 Benefits of Induction Surface Cooking
 - 44 Induction Cookware
 - 44 Cookware Placement
 - 45 Moving Cookware on the Cooktop
 - 45 Pan Sensing
 - 45 Setting Surface Controls
 - 46 Hot Surface Indicator
 - 46 Using the Cooking Elements
 - 46 Flex Mode
 - 47 The Recommended Surface Cooking Setting
 - 47 Pan Preheat Recommendations
 - 47 Noises during Induction Operation
 - 47 Power Management
- 48 Sous Vide (On Some Models)
 - 48 Vacuum Sealing
 - 48 Using Sous Vide
 - 49 Using the Rack
 - 49 No Preheating Cooking
 - 49 Moving the Sous Vide Bath
 - 50 Setting the Temperature
 - 50 Setting the Cook Time
 - 51 Using Oven Racks
 - 51 Filling the Water
 - 51 Sous Vide Cook Guide
- 52 Using the Oven
 - 52 Before Using the Oven
 - 52 Oven Vent
 - 52 Using Oven Racks
 - 53 Accessories for Right Oven
 - 53 Accessories for Left Oven
 - 54 Timer
 - 54 Bake
 - 55 Convection Modes
 - 56 Rapidheat Roast
 - 57 Recommended Baking and Roasting Guide
 - 58 Broil
 - 59 Recommended Broiling Guide
 - 60 Warm
 - 60 Proof
 - 61 Probe
 - 62 My Recipe
 - 62 Auto Cook
 - 63 Steam Function(Left Oven Only)
 - 64 Remote Start

65 SMART FUNCTIONS

- 65 SIGNATURE KITCHEN SUITE Application
- 66 Smart Diagnosis™ Function
- 67 Open Source Software Notice Information
- 68 FCC Notice
- 68 FCC RF Radiation Exposure Statement

69 MAINTENANCE

- 69 Control Panel
- 69 Gas Surface Burners
- 70 Burner Grates
- 70 Gas Cooktop Surface
- 71 Sous Vide Module
- 71 Induction Cooktop
- 73 Exterior
- 74 Front Manifold Panel and Knobs
- 75 SpeedClean™ (Right Oven)
- 77 SpeedClean™ (Left Oven)
- 77 Self Clean (Right Oven Only)
- 79 Oven Air Vents
- 79 Steam Feeder Tank
- 80 Descaling
- 80 Drying
- 80 Evaporation
- 81 Removing and Replacing the Lift-Off Oven Doors

82 TROUBLESHOOTING

- 82 FAQs
- 84 Before Calling for Service

88 WARRANTY

IMPORTANT SAFETY INSTRUCTIONS

Read and follow all instructions when using the range to prevent the risk of fire, electric shock, personal injury, or damage. This guide does not cover all possible conditions that may occur. Always contact your service agent or manufacturer about problems that you do not understand.

Download this owner's manual at: www.thesignaturekitchen.com



This is the safety alert symbol. This symbol alerts you to potential hazards that can result in property damage and/or serious bodily harm or death.

All safety messages will follow the safety alert symbol and either the word WARNING or CAUTION. These words mean:



WARNING - Indicates a hazardous situation which, if not avoided, could result in death or serious injury.



CAUTION - Indicates a hazardous situation which, if not avoided, could result in minor or moderate injury.

ANTI-TIP DEVICE



WARNING

- **TO REDUCE THE RISK OF TIPPING, THE APPLIANCE MUST BE SECURED BY A PROPERLY INSTALLED ANTI-TIP DEVICE. TO CHECK IF THE DEVICE IS INSTALLED PROPERLY, VERIFY THAT THE ANTI-TIP DEVICE IS ENGAGED, OR GRASP THE TOP REAR EDGE OF THE RANGE BACK GUARD AND CAREFULLY ATTEMPT TO TILT IT FORWARD.** Refer to the installation section for instructions.
 - A child or adult can tip the range and be killed.
 - Install the anti-tip device to the structure and/or the range. Verify the anti-tip device has been properly installed and engaged following the instructions on the anti-tip bracket template.
 - Engage the range to the anti-tip device following the instructions on the anti-tip bracket template. Ensure the anti-tip device is re-engaged when the range is moved by following the instruction on the anti-tip bracket template.
 - Re-engage the anti-tip device if the range is moved. Do not operate the range without the anti-tip device in place and engaged.
 - See installation instructions for details.
 - Failure to do so can result in death or serious burns to children or adults.
-
- Never remove the oven legs. The range will not be secured to the anti-tip bracket if the legs are removed.
 - Do not step or sit on the oven door. The range could be tipped and injury might result from spilled hot liquid, food, or the range itself.
 - Do not rest large, heavy items such as whole turkeys on the open oven door. The range could tip forward and cause injury.
 - Reengage the anti-tip device after pulling the range out for cleaning, service, or any other reason.
 - Failure to follow these instructions can result in death or serious burns to children or adults.

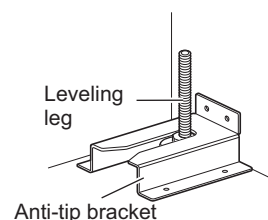

INSTALLATION SAFETY PRECAUTIONS

Have the installer show you the location of the range gas shut-off valve and how to shut it off if necessary.

WARNING

- Make sure the range is properly installed and grounded by a qualified installer, according to the installation instructions. Any adjustment and service should be performed only by qualified gas range installers or service technicians.
- Make sure the range is properly adjusted by a qualified service technician or installer for the type of gas (natural or LP) that is to be used. The range can be converted for use with either type of gas. See the installation instructions.
- These adjustments must be done by a qualified service technician according to the manufacturer's instructions and all codes and requirements of the authority having jurisdiction. Failure to follow these instructions could result in serious injury or property damage. The qualified agency performing these adjustments assumes responsibility for the conversion.
- Disconnect the electrical supply before servicing the appliance.
- Never use the appliance door as a step stool or seat, as this may result in tipping of the appliance and serious injuries.
- This product should not be installed below ventilation type hood systems that direct air in a downward direction.
Doing so may cause ignition and combustion problems with the cooktop resulting in personal injury and may affect the cooking performance of the unit.
- To prevent fire hazard or electrical shock, do not use an adapter plug or an extension cord, or remove the grounding prong from the electrical power cord. Failure to follow this warning can cause serious injury, fire or death.
- To prevent poor air circulation, place the range out of the kitchen traffic path and out of drafty locations.
- Do not attempt to repair or replace any part of the range unless it is specifically mentioned in this manual. All other services should be referred to a qualified technician.
- Make sure that all packaging materials are removed from the range before operating it to prevent fire or smoke damage should the packaging material ignite.
- After using the range for an extended period of time high floor temperatures may result. Many floor coverings will not withstand this kind of use.
- Never install the range over vinyl tile or linoleum that cannot withstand such type of use. Never install it directly over interior kitchen carpeting.

SAFETY PRECAUTIONS

The Safe Drinking Water and Toxic Enforcement Act requires the Governor of California to publish a list of substances known to the state to cause birth defects or other reproductive harm, and requires businesses to warn customers of potential exposure to such substances. Gas appliances can cause minor exposure to four of these substances, namely benzene, carbon monoxide, formaldehyde and soot, caused primarily by the imperfect combustion of natural or LP gas. Correctly adjusted burners, indicated by a bluish rather than a yellow flame, will minimize imperfect combustion. Exposure to these substances can be minimized by opening windows or using a ventilation fan or hood.

WARNING

This product contains chemicals known to the State of California to cause cancer and birth defects or other reproductive harm. ***Wash hands after handling. (US only)***

- **DO NOT TOUCH HEATING ELEMENTS OR INTERIOR SURFACES OF OVEN.** Heating elements may be hot even though they are dark in color. Interior surfaces of an oven become hot enough to cause burns. During and after use, do not touch or let clothing or other flammable materials contact heating elements or interior surfaces of oven until they have had sufficient time to cool. Other surfaces, such as oven vent openings and surfaces near these openings, oven doors, and windows of oven doors, also get hot and may cause burns if not cooled.
- **Use care when opening door.** The hot air and steam that escape can cause burns to hands, face and eyes. Let hot air or steam escape from the oven before removing or replacing food in the oven.
- Do not repair or replace any part of the appliance unless specifically recommended in the manual. All other servicing should be performed by a qualified technician.
- Do not use harsh etching, abrasive cleaners or sharp metal scrapers to clean the oven door glass since they can scratch the surface. Scratches may cause the glass to shatter.

WARNING

If the door glass, surface, or oven heating unit of the range are damaged, discontinue use of the range and call for service.

- Do not use plastic to cover food. Use foil or oven-safe lids only.
- Do not allow anyone to climb, stand or hang on the door or cooktop. They could damage the range and even tip it over, causing severe personal injury.
- Do not line the oven walls, racks, bottom, or any other part of the oven with aluminum foil or any other material. Doing so will disrupt heat distribution, produce poor baking results and cause permanent damage to the oven interior (aluminum foil will melt to the interior surface of the oven)
- Never attempt to dry a pet in the oven.
- **Never use your appliance for warming or heating the room.**
- Always use pot holders or oven mitts when removing food from the oven or the surface element. Cookware will be hot. **Use only dry pot holders.** Moist or damp pot holders on hot surfaces may result in burns from steam. Do not let the pot holder touch hot heating elements. Do not use a towel or other bulky cloth to remove food.
- **Do not heat unopened food containers.** Pressure in the containers may cause them to burst which may result in injury.
- Large scratches or impacts to glass doors can lead to broken or shattered glass.
- Leak testing of the appliance must be conducted according to the manufacturer's instructions.

- To eliminate the risk of burns or fire by reaching over heated surface units, cabinet storage space located above the surface units should be avoided. If cabinet storage is to be provided, the risk can be reduced by installing a range hood that projects horizontally a minimum of 5 inches beyond the bottom of the cabinets.

WARNING

- Gas leaks may occur in the system and result in a serious hazard. Gas leaks may not be detected by smell alone. Gas suppliers recommend you purchase and install a UL approved gas detector. Install and use in accordance with the gas detector manufacturer's instructions.
- To prevent staining or discoloration, clean appliance after each use.
- Do not attempt to open or close the door or operate the oven until the door is properly installed.
- Never place fingers between the hinge and front oven frame. Hinge arms are spring mounted. If accidentally hit, the hinge will slam shut against the oven frame and injure your fingers.

CAUTION

- Wear gloves when cleaning the range to avoid injury or burns.
- Do not use the oven for storing food or cookware.
- To prevent damage to the oven door, do not attempt to open the door when Lock is displayed.
- Do not stand or place excessive weight on an open door. This could tip the range, break the door, or injure the user.
- Do not use delayed baking for highly perishable foods such as dairy products, pork, poultry, or seafood.

FLAMMABLE MATERIALS

WARNING

Be certain that all packing materials are removed from the appliance before operating. Keep plastic, clothes, paper, and other flammable materials away from parts of the appliance that may become hot.

- Do not store or use flammable material in the oven or near or on the cooktop. Flammable materials include paper, plastic, pot holders, linens, wall coverings, curtains, and gasoline or other flammable vapors and liquids such as grease or cooking oil. These materials can be ignited when the oven and cooktop are in use.
- **Wear proper apparel.** Do not wear loose-fitting or hanging garments, which may ignite if they contact hot surfaces, and cause severe burns.
- Do not use the oven for drying clothes. Only use the oven for its intended purpose.
- If a cabinet storage is provided directly above cooking surface, place items that are not frequently used and can be safely stored in an area subjected to heat. Temperatures may be unsafe for volatile items such as flammable liquids, cleaners or aerosol sprays.

ELECTRICAL SAFETY

CAUTION

Be certain that all packing materials are removed from the appliance before operating. Keep plastic, clothes, paper, and other flammable materials away from parts of the appliance that may become hot.

- Always disconnect power from the appliance before servicing.
- Do not use aluminum foil or any other material to line the oven bottom. Improper installation of these liners may result in a risk of electric shock or fire.
- Do not allow aluminum foil or the temperature probe to contact heating elements.

DEEP FAT FRYER

- Use extreme caution when moving or disposing of hot grease.
- Always heat fat slowly, and watch as it heats.
- If frying combinations of oils and fats, stir them together before heating.
- Use a deep fat thermometer, if possible, to prevent overheating fat beyond the smoking point.
- Use the least possible amount of fat for effective shallow or deep-fat frying. Filling the pan with too much fat can cause spillovers when food is added.

CHILD SAFETY

- Do not leave small children unattended near the oven.

WARNING

Do not leave children alone or unsupervised near the appliance when it is in use or is still hot. Children should never be allowed to sit or stand on any part of the appliance as they could be injured or burned.

CAUTION

Do not store items of interest to children in cabinets above a range or on the back guard of a range – children climbing on the range to reach items could be seriously injured.

- Never let a child hang on the oven door.
- Do not allow children to crawl into the oven.
- Let hot utensils cool in a safe place, out of reach of small children.
- Children should not be allowed to play with controls or other parts of the appliance.

SURFACE BURNERS

WARNING

- Even if the top burner flame goes out, gas is still flowing to the burner until the knob is turned to the **Off** position. If you smell gas, immediately open a window and ventilate the area for five minutes prior to using the burner. Do not leave the burners on unattended.
- **Use proper pan size.** Do not use pans that are unstable or that can be easily tipped. Select cookware with flat bottoms large enough to cover burner grates. To avoid spillovers, make sure the cookware is large enough to contain the food properly. This will both save cleaning time and prevent hazardous accumulations of food, since heavy spattering or spillovers left on the range can ignite. Use pans with handles that can be easily grasped and remain cool.

CAUTION

- Be sure that all surface controls are set in the **Off** position prior to supplying gas to the range.
- Never leave the surface burners unattended at high flame settings. Boilovers may cause smoke and greasy spillovers that may ignite.
- Always turn the knobs to the **Lite** position when igniting the top burners and make sure the burners have ignited.
- Control the top burner flame size so it does not extend beyond the edge of the cookware. Excessive flame is hazardous.
- Only use dry pot holders- moist or damp pot holders on hot surfaces may result in burns from steam. Do not let pot holders come near open flames when lifting cookware. Do not use towels or other bulky cloth items. Use a pot holder.
- If using glass cookware, make sure the cookware is designed for range-top cooking.
- To prevent burns from ignition of flammable materials and spillage, turn cookware handles toward the side or back of the range without extending them over adjacent burners.
- Never leave any items on the cooktop. The hot air from the vent may ignite flammable items and will increase pressure in closed containers, which may cause them to burst.
- Carefully watch foods being fried at a high flame setting.
- Always heat fat slowly, and watch as it heats.
- If frying combinations of oils and fats, stir together before heating.
- Use a deep fat thermometer if possible to prevent fat from heating beyond the smoking point.
- Use the least possible amount of fat for effective shallow or deep fat frying. Filling the pan with too much fat can cause spillovers when food is added.
- Do not cook foods directly on an open flame on the cooktop.
- Foods for frying should be as dry as possible. Frost or moisture on foods can cause hot fat to bubble up and spill over the sides of the pan.
- Never try to move a pan of hot fat, especially a deep fryer. Wait until the fat is cool.
- Do not place plastic items on the cooktop- they may melt if left too close to the vent.
- Keep all plastics away from the surface burners.
- To prevent burns, always be sure that the controls for all burners are in the **Off** position and all grates are cool before attempting to remove them.
- If you smell gas, turn off the gas to the range and call a qualified service technician. Never use an open flame to locate a leak.
- Always turn the knobs to the **Off** position before removing cookware.
- Do not lift the cooktop. Lifting the cooktop can cause damage and improper operation of the range.

 **CAUTION**

- If the range is located near a window, do not hang long curtains that could blow over the surface burners and catch on fire.
- Use care when cleaning the cooktop. The pointed metal ends on the electrodes could cause injury.
- Stand away from the range while frying.
- Keep an eye on foods being fried at high or medium high heat settings.

GLASS-CERAMIC COOKING SURFACE

- Surface units may be hot even though they are dark in color. Areas near surface units may become hot enough to cause burns. During and after use, **DO NOT TOUCH SURFACE UNITS OR AREAS NEAR UNITS** or let clothing or other flammable materials contact surface units or areas near units until they have had sufficient time to cool. This includes the Induction plate and the area above the oven door.
- **Do not cook on a broken induction plate.** If the induction plate is broken, cleaning solutions and spillovers may penetrate the broken induction plate and create a risk of electric shock. Switch off the appliance to avoid the possibility of electric shock and contact a qualified technician immediately.
- Do not use the glass induction plate surface as a cutting board.
- Do not place or store items that can melt or catch fire on the glass induction plate, even when it is not being used.
- Select pans that have flat bottoms large enough to cover the heating elements.
- **Glazed cookware.** Only certain types of glass, glass-ceramic, ceramic, earthenware, or other glazed cookware are suitable for range-top service without breaking due to the sudden change in temperature.
- Never cook directly on the glass. Always use cookware.
- Always turn the surface units off before removing cookware. Do not rely on the pan sensor.

 **WARNING**

Do not leave fats or oils to heat unattended on the cooktop. Spillovers can result in a fire.

- The Induction plate is not intended to be operated by means of an external timer or separate remote-control system.
- **Turn cookware handles inward so they don't extend over adjacent surface units.** This reduces the risk of burns, ignition of flammable materials, and spillage due to unintentional contact with the cookware.
- Immediately clean spills on the cooking area to prevent a tough cleaning chore later.
- Some cleaners can produce dangerous fumes if applied to a hot surface.
- Do not place metallic objects such as knives, forks, spoons, and lids on the Induction plate surface, because they can get hot.
- Always place the pan in the center of the surface unit you are cooking on. **Never leave surface units unattended at high heat settings.** Proper contact of cookware to burner also will improve efficiency. Boilovers cause smoking and greasy spills that may catch on fire.
- **Clean induction plate with caution.** Do not use sponges or cloth to wipe spills on a hot cooking area. Use a proper metal scraper. If a wet sponge or cloth is used to wipe spills on a hot cooking area, it can cause steam burns. Some cleaners can produce noxious fumes if applied to a hot surface.

- Do not turn surface units on before placing cookware.
- Do not store heavy items above the Induction plate surface that could fall and damage it.
- Do not place aluminum foil or plastic items such as salt and pepper shakers, spoon holders, or plastic wrappings or any other material on the range when it is in use.
- Do not use a steel-wool pad or scrub pad or abrasive cleaning pads. They can scratch the surface.

USING SOUS VIDE

CAUTION

- Use only food grade plastic bags or bags made from materials recommended by the manufacturer for use in cooking.
- Allow sous vide to cool before cleaning or draining the water bath.
- Make sure the water level in the sous vide pan remains between the minimum and maximum fill lines both before and after adding the food pouches.
- Do not operate the sous vide module if the water level is not between these lines. Doing so may result in electric shock or fire.
- Do not touch the water in the sous vide module until it has cooled. Use tongs to take out pouches in the water bath. Failure to follow this precaution can result in burns.
- Allow the sous vide module to cool before touching any surfaces. Use an oven mitt while operating the sous vide to avoid burns or other injury.
- Don't leave water in water bath after use. Allow the module to cool before draining the bath and drying it with a clean cloth.
- Do not place or store objects on the glass cover of the sous vide. Doing so can damage the cover.
- Only use pouches which are designed for vacuum sealing.
- Vacuum sealing does not prevent food from spoiling. Refrigerate perishable food.
- Sharp edges on food, such as bones or dried noodles, can puncture pouches during vacuum sealing. Wrap sharp edges with paper towels or softer food items.

FOOD PACKAGING AND STORAGE SAFETY INFORMATION

- Always wash your hands carefully with soap and water before and after handling food.
- Keep all work surfaces and utensils clean and disinfected before and after packaging foods.
- Temperature, moisture, acidity, and salt or sugar content of foods can influence the growth of potentially harmful microorganisms in food.
- For safety, vacuum-sealed fresh (perishable) foods should be kept in the "safe zones": cooled to 40°F/4°C or below or heated to 130°F/55°C or above.
- Vacuum-sealed pouches of cooked foods can be quick chilled by submerging them in ice water (half ice/half water) for 30 to 60 minutes and then refrigerated for up to 48 hours or frozen for up to a year.

USING STEAM FUNCTION

CAUTION

- Hot steam may cause scalding.
- Don't open the door and don't touch the vent holes while steam function is working.
- Use care when opening the door. The hot air and steam that escape can cause burns to hands, face and eyes. Let hot air or steam escape from the oven before opening the door.
- Steam may condense on the inside of the door. Do not wipe condensation off until the door has cooled.

ENERGY SAVING TIPS

- Multiple-rack cooking saves time and energy. Whenever possible, cook foods requiring the same cooking temperature together in one oven.
- For optimal performance and energy savings, follow the guides on page 37 for proper rack and pan placements.
- Match the size of the cookware to the amount of food being cooked to save energy when heating. Heating ½ quart of water requires more energy in a 3-quart pot than in a 1-quart pot.
- Match the size of the cooktop burner or element to the size of the cookware in use. Using a large element for a small pan wastes heating energy, and the exposed surface of the element is a burn or fire hazard.
- Reduce energy use by cleaning light oven soils with the SpeedClean™ feature instead of self-clean.
- Avoid opening the oven door more than necessary during use. This helps the oven maintain temperature, prevents unnecessary heat loss, and saves on energy use.

SAFETY DURING USE

- Do not touch the oven racks while they are hot.
- If a rack must be moved while the oven is hot, do not let the pot holder contact the hot heating element in the oven.
- Use caution with the Timed Cook or Delayed Timed Cook features. Use the automatic timer when cooking cured or frozen meats and most fruits and vegetables. Foods that can easily spoil, such as milk, eggs, fish, meat or poultry, should be chilled in the refrigerator first. Even when chilled, they should not stand in the oven for more than 1 hour before cooking begins, and should be removed promptly when cooking is complete. Eating spoiled food can result in sickness from food poisoning.
- Accessible parts may become hot when the grill is in use.
- Do not place food or cookware on the bottom of the oven cavity. Doing so will cause permanent damage to the oven bottom finish.
- **Do not use water on grease fires.** Should an oven fire occur, leave the oven door closed and turn the oven off. If the fire continues, throw baking soda on the fire or use a fire extinguisher. Do not put water or flour on the fire. Flour may be explosive and water can spread a grease fire and cause personal injury.
- When disposing of the range, cut off the power cord and remove the door.
- Do not make any attempt to operate the electric ignition oven during an electrical power failure.
- Pull the oven rack to the stop-lock position when loading and unloading food from the oven. This helps prevent burns caused by touching hot surfaces of the door and oven walls.
- Do not use the oven if a heating element develops a glowing spot during use or shows other signs of damage. A glowing spot indicates the heating element may fail and present a potential burn, fire, or shock hazard. Turn the oven off immediately and have the heating element replaced by a qualified service technician.
- When using cooking or roasting bags in the oven, follow the manufacturer's directions.

SAFETY WHEN CLEANING

- Open a window or turn on a ventilation fan or hood before self-cleaning.
- If the oven is heavily soiled with oil, self-clean the oven before using the oven again. The oil could cause a fire.
- Wipe up heavy soil on the bottom of the oven before using the Self Clean function.
- **Do not use oven cleaners.** Commercial oven cleaner or oven liner protective coating of any kind should not be used in or around any part of the oven.
- Never keep pet birds in the kitchen. The health of birds is extremely sensitive to the fumes released during an oven self-clean cycle. Fumes may be harmful or fatal to birds. Move birds to a well-ventilated room.
- Clean in the self-clean cycle only parts listed in this manual. Before self-cleaning the oven, remove the broiler pan, all oven racks, the meat probe and any utensils or food from the oven.
- Important Instruction. The oven displays an F error code and sounds three long beeps if it malfunctions during the self-cleaning process. Switch off the electrical power to the main fuse or breaker and have the oven serviced by a qualified technician.
- It is normal for the cooktop of the range to become hot during a self-clean cycle. Do not touch the cooktop during a self-clean cycle.
- Never pour cold water over a hot oven for cleaning. Doing so may cause the oven to malfunction.
- Make sure oven lights are cool before cleaning.
- **Do not clean door gasket.** The door gasket is essential for a good seal. Care should be taken not to rub, damage, or move the gasket.
- If there is a fire in the oven during self-clean, turn the oven off and wait for the fire to go out. Do not force the door open. Introduction of fresh air at self-clean temperatures may lead to a burst of flame from the oven. Failure to follow this instruction may result in severe burns.
- For your safety, do not use high-pressure water cleaners or steam jet cleaners to clean the product.

COOK MEAT AND POULTRY THOROUGHLY

- To protect against food-borne illnesses, cook meat and poultry thoroughly. The USDA has indicated the following as safe minimum internal temperatures for consumption:
 - Ground meats: 160 °F
 - All poultry: 165 °F
 - Beef, veal, pork, or lamb: 145 °F
 - Fish/seafood: 145 °F

PRODUCT OVERVIEW

Parts

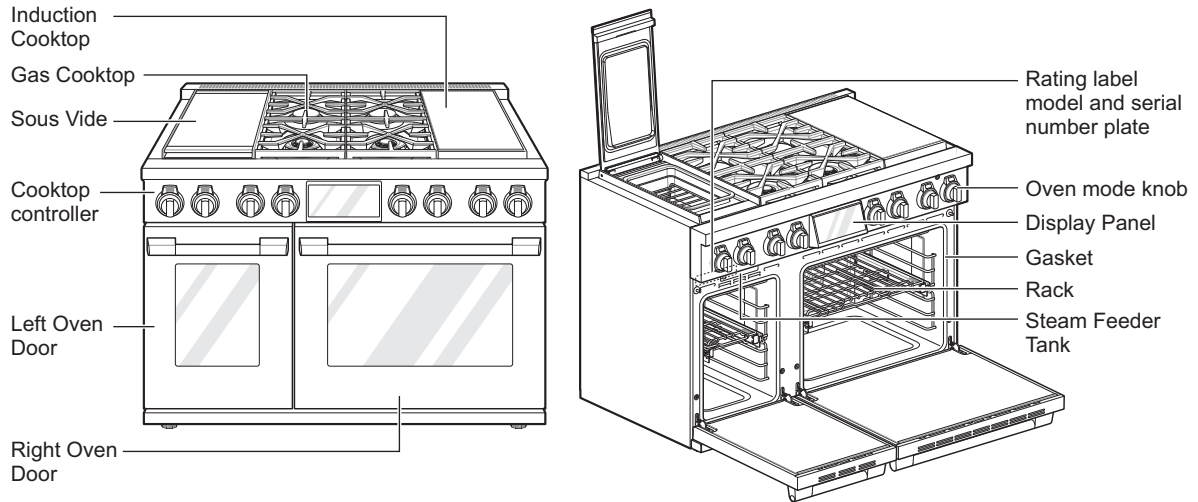

Accessories

Included Accessories

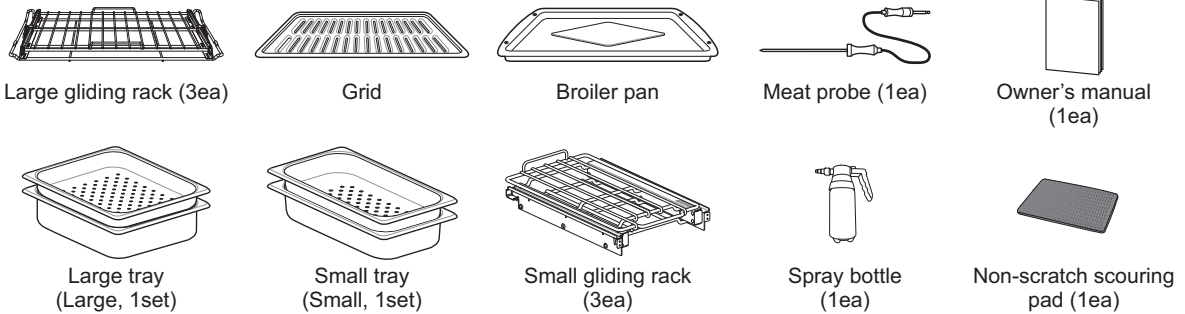

Anti-tip kit



LP nozzle conversion kit

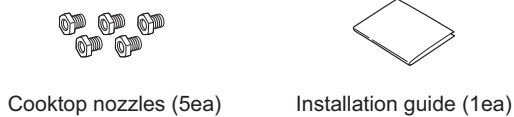

Sous Vide Module Accessories

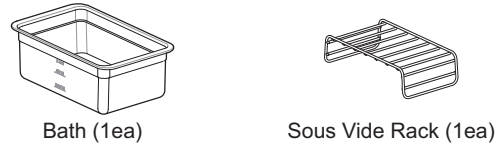

NOTE

- If accessories are missing, call 1-855-790-6655 or visit our website at : www.thesignaturekitchen.com
- For your safety and for extended product life, only use authorized components.
- The manufacturer is not responsible for product malfunction or accidents caused by the use of separately purchased, unauthorized components or parts.
- The images in this guide may be different from the actual components and accessories, which are subject to change by the manufacturer without prior notice for product improvement purposes.

INSTALLATION

Installation Overview

Please read the following installation instructions first after purchasing this product or transporting it to another location.

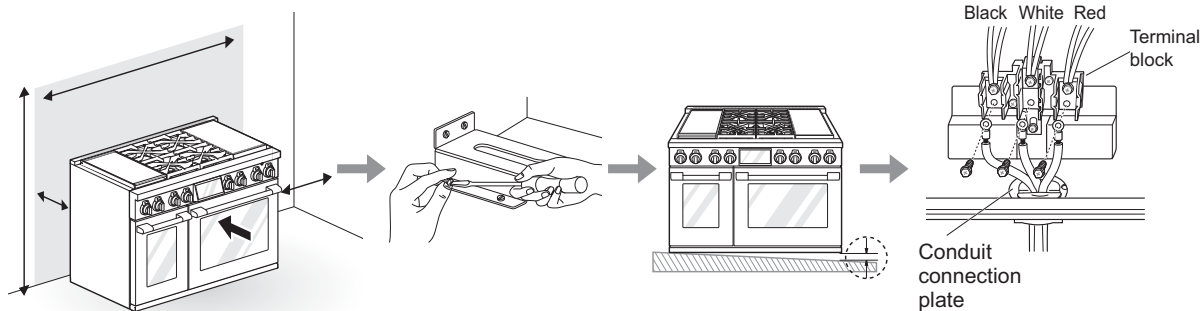

Check and choose the proper location

Install anti-tip device

Level the range

Connect electric range

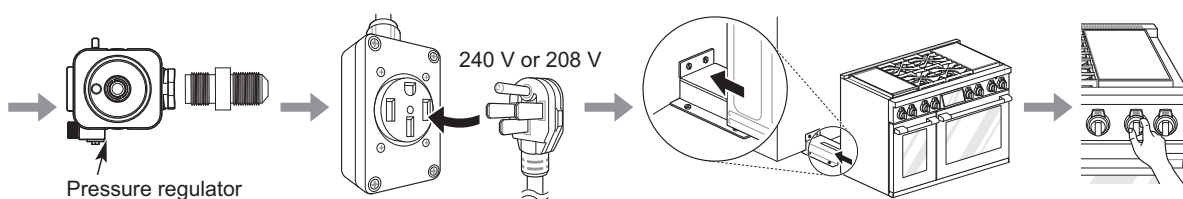

Pressure regulator

Connect the range to gas

Plug in the power cord

Engage the anti-tip device

Test run

Product Specifications

The appearance and specifications listed in this manual may vary due to constant product improvements.

Oven Range Models	SKSDR480SIS
Description	48" Duel Fuel Pro Range
Electrical requirements	13.5 kW 120/240 VAC, 10.5 kW 120/208 VAC
Exterior Dimensions	47 7/8" (W) x 35 7/64" (H) x 26 39/64" (D) (D with door closed) 121.6 cm (W) x 89.6 cm (H) x 67.6 cm (D) (D with door closed)
Height to cooking surface	36" (91.4 cm)
Net weight	529.1 lb (240 kg)
Total capacity	Right Oven : 5.2 cu.ft Left Oven : 2.7 cu.ft Total : 7.9 cu.ft

Before Installing the Range

WARNING

Tip - Over Hazard

A child or adult can tip the range and be killed. Verify the anti-tip bracket has been installed. Ensure the anti-tip bracket is engaged when the range is moved.



Do not operate the range without the anti-tip bracket in place. Failure to follow these instructions can result in death or serious burns to children and adults.

To check that leveling leg is inserted into anti-tip bracket, grasp the top rear edge of the range and carefully attempt to tilt it forward.

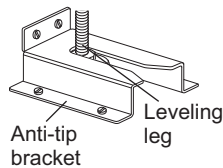

WARNING

- **Leveling legs must be extended lower than wheels to prevent range from moving.** This range is designed with wheels to make installation easier. During installation, make sure to extend the leveling legs until the wheels are lifted off the ground. Failure to do so can result in death or serious injury to children and adults.

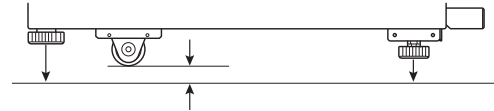

If you did not receive an anti-tip bracket with your purchase, call 1-855-790-6655 (Signature Kitchen Suite) to receive one at no charge.

WARNING

- **The information in this manual should be followed exactly.** Failure to do so may result in fire, electrical shock, property damage, personal injury, or death.
- **Wear gloves during the installation procedure.** Failure to do so can result in bodily injury.
- Make sure no parts came loose during shipping.

In the Commonwealth of Massachusetts

- This product must be installed by a licensed plumber or gas fitter.
- When using ball type gas shut-off valves, they must be the T-handle type.
- When using a flexible gas connector, it must not exceed 3 feet in length.

NOTE

- Observe all governing codes and ordinances.
- Have the installer show you the location of the circuit breaker or fuse. Mark it for easy reference.
- As when using any appliance generating heat, follow basic safety precautions.
- Be sure your range is installed and grounded properly by a qualified installer or service technician according to the installation instructions.
- Any adjustment and service should be performed only by qualified gas range installers or service technicians.

Preparing for Installation

Tools Needed

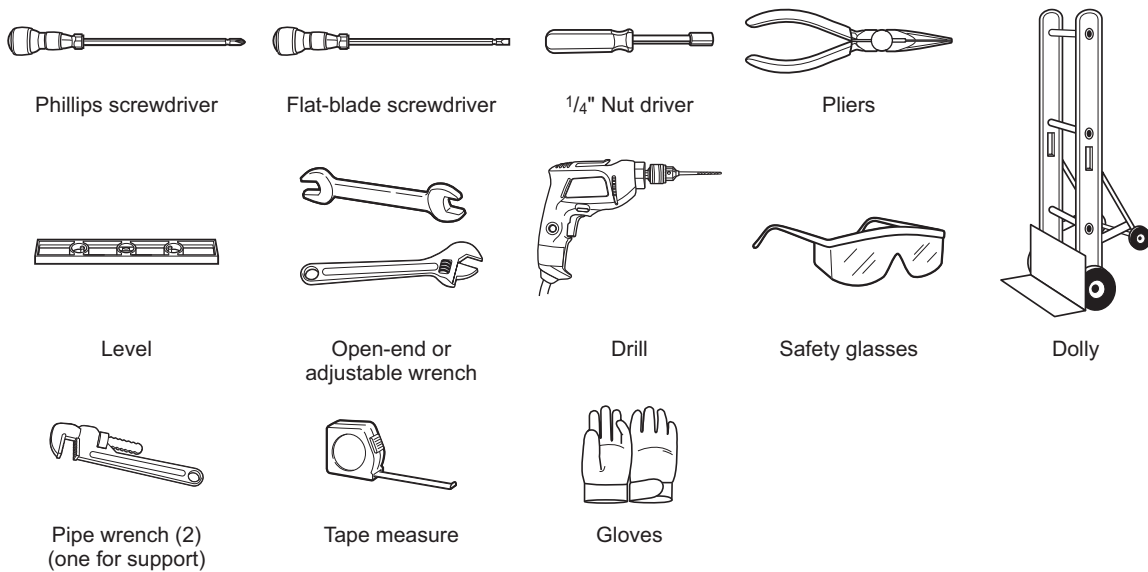

Parts Provided

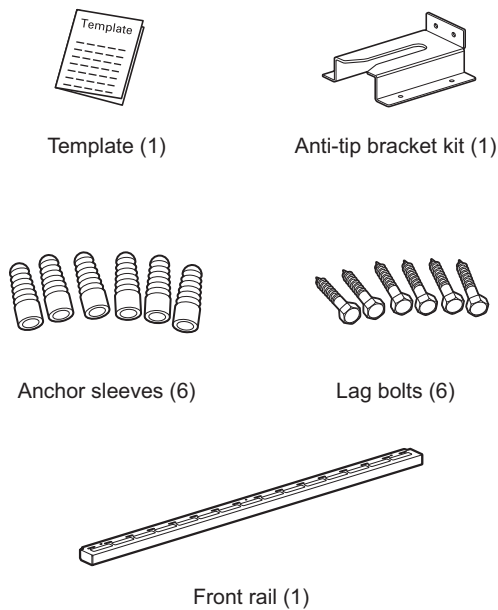

Parts not Provided

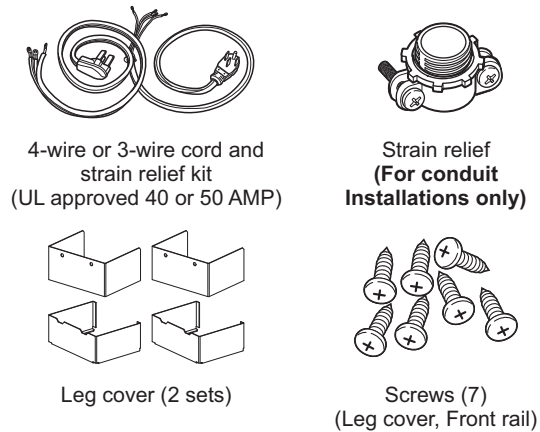

Materials You May Need

- Gas line shut-off valve
- Pipe joint sealant that resists action of natural and LP gases
- Flexible metal appliance connector (3/4" or 1/2" NPT x 1/2" I.D.)
Never use an old connector when installing a new range.
- Flare union adapter for connection to gas supply line (3/4" or 1/2" NPT x 1/2" I.D.)
- Flare union adapter for connection to pressure regulator on range (1/2" NPT x 1/2" I.D.)
- Liquid leak detector or soapy water
- Lag bolt or 1/2" O.D. sleeve anchor (for concrete floors only)

Ventilation Requirement

It is recommended that these ranges be installed in conjunction with a suitable overhead vent hood.

- Install a hood with at least 1200 CFM above a 48" wide range.
- Install a hood with at least 600 CFM above a 30" or 36" range.

Due to the high heat capacity of this unit, particular attention should be paid to the hood and ductwork installation to assure it meets local building code.

WARNING

Do not install this product with an air curtain hood or other range hood that operates by blowing air down on the cooktop. This airflow may interfere with operation of the gas burners resulting in fire or explosion hazard.

See below for the minimum clearance from the cooking surface to any horizontal surface above the range. Failure to observe this clearance may result in a fire hazard.

- Installations without a hood require a 48" minimum distance to any overhead combustible surface.
- Installations with custom hoods containing exposed horizontal combustible surfaces require a hood with at least 600 CFM at least 36" above the cooking surface.
- For other hood installations, refer to the installation instructions included with the hood for specific clearances.

Proper Location

- The range is a free standing unit. If the unit is to be placed adjacent to cabinets, the clearances shown in "Install Clearance" are required. The same clearances apply to island installations, except for overhead cabinets, which must have a space wide enough to accept the flared island hood.
- The range should not be recessed into the cabinets beyond the edge of the front face of the oven. (see "Product Dimensions and Clearances")
- The maximum depth of overhead cabinets installed on either side of the hood is 13"(330mm). Wall cabinets must be 18" (457mm) above the countertop.
- There is a 36" (914 mm) minimum clearance required between the top of the cooking surface and the bottom of an unprotected cabinet. A 30" (762 mm) clearance can be used when the bottom of the wood or metal cabinet is protected by not less than 1/4" (6 mm) of a flame retardant material covered with not less than No. 28 MSG sheet steel, 0.015" (0.38 mm) thick stainless steel, 0.024" (0.61 mm) aluminum, or 0.02" (0.51 mm) thick copper.

CAUTION

- **Avoid placing cabinets above the range.** To minimize the hazard caused by reaching over the open flames of operating burners, install a ventilation hood over the range that projects forward at least five inches beyond the front of the cabinets.
- **Do not locate your range where it may be subject to strong drafts.** Any openings in the floor or wall behind the range should be sealed. Make sure the openings around the base of the range that supply fresh air for combustion and ventilation are not blocked by carpeting or woodwork.
- **This range is for indoor, household use only.**
- **If the range is located near a window, do not hang long curtains or paper blinds on that window.**
- **Make sure wall covering, countertop and cabinets around the range can withstand the heat (up to 194 °F) generated by the range.** Discoloration, delamination or melting may occur. This range has been designed to comply with the maximum allowable wood cabinet temperature of 194 °F.
- **Before installing the range in an area covered with linoleum or other synthetic floor covering, make sure the floor covering can withstand temperatures of at least 160 °F(70°C).**
- **Use an insulated pad or 1/4 in. (0.64 cm) plywood under the range if installing the range over carpeting.**

When the floor covering ends at the front of the range, the area that the range will be installed on should be built up with plywood to the same level or higher than the floor covering. This will allow the range to be moved for cleaning and servicing, as well as provide proper air flow to the range.

NOTE

- All models require 12" minimum clearance to a vertical combustible surface at the rear. If clearance is less than 12", the entire surface of the back wall above and the full width of the range must be protected by a backsplash. The backsplash must be constructed of non-combustible material, such as metal, ceramic tile, brick, marble or other stone.

Install Clearance

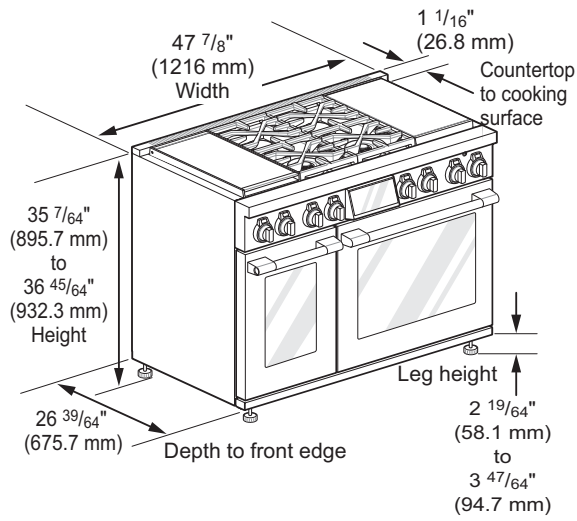

WARNING

- The surface of the entire back wall above the range and below the hood must be covered with a noncombustible material such as metal, ceramic tile, brick, marble or other stone.

Universal Utility Locations

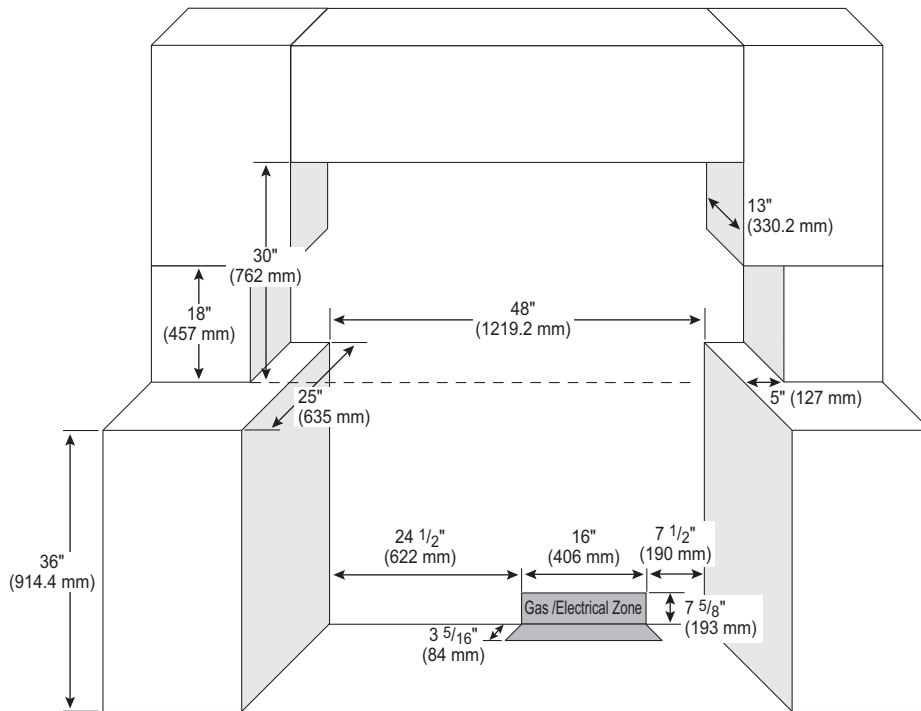

Product Dimensions and Clearances

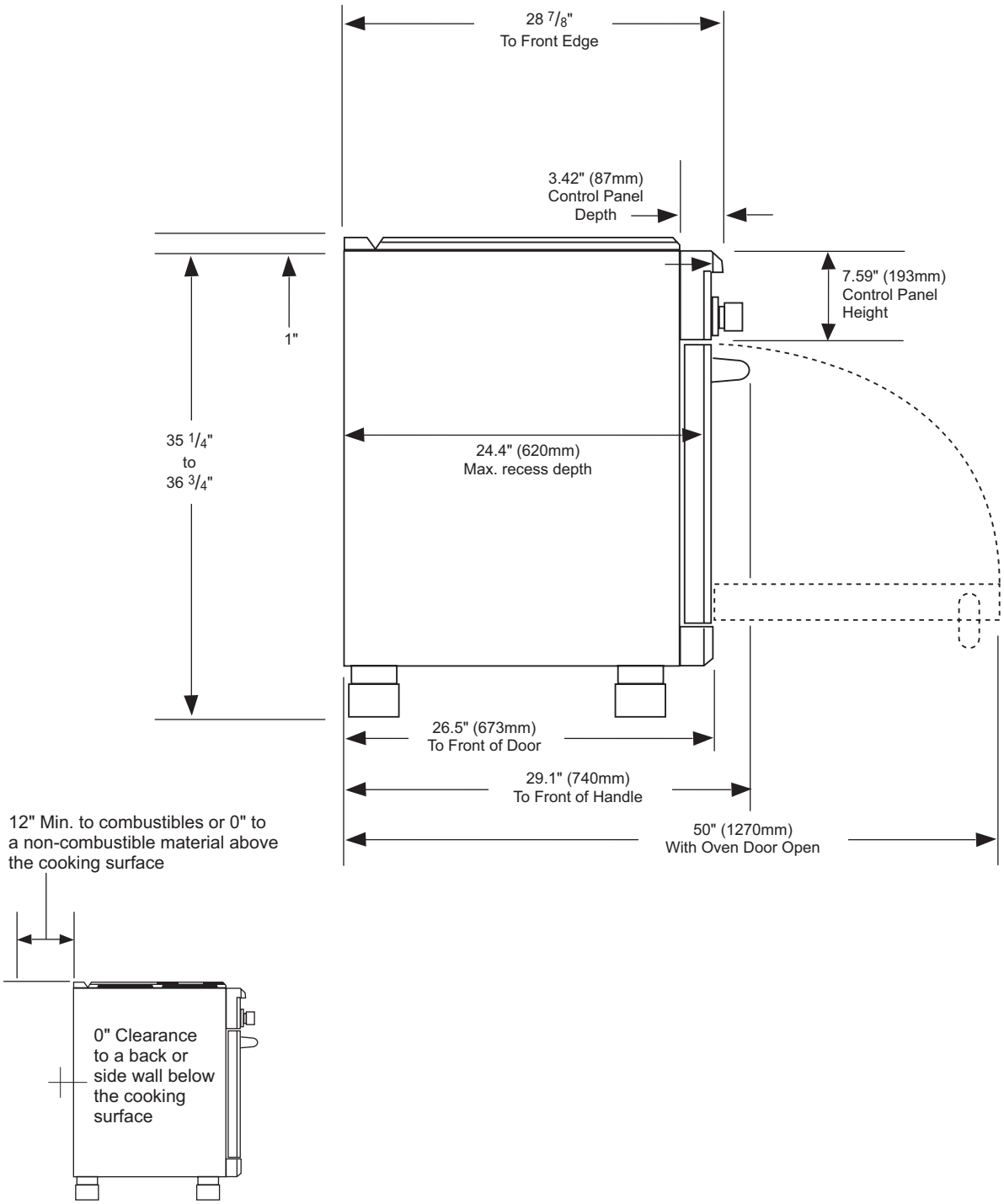

Gas Supply

The range is designed to operate at a pressure of 5" of water column on natural gas or 10" of water column on LP.

Make sure you are supplying the range with the type of gas for which it is configured.

This range is convertible for use with natural or LP gas. When using this range with LP gas, conversion must be made by a qualified LP installer before attempting to operate the range.

For proper operation, the pressure of natural gas supplied to the regulator must be between 5" and 13" of water column.

For LP gas, the pressure supplied to the regulator must be between 10" and 13" of water column. When checking for correct operation of the regulator, the inlet pressure must be at least 1" more than the operating (manifold) pressure as given above.

The pressure regulator located at the inlet of the range must remain in the supply line regardless of which type of gas is being used.

A flexible metal appliance connector used to connect the range to the gas supply line should have an I.D. of $\frac{5}{8}$ " and a maximum length of 5 feet. In Canada, flexible connectors must be single wall metal connectors less than 6 feet in length.

Electrical Supply

Installation of the range must be planned so that the rough in of the terminal block for the receptacle or conduit connection will allow maximum clearance to the rear of the unit.

When the power supply cord or conduit is connected to the mating receptacle or terminal block cover, the combined connection should protrude no more than 2" (51 mm) from the rear wall.

NOTE

Canadian models have the power cord supplied with the range.

Power Cord & Receptacle
2" (51 mm) maximum
when plugged in

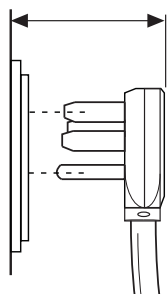

Junction Box & Conduit
2" (51 mm)
maximum

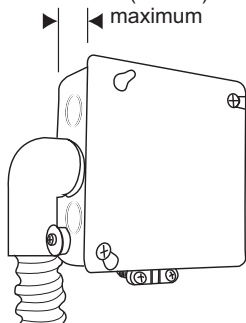

Installing the Range

Unpacking the Range

⚠ CAUTION

- **You should use 2 or more people to move and install the range. (Excessive Weight Hazard)** Failure to do so can result in back or other injury.
- **Do not use the door handles to push or pull the range during installation or when moving the range out for cleaning or service.** Doing so can result in serious damage to the door of the range.

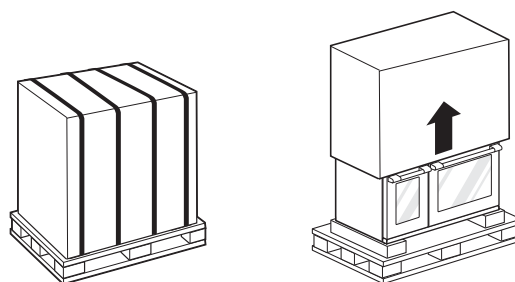

- 1 Cut the packing straps. Lift the carton straight up. Remove packing material, tape and any temporary labels from your range before using but leave the adhesive-backed foam layer over the brushed-metal surface, to protect the finish from scratches. Do not remove any warning-type labels, the model and serial number label, or the Tech Sheet that is located on the back of the range.
- 2 Remove the door(s). This will reduce the weight of the range during installation.
- 3 The grates, burner heads, burner caps, trays and oven racks must be removed to facilitate handling. Do not remove the griddle element.

NOTE

Doors and passageways leading to the installation location require at least 32" opening. If the opening is less than 32", the oven door(s) and control knobs must be removed.

Moving the Range

CAUTION

- Do not lift the range by the oven door's handle, as this may damage the door hinges and cause the door to fit incorrectly.
- Do not lift the appliance by the range's control panel.
- Rings, watches, and any other loose items that may damage the unit or otherwise might become entangled with the unit should be removed.
- Hidden surfaces may have sharp edges. Use caution when reaching behind or under the appliance.
- Do not use a hand truck or appliance dolly on the back or front of the unit. Handle from the side only.
- Due to the weight, it is strongly recommended that a furniture dolly with soft wheels or an air lift be used to move this unit. The weight must be supported uniformly across the bottom.
- All ranges are held to the pallet by (4) brackets through a wood block

- 1 Remove the two screws on each bracket that secure the product to the pallet.

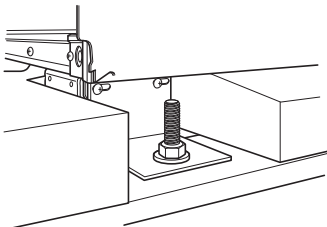

- 2 Remove both oven doors.

NOTE

- Instructions for removing the oven doors can be found in the Maintenance section of this manual.

- 3 Carefully tilt the range from the side and insert a dolly under the range to remove the range from the pallet. Use additional help as required to remove the product from the pallet. To prevent damage to the sides of the range, it will be necessary to pad the corners beneath the straps on the dolly.

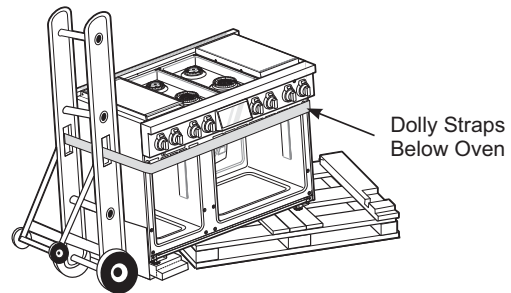
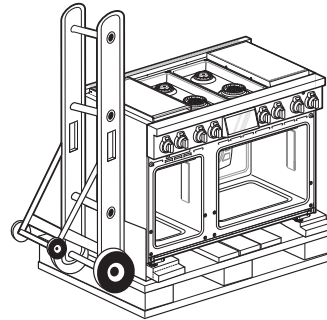

- 4 Transport the range on the furniture dolly close to its final location, tip the range back to level, and carefully remove the dolly.

Installing the Anti-tip Device

WARNING

Tip - Over Hazard

A child or adult can tip the range and be killed. Verify the anti-tip bracket has been installed. Ensure the anti-tip bracket is engaged when the range is moved. Do not operate the range without the anti-tip bracket in place. Failure to follow these instructions can result in death or serious burns to children and adults.



To check that leveling leg is inserted into anti-tip bracket, grasp the top rear edge of the range and carefully attempt to tilt it forward.

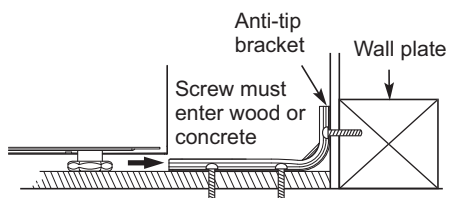
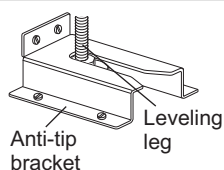

Locate the anti-tip bracket using the template.

An anti-tip bracket is packaged with the template. The instructions include necessary information to complete the installation. Read and follow the range installation instruction sheet (template).

WARNING

- A child or adult can tip the range and be killed.
- Install the anti-tip device to the structure and/or the range. Verify the anti-tip device has been properly installed and engaged by following the instructions on this template.
- Engage the range to the anti-tip device following the instructions on this template. Ensure the anti-tip device is reengaged when the range is moved by following the instructions on this template.
- Re-engage the anti-tip device if the range is moved. Do not operate the range without the anti-tip device in place and engaged.
- See installation instructions for details.
- Failure to do so can result in death or serious burns to children or adults.

Leveling the Range

Front Legs

Level the range by adjusting the leveling legs with a wrench. Extending the legs slightly may also make it easier to insert the rear leg into the anti-tip bracket.

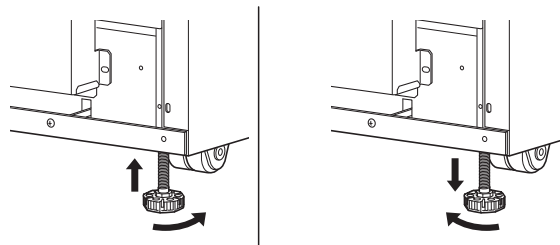

Back Legs

To adjust the rear leveling legs, remove the 3 screws at the front of the vent trim and remove the trim.

Use an adjustable 7 mm box wrench to turn the rear leg extension rods at each corner.

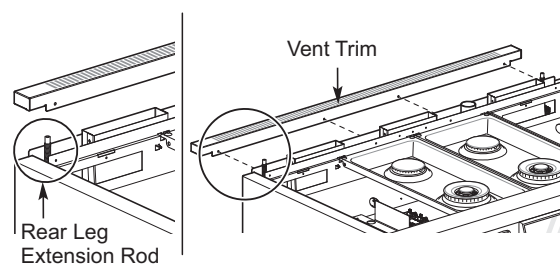

Use a level to check your adjustments. Place the level diagonally on the oven rack, and check each direction for level.

First check direction ①.

Then check direction ②. If the level doesn't show level on the rack, adjust the leveling legs with a wrench.

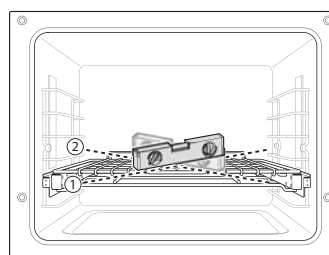

Installing the Leg Cover

- 1 Remove the plastic covers from the stainless steel leg covers.
- 2 Slide each small leg cover inside a larger leg cover. Cutouts should face up and both covers should be open at the back.

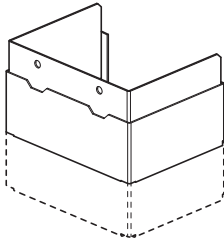

- 3 Use the assembled covers to conceal the front leveling legs.
- 4 Place the outer covers on the floor and slide the inner covers up until the holes at the top front snap over the dimples on the flanges on the bottom of the range.

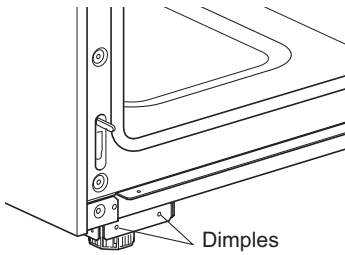

- 5 Insert the provided screws through the holes in the leg cover assemblies to secure them in place.

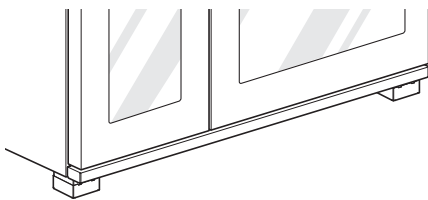

Installing Front Rail

- 1 Remove the plastic film from the stainless steel front rail.
- 2 Insert the front rail onto the flange below the oven door, aligning the holes in the top of the rail with the holes in the flange.

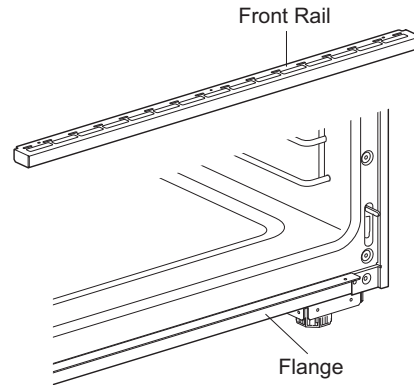

- 3 Use the 3 screws provided to secure the front rail to the flange.

Connecting the Range to Gas

Shut off the range gas supply valve before removing the old range and leave it off until the new hook-up has been completed.

Because hard piping restricts movement of the range, a CSA International-certified flexible metal appliance connector should be used unless local codes require a hard-piped connection.

A manual valve must be installed in an accessible location in the gas piping external to the appliance for the purpose of turning on or shutting off gas to the appliance.

Never reuse an old connector when installing a new range.

To protect against gas leaks, use a qualified pipe joint sealant on all external threads.

- 1 An inlet pipe is set on the left rear of this appliance. Hook up a gas hose that has 1/2" NPT internal thread to the inlet pipe using a wrench.
- 2 Apply sealing compound or Teflon tape at the connection.
- 3 When all connections have been made, be sure all range controls are in the **Off** position and turn on the main gas supply valve. Gas leaks may occur in your system and create a hazard. Gas leaks may not be detected by smell alone.

Check all gas connection joints and fittings for leaks with a non-corrosive leak detection fluid, then wipe off.

Gas suppliers recommend you purchase and install a UL approved gas detector. Install and use in accordance with the installation instructions.

WARNING

- Do not use a flame to check for gas leaks.
- Isolate the range from the gas supply system by closing its individual shut-off valve during any pressure testing of the gas supply system at test pressures equal to or less than 1/2" psig (3.5 kPa).

Flexible Connector Hookup

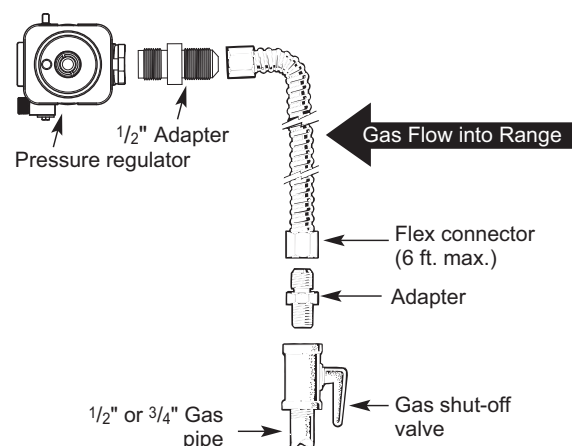

Installer: Inform the consumer of the location of the gas shutoff valve.

Pressure Regulator Position

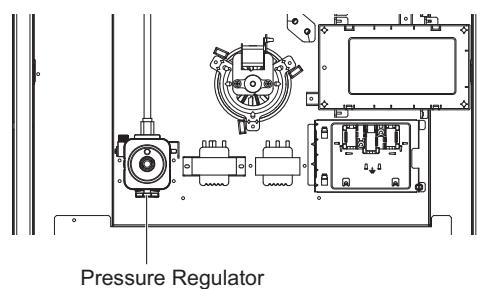

Connecting Electricity

Electrical Requirements

This appliance must be installed and grounded on a branch circuit by a qualified technician in accordance with the National Electrical Code ANSI/NFPA NO. 70 - latest edition.

All wiring should conform to local and NEC codes. This range requires a single-phase, 3 wire, A.C 120/208 V or 120/240 V 60 Hz electrical system. Use only a 3-conductor or a 4-conductor UL-listed range cord with closed-loop terminals, open-end spade lugs with upturned ends or similar termination. Do not install the power cord without a strain relief.



A range cord rated at 40 amps with 120/208 or 120/240 minimum volt range is required. If a 50 amp range cord is used, it should be marked for use with 1 3/8" diameter connection openings. This appliance may be connected by means of a conduit or power cord. If a conduit is being used, go to page 28 for **3 wire conduit connections** or **4 wire conduit connections**.

WARNING

- **Allow 2 to 3 ft (61.0 cm to 91.4 cm) of slack in the line so that the range can be moved if servicing is ever necessary.**
- **The power supply cord and plug should not be modified. If the plug will not fit the outlet, have a proper outlet installed by a qualified electrician.**
- **Using an extension cord to connect the power is prohibited. Connect the power cord and plug directly.**
- **Electrical ground is required on this appliance.**
- **Make sure that the power cord is not pinched by the range or heavy objects.** Failure to do so can result in serious burns or electrical shock.
- **Do not use a damaged power plug, power cord, or loose power outlet.**
- **Do not put a fuse in a neutral or ground circuit.**
- **Do not connect the ground wire to plastic plumbing lines, gas lines, or hot water pipes.**

Specified power-supply-cord kit rating				
Range rating, watts		Specified rating of power supply-cord kit, amperes	Diameter (inches) of range connection opening	
			Power cord	Conduit
120/240 volts 3-wire	120/208 volts 3-wire	40 or 50A	1 3/8"	1 1/8"
8,750 - 16,500	7,801 - 12,500	50	1 3/4"	1 3/8"

3, 4 - Wire Electrical Wall Receptacle

	4 Wire receptacle (14-50R)
	3 Wire receptacle (10-50R)

Connecting the Power Cord

The rear access cover must be removed. Loosen the two screws with a screwdriver. The terminal block will then be accessible.

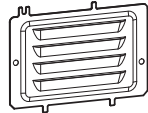

Access cover

Use the cord/conduit connection plate to install the power cord or conduit. Leave the connection plate as installed for power cord installations. Remove the connection plate for conduit installations and use the smaller 1 1/8 in. (2.8 cm) conduit hole instead of the 1 3/8 in. (3.5 cm) power cord hole.

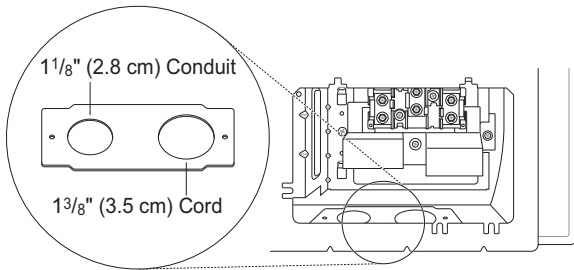

Remove the conduit connection plate

For power cord installations, hook the strain relief over the 1 3/8 in. (3.5 cm) power cord hole located below the rear of the oven. Insert the power cord through the strain relief and tighten it.

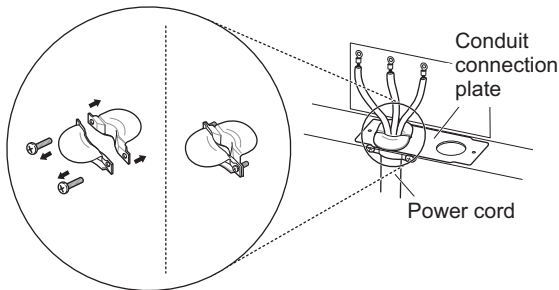

Assembling power cord strain relief at the 1 3/8" opening

For conduit installations, insert the conduit strain relief in the 1 1/8 in. (2.8 cm) conduit hole. Then install the conduit through the body of the strain relief and fasten the strain relief with its ring.

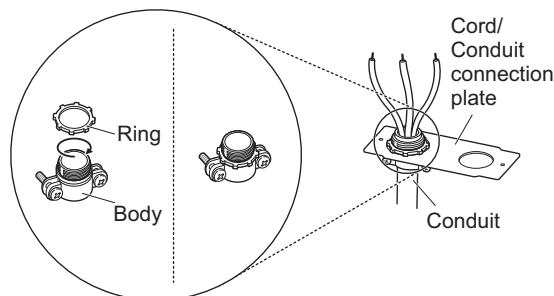

Assembling conduit cord strain relief at the 1 1/8" opening

3-Wire Connection: Power Cord

⚠ WARNING

- The middle (neutral or ground) wire, which is white, of a 3-wire power cord or a 3-wire conduit has to be connected to the middle post of the main terminal block. The remaining two wires of the power cord or conduit have to be connected to the outside posts of the main terminal connection block. Failure to do so can result in electrical shock, severe personal injury or death.

Installing the Power Cord

For power cord installations, hook the strain relief over the power cord hole (1 3/8") located below the rear of the oven. Insert the power cord through the strain relief and tighten the strain relief.

Do not install the power cord without a strain relief.

- 1 Remove the lower 3 screws from the terminal block and retain them.
- 2 Insert one of the screws through each power cord terminal ring and into the lower terminals of the terminal block. Make sure that the center (neutral) wire, which is white, is connected to the center lower position of the terminal block.
- 3 Tighten the 3 screws securely into the terminal block. Do not remove the ground strap connections.

3-Wire Connection

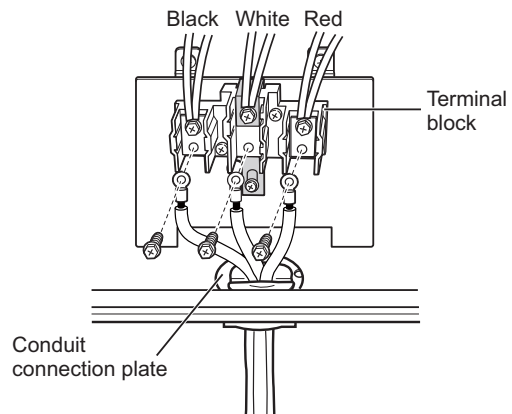

If screws are not tightened securely, it can result in electrical spark and severe personal injury or death.

4-Wire Connection: Power Cord

⚠ WARNING

- Only a 4-conductor power-supply cord kit rated 120/208 or 120/240 volts, 50 amperes and marked for use with ranges with closed-loop connectors or opened spade lugs with upturned ends must be used. The white middle (neutral) wire of the power cord or 4-wire conduit has to be connected to the middle post of the main terminal block. The other two wires of the power cord or conduit have to be connected to the outside posts of the main terminal connection block. The 4th ground wire (green) must be connected to the frame of the range with the ground screw. Failure to do so can result in electrical shock, severe personal injury or death.

Installing the Power Cord

Do not install the power cord without a strain relief.

- 1 Remove the lower 3 screws from the terminal block and retain them.
- 2 Remove the ground screw and bend the end of the ground strap up so the slot is over the hole of the center screw removed in step 1.
- 3 Insert the ground screw into the power cord ground wire (green) terminal ring and secure it to the range frame.
- 4 Insert one screw through each power cord terminal ring and into the lower terminals of the terminal block. Make sure that the white center (neutral) wire is connected to the center lower position of the terminal block.
- 5 Tighten the 3 screws securely into the terminal block. The center screw now attaches the bent up ground strap to the block.

4-Wire Connection

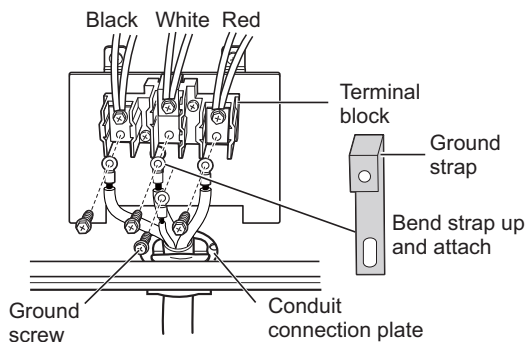

If screws are not tightened securely, it can result in electrical spark and severe personal injury or death.

3-Wire Connection: Conduit

Installing the Conduit

Remove the conduit connection plate from the rear of the oven and rotate it. The conduit hole ($1\frac{1}{8}$ ") must be used.

First, prepare the conduit wires as shown below.

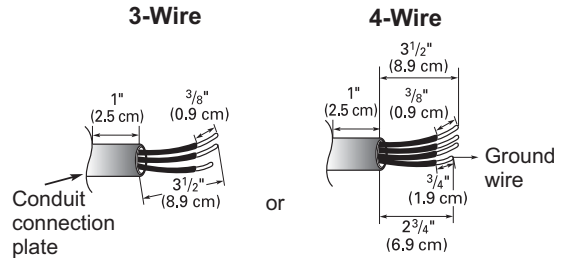

Second, install the conduit strain relief.

For conduit installations, purchase a strain relief and insert it in the $1\frac{1}{8}$ in. (2.8 cm) conduit hole. Then install the conduit through the body of the strain relief and fasten the strain relief with its ring. Reinstall the bracket.

For conduit connections:

If the wire in the conduit is copper it must be 8 or 10 AWG wiring.

If the wire in the conduit is aluminum it must be 6 or 8 AWG wiring.

- 1 Loosen the lower 3 screws from the terminal block.
- 2 Insert the bare wire (white/neutral) end through the center terminal block opening. Do not remove the ground strap connections.
- 3 Insert the two side bare wire ends into the lower left and the lower right terminal block openings. Tighten the 3 screws securely into the terminal block. (approximately 35 - 50 IN-LB)

Installing the Conduit

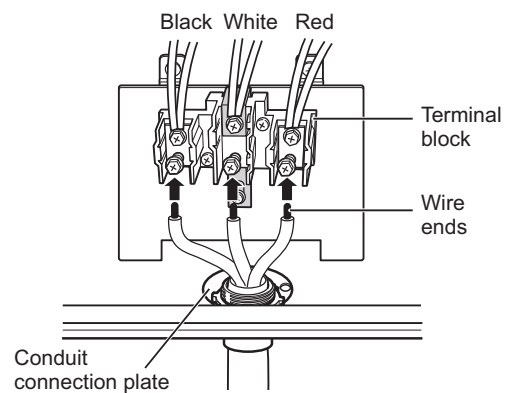

If screws are not tightened securely, it can result in electrical spark and severe personal injury or death.

4-Wire Connection: Conduit

⚠ WARNING

- The white middle (neutral) wire of the power cord or 4-wire conduit has to be connected to the middle post of the main terminal block. The other two wires of the power cord or conduit have to be connected to the outside posts of the main terminal connection block. The 4th ground wire (green) must be connected to the frame of the range with the ground screw. Failure to do so can result in electrical shock, severe personal injury or death.

- 1 Follow the instructions for installing the conduit under 3-Wire Connection: Conduit until the strain relief and bracket are installed. Do not install the conduit without a strain relief.
- 2 Loosen the 2 lower left and right screws from the terminal block. Remove the lower center screw. Do not discard any screws.
- 3 Remove the ground screw and bend the end of the ground strap up so the slot is over the hole of the center screw removed in step 2.
- 4 Attach the ground (green) bare wire end to the range frame and secure it in place with the ground screw.
- 5 Insert the bare wire (white/neutral) end through the center terminal block opening. The center screw now attaches the bent up ground strap to the block.
- 6 Insert the two side bare wire ends into the left and the right terminal block openings. Tighten the 3 screws securely into the terminal block. (approximately 35 - 50 IN-LB)

4-Wire Connection

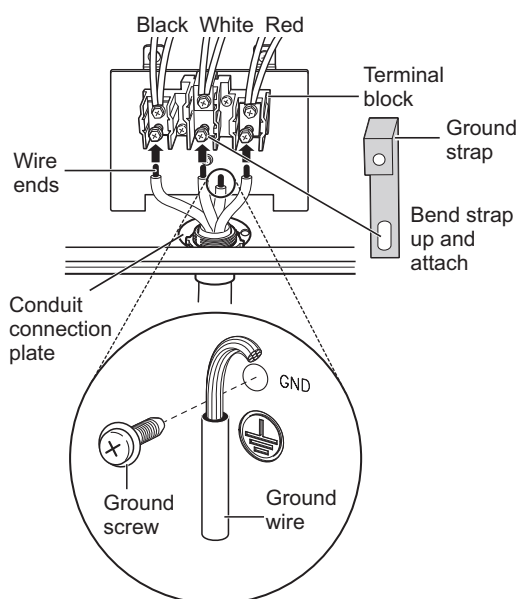

If screws are not tightened securely, it can result in electrical spark and severe personal injury or death.

Engaging the Anti-tip Device

- Move the range close enough to the opening to plug into the receptacle.
- Slide the range into position ensuring that the back leg slides under the anti-tip bracket. The range should sit flush against the back wall when properly installed.
- Carefully attempt to tip the range forward to ensure that the anti-tip bracket is engaged properly. If properly installed, the anti-tip bracket will prevent the range from being tipped. If the range can be tipped, reinstall the range until the anti-tip bracket is properly installed and the range will not tip forward.
- Turn on electrical power. Check the range for proper operation.

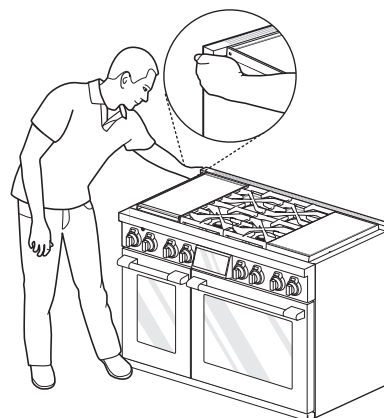

Test Run

Check if the range is properly installed and run a test cycle.

- 1 Remove all packing materials from inside the oven. Press **Power** button located next to the display and set initial settings such as language and time. (Refer to "Getting Started" in the Operation section.)
- 2 Check the operation of the right oven. Select **RIGHT OVEN** on the display and the cook mode screen opens. Select Proheat Bake then Start.
- 3 Check the operation of the left oven. Select **LEFT OVEN** on the display. Select Bake then Start.
- 4 The ovens should finish preheating in 15 minutes.
- 5 After making sure the ovens operate properly, turn the temperature in both ovens to 550 °F (288 °C) and leave the ovens on for at least an hour. This helps remove any residual oil which might cause smoke or odor when first using the ovens.

NOTE

Smoke may come out of the range when it is first used.

Checking Ignition of the Surface Burners

Electric Ignition

Select a surface burner knob and simultaneously push in and turn to the **Lite** position. You will hear a clicking sound indicating proper operation of the spark module.

Once the air has been purged from the supply lines the burner should ignite within 4 seconds. After the burner ignites, rotate the knob out of the **Lite** position. Try each burner in succession until all burners have been checked.

Quality of Flames

The combustion quality of the burner flames needs to be confirmed visually.



A **Yellow flames** - Call for service.



B **Yellow tips on outer cones** - This is normal for LP gas.



C **Soft blue flames** - This is normal for natural gas.

NOTE

- With LP gas, some yellow tipping on outer cones is normal.

Adjusting the Surface Burner to the Low Flame (Simmer) Setting

- The simmer setting only needs to be adjusted on the large (23 K BTU) burners.
- The simmer setting on small (15 K BTU) burners is adjusted as flame cycles off and on.

- 1 Remove the knob on the burner being adjusted.
- 2 Unscrew the 2 screws to remove the locking plate.

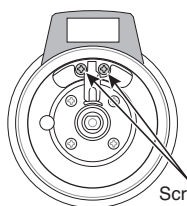

Screws for locking plate (2ea)

- 3 Reassemble the burner knob.
- 4 Light all surface burners.
- 5 Turn the knob on the large burner being adjusted to the Simmer position then remove the knob.
- 6 Insert a small, flat-blade screwdriver into the valve shaft and turn the adjustment screw until the flame reaches the desired size.

- 7 Reassemble the locking plate and large burner knob.

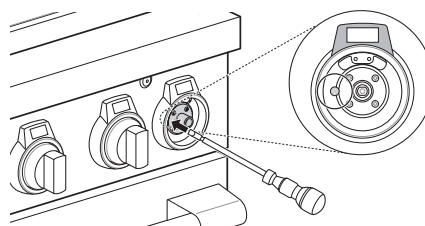

NOTE

Hold the valve shaft with one hand while turning the screw to adjust with the other.

- 8 Test the flame stability.

Test 1: Quickly turn the knob from the Hi to the Simmer position. If the flame goes out, increase the flame size and test again.

Test 2: With the burner set to Simmer, open and close the oven door quickly. If the air current extinguishes the flame, increase the flame height and test again.
- 9 Repeat steps 1-8 for each large gas burner on cooktop surface.

OPERATION

Control Panel Overview



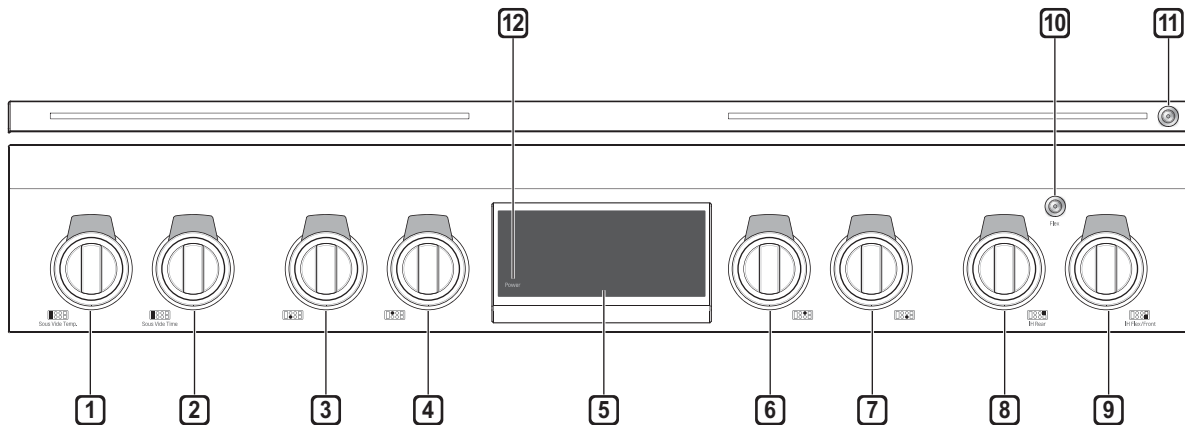





The position of the control knobs and buttons varies by model.



- 1** Sous Vide Temperature Control
- 2** Sous Vide Cooking Time Control
- 3** Left Front Burner Control
- 4** Left Rear Burner Control
- 5** LCD Touchscreen for Oven
- 6** Right Rear Burner Control
- 7** Right Front Burner Control

- 8** Rear Induction Element Control
- 9** Front Induction Element Control
- 10** Flex On/Off
Used to heat large containers on the induction surface.
- 11** Mood Light On/Off
- 12** LCD Display On/Off

Display Icons

- 1**  **Timer Icon**
Icon to set the timer
- 2**  **Lamp Icon**
Icon to turn ON/OFF the lamp
- 3**  **Number Pad Icon**
Icon to set the time or temperature
- 4**  **Reset Icon**
Icon to cancel the function
- 5**  **Lock Icon**
Icon that appears when locked
- 6**  **Wi-Fi Icon**
Icon that appears when set the Wi-Fi
- 7**  **Remote Start Icon**
Icon that appears when set the Remote Start
- 8**  **Auto Conversion Icon**
Icon that appears when set the auto conversion
- 9**  **Prove Icon**
Icon that appears when connect the prove.

Getting Started

After turning on the range for the first time, adjust the settings to suit your preferences.

- 1 Touch POWER on the LCD display.
- 2 After turning on the range for the first time, adjust the settings to suit your preferences.
- 3 Scroll the fields up or down to set the correct date, then touch NEXT.
- 4 Set the correct time of day and choose between a 12-hour or 24-hour time format, then touch NEXT.
- 5 If desired, change the default clock theme by swiping through the examples, then press NEXT.
- 6 Read through the application guide in the display and touch DONE.
- 7 The Mode Selector screen appears in the display.

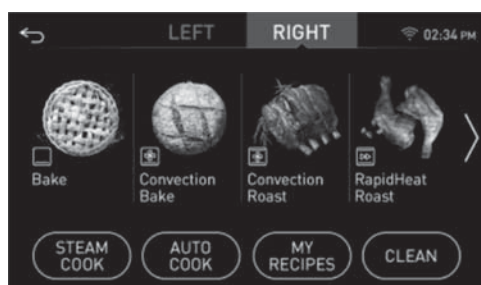

Changing Oven Settings

Settings

To adjust settings after the initial setup, touch the display to open the Main screen. Touch Settings at the bottom center of the Main screen.

Swipe the screen or touch the <> arrow keys to navigate through the Settings screens.

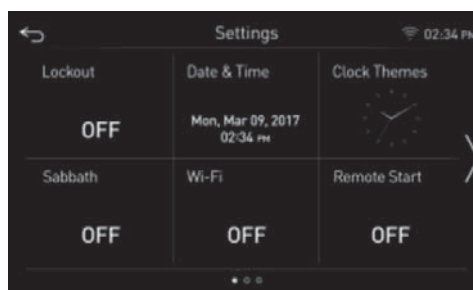
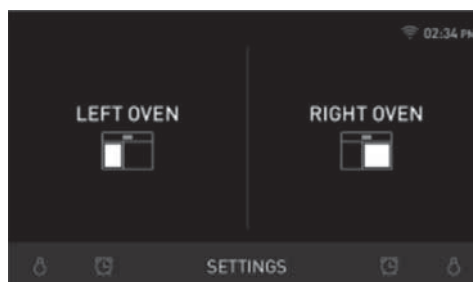

Location of Settings

- Page 1: Lockout, Date & Time, Clock Themes, Sabbath Mode, Wi-Fi Setup, Remote Start
- Page 2: Brightness, Display, Convection Auto Conversion, Language, Volume, Preheat Alarm Light
- Page 3: Thermostat Adjustment, Temperature Units, Smart Diagnosis™, Program Update, Factory Data Reset, Open Source License

Lockout

The Lockout feature automatically prevents most oven controls from being turned on. It does not disable the clock, timer and the interior oven light.

- If Lockout is turned on, all cooktop modules except for gas burners are disabled.

Lock

- 1 Touch Setting at the center bottom of the Main screen.
- 2 Touch Lockout on the first Settings screen.
- 3 When Lockout is turned on, the lock icon  appears at the top of the display.

Unlock

- 1 Touch any part of screen while Lockout is on.
- 2 A popup screen appears. Touch Unlock for 3 seconds.
- 3 The lock icon disappears from the top of the display.

Date & Time

The date and time show in the LCD display when the ovens are not in use. Reset the date and time if the range is unplugged or following a power failure.

Setting Date

- 1 Touch Setting at the center bottom of the Main screen, then touch Date & Time on the Settings screen.
- 2 Touch Time, then set the correct hour and minutes by scrolling. You can also touch the number pad icon  and enter the desired numbers.
- 3 Touch OK.

Setting Time of Day

- 1 Touch Setting at the center bottom of the Main screen, then touch Date & Time on the Settings screen.
- 2 Touch Time, then set the correct hour and minutes by scrolling. You can also touch the number pad icon  and enter the desired numbers.
- 3 Select either a 12-hour or 24-hour clock mode (12H/24H).
- 4 Touch OK.

Clock Themes

Six different clock themes are that contain several analog and digital type.

Clock Themes setting

- 1 Touch Setting at the center bottom of the Main screen.
- 2 Touch Clock Themes on the first Settings screen and swipe to browse through the clock themes.
- 3 Select a clock theme and touch OK.

Sabbath mode

Sabbath mode is used on the Jewish Sabbath and holidays.

While the oven is in Sabbath mode, you cannot adjust temperature or use the timer, light, or alarm functions. Only the cooking mode and temperature appear in the display. On double oven ranges, the left and right ovens can be set individually and allowing simultaneous operation while in Sabbath mode. The cooktop modules are disabled in Sabbath mode, except for the gas burners.

Setting Sabbath Mode

- 1 Disconnect the probe. The Probe function is not available in Sabbath mode.
- 2 Touch Setting at the center bottom of the Main screen, then touch Sabbath in the first Settings screen.
- 3 Read the instructions, if needed, and select one of the ovens.
- 4 Select the right or left oven.
- 5 Set the desired temperature, cook time, and start time (optional), then touch START.
- 6 To stop Sabbath mode, press POWER on the LCD display.

NOTE

- If a power failure occurs while operating in Sabbath mode, the information recently entered will be displayed on the display.
- If you install prove during sabbath mode, the display will show "Proved is connected".

Wi-Fi

Connect the appliance to a home Wi-Fi network to use Remote Start and other smart functions. See the Smart Functions section for more details.

Setting Up Wi-Fi

- 1 Touch Setting at the center bottom of the Main screen, then touch Wi-Fi in the first Settings screen.
- 2 Follow the instructions in the Wi-Fi Guide in the display.
- 3 Select ON, OFF, or RESET and touch OK.
- 4 If ON is selected, the Wi-Fi icon  appears at the top of the display.
- 5 Selecting RESET initializes the IP address.

Remote Start

Remotely starts or stops the preheating function of the appliance. The appliance must be registered on a home Wi-Fi network to use Remote Start.

Setting Remote Start

- 1 Touch Setting at the center bottom of the Main screen, then touch Remote Start in the first Settings screen.
- 2 Select On or Off and touch OK.
- 3 If ON is selected, the Remote Start icon  appears at the top of the display.

Brightness

Adjust the brightness of the LCD display from 0% to 100 % in increments of 20 %.

Setting Display Brightness

- 1 Touch Setting at the center bottom of the Main screen, swipe to the second Settings screen, and touch Brightness.
- 2 Adjust the display brightness by touching and dragging the dot across the bar, by tapping anywhere on the bar, or by touching [light+ icon] or [light - icon].
- 3 Touch OK.

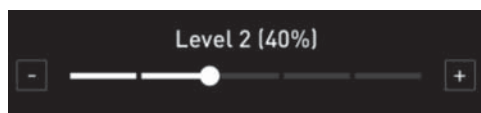

Display

Set the length of time before the display sleeps.

There are three options you can select.

- **ON** : Always on
- **OFF** : Automatically turns off if idle for 30 minutes.
- **Night Dimming** : Turns on from 5:00 a.m. to 10:00 p.m.

Setting Display Option

- 1 Touch Setting at the center bottom of the Main screen, swipe to the second Settings screen, and touch Display.
- 2 Select the desired option.
- 3 Touch OK.

Convection Auto Conversion

There is no need to remember to convert standard recipe temperatures for convection cooking. Convection Auto Conversion automatically subtracts 25 °F / 14 °C from the set temperature when a convection cooking mode is selected. The converted temperature appears in the display once preheating is finished.

For example, select Convection Bake and enter 350 °F. The temperature will auto-convert to 325°F and display the converted temperature.

Convection Auto Conversion is turned ON by default.

Turning Convection Auto Conversion On/Off

- 1 Touch Setting at the center bottom of the Main screen, swipe to the second Settings screen, and touch Convection Auto Conversion.
- 2 Select ON or OFF.
- 3 When Convection Auto Conversion is ON, the icon  appears at the top of the display.

Language Selection

Set the display language to English, Spanish, or French.

Selecting a Language

- 1 Touch Setting at the center bottom of the Main screen, swipe to the second Settings screen, and touch Language Selection.
- 2 Select the desired language.
- 3 Touch OK.

Volume

Adjust the volume of the cooktop and oven controls.

Setting the Volume

- 1 Touch Setting at the center bottom of the Main screen, swipe to the second Settings screen, and touch Volume.
- 2 Select Mute, Low, or High.
- 3 Touch OK.

Preheat Alarm Light

When the oven reaches its set-temperature, the preheating alarm light flashes 5 times or until the oven door is opened.

You can turn the preheat alarm light on or off.

Preheat alarm setting

- 1 Touch Setting at the center bottom of the Main screen, swipe to the second Settings screen, and touch Preheat Alarm Light.
- 2 Select ON or OFF.
- 3 Touch OK.

Thermostat Adjustment

Your new oven may cook differently from the one it replaced. Use your new oven for a few weeks to become more familiar with it before adjusting the thermostat. Start by raising or lowering the thermostat 15 °F / 4 °C. Based on initial results, readjust the amount until satisfied. The thermostat can be raised or lowered by 35 °F / 10 °C.

Adjusting the Thermostat

- 1 Touch Setting at the center bottom of the Main screen, swipe to the third Settings screen, and touch Thermostat Adjustment.
- 2 There are two adjustment scales, one for each oven.
To make large adjustments, drag the central indicator toward the + or - ends of the scale or tap a location on the scale. To make small adjustments, tap + or - to raise or lower the thermostat in 1-degree increments. Tap and hold + or - to scroll up or down the scale.
- 3 When the desired change appears above the range, touch OK.

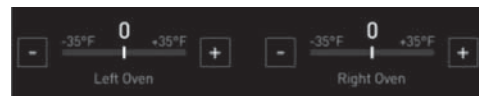

Temperature Units

Set the oven temperature display to show either Fahrenheit or Celsius units.

The oven defaults to Fahrenheit unless changed by the user.

Setting Temperature Units

- 1 Touch Setting at the center bottom of the Main screen, swipe to the third Settings screen, and touch Temperature Units.
- 2 Select °F or °C.
- 3 Touch OK.

Smart Diagnosis™

Smart Diagnosis™ can be run through a smartphone application or by calling for support. Place your smartphone's mouthpiece near the top left corner of the screen. See "Smart Diagnosis Function" in the Smart Functions section for detailed instructions.

- 1 Touch Setting at the center bottom of the Main screen, swipe to the third Settings screen, and touch Smart Diagnosis.
- 2 Touch START to start the diagnostic tone.

Program Update

Once the appliance is connected to a home Wi-Fi network, use this setting to check for available programming updates and install them.

- 1 Touch Setting at the center bottom of the Main screen, swipe to the third Settings screen, and touch Program Update.
- 2 The display shows available programming updates. Touch UPDATE to download and install the new version.

Factory Data Reset

This function returns all settings to the factory defaults.

- 1 Touch Setting at the center bottom of the Main screen, swipe to the third Settings screen, and touch Factory Data Reset.
- 2 If you want to reset data to the factory defaults, touch RESET and then OK.



WARNING

- All stored data will be deleted.

Open Source License

Those products identified by the product Type and Model Range above from SIGNATURE KITCHEN SUITE contain the open source soft detailed function. Please refer to the indicated open source licenses (as are included following this notice) for the terms and condition of their use.

- 1 Touch Setting at the center bottom of the Main screen and swipe to the third Settings screen.
- 2 Touch Open Source License.

Using the Cooktop

Gas Cooktop Module

The size and location of gas burners vary depending on the range model. Every gas cooktop module includes 4 gas burners.

Sous Vide, Gas Cooktop, Induction Cooktop

This model includes a sous vide module on the left, 4 gas burners in the center, and an induction cooktop on the right.

The sous vide module uses a water bath to cook food which has been vacuum-sealed in pouches.

The induction elements use a magnetic field to quickly and efficiently heat just the cookware, not the cooktop surface.

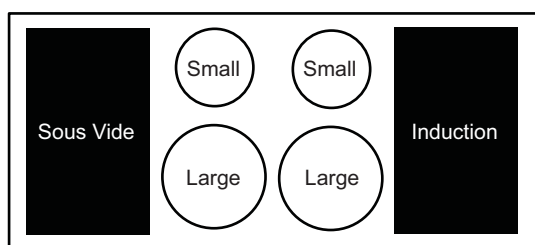

NOTE

- The cooktop module only works using knobs without the display operation.

Cooktop Timers

Each cooktop control knob has an LED display at the top which provides information such as heat level, temperature, or time remaining. The [gas burner] control knobs include a timer function.

Setting the Cooktop Timers

A cooktop timer can only be set when the element is in use. After the timer ends, a chime sounds and the LED lamp blinks until the element is turned OFF.

- 1 Push in and turn the knob to turn on the element.
- 2 Set a timer by turning the LED ring behind the knob. Turn the LED ring right or left and hold it to increase or decrease the time.
- 3 Release the LED ring when the desired time appears in the knob display.
- 4 The knob display shows the time counting down. A chime sounds when the time ends.
- 5 To cancel a timer, turn the LED ring to the left until 0:01 appears in the display.

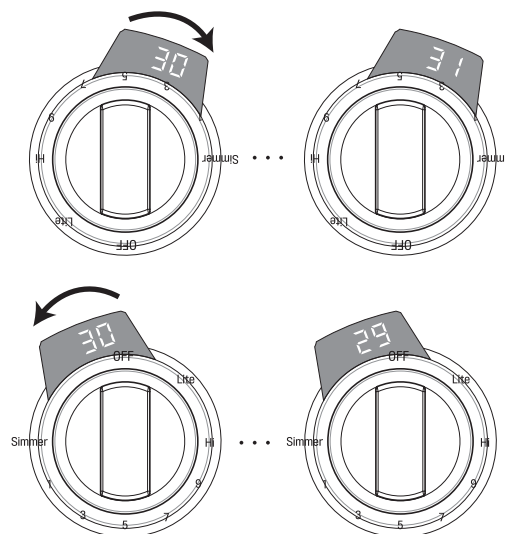

The Gas Surface Burners

Before Use

Read all instructions before using.

Make sure that all burners are properly placed.

Burner locations differ depending on the range model.

Burner locations can be found under "Using the Cooktop."

Make sure that all grates are properly placed before using the burners.

CAUTION

Do not operate the burners for an extended period of time without cookware on the grate.

The finish on the grate may chip without cookware to absorb the heat.

Make sure the burners and grates have cooled down before touching them, or placing a pot holder, cleaning cloth, or other materials on them.

Touching grates before they cool down may cause burns.

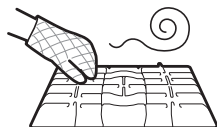

CAUTION

WHAT TO DO IF YOU SMELL GAS

- Open windows.
- Do not try to light any appliance.
- Do not touch any electrical switch.
- Do not use any phone in your building.
- Immediately call your gas supplier from a neighbor's phone. Follow the gas supplier's instructions.
- If you cannot reach your gas supplier, call the fire department.

NOTE

Electric spark igniters from the burners cause a clicking noise. If the flame goes out, the reignition system reignites the burners automatically.

Using the Gas Surface Burners

- 1 Be sure that all of the surface burners and grates are placed in the correct positions.
- 2 Place cookware on the grate.
- 3 Push the control knob and turn to the **Lite** position until the flames have ignited.

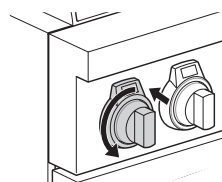

The electric spark ignition system makes a clicking noise.

- 4 Turn the control knob to control the flame size.

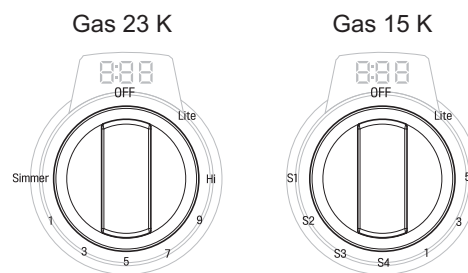

Simmer : S1-S4

CAUTION

Do not attempt to disassemble or clean around any burner while another burner is on. All the burners spark when any burner is turned to **Lite**. An electric shock may result causing you to knock over hot cookware.

Setting the Flame Size

Watch the flame, not the knob, as you reduce heat. Match the flame size on a gas burner to the cookware being used for fastest heating.

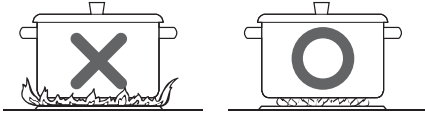

CAUTION

Never let the flames extend up the sides of the cookware.

NOTE

- The flames on the surface burners may burn yellow in the presence of high humidity, such as a rainy day or a nearby humidifier.
- After LP gas conversion, flames can be bigger than normal when you put a pot on the surface burner.
- When turning a surface burner from high heat to simmer quickly, make sure the flames stay lit. See page 31 to adjust the burner flames, if necessary.

In Case of Power Failure

If you experience a power outage, you can carefully light the gas surface burners on the range with a match. Gas burners in use when the power goes out will continue to operate normally.

- 1 Hold a lit match to the burner, then push in the control knob.
- 2 Turn the control knob to the 1 position.

CAUTION

Use extreme caution when lighting burners with a match. Doing so can cause burns and other damage.

Cookware for Gas Burners

Aluminum	Medium-weight cookware is recommended because it heats quickly and evenly. Most foods brown evenly in an aluminum skillet. Use saucepans with tight fitting lids when cooking with minimum amounts of water.
Cast-Iron	If heated slowly, most skillets will give satisfactory results.
Stainless Steel	This metal alone has poor heating properties and is usually combined with copper, aluminum or other metals for improved heat distribution. Combination metal skillets work satisfactorily if they are used with medium heat as the manufacturer recommends.
Enamelware	Under some conditions, the enamel of this cookware may melt. Follow cookware manufacturer's recommendations for cooking methods.
Glass	There are two types of glass cookware. Those for oven use only and those for top-of-range cooking.
Heatproof Glass Ceramic	Can be used for either surface or oven cooking. It conducts heat very slowly and cools very slowly. Check cookware manufacturer's directions to be sure it can be used on gas ranges.

Extra Low Simmer (Small Burners Only)

- Extra Low Simmer is only available on small burners. For the location of your small burners, see the Burner Locations section. The simmer function on the large burners applies heat to food continuously.

Extra Low Simmer controls the heat by turning the flame on and off at preset intervals. This allows foods such as sauces, chocolate and jam to simmer longer without scorching.

- The intervals without flame become longer as you move from S3 to S1.
- The S4 simmer setting keeps the flame lit continuously.

NOTE

- It may look like the burners are turned off during Extra Low Simmer.
- It is normal for the flames to turn off and on periodically during Extra Low Simmer.
- The electric igniters automatically operate periodically to reignite the burners.

On/Off Timing for Extra Low Simmer Modes

The 3 Extra Low Simmer modes are S1, S2, and S3. The hottest setting, with the longest On period, is S3.

S1 : On-7s, Off-53s per 1 minute (roughly)

S2 : On-27s, Off-33s per 1 minute (roughly)

S3 : On-39s, Off-21s per 1 minute (roughly)

Using a Wok

- The large burner grates can be used as wok grates. 14-inch or smaller flat-bottom woks can be set directly on the grate, if the wok bottom is large enough to sit flat on the grate.

CAUTION

If using a round-bottomed wok, use the included wok grate. Do not use a wok support ring. Placing the ring over the burner or grate may cause the burner to work improperly, resulting in carbon monoxide levels above allowable standards. This can be hazardous to your health.

Using the Wok Grates

The large burner grates can be flipped over to handle a wide variety of round-bottom woks.

- 1 Turn off all burners and allow the grates and cooktop to cool before reversing the grates.
- 2 Flip the large burner grate so the wok grate is facing up.
- 3 Use a 12" to 14" round-bottomed wok. Do not use a wok that does not rest securely in the wok grate.

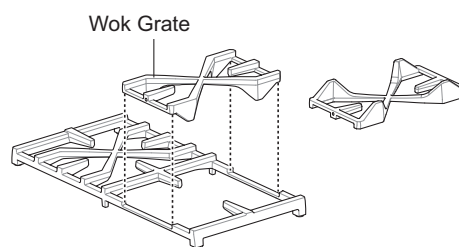

NOTE

- Do not use the wok grate with cookware other than a wok.
- Clean the wok grate with hot, soapy water. Do not use oven cleaners, steel wool, or abrasive cleansers. Do not clean with the self-clean mode.

CAUTION

- Turn off all burners and allow wok grate, burner grates, and cooktop to cool before reversing or removing wok grate.
- The wok grate retains heat for a long time. Always use an oven mitt when installing or removing the wok grate. Do not store the wok grate on another burner grate.
- Do not use flat-bottomed cookware or incorrectly sized woks with the wok grate. The cookware or wok could tip and cause personal injury.
- Do not use a wok larger than 14" with the wok grate. Doing so could cause burner flames to spread excessively and damage the cooktop.

Using Stove-Top Grills

Do not place stove-top grills on the burner.



CAUTION

Do not use stove top grills on the surface burners. Using a stove top grill on the surface burner will cause incomplete combustion and can result in exposure to carbon monoxide levels above allowable current standards. This can be a health hazard.

Induction Cooktop (On Some Models)

The induction cooktop uses an electromagnetic field to directly heat only the pan, not the cooktop. Any cookware that can be strongly magnetized will work for induction cooking.

The induction cooktop has a Front element and a Rear element. The wattage ratings of each element are below;

Level	Front & Rear	Flex
Boost	3650 W	3650 W
9	2000 W	3300 W

The LED displays at the front of the induction cooktop and over each control knob indicate the power level of the elements while cooking.

Boost mode can be used for 10 minutes, after which the element is automatically set to level 9. The Boost mode is not available in Flex mode.

Benefits of Induction Surface Cooking

Speed and Efficiency

Induction cooking elements heat faster and use less energy. Induction power levels quickly boil liquids and are efficient when simmering.

A Cooler Cooktop

Whether induction cooking elements are turned on or off, they remain cooler than radiant elements. Virtually no heat is wasted because the heat begins with the presence of cookware.

Easy Cleanups

Cooler cooking elements make for easier cleaning. Spills resist sticking or burning so they wipe up easily.

Pan Size Detection

A sensor automatically detects and adapts the induction cooking element to the pan size in use for more consistent, even cooking.¹

Greater Responsiveness

Induction cooking elements are more responsive than their electric or gas counterparts because only the pan heats. Induction elements heat more easily and are just as responsive when reducing temperatures to a simmer.

Induction Cookware

NOTE

Before using the induction cooking elements, carefully read and follow these cookware recommendations and the instructions in the pan sensing sections.

When purchasing pans for use on the induction cooktop, look for cookware identified by the manufacturer as "induction ready" or "induction capable", or that is marked by the manufacturer as specifically designed for induction cooking.

The base material of the cookware must be magnetic for the cooking elements to activate. Use a magnet to check if the cookware base material is suitable. If the magnet sticks to the bottom of the cookware, the cookware can be used for induction cooking.

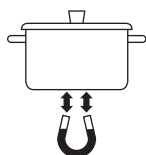

For the best possible surface cooking results, use only high-quality, heavy gauge steel cookware on the induction cooking elements. Follow manufacturer's recommendations when using induction cookware.

Induction Cookware Types

The three most common induction cookware types available are stainless steel, cast iron, and porcelain-enamel-coated metals.

- **Stainless Steel** is generally excellent for induction cooking. It is durable, easy to clean, and resists staining.

NOTE



Not all stainless steel cookware is magnetic; stainless steel is not always suitable for induction cooking.

- **Cast iron** cooks evenly and is also good for induction cooking. Do not slide cast iron cookware on the cooktop; cast iron cookware with a rough surface will scratch the ceramic cooktop.
- **Porcelain-enamel-coated metals** have variable heating characteristics depending on the quality of the base metal. Make sure the porcelain-enamel coating is smooth to avoid scratching the ceramic cooktop.



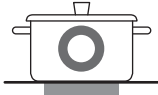
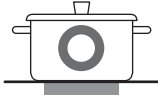
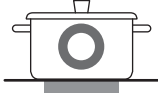
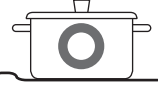

Cookware Placement

Use the proper cookware and place it correctly on the cooktop. One or more of the cooking elements will not heat if any of the incorrect conditions shown is detected by the sensors located below the ceramic cooktop surface. Correct the problem before attempting to use the cooktop.

Correct

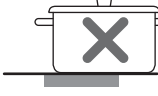
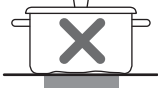
- Cookware is centered correctly on surface of cooking element. 
- Pan has flat bottom and straight sides. 
- Pan size meets or exceeds the recommended minimum size for the cooking element. 
- Pan rests completely on the cooktop surface. 
- Pan is properly balanced. 

Incorrect

- Cookware is not centered on surface of cooking element. 
- Pan has curved or warped bottom or sides. 
- Pan does not meet the minimum size required for the cooking element used. 
- Pan bottom rests on cooktop trim or does not rest completely on the cooktop surface. 
- Pan is unbalanced by heavy handle. 

Moving Cookware on the Cooktop

Always use heavier gauge, high-quality cookware on the cooking elements and do not slide it on the ceramic cooktop surface. Even high-quality cookware can scratch the cooktop surface.

NOTE

- Always lift cookware before moving it on the ceramic glass surface. Any cookware that has a rough or dirty bottom can mark and scratch the cooktop surface. Always start with clean cookware.
- Do not allow aluminum foil or any material that can melt to make contact with the ceramic glass cooktop. If these materials melt on the cooktop they may damage the ceramic glass surface.

Sliding any type of cookware over the surface will scratch the cooktop over time. Scratches will make cleaning the ceramic cooktop difficult and degrade the appearance of the cooktop.

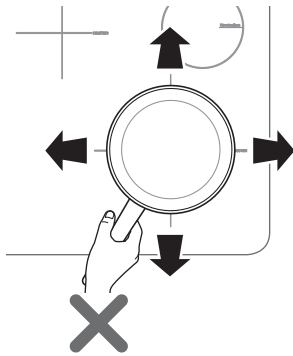

Pan Sensing

The cooking-element sensors located below the cooktop surface require certain cookware conditions to be met before the induction cooking elements can operate.

The cooking zone LED bar may display a pan sensing error message. If a cooking element is activated and no cookware is detected, the affected induction cooking zone LED bar will fluctuate. If the cookware does not meet the correct conditions, the cooking zone may not heat.



If the problem is not corrected, the affected cooking element will automatically deactivate after one minute.

Setting Surface Controls

Cooking Element LED Bar

There are LED bars located at the front of the induction cooktop surface. The LED rings on the control knobs also indicate the power level of the elements while in use.

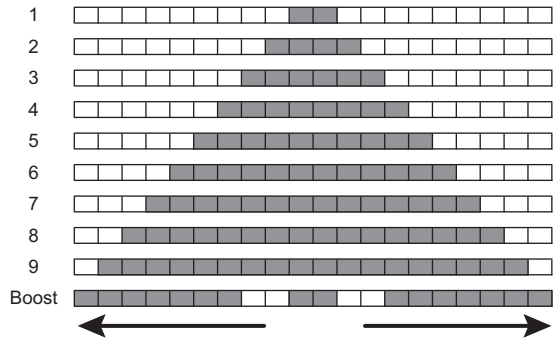

Available Power Level Settings

LED bars display the element's power level settings, ranging from 1 to 9 to Boost. Adjust the settings in increments of one, from 1 to Boost. To select 9, turn the knob clockwise to 9.

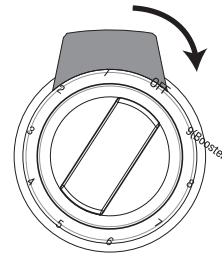

Boost Power Level

To activate the Boost mode, turn the knob counterclockwise from Off to 9. Boost mode is only available immediately after activating a cooking element. When the cooking element is set to the Boost mode, the LED bar flashes and the Boost mode stays in operation for up to 10 minutes. After 10 minutes, the cooking element automatically returns to level 9.

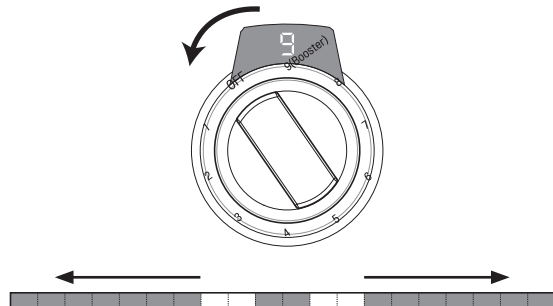

The maximum operating time for all element levels except the Boost mode is 12 hours.

Hot Surface Indicator

The hot surface indicator light glows as long as any surface cooking area is too hot to touch.

It remains on after the element is turned off and until the surface has cooled to approximately 130 °F.

It is normal for the surface elements to cycle on and off when cooking at lower temperature settings.

Using the Cooking Elements

CAUTION

Before Cooking

- Do not place or store flammable or heat-sensitive items on the induction cooktop, even when the cooktop is not in use.
- Place cookware on the cooking elements before turning on the induction cooktop.
- Do not place sealed containers on the cooktop.

During Cooking

- Do not place metallic objects such as knives, forks, spoons, and lids on the induction cooktop surface; they can get hot.
- Use this appliance only for normal household use. It is not designed for commercial or industrial use.
- Never use the appliance to heat the room.
- Use caution when plugging electrical appliances into power outlets near the cooktop. Keep power cords from any contact with the cooktop or cookware.
- Overheated fat and oil can catch fire quickly. Never leave surface elements unattended when frying foods.
- Do not use the induction cooktop to heat aluminum foil, products wrapped in aluminum foil, or frozen foods packaged in aluminum cookware.
- Use caution when plugging electrical appliances into outlets near the cooktop to keep power cords away from the hot cooktop or cookware.
- Users with pacemakers and active heart implants must keep their upper body at a minimum distance of 1 ft (30 cm) from active induction cooking elements. If in doubt, consult the implant manufacturer or your doctor.

After Cooking

- After use, switch off the induction cooking element using its control. Do not rely on the pan sensor.

Turning On Cooking Elements

- 1 Push the control knob in.
- 2 Turn the knob in either direction to select the desired setting. A short beep sounds and the cooking element's LED bar shows its current setting.
- 3 To activate the Boost mode, turn the knob directly from Off to 9(Boost).

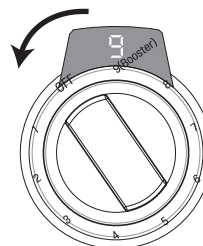

Flex Mode

Use the Flex mode for cookware that is too large to fit on one element. Push the Flex button between the two control knobs to turn on Flex mode.

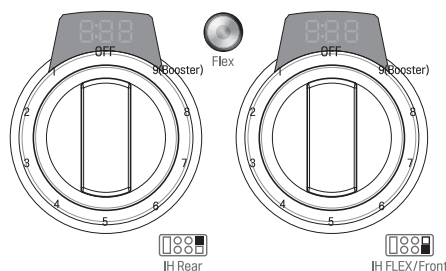

In Flex mode, both cooking-element sensors are turned on. When larger cookware is placed on the cooktop, both elements operate simultaneously.

- Boost mode cannot be used in Flex mode.

Using Flex Mode

- Only the right control knob is used in Flex mode.
 - If the left control knob is turned, Flex mode is canceled.
- 1 Place the proper cookware on the induction cooktop.
 - 2 Touch Flex button located between induction knobs and "FLE" blinks on the right knob LED.
 - 3 Turn the right knob and set power level. The LED ring displays the power level.

To turn Flex mode off, turn the right knob counterclockwise to the OFF position.

The Recommended Surface Cooking Setting

Start most surface cooking on a higher setting and then adjust to a lower setting to finish cooking.

The suggested settings may need adjustments, depending on cookware design and quality and on the amount of food being prepared.

Use quality cookware that is constructed with a magnetic base material and that meets the minimum and maximum pan size requirements.

Setting	Recommended Use
Boost	<ul style="list-style-type: none"> Use to heat a large amount of food or to bring large pans of water to a boil
8-Hi	<ul style="list-style-type: none"> Bring liquid to a boil Start most cooking
MED-8	<ul style="list-style-type: none"> Hold a rapid boil, fry, deep fat fry Quickly brown or sear food Steaks, cutlets, grilled meat
3-MED	<ul style="list-style-type: none"> Maintain a slow boil Fry or sauté foods Cook soups, sauces and gravies Eggs, pancakes
SIMMER-3	<ul style="list-style-type: none"> Stew or steam food Simmer
Lo-SIMMER	<ul style="list-style-type: none"> Keep food warm Melt chocolate or butter Simmer

Pan Preheat Recommendations

Induction cooking may decrease the amount of time required to preheat cookware compared to cooking on a radiant element cooktop or gas surface burner. Pay close attention to all food items while cooking on the cooktop or in the oven, and until all cooking processes are complete.



CAUTION

Remember that induction surface cooking initially heats the cookware **VERY QUICKLY** if the cookware does not contain food.

Noises during Induction Operation

The electronic processes involved with induction cooking may create some background noises. You may hear a slight buzzing sound when cooking on the cooktop. These noises are part of the induction cooking process and are considered normal. Some cookware will buzz, depending on the construction or base material. The buzz may be more noticeable if the contents of the pan are cold. As the pan heats up, the noise will decrease. The noise will also decrease if the power level setting is reduced.

NOTE

- When using the induction cooktop, operational noises are more noticeable while cooking in Boost mode. But very loud noises are not normal when induction cooking.
- The cooktop fan may turn on to reduce the temperature of the product, even when the surface elements are not being used.

Power Management

The induction cooktop contains paired cooking elements, which are restricted to drawing a certain maximum amount of power.

If you turn on the Boost function for one element while its paired element is in use, the Power Management function may automatically reduce the power of both elements.

NOTE

- If the combined heat of the oven and the surface burners is sufficiently high, the output of the induction cooktop is reduced to avoid damage to the product.
- Both elements in induction cooktop cannot use the Boost mode at the same time.

Sous Vide (On Some Models)

Sous vide cooking uses a hot water bath to cook foods "low and slow." Use it to cook meat, fish, seafood, poultry, or vegetables. Food must be vacuum packed in pouches before placing it in the water bath.

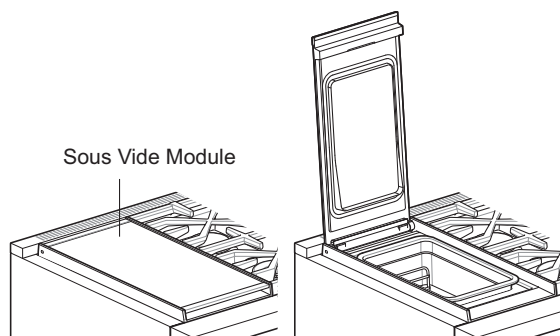

Benefits of Sous Vide

The lower temperatures and long cooking times used in sous vide cooking provide many benefits.

Healthier

Compared to other cooking methods, sous vide retains most of the original nutrients in food.

Safe and Convenient

The long cooking times used in sous vide cooking allow food to be pasteurized. Because food is vacuum packed before cooking, the unopened pouches can be quickly chilled then easily stored after cooking.

Crisp and Moist Results

The fine temperature control of sous vide cooking is an excellent way to achieve the perfect texture when cooking meat and poultry. The low temperatures used retain more of the moisture in food than conventional cooking methods. After cooking, a final sear in a frying pan adds the perfect crisp finish.

Vacuum Sealing

For best results, use a vacuum sealer and food-grade plastic pouches when sous vide cooking.

- 1 Season food as desired and vacuum seal it in a plastic pouch.
- 2 Check the pouch to make sure it is airtight and completely sealed.

NOTE

- Do not attempt to package objects with sharp points that could penetrate and tear the plastic, such as fish bones or hard shells.

Using Sous Vide

- 1 Open the cover of the sous vide module and remove the water bath.
- 2 Check the bottom of the water bath and inside the module for water or debris. Clean the bath and the module if necessary.
- 3 Fill the bath with water between the Max and Min lines.
- 4 Place the filled water bath in the sous vide module and put the rack in the bath.
- 5 Close the module cover completely.
- 6 Turn the Sous Vide Temp knob clockwise to set the desired cooking temperature.
- 7 Turn the Sous Vide timer knob clockwise to set the desired cooking time.
- 8 Pre Heating When the alarm sounds, open the door and place the sealed food pouch on the rack.
- 9 When cooking is complete, open the sous vide module cover and remove the food pouch with tongs.
- 10 Return the Time and Temp knobs to the OFF position.
- 11 Allow the water bath to cool, then remove the bath and drain the water.

NOTE

- When opening the door, beware of escaping steam and drips from hot condensation water. There is a danger of scalding.
- Remember to return the Sous Vide Temp knob to the OFF position after use.
- When the cover is opened after sous vide cooking, steam may condense and fall into the module. Once the module cools, remove any moisture with a dry towel.

Using the Rack

Be sure to use the rack when cooking Sous-Vide. If you do not use the rack, the food may touch the bottom of the bath, causing the food to pick up from the bottom. The racks help prevent food from reaching the floor and allow food to be uniformly cooked. Install the rack in a bath so that it has a "U" shape.

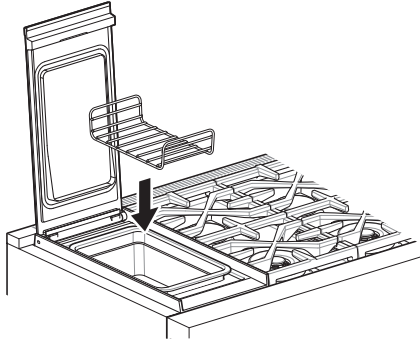

No Preheating Cooking

The Sous-Vide Module can be cooked without preheating. Before you start cooking, put the vacuum packed food with water in the bath, set the temperature and set the time. However, set the temperature and time to suit each dish. If you are cooking without pre heating, please ignore "Pre" displayed on the knob and Pre Heating alarm.

Moving the Sous Vide Bath

Before Sous-Vide Cooking. When moving the bath, hold the bath back and forth, lift the bath completely, and move it. If there is a lot of water in the bath and the bath is heavy, take the water out and put the bath into the Sous-Vide case. Place the bath in the

Sous-Vide case and fill it with as much water as you drained. **After Sous-Vide Cooking.** Be sure to move the bath after the water in the bath has cooled down. Open the door fully, grasp the front and back of the bath, lift it completely out of the case and move the bath. If there is a lot of water in the bath and the bath is heavy, remove some water and move the bath.

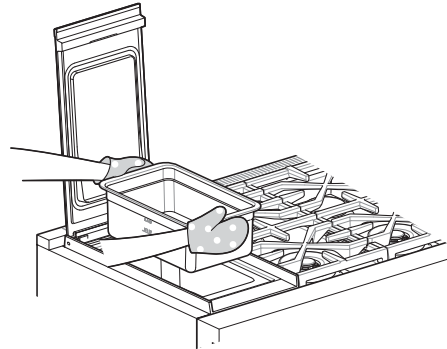

NOTE

- If you move the bath during cooking on the cook top, be careful that your arm touch the hot pot on the cook top.
- Be careful to spill the water into the product when you move the bath.
- After cooking, the bath may be hot. Be sure to wear the oven gloves and move the bath.

Setting the Temperature

Check the temperature indicated on the knob and turn the knob to a temperature close to the desired temperature. Turn the knob ring to the left or right to set the desired temperature. The temperature can be set between 120 °F and 200 °F at 1 °F.

For example, if you set 168 °F

- 1 Place the knob at 170 °F. The display shows 170 °F.

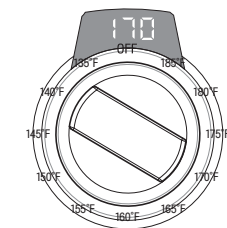

Sous Vide Temp.

- 2 Turn the knob Ring counterclockwise twice to set 168 °F. Turn the knob once and automatically return to the home position, then turn it again to set 168 °F to the display.

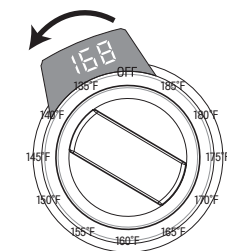

Sous Vide Temp.

Setting the Cook Time

Check the cook time indicated on the knob and turn the knob to a cook time close to the desired cook time. Turn the knob ring to the left or right to set the desired cook time. The cook time can be set between 1 min. and 48 hr at 1 min.

For example, if you set 43 min

- 1 Place the knob at 30 min. The display shows 30 min.

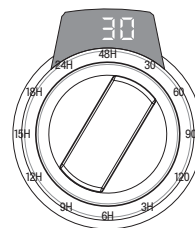

Sous Vide Temp.

- 2 Turn the knob ring clockwise 3 times to set 33 min. Turn the knob once and automatically return to the home position, then turn it again to set 33 min to the display.

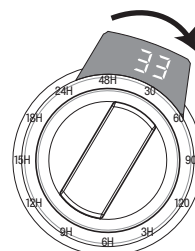

Sous Vide Temp.

Using Oven Racks

Be sure to use the supplied bath for the Sous-Vide module and place it correctly on the heater on the bottom of the Sous-Vide case. If you do not use the supplied bath for the Sous-Vide module or correctly place the bath on the heater, the sensor in the center of the heater will not detect the water temperature properly, the water will not be heated or the heat will not be transferred from the heater to the bath properly. Correct the problem before attempting to use the Sous-Vide. If you close the door without positioning the bath properly, the door can be damaged. Be sure to position the bath properly and close the door. If there is debris or water on the surface of the bottom of the bath or on the surface of the heater, the heat of the heater may not be evenly distributed to the bath or fire may be caused by the heat of the heater.

Correct

- Bath is centered correctly on surface of heater.
- Use the bath provided with the product.
- There should be no debris or water on the heater surface and the bottom of the bath.

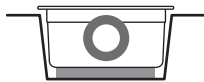
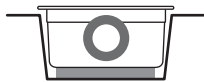

Incorrect

- Bath bottom rests on side of case or does not rest completely on the heater surface.
- Do not use the bath provided.
- Use it with debris or water on the bottom of the bath or on the surface of the heater.

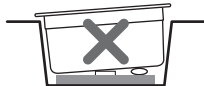
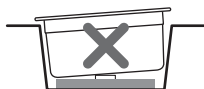

Filling the Water

Be sure to fill the bath with clean water. Be sure to drain the water you used once and wash the bath, then use fresh water. If water is reused, contaminated water can cause illness. Fill with 68 ° F water and start cooking. Filling hot or cold water can affect cooking time and results. Fill the water between Max and Min scale. Keep in mind that the water level is increased by the addition of food and fill the water first. Be sure to fill the water so that the food is completely immersed in the water. If the food does not fully immersed in the water, please add water. If the food floats in the water and is not completely immersed, place an appropriate weight (eg a dish) on it to allow the food to settle.

NOTE

- Keep the Sous Vide module and water bath exterior free from water or debris when not in use. If needed, clean and dry both before using.
- Take care to avoid spilling water into the product when loading the water bath.

Sous Vide Cook Guide

The cooking times listed are approximate only, as each type of food to be cooked is different in nature and consistency. When processing frozen food, the cooking times are increased.

Food	Temp. (°F)	Time (mins.)	
Steak (1-1.5") Rib, Rib eye, Top loin, T-bone, Porterhouse	Medium	135	120-180
	Well done	158	45-180
Pork (1-2") Chops-Boneless	Medium rare	140	60-150
	Medium well	149	60-150
Chicken (1-1.5") Breast-Boneless	Medium	140	90-180
	Well	149	60-180
Vegetables	Root	185	60-240
	Tender		20-60
Fish (1-1.5") Fillet, Steak	Medium well	140	40-90
Eggs (Large) Whole, In Shell	Soft cooked in shell	145	45-90
	Hard cooked in shell	165	45-90

Using the Oven

Before Using the Oven

NOTE

- Because the oven temperature cycles, an oven thermometer placed in the oven cavity may not show the same temperature that is set on the oven.
- It is normal for the convection fan to run while preheating during a regular bake cycle.
- The convection fan motor may run periodically during a regular bake cycle.
- If the door is left open for longer than 30 seconds during baking, the heat turns off. The heat turns back on automatically once the door is closed.
- After using the steam function, drain the water in the water tank and clean the water tank and the oven cavity. Wipe off any moisture in the oven cavity.

Oven Vent

Areas near the vent may become hot during operation and may cause burns. Do not block the vent opening. Avoid placing plastics near the vent as heat may distort or melt the plastic.

It is normal for steam to be visible when cooking foods with high moisture content.

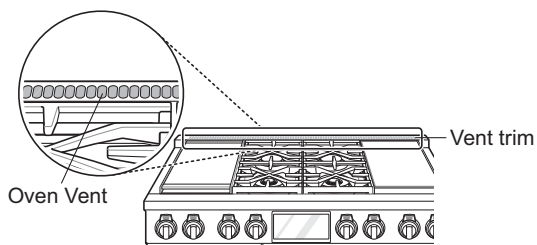

CAUTION

- **The edges of the range vent and vent trim are sharp and may become hot during operation.** Wear gloves when cleaning the range to avoid burns or other injury.

Using Oven Racks

The racks have a turned-up back edge that prevents them from being pulled completely out of the oven cavity.

Removing Racks

- 1 Pull the rack straight out until it stops.
- 2 Lift up the front of the rack and pull the rack out.

Replacing Racks

- 1 Place the end of the rack on the support. Make sure rack is level and both sides are in the same rack position.
- 2 Tilt the front end up and push the rack in.



CAUTION

- Place oven racks in the desired location before turning on the oven to avoid burns.
- Do not cover the racks with aluminum foil, or any other material, or place anything on the bottom of the oven. Doing so will result in poor baking and may damage the oven bottom.

Accessories for Right Oven

Broiler Pan and Grid

Use a broiler pan and grid when preparing meats for Convection Roast, Rapidheat Roast, and Broil.

The broiler pan catches grease spills and the grid helps prevent grease splatters.

- 1 Place the rack in the oven.
- 2 Place the grid in the broiler pan with the raised vents toward the bottom.
- 3 Place the broiler pan and grid on the rack.

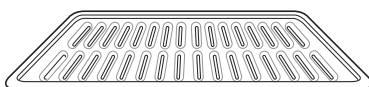

Grid

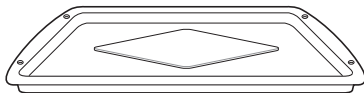

Broiler pan

CAUTION

- Do not use a broiler pan without a grid. Oil can cause a grease fire.
- Do not cover the grid and broiler pan with aluminum foil. Doing so will cause a fire.
- Always use a broiler pan and grid for excess fat and grease drainage. This will help to reduce splatter, smoke, and flare-ups.
- Do not broil meat too close to the burner flame. Trim excess fat from meat before cooking.
- Position food (fat side up) on the grid.

Accessories for Left Oven

When using the Steam cooking function, use the nested steam trays for best results.

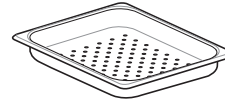

Perforated Large tray 1 ea

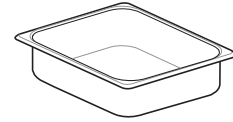

Large tray 1 ea

Using the Large Steamer Trays

- 1 Place food on the perforated tray.
- 2 Insert the perforated tray into the desired rack guides in the oven and slide it into the cavity until it stops.
- 3 Insert the solid tray into the rack guides just below the perforated tray and slide it into the cavity.

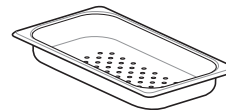

Perforated Small tray 1 ea

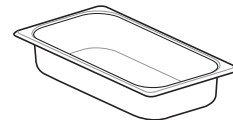

Small tray 1 ea

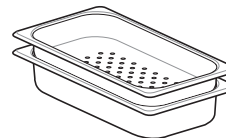

Nested trays

Using the Small Steamer Trays

- 1 Place food on the perforated tray.
- 2 Insert the perforated tray into the solid tray.
- 3 Place the nested trays on the oven rack.

NOTE

- Use only steam cooker for large and small trays.
- Do not use for baking and roasting.

Timer

The oven timers don't affect oven operation or cooking time. Use them as extra kitchen timers. Once the time runs out, the oven chimes and "End" appears in the display.

Setting the Timer

- 1 Touch either clock icon  at the bottom of the display.
- 2 Scroll through the numbers in the popup until the desired time appears in the display and touch OK.
- 3 The time remaining appears next to the clock icon in the display.

Adjusting or Cancelling the Timer

- 1 Touch the remaining time next to the clock icon in the display.
- 2 To cancel the timer, touch Reset  in the popup, then touch OK.
- 3 To adjust the time, scroll the numbers in the popup until the desired time appears, then touch OK.
- 4 The remaining time in the display is adjusted.

Bake

Bake is used to prepare foods such as pastries, breads and casseroles.

The oven can be programmed to bake at any temperature from 170 °F(80 °C) to 550 °F(285 °C). The default temperature is 350 °F(175 °C).

Setting the Bake Function

- 1 Select the desired oven in the display then select Bake in the cooking mode screen.
 - 2 Scroll through the numbers to select a cooking temperature or touch the number pad icon  to enter the numbers directly.
 - 3 If desired, set the cook time and delayed start time using the same method. Touch the arrow key on the right side of the display to see the delayed start time settings.
 - 4 Touch **Start**. The oven starts to preheat.
 - 5 If the cook time is set, the remaining time appears in the display. If a delayed start time is set, the start time appears in the display.
 - 6 A chime sounds once preheating is complete.
 - 7 A chime sounds at the end of the set cook time and a notification appears in the display. Open the oven door and remove the food.
- If no cook time is set, the oven turns off automatically after 3 hours.

Changing the Cook Settings

- 1 Touch **Edit** in the display to bring up the Cook Settings screen.
- 2 Adjust the settings using the number pad or scroll function.
- 3 Touch **Start**.

To Stop Cooking

- 1 Touch **Stop** in the display, then select Yes.

NOTE

It is normal for the convection fan to operate periodically throughout a normal bake cycle. In the oven. This is to ensure even baking results.

Baking Tips

- Baking time and temperature will vary depending on the characteristics, size, and shape of the baking pan used.
- Check for food doneness at the minimum recipe time.
- Use metal bakeware (with or without a nonstick finish), heatproof glass-ceramic, ceramic or other bakeware recommended for oven use.
- Dark metal pans or nonstick coatings will cook food faster with more browning. Insulated bakeware will slightly lengthen the cooking time for most foods.

NOTE

The oven bottom has a porcelain-enamel finish. To make cleaning easier, protect the oven bottom from excessive spillovers by placing a foil-lined cookie sheet on the rack below the rack you are cooking on. This is particularly important when baking a fruit pie or other foods with a high acid content. Hot fruit fillings or other foods that are highly acidic may cause pitting and damage to the porcelain-enamel surface and should be wiped up as soon as it is safe to do so.

Convection Modes

- For best results when cooking meat, use the broiler pan and grid. See "Accessories for Right Oven."

Convection Bake and Convection Roast use a fan to circulate heat evenly within the oven. This improves heat distribution and allows for even cooking and excellent results whether cooking on one rack or multiple racks.

Using Convection

- 1 Select the desired oven in the display, then select Convection Bake or Convection Roast in the Cooking Modes screen.
 - 2 Scroll through the numbers to select a cooking temperature or touch the number pad icon  to enter the numbers directly.
 - 3 If desired, set the cook time and delayed start time using the same method. Touch the arrow key on the right side of the display to see the delayed start time settings.
 - 4 Touch **Start**. The oven starts to preheat.
 - 5 If the cook time is set, the remaining time appears in the display. If a delayed start time is set, the start time appears in the display.
 - 6 A chime sounds once preheating is complete.
 - 7 A chime sounds at the end of the set cook time and a notification appears in the display. Open the oven door and remove the food.
- If no cook time is set, the oven turns off automatically after 3 hours.

Changing the Cook Settings

- 1 Touch **Edit** in the display to bring up the Cook Settings screen.
- 2 Adjust the settings using the number pad or scroll function.
- 3 Touch **Start**.

To Stop Cooking

- 1 Touch **Stop** in the display, then select Yes.

NOTE

The oven fan runs while convection baking. The fan stops when the door is open. In some cases, the fan may shut off during a convection bake cycle.

Tips for Convection Baking

- Use Convection Bake for faster and more even multiple-rack cooking of pastries, cookies, muffins, biscuits, and breads of all kinds.
- Bake cookies and biscuits on pans with no sides or very low sides to allow heated air to circulate around the food. Food baked on pans with a dark finish will cook faster.
- When using Convection Bake with a single rack, place the oven rack in position 3. If cooking on multiple racks, place the oven racks in positions 1 and 3 (for two racks).
- Multiple oven rack cooking may slightly increase cook times for some foods.
- Cakes, cookies and muffins have better results when using multiple racks.

Convection Roast

The Convection Roast feature is designed to give optimum roasting performance. Convection Roast combines cooking with the convection fan to roast meats and poultry. The heated air circulates around the food from all sides, sealing in juices and flavors. Foods are crispy brown on the outside while staying moist on the inside. Convection roasting is especially good for large tender cuts of meat, uncovered.

Rapidheat Roast

The Rapidheat Roast feature is designed to quickly roast poultry. The combination of intense heat from the upper and lower heating elements and heated air from the back heating element results in crispier food and shorter cooking times. The Rapidheat Roast is especially good for medium sized poultry.

NOTE

- The recommended cook time is 60-65 minutes for a whole chicken weighing 3.3 lb.
- Adjust the cook time according to the weight of the poultry.
- Place the oven rack in position 2.
- Rapidheat Roast is designed to reduce the cooking time. There is no need for preheating.
- This function is optimized for poultry, so and the cooking temperature cannot be adjusted.
- It is normal for the fan to operate during the Rapidheat Roast function.

Setting the Rapidheat Roast Function

- 1 Select Right Oven in the display, then touch **Rapidheat Roast**.
- 2 Touch **Start**.

Stopping during Cooking

- 1 Touch **Stop** in the display, then select Yes.

Recommended Baking and Roasting Guide

Baking results will be better if baking pans are centered in the oven as much as possible. If cooking on multiple racks, place the oven racks in the positions shown.

Rack and Pan Placement

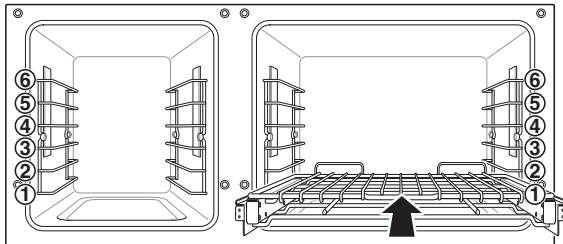

Multiple Rack Guide

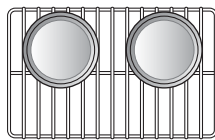

Rack (Position 1)

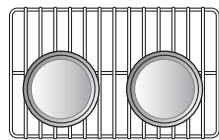

Rack (Position 3)

Single rack baking

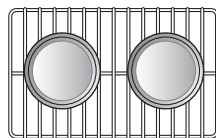

Rack

Baking Rack Guide

Food	Rack position		
	Left Oven	Right Oven	
Cakes	• Layer cakes	3	3
	• Bundt cakes	3	3
Cookies	• Sugar cookies	3	3
	• Chocolate chips	3	3
	• Brownies	3	3
Pizza	• Fresh	3	2
	• Frozen	3	2
Pastry Crust	• From scratch	3	2
	• Refrigerator	3	2
Breads	• Biscuit, canned	3	3
	• Biscuit, from scratch	3	2
	• Muffins	3	2
Desserts	• Fruit crisps and cobblers, from scratch	3	3
	• Pies, from scratch, 2-crust fruit	3	2

Roasting Rack Guide

Food	Rack position		
	Right Oven		
Beef	Rib	Rare	1
		Medium	1
		Well done	1
	Boneless rib, top sirloin	Rare	1
		Medium	1
		Well done	1
Beef tenderloin	Rare	1	
	Medium	1	
Pork	Rib		1
	Bone-in, sirloin		1
	Ham, cooked		1
Poultry	Whole chicken		1
	Chicken pieces		1
	Turkey		1

Broil

The Broil function uses intense heat from the upper heating element to cook food. Broiling works best for tender cuts of meat, fish, and thinly cut vegetables.

Keep the oven door closed while broiling. Let the oven preheat for approximately five minutes before cooking food.

- For best results, use a broiler pan and grid. See "Accessories for Right Oven."

Setting the Broil Function

- 1 Select the desired oven in the display and touch **Broil** in the Cooking Modes screen.
- 2 Scroll to set the desired temperature: Low, Medium, or High. If desired, scroll to set a cook time.
- 3 Touch **Start**. If the cook time was set, the remaining time appears in the display. The oven door must be closed to use the Broil function.
- 4 Let the oven preheat for approximately five minutes before cooking the food.
- 5 Touch **STOP** to cancel at any time or when cooking is complete.

- If the cook time is not set, the oven automatically turns off after 3 hours.

Changing the Broil Settings

- 1 Touch **Edit** in the display to bring up the Cook Settings screen.
- 2 Adjust the settings.
- 3 Touch **Start**.

To Stop Broiling

- 1 Touch **Stop** in the display, then select Yes.

NOTE

- This range is designed for closed-door broiling. Close the door to set the Broil function. If the door is open, the Broil function cannot be set a popup appears in the display. If the door remains open for longer than 5 seconds, the broil burner turns off. Once the door is closed, the broil burner turns back on automatically.

Smoking

Due to the intense heat associated with broiling, it is normal to experience smoke during the cooking process. This smoke is a natural by product of searing and should not cause you to worry. If you are experiencing more smoke than you are comfortable with, use the following tips to reduce the amount of smoke in your oven.

- 1 Always use a broiler pan. Do not use saute pans or regular baking sheets for safety reasons.
- 2 The broiler pan should always be thoroughly cleaned and at room temperature at the beginning of cooking.
- 3 Always run your cooktop ventilation system or vent hood during broiling.
- 4 Keep the interior of your oven as clean as possible. Leftover debris from prior meals can burn or catch fire.
- 5 Avoid fatty marinades and sugary glazes. Both of these will increase the amount of smoke you experience. If you would like to use a glaze, apply it at the very end of cooking.
- 6 If you are experiencing significant smoke with any food item, consider:
 - Lowering the broiler to the Lo setting.
 - Lowering the rack position to cook the food further away from the broiler.
 - Using the Hi broil setting to achieve the level of searing you desire, and then either switching to the Lo broil setting, or switching to the Bake function.
- 7 As a rule, fattier cuts of meat and fish will produce more smoke than leaner items.
- 8 Adhere to the recommended broil settings and cooking guidelines in the chart on the following page whenever possible.

Recommended Broiling Guide

The size, weight, thickness, starting temperature, and your preference of doneness will affect broiling times.

This guide is based on meats at refrigerator temperature. For best results when broiling, use a pan designed for broiling.

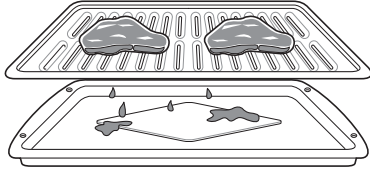

Food	Quantity and/or Thickness	Left Oven			Right Oven			Comments
		Rack Position	First Side (minutes)	Second Side (minutes)	Rack Position	First Side (minutes)	Second Side (minutes)	
Ground Beef Well done	1 lb. (4 patties) 1/2 to 3/4" thick	2	4-7	2-5	4	4-7	3-5	Space evenly. For 1-4 patties, use Speed Broil in upper oven. For more than 4 patties, use Broil in lower oven.
Beef Steaks Rare Medium Well done	1" thick 1 to 1 1/2 lbs.	2 2 2	3-4 4-5 5-6	2-3 2-3 3-4	4 4 4	4-5 4-7 6	2-3 3-4 4-5	Steaks less than 1" thick cook through before browning. Pan frying is recommended. Slash fat.
Rare Medium Well done	1 1/2" thick 2 to 2 1/2 lbs.	1 1 1	8 9 10	3-4 4-5 5-6	3 3 3	10 10-12 12	4 5-6 6-8	
Chicken	1 whole cut up 2 to 2 1/2 lbs., split lengthwise 2 Breasts	1 1	10 8-10	4-6 3-5	3 3	14-16 8-9	4-6 3-5	
Lobster Tails	2-4 10 to 12 oz. each	-	-	-	2	14	Do not turn over	Cut through back of shell. Spread open. Brush with melted butter before broiling and after half of broiling time.
Fish Fillets	1/4 to 1/2" thick	2	5	2-3	4	6	3-4	Handle and turn very carefully. Brush with lemon butter before and during cooking, if desired.
Ham Slices (precooked)	1/2" thick	2	4-5	2-3	4	6-8	2-4	Increase time 5 to 10 minutes per side for 1 1/2" thick or home-cured ham.
Pork Chops Well done	1 (1/2" thick) 2 (1" thick) about 1 lb.	2 1	7 7	3-5 2-4	4 3	5-6 9-10	2-4 4-6	
Lamb Chops Medium Well done	2 (1" thick) about 10 to 12 oz.	2 2	4-5 5-6	2-3 3-4	4 4	6 8	3-4 4-5	
Medium Well done	2 (1 1/2" thick) about 1 lb.	1 1	9 10	4-5 5-6	3 3	10 12	5-6 6-8	
Salmon Steaks	2 (1" thick) 4 (1" thick) about 1 lb.	2 1	6 7	3-5 3-5	4 3	8 9	4-6 4-6	Grease pan. Brush steaks with melted butter.

- This guide is only for reference. Adjust cook time according to your preference.
- For best performance, center food on rack when using Broil.

Tips for Broiling

Beef

- Steaks and chops should always be allowed to rest for five minutes before being cut into and eaten. This allows the heat to distribute evenly through the food and creates a more tender and juicy result.
- Pieces of meat that are thicker than two inches should be removed from the refrigerator 30 minutes prior to cooking. This will help them cook more quickly and evenly, and will produce less smoke when broiling. Cooking times will likely be shorter than the times indicated in the Broiling Chart.
- For bone-in steaks or chops that have been *frenched* (all meat removed from around the bone), wrap the exposed sections of bone in foil to reduce burning.

Seafood

- When broiling skin-on fish, always use the Lo broil setting and always broil the skin side last.
- Seafood is best consumed immediately after cooking. Allowing seafood to rest after cooking can cause the food to dry out.
- It is a good idea to rub a thin coating of oil on the surface of the broiling pan before cooking to reduce sticking, especially with fish and seafood. You can also use a light coating of non-stick pan spray.

Vegetables

- Toss your vegetables lightly in oil before cooking to improve browning.

Warm

The Warm mode maintains an oven temperature of 200°F or less. Use the Warm mode to keep cooked food at serving temperature for up to three hours after the end of the cooking cycle. Do not use the Warm mode to try to cook food or reheat cold food.

Setting the Warm Function

- 1 Select the desired oven in the display, then touch **Warm** in the Cooking Modes screen.
 - 2 Scroll to set the desired temperature: Low, Medium, or High. If desired, scroll to set a run time.
 - 3 Touch **Start**. If the run time was set, the remaining time appears in the display.
- If the run time is not set, the Warming function turns off automatically after 3 hours.

NOTE

- The warm feature has three temperature levels: High=200 °F, Med=170 °F, Low=140 °F
High=93 °C, Med=77 °C, Low=60 °C

Changing the Warm Settings

- 1 Touch **Edit** in the display to bring up the Cook Settings screen.
- 2 Adjust the settings as desired.
- 3 Touch **Start**.

Canceling the Warm Function

- 1 Touch **Stop** in the display, then select Yes.

NOTE

- The Warm function is intended to keep food warm. Do not use it to cool food down.
- It is normal for the fan to operate during the Warm function.

Proof

This feature maintains a warm oven for rising yeast leavened products before baking.

Setting the Proof Function

- 1 Select the desired oven in the display, then touch **Proof** in the Cooking Modes screen.
 - 2 Scroll through the numbers to set a proofing time or touch the number pad icon  to enter the numbers directly.
 - 3 Touch **Start**. The remaining proofing time appears in the display.
- If the proofing time is not set, the oven automatically turns off after 3 hours.

Canceling the Proof Function

- 1 Touch **Stop** in the display, then select Yes.

NOTE



- To avoid lowering the oven temperature and lengthening proofing time, do not open the oven door unnecessarily. Check bread products early to avoid over proofing.
- Do not use the proofing mode for warming food or keeping food hot. The proofing oven temperature is not hot enough to keep foods at safe temperatures. Use the Warm feature to keep food warm. Proofing does not operate when the oven is above 125 °F. **“Oven is too hot”** appears in the display.
- It is normal for the fan to operate during the Proof function.

Probe

The probe accurately measures the internal temperature of meat, poultry and casseroles. It should not be used during broiling, self clean, warming or proofing. Always unplug and remove the probe from the oven when removing food. Before using, insert the probe into the center of the thickest part of the meat or into the inner thigh or breast of poultry, away from fat or bones. Place the food in the oven and connect the probe to the jack. Keep the probe as far away from heat sources as possible.

- The probe cannot be used in Broil, Warm, or Proof modes.

Using the Probe

- 1 Insert the probe into the food.
- 2 Connect the probe to the jack in the oven, and "Probe is connected" pops up in the display and the probe icon  appears at the top of the display.
- 3 Select the desired oven, then select an appropriate cooking mode.
- 4 Scroll through the numbers to set a cooking temperature and a probe temperature or touch the number pad icon  to enter the numbers directly. The default probe temperature is 150 °F (65 °C), but can be changed to any temperature between 80 °F (27 °C) and 210 °F (100 °C).
- 5 If desired, set the delayed start time using the same method. Touch the arrow key on the right side of the display to see the additional settings.
- 6 Touch **Start**. If a delayed start time has been set, the start time appears in the display.
- 7 When the set probe temperature is reached, the oven shuts off automatically.

Changing the Cook Settings

- 1 Touch **Edit** in the display to bring up the Cook Settings screen.
- 2 Adjust the settings as desired.
- 3 Touch **Start**.

To Stop Cooking

- 1 Touch **Stop** in the display, then select Yes.

IMPORTANT NOTE

Touch Stop on the display at any time to cancel a cooking operation. To avoid breaking the probe, make sure food is completely defrosted before inserting.



CAUTION

- **Always use an oven mitt to remove the temperature probe. Do not touch the broil element.** Failure to obey this caution can result in severe personal injury.
- **To avoid damage to the meat probe, do not use tongs to pull on the probe when removing it.**
- **Do not store the meat probe in the oven.**

Recommended Probe Temperature Chart

Doneness	Probe Temp.
Beef, Lamb and Veal	
Rare	130 °F (54 °C)
Medium Rare	140 °F (60 °C)
Medium	150 °F (66 °C)
Well Done	160 °F (71 °C)
Pork	
Well Done	170 °F (77 °C)
Poultry	
Breast	170 °F (77 °C)
Thigh	180 °F (82 °C)
Whole Turkey/Chicken	165 °F (74 °C)

My Recipe

For frequently used cooking menus, you can combine up to three different temperatures and cooking modes into one hot key.

Creating My Recipe

- When combining two or more cooking modes, a cooking time or probe temperature must be set before selecting an additional cooking mode.
 - The Probe function cannot be used with the Broil, Warm, or Proof modes.
- 1 Select the desired oven in the display, then touch **My Recipe** in the Cooking Modes screen.
 - 2 Touch **Create** to make a new hot key.
 - 3 Select a first cook mode listed in the display and set the desired cook temperature.
 - 4 Touch **Set Cook Time** or **Set Probe**.
 - 5 If there are no additional cooking stages, touch **Done**. To add another cooking stage, set a cooking time or probe temperature for the first stage. Then touch **Add Cook Mode**.
 - 6 Repeat steps 3-5 until all desired cooking stages have been entered. Then touch **Done**.
 - 7 Enter a name for your recipe using the keyboard and touch **Save**.
 - 8 The recipe name is added to the My Recipes menu.

NOTE

If the probe was inserted in the oven jack to add a probe temperature, remember to remove it.

Editing My Recipe

- The Edit function cannot add or remove cooking stages to a recipe. Only the probe temperature and cook time can be changed.
- 1 Select the desired oven and touch **My Recipe** in the Cooking Modes screen.
 - 2 Select the recipe to edit then touch the pencil icon at the bottom left of the screen.
 - 3 Edit the settings for the first cooking stage and touch **Done** to proceed to the next cooking stage, if any.
 - 4 Edit the next cooking stage, touch **Done**, and proceed through all cooking stages in the same way.
 - 5 Once the last cooking stage has been edited, enter a new name for the recipe or keep the previous name, then touch **Save**.

Deleting My Recipe

- 1 Select the desired oven and touch **My Recipe** in the Cooking Modes screen.
- 2 Select the recipe and touch the trash can icon at the bottom left of the screen.
- 3 Touch **Yes**.

Auto Cook

The Auto Cook function provides guidance for cooking foods or dishes that may be unfamiliar. It contains preset programs for cooking many popular food items, with information on recommended preheating, accessories, and rack position for optimal results.

Setting Auto Cook Function

- 1 Select the desired oven and touch **Auto Cook** in the Cooking Modes screen.
 - 2 Touch a category to filter the options.
 - 3 Scroll through or tap the letters to find and select an item, then touch **Next**.
 - 4 Follow the recommendations in the display regarding accessories and rack position.
 - 5 Touch **Start**.
- Update the Auto Cook menus regularly using the Signature Kitchen Suite mobile application.

Steam Function(Left Oven Only)

Steam cooking uses the moist heat of steam to cook food. This is an ideal cooking method for delicate food items such as seafood, which can lose nutrients when boiled.

The left oven provides 3 methods of steam cooking: Steam, Steam Assist, and Auto Steam.

Using the Steam Feeder Tank

The steam feeder tank is located over the left oven cavity.

- 1 Gently push the front of the steam feeder tank to slide it out.

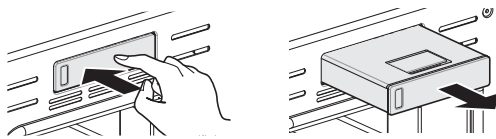

- 2 Remove the tank and place it on a flat surface.
- 3 Remove the tank cover or flip open the fill lid at the front of the tank cover.
- 4 Fill the tank to the max line located at the front of the tank. Use softened, filtered water, if possible. Hard water may clog the steam generator more quickly with scale buildup.

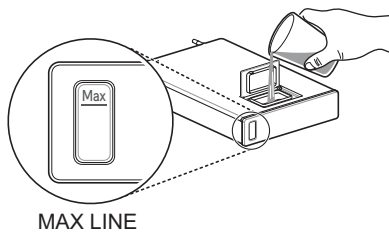

- 5 Assemble the cover or snap closed the fill lid.

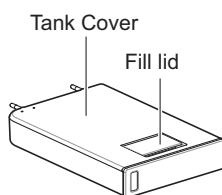

CAUTION

- Make sure the tank cover and fill lid are closed before putting in the oven.

- 6 Carefully insert the tank into the steam feeder slot, making sure to keep the tank level while carrying it. If the tank is not kept level, water will drain out of the tubes in the back.
- 7 Slide the tank into the slot until it clicks into place.

Steam Mode

Select the Steam mode to cook food without the assistance of the oven heating elements, using only the moist heat produced by steam. The available temperature range is 176°F (80°C) to 212°F (100°C).

Setting Steam Mode

- 1 Touch **Left Oven**, then touch **Steam Cook**.
- 2 Touch **Steam**
- 3 Scroll through the numbers to set a cooking temperature or touch the number pad icon  to enter the numbers directly.
- 4 If desired, set the cook time and delayed start time using the same method. Touch the arrow key on the right side of the display to see the delayed start time settings.
- 5 Touch **Start**.

Steam-Assist Mode

The Steam-Assist mode heats food gradually, using both the oven heating elements and moist steam heat. Preset temperature options start at 212°F (100°C).

Setting Steam-Assist Mode

- 1 Touch **Left Oven**, then touch **Steam Cook**.
- 2 Touch **Steam-assist**.
- 3 Select the desired temperature level: Low, Medium, or High.
- 4 If desired, scroll to set the cook time and delayed start time. Touch the arrow key on the right side of the display to see the delayed start time settings.
- 5 Touch **Start**.

Once Steam-Assist cooking is started, an indicator on the display shows the status of the steam function. Yellow indicates that the steam function is on, grey indicates that the steam function is off.

Make sure the steam feeder tank is filled with water before starting the Steam-Assist mode. If the water in the tank runs out during cooking, a chime sounds and a popup appears in the display. The oven continues to cook without steam.

The steam cooking modes can only be used with the left oven.

NOTE

- Remember to drain the steam feeder tank after use.

Changing the Steam Cook Settings

- 1 Touch **Edit** in the display to bring up the Cook Settings screen.
- 2 Adjust the settings as desired.
- 3 Touch **Start**.

To Stop Steam Cooking

- 1 Touch **Stop** in the display, then select Yes.

Auto Steam

Get great results using preset steam cooking recipes that include recommendations for accessories and rack position.

Setting Auto Steam Function

- 1 Touch **Left Oven**, then touch **Steam Cook**.
- 2 Touch **Auto Steam**.
- 3 Touch a category to filter the options.
- 4 Scroll through or tap the letters to find and select an item, then touch **Next**.
- 5 Follow the recommendations in the display regarding accessories and rack position.
- 6 Touch **Start**.

- Update the Auto Steam menus regularly using the Signature Kitchen Suite mobile application.

Remote Start

If the appliance is registered on a home Wi-Fi network, the preheating function of the oven can be started or stopped using the SIGNATURE KITCHEN SUITE smart phone app.

Preparing the Oven for a Remote Start

- 1 Open the oven door to make sure the oven is empty and ready for preheating. Do not place food in the oven. Close the oven door.
- 2 Touch **SETTINGS**, located at the center bottom of the display. Touch Remote Start on the first Settings screen, then select On. Follow the instructions on the popup that opens in the display.
- 3 Follow the instructions in the SIGNATURE KITCHEN SUITE smart phone app for using the Remote Start function.

NOTE

- Remote Start is disconnected in the following situations:
 - Remote Start is never set up in the smart phone app.
 - The Remote Start status is “ready”.
 - Remote Start experiences a problem during operation.
- The Wi-Fi icon on the display shows the status of the appliance's network connection. If the Wi-Fi icon is not lit, use the smart phone app to select the Wi-Fi network or register the product again.
- A faulty Wi-Fi connection could delay the Remote Start function.

SMART FUNCTIONS

SIGNATURE KITCHEN SUITE

Application

The SIGNATURE KITCHEN SUITE application allows you to communicate with the appliance using a smartphone.

Before Using SIGNATURE KITCHEN SUITE

- 1 Use a smartphone to check the strength of the wireless router (Wi-Fi network) near the appliance.
 - If the distance between the appliance and the wireless router is too far, the signal strength becomes weak. It may take a long time to register or installation may fail.
- 2 Turn off the **Mobile data** or **Cellular Data** on your smartphone.
 - For iPhones, turn data off by going to **Settings** → **Cellular** → **Cellular Data**.

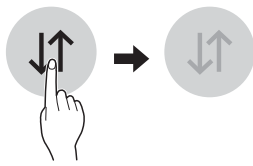

- 3 Connect your smartphone to the wireless router.

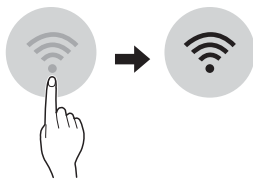

NOTE

- To verify the Wi-Fi connection, check that **Wi-Fi**  icon on the control panel is lit.
- The appliance supports 2.4 GHz Wi-Fi networks only. To check your network frequency, contact your Internet service provider or refer to your wireless router manual.
- SIGNATURE KITCHEN SUITE is not responsible for any network connection problems or any faults, malfunctions, or errors caused by network connection.
- The surrounding wireless environment can make the wireless network service run slowly.
- If the appliance is having trouble connecting to the Wi-Fi network, it may be too far from the router. Purchase a Wi-Fi repeater (range extender) to improve the Wi-Fi signal strength.
- The network connection may not work properly depending on the Internet service provider.
- The Wi-Fi connection may not connect or may be interrupted because of the home network environment.
- If the appliance cannot be registered due to problems with the wireless signal transmission, unplug the appliance and wait about a minute before trying again.
- If the firewall on your wireless router is enabled, disable the firewall or add an exception to it.
- The wireless network name (SSID) should be a combination of English letters and numbers. (Do not use special characters.)
- Smartphone user interface (UI) may vary depending on the mobile operating system (OS) and the manufacturer.
- If the security protocol of the router is set to **WEP**, network setup may fail. Change the security protocol (**WPA2** is recommended), and register the product again.

Installing the SIGNATURE KITCHEN SUITE Application

Search for the SIGNATURE KITCHEN SUITE application from the Google Play Store or Apple App Store on a smart phone. Follow instructions to download and install the application.

NOTE

- If you choose the simple login to access the SIGNATURE KITCHEN SUITE application, you must go through the appliance registration process each time you change your smartphone or reinstall the application.

SIGNATURE KITCHEN SUITE Application Features

SpeedClean™

Allows you to set SpeedClean™ alerts, read the instruction guide, and simulate and compare energy consumption when using SpeedClean™ versus self-clean cycles.

Smart Diagnosis™

This function provides useful information for diagnosing and solving issues with the appliance based on the pattern of use.

Settings

Change oven settings, including the hour mode, preheat alarm light, beeper volume, temperature units, convection auto conversion, thermostat adjustment and language.

Remote Start

Turn off the oven or start the oven preheating remotely. Open and close the oven door, then select Remote Start in the Settings menu on the display within 30 seconds.

Monitoring

See the current status for the range, remaining cooking time, cook settings, and end cooking time.

Push Alert

Turn on alerts in the app to receive notifications about the current status of the appliance. Push alerts are sent even if the Signature Kitchen Suite app is off.

Timer

Set the timer from the app.

NOTE

- If you change your wireless router, your Internet service provider or your password after registering the appliance, delete it from the SIGNATURE KITCHEN SUITE **Settings** → **Edit Product** and register again.
- This information is current at the time of publication. The application is subject to change for product improvement purposes without notice to users.

Smart Diagnosis™ Function

Should you experience any problems with the appliance, it has the capability of transmitting data via your telephone to the SIGNATURE KITCHEN SUITE Customer Information Center. NFC or Wi-Fi equipped models can also transmit data to a smartphone using the SIGNATURE KITCHEN SUITE application.



Smart Diagnosis™ through the Concierge Service

- For appliances with the  or  logo

This method allows you to speak directly to our trained specialists. The specialist records the data transmitted from the appliance and uses it to analyze the issue, providing a fast and effective diagnosis.

- 1 Call the SIGNATURE KITCHEN SUITE Concierge Service at 1-855-790-6655.
- 2 Touch **SETTINGS**, located at the center bottom of the main display screen. Swipe to the third settings screen and select Smart Diagnosis™. Follow the instructions in the display.

NOTE



Do not touch any other buttons or icons on the display screen.

- 3 Touch **Start**.
- 4 Keep the phone in place until the tone transmission has finished. This takes about 6 seconds and the display will count down the time.
- 5 Once the countdown is over and the tones have stopped, resume your conversation with the call agent, who will then be able to assist you in using the information transmitted for analysis.

NOTE

- For best results, do not move the phone while the tones are being transmitted.
- If the call agent is not able to get an accurate recording of the data, you may be asked to try again.

SIGNATURE KITCHEN SUITE Smart Diagnosis™

- For appliances with the  or  logo

Use the Smart Diagnosis feature in the SIGNATURE KITCHEN SUITE application for help diagnosing issues with the appliance without the assistance of the SIGNATURE KITCHEN SUITE Customer Information Center.

Follow the instructions in the SIGNATURE KITCHEN SUITE application to perform a Smart Diagnosis using your smartphone.

- 1 Download the SIGNATURE KITCHEN SUITE application on your smart phone.
- 2 Open the SIGNATURE KITCHEN SUITE application on your smart phone. Touch the Smart Diagnosis™ button to advance to the next screen.
- 3 Follow directions of the application. If the Wi-Fi method does not work well, follow the instructions for using Audible Diagnosis.
- 4 Touch [?] in the SIGNATURE KITCHEN SUITE application for a more detailed guide on how to use the Wi-Fi function.

NOTE

- Smart Diagnosis™ cannot be activated unless the appliance can be turned on using the **Power** button. If the appliance cannot be turned on, troubleshooting must be done without using Smart Diagnosis™.
- Call quality differences by region may affect the function.
- Use a landline telephone for better communication performance, resulting in better service.
- Bad call quality may result in poor data transmission from your phone to the machine, which could cause Smart Diagnosis™ to malfunction.

Open Source Software Notice Information

To obtain the source code under GPL, LGPL, MPL and To obtain the source code under GPL, LGPL, MPL, and other open source licenses, that is contained in this product, please visit <http://opensource.thesignaturekitchen.com>. In addition to the source code, all referred license terms, warranty disclaimers and copyright notices are available for download.

SIGNATURE KITCHEN SUITE will also provide open source code to you on CD-ROM for a charge covering the cost of performing such distribution (such as the cost of media, shipping, and handling) upon email request to opensource@thesignaturekitchen.com. This offer is valid for a period of three years after our last shipment of this product. This offer is valid to anyone in receipt of this information.

Wireless LAN Module Specifications

Model	TWFM-K304D
Frequency Range	2412 MHz – 2462 MHz
Output Power (Max)	IEEE 802.11b : 19.58 dBm IEEE 802.11g : 19.84 dBm IEEE 802.11n(HT20) : 18.77 dBm IEEE 802.11n(HT40) : 17.25 dBm

FCC Notice

The following notice covers the transmitter module contained in this product.

This equipment has been tested and found to comply with the limits for a Class B digital device, pursuant to Part 15 of the FCC Rules and also Part 18 of the FCC Rules. These limits are designed to provide reasonable protection against harmful interference in a residential installation. This equipment generates, uses, and can radiate radio frequency energy and, if not installed and used in accordance with the instructions, may cause harmful interference to radio communications. However, there is no guarantee that interference will not occur in a particular installation. If this equipment does cause harmful interference to radio or television reception, which can be determined by turning the equipment off and on, the user is encouraged to try to correct the interference by one or more of the following measures:

- Reorient or relocate the receiving antenna.
- Increase the separation between the equipment and the receiver.
- Connect the equipment to an outlet on a circuit different from that to which the receiver is connected.
- Consult the dealer or an experienced radio/TV technician for help.

This device complies with Part 15, Part 18 of the FCC Rules. Operation is subject to the following two conditions:

- 1) this device may not cause harmful interference and
- 2) this device must accept any interference received, including interference that may cause undesired operation of the device.

Any changes or modifications in construction of this device which are not expressly approved by the party responsible for compliance could void the user's authority to operate the equipment.

FCC RF Radiation Exposure Statement

This equipment complies with FCC radiation exposure limits set forth for an uncontrolled environment. This transmitter must not be co-located or operating in conjunction with any other antenna or transmitter.

This equipment should be installed and operated with a minimum distance of 20 cm (7.8 inches) between the antenna and your body. Users must follow the specific operating instructions for satisfying RF exposure compliance.

MAINTENANCE

NOTE

- Depending on the model, your range may contain different cooktop modules requiring different maintenance procedures. Take care when cleaning the range to apply cleaners only as recommended.

CAUTION

- Do not clean this appliance with bleach.
- To prevent burns, wait until the cooktop has cooled down before touching any of its parts.
- Always wear gloves when cleaning the cooktop.

Control Panel

To prevent activating the control panel during cleaning, unplug the range. Clean up splatters with a damp cloth using a glass cleaner. Remove heavier soil with warm, soapy water. Do not use abrasives of any kind.

Gas Surface Burners

Removing and Replacing the Gas Surface Burners

Grates and burner heads/caps can be removed for care and cleaning.

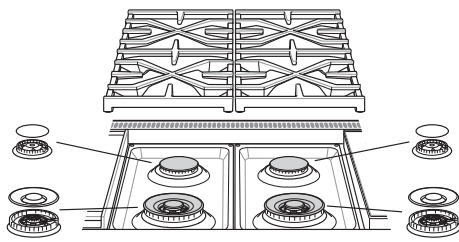

	General burner
Burner cap is properly set.	
Burner cap is NOT properly set.	

Cleaning Burner Heads/Caps

For even and unhampered flame, the slits in the burner heads must be kept clean at all times. The burner heads and caps can be lifted off.

- Wash the burner caps in hot soapy water and rinse with clean water. Run water through the burner from the bottom stem to flush out debris.
- Use care when cleaning the cooktop. The pointed metal ends on the electrodes could cause injury. Hitting an electrode with a hard object may damage it.
- To remove burnt-on food, soak the burner heads in a solution of mild liquid detergent and hot water for 20–30 minutes. For stubborn stains, use a toothbrush.
- The burners will not operate properly if the burner ports or electrodes are clogged or dirty.
- Burner caps and heads should be cleaned routinely, especially after excessive spillover.
- Burners will not light if the cap is removed.

CAUTION

- Do not hit the electrodes with anything hard. Doing so could damage them.
- Do not use steel wool or scouring powders to clean the burners.
- Do not scratch or gouge the port features of the brass burner bases.
- It is normal for brass burners to become tarnished with use.

NOTE

- To clean the brass burners, use mild abrasive cleaners or liquid cleaners such as Kleen King®, BonAmi® and Wright's®.
- To clean port openings, use a stiff, nylon bristle tooth brush.
- Do not use steel wool or steel bristle brushes as they can scratch the brass burner surface.

After Cleaning the Burner Heads/Caps

Shake out any excess water and then let them dry thoroughly. Placing the burner upside down will allow the water to drain out more easily. Replace the burner heads and caps over the electrodes on the cooktop in the correct locations according to their size. Make sure the hole in the burner head is positioned over the electrode.

Burner Grates

The convertible wok grates should be used in the front, and the remaining grates in the back.

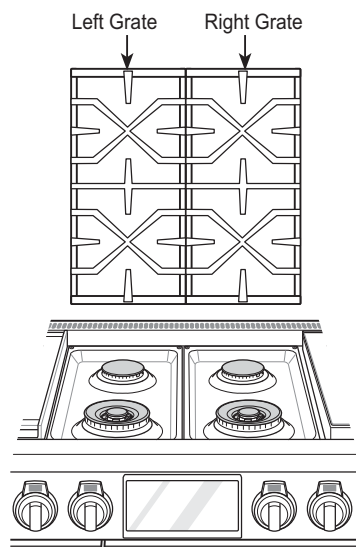

NOTE

Do not operate a burner for an extended period of time without cookware on the grate. The finish on the grate may chip without cookware to absorb the heat.

Cleaning the Burner Grates

CAUTION

- Do not lift the grates out until they have cooled.
- Do not put the grate in the oven during self cleaning mode.

- Grates should be washed regularly and after spillovers.
- Wash the grates in hot, soapy water and rinse with clean water.
- The grates are dishwasher safe.
- After cleaning the grates, let them dry completely and securely position them over the burners.

Gas Cooktop Surface

CAUTION

- To avoid burns, do not clean the cooktop surface until it has cooled.
- Do not lift the cooktop surface. Lifting the cooktop surface can lead to damage and improper operation of the range.
- When water is spilled on the cooktop, wipe up water immediately. If water is left on the cooktop for a long time, discoloration may occur.

Foods with high acid or sugar content may cause a dull spot if allowed to set. Wash and rinse soon after the surface has cooled. For other spills such as oil/grease spattering, etc., wash with soap and water when the surface has cooled, then rinse and polish with a dry cloth.

Sous Vide Module

⚠ CAUTION

- The sous vide handle may become hot during operation. Use oven mitts when handling during and after use.
- Wear oven mitts when removing the water bath. Do not touch the heater under the bath.
- Avoid spilling water into the sous vide module when moving the filled water bath.
- Remove the condensation from opening the sous vide cover with a dry towel.
- Do not use abrasive cleansers or scouring pads to clean the sous vide module. They will scratch the surface.

- Clean the outside of the sous vide module with a soft, damp cloth or sponge, using mild dish soap and warm water.
- To clean the inside of the module, use a paper towel or soft clean cloth to wipe off food or liquids. Dampen a soft cloth with mild soapy water and gently wipe clean.
- After cleaning, thoroughly wipe dry with a soft, clean cloth.

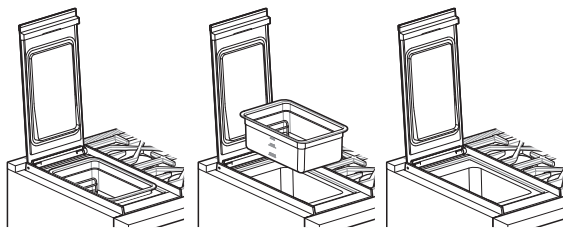

Induction Cooktop

⚠ CAUTION

- Do not use glass ceramic cooktop cleaners on other range surfaces.
- Do not use scrub pads or abrasive cleaning pads. They may damage the induction surface.
- For your safety, use an oven mitt or pot holder when using the scraper to clean the hot cooking surface.
- Read and follow all instructions and warnings on the cleaning cream label.

Use only glass-ceramic induction cooktop cleaner on the induction cooktop. Other creams may not be as effective or may scratch, damage or stain the induction cooktop.

To maintain and protect the surface of the glass Induction, follow these steps:

- 1 Before using the induction cooktop for the first time, clean it with a ceramic induction cooktop cleaner. This helps protect the top and makes cleanup easier.
- 2 Shake the cleaning cream well. Apply a few drops of cleaner directly to the induction cooktop.
- 3 Use a paper towel to clean the entire induction cooktop surface.
- 4 Rinse with clear water and use a dry cloth or paper towel to remove all cleaning residue.

NOTE

- Do not heat the induction cooktop until it has been cleaned thoroughly.
- Use ceramic Induction cleaner daily to help keep the cooktop looking new.

IMPORTANT

If any sugar or food containing sugar (preserves, ketchup, tomato sauce, jellies, fudge, candy, syrups, chocolate) spills, or plastic or foil melts on the induction cooktop, remove the molten material IMMEDIATELY with a metal razor scraper (it will not damage the decorated cooking surface) while the cooking surface is still hot to avoid the risk of damage to the glass-ceramic surface. For your safety, please use an oven mitt or pot holder while scraping the hot cooking surface.

Burned-On Residue

Follow these instructions to remove burnt on residue from the glass ceramic induction cooktop surface.

- 1 While the induction cooktop is still hot, remove any burnt on deposits or spilled food from the glass-ceramic cooking surface with a suitable metal razor scraper. (Similar to scraping paint off of a windowpane, it will not damage the decorated cooking surface.) Hold the scraper at a 30° angle to the induction cooktop.

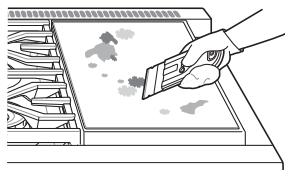

NOTE

- Do not use a dull or nicked blade.
- To prevent burns, wear an oven mitt or pot holder while using the metal scraper.

- 2 When the cooking surface has cooled down, apply a few dabs (about the size of a dime) of an approved cleaner in each burner area and work the cleaning cream over the induction cooktop surface with a damp paper towel.

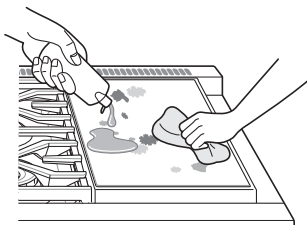

NOTE

Approved cleaners

- Weiman Cooktop Cleaning Cream (www.weiman.com)
- Cerama Bryte (www.ceramabryte.com)
- Golden Ventures Cerama Bryte
- Easy-Off 3 in 1 Glass Top Cleaner Spray (www.easyoff.us)

- 3 Rinse with clean water and wipe the induction cooktop surface with a clean, dry paper towel.

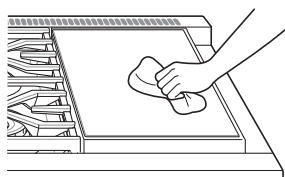

Metal Marks and Scratches

- Be careful not to slide pots and pans across the induction cooktop. Doing so will leave metal markings on the surface.
- To help remove these marks, use a ceramic induction cooktop cleaner with a cleaning pad made for use with ceramic glass induction cooktops.

CAUTION

Cookware with rough or uneven bottoms can mark or scratch the induction surface.

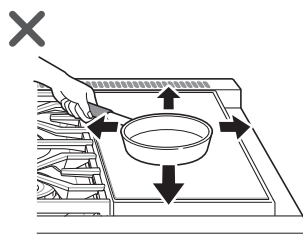

- Do not slide metal or glass across the induction surface.
- Do not use cookware with any dirt build-up on the bottom.

Exterior

Painted and Decorative Trim

For general cleaning, use a cloth with hot soapy water. For more difficult soils and built-up grease, apply a liquid detergent directly onto the soil. Leave it on for 30 to 60 minutes. Rinse with a damp cloth and dry. Do not use abrasive cleaners.

Stainless Steel Surfaces

To avoid scratches, do not use steel wool pads

- 1 Place a small amount of stainless steel appliance cleaner or polish on a damp cloth or paper towel.
- 2 Clean a small area, rubbing with the grain of the stainless steel if applicable.
- 3 Wipe with a clean, dry paper towel or soft cloth.
- 4 Repeat as necessary.

NOTE

- Use warm soapy water or a stainless steel cleaner or polish.
- Always wipe in the direction of the metal surface finish.
- To purchase stainless steel appliance cleaner or polish, or to locate a dealer near you, call our toll-free customer service number: 1-855-790-6655 or visit our website at : <http://www.thesignaturekitchen.com/>

Broiler Pan, Grid, and Steam Trays

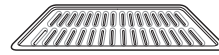

Grid



Broiler pan



Perforated Large&Small tray

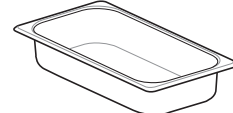

Large&Small tray

- Do not store the soiled broiler pan, grid, or steam trays in the range.
- Do not use the self-clean mode to clean the broiler pan, grid, or steam trays.
- Remove the grid from the broiler pan to clean. Carefully pour grease from the pan into an appropriate container.
- Use a plastic scouring pad to clean the broiler pan, grid, and steam trays in hot, soapy water.
- To remove burned on food, cover the grid while it's hot with a wet, soapy dishcloth or paper towels, and allow the residue to soften.
- The broiler pan, grid, and steam trays are dishwasher safe.

Oven Racks

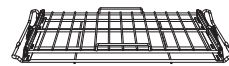

Large gliding rack

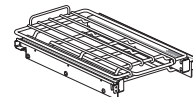

Small gliding rack

Remove the oven racks before operating the self clean cycle.

- 1 Food spilled into the tracks could cause the racks to become stuck. Clean racks with a mild, abrasive cleaner.
- 2 Rinse with clean water and dry.

NOTE

If the racks are cleaned using the self clean cycle (not recommended), the color will turn slightly blue and the finish will become dull. After the self clean cycle is complete, and the oven has cooled, rub the sides of the racks with wax paper or a cloth containing a small amount of vegetable oil. This will make the racks glide more easily into the rack tracks.

Oven Door

- Use soapy water to thoroughly clean the oven door. Rinse well. Do not immerse the door in water.
- You may use a glass cleaner on the outside glass of the oven door. Do not spray water or glass cleaner on the door vents.
- Do not use oven cleaners, cleaning powders, or harsh abrasive cleaning materials on the oven door.
- Do not clean the oven door gasket. The oven door gasket is made of a woven material that is essential for a good seal. Care should be taken not to rub, damage, or remove this gasket.

CAUTION

Do not use harsh cleaners or harsh abrasive cleaning materials on the oven door. Doing so can cause damage.

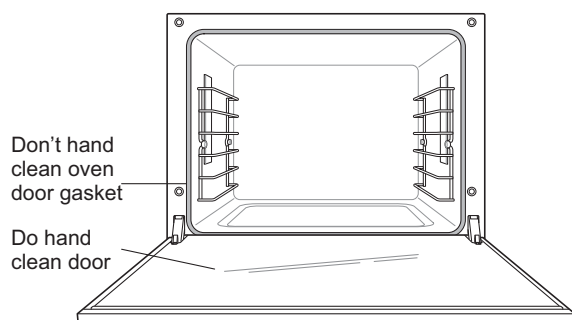

Front Manifold Panel and Knobs

It is best to clean the manifold panel after each use of the range. To clean, use a damp cloth and mild soapy water or a 50/50 solution of vinegar and water. Rinse with clean water and polish dry with a soft cloth.

The control knobs may be removed for easy cleaning.

- 1 To clean the knobs, make sure that they have the position indicator centered at the top or **Off** position and pull them straight off the stems.
- 2 To replace the knobs, make sure that the knobs have the position indicator centered at the top or **Off** position, and slide the knobs directly onto the stem.

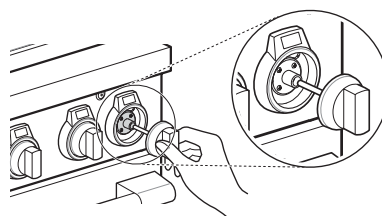

CAUTION

- Do not use abrasive cleansers, strong liquid cleaners, plastic scouring pads or oven cleaners on the manifold panel. Doing so will damage the finish.
- Do not try to bend the knobs by pulling them up or down, and do not hang a towel or other objects on them. This can damage the gas valve shaft.
- Do not try to remove the LED rings behind the control knobs.

NOTE

To prevent scratching, do not use abrasive cleaners on any of these materials.

SpeedClean™ (Right Oven)

SIGNATURE KITCHEN SUITE'S SpeedClean™ enamel technology provides two cleaning options for the inside of the range. The SpeedClean™ feature takes advantage of SIGNATURE KITCHEN SUITE'S new enamel to help lift soils without harsh chemicals, and it runs using ONLY WATER for just 10 minutes in low temperatures to help loosen LIGHT soils before hand-cleaning.

While SpeedClean™ is quick and effective for small and LIGHT soils, the Self Clean feature can be used to remove HEAVY, built up soils. The intensity and high heat of the Self Clean cycle may result in smoke which will require the opening up of windows to provide ventilation. Compared to the more intense Self Clean process, your SIGNATURE KITCHEN SUITE'S oven gives you the option of cleaning with LESS HEAT, LESS TIME, and virtually NO SMOKE OR FUMES.

When needed, the range still provides the Self Clean option for longer, more thorough oven cleaning for heavier, built up soils.

Benefits of SpeedClean™

- Helps loosen light soils before hand-cleaning
- SpeedClean™ only uses water; no chemical cleaners
- Makes for a better self-clean experience
 - Delays the need for a self-clean cycle
 - Minimizes smoke and odors
 - Can allow shorter self-clean time

When to Use SpeedClean™

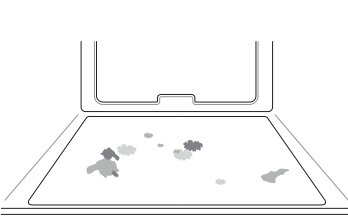
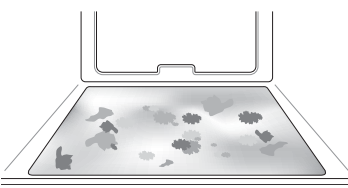
Suggested Cleaning Method	Example of Oven Soiling	Soil Pattern	Types of Soils	Common Food Items That Can Soil Your Oven
SpeedClean™		Small drops or spots	Cheese or other ingredients	Pizza
		Light splatter	Fat/grease	Steaks, broiled
				Fish, broiled
				Meat roasted at low temperatures
Self Clean*		Medium to heavy splatter	Fat/grease	Meat roasted at high temperatures
		Drops or spots	Filling or sugar based soils	Pies
			Cream or tomato sauce	Casseroles

* The Self Clean cycle can be used for soil that has been built up over time.

SpeedClean™ Instruction Guide

- 1 Remove oven racks and accessories from the oven.
- 2 Scrape off and remove any burnt-on debris with a plastic scraper.

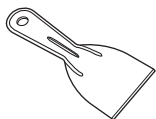

Suggested plastic scrapers:

- Hard plastic spatula
- Plastic pan scraper
- Plastic paint scraper
- Old credit card

- 3 Fill a spray bottle with 1¼ cups (10 oz or 300 ml) of water and use the spray bottle to thoroughly spray the inside surfaces of the oven.
- 4 Use at least ¼ cup (2 oz or 60 ml) of the water to completely saturate the soil on both the walls and in the corners of the oven.

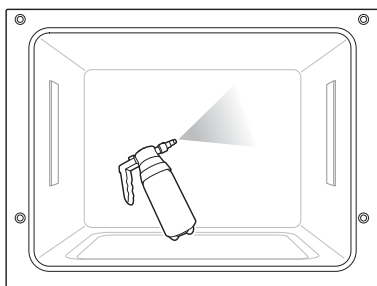

- 5 Spray or pour the remaining 1 cup (8 oz or 250 ml) of water onto the bottom center of the oven cavity. The indentation on the oven bottom should be fully covered to submerge all soils. Add water if necessary.

NOTE

Use the "mist" setting on the spray bottle for better coverage. The entire 1¼ cup (10 oz or 300 ml) of water should be used for each oven cavity cleaned. Do not spray water directly on the door. Doing so will result in water dripping to the floor.

- 6 Close the right oven door. Touch Right Oven, Clean, SpeedClean™ and Start in that order.

CAUTION

- Some surfaces may be hot after the SpeedClean™ cycle. Wear rubber gloves while cleaning to prevent burns.
- During the SpeedClean™ cycle, the oven may become hot enough to cause burns. Wait until the cycle is over before wiping the inside surface of the oven. Failure to do so may result in burns.
- Avoid leaning or resting on the oven door glass while cleaning the oven cavity.

- 7 A tone will sound at the end of the 10 minute cycle. Touch **End of Cleaning** to clear the display and end the tone.
- 8 After the cleaning cycle and during hand-cleaning, enough water should remain on the oven bottom to completely submerge all soils. Add water if necessary. Place a towel on the floor in front of the oven to capture any water that may spill out during hand-cleaning.
- 9 Clean the oven cavity immediately after the SpeedClean™ cycle by scrubbing with a wet, non-scratch scouring sponge or pad. (The scouring side will not scratch the finish.)

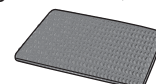

NOTE

Do not use any steel scouring pads, abrasive pads or cleaners as these materials can permanently damage the oven surface.

- 10 Once the oven cavity is cleaned, wipe any excess water with a clean dry towel. Replace racks and any other accessories.
- 11 If some light soils remain, repeat the above steps, making sure to thoroughly soak the soiled areas. If stubborn soils remain after multiple SpeedClean™ cycles, run the Self Clean cycle. Be sure that the oven cavity is empty of oven racks and other accessories, and that the oven cavity surface is dry before running the Self Clean cycle. Consult the Self Clean section of your owner's manual for further details.

NOTE

- If you forget to saturate the inside of the oven with water before starting SpeedClean™. Press Stop to end the cycle. Wait for the range to cool to room temperature and then spray or pour water into the oven and start another SpeedClean™ cycle.
- The cavity gasket may be wet when the SpeedClean™ cycle finishes. This is normal. Do not clean the gasket.
- If mineral deposits remain on the oven bottom after cleaning, use a cloth or sponge soaked in vinegar to remove them.
- It is normal for the fan to operate during the SpeedClean™ cycle.

SpeedClean™ (Left Oven)

This 10-minute process takes advantage of the steam generator in the left oven to help lift light soil. These directions are for the left oven only.

Setting SpeedClean™

- 1 Remove oven racks and accessories from the oven.
- 2 Fill the steam feeder tank with water to the maximum fill line (34 oz/1000 cc).
- 3 Touch Left Oven, Clean and SpeedClean™ in that order.
- 4 Touch Start. The remaining time appears in the display.

Cleaning Tips

- Allow the oven to cool to room temperature before using the SpeedClean™ cycle. If your oven cavity is above 150 °F (65 °C), **Hot** will appear in the display, and the SpeedClean™ cycle will not be activated until the oven cavity cools down.
- A plastic spatula can be used as a scraper to scrape off any chunks or debris before and during oven cleaning.
- Using the rough side of a non-scratch scouring pad may help to take off burnt-on stains better than a soft sponge or towel.
- Certain non-scratch scrubbing sponges, such as those made of melamine foam, available at your local stores, can also help improve cleaning.
- Make sure the range is level for best results when cleaning the right oven.
- For best results, use distilled or filtered water. Tap water may leave mineral deposits on the oven bottom.
- Soil baked on through several cooking cycles will be more difficult to remove with the SpeedClean™ cycle.
- Do not open the oven door during the SpeedClean™ cycle. Water will not get hot enough if the door is opened during the cycle.
- The self-clean cycle is better for cleaning hard to reach areas such as the back of the oven cavity.

Self Clean (Right Oven Only)

The Self Clean cycle uses extremely hot temperatures to clean the oven cavity. While running the Self Clean cycle, you may notice smoking or an odor. This is normal; especially if the oven is heavily soiled.

During Self Clean, the kitchen should be well ventilated to minimize the odors from cleaning.

Before Starting Self Clean

- Remove the oven racks, broiler pan, broiler grid, steam trays, oven rack guides, all cookware, aluminum foil or any other material from the oven.
- The kitchen should be well ventilated to minimize the odors from cleaning.
- Wipe any heavy spillovers on the bottom of the oven.
- The LED lighting inside the oven should be turned off. Make sure the LED cover is in place.
- The LED lighting inside the oven cannot be turned on until the oven temperature has cooled below 500 °F (260 °C) after a Self Clean cycle is complete.

Removing the Rack guide

Before starting Self Clean, you must remove the rack guide.

- 1 Open the oven door.
- 2 Release 2 ea screws counterclockwise as shown in the image.



CAUTION

- Do not leave small children unattended near the appliance. During the Self Clean cycle, the outside of the range can become very hot to the touch.
- If you have pet birds, move them to another well-ventilated room. The health of some birds is extremely sensitive to the fumes given off during the Self Clean cycle of any range.
- Do not line the oven walls, racks, bottom or any other part of the range with aluminum foil or any other material. Doing so will destroy heat distribution, produce poor baking results and cause permanent damage to the oven interior (aluminum foil will melt to the interior surface of the oven).
- Do not force the door open. This can damage the automatic door locking system. Use care when opening the oven door after the Self Clean cycle. Stand to the side of the oven when opening the door to allow hot air or steam to escape. The oven may still be VERY HOT.

NOTE

- Remove oven racks and accessories before starting the Self Clean cycle. Remove rack guides from the oven. See "Removing Rack Guides."
- If oven racks are left in the oven cavity during the Self Clean cycle, they will discolor and become difficult to slide in and out.
- Clean the frame of the oven and door with hot soapy water. Rinse well.
- Do not clean the gasket. The fiberglass material of the oven door gasket cannot withstand abrasion. It is essential for the gasket to remain intact. If you notice it becoming worn or frayed, have it replaced.
- Wipe up any heavy spillovers on the oven bottom.
- Make sure that the oven LED cover is in place and the oven LED is off.
- It is normal for the fan to operate during the Self Clean cycle.

Setting Self Clean

The Self Clean function has cycle times of 3, 4 or 5 hours.

- If the self-cleaning cycle is running in the right oven, the left oven and the griddle, induction cooktop, and sous vide module cannot be used.
- The left oven does not have a self-clean function.

Self Clean Soil Guide

Soil Level	Cycle Setting
Lightly Soiled Oven Cavity	3-Hour Self Clean
Moderately Soiled Oven Cavity	4-Hour Self Clean
Heavily Soiled Oven Cavity	5-Hour Self Clean

- 1 Touch Right Oven, Clean and Self Clean in that order.
 - 2 Select the desired cycle time.
 - 3 If desired, scroll to set a delayed start time or touch the number pad icon  to enter the start time directly.
 - 4 Touch Start. The remaining time or the delayed start time appears in the display.
 - 5 Once the self-clean cycle is set, the oven door locks automatically and the lock icon displays. You will not be able to open the oven door until the oven has cooled. The lock releases automatically when the oven has cooled.
- The left oven cannot be used while a self-clean cycle is running in the right oven.

CAUTION

Do not force the oven door open when the lock icon is displayed. The oven door remains locked until the oven temperature has cooled. Forcing the door open will damage the door.

NOTE

It may become necessary to cancel or interrupt a Self Clean cycle due to excessive smoke or fire in the oven. To cancel the Self Clean function, touch the **STOP** or **POWER** button at the left side of the display.

During Self Clean

- The Self Clean cycle uses extremely hot temperatures to clean the oven cavity. While running the Self Clean cycle, you may notice smoking or an odor. This is normal, especially if the oven is heavily soiled.
- As the oven heats, you may hear sounds of metal parts expanding and contracting. This is normal and will not damage the oven.
- Do not force the oven door open when the lock  is displayed. The oven door remains locked until the oven temperature has cooled. Forcing the door open will damage the door.

After the Self Clean Cycle

- The oven door remains locked until the oven temperature has cooled.
- You may notice some white ash in the oven. Wipe it off with a damp cloth or a soap-filled steel wool pad after the oven cools. If the oven is not clean after one self-clean cycle, repeat the cycle.
- If oven racks were left in the oven and do not slide smoothly after a self-clean cycle, wipe racks and rack supports with a small amount of vegetable oil to make them glide more easily.
- Fine lines may appear in the porcelain because it went through heating and cooling. This is normal and will not affect performance.

NOTE

- The Self Clean cycle cannot be started if the Lockout feature is active.
- Once the Self Clean cycle is set, the oven door locks automatically. You will not be able to open the oven door until the oven has cooled. The lock releases automatically.
- Once the door has been locked, the lock  indicator light stops flashing and remains on. Allow about 15 seconds for the oven door lock to activate.
- If the clock is set for a 12-hour display (default) the Delayed Self Clean can never be set to start more than 12 hours in advance.
- After the oven is turned off, the convection fan keeps operating until the oven has cooled down.

Oven Air Vents

Air openings are located at the rear of the cooktop, at the top of the oven door, at the front of oven cavity and at the bottom of the range.

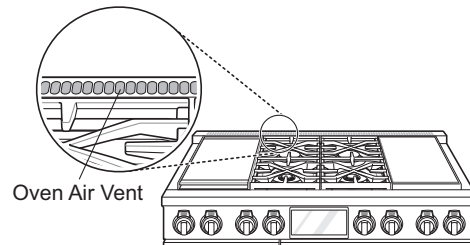

CAUTION

- **The edges of the range vent are sharp.** Wear gloves when cleaning the range to avoid injury.
- Clean ventilating hoods frequently. Grease should not be allowed to accumulate on the hood or filter.

NOTE

Do not block the vents and air openings of the range. They provide the air inlet and outlet that are necessary for the range to operate properly with correct combustion.

Steam Feeder Tank

The steam feeder tank is used during the steam cooking functions. Use filtered, softened water if possible.

NOTE

- After using the steam function, the steam feeder tank should be drained. To avoid bacteria or odors, clean and dry the steam feeder tank after every use.
- Do not clean in a dishwasher.

Hard Water Scale

If hard water is used in the steam feeder tank, the steam generator may become clogged with hard water scale. In areas with hard water, run the Descaling function frequently or use softened water.

Descaling

Use this function to remove the white deposits that form after the steam generator is used for a long period.

The Descaling function runs for 65 minutes. Water will come out of the steam generator while it is being cleaned.

For instructions on removing and filling the steam feeder tank, see "Using the Steam Feeder Tank."

Setting Descaling

- 1 Fill the steam feeder tank with a 20:1 mixture of water and citric acid. For example, use 4 tsp of citric acid in 4 $\frac{1}{4}$ cups water (20 g citric acid in 1000 ml water).
- 2 Insert the steam feeder tank into the slot over the left oven cavity and push it in until it clicks into place.
- 3 Touch Left Oven, Clean, Steam Maintenance and Descaling in that order.
- 4 After 10 minutes of descaling, a popup will appear in the display. Following the instructions, drain the tank and fill it with clean water.
- 5 Insert the tank and start the Rinsing function.
- 6 Once the Rinsing function is complete, dry the inside of the oven with a soft cloth.

Drying

The Drying function removes residual water inside the steam generator. The function takes a little over 1 minute and runs automatically after any steam cooking cycle. The Drying function can also be started manually, if needed.

Setting Drying

- 1 Check whether there is water in the steam feeder tank.
- 2 Touch Left Oven, Clean, Steam Maintenance and Drying in that order.
- 3 Touch **Start** to begin Drying. The remaining time appears in the display.

Evaporation

Use the Evaporation function to dry the oven cavity after a steam cooking cycle. Evaporation runs for 12 minutes.

Setting Evaporation

- 1 Touch Left Oven, Clean, Steam Maintenance and Evaporation in that order.
- 2 Touch **Start** to begin Evaporation. The remaining time appears in the display.

Removing and Replacing the Lift-Off Oven Doors

CAUTION

- Be careful when removing and lifting the door.
- Do not lift the door by the handle. The handle is not designed to support the weight of the door and could break.

Removing the Door

- 1 Fully open the door.
- 2 Unlock the hinge on both sides, rotating them as far toward the open door frame as they will go.

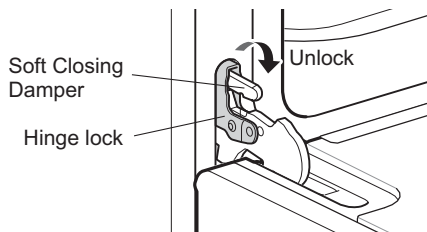

- 3 Firmly grasp both sides of the door at the top.
- 4 Close the door to the removal position (approximately 30 degrees) which is halfway between the broil stop position and fully closed. If the position is correct, the hinge cams will move freely.

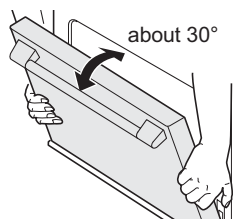

- 5 Lift door up and out until the hinge cams are clear of the slots.

Replacing the Door

- 1 Firmly grasp both sides of the door at the top.
- 2 With the door at the same angle as the removal position, seat the indentation of the hinge cams into the bottom edge of the hinge slots. The notch in the hinge cams must be fully seated into the bottom edge of the slots.

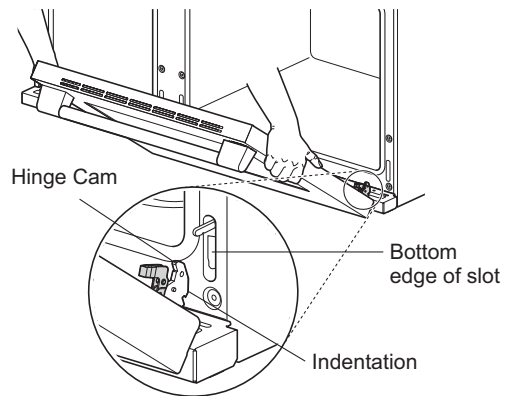

- 3 Open the door fully. If the door will not open fully, the indentation is not seated correctly in the bottom edge of the slots.
- 4 Lock the hinges on either side of the door, rotating them back toward the slots in the oven frame until they lock.

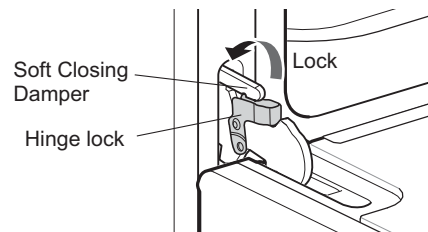

- 5 Close the oven door.

Door Care Instructions

Most oven doors contain glass that can break.

CAUTION

- Do not close the oven door until all the oven racks are fully in place.
- Do not hit the glass with pots, pans, or any other object.
- Scratching, hitting, jarring, or stressing the glass may weaken its structure causing an increased risk of breakage at a later time.

TROUBLESHOOTING

FAQs

What types of cookware are recommended for use with the induction cooktop?

- The pans must have a flat bottom and straight sides.
- Only use heavy-gauge pans.
- The pan size must match the amount of food to be prepared and the size of the surface element.
- Use tight fitting lids.
- Only use flat-bottom woks or 12" to 14" round-bottom woks when using a SIGNATURE KITCHEN SUITE supplied wok grate.

Why do the heating elements appear to be turning ON and OFF during use of the cooktop or oven?

Depending on your cooktop element setting or the temperature selected in your oven, it is NORMAL for the cooking elements to cycle on and off.

My new oven doesn't cook like my old one. Is there something wrong with the temperature settings?

No, your oven has been factory tested and calibrated. For the first few uses, follow your recipe times and temperatures carefully. If you still think your new oven is too hot or too cold, you can adjust the oven temperature yourself to meet your specific cooking needs. Refer to the Thermostat Adjustment section in this manual for easy instructions on how to adjust your thermostat.

Is it normal to hear a clicking noise coming from the back of my oven when I am using it?

Your new range is designed to maintain a tighter control over your oven's temperature. You may hear your oven's heating elements click on and off more frequently on your new oven. This is NORMAL.

During convection cooking the fan stops when I open the door. Is that normal?

Yes, this is normal. When the door is opened, the convection fan will stop until the door is closed.

Can I use aluminum foil to catch drippings in my oven cavity?

Never use aluminum foil to line the bottom or sides of the oven. The foil will melt and stick to the bottom surface of the oven and will not be removable. Use a sheet pan placed on a lower oven rack to catch drippings instead. (If foil has already melted onto the bottom of the oven, it will not interfere with the oven's performance.)

Can I use aluminum foil on the racks?

Do not cover racks with aluminum foil. Covering entire racks with foil restricts air flow, leading to poor cooking results. Use a sheet pan lined with foil under fruit pies or other acidic or sugary foods to prevent spillovers from damaging the oven finish.



CAUTION

Foil may be used to wrap food in the oven, but do not allow the foil to come into contact with the exposed broiling elements in the oven. The foil could melt or ignite, causing smoke, fire, or injury.

Can I leave my racks and rack guides in the oven when running a Self Clean cycle?

No. Although it will not damage the racks, it will discolor them and may make them hard to slide in and out during use. Remove all items from the oven before starting a Self Clean cycle.

What should I do if my racks are sticky and have become hard to slide in and out?

Over time, the racks may become hard to slide in and out. Apply a small amount of olive oil to the ends of the racks. This will work as a lubricant for easier gliding.

What should I do for hard to remove stains on my induction cooktop?

The induction cooktop should be cleaned after every use to prevent permanent staining. When cooking foods with high sugar content, such as tomato sauce, clean the stain off with a scraper while the cooktop is still warm. Use an oven mitt when scraping to prevent burns. Refer to the MAINTENANCE section of this owner's manual for further induction cooktop.

Why aren't the function buttons working?

Make sure that the range is not in Lock Out mode. The lock  will show in the display if Lock Out is activated. To deactivate Lock Out, tap display to see the unlock popup. Press UNLOCK for 3 seconds to cancel the lockout function. The lock icon will disappear at the upper right in the display.

My range is still dirty after running the SpeedClean™ cycle. What else should I do?

The SpeedClean™ cycle only helps to loosen light soils in your oven range to assist in hand-cleaning of your oven. It does not automatically remove all soils after the cycle. Some scrubbing of your oven range is required after running the SpeedClean™ cycle.

I tried scrubbing my oven after running SpeedClean™, but some soils still remain. What can I do?

The SpeedClean™ feature works best when the soils are fully soaked and submerged in water before running the cycle and during hand-cleaning. If soils are not sufficiently soaked in water, it can negatively affect the cleaning performance. Repeat the SpeedClean™ process using sufficient water.

Sugar-based and certain greasy soils are especially hard to clean. If some stubborn soil remains in the right oven, use the Self Clean feature to thoroughly clean your oven.

Soil on my oven walls is not coming off. How can I get the oven walls clean?

Soil on the side and rear walls of your oven range may be more difficult to fully soak with water. Try repeating the SpeedClean™ process with more than the ¼ cup (2 oz or 60 ml) spray recommended.

Will SpeedClean™ get all of the soil and stains out completely?

It depends on the soil type. Sugar-based and certain grease stains are especially hard to clean. Also, if stains are not sufficiently soaked in water, this can negatively affect cleaning performance.

If stubborn or built-up stains remain in the right oven, use the Self Clean feature. Refer to the Self Clean section of this owner's manual.

Are there any tricks to getting some of the stubborn soil out?

Scraping soil with a plastic scraper before and during hand-cleaning is recommended. Fully saturating soil with water is also recommended.

However, certain types of soil are harder to clean than others. For stubborn soil, the Self Clean cycle is recommended. However, self clean only works in the right oven. Consult the Self Clean section of your owner's manual for details.

Is it safe for my convection fan, broil burner or heater element to get wet during SpeedClean™?

Yes. The convection fan and broiler heater element may get a little wet during cleaning. However, direct spray onto the broil burner and heater elements is not necessary because these are self-cleaning during regular use.

Do I need to use all 1¼ cups (10 oz or 300 ml) of water to SpeedClean™ the right oven?

Yes. It is highly recommended that 1 cup (8 oz or 250 ml) of water be sprayed or poured on the bottom and an additional ¼ cup (2 oz or 60 ml) of water be sprayed on walls and other soiled areas to fully saturate the soils for better cleaning performance.

I see smoke coming out of my oven range's cooktop vents during SpeedClean™. Is this normal?

This is normal. This is not smoke. It is actually water vapor (steam) from the water in the oven cavity. As the oven heats briefly during SpeedClean™, the water in the cavity evaporates and escapes through the oven vents.

How often should I use SpeedClean™?

SpeedClean™ can be performed as often as you wish. SpeedClean™ works best when your oven is LIGHTLY soiled from such things as LIGHT grease splatter and small drops of cheese. Please refer to the SpeedClean™ section in your owner's manual for more information.

What is required for SpeedClean™?

A spray bottle filled with 1¼ cups (10 oz or 300 ml) of water (only for the right oven), a plastic scraper, a non-scratch scrubbing pad and a towel. You should not use abrasive scrubbers such as heavy-duty scouring pads or steel wool.

Can I run the SpeedClean™ cycle on both of my ovens at once?

Yes. You can run the SpeedClean™ cycle on both ovens at the same time. Some oven surfaces will be hot after the cycle completes running. Avoid leaning or resting on the oven door glass while cleaning the oven cavities.



However, when a self-clean cycle is run in the right oven, the SpeedClean™ cycle cannot be run in the left oven.

Before Calling for Service

Before you call for service, review this list. It may save you time and expense. The list includes common occurrences that are not the result of defective workmanship or materials in this appliance.

Symptoms	Possible Causes / Solutions
Range is not level.	<ul style="list-style-type: none"> • Poor installation. Place oven rack in center of oven. Place a level on the oven rack. Adjust leveling legs at base of range until the oven rack is level. • Be sure floor is level and strong and stable enough to adequately support range. • If floor is sagging or sloping, contact a carpenter to correct the situation. • Kitchen cabinet alignment may make range appear unlevel. Be sure cabinets are square and have sufficient room for range clearance.
Cannot move appliance easily. Appliance must be accessible for service.	<ul style="list-style-type: none"> • Cabinets not square or are built in too tightly. Contact builder or installer to make appliance accessible. • Carpet interferes with range. Provide sufficient space so range can be lifted over carpet. • Anti-tip device engaged.
Oven control beeps and displays any F error code.	<ul style="list-style-type: none"> • Electronic control error. Press STOP to clear the display and stop beeping. Reprogram oven. If fault recurs, record fault number. Press STOP and contact a Service agent.
Induction control beeps and LED on knob displays any CF error code.	<ul style="list-style-type: none"> • Electronic control error. Turn the knob to the central OFF position in order to clear the display and stop beeping. Reprogram oven. If fault recurs, record fault number. Turn the knob to the central OFF position and call for service.
Sous-Vide control beeps and LED on knob displays any SF error code.	<ul style="list-style-type: none"> • Electronic control error. Turn the knob to the central OFF position in order to clear the display and stop beeping. Reprogram oven. If fault recurs, record fault number. Turn the knob to the central OFF position and call for service.
Griddle control beeps and LED on knob displays any GF error code.	<ul style="list-style-type: none"> • Electronic control error. Turn the knob to the central OFF position in order to clear the display and stop beeping. Reprogram oven. If fault recurs, record fault number. Turn the knob to the central OFF position and call for service.
Gas cooktop burners do not light or do not burn evenly.	<ul style="list-style-type: none"> • Make sure that the electrical plug is inserted into a live, properly grounded outlet. • Remove the burners and clean them. Check the electrode area for burnt on food or grease. See Cleaning Burner Heads/Caps in the MAINTENANCE section. • Make sure that the burner parts are installed correctly. See Removing and Replacing the Gas Surface Burners in the MAINTENANCE section.
Burner flames are very large or yellow.	<p>If the range is connected to LP gas, contact the technician who installed your range or made the conversion.</p>
Oven will not work	<ul style="list-style-type: none"> • Plug on range is not completely inserted in the electrical outlet. <ul style="list-style-type: none"> - Make sure electrical plug is plugged into a live, properly grounded outlet. • A fuse in your home may be blown or the circuit breaker tripped. <ul style="list-style-type: none"> - Replace the fuse or reset the circuit breaker. • Oven controls improperly set. <ul style="list-style-type: none"> - See the Using the Oven section. • Oven too hot. <ul style="list-style-type: none"> - Allow the oven to cool to below locking temperature.

Symptoms	Possible Causes / Solutions
Steam is exhausted through the oven vent.	<ul style="list-style-type: none"> • Cooking foods with high moisture produces steam. This is normal.
Appliance does not operate.	<ul style="list-style-type: none"> • Make sure cord is plugged correctly into outlet. Check circuit breakers. • Service wiring is not complete. Contact your electrician for assistance. • Power outage. Check house lights to be sure. Call your local electric company for service.
Oven light does not work.	<ul style="list-style-type: none"> • This oven uses LED lighting which must be repaired or replaced by an authorized technician.
Oven smokes excessively during broiling.	<ul style="list-style-type: none"> • Control not set properly. Follow instructions under Setting Oven Controls. • Meat too close to the element. Reposition the rack to provide proper clearance between the meat and the element. Preheat broil element for searing. • Meat not properly prepared. Remove excess fat from meat. Cut remaining fatty edges to prevent curling. • Insert on broiler pan wrong side up and grease not draining. Always place grid on the broiler pan with ribs up and slots down to allow grease to drip into pan. • Grease has built up on oven surfaces. Regular cleaning is necessary when broiling frequently. <ul style="list-style-type: none"> - Old grease or food spatters cause excessive smoking.
Food does not bake or roast properly	<ul style="list-style-type: none"> • Oven controls improperly set. <ul style="list-style-type: none"> - See the Using the Oven section. • Rack position is incorrect or the rack is not level. <ul style="list-style-type: none"> - See the Using the Oven section. • Incorrect cookware or cookware of improper size being used. <ul style="list-style-type: none"> - See the Using the Oven section. • Oven sensor needs to be adjusted. <ul style="list-style-type: none"> - See Thermostat Adjustment in the Features section.
Food does not broil properly	<ul style="list-style-type: none"> • Improper rack position being used. <ul style="list-style-type: none"> - See the Broiling Guide. • Cookware not suited for broiling. <ul style="list-style-type: none"> - Use broiling pan and grid. • Aluminum foil used on the broiling pan and grid has not been fitted properly and slit as recommended. <ul style="list-style-type: none"> - See the Using the Oven section. • In some areas the power voltage may be low. <ul style="list-style-type: none"> - Preheat the broil element for 5-7 minutes. - See the Broiling Guide.
Oven temperature too hot or too cold	<ul style="list-style-type: none"> • Oven sensor needs to be adjusted. <ul style="list-style-type: none"> - See Thermostat Adjustment in the Settings section.

Symptoms	Possible Causes / Solutions
Oven will not Self Clean	<ul style="list-style-type: none"> • The oven temperature is too high to set a Self Clean operation. <ul style="list-style-type: none"> - Allow the range to cool and reset the controls. • Oven controls improperly set. <ul style="list-style-type: none"> - See the Self Clean section. • A Self Clean cycle cannot be started if the oven lockout feature is active. • Self Clean operation is only available on the right oven.
“Crackling” or “popping” sound	<ul style="list-style-type: none"> • This is the sound of the metal heating and cooling during both the cooking and Self Clean functions. <ul style="list-style-type: none"> - This is normal.
Fan noise	<ul style="list-style-type: none"> • A convection fan may automatically turn on and off. <ul style="list-style-type: none"> - This is normal. • The fans that exist to cooling for the range are turned on and off according to the temperature of the range. <ul style="list-style-type: none"> - This is normal.
Convection Fan stops	<ul style="list-style-type: none"> • Convection fan stops according to cook mode. <ul style="list-style-type: none"> - This is normal and is done to allow for more even heating during the cycle. This is not a failure of the range and should be considered normal operation.
Excessive smoking during a Self Clean cycle	<ul style="list-style-type: none"> • Excessive soil. <ul style="list-style-type: none"> - Press the STOP button. Open the windows to rid the room of smoke. Wait until the Self Clean mode is cancelled. Wipe up the excess soil and reset the clean.
Oven door does not open after a Self Clean cycle	<ul style="list-style-type: none"> • Oven is too hot. <ul style="list-style-type: none"> - Allow the oven to cool below locking temperature. • Allow about one hour for the oven to cool after the completion of a Self Clean cycle. The door can be opened when the lock  is no longer displayed. • The control and door may be locked.
The oven is not clean after a Self Clean cycle	<ul style="list-style-type: none"> • Oven controls not properly set. <ul style="list-style-type: none"> - See the Self Clean section. • Oven was heavily soiled. <ul style="list-style-type: none"> - Clean up heavy spillovers before starting the clean cycle. Heavily soiled ovens may need to Self Clean again or for a longer period of time.
Door locked icon  shows in the display when you want to cook	<ul style="list-style-type: none"> • The oven door is locked because the temperature inside the oven has not dropped below the locking temperature. <ul style="list-style-type: none"> - Press the STOP button. Allow the oven to cool.
Burning or oily odor emitting from the vent	<ul style="list-style-type: none"> • This is normal in a new oven and will disappear in time. <ul style="list-style-type: none"> - To speed the process, set a Self Clean cycle for a minimum of 3 hours. See the Self Clean section.
Oven racks are difficult to slide	<ul style="list-style-type: none"> • The shiny, silver-colored racks were cleaned in a Self Clean cycle. <ul style="list-style-type: none"> - Apply a small amount of vegetable oil to a paper towel and wipe the edges of the oven racks with the paper towel.
Moisture collects on oven window or steam comes from oven vent	<ul style="list-style-type: none"> • This is normal when cooking foods in high moisture. • Excessive moisture was used when cleaning the window.

Symptoms	Possible Causes / Solutions
Trouble connecting appliance and smartphone to Wi-Fi network	<ul style="list-style-type: none"> • The password for the Wi-Fi network was entered incorrectly. <ul style="list-style-type: none"> - Delete your home Wi-Fi network and begin the registration process again. • Mobile data for your smartphone is turned on. <ul style="list-style-type: none"> - Turn off the Mobile data on your smartphone before registering the appliance. • The wireless network name (SSID) is set incorrectly. <ul style="list-style-type: none"> - The wireless network name (SSID) should be a combination of English letters and numbers. (Do not use special characters.) • The router frequency is not 2.4 GHz. <ul style="list-style-type: none"> - Only a 2.4 GHz router frequency is supported. Set the wireless router to 2.4 GHz and connect the appliance to the wireless router. To check the router frequency, check with your Internet service provider or the router manufacturer. • The distance between the appliance and the router is too far. <ul style="list-style-type: none"> - If the appliance is too far from the router, the signal may be weak and the connection may not be configured correctly. Move the router closer to the appliance or purchase and install a Wi-Fi repeater.
After the Sous-Vide operation, the product beeps.	<ul style="list-style-type: none"> • It is a sound alert when you are operating the Sous-vide without filling water in the bath. <ul style="list-style-type: none"> - Fill the water in the bath.
The Sous-Vide Module is not performed and "HS" is displayed on the Knob display.	<ul style="list-style-type: none"> • When Oven is in SelfClean operation, Sous-Vide Module is not activated and "HS" is displayed on Knob. <ul style="list-style-type: none"> - After Selfclean, run the Sous-Vide Module.

WARRANTY (USA)

Should your SIGNATURE KITCHEN SUITE Dual Fuel Range fail due to a defect in materials or workmanship under normal home use, during the warranty period set forth below, SIGNATURE KITCHEN SUITE will at its option repair or replace the product. This limited warranty is valid only to the original retail purchaser of the product and applies only when purchased and used within the United States including U.S. Territories. Proof of original retail purchase is required to obtain warranty service under this limited warranty.

Warranty Period	Scope of Warranty	HOW SERVICE IS HANDLED
Three (3) years from date of original retail purchase	Parts and Labor	SIGNATURE KITCHEN SUITE will provide parts and labor to repair or replace defective parts.

- Replacement products and parts are warranted for the remaining portion of the original warranty period or ninety (90) days, whichever is greater.
- Replacement products and parts may be new or remanufactured.

THIS WARRANTY IS IN LIEU OF ANY OTHER WARRANTY, EXPRESS OR IMPLIED, INCLUDING WITHOUT LIMITATION, ANY WARRANTY OF MERCHANTABILITY OR FITNESS FOR A PARTICULAR PURPOSE. TO THE EXTENT ANY IMPLIED WARRANTY IS REQUIRED BY LAW, IT IS LIMITED IN DURATION TO THE EXPRESS WARRANTY PERIOD ABOVE. NEITHER THE MANUFACTURER NOR ITS U.S. DISTRIBUTOR SHALL BE LIABLE FOR ANY INCIDENTAL, CONSEQUENTIAL, INDIRECT, SPECIAL, OR PUNITIVE DAMAGES OF ANY NATURE, INCLUDING WITHOUT LIMITATION, LOST REVENUES OR PROFITS, OR ANY OTHER DAMAGE WHETHER BASED IN CONTRACT, TORT, OR OTHERWISE.



Some states do not allow the exclusion or limitation of incidental or consequential damages or limitations on how long an implied warranty lasts, so the above exclusion or limitation may not apply to you. This warranty gives you specific legal rights and you may also have other rights that vary from state to state.



THIS LIMITED WARRANTY DOES NOT COVER:

- Service trips to deliver, pick up, or install or repair the product; instruction to the customer on operation of the product; repair or replacement of fuses or correction of wiring or plumbing, or correction of unauthorized repairs/installation.
- Failure of the product to perform during power failures and interruptions or inadequate electrical service.
- Damage caused by leaky or broken water pipes, frozen water pipes, restricted drain lines, inadequate or interrupted water supply or inadequate supply of air.
- Damage resulting from operating the Product in a corrosive atmosphere or contrary to the instructions outlined in the Product's owner's manual.
- Damage to the Product caused by accidents, pests and vermin, lightning, wind, fire, floods, or acts of God.
- Damage or failure caused by unauthorized modification or alteration, or if it is used for other than the intended purpose, or any water leakage where the unit was not properly installed.
- Damage or failure caused by incorrect electrical current, voltage, or plumbing codes, commercial or industrial use, or use of accessories, components, or consumable cleaning products that are not approved by SIGNATURE KITCHEN SUITE.
- Damage caused by transportation and handling, including scratches, dents, chips, and/or other damage to the finish of your product, unless such damage results from defects in materials or workmanship and is reported within one (1) week of delivery.
- Damage or missing items to any display, open box, discounted, or refurbished Product.
- Products with original serial numbers that have been removed, altered, or cannot be readily determined. Model and Serial numbers, along with original retail sales receipt, are required for warranty validation.
- Increases in utility costs and additional utility expenses.
- Repairs when your Product is used in other than normal and usual household use (e.g. commercial use, in offices and recreational facilities) or contrary to the instructions outlined in the Product's owner's manual.
- Costs associated with removal of your Product from your home for repairs.

- The removal and reinstallation of the Product if it is installed in an inaccessible location or is not installed in accordance with published installation instructions, including SIGNATURE KITCHEN SUITE'S owner's and installation manuals.
- Damage resulting from misuse, abuse, improper installation, repair, or maintenance. Improper repair includes use of parts not approved or specified by SIGNATURE KITCHEN SUITE'S.

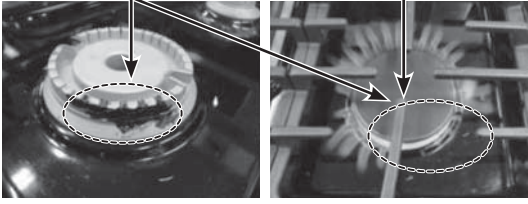
The following circumstances are not covered under the warranty:

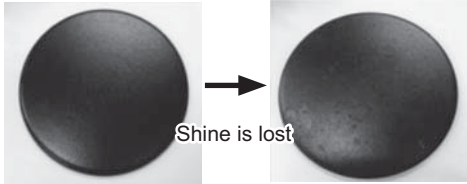
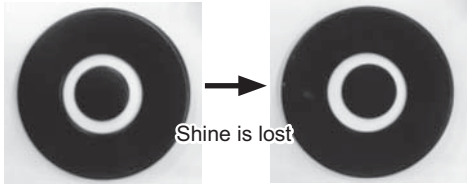
Problem	Cause	Prevention
<ul style="list-style-type: none"> • Burners do not light 	<p>Clogged or dirty burner ports or electrodes will not allow the burner to operate properly</p> <p>15 k Burner Cap</p>  <p>23 k Burner Cap</p> 	<ul style="list-style-type: none"> • Check and clean the gas electrode.
<ul style="list-style-type: none"> • Uneven flame 	<p>1. Improper burner cap installation</p> <p>Burner cap is properly seated. Burner cap is NOT properly seated.</p>  <p>2. Burner ports clogged by food residue</p> <p>Ports blocked by dirt Flames uneven</p> 	<ul style="list-style-type: none"> • Check installation of burner head and cap • Hardened residue should be removed using a toothbrush.

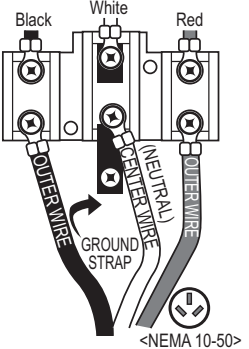
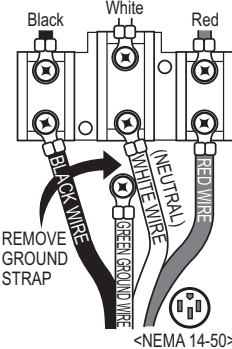
Problem	Cause	Prevention
<ul style="list-style-type: none"> • Burner cap is dull or has changed color 	<ol style="list-style-type: none"> 1. Scratching 2. Use of detergent or abrasive cleansers <p>15 k Burner Cap</p>  <p>23 k Burner Cap</p> 	<ul style="list-style-type: none"> • Do not use steel wool or abrasive cleansers to clean. • To remove burnt-on food, soak the burner heads in hot water for 20–30 minutes. (Do not use detergent)
<ul style="list-style-type: none"> • Oven or racks are stained after using aluminum foil 	<p>Aluminum foil has melted in the oven</p> 	<ul style="list-style-type: none"> • Never cover the oven bottom or cover an entire rack with materials such as aluminum foil. • If the foil has already melted onto the oven, it will not affect the performance of the oven.
<ul style="list-style-type: none"> • Unit has no power 	<ol style="list-style-type: none"> 1. House power turned off (power supply) 2. Tripped breaker 3. The power cord is not installed properly. <p>3-WIRE HOOK UP</p>  <p>4-WIRE HOOK UP</p> 	<ul style="list-style-type: none"> • Check power at main board before calling for service. • Match power cord type and outlet type • Properly install the power cord

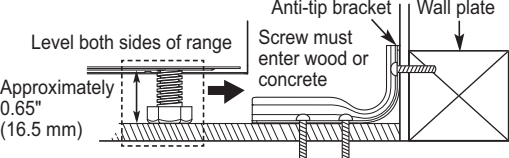
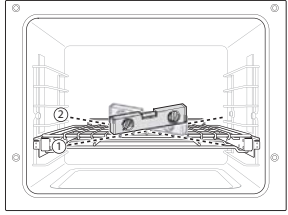
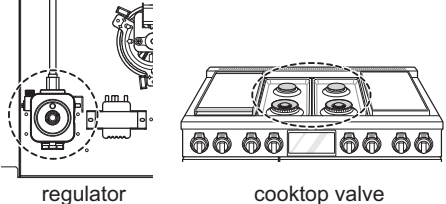
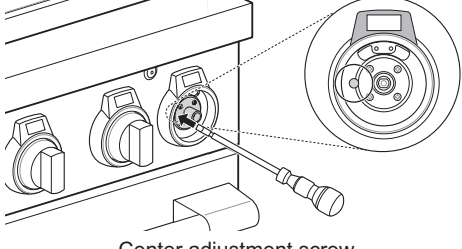
Problem	Cause	Prevention
<ul style="list-style-type: none"> • Surface is not level • Oven is tipping 	<ol style="list-style-type: none"> 1. Range not leveled 2. Anti-tip device not installed correctly   <p>Use carpenter's level to check level.</p>	<ul style="list-style-type: none"> • Check with installer first
<ul style="list-style-type: none"> • Flames too big on converted cooktop (NP → LP) 	<p>The installer missed part of the conversion. (Check 2 parts: regulator, cooktop valve).</p>  <p>regulator cooktop valve</p>	<ul style="list-style-type: none"> • Check with installer first • Refer to installation manual
<ul style="list-style-type: none"> • Flame is too small or too large 	<ol style="list-style-type: none"> 1. Variable gas pressure 2. Installer did not check  <p>Center adjustment screw</p>	<ul style="list-style-type: none"> • Check with installer first

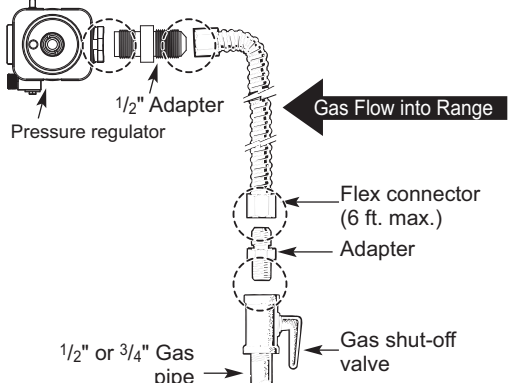
Problem	Cause	Prevention
<ul style="list-style-type: none"> Gas smell 	<p>Improper connection</p> <p>Flexible Connector Hookup</p>  <p>Labels in diagram: Pressure regulator 1/2" Adapter Gas Flow into Range Flex connector (6 ft. max.) Adapter Gas shut-off valve 1/2" or 3/4" Gas pipe</p>	<ul style="list-style-type: none"> Check with installer first

The cost of repair or replacement under these excluded circumstances shall be borne by the consumer.

OBTAIN WARRANTY SERVICE AND ADDITIONAL INFORMATION

If you do not have access to the internet and you need assistance using your product or you would like to schedule service, you may contact SIGNATURE KITCHEN SUITE at the number below.

For assistance or service, call 1-855-790-6655.

If you need further assistance, you can write to SIGNATURE KITCHEN SUITE with any questions or concerns at the address below:

SIGNATURE KITCHEN SUITE, 201 James Record Road, Huntsville, Alabama 35813

For additional product information, visit our website at www.thesignaturekitchen.com