



LG

Life's Good

OWNER'S MANUAL

LED LCD TV / LCD TV

Please read this manual carefully before operating your set and retain it for future reference.

LED LCD TV MODELS

19LE5300	32LE5300	42LE7300
22LE5300	37LE5300	47LE7300
26LE5300	42LE5300	55LE7300
22LE5500	47LE5300	
26LE5500	55LE5300	

LCD TV MODELS

32LD420	37LD450C	42LD630
42LD420	42LD450C	47LD630
47LD420	47LD450C	55LD630
32LD450	32LD520	
37LD450	42LD520	
42LD450	47LD520	
47LD450	55LD520	

WARNING / CAUTION



WARNING / CAUTION
RISK OF ELECTRIC SHOCK
DO NOT OPEN



TO REDUCE THE RISK OF ELECTRIC SHOCK DO NOT REMOVE COVER (OR BACK). NO USER SERVICEABLE PARTS INSIDE. REFER TO QUALIFIED SERVICE PERSONNEL.

 The lightning flash with arrowhead symbol, within an equilateral triangle, is intended to alert the user to the presence of uninsulated "dangerous voltage" within the product's enclosure that may be of sufficient magnitude to constitute a risk of electric shock to persons.

 The exclamation point within an equilateral triangle is intended to alert the user to the presence of important operating and maintenance (servicing) instructions in the literature accompanying the appliance.

WARNING/CAUTION

TO REDUCE THE RISK OF FIRE AND ELECTRIC SHOCK, DO NOT EXPOSE THIS PRODUCT TO RAIN OR MOISTURE.

NOTE TO CABLE/TV INSTALLER

This reminder is provided to call the CATV system installer's attention to Article 820-40 of the National Electric Code (U.S.A.). The code provides guidelines for proper grounding and, in particular, specifies that the cable ground shall be connected to the grounding system of the building, as close to the point of the cable entry as practical.

WARNING / CAUTION

To prevent fire or shock hazards, do not expose this product to rain or moisture.

FCC Notice

Class B digital device

This equipment has been tested and found to comply with the limits for a Class B digital device, pursuant to Part 15 of the FCC Rules. These limits are designed to provide reasonable protection against harmful interference in a residential installation. This equipment generates, uses and can radiate radio frequency energy and, if not installed and used in accordance with the instructions, may cause harmful interference to radio communications. However, there is no guarantee that interference will not occur in a particular installation. If this equipment does cause harmful interference to radio or television reception, which can be determined by turning the equipment off and on, the user is encouraged to try to correct the interference by one or more of the following measures:

- Reorient or relocate the receiving antenna.
- Increase the separation between the equipment and receiver.
- Connect the equipment to an outlet on a circuit different from that to which the receiver is connected.
- Consult the dealer or an experienced radio/TV technician for help.

This device complies with part 15 of the FCC Rules.

Operation is subject to the following two conditions: (1) This device may not cause (harmful) interference, and (2) this device must accept any interference received, including interference that may cause undesired operation (of the device).

Any changes or modifications in construction of this device which are not expressly approved by the party responsible for compliance could void the user's authority to operate the equipment.

CAUTION

Do not attempt to modify this product in any way without written authorization from LG Electronics.

Unauthorized modification could void the user's authority to operate this product.

SAFETY INSTRUCTIONS

IMPORTANT SAFETY INSTRUCTIONS

Read these instructions.
Keep these instructions.
Heed all warnings.
Follow all instructions.

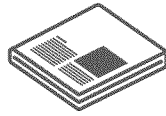

- 1** Do not use this apparatus near water.

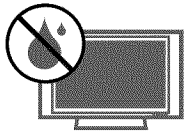

- 2** Clean only with dry cloth.



- 3** Do not block any ventilation openings. Install in accordance with the manufacturer's instructions.

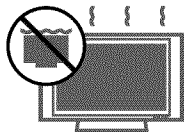

- 4** Do not install near any heat sources such as radiators, heat registers, stoves, or other apparatus (including amplifiers) that produce heat.

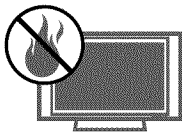

- 5** Do not defeat the safety purpose of the polarized or grounding-type plug. A polarized plug has two blades with one wider than the other. A grounding type plug has two blades and a third grounding prong. The wide blade or the third prong are provided for your safety. If the provided plug does not fit into your outlet, consult an electrician for replacement of the obsolete outlet.

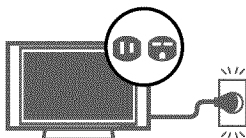

- 6** Protect the power cord from being walked on or pinched particularly at plugs, convenience receptacles, and the point where they exit from the apparatus.

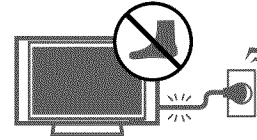

- 7** Only use attachments/accessories specified by the manufacturer.

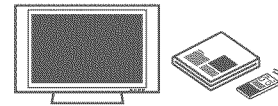

- 8** Use only with the cart, stand, tripod, bracket, or table specified by the manufacturer, or sold with the apparatus. When a cart is used, use caution when moving the cart/apparatus combination to avoid injury from tip-over.



S3125A

- 9** Unplug this apparatus during lightning storms or when unused for long periods of time.

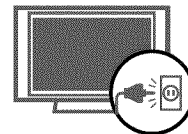

- 10** Refer all servicing to qualified service personnel. Servicing is required when the apparatus has been damaged in any way, such as power-supply cord or plug is damaged, liquid has been spilled or objects have fallen into the apparatus, the apparatus has been exposed to rain or moisture, does not operate normally, or has been dropped.

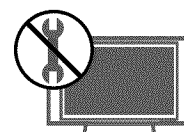

SAFETY INSTRUCTIONS

- 11 Never touch this apparatus or antenna during a thunder or lightning storm.
- 12 When mounting a TV on the wall, make sure not to install the TV by the hanging power and signal cables on the back of the TV.
- 13 Do not allow an impact shock or any objects to fall into the product, and do not drop onto the screen with something.

14 **CAUTION** concerning the Power Cord:
It is recommend that appliances be placed upon a dedicated circuit; that is, a single outlet circuit which powers only that appliance and has no additional outlets or branch circuits. Check the specification page of this owner's manual to be certain.

Do not connect too many appliances to the same AC power outlet as this could result in fire or electric shock.

Do not overload wall outlets. Overloaded wall outlets, loose or damaged wall outlets, extension cords, frayed power cords, or damaged or cracked wire insulation are dangerous. Any of these conditions could result in electric shock or fire. Periodically examine the cord of your appliance, and if its appearance indicates damage or deterioration, unplug it, discontinue use of the appliance, and have the cord replaced with an exact replacement part by an authorized servicer. Protect the power cord from physical or mechanical abuse, such as being twisted, kinked, pinched, closed in a door, or walked upon. Pay particular attention to plugs, wall outlets, and the point where the cord exits the appliance.

Do not use a damaged or loose power cord. Do not pull on the power cord to unplug the TV. Grasp the plug when unplugging the power cord.

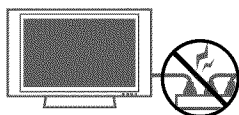

- 15 **WARNING** - To reduce the risk of fire or electrical shock, do not expose this product to rain, moisture or other liquids. Do not touch the TV with wet hands. Do not install this product near flammable objects such as gasoline or candles or expose the TV to direct air conditioning.

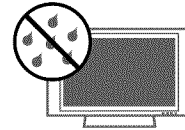

- 16 Do not expose to dripping or splashing and do not place objects filled with liquids, such as vases, cups, etc. on or over the apparatus (e.g. on shelves above the unit).

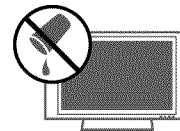

17 GROUNDING

Ensure that you connect the earth ground wire to prevent possible electric shock (i.e. a TV with a three-prong grounded AC plug must be connected to a three-prong grounded AC outlet). If grounding methods are not possible, have a qualified electrician install a separate circuit breaker.

Do not try to ground the unit by connecting it to telephone wires, lightening rods, or gas pipes.

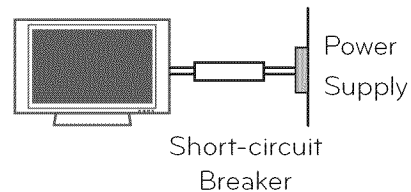

18 DISCONNECTING DEVICE FROM MAINS

Mains plug is the disconnecting device. The plug must remain readily operable.

- 19 As long as this unit is connected to the AC wall outlet, it is not disconnected from AC power even if you turn off the power switch on the unit.

20 ANTENNAS

Outdoor antenna grounding

If an outdoor antenna is installed, follow the precautions below. An outdoor antenna system should not be located in the vicinity of overhead power lines or other electric light or power circuits, or where it can come in contact with such power lines or circuits as death or serious injury can occur.

Be sure the antenna system is grounded so as to provide some protection against voltage surges and built-up static charges.

Section 810 of the National Electrical Code (NEC) in the U.S.A. provides information with respect to proper grounding of the mast and supporting structure, grounding of the lead-in wire to an antenna discharge unit, size of grounding conductors, location of antenna discharge unit, connection to grounding electrodes and requirements for the grounding electrode.

Antenna grounding according to the National Electrical Code, ANSI/NFPA 70

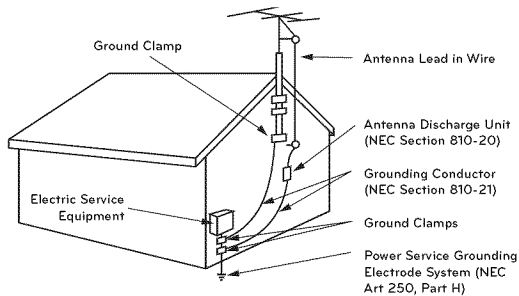

NEC: National Electrical Code

21 Cleaning

When cleaning, unplug the power cord and rub gently with a soft cloth to prevent scratching. Do not spray water or other liquids directly on the TV as electric shock may occur. Do not clean with chemicals such as alcohol, thinners or benzene.

22 Moving

Make sure the product is turned off, unplugged and all cables have been removed. It may take 2 or more people to carry larger TVs. Do not press against or put stress on the front panel of the TV.

23 Ventilation

Install your TV where there is proper ventilation. Do not install in a confined space such as a bookcase. Do not cover the product with cloth or other materials (e.g.) plastic while plugged in. Do not install in excessively dusty places.

24 Take care not to touch the ventilation openings. When watching the TV for a long period, the ventilation openings may become hot.

25 If you smell smoke or other odors coming from the TV or hear strange sounds, unplug the power cord contact an authorized service center.

26 Do not press strongly upon the panel with hand or sharp object such as nail, pencil or pen, or make a scratch on it.

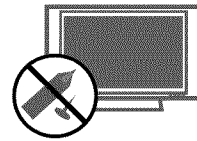

27 Keep the product away from direct sunlight.

28 If the TV feels cold to the touch, there may be a small "flicker" when it is turned on. This is normal, there is nothing wrong with TV.

Some minute dot defects may be visible on the screen, appearing as tiny red, green, or blue spots. However, they have no adverse effect on the monitor's performance.

Avoid touching the LCD screen or holding your finger(s) against it for long periods of time. Doing so may produce some temporary distortion effects on the screen.

ON DISPOSAL (Only Hg lamp used LCD TV)

The fluorescent lamp used in this product contains a small amount of mercury. Do not dispose of this product with general household waste. Disposal of this product must be carried out in accordance to the regulations of your local authority.

CONTENTS

WARNING / CAUTION	2
SAFETY INSTRUCTIONS	
Important Safety Instructions	3
FEATURE OF THIS TV	8

PREPARATION

Accessories	9
Front Panel Information	11
Back Panel Information	16
Stand Instructions	20
VESA wall mounting	28
Cable Management	30
Desktop Pedestal Installation	32
Swivel Stand	32
Kensington Security System	32
Attaching the TV to a Desk	33
Securing the TV to the Wall to Prevent Falling when the TV is used on a stand	34
Antenna or Cable Connection	35

EXTERNAL EQUIPMENT SETUP

HD Receiver setup	36
DVD setup	39
VCR SETUP	41
Other A/V Source Setup	42
USB Connection	43
Headphone Setup	43
Audio out Connection	44
PC Setup	45

WATCHING TV / CHANNEL CONTROL

Remote Control Functions	52
Turning on the TV	54
Channel Selection	54
Volume Adjustment	54
Initial Setting	55
On-Screen Menus Selection	57
Quick menu	59

Customer Support	
- Picture Test / Sound Test	60
- Product/Service Info	61
Simple Manual	62
Channel Setup	
- Auto Scan (Auto Tuning)	63
- Add/Delete Channel (Manual Tuning)	64
- Channel Editing	65
Favorite Channel Setup	66
Favorite Channel List	66
Channel List	67
Channel Information	68
Channel Brief Information	69
Input List	70
Input Label	71
Reset to factory default (Initial Setting)	72
Mode Setting	73
Demo Mode	74
AV Mode	75
SIMPLINK	76

MY MEDIA

Connection Method	78
Entry Mode	79
Movie List	80
Photo List	87
Music List	93
DivX Registration Code	98
Deactivation	99

PICTURE CONTROL

Picture Size (Aspect Ratio) Control	100
Picture Wizard	102
 Energy Saving	104
Preset Picture Settings (Picture mode)	105
Manual Picture Adjustment - User Mode	106
Picture Improvement Technology (Advanced Control)	107
Expert Picture Control	108
Picture Reset	111
Power Indicator	111
TruMotion	112

SOUND & LANGUAGE CONTROL

Auto Volume.....	113
Clear Voice II	114
Balance	115
Preset Sound Settings (Sound Mode)	116
Sound Setting Adjustment - User Mode...	117
Audio Reset.....	118
TV Speakers On/Off Setup	119
External Speakers On/Off Setup	119
Stereo/SAP Broadcast Setup	120
Audio Language	121
On-screen Menus Language Selection....	122
Caption Mode	
- Analog Broadcasting System Captions.	123
- Digital Broadcasting System Captions...	124
- Caption Option.....	125

TIME SETTING

Clock Setting	
- Auto Clock Setup	126
- Manual Clock Setup	127
Auto On/Off Time Setting	128
Sleep Timer Setting	129

PARENTAL CONTROL / RATINGS

Set Password & Lock System	
- Setting up Your Password	130
- Set Password	131
- Lock System.....	132
Channel Blocking.....	133
Movie & TV Rating	134
Downloadable Rating.....	139
External Input Blocking	140
Key Lock	141

APPENDIX

Troubleshooting	142
Maintenance	145
Product Specifications	146
IR Code.....	151
External Control through RS-232C	152
Open Source License.....	158

FEATURE OF THIS TV

■ Some of these features are not available on all models.



High-definition television. High-resolution digital television broadcast and playback system composed of roughly a million or more pixels, 16:9 aspect-ratio screens, and AC3 digital audio. A subset of digital television, HDTV formats include 1080i and 720p resolutions.



AV Mode is three preset picture and audio settings. It allows the viewer to quickly switch between common settings. It includes Cinema, Sports, and Game Modes.



A unique invisible speaker system tuned by renowned audio expert, Mr. Mark Levinson. Speakers are embedded in strategic spots behind the front cabinet and use minute vibrations to turn the entire front bezel into the speaker system. The result is a clean, polished look, and enhanced audio by increasing the "sweet spot", giving a wider and richer sound field.



Automatically enhances and amplifies the sound of human voice frequency range to help keep dialogue audible when background noise swells.



Unlike other sensors which can only sense brightness of ambient light, LG's "Intelligent Sensor" uses 4,096 sensing steps to evaluate its surroundings. Using a sophisticated algorithm, the LG processes picture quality elements including brightness, contrast, color, sharpness and white balance. The result is a picture optimized for its surroundings, more pleasing to watch and which can also save up to 50% in power consumption.



Manufactured under license from Dolby Laboratories. "Dolby" and the double-D symbol are trademarks of Dolby Laboratories.



HDMI, the HDMI logo and High-Definition Multimedia Interface are trademarks or registered trademarks of HDMI Licensing LLC."



Displays HDTV programs in full 1920 x 1080p resolution for a more detailed picture.



View videos and photos and listen to music on your TV through USB 2.0 ('videos' dependent on model).



ABOUT DIVX VIDEO: DivX® is a digital video format created by DivX, Inc. This is an official DivX Certified device that plays DivX video. Visit www.divx.com for more information and software tools to convert your files into DivX video.

ABOUT DIVX VIDEO-ON-DEMAND: This DivX Certified® device must be registered in order to play DivX Video-on-Demand (VOD) content. To generate the registration code, locate the DivX VOD section in the device setup menu. Go to vod.divx.com with this code to complete the registration process and learn more about DivX VOD.

"DivX Certified to play DivX video up to HD 1080p, including premium content"

"Pat. 7,295,673; 7,460,688; 7,519,274"



IMPORTANT INFORMATION TO PREVENT "IMAGE BURN / BURN-IN" ON YOUR TV SCREEN

- When a fixed image (e.g. logos, screen menus, video game, and computer display) is displayed on the TV for an extended period, it can become permanently imprinted on the screen. This phenomenon is known as "image burn" or "burn-in." Image burn is not covered under the manufacturer's warranty.
- In order to prevent image burn, avoid displaying a fixed image on your TV screen for a prolonged period (2 or more hours for LCD, 1 or more hours for Plasma).
- Image burn can also occur on the letter-boxed areas of your TV if you use the 4:3 aspect ratio setting for an extended period.

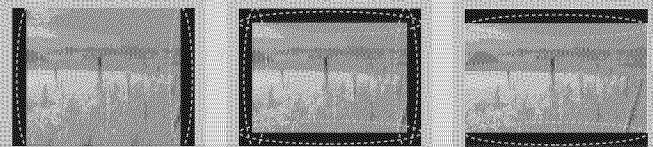

PREPARATION

ACCESSORIES

Ensure that the following accessories are included with your TV. If an accessory is missing, please contact the dealer where you purchased the TV.

The accessories included may differ from the images below.

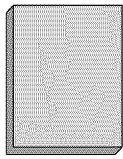

Owner's Manual

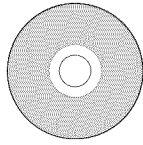

CD Manual

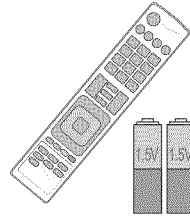

Remote Control,
Batteries (AAA)

Not included with all models

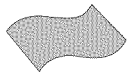

Polishing Cloth

- * Wipe spots on the exterior only with the polishing cloth.
- * Do not wipe roughly when removing stains. Excessive pressure may cause scratches or discoloration.

Option Extras

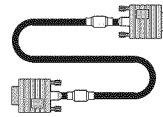

D-sub 15 pin Cable

When using the VGA (D-sub 15 pin cable) PC connection, the user must use shielded signal interface cables with ferrite cores to maintain standards compliance.

19/22/26LE5300, 22/26LE5500

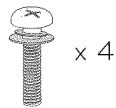

(M4 x 14)

Screws for stand assembly
(Refer to P.20, 22)

(For 26LE5300,
26LE5500)

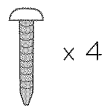

(M4 x 20)



Cable Holder
(Refer to p.31)

(For 26LE5300,
26LE5500)



x 4

Ring spacers
(Refer to p.29)

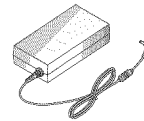

AC/DC Adapter

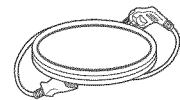

Power Cord

32/37/42/47LD450, 37/42/47LD450C, 42/47/55LD630

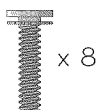

(M4 x 20)

Screws for stand assembly
(Refer to P.24)

(For 32/37/42LD450,
37/42LD450C, 42LD630)



Screw for stand fixing
(Refer to P.33)



Protection Cover
(Refer to P.25)

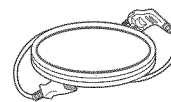

Power Cord

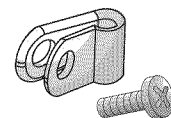



Protective Bracket
and Screw for
Power Cord
(Refer to P.30)

PREPARATION



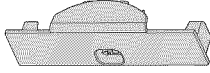
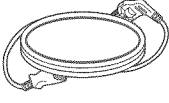

PREPARATION





32/42/47LD420, 32/42/47/55LD520



<p>(Except 55LD520)</p>  <p>x 4</p> <p>(M4 x 24)</p>	<p>(Except 47LD420, 47/55LD520)</p> 		
<p>Screws for stand assembly (Refer to P.26)</p>	<p>Screw for stand fixing (Refer to P.33)</p>	<p>Protection Cover (Refer to P.27)</p>	<p>Power Cord</p>

32/37/42/47/55LE5300, 42/47/55LE7300

(32/37/42/47/55LE5300)

<p>(32LE5300)</p>  <p>x 4</p> <p>(M4 x 22)</p>	<p>(37/42LE5300)</p>  <p>x 4</p> <p>(M4 x 24)</p>	<p>(47/55LE5300)</p>  <p>x 4</p> <p>(M4 x 26)</p>	 <p>x 4</p> <p>(M4 x 16)</p>
<p>Screws for stand assembly (Refer to P.22)</p>			

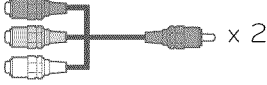
<p>(42/47LE7300)</p>  <p>x 3</p> <p>(M4 x 20)</p>	 <p>x 4</p> <p>(M4 x 12)</p>	<p>(55LE7300)</p>  <p>x 3</p> <p>(M4 x 26)</p>	 <p>x 4</p> <p>(M4 x 16)</p>
<p>Screws for stand assembly (Refer to P.21)</p>			

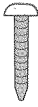
 <p>Cable Holder (Refer to p.31)</p>	 <p>Component gender cable, AV gender cable</p>	<p>(For 42/47/55LE7300)</p>  <p>Cable Management Clip (Refer to p.31)</p>	<p>(For 32LE5300)</p>  <p>Screw for stand fixing (Refer to P.33)</p>
---	--	--	---

FRONT PANEL INFORMATION

■ Image shown may differ from your TV.

19/22/26/32/37/42/47/55LE5300,
22/26LE5500

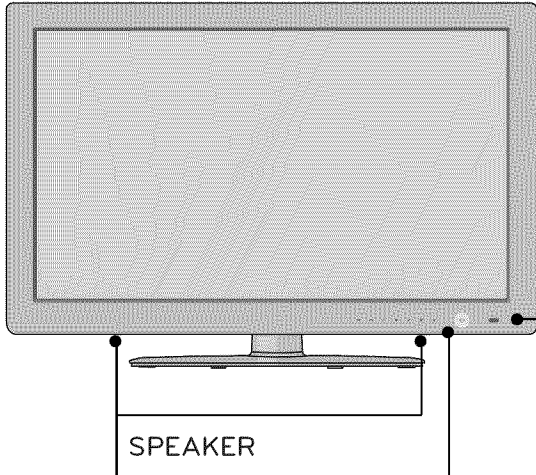

19/22/26LE5300, 22/26LE5500

Remote Control Sensor

Power/Standby Indicator
(Can be adjusted using the **Power Indicator** in the OPTION menu. ▶ p.111)

32/37/42/47/55LE5300

Remote Control Sensor

Intelligent Sensor
Adjusts picture according to the surrounding conditions

Power/Standby Indicator
(Can be adjusted using the **Power Indicator** in the OPTION menu. ▶ p.111)

19/22/26LE5300, 22/26LE5500

CH	VOL	ENTER	MENU	INPUT	POWER
↓ ↑	- +	✓	M	↘	⏻
CHANNEL (↓, ↑) Buttons	VOLUME (-, +) Buttons	ENTER Button	MENU Button	INPUT Button	POWER Button

32/37/42/47/55LE5300

CH	VOL	ENTER	MENU	INPUT	POWER
↓ ↑	- +	✓	M	↘	⏻
CHANNEL (↓, ↑) Buttons	VOLUME (-, +) Buttons	ENTER Button	MENU Button	INPUT Button	POWER Button

PREPARATION

■ Image shown may differ from your TV.

32/37/42/47LD450, 37/42/47LD450C

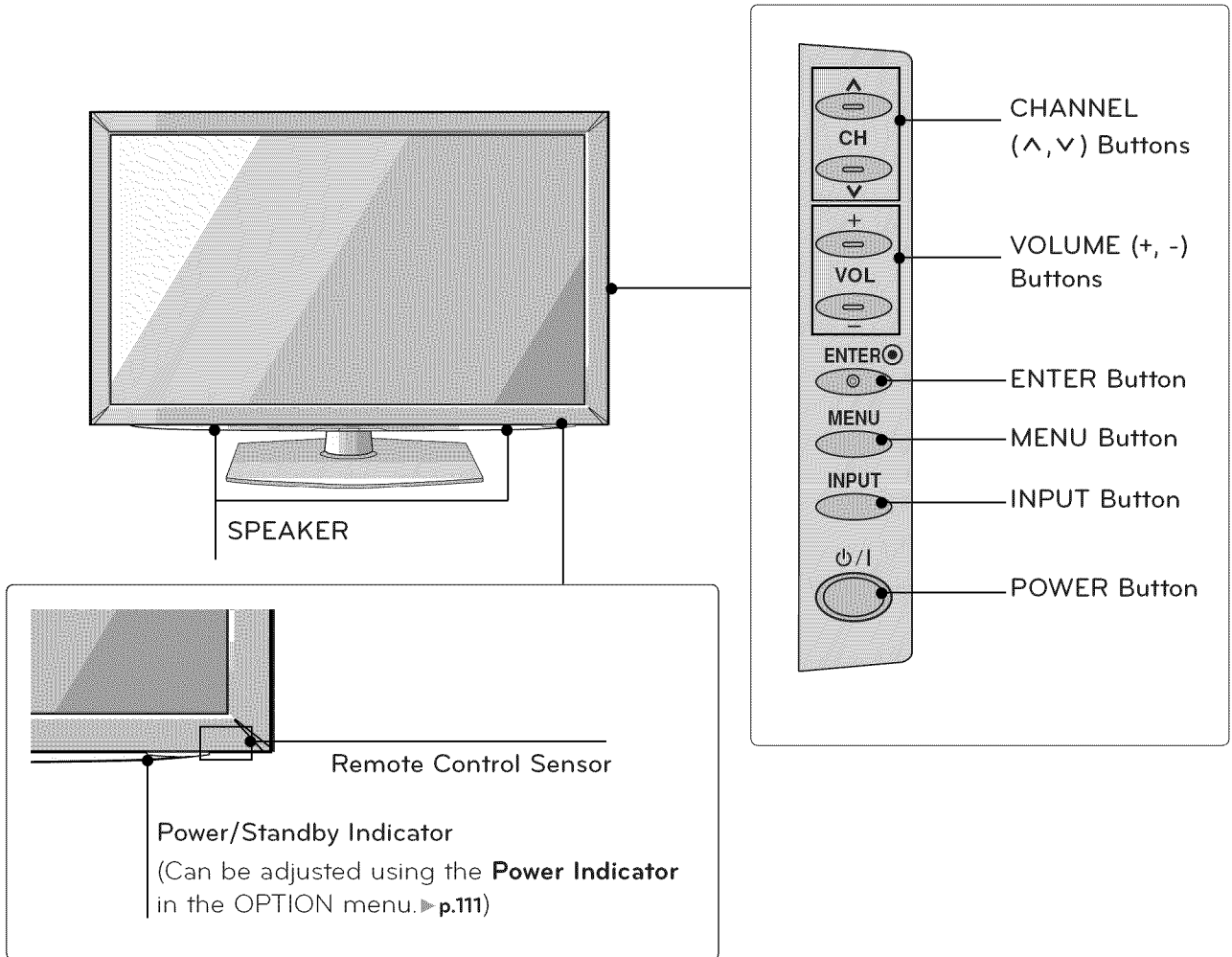

42/47/55LD630

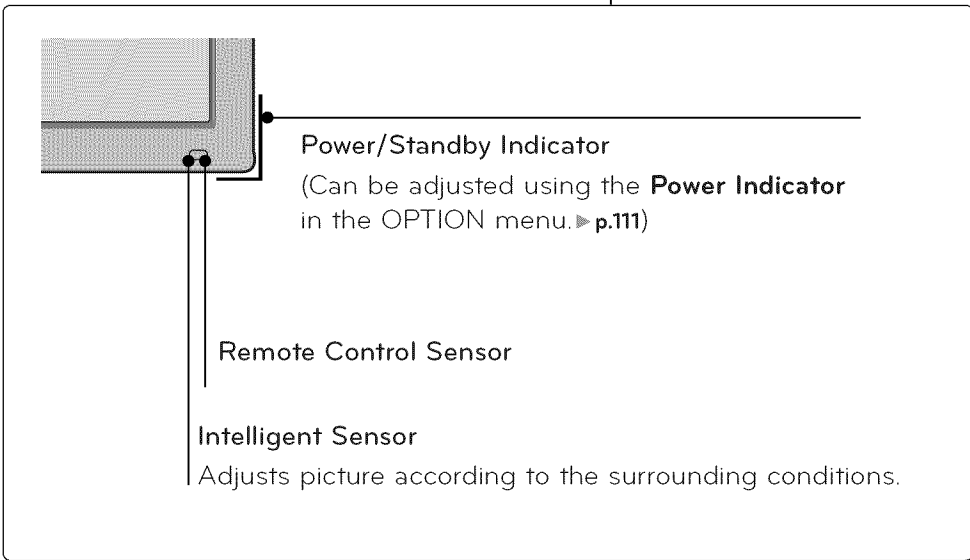
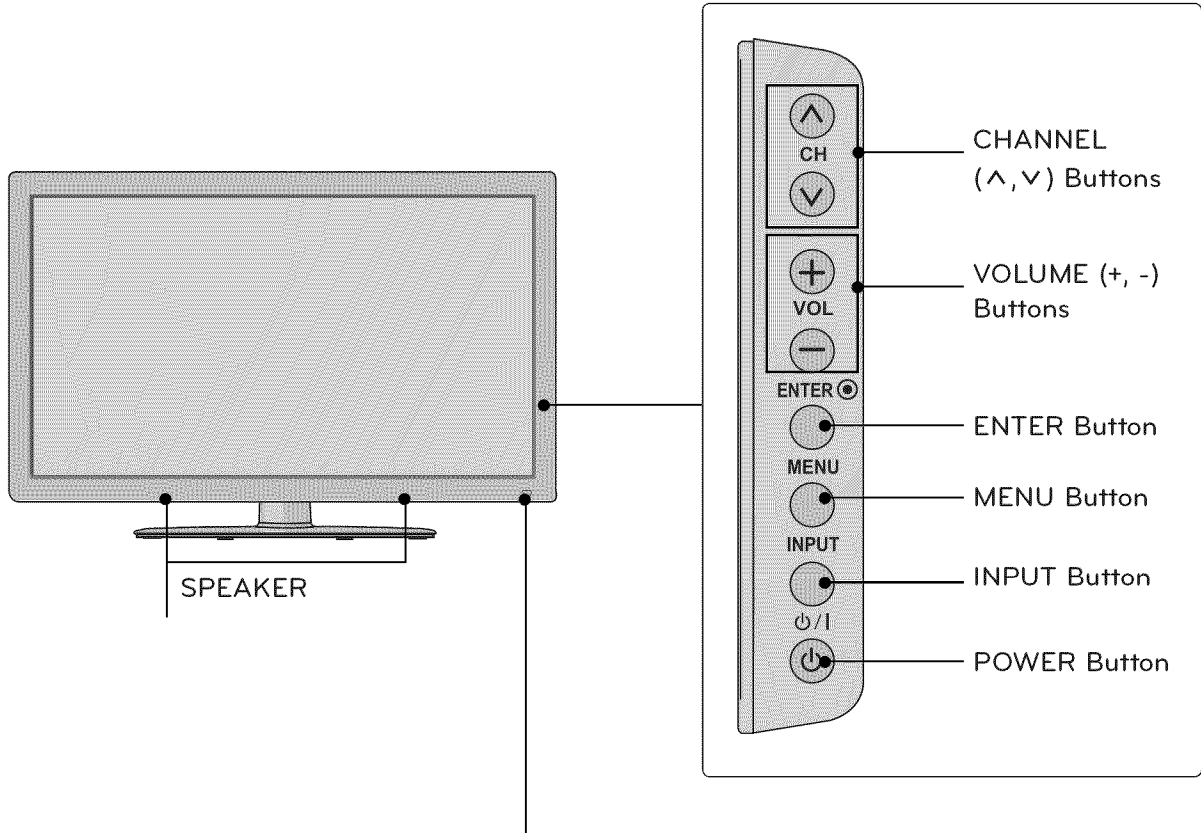

PREPARATION

PREPARATION

■ Image shown may differ from your TV.

32/42/47LD420

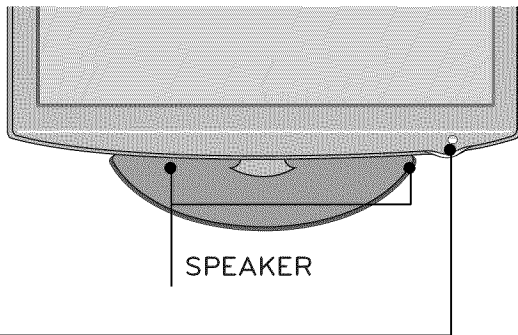

Remote Control Sensor
 Power/Standby Indicator
 (Can be adjusted using the **Power Indicator** in the OPTION menu. ▶ p.111)

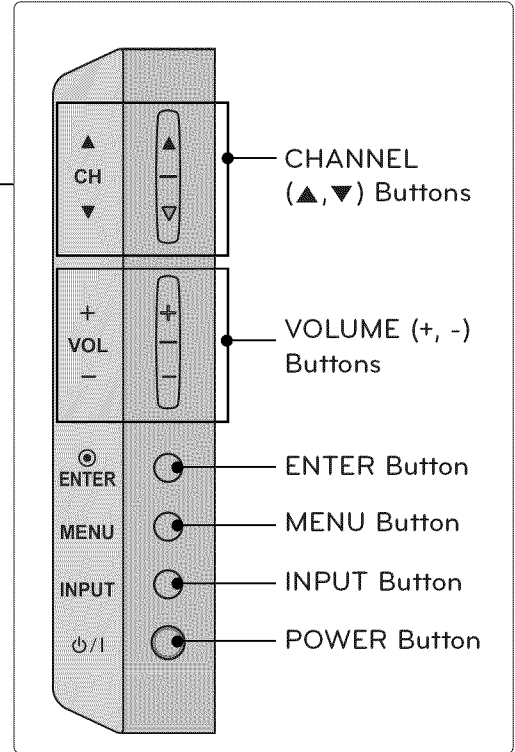

32/42/47/55LD520

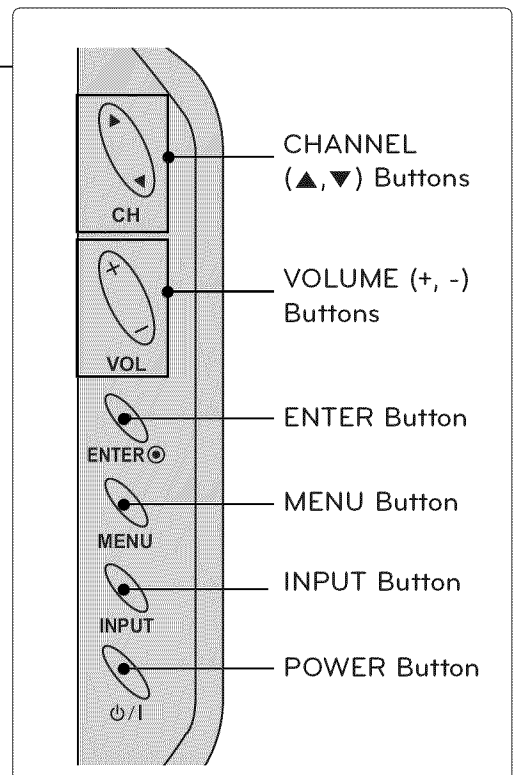
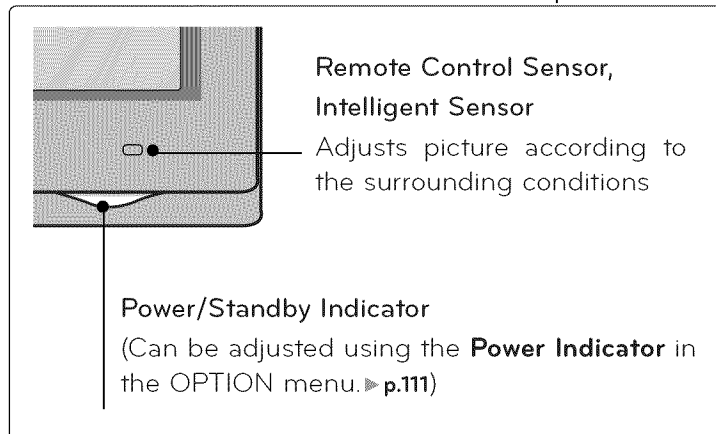
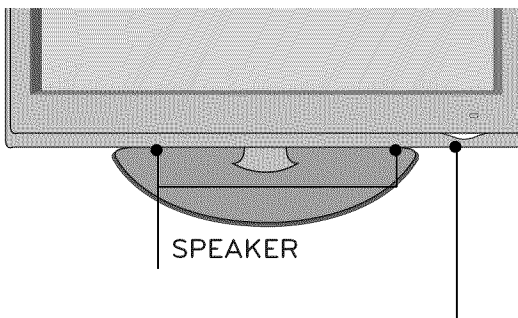

42/47/55LE7300

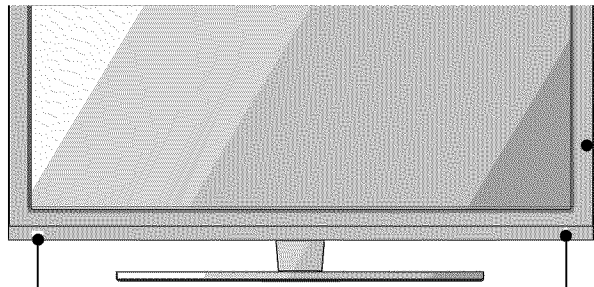

Power/Standby Indicator
 (Can be adjusted using the
Power Indicator in the OPTION
 menu. ▶ p.111)

Remote Control Sensor

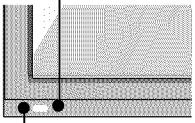

Intelligent Sensor

Adjusts picture according to
 the surrounding conditions.

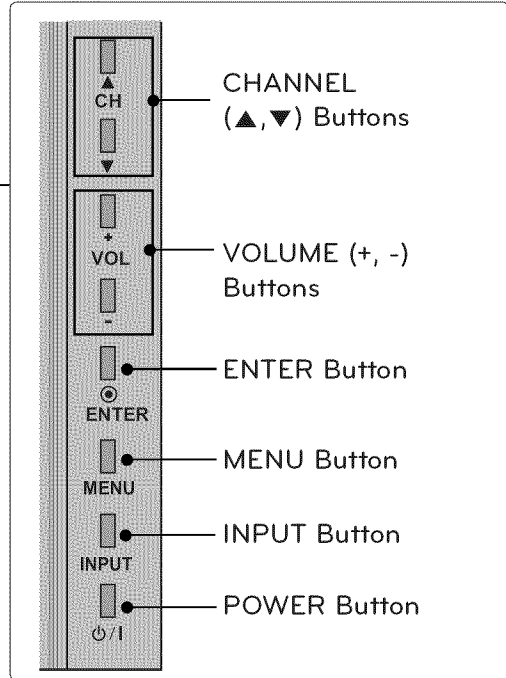

CHANNEL
 (▲, ▼) Buttons

VOLUME (+, -)
 Buttons

ENTER Button

ENTER

MENU Button

MENU

INPUT Button

INPUT

POWER Button

⏻/⏻

NOTE

- ▶ Do not step on the glass stand or subject it to any impact. It may break, causing possible injury from fragments of glass, or the TV may fall.
- ▶ Do not drag the TV. The floor or the product may be damaged.

PREPARATION

BACK PANEL INFORMATION

■ Image shown may differ from your TV.

19/22/26LE5300, 22/26LE5500

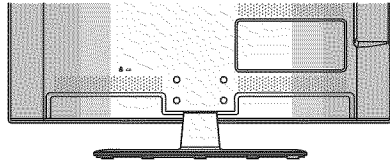

19/22LE5300,
22LE5500

26LE5300,
26LE5500

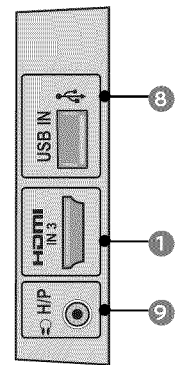
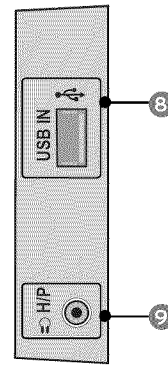
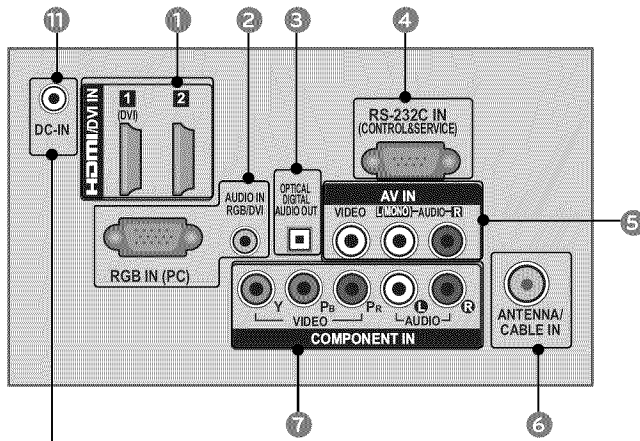

Power Connection

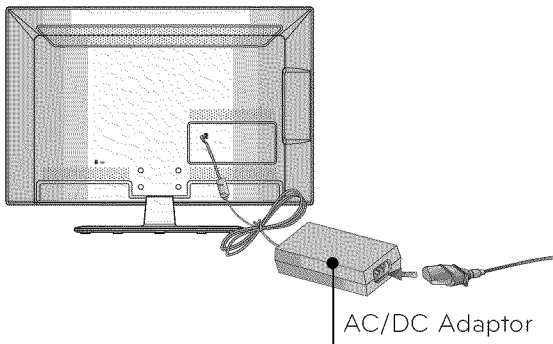

- 1 Connect the AC/DC adapter plug to the power input jack on the TV.
- 2 Connect the power cord to the AC/DC adapter first, then plug the power cord into the wall power outlet.

CAUTION

▶ Please be sure to connect the TV to the AC/DC power adapter before connecting the TV's power plug to a wall power outlet.

32/37/42/47/55LE5300

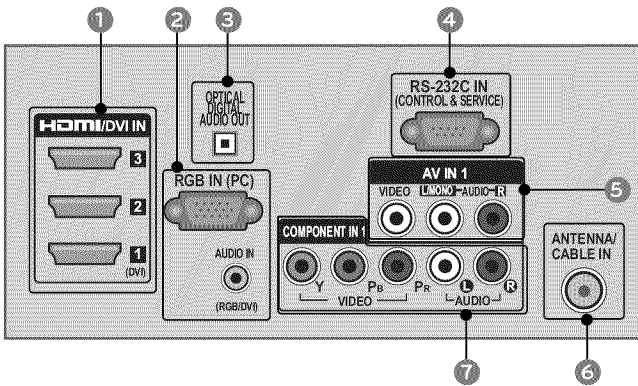
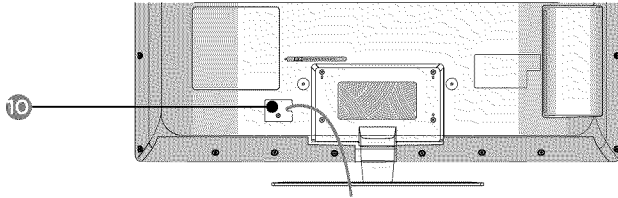

42/47/55LE7300

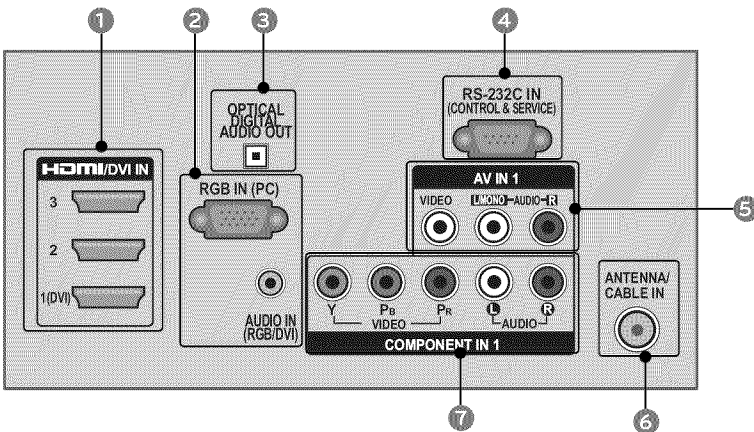

⚠ CAUTION

For HDMI IN 4 and USB IN

- ▶ For an optimal connection, HDMI cables and USB devices should have bezels less than 10 mm (0.39 inches) thick.

*A ≤ 10 mm (0.39 inches)

PREPARATION

PREPARATION

32/42/47LD420, 32/37/42/47LD450

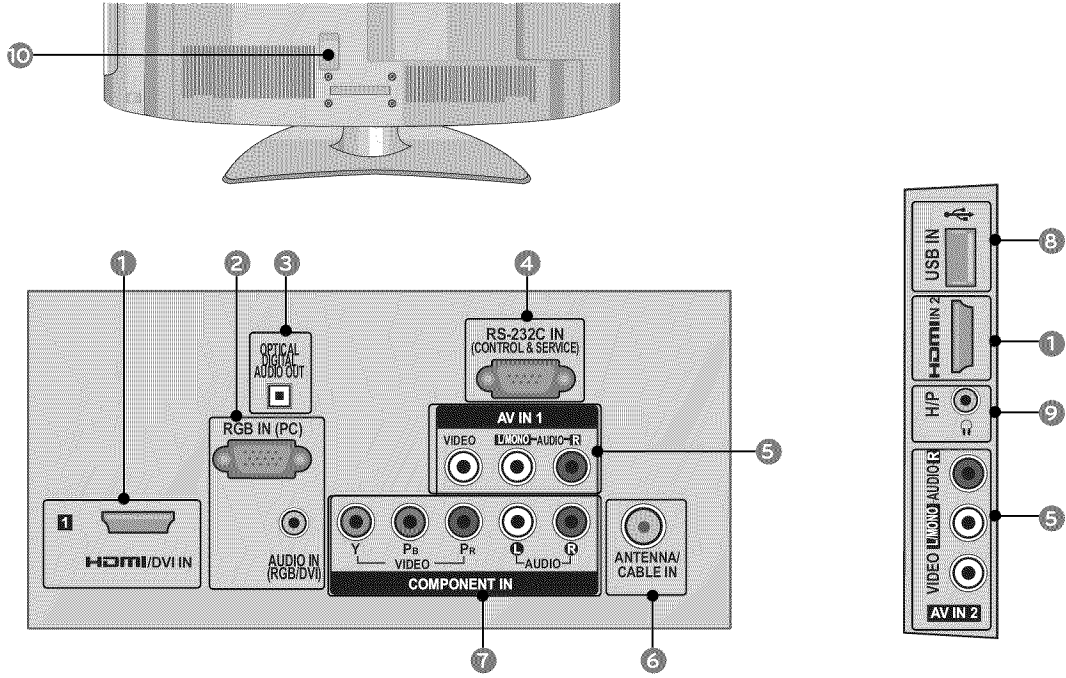

32/42/47/55LD520, 42/47/55LD630

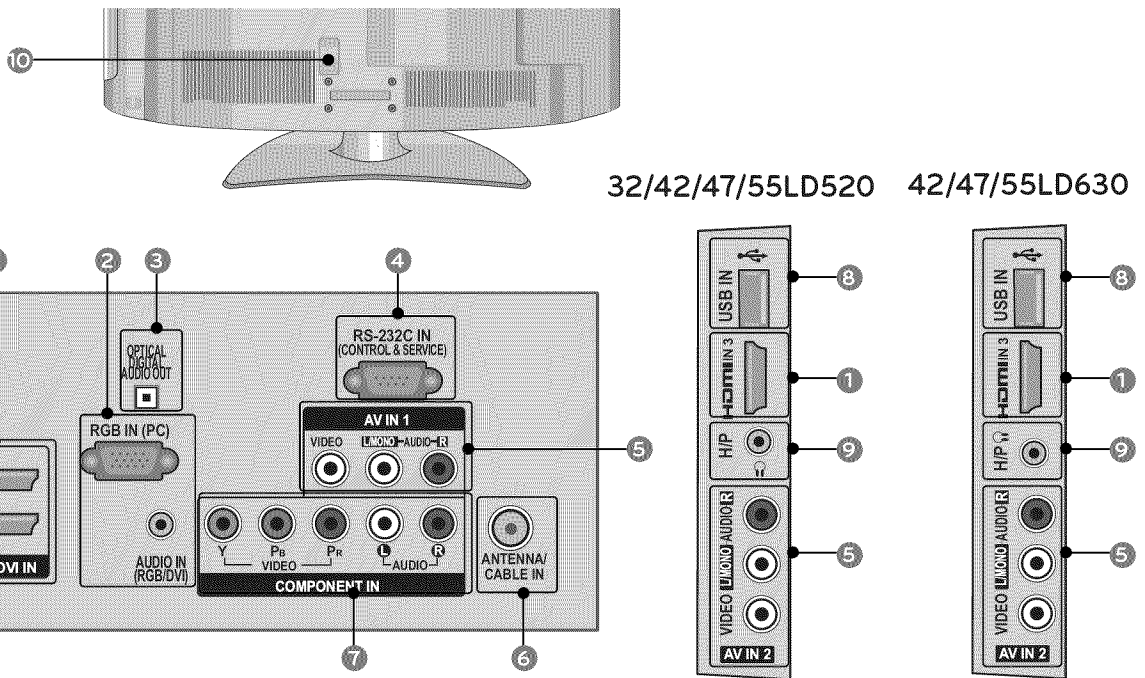

37/42/47LD450C

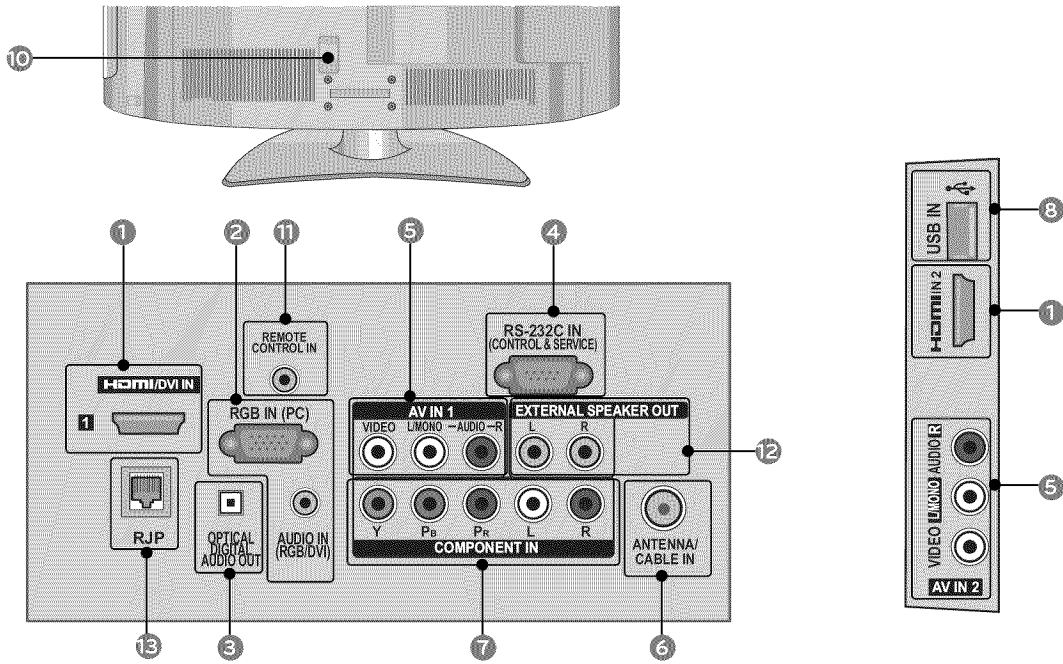

1 HDMI/DVI IN, HDMI IN

Digital Connection.

Supports HD video and Digital audio. Doesn't support 480i.

Accepts DVI video using an adapter or HDMI to DVI cable (not included).

2 RGB IN (PC)

Analog PC Connection. Uses a D-sub 15 pin cable (VGA cable).

AUDIO IN (RGB/DVI)

0.32 cm (1/8 inch) headphone jack for analog PC audio input.

3 OPTICAL DIGITAL AUDIO OUT

Digital optical audio output for use with amps and home theater systems.

Note: In standby mode, this port doesn't work.

4 RS-232C IN (CONTROL & SERVICE)

Used by third party devices.

This port is used for service or Hotel mode.

5 AV (Audio/Video) IN

Analog composite connection. Supports standard definition video only (480i).

6 ANTENNA/CABLE IN

Connect over-the-air or cable signals to this jack.

7 COMPONENT IN

Analog Connection.

Supports HD.

Uses a red, green, and blue cable for video & red and white for audio.

8 USB INPUT

Used for viewing videos, photos and listening to MP3s.

9 HEADPHONE

0.32 cm (1/8 inch) headphone jack

Impedance 16 Ω , Maximum audio out 15 mW

10 Power Cord Socket

For operation with AC power.

Caution: Never attempt to operate the TV on DC pwer.

11 REMOTE CONTROL IN

For a wired remote control.

12 EXTERNARL SPEAKER OUT

For use with external speakers.

13 RJP

Connect this to an LG remote jack pack system.

PREPARATION

STAND INSTRUCTIONS (For 19/22LE5300, 22LE5500)

■ Image shown may differ from your TV.

PREPARATION

INSTALLATION

- 1 Carefully place the TV screen side down on a cushioned surface to protect the screen from damage.

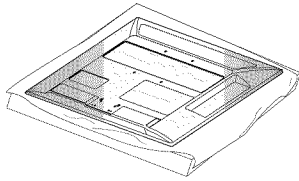

- 2 Assemble the parts of the **STAND BODY** with the **STAND BASE** of the TV.

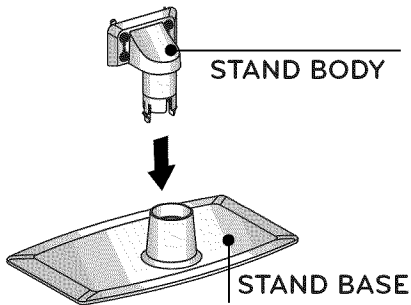

- 3 Assemble the TV as shown.

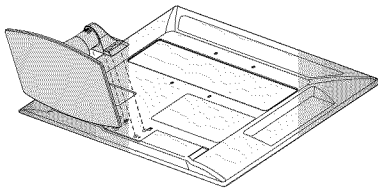

- 4 Install the 4 screws into the holes shown.

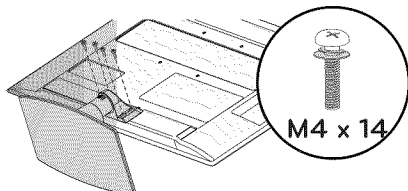

NOTE

- ▶ When assembling the desk type stand, make sure the screws are fully tightened. (If not tightened fully, the TV can tilt forward after the product installation). Do not over tighten.

DETACHMENT

- 1 Carefully place the TV screen side down on a cushioned surface to protect the screen from damage.

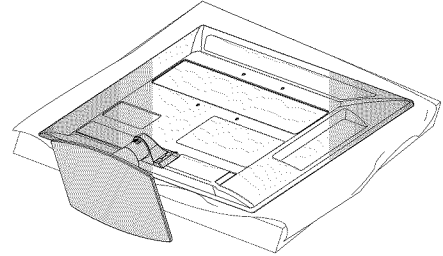

- 2 Remove the screws from the TV.

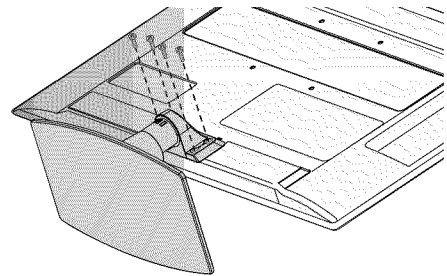

- 3 Detach the stand from TV.

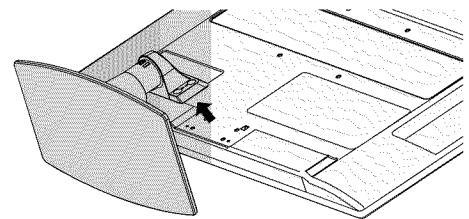

STAND INSTRUCTIONS (For 42/47/55LE7300)

■ Image shown may differ from your TV.

INSTALLATION

- 1 Carefully place the TV screen side down on a cushioned surface to protect the screen from damage.

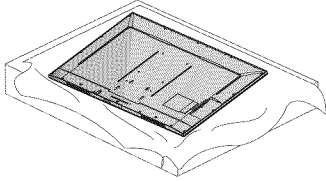

- 2 Assemble the parts of the **STAND BODY** with the **STAND BASE** of the TV.

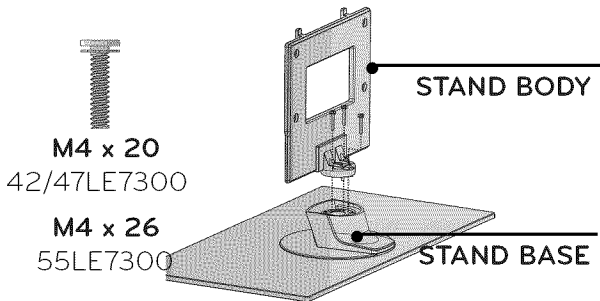

- 3 Assemble the TV as shown.

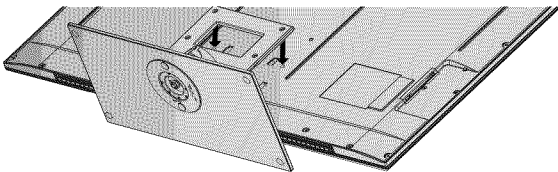

- 4 Install the 4 screws into the holes shown.

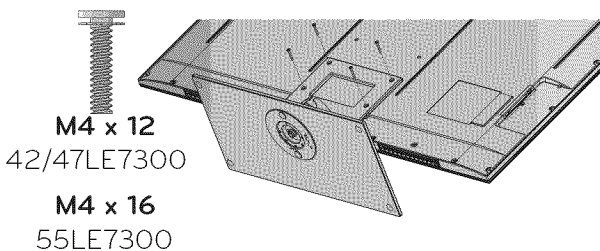

NOTE

- ▶ When assembling the desk type stand, make sure the screws are fully tightened (If not tightened fully, the TV can tilt forward after the product installation). Do not over tighten.

DETACHMENT

- 1 Carefully place the TV screen side down on a cushioned surface to protect the screen from damage.

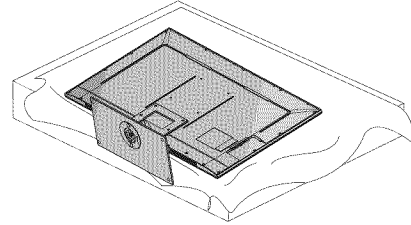

- 2 Remove the screws from the TV.

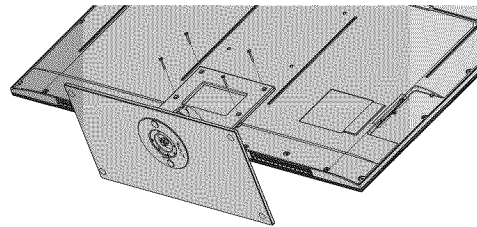

- 3 Detach the stand from TV.

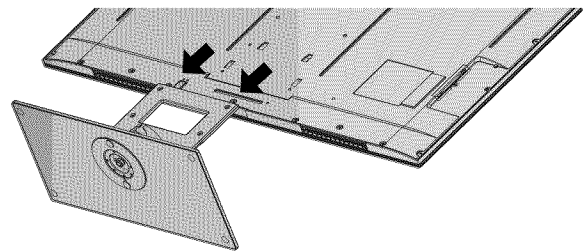

PREPARATION

STAND INSTRUCTIONS (For 26/32/37/42/47/55LE5300, 26LE5500)

■ Image shown may differ from your TV.

PREPARATION

INSTALLATION

- 1 Carefully place the TV screen side down on a cushioned surface to protect the screen from damage.

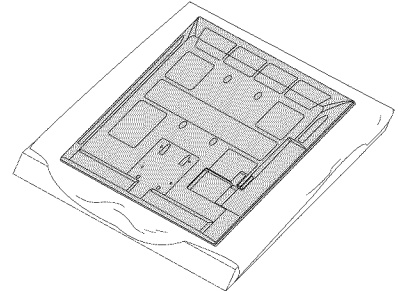

- 2 Assemble the parts of the **STAND BODY** with the **STAND BASE** of the TV.



26LE5300,
26LE5500



32LE5300

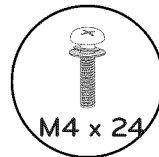

37/42LE5300

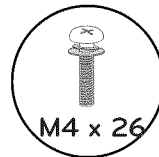

47/55LE5300

STAND BODY

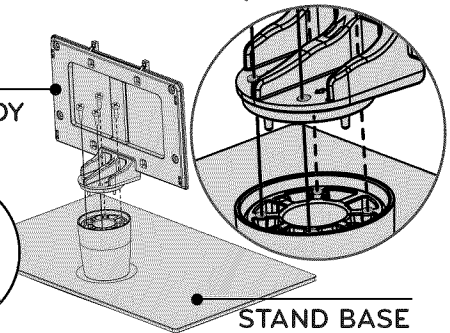

STAND BASE

- 3 Assemble the TV as shown.

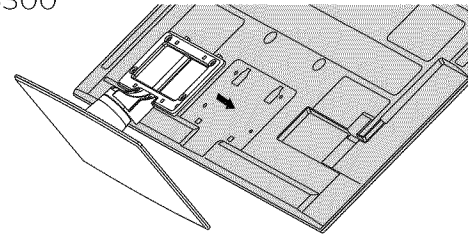

- 4 Assemble the part of the **STAND REAR COVER** with the TV.

STAND REAR COVER

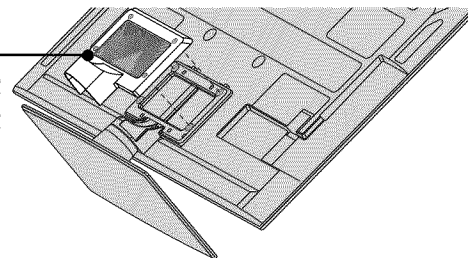

- 5 Install the 4 screws into the holes shown.

NOTE

- ▶ When assembling the desk type stand, make sure the screws are fully tightened (If not tightened fully, the TV can tilt forward after the product installation). Do not over tighten.

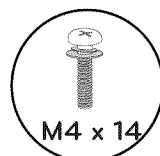

26LE5300,
26LE5500

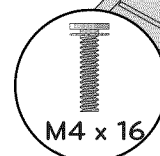

Other models

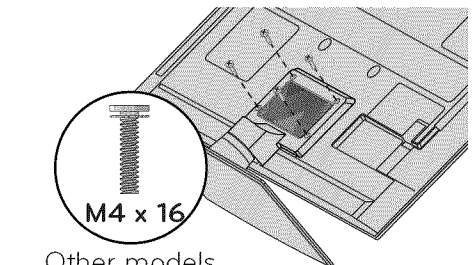

DETACHMENT

- 1 Carefully place the TV screen side down on a cushioned surface to protect the screen from damage.

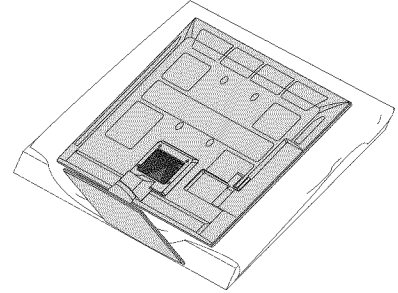

- 2 Remove the screws from the TV.

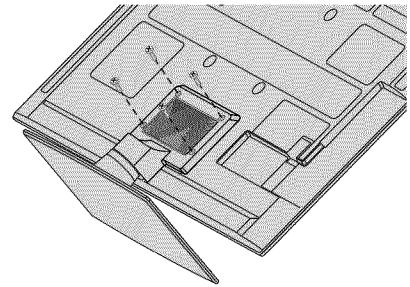

- 3 Detach the **STAND REAR COVER** from TV.

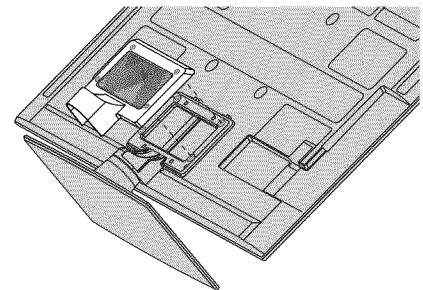

- 4 Detach the stand from TV.

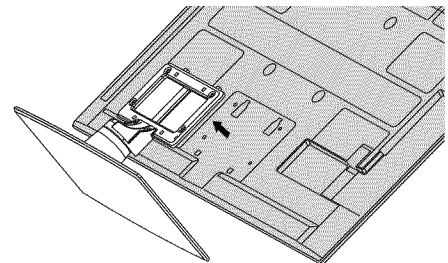

PREPARATION

STAND INSTRUCTIONS (For 32/37/42/47LD450, 37/42/47LD450C, 42/47/55LD630)

■ Image shown may differ from your TV.

PREPARATION

INSTALLATION

- 1 Carefully place the TV screen side down on a cushioned surface to protect the screen from damage.

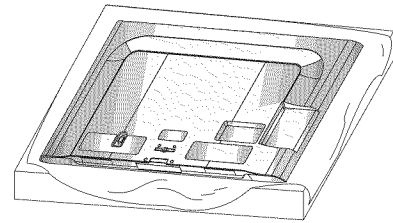

- 2 Assemble the parts of the **STAND BODY** with the **STAND BASE** of the TV.

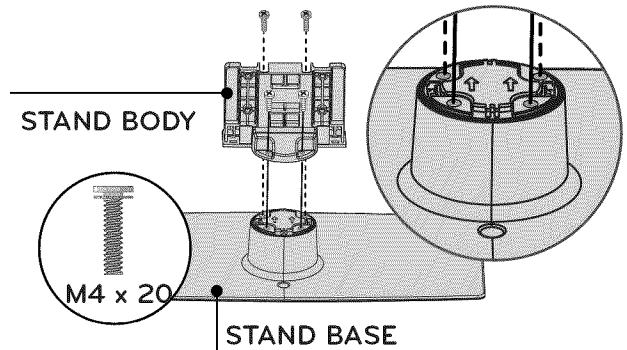

- 3 Assemble the TV as shown.

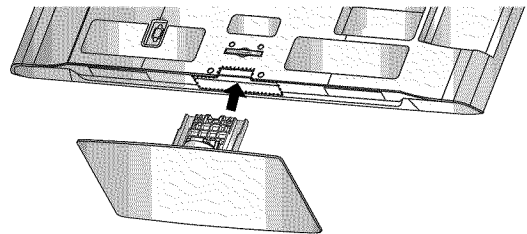

- 4 Install the 4 screws into the holes shown.

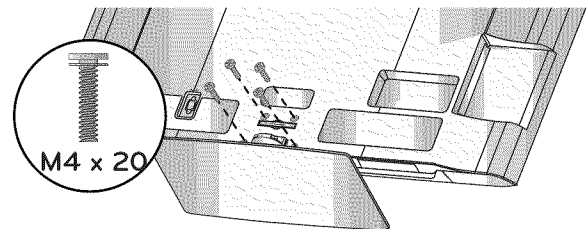

NOTE

- ▶ When assembling the desk type stand, make sure the screws are fully tightened (If not tightened fully, the TV can tilt forward after the product installation). Do not over tighten.

DETACHMENT

- 1 Carefully place the TV screen side down on a cushioned surface to protect the screen from damage.

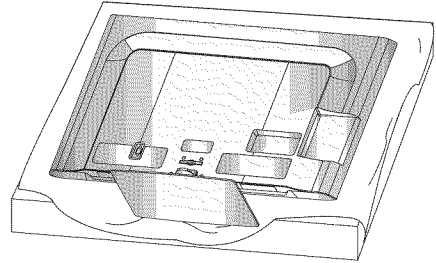

- 2 Remove the screws from the TV.

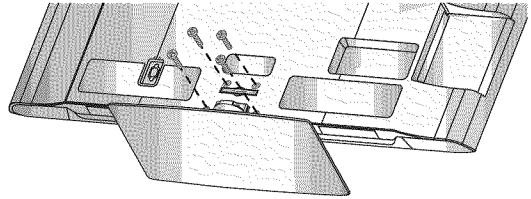

- 3 Detach the stand from TV.

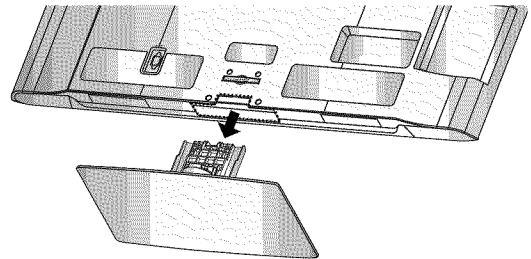

PROTECTION COVER

After removing the stand, install the included **PROTECTION COVER** over the hole for the stand.

Press the **PROTECTION COVER** into the TV until you hear it click.

When installing the wall mounting bracket, use the **PROTECTION COVER**.

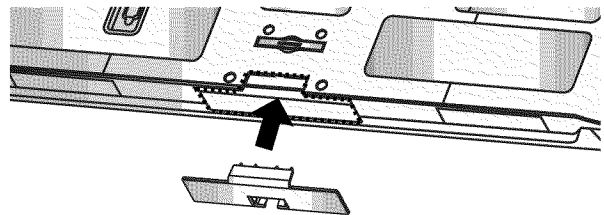

PREPARATION

STAND INSTRUCTIONS

(For 32/42/47LD420, 32/42/47/55LD520)

■ Image shown may differ from your TV.

PREPARATION

INSTALLATION (EXCEPT 55LD520)

- 1 Carefully place the TV screen side down on a cushioned surface to protect the screen from damage.

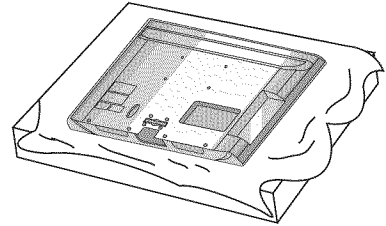

- 2 Assemble the TV as shown.

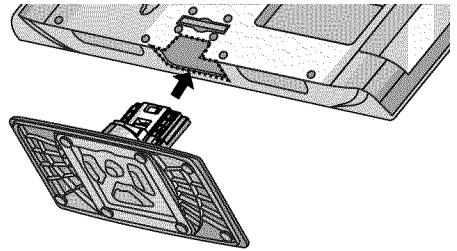

- 3 Install the 4 screws into the holes shown.

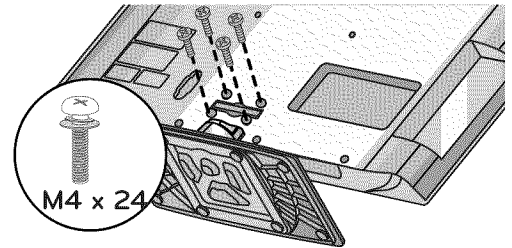

NOTE

- ▶ When assembling the desk type stand, make sure the screws are fully tightened (If not tightened fully, the TV can tilt forward after the product installation). Do not over tighten.

DETACHMENT

- 1 Carefully place the TV screen side down on a cushioned surface to protect the screen from damage.

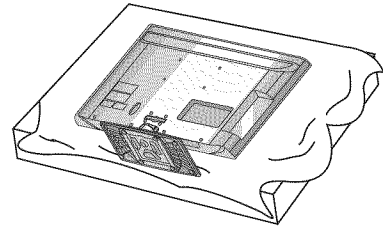

- 2 Remove the screws from the TV.

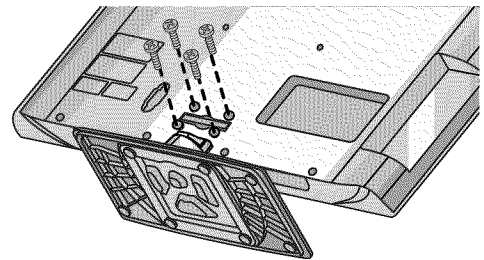

- 3 Detach the stand from TV.

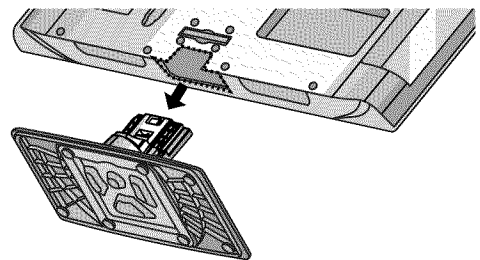

PROTECTION COVER

After removing the stand, install the included **PROTECTION COVER** over the hole for the stand.

Press the **PROTECTION COVER** into the TV until you hear it click.

When installing the wall mounting bracket, use the **PROTECTION COVER**.

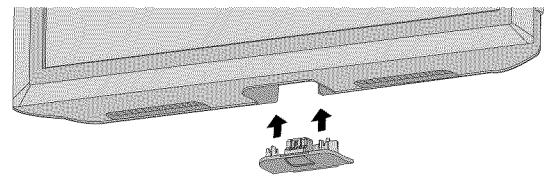

PREPARATION

VESA WALL MOUNTING

Install your wall mount on a solid wall perpendicular to the floor. When attaching to other building materials, please contact your nearest installer.

If installed on a ceiling or slanted wall, it may fall and result in severe personal injury.

We recommend that you use an LG brand wall mount when mounting the TV to a wall.

LG recommends that wall mounting be performed by a qualified professional installer.

PREPARATION

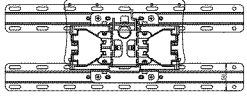
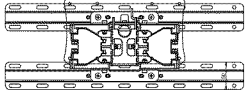
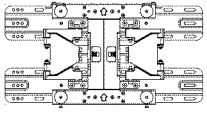
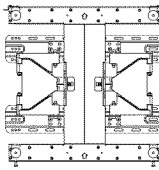
Model	VESA (A * B) 	Standard Screw	Quantity	Wall Mounting Bracket (sold separately)
19LE5300, 22LE5300, 22LE5500, 26LE5300, 26LE5500	100 * 100	M4	4	LSW100B, LSW100BG 
32LE5300, 32LD420, 32LD450, 32LD520	200 * 100	M4	4	LSW100B, LSW100BG 
37LE5300, 42LE5300, 47LE5300, 37LD450, 37LD450C, 42LE7300, 47LE7300, 42LD450, 42LD450C, 47LD450, 47LD450C, 42LD420, 47LD420, 42LD520, 47LD520, 42LD630, 47LD630	200 * 200	M6	4	LSW200B, LSW200BG 
55LE5300, 55LE7300, 55LD520, 55LD630	400 * 400	M6	4	LSW400B, LSW400BG 

NOTE

- ▶ Screw length needed depends on the wall mount used. For further information, refer to the instructions included with the mount.
- ▶ Standard dimensions for wall mount kits are shown in the table.
- ▶ When purchasing our wall mount kit, a detailed installation manual and all parts necessary for assembly are provided.
- ▶ Do not use screws longer than the standard dimension, as they may cause damage to the inside to the TV.
- ▶ For wall mounts that do not comply with the VESA standard screw specifications, the length of the screws may differ depending on their specifications.
- ▶ Do not use screws that do not comply with the VESA standard screw specifications.
- ▶ Do not use fasten the screws too strongly, this may damage the TV or cause the TV to a fall, leading to personal injury. LG is not liable for these kinds of accidents.
- ▶ LG is not liable for TV damage or personal injury when a non-VESA or non specified wall mount is used or the consumer fails to follow the TV installation instructions.

CAUTION

- ▶ Do not install your wall mount kit while your TV is turned on. It may result in personal injury due to electric shock.

For 26LE5300, 26LE5500

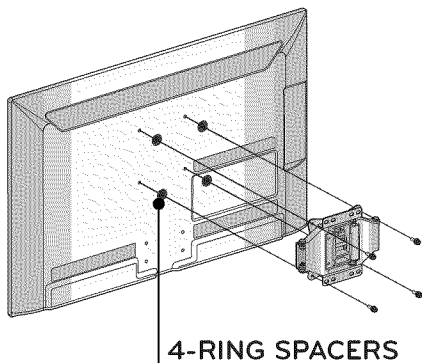

Place the ring spacers on the set before installing the wall mounting bracket so that the inclination of the backside of the set can be adjusted perpendicularly.

PREPARATION

CABLE MANAGEMENT

■ Image shown may differ from your TV.

32/37/42/47LD450, 37/42/47LD450C, 32/42/47LD420, 32/42/47/55LD520, 42/47/55LD630

PREPARATION

- 1 Connect the cables as necessary.
To connect additional equipment, see the **EXTERNAL EQUIPMENT SETUP** section.
For 37/42/47LD450C: Secure the power cord with the **PROTECTIVE BRACKET/SCREW** on the TV back cover. It will help prevent the power cable from being removed by accident.

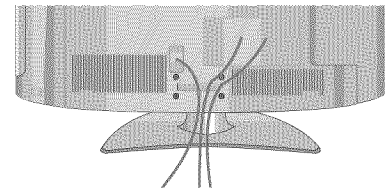
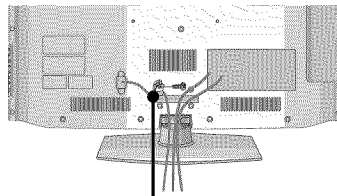
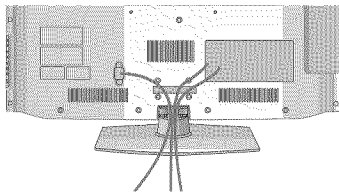

PROTECTIVE BRACKET/SCREW

- 2 Open the **CABLE MANAGEMENT CLIP** as shown.

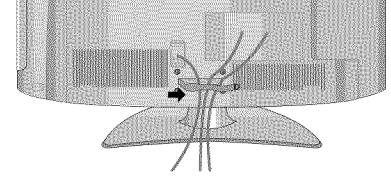
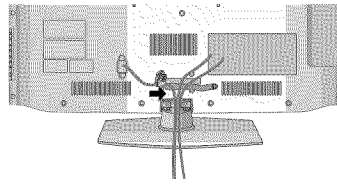
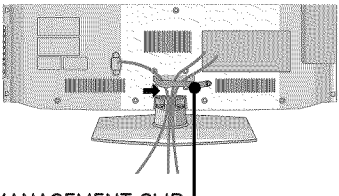

CABLE MANAGEMENT CLIP

- 3 Put the cables inside the **CABLE MANAGEMENT CLIP** and snap it closed.

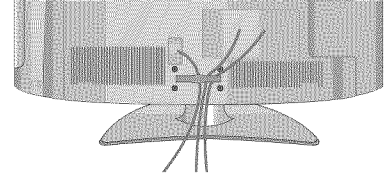
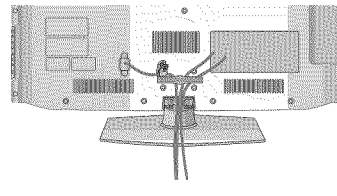
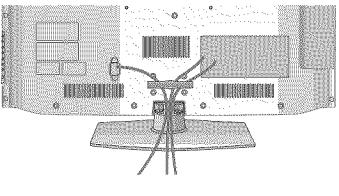

19/22/26LE5300, 22/26LE5500

- 1 After connecting the cables as necessary, install the **CABLE HOLDER** as shown and bundle the cables.

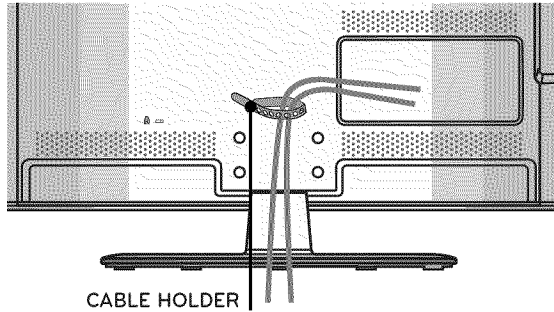

32/37/42/47/55LE5300

- 1 Secure the power cord with the **CABLE HOLDER** on the TV back cover. It will help prevent the power cable from being removed by accident.

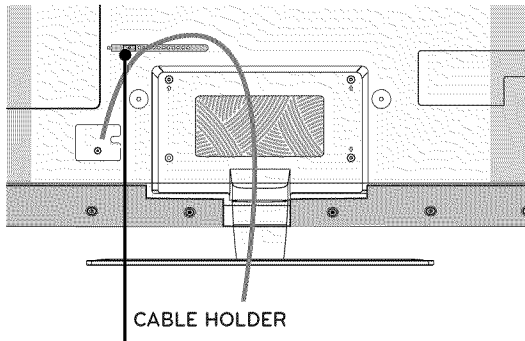

- 2 After connecting the cables as necessary, install the **CABLE HOLDER** as shown and bundle the cables.

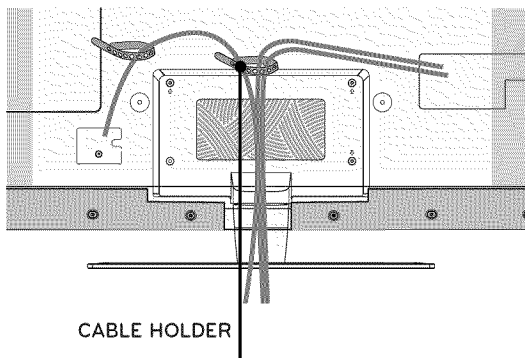

42/47/55LE7300

FOR DESK-TYPE STAND

- 1 Install the **CABLE MANAGEMENT CLIP** as shown.

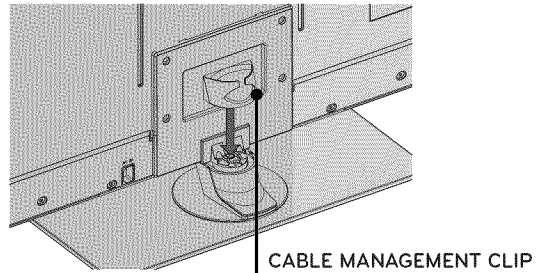

- 2 Connect the cables as necessary. To connect additional equipment, see the **EXTERNAL EQUIPMENT SETUP** section.

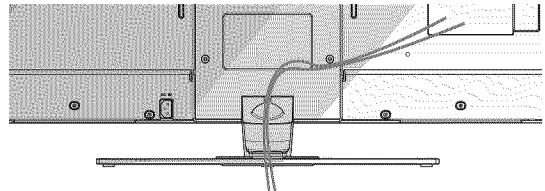

FOR WALL MOUNT

- 1 Connect the cables as necessary. To connect additional equipment, see the **EXTERNAL EQUIPMENT SETUP** section. Install **CABLE HOLDER** as shown and bundle the cables.

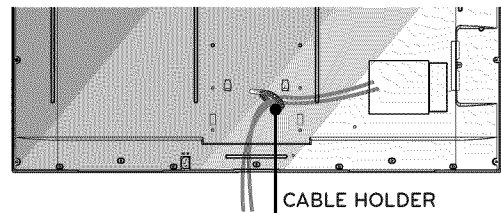

PREPARATION

DESKTOP PEDESTAL INSTALLATION

■ Image shown may differ from your TV.

For proper ventilation, allow a clearance of 10.1 cm (4 inch) on all four sides from the wall.

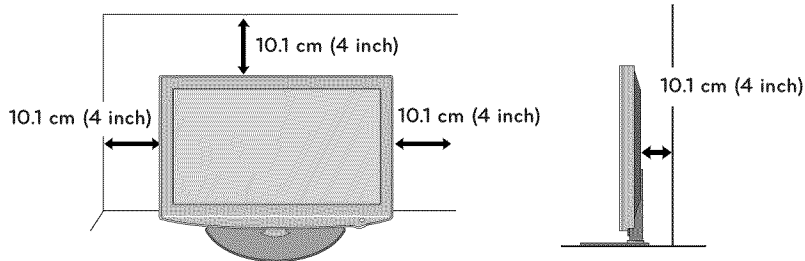

⚠ CAUTION

- ▶ Ensure adequate ventilation by following the clearance recommendations.
- ▶ Do not mount near or above any type of heat source.

SWIVEL STAND (Except 19/22LE5300, 22LE5500)

After installing the TV, you can adjust the TV set manually to the left or right direction by 20 ° to suit your viewing position.

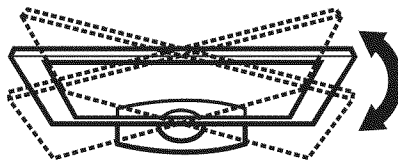

KENSINGTON SECURITY SYSTEM

■ This feature is not available for all models.

- The TV is equipped with a Kensington Security System connector on the back panel. Connect the Kensington Security System cable as shown below.
- For the detailed installation and use of the Kensington Security System, refer to the user's guide provided with the Kensington Security System.

For further information, contact <http://www.kensington.com>, the internet homepage of the Kensington company. Kensington sells security systems for expensive electronic equipment such as notebook PCs and LCD projectors.

NOTE: The Kensington Security System is an optional accessory.

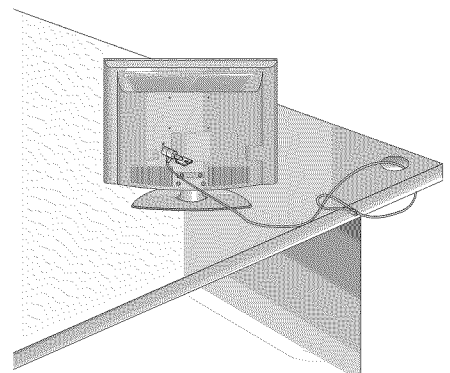

ATTACHING THE TV TO A DESK

(For 32/42LD420, 32/37/42LD450, 37/42LD450C, 32/42LD520, 42LD630, 32LE5300)

■ Image shown may differ from your TV.

The TV must be attached to a desk so it cannot be pulled in a forward/backward direction, potentially causing injury or damaging the product.

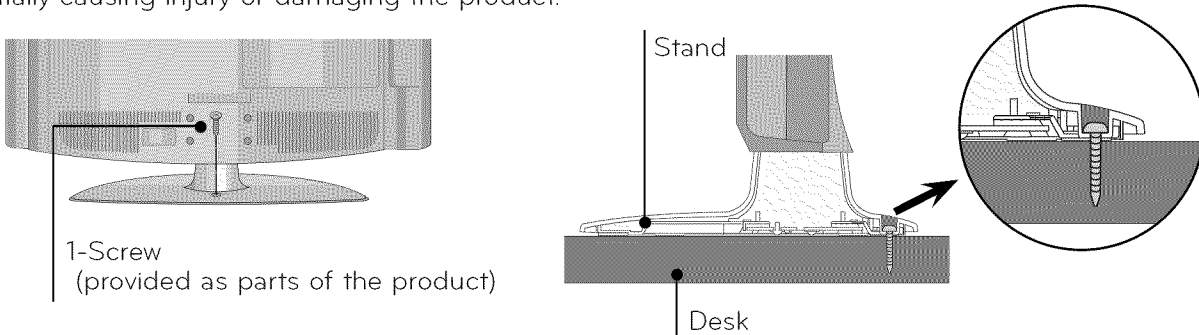

For 37/42/47LD450C

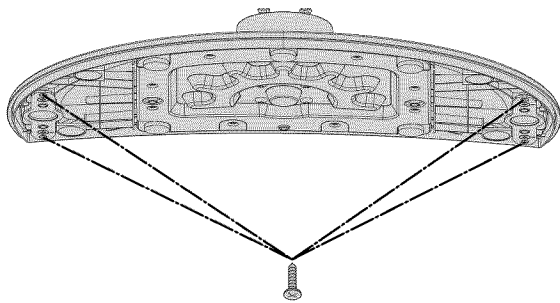

4-Screws
(not provided as parts of the product)

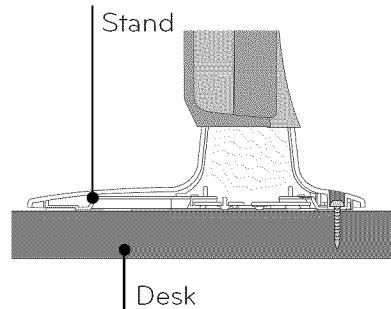

- ▶ Recommended screw size: M5 x L (*L: Table depth + 8~10 mm)
- ex) Table depth: 15mm, Screw: M5 x 25

⚠ WARNING

- ▶ To prevent TV from falling over, the TV should be securely attached to the floor/wall per installation instructions. Tipping, shaking, or rocking the machine may cause injury.

PREPARATION

PREPARATION

SECURING THE TV TO THE WALL TO PREVENT FALLING WHEN THE TV IS USED ON A STAND

- You should purchase necessary components to prevent the TV from tipping over (when not using a wall mount).
- Image shown may differ from your TV.

We recommend that you set up the TV close to a wall so it cannot fall over if pushed backwards. Additionally, we recommend that the TV be attached to a wall so it cannot be pulled in a forward direction, potentially causing injury or damaging the product.

Caution: Please make sure that children don't climb on or hang from the TV.

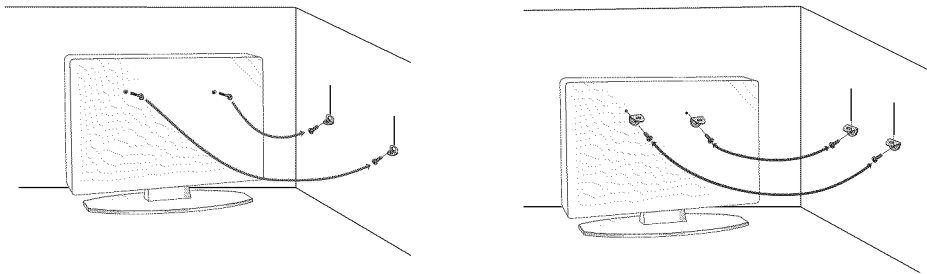

- Insert the eye-bolts (or TV brackets and bolts) to tighten the product to the wall as shown in the picture.
 - * If your product has the bolts in the eye-bolts position before inserting the eye-bolts, loosen the bolts.
 - * Insert the eye-bolts or TV brackets/bolts and tighten them securely in the upper holes.
- Secure the wall brackets with the bolts (sold separately) to the wall. Match the height of the bracket that is mounted on the wall to the holes in the product.
- Ensure the eye-bolts or brackets are tightened securely.

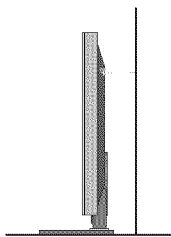

- Use a sturdy rope (sold separately) to tie the product. It is safer to tie the rope so it becomes horizontal between the wall and the product.

NOTE

- ▶ Use a platform or cabinet strong enough and large enough to support the size and weight of the TV.
- ▶ To use the TV safely make sure that the height of the bracket on the wall and the one on the TV are the same.

- To prevent damage do not connect to the power outlet until all connections are made between the devices.
- Image shown may differ from your TV.

ANTENNA OR CABLE CONNECTION

1. Antenna (Analog or Digital)

Wall Antenna Socket or Outdoor Antenna without a Cable Box Connections.

For optimum picture quality, adjust antenna direction if needed.

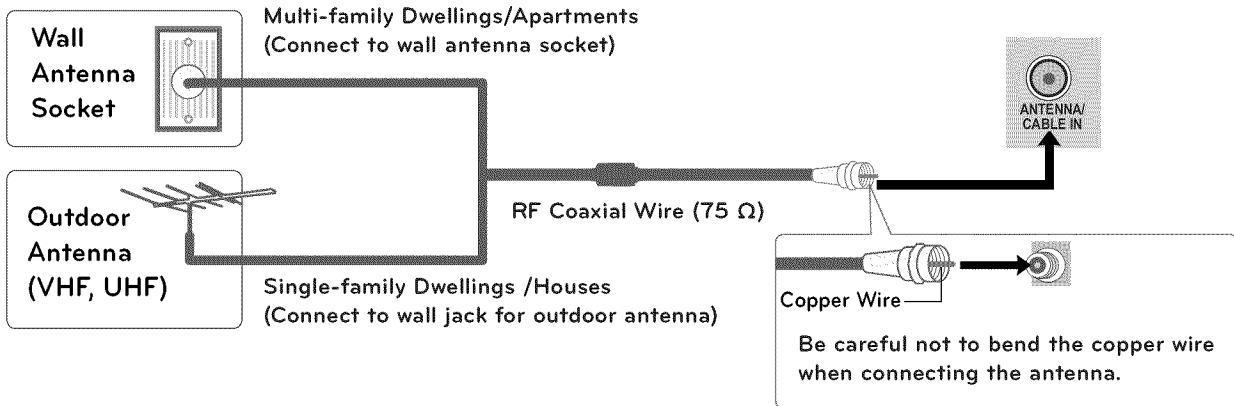

2. Cable

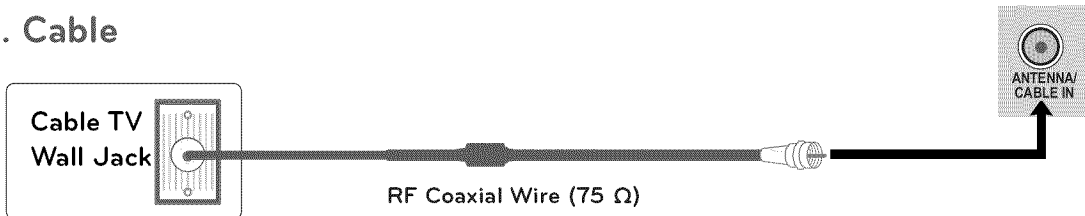

- If the antenna needs to be split for two TV's, install a 2-Way Signal Splitter.
- For much more information about antennas visit our Knowledgebase at <http://lgknowledgebase.com>. Search for antenna.

EXTERNAL EQUIPMENT SETUP

- To prevent the equipment damage, never plug in any power cords until you have finished connecting all equipment.
- This part of EXTERNAL EQUIPMENT SETUP mainly use picture of for 26LE5300/26LE5500.

HD RECEIVER SETUP

This TV can receive digital over-the-air/digital cable signals without an external digital set-top box. However, if you do receive digital signals from a digital set-top box or other digital external device.

Component Connection

1. How to connect

- 1 Connect the video outputs (Y, PB, PR) of the digital set-top box to the **COMPONENT IN VIDEO** or 1/2* jacks on the TV. Match the jack colors (Y = green, PB = blue, and PR = red).
- 2 Connect the audio output of the digital set-top box to the **COMPONENT IN AUDIO** or 1/2* jacks on the TV.

2. How to use

- Turn on the digital set-top box.
(Refer to the owner's manual for the digital set-top box operation.)
- Select the **Component** or **Component1/2*** input source on the TV using the **INPUT** button on the remote control.

* Component2: For 32/37/42/47/55LE5300, 42/47/55LE7300

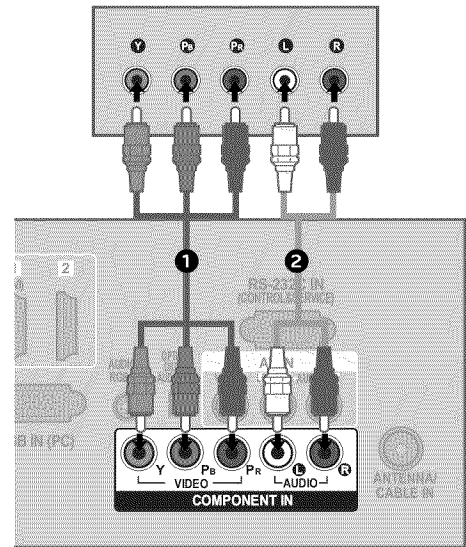

Y, CB/PB, CR/PR

Resolution	Horizontal Frequency(KHz)	Vertical Frequency(Hz)
720x480i	15.73	59.94
	15.73	60.00
720x480p	31.47	59.94
	31.50	60.00
1280x720p	44.96	59.94
	45.00	60.00
1920x1080i	33.72	59.94
	33.75	60.00
1920x1080p	26.97	23.976
	27.00	24.00
	33.71	29.97
	33.75	30.00
	67.432	59.94
	67.50	60.00

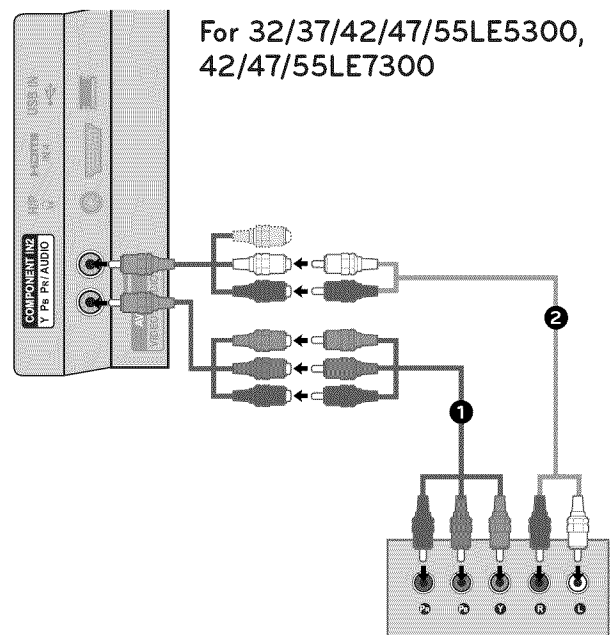

HDMI Connection

1. How to connect

- 1 Connect the digital set-top box to **HDMI/DVI IN 1, 2, 3***, or **4**** jack on the TV.
- 2 No separate audio connection is necessary. HDMI supports both audio and video.

2. How to use

- Turn on the digital set-top box.
(Refer to the owner's manual for the digital set-top box.)
- Select the **HDMI1**, **HDMI2**, **HDMI3***, or **HDMI4**** input source on the TV using the **INPUT** button on the remote control.

* HDMI3: For 26LE5300/5500, 32/42/47/55LD520, 42/47/55LD630

** HDMI4: For 32/37/42/47/55LE5300, 42/47/55LE7300

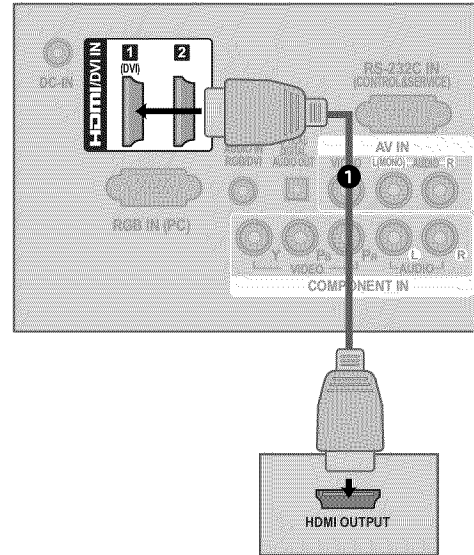

NOTE

- ▶ If an HDMI cable doesn't support High Speed HDMI, it can cause flickers or no screen display. In this case use the latest cables that support High Speed HDMI.
- ▶ HDMI Audio Supported Format: Dolby Digital (32 KHz, 44.1 KHz, 48 KHz), Linear PCM (32 KHz, 44.1 KHz, 48 KHz)

HDMI-DTV

Resolution	Horizontal Frequency(KHz)	Vertical Frequency(Hz)
720x480p	31.47	59.94
	31.50	60.00
1280x720p	44.96	59.94
	45.00	60.00
1920x1080i	33.72	59.94
	33.75	60.00
1920x1080p	26.97	23.976
	27.00	24.00
	33.71	29.97
	33.75	30.00
	67.432	59.94
	67.50	60.00

EXTERNAL EQUIPMENT SETUP

DVI to HDMI Connection

1. How to connect

- 1 Connect the DVI output of the digital set-top box to the **HDMI/DVI IN 1** or **2*** jack on the TV.
- 2 Connect the digital set-top box audio output to the **AUDIO IN (RGB/DVI)** jack on the TV.

2. How to use

- Turn on the digital set-top box.
(Refer to the owner's manual for the digital set-top box.)
- Select the **HDMI1** or **HDMI2*** input source on the TV using the **INPUT** button on the remote control.

* **HDMI2**: For 32/42/47/55LD520, 42/47/55LD630

NOTE

- ▶ A DVI to HDMI cable or adapter is required for this connection. DVI doesn't support audio, so a separate audio connection is necessary.

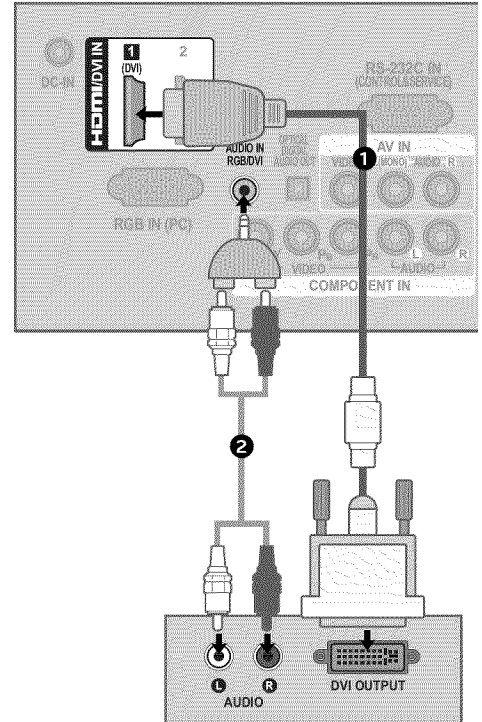

DVD SETUP

Component Connection

1. How to connect

- 1 Connect the video outputs (Y, PB, PR) of the DVD to the **COMPONENT IN VIDEO** or **1/2*** jacks on the TV. Match the jack colors (Y = green, PB = blue, and PR = red).
- 2 Connect the audio outputs of the DVD to the **COMPONENT IN AUDIO** or **1/2*** jacks on the TV.

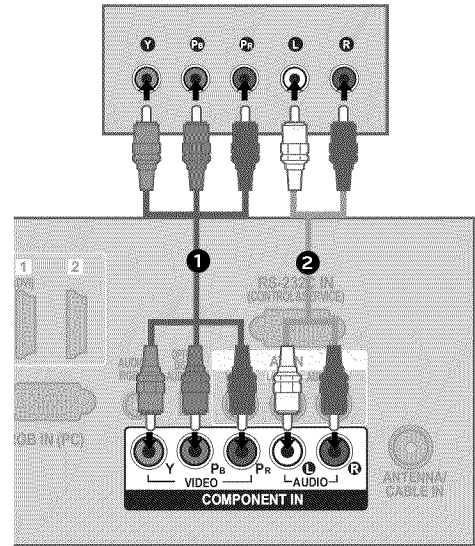

2. How to use

- Turn on the DVD player, insert a DVD.
- Select the **Component** or **Component1/2*** input source on the TV using the **INPUT** button on the remote control.
- Refer to the DVD player's manual for operating instructions.

* Component2: For 32/37/42/47/55LE5300, 42/47/55LE7300

Component Input ports

To get better picture quality, connect a DVD player to the component input ports as shown below.

Component ports on the TV	Y	P _B	P _R
Video output ports on DVD player	Y	P _B	P _R
	Y	B-Y	R-Y
	Y	C _b	C _r
	Y	P _b	P _r

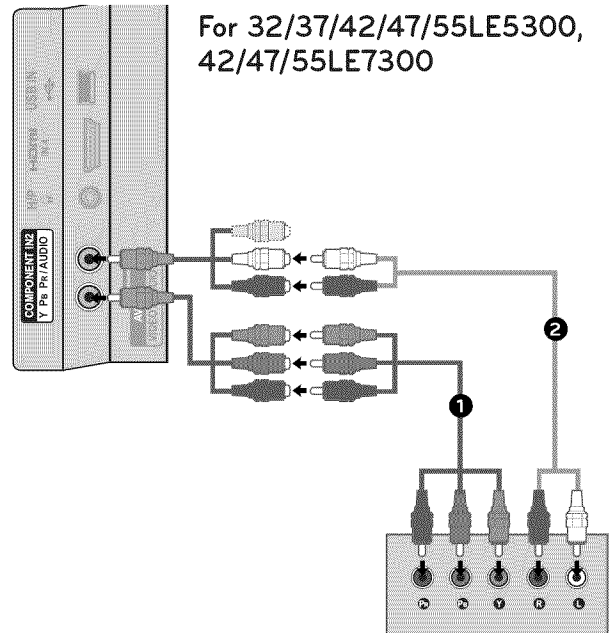

EXTERNAL EQUIPMENT SETUP

Composite (RCA) Connection

1. How to connect

- 1 Connect the **AUDIO/VIDEO** jacks between TV and DVD. Match the jack colors (Video = yellow, Audio Left = white, and Audio Right = red)

2. How to use

- Turn on the DVD player, insert a DVD.
- Select the **AV** or **AV1/2*** input source on the TV using the **INPUT** button on the remote control.
- Refer to the DVD player's manual for operating instructions.

* AV2: Except 19/22/26LE5300, 22/26LE5500

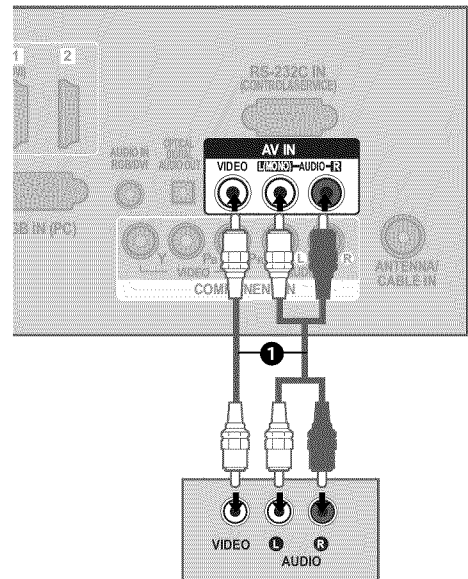

HDMI Connection

1. How to connect

- 1 Connect the HDMI output of the DVD to the **HDMI/DVI IN 1, 2, 3***, or **4**** jack on the TV.
- 2 No separate audio connection is necessary. HDMI supports both audio and video.

2. How to use

- Select the **HDMI1**, **HDMI2**, **HDMI3***, or **HDMI4**** input source on the TV using the **INPUT** button on the remote control.
- Refer to the DVD player's manual for operating instructions.

* HDMI3: For 26LE5300/5500, 32/42/47/55LD520, 42/47/55LD630

** HDMI4: For 32/37/42/47/55LE5300, 42/47/55LE7300

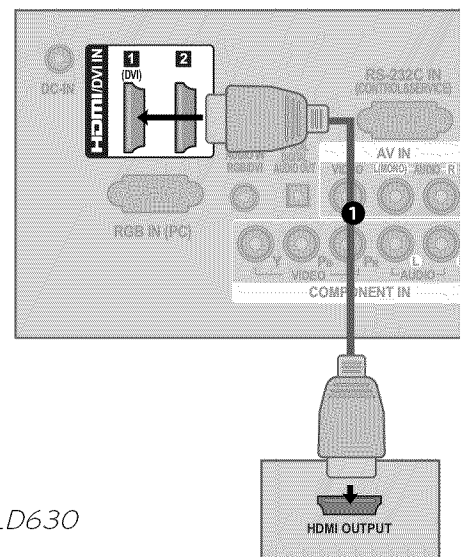

NOTE

- ▶ If an HDMI cable doesn't support High Speed HDMI, it can cause flickers or no screen display. In this case use the latest cables that support High Speed HDMI.
- ▶ HDMI Audio Supported Format: Dolby Digital (32 KHz, 44.1 KHz, 48 KHz), Linear PCM (32 KHz, 44.1 KHz, 48 KHz)

VCR SETUP

Antenna Connection

1. How to connect

- 1 Connect the RF antenna out socket of the VCR to the **ANTENNA/CABLE IN** socket on the TV.
- 2 Connect the antenna cable to the RF antenna in socket of the VCR.

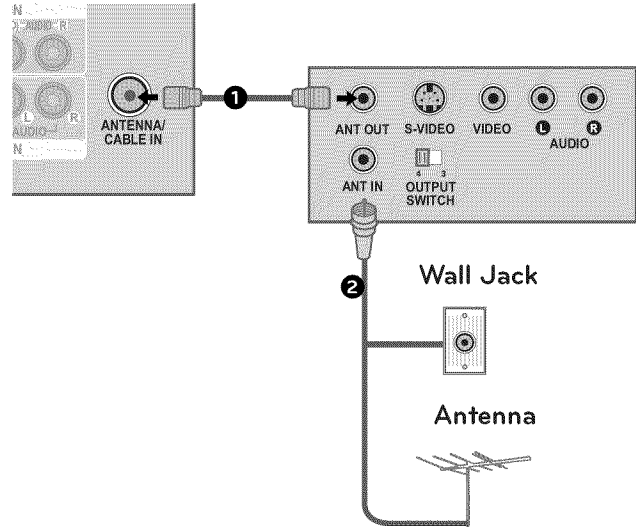

2. How to use

- Set VCR output switch to 3 or 4 and then tune TV to the same channel number.
- Insert a video tape into the VCR and press PLAY on the VCR (Refer to the VCR owner's manual).

Composite (RCA) Connection

1. How to connect

- 1 Connect the **AUDIO/VIDEO** jacks between TV and VCR. Match the jack colors (Video = yellow, Audio Left = white, and Audio Right = red)

2. How to use

- Insert a video tape into the VCR and press PLAY on the VCR. (Refer to the VCR owner's manual.)
- Select the **AV** or **AV1/2*** input source on the TV using the **INPUT** button on the remote control.

* AV2: Except 19/22/26LE5300, 22/26LE5500

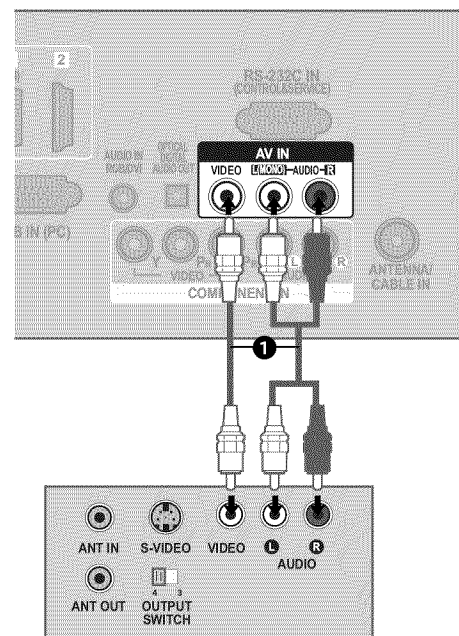

NOTE

- ▶ If you have a mono VCR, connect the audio cable from the VCR to the **AUDIO L(MONO)** jack of the TV.

EXTERNAL EQUIPMENT SETUP

OTHER A/V SOURCE SETUP

1. How to connect

- 1 Connect the **AUDIO/VIDEO** jacks between TV and external equipment. Match the jack colors. (Video = yellow, Audio Left = white, and Audio Right = red)

2. How to use

- Select the **AV** or **AV1/2*** input source on the TV using the **INPUT** button on the remote control.
- Operate the corresponding external equipment.

* AV2: Except 19/22/26LE5300, 22/26LE5500

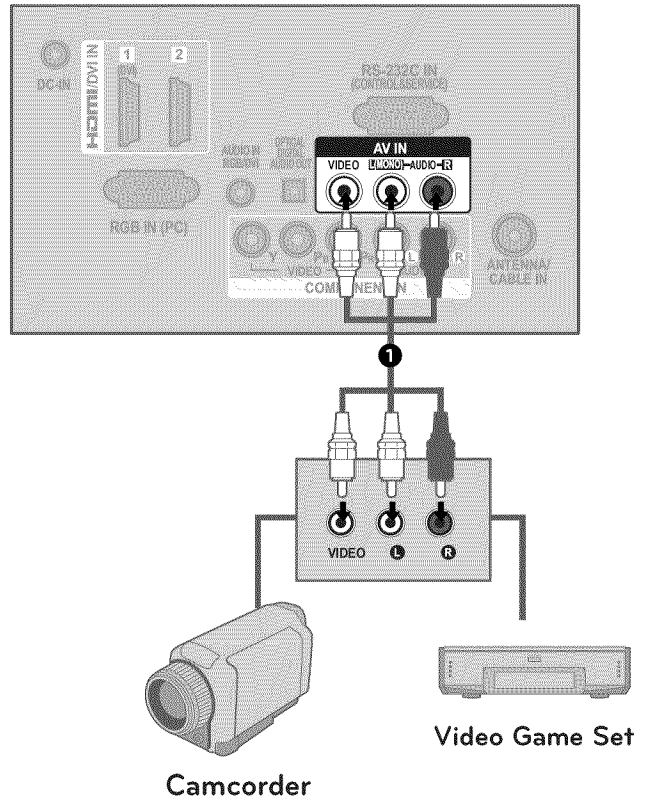

USB CONNECTION

1. How to connect

- 1 Connect the USB device to the **USB IN** jack on the side of TV.

2. How to use

- After connecting the **USB IN** jack, you use the USB function. (▶ p.78)

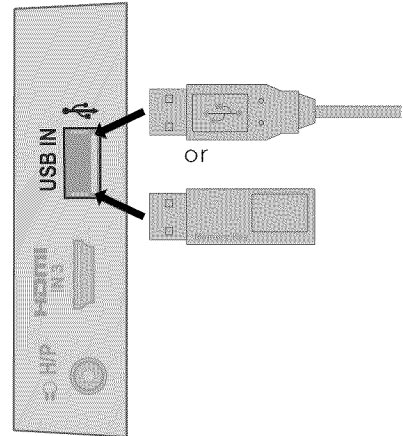

HEADPHONE SETUP

You can listen to the sound through the headphone.

1. How to connect

- 1 Plug the headphone into the headphone socket.
- 2 To adjust the headphone volume, press the **VOL +/-** button. If you press the **MUTE** button, the sound from the headphone is switched off.

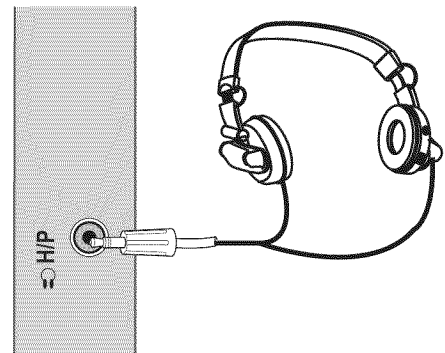

NOTE

- ▶ AUDIO menu options are disabled when connecting a headphone.
- ▶ When changing AV MODE with a headphone connected, the change is applied to video but not to audio.
- ▶ Optical Digital Audio Out is not available when connecting a headphone.

EXTERNAL EQUIPMENT SETUP

AUDIO OUT CONNECTION

Send the TV's audio to external audio equipment via the Audio Output port.

If you want to enjoy digital broadcasting through 5.1-channel speakers, connect the OPTICAL DIGITAL AUDIO OUT terminal on the back of TV to a Home Theater (or amp).

1. How to connect

- 1 Connect one end of the optical cable to the TV port of **OPTICAL DIGITAL AUDIO OUT**.
- 2 Connect the other end of the optical cable to the digital audio input on the audio equipment.
- 3 Set the "TV Speaker option - Off" in the AUDIO menu. (▶ p.119). See the external audio equipment instruction manual for operation.

NOTE

- ▶ When connecting with external audio equipment, such as amplifiers or speakers, you can turn the TV speakers off in the menu. (▶ p.119)

CAUTION

- ▶ Do not look into the optical output port. Looking at the laser beam may damage your vision.
- ▶ Audio with ACP (Audio Copy Protection) function may block digital audio output.

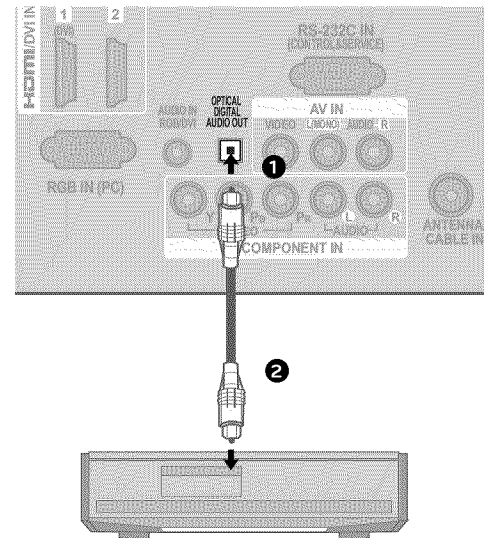

PC SETUP

This TV provides Plug and Play capability, meaning that a PC adjusts automatically to the TV's settings.

VGA (D-Sub 15 Pin) Connection

1. How to connect

- 1 Connect the VGA output of the PC to the **RGB IN (PC)** jack on the TV.
- 2 Connect PC audio output to the **AUDIO IN (RGB/DVI)** jack on the TV.

2. How to use

- Turn on the PC and the TV.
- Select the **RGB-PC** input source on the TV using the **INPUT** button on the remote control.

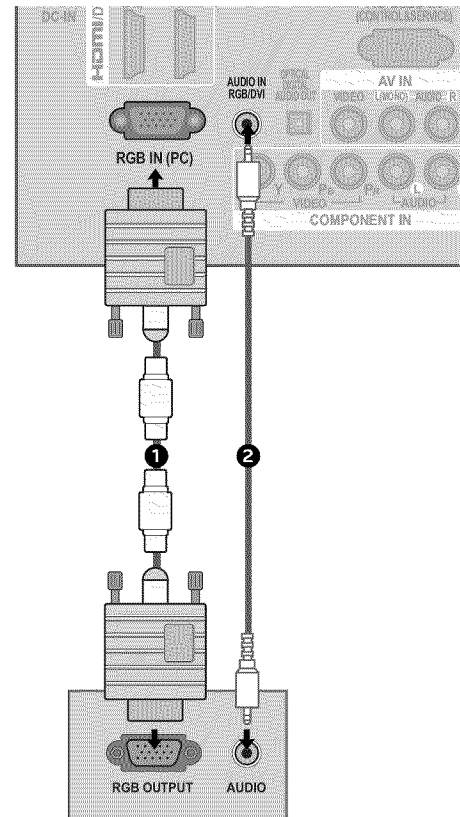

EXTERNAL EQUIPMENT SETUP

DVI to HDMI Connection

1. How to connect

- 1 Connect the DVI output of the PC to the **HDMI/DVI IN 1** or **2*** jack on the TV.
- 2 Connect the PC audio output to the **AUDIO IN (RGB/DVI)** jack on the TV.

2. How to use

- Turn on the PC and the TV.
- Select the **HDMI1** or **HDMI2*** input source on the TV using the **INPUT** button on the remote control.

* *HDMI2: For 32/42/47/55LD520, 42/47/55LD630*

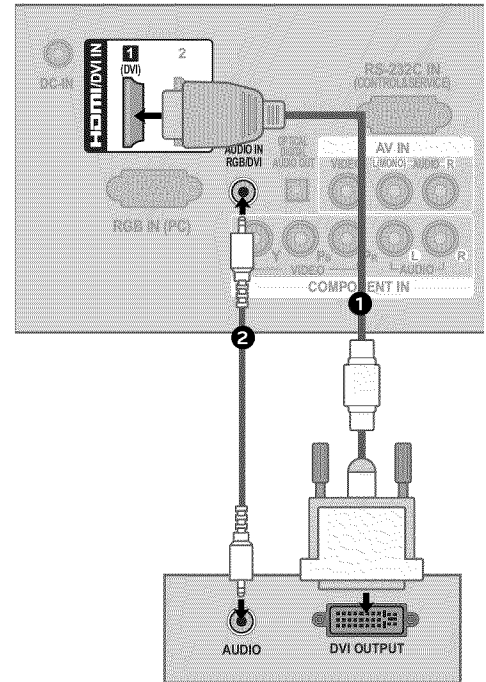

NOTE

- ▶ To get the the best picture quality, adjust the PC graphics card to **1360 x 768** (19/22/26LE5300) or **1920 x 1080** (Other models).
- ▶ Depending on the graphics card, DOS mode may not work if a HDMI to DVI Cable is in use.
- ▶ In PC mode, there may be noise associated with the resolution, vertical pattern, contrast or brightness. If noise is present, change the PC output to another resolution, change the refresh rate to another rate or adjust the brightness and contrast on the PICTURE menu until the picture is clear.
- ▶ Avoid keeping a fixed image on the screen for a long period of time. The fixed image may become permanently imprinted on the screen.
- ▶ The synchronization input form for Horizontal and Vertical frequencies is separate.
- ▶ Depending on the graphics card, some resolution settings may not allow the image to be positioned on the screen properly.
- ▶ When selecting HDMI-PC, set the "Input Label - PC" in the OPTION menu.

Supported Display Specifications (RGB-PC, HDMI-PC)

Resolution	Horizontal Frequency(KHz)	Vertical Frequency(Hz)	
640x350	31.468	70.09	
720x400	31.469	70.08	
640x480	31.469	59.94	
800x600	37.879	60.31	
1024x768	48.363	60.00	
1280x768	47.776	59.87	
1360x768	47.712	60.015	
1280x1024	63.981	60.02	Except 19/22/26LE5300
1600x1200	75.00	60.00	Except 32/37/42/47/55LE5300, 42/47/55LE7300, 22/26LE5500
1920x1080 RGB-PC	66.587	59.934	
1920x1080 HDMI-PC	67.50	60.00	

EXTERNAL EQUIPMENT SETUP

Screen Setup for PC mode







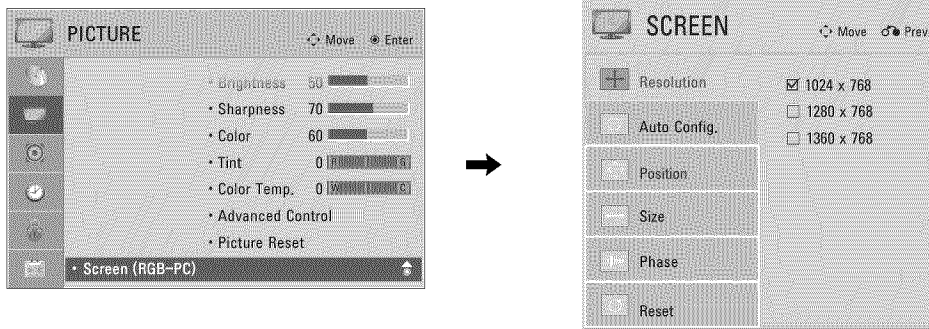

Selecting Resolution

You can choose the resolution in RGB-PC mode.

The Position, Phase, and Size can also be adjusted.

You can choose this option only when the PC resolution is set to 1024X768, 1280X768 or 1360X768.









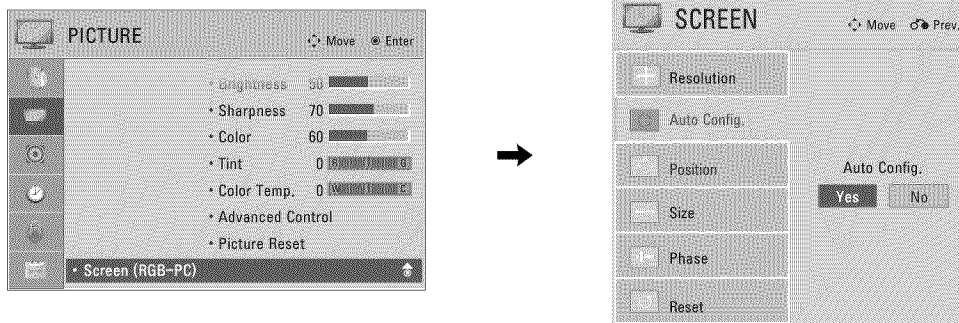

- 1   Select **PICTURE**.
- 2   Select **Screen (RGB-PC)**.
- 3   Select **Resolution**.
- 4   Select the desired resolution.
- 5 

Auto Configure

Automatically adjusts picture position and minimizes image instability. After adjustment, if the image is still not correct, try using the manual settings or a different resolution or refresh rate on the PC.



- 1   Select **PICTURE**.
- 2   Select **Screen (RGB-PC)**.
- 3   Select **Auto Config..**
- 4   Select **Yes**.
- 5  Start Auto Configuration.







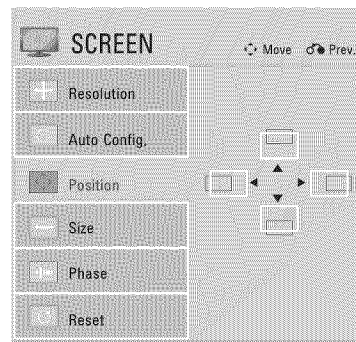
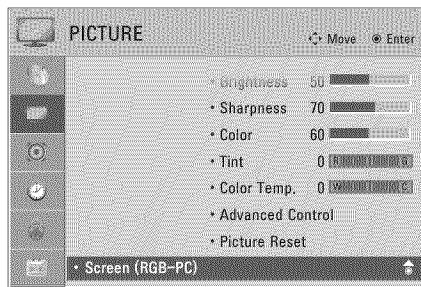

- If the position of the image is still not correct, try Auto adjustment again.
- If picture needs to be adjusted again after Auto adjustment in RGB-PC, you can adjust the **Position**, **Size** or **Phase**.

EXTERNAL EQUIPMENT SETUP

Adjustment for screen Position, Size, and Phase

If the picture is not clear after auto adjustment or if text is shaking, adjust the picture phase manually. This feature operates only in RGB-PC mode.











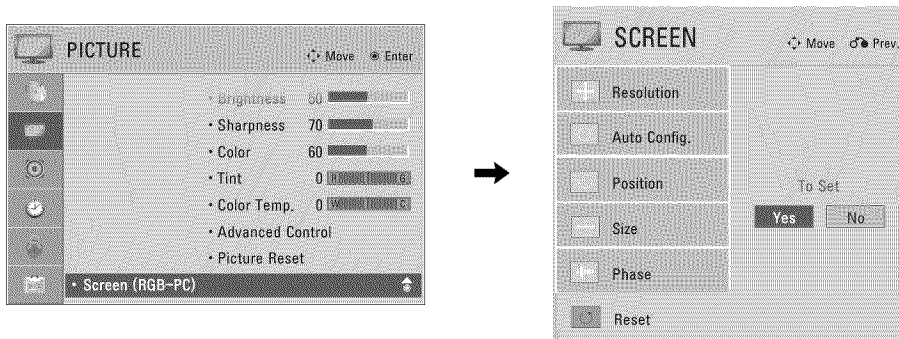

1.   Select **PICTURE**.
2.   Select **Screen (RGB-PC)**.
3.   Select **Position, Size, or Phase**.
4.   Make appropriate adjustments.
5. 

- **Position:** This function is to adjust picture to left/right and up/down as you prefer.
- **Size:** This function is to minimize any vertical bars or stripes visible on the screen background. And the horizontal screen size will also change.
- **Phase:** This function allows you to remove any horizontal noise and clear or sharpen the image of characters.

Screen Reset (Reset to original initial values)

Returns **Position**, **Size**, and **Phase** to the default initial settings.
This feature operates only in RGB-PC mode.



- 1   Select **PICTURE**.
- 2   Select **Screen (RGB-PC)**.
- 3   Select **Reset**.
- 4   Select **Yes**.
- 5  Start **Reset**.

WATCHING TV / CHANNEL CONTROL

REMOTE CONTROL FUNCTIONS

When using the remote control, aim it at the remote control sensor on the TV.
The remote control may differ from the images below.

POWER	Turns the TV on from standby or off to standby.
ENERGY SAVING	Adjusts the Energy Saving setting. ▶ p.104
AV MODE	Toggles through preset Video and Audio modes. ▶ p.75
INPUT	Rotates through inputs. Also switches the TV on from standby. ▶ p.70
TV	Returns to the last TV channel.
NUMBER button	
– (DASH)	Used to enter a program number for multiple program channels such as 2-1, 2-2, etc.
LIST	Displays the channel table. ▶ p.67
FLASHBK	Tunes to the last channel viewed.
MENU	
MENU	Displays the main menu or clears all on-screen displays and return to TV viewing.
INFO	Displays channel information at the bottom of the screen.
Q.MENU	Opens the list of Quick Menu options. ▶ p.59
THUMBSTICK (Up/Down/Left Right/ENTER)	Navigates the on-screen menus and adjusts the system settings to your preference.
BACK	Allows the user to move return one step in an interactive application or other user interaction function.
SIMPLINK	See a list of AV devices connected to TV. When you toggle this button, the SIMPLINK menu appears at the screen. ▶ p.76
EXIT	Clears all on-screen displays and return to TV viewing.

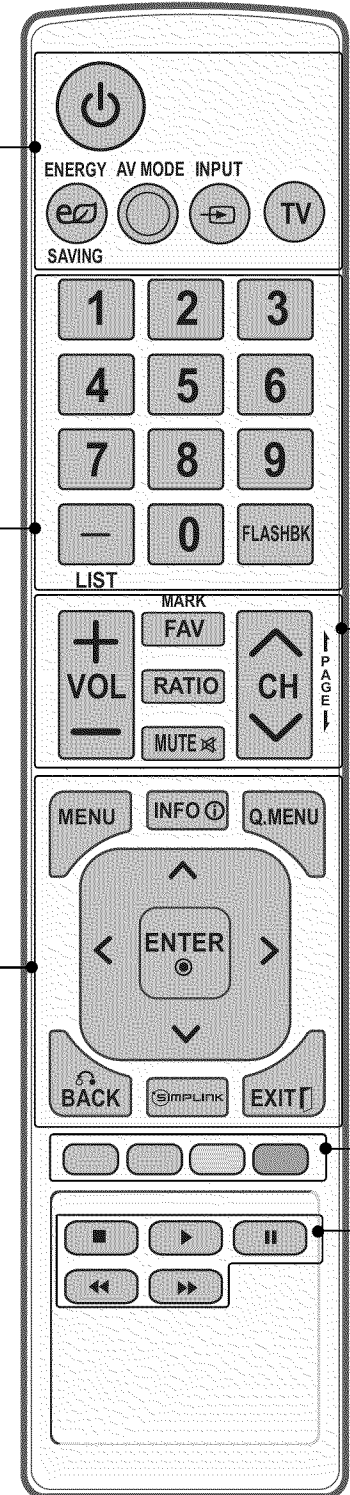

**VOLUME
UP/DOWN**

Adjusts the volume.

FAV Scroll through the programmed Favorite channels. ▶ **p.66**

MARK Select the input to apply the Picture Wizard settings. ▶ **p.103**
Use to mark or unmark a photo/music/movie. ▶ **p.83, 88, 94**

RATIO Changes the aspect ratio. ▶ **p.100**

MUTE Switches the sound on or off. ▶ **p.54**

**CHANNEL
UP/DOWN**

Changes the channel.

**PAGE
UP/DOWN**

Moves from one full set of screen information to the next one.

**COLOR
BUTTON**

Access special functions in some menus.

**USB,
SIMPLINK
Control
buttons**

- Controls MY MEDIA menu (Movie List, Photo List, Music List)
- Controls the SIMPLINK compatible devices.

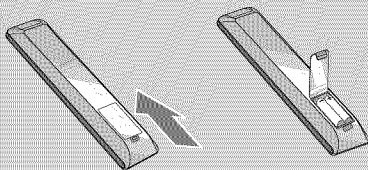
Installing Batteries

- Open the battery compartment cover on the back side and install the batteries matching correct polarity.
- Install two 1.5V AAA batteries. Don't mix old or used batteries with new ones.
- Close cover.

WATCHING TV / CHANNEL CONTROL

TURNING ON THE TV

- 1 First, connect power cord correctly.
At this moment, the TV switches to standby mode.
 - In standby mode to turn TV on, press the **⏻** / **I**, **INPUT**, **CH (▲ or ▼)** button on the TV or press the **⏻**, **INPUT**, **CH (▲ or ▼)**, **Number (0-9)** button on the remote control.
- 2 Select the viewing source by using the **INPUT** button on the remote control.
- 3 When finished using the TV, press the **POWER** button on the remote control. The TV reverts to standby mode.

NOTE

- ▶ If you intend to be away on vacation, disconnect the power plug from the wall power outlet.
- ▶ If you do not complete the **Initial setting**, it will appear whenever the TV is switched on until the **Initial setting** procedure is completed.

CHANNEL SELECTION

- 1 Press the **CH (▲ or ▼)** or **NUMBER** buttons to select a channel number.

VOLUME ADJUSTMENT

Adjust the volume to suit your personal preference.

- 1 Press the **VOL (+ or -)** button to adjust the volume.
- 2 If you want to switch the sound off, press the **MUTE** button.
- 3 You can cancel the Mute function by pressing the **MUTE** or **VOL (+ or -)** button.

INITIAL SETTING

This Function guides the user to easily set the essential items for viewing the TV for the first time when purchasing the TV. It will be displayed on the screen when turning the TV on for the first time. It can also be activated from the user menus.

- Default selection is "**Home Use**". We recommend setting the TV to "**Home Use**" mode for the best picture in your home environment.
- "**Store Demo**" Mode is only intended for use in retail environments. Customers can adjust the "**Picture** menu - **Picture mode**" manually while inspecting the TV, but the TV will automatically return to preset in-store mode after 5 minutes.
- "**Store Demo**" Mode is an optimal setting for displaying at stores. "Store Demo" mode initializes the TV to set the image quality:

Step 1. Selecting Language

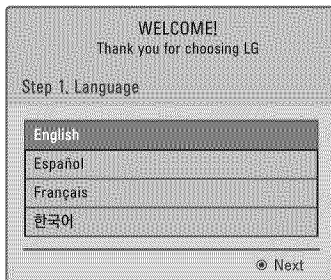

1 Select Menu Language.



Step 2. Mode setting

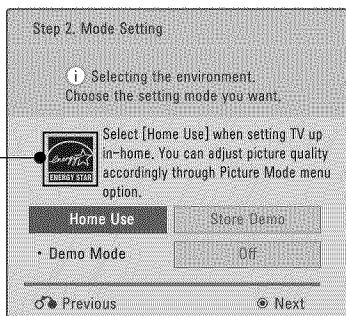

1 Select **Home Use**.





For 19/22/26/37/42/47/55LE5300, 22/26LE5500,
42/47/55LE7300, 37/42/47LD450C

WATCHING TV / CHANNEL CONTROL

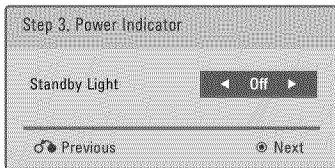
Step 3. Power Indicator (For LED LCD TV)





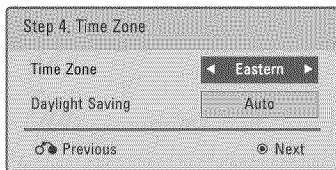

- 1  Select **On** or **Off**.
- 2 

■ This function is disabled in "Step2. Mode Setting - Store Demo".

Step 4. Time Zone



- 1  Select **Time Zone** option.
- 2   Select **Daylight Saving** option.
- 3 

Step 5. Auto Tuning

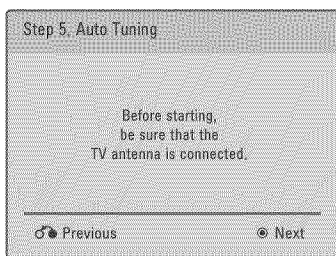

- 1  Check your antenna connection and start **Auto Tuning**.

ON-SCREEN MENUS SELECTION

Your TV's OSD (On Screen Display) may differ slightly from that shown in this manual.

1   Display each menu.

2   Select a menu item.

3  Accept the current selection.

4  Return to TV viewing.

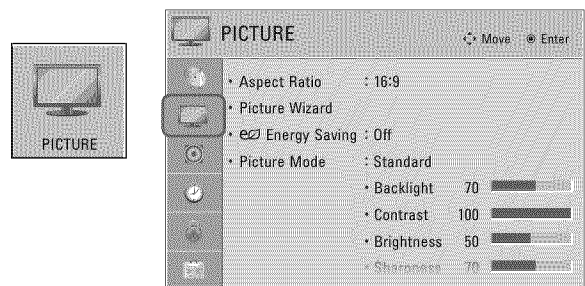

For USA

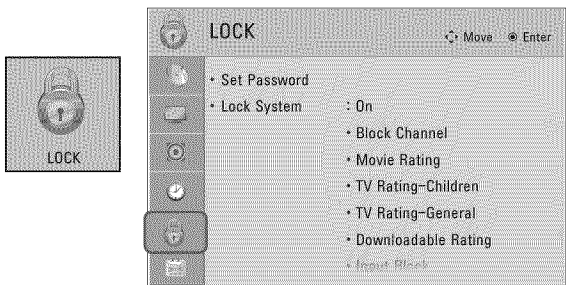

For Canada

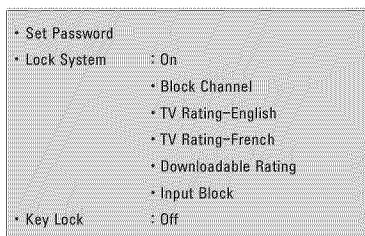

WATCHING TV / CHANNEL CONTROL

i.e)

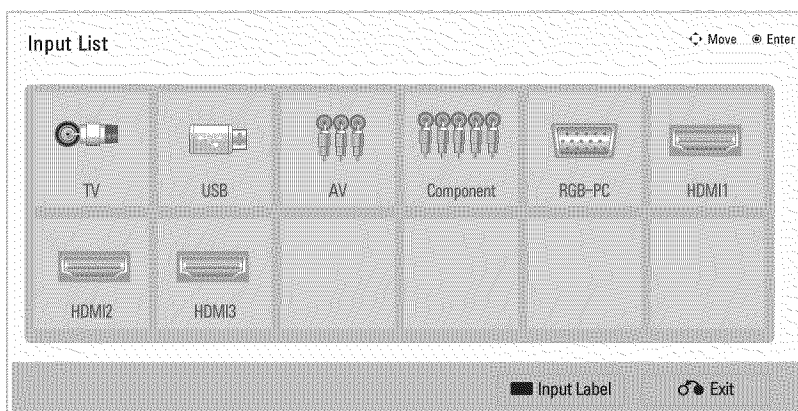
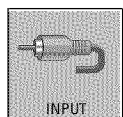









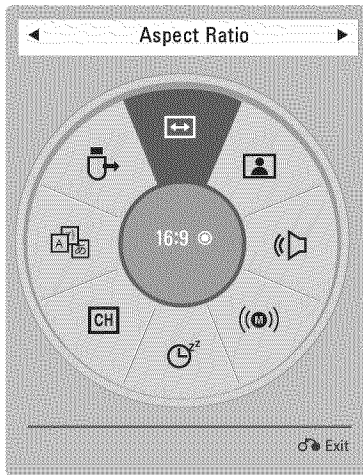

Except 32/42/47LD420,
32/37/42/47LD450,
37/42/47LD450C,
32/42/47/55LD520





QUICK MENU

Your TV's OSD (On Screen Display) may differ slightly from what is shown in this manual.

Q.Menu (Quick Menu) is a menu of features which users might use frequently.



-  **Aspect Ratio:** Selects your desired picture format.
-  **Picture Mode:** Selects the desired preset picture setting.
-  **Sound Mode:** Selects the desired preset sound setting.
-  **Multi Audio:** Changes the audio language (Digital signal).
-  **SAP:** Selects MTS sound (Analog signal).
-  **Sleep Timer:** Select the amount of time before your TV turns off automatically.
-  **Del/Add:** Select channel you want to add or delete.
-  **Caption:** Select on or off.
-  **USB Device:** Select "Eject" in order to eject a USB device.

- 1   Display each menu.
- 2   Make appropriate adjustments.
- 3  Return to TV viewing.







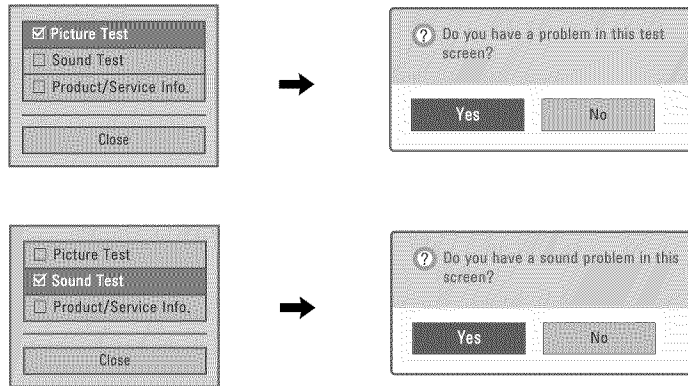

WATCHING TV / CHANNEL CONTROL

CUSTOMER SUPPORT

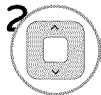
Picture Test / Sound Test

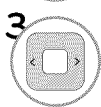
This function is a customer support function that can execute picture and sound tests.







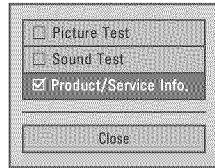

-   Select **Customer Support**.
-   Select **Picture Test** or **Sound Test**.
-   Select **Yes**.
-  Return to the previous menu.
-  Return to TV viewing.

Product/Service Info.

This function shows support and product information.
Customer Service Center can differ by country.



-
- 1   Select **Customer Support**.
 - 2   Select **Product/Service Info.**
You can check the various product/Service information based on your model.
 - 3  Return to the previous menu.
 -  Return to TV viewing.

WATCHING TV / CHANNEL CONTROL

SIMPLE MANUAL

You can easily and effectively access the TV information by viewing a simple manual on the TV. During the Simple Manual operation, audio will be muted.

1   Select **Simple Manual**.

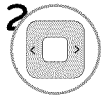
2  Select the part of the manual you would like to see.

 Go to the **Index** page.

 Play the **Simple Manual** automatically or manually.

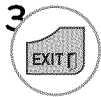
3  Return to TV viewing.

CHANNEL SETUP







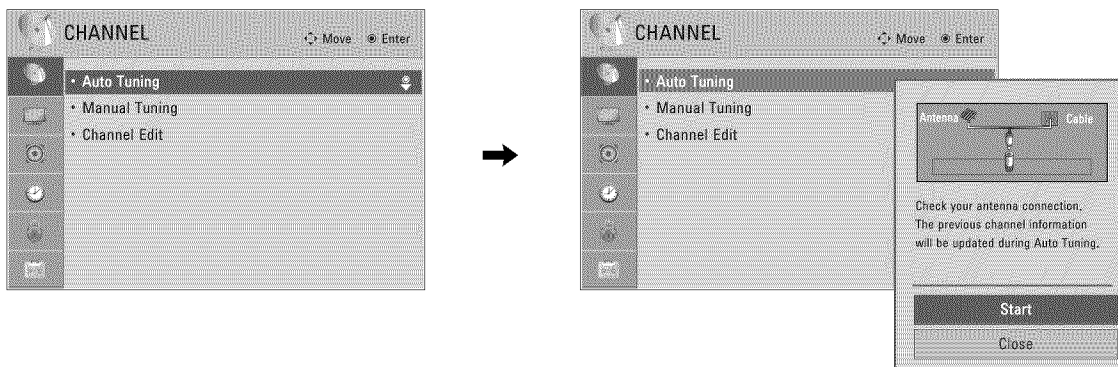

Auto Scan (Auto Tuning)

Automatically finds all channels available through antenna or cable inputs, and stores them in memory on the channel list.

Run this function if you change your residence or move the TV.

Auto Tuning memorizes only the channels available at the time.



- 1   Select **CHANNEL**.
- 2   Select **Auto Tuning**.
- 3   Select **Start**.
- 4  Run **Auto tuning**.
- 5  Return to the previous menu.
-  Return to TV viewing.

- The TV will ask for a password if parental control has been activated (LOCK Menu). Use the password you set up in the LOCK Menu to allow a channel search.
- The maximum number of channels the TV can store is 1000.
- Found channels are grouped in the order of DTV, TV, Cable DTV and Cable TV.

WATCHING TV / CHANNEL CONTROL

Add/Delete Channel (Manual Tuning)

When selecting DTV or Cable DTV input signal in **Manual Tuning**, you can view the on-screen signal strength monitor to see the quality of the signal being received.

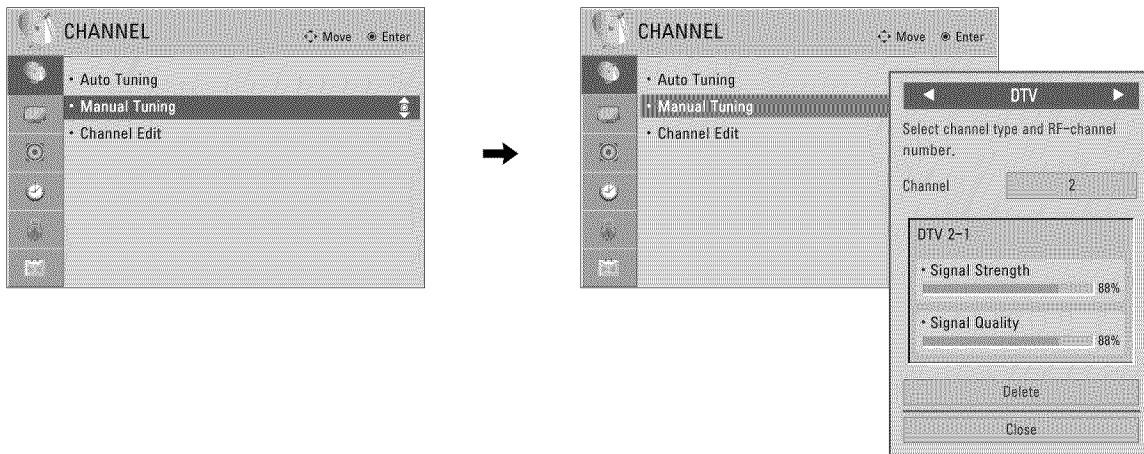

-   Select **CHANNEL**.
-   Select **Manual Tuning**.
-   Select **DTV, TV, Cable DTV,** or **Cable TV**.
-   Select channel you want to add or delete.
-   Select **Add** or **Delete**.
-  Return to the previous menu.
-  Return to TV viewing.

- The TV will ask for a password if parental control has been activated (LOCK Menu). Use the password you set up in the LOCK Menu to allow a channel search.
- The maximum number of channels the TV can store is 1000.

Channel Editing

The channels in the Channel Edit List are displayed in black and the channels deleted from the Channel Edit List are displayed in blue.

When a channel number is deleted, it means that you will be unable to select it using CH \wedge \vee button during TV viewing. If you wish to select the deleted channel, directly enter the channel number with the NUMBER buttons or select it in the Channel Edit menu.

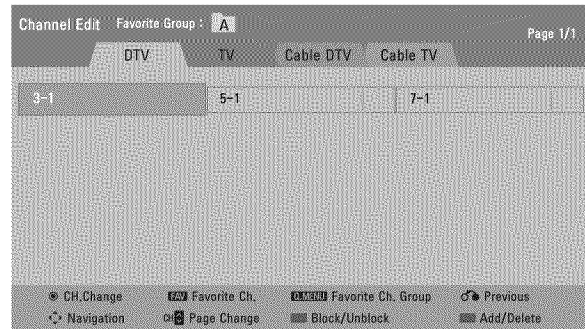

Block or unblock the channel.

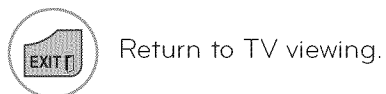
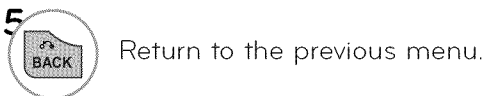
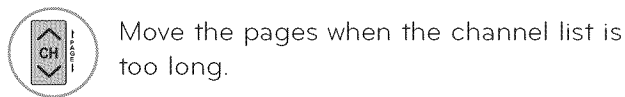
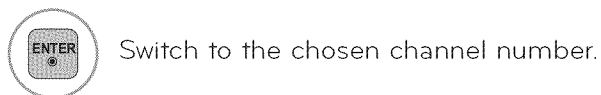
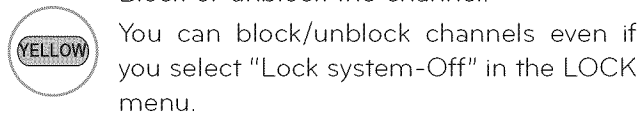





- Keep pressing the \wedge button and use the \leftarrow or \rightarrow buttons to move between DTV, TV, Cable DTV and Cable TV.

WATCHING TV / CHANNEL CONTROL

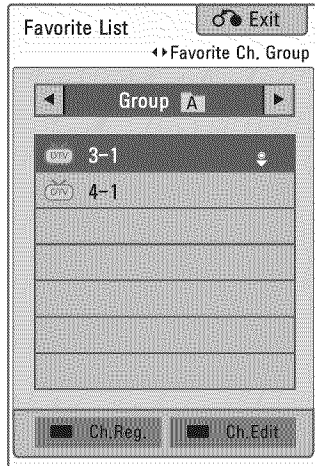
FAVORITE CHANNEL SETUP

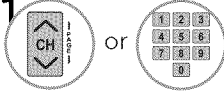
Favorite Channels are a convenient feature that lets you quickly select channels of your choice without waiting for the TV to select all the in-between channels.



- 1  Select your desired channel.
- 2  Select your desired favorite channel group from A to D.
- 3  Register or cancel the current channel in favorite channel list.
-  Go to the "CHANNEL menu - Channel Edit".
- 4  Return to TV viewing.

■ You can also setup **Favorite List** in the **CHANNEL** menu - **Channel Edit**.

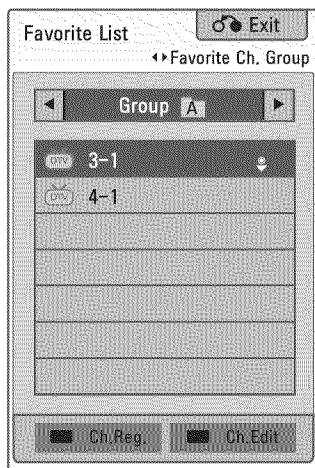

FAVORITE CHANNEL LIST





Displaying the favorite channel list

- 1  Display the Favorite channel list.

Selecting a channel in the favorite channel list

- 1  Select a channel.
- 2  Switch to the chosen channel number.

Paging through a favorite channel list

- 1  Turn the pages.
- 2  Return to TV viewing.

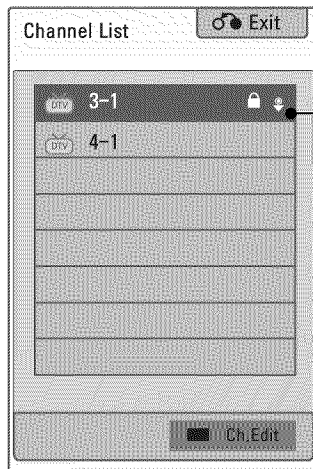

CHANNEL LIST

You can check which channels are stored in the memory by displaying the channel list.





This padlock is displayed when the channel is locked with parental control.

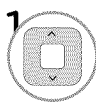

Displaying Channel List

-  Display the **Channel List**.
-  Tune to the "CHANNEL menu - Channel Edit".

Selecting a channel in the channel list

-  Select a channel.
-  Switch to the chosen channel number.

Paging through a channel list



-  Turn the pages.
-  Return to TV viewing.

WATCHING TV / CHANNEL CONTROL

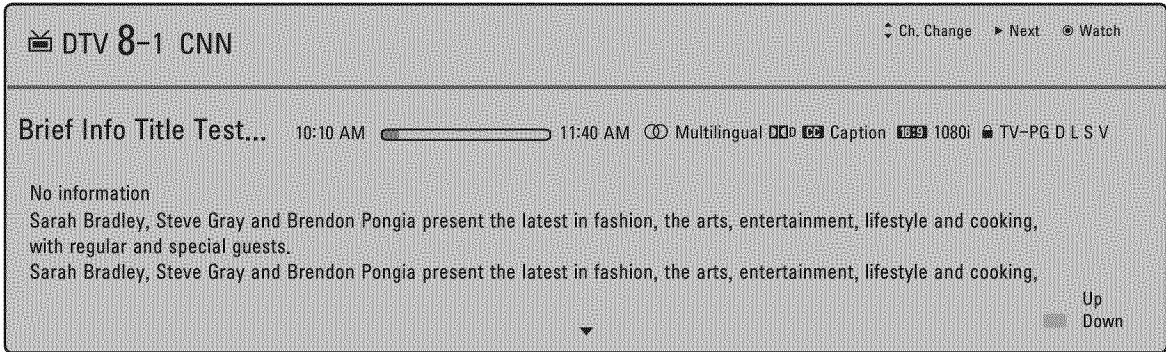
CHANNEL INFORMATION



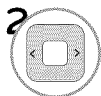

Displaying Channel Information

-  Show the current channel program Information on the screen.
-  Show a previous or next channel's program information
-  Return to TV viewing.









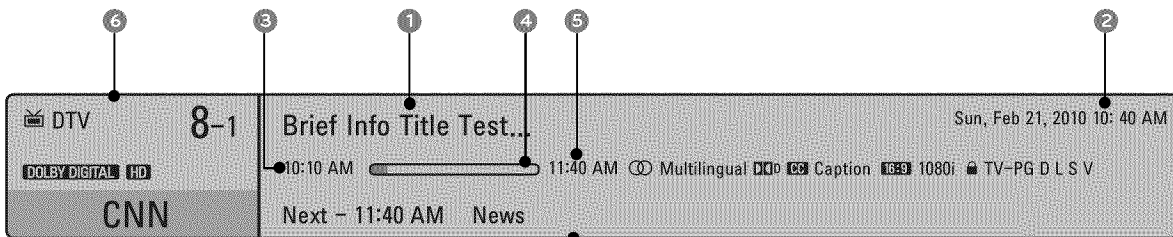

CHANNEL BRIEF INFORMATION

Brief Info shows the present screen information.

1  Shows the current channel's brief info screen.

2  Return to TV viewing.



	Multilingual : The program contains two or more audio services. Use the Q.MENU menu to select wanted Audio.
	Caption : The program contains one or more caption services. Use the Q.MENU menu to select wanted Closed caption.
	Dolby Digital : The program contains a Dolby Digital audio signal in TV and HDMI input source.
	The original aspect ratio of the video is 4:3
	The original aspect ratio of the video is 16:9 (wide)
	The video resolution is 720x480i
	The video resolution is 720x480p
	The video resolution is 1280x720p
	The video resolution is 1920x1080i
	The video resolution is 1920x1080p
	V-Chip : The program contains V-Chip information. Refer to the LOCK menu: A (Age), D (Dialogue), L (Language), S (Sex), V (Violence), FV (Fantasy Violence)

- 1 Program title
- 2 Day, Month, Year, Present time
- 3 Program start time
- 4 Program progress bar
- 5 Program finish time
- 6 Banner information

WATCHING TV / CHANNEL CONTROL

INPUT LIST

Only these input signals which are connected to a TV can be activated and selected.

ie)

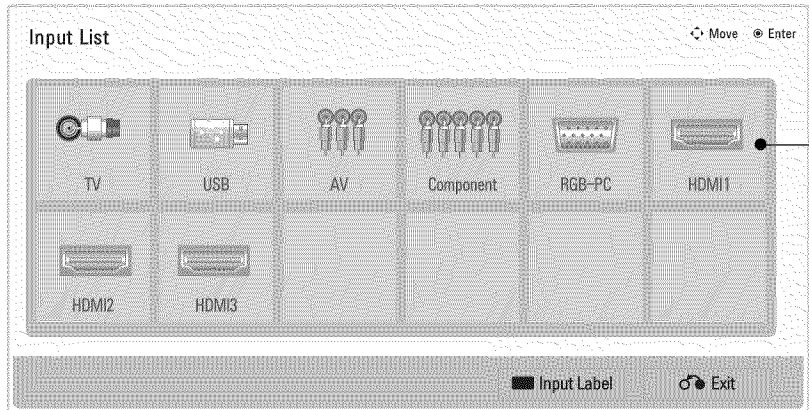

Disconnected inputs are inactive (grayed out)

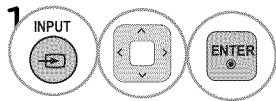

Select the desired input source.

- When new external device is connected, this popup menu is displayed automatically. If selecting **Yes**, you can select input source that you want to appreciate.
- But, when selecting "**SIMPLINK - On**", popup menu for HDMI input will not be displayed.

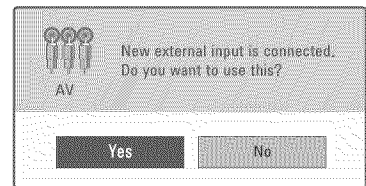





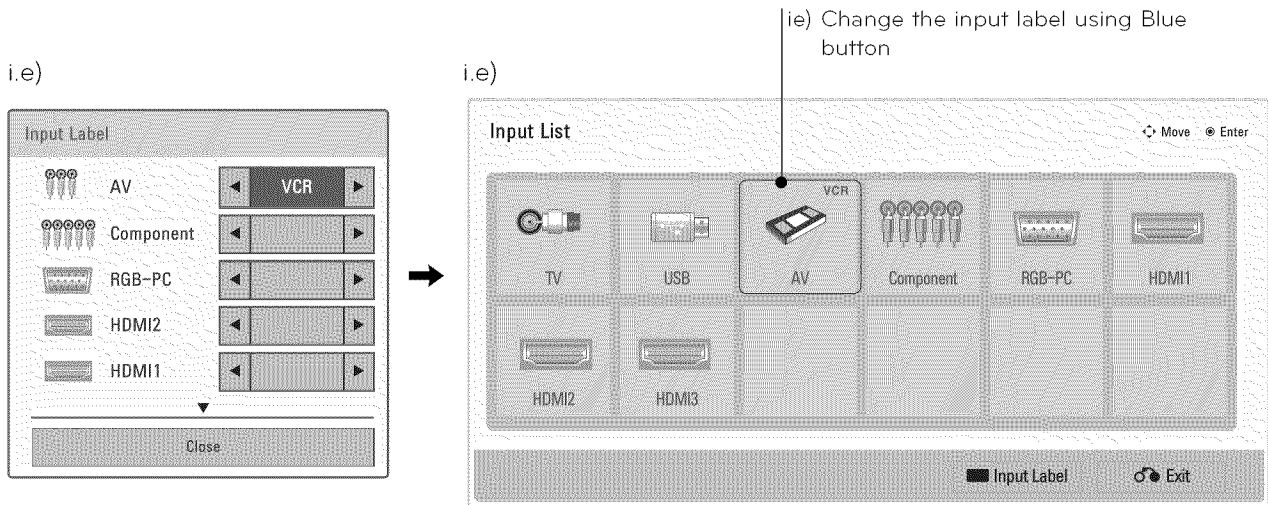

- **TV**: Select it to watch over-the-air, cable and digital cable broadcasts.
- **AV**: Select them to watch a VCR or other external equipment.
- **Component**: Select them to watch DVD or a Digital set-top box.
- **RGB-PC**: Select it to view PC input.
- **HDMI**: Select them to watch high definition devices.

INPUT LABEL

This indicates which device is connected to which input port.









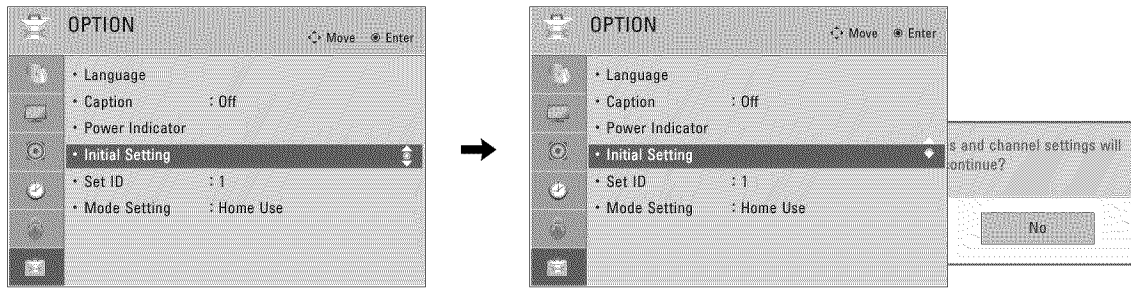

- 1   Select the desired input source.
- 2   Select the label.
- 3  Return to the previous menu.
-  Return to TV viewing.

WATCHING TV / CHANNEL CONTROL

RESET TO FACTORY DEFAULT (INITIAL SETTING)

This function resets the TV to factory default and erases all stored channels.



-   Select **OPTION**.
-   Select **Initial Setting**.
-   Select **Yes**.
-  TV turns off automatically and starts factory reset.

■ When selecting "**Lock System - On**" in the LOCK menu, the message to enter the password appears.







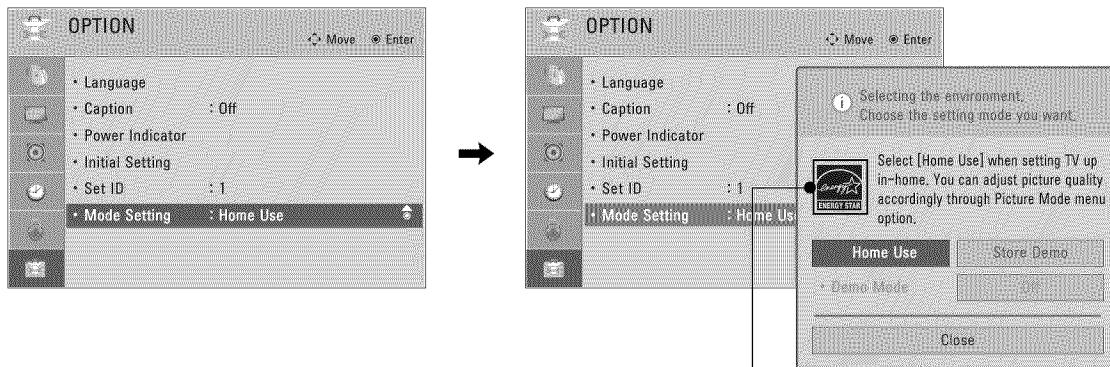

■ If you forget your password, press "0-3-2-5" on the remote control.

MODE SETTING

Default selection is "Home Use". We recommend setting the TV to "Home Use" mode for the best picture in your home environment.



For 19/22/26/37/42/47/55LE5300,
22/26LE5500, 42/47/55LE7300,
37/42/47LD450C

- 1   Select **OPTION**.
- 2   Select **Mode Setting**.
- 3   Select **Home Use**.
- 4  Return to the previous menu.
-  Return to TV viewing.



- "Store Demo" Mode is only intended for use in retail environments. Customers can adjust the "Picture menu - **Picture mode**" manually while inspecting the TV, but the TV will automatically return to preset in-store mode after 5 minutes.
- "Store Demo" Mode is an optimal setting for displaying at stores. "Store Demo" mode initializes the TV to set the image quality:

WATCHING TV / CHANNEL CONTROL

DEMO MODE

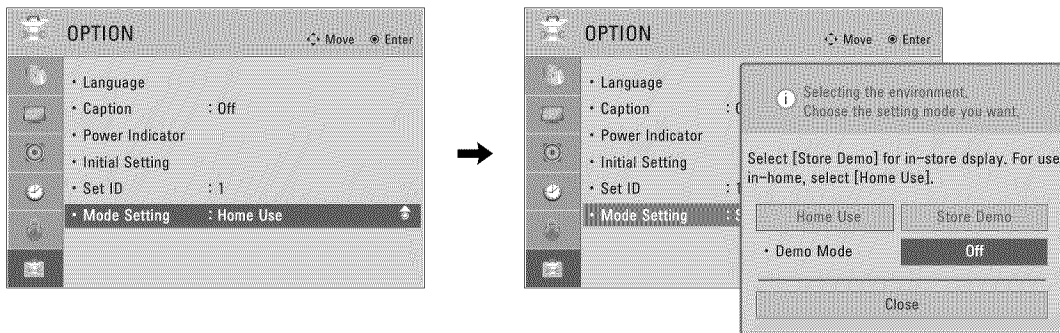
Displays a slide show to explain the various feature of this TV.

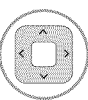

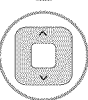
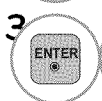
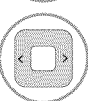
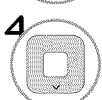
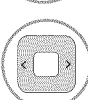
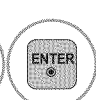
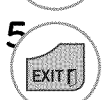
-   Select **OPTION**.
-   Select **Mode Setting**.
-   Select **Store Demo**.
-    Select **On**.
-  Return to TV viewing.
After a while, **Demo Mode** starts.
If you want to stop the demo, press any button (Except VOL +, - and MUTE button).

AV MODE

AV Mode toggles through preset Video and Audio settings.

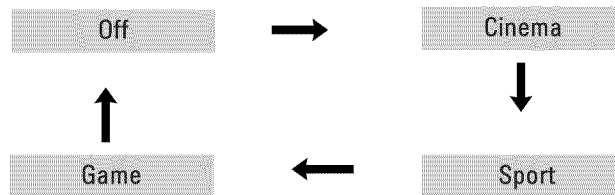

1 Press the **AV MODE** button repeatedly to select the desired source.



- If you select "**Cinema**" in AV mode, **Cinema** will be selected both for "PICTURE menu - Picture Mode" and "AUDIO menu - Sound Mode" respectively.
- If you select "**Off**" in AV mode, the "**Picture Mode**" and "**Sound Mode**" return to previous selected value.
- **Off**: Disables the AV MODE.
- **Cinema**: Optimizes video and audio for watching movies.
- **Sport**: Optimizes video and audio for watching sports events.
- **Game**: Optimizes video and audio for playing games.

WATCHING TV / CHANNEL CONTROL

SIMPLINK

SIMPLINK allows you to control and play other AV devices connected with HDMI cable without additional cables and settings. This TV may work with devices with HDMI-CEC support, but only devices with the SIMPLINK logo are fully supported.

SIMPLINK can be turned on and off in the user menus.



- 1 Display **SIMPLINK** menu.
- 2 Select **On**.
- 3 Select the desired device.
- 4 Control connected AV devices.

- 1 **TV viewing:** Switch to the previous TV channel regardless of the current mode.
- 2 **DISC playback:** Select and play discs. When multiple discs are available, the disc devices are conveniently displayed at the bottom of the screen.
- 3 **VCR playback:** Control the connected VCR.
- 4 **HDD Recordings playback:** Control recordings stored in HDD.
- 5 **Audio Out to Home Theater speaker/ Audio Out to TV:** Select Home Theater speaker or TV speaker for Audio Out.

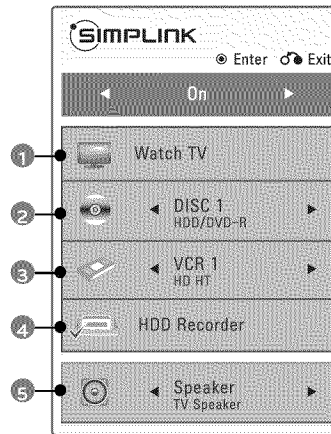

- ▶ When no device is connected (displayed in gray)
- ▶ Selected Device
- ▶ When a device is connected (displayed in bright color)

SIMPLINK Functions

- **Direct Play:** After connecting AV devices to the TV, you can directly control the devices and play media without additional settings.
- **Select AV device:** Enables you to select one of the AV devices connected to the TV.
- **Disc playback:** Control connected AV devices by pressing the **^ v < >**, **ENTER**, **▶**, **■**, **||**, **◀** and **▶▶** buttons.
- **Power off all devices:** When you power off the TV, all connected devices are turned off.
- **Switch audio-out:** Offers an easy way to switch audio-out.
- **Sync Power on:** When the equipment with Simplink function connected HDMI terminal starts to play, The TV will automatically turn on.

Note: To operate SIMPLINK, an HDMI cable over Version 1.3 with *CEC function should be used. (*CEC: Consumer Electronics Control).

(A device, which is connected to the TV through a HDMI cable but does not support SIMPLINK, does not provide this function)

NOTE

- ▶ Connect the HDMI/DVI IN or HDMI IN terminal of the TV to the rear terminal (HDMI terminal) of the SIMPLINK device with the HDMI cable
- ▶ When you switch the Input source with the INPUT button on the remote control, the SIMPLINK device will stop.
- ▶ When you select a device with home theater functionality, the sound output automatically switches to the home theater speakers and the TV speakers are turned off.
- ▶ If a connected SIMPLINK home theater system doesn't play the audio from the TV, connect the DIGITAL AUDIO OUT terminal on the back of the TV to the DIGITAL AUDIO IN terminal on the back of the SIMPLINK device with an OPTICAL cable.

MY MEDIA

CONNECTION METHOD

USB Connection

- 1 Connect the USB device to the **USB IN** jack on the side of TV.

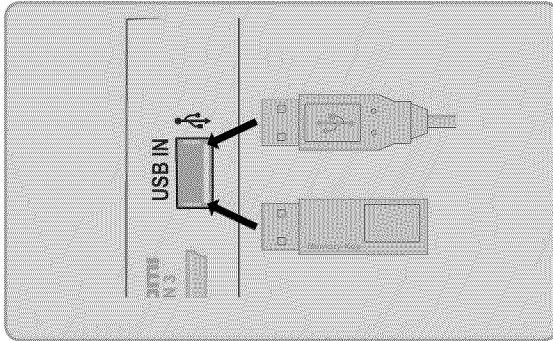

Precautions when using the USB device

- ▶ Only a USB storage device is recognizable.
- ▶ Connecting a USB storage device through a USB hub is not supported.
- ▶ A USB storage device which uses its own driver may not be recognized.
- ▶ The recognition speed of a USB storage device may depend on each device.
- ▶ Please do not turn off the TV or unplug the USB device when the connected USB storage device is working. When such device is suddenly separated or unplugged, the stored files or the USB storage device may be damaged.
- ▶ Only use a USB storage device which has normal music files, image files, or movie files.
- ▶ Please use only a USB storage device which was formatted as a FAT 32 or NTFS file system provided with the Windows operating system. Others may not be recognized.
- ▶ Some USB storage devices require a power adapter. The power adapter must be connected in order to be seen by the TV.
- ▶ If a device is not recognized by the TV, try a different cable. Excessively long cables are not supported.
- ▶ Some USB storage devices may not be supported or operate properly.
- ▶ Please backup important files because data on USB device could be damaged. Data management is consumer's responsibility and as a result, the manufacturer does not cover data damage.
- ▶ If your USB memory device has multiple partitions, or if you use a USB multi-card reader, you can use up to 4 partitions or USB memory devices.
- ▶ In case of USB storage devices formatted as NTFS, deletion is not supported.
- ▶ File alignment method of USB storage device is similar to Window XP and file names can be up to 100 English characters.
- ▶ The recommended capacity is 1TB or less for a USB external hard disk and 32 GB or less for USB memory.
- ▶ If a USB external hard disk with a "Energy Saving" function doesn't work, turn the hard disk off and on again to make it work properly. Refer to the user manual of the USB external hard disk.
- ▶ USB storage devices below USB 2.0 are supported as well. But they may not work properly in the movie list.



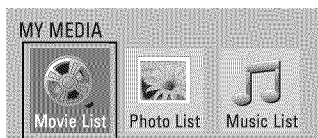

ENTRY MODE

The My Media menu will open automatically when you insert a USB drive. My Media can also be accessed by choosing My Media in the user menu.

On USB device, you can not add a new folder or delete the existing folder.





Except 32/42/47LD420,
32/37/42/47LD450,
37/42/47LD450C,
32/42/47/55LD520

-   Select **MY MEDIA**.
-   Select **Movie List**, **Photo List** or **Music List**.
- 

■ This TV can view JPG image files, HD DivX files or play MP3 audio files.

When removing the USB device

Select the **USB Device** menu before removing the USB device.

-   Select **USB Device**.
-  Select **Eject**.

MOVIE LIST

(Except 32/42/47LD420, 32/37/42/47LD450, 37/42/47LD450C, 32/42/47/55LD520)

The movie list is activated once a USB drive is detected. It is used when playing movie files on the TV. It displays all of the video files it recognizes.

The On-Screen Display on your model may be slightly different.

Supported movie file

- Resolution: under 1920 pixel (width) x 1080 pixel (height)
- Frame Rate: under 30 frame/sec (1920x1080), under 60 frame/sec (1280x720)
- Max bitrate of playable video file: 20 Mbps (Mega bit per second)
- Bit rate : within 32 kbps to 320 kbps (MP3)
- Supported external subtitle format: *.smi/*.srt/*.sub (MicroDVD,Subviewer1.0/2.0)/*.ass/*.ssa/*.txt (TMPlayer)/*.psb (PowerDivX)
- Supported Internal subtitle format: only, XSUB (It is the subtitle format used in DivX6 files)

Precautions when playing the video files

- ▶ Some user-created subtitles may not work properly.
- ▶ Some special characters are not supported in subtitles.
- ▶ HTML tags are not supported in subtitles.
- ▶ Time information in an external subtitle file should be arranged in ascending order to be played.
- ▶ The screen may suffer temporary interruptions (image stoppage, faster playback, etc.) when the audio language is changed.
- ▶ A damaged video file may not be played correctly, or some functions may not be usable.
- ▶ Video files produced with some encoders may not be played correctly.
- ▶ If the video and audio structure of recorded file is not interleaved, the file not playback properly.
- ▶ Video with resolution higher than maximum resolution supported for each frame, cannot be guaranteed for smooth playback.
- ▶ Video files other than the specified types and formats may not work properly.
- ▶ The movie file encoded by the GMC (Global Motion Compensation) is not supported.
- ▶ Only 250 Korean characters, 500 letters and 500 numbers are supported for each line of the subtitle.
- ▶ Only 10000 sync blocks are supported within the subtitle file.
- ▶ We do not guarantee smooth playback of profiles encoded level 4.1 or higher in H.264/AVC.
- ▶ DTS Audio codec is not supported.
- ▶ A video file more than 30GB in file size is not supported for playback.
- ▶ Playing a video via a USB connection that doesn't support high speed may not work properly.
- ▶ USB storage devices below USB 2.0 are supported as well. But they may not work properly in the movie list.
- ▶ The video file and its subtitle file must be located in the same folder.
At this time, a video file name and its subtitle file name must be identical for it to be displayed.
- ▶ When you are watching a movie via the Movie List function, you can adjust the picture with the ENERGY SAVING and AV MODE button on the remote control. User setup for each picture mode is not supported.

Supported Video Formats

File Extension name	Video Decoder	Audio Codec	Max Resolution
mpg, mpeg	MPEG1, MPEG2	MP2, MP3, Dolby Digital, LPCM	1920 x 1080 @ 30p (Only Motion JPEG 640x480@30p)
dat	MPEG1	MP2	
ts, trp, tp	MPEG2, H.264, AVS, VC1	MP2, MP3, Dolby Digital, AAC, HE-AAC	
vob	MPEG1, 2	MP2, MP3, Dolby Digital, LPCM	
mp4, mov	MPEG4, DivX 3.11, DivX 4.12, DivX 5.x, DivX 6, Xvid 1.00, Xvid 1.01, Xvid 1.02, Xvid 1.03, Xvid 1.10-beta1/2H.264	AAC, HE-AAC, MP3	
mkv	H.264, MPEG-1,2,4	MP2, MP3, Dolby Digital, AAC HE-AAC, LPCM	
divx, avi	MPEG2, MPEG4, DivX 3.11, DivX 4, DivX 5, DivX 6, Xvid 1.00, Xvid 1.01, Xvid 1.02, Xvid 1.03, Xvid 1.10-beta1/2H.264	MP2, MP3, Dolby Digital, LPCM, ADPCM, AAC, HE-AAC	
Motion JPEG (avi, mp4, mkv)	JPEG	LPCM, ADPCM	
asf, wmv	VC1	WMA	
flv	Sorenson H.263, H264	MP3, AAC	

MY MEDIA

Screen Components

MY MEDIA



- ① Moves to upper level folder
- ② Current page/Total pages
- ③ Corresponding buttons on the remote control
- ④ Contents under the folder focused on
- ⑤ Current page/total pages of contents

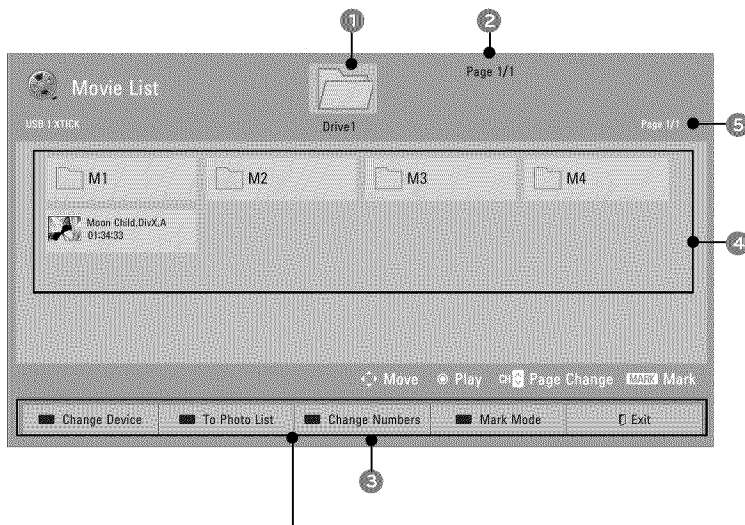

GREEN	Move to Photo List or Music List .
YELLOW	Change Numbers: Changes the number or thumbnails displayed at a time.
BLUE	Allows you to mark certain files.
EXIT	Return to TV viewing.

Movie Selection

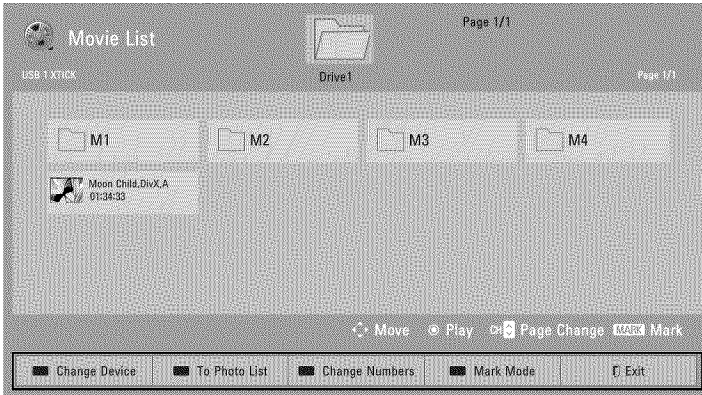

- 1 Select the target folder or drive.
- 2 Select the desired movie title.
- 3 Play the movie file.

■ Use the CH (^ v) button to navigate in the movie page.

Mark Mode

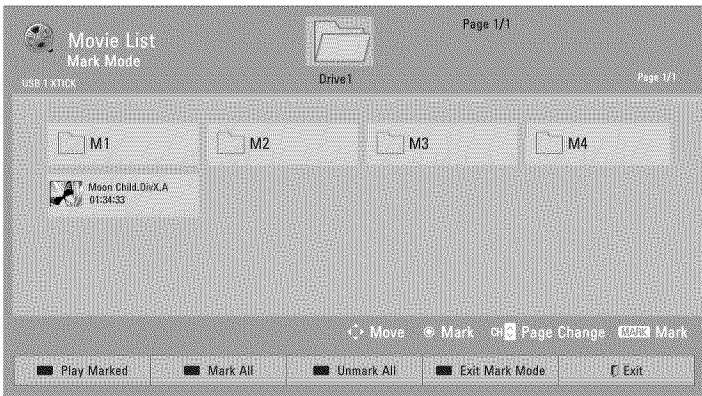

- 1 Select the target folder or drive.
- 2 Select the desired movie title.
- 3 Mark your desired movie file.
- 4 Play the marked movie file.
It displays the current movie status progress bar on the bottom of the screen.

RED	Play Marked: Play the first selected file. Once a movie finishes playing, the next selected one will be played automatically.
GREEN	Mark All: Mark all files in the folder.
YELLOW	Unmark All: Deselect all marked files.
BLUE	Exit the Mark Mode.

■ When one or more movie files are marked, the marked movies will be played in sequence.

MY MEDIA

Using the Movie List Function

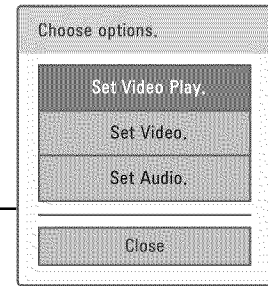
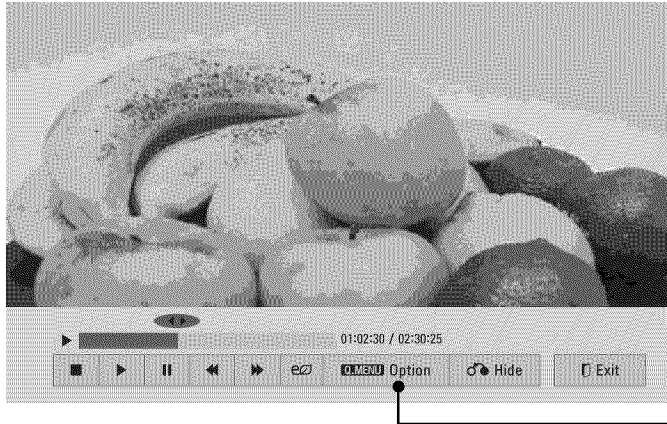

MY MEDIA

- 1 Show the **Option** menu.
- 2 Select **Set Video Play**, **Set Video.**, or **Set Audio.**

NOTE

- ▶ Option values changed in the Movie List does not affect Photo List and Music List.
- ▶ Option values changed in Photo List and Music List are changed likewise in Photo List and Music List, but not in the Movie List.
- ▶ When replaying a video file after stopping, you can play from where it stopped automatically.
- ▶ If you select "Yes" when playing the same file after the video file has been stopped, it will restart where it stopped previously.
- ▶ If continuous series files exist within the folder, the next file will automatically be played. But, this excludes cases when the Repeat function of Movie List Option is turned "On" (Refer to page 85) or when set as **Marked Play**.

Using the remote control

	Return to TV viewing.
	Select the required speed: x2, x4, x8, x16, x32 (backward/forward).
	Pauses the media player. If no buttons are pressed on the remote control for 10 minutes after pausing, the TV returns to the playback state.
	Displays a slow motion.
	Move to a specific frame forward or backward while playing a video. A cursor indicating the position can be viewed on the screen. It may not work properly for some movie files.
	Return to normal playback.
	Hide the menu on screen. To see the menu again, press ENTER button to display.
	Press the ENERGY SAVING button repeatedly to increase the brightness of your screen (Refer to p. 104).
	Press the AV MODE button repeatedly to select the desired source (Refer to p. 75).

Set Video Play Menu Options

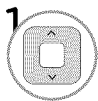
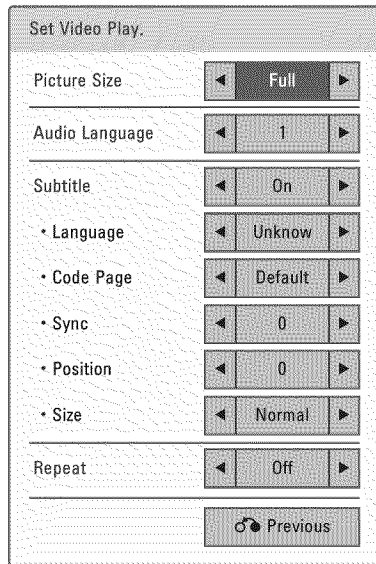

1 Select **Picture Size**, **Audio Language**, **Subtitle**, or **Repeat**.

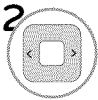

2 Make appropriate adjustments.

Code Page

Subtitle Language Group	Supported Language
Latin1	English, Spanish, French
Korean	English, Korean

- **Picture Size:** Selects your desired picture format for videos.
- **Audio Language:** Changes the Language Group of the audio for video files.
- **Subtitle Language:** The subtitles can be turned on or off. If there are two or more subtitles, you can select one of them.
- **Language:** Activated for SMI subtitles and can select the language within the subtitle.
- **Code Page:** Subtitle font selection. When set to default, same font as general menu will be used.
- **Sync:** When the video is not synchronized with the captions, it can be adjusted by 0.5 second.
- **Position:** Move the location of the subtitles.
- **Size:** Changes the subtitle font size.
- **Repeat:** Turn on/off repeat function of movie playback. When turned on, the file within the folder will be played back repeatedly.

MY MEDIA

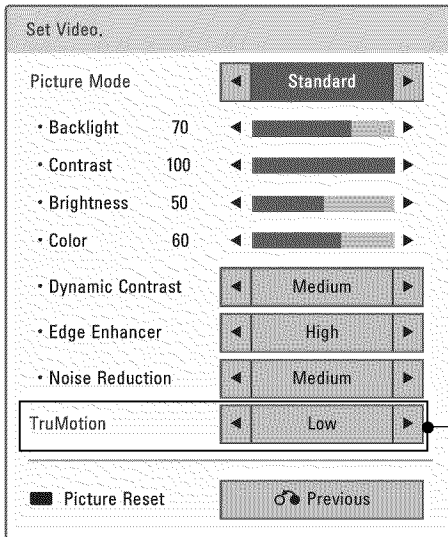

* Image shown may differ from your TV.

Set Video Menu Options

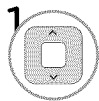
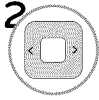

('TruMotion' dependent on model)

MY MEDIA

-  Select **Picture Mode** or **TruMotion**.
-  Make appropriate adjustments.
-  Reset picture settings to default.

Set Audio Menu Options

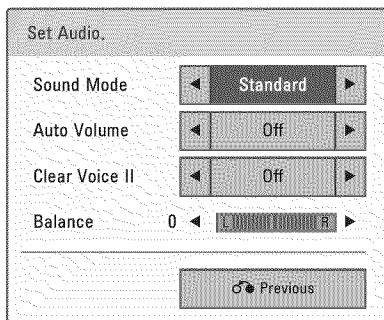



-  Select **Sound Mode**, **Auto Volume**, **Clear Voice II** or **Balance**.
-  Make appropriate adjustments.

PHOTO LIST

The On-Screen Display on your model may be slightly different.

Supported photo file: *.JPG

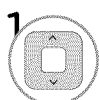
- Baseline: 64 pixel (width) x 64 pixel (height) to 15360 pixel (width) x 8640 pixel (height)
- Progressive: 64 pixel (width) x 64 pixel (height) to 1920 pixel (width) x 1440 pixel (height)
- You can play JPEG files only.
- Non-supported files are displayed in the form of predefined icon.

Screen Components



- ① Moves to upper level folder
- ② Current page/total pages
- ③ Corresponding buttons on the remote control
- ④ Contents under the folder focused on ①
- ⑤ Current page/total pages of contents

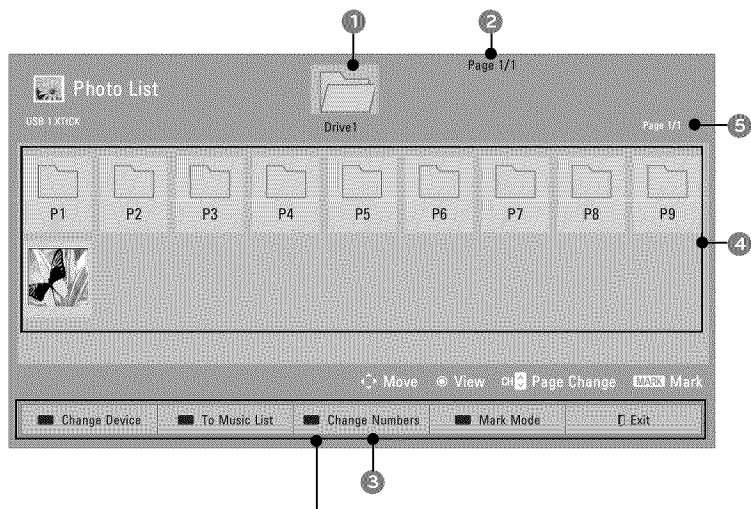



GREEN	Move to Music List or Movie List .
YELLOW	Change Numbers: Changes the number or thumbnails displayed at a time.
BLUE	Allows you to mark certain files.
EXIT	Return to TV viewing.

MY MEDIA

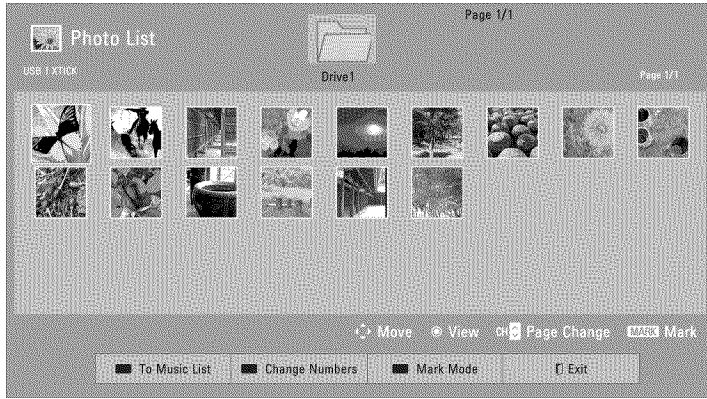
Photo Selection









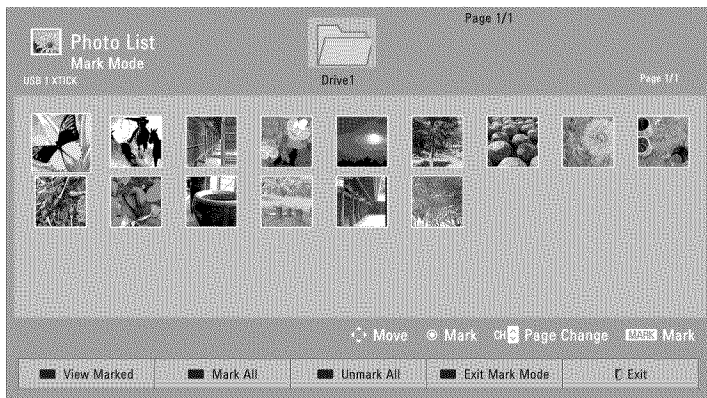

- 1  Select the target folder or drive.
- 2   Select the desired photos.
- 3  Photo file is displayed.

■ Use the CH (^ v) button to navigate in the photo page.

Mark Mode



- 1  Select the target folder or drive.
- 2   Select the desired photo files.
- 3  Mark your desired photo files.
- 4  View the marked photo files.

	View Marked: Display the selected photo.
	Mark All: Mark all photos on the screen.
	Unmark All: Deselect all marked photos.
	Exit the Mark Mode.



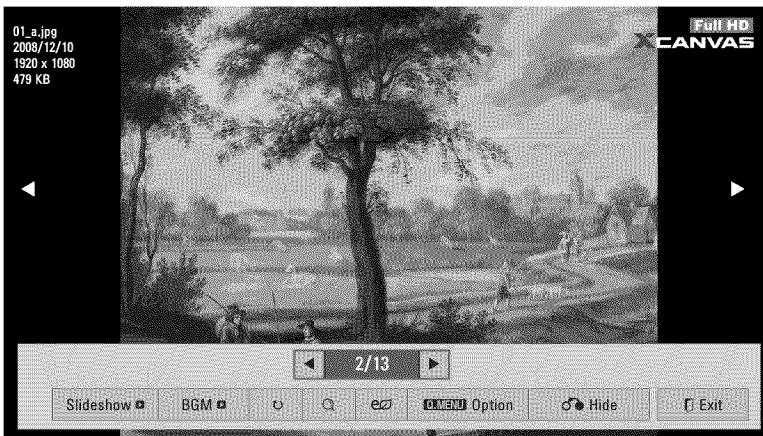
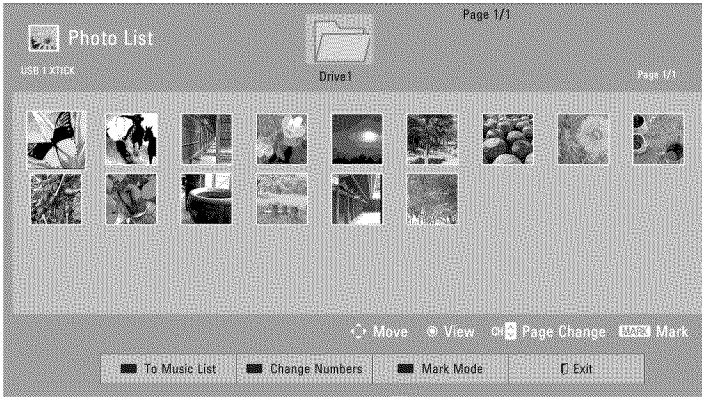

■ When one or more photos are marked, you can view individual photos or a slide show of the marked photos. If no photos are marked, you can view all photos individually or all photos in the folder in a slide show.

Full Screen Menu

More operations are available in full screen mode.



The aspect ratio of a photo may change the size of the photo displayed on the screen in full size.

-  Select the target folder or drive.
-   Select the desired photos.
-  The selected photo is displayed in full size.

■ Use the CH (^ v) button to navigate in the photo page.

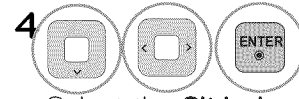

4 Select the **Slideshow**, **BGM**, **⤵ (Rotate)**, **Q (Zoom In)**, **eS (Energy Saving)**, **Option**, or **Hide**.

■ Use **< >** button to select the previous or next photo.

- ▶ **Slideshow:** Selected photos are displayed during the slide show. If no photo is selected, all photos in the current folder are displayed during slide show.
 - Set the time interval of the slide show in **Option-Set Photo View** menu (Refer to p. 91).
 - You can adjust **Option** by using the **Q.MENU** button on the remote control.
- ▶ **BGM (Background Music):** Listen to music while viewing photos in full size.
 - Set the BGM device and album in **Option-Set Photo View** menu (Refer to p. 91).
 - You can adjust **Option** by using the **Q.MENU** button on the remote control.
- ▶ **⤵ (Rotate):** Rotate photos.
 - Rotates the photo 90°, 180°, 270°, 360° clockwise.
 - Photos cannot be rotated if its width is greater than the available supported resolution height.
- ▶ **Q (Zoom In):** View the photo by zoom in 2, 4 times by using Blue button.
- ▶ **eS (Energy Saving):** Increase the brightness of your screen by using ENERGY SAVING button.
- ▶ **Option:** Set values for **Slide Speed** and **Music Album** (Refer to p. 91).
 - You cannot change **Music Album** while BGM is playing.
 - You can only select the MP3 folder saved on the device that currently displays the photo.
- ▶ **Hide:** Hide the menu on the full-sized screen.
 - To see the menu again on the full-sized screen, press **ENTER** button to display.
- ▶ **Exit:** Move to the previous menu screen.

Using the Photo List Function



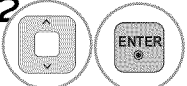

- 1  Show the **Option** menu.
- 2  Select **Set Photo View.**, **Set Video.**, or **Set Audio.**

NOTE

- ▶ Option values changed in Photo List do not affect Movie List and Music List.
- ▶ Option values changed in Photo List or Music List are changed likewise in Photo List and Music List, but not Movie List.

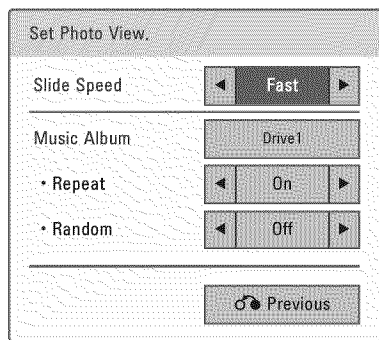
Set Photo View Menu Options



- 1  Select **Slide Speed** or **Music Album**.
- 2  Make appropriate adjustments.

MY MEDIA

* Image shown may differ from your TV.

Set Video Menu Options

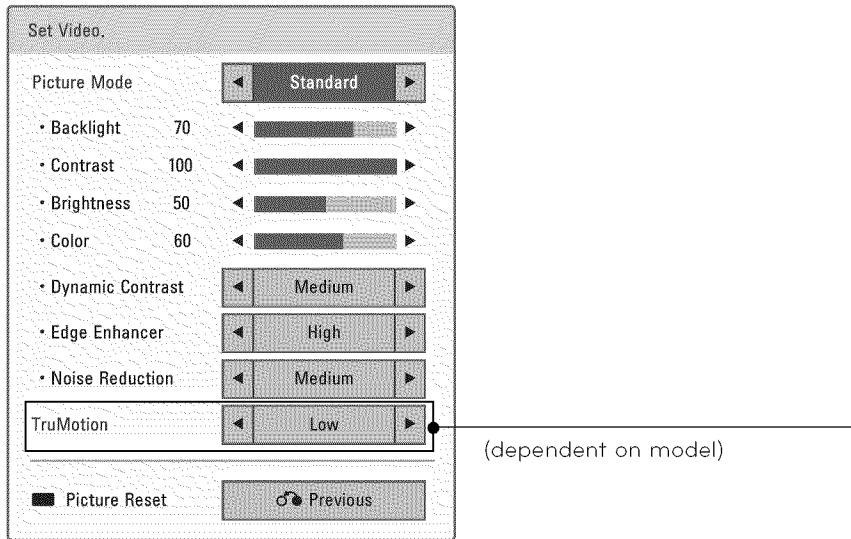

- 1 Select **Picture Mode** or **TruMotion**.
- 2 Make appropriate adjustments.
- Initialize the adjusted picture value.

Set Audio Menu Options

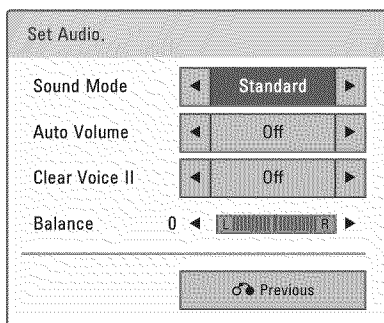

- 1 Select **Sound Mode**, **Auto Volume**, **Clear Voice II** or **Balance**.
- 2 Make appropriate adjustments.

MUSIC LIST

This TV cannot play back copy-protected files.
 The On-Screen Display on your model may be slightly different.

- MUSIC (*.MP3) supporting file
- Bit rate 32 Kbps - 320 Kbps
- Sampling rate MPEG1 Layer3: 32 kHz, 44.1 kHz, 48 kHz
 - Sampling rate MPEG2 Layer3: 16 kHz, 22.05 kHz, 24 kHz
 - Sampling rate MPEG2.5 Layer3: 8 kHz, 11.025 kHz, 12 kHz

Screen Components

1



Select **MY MEDIA**.

2

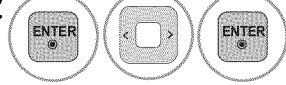

Select **Music List**.

- 1 Preview: If any album jacket for the file (Album Art Image) exists, this picture is displayed.
- 2 Moves to upper level folder
- 3 Current page/Total pages
- 4 Corresponding buttons on the remote control
- 5 Contents under the folder focused on 1
- 6 Current page/total pages of contents

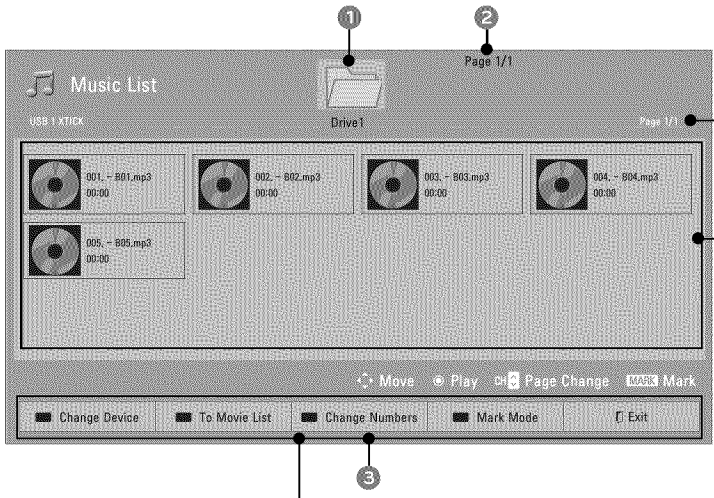

GREEN	Move to Movie List or Photo List .
YELLOW	Change Numbers: Changes the number or thumbnails displayed at a time.
BLUE	Allows you to mark certain files.
EXIT	Return to TV viewing.
ENERGY SAVING	Press the ENERGY SAVING button repeatedly to increase the brightness of your screen (Refer to p. 104). (It's available "ENERGY SAVING - Off, Screen Off" only.)

MY MEDIA

Music Selection

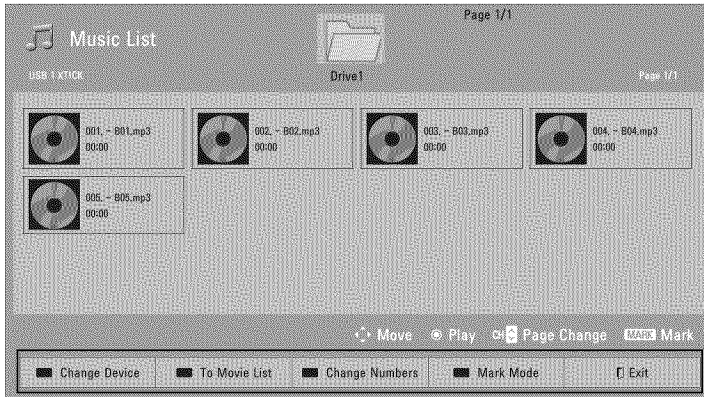

- 1 Select the target folder or drive.
- 2 Select the desired music file.
- 3 Music files are played.

■ Use the CH (^ v) button to navigate in the music page.

MY MEDIA

Mark Mode

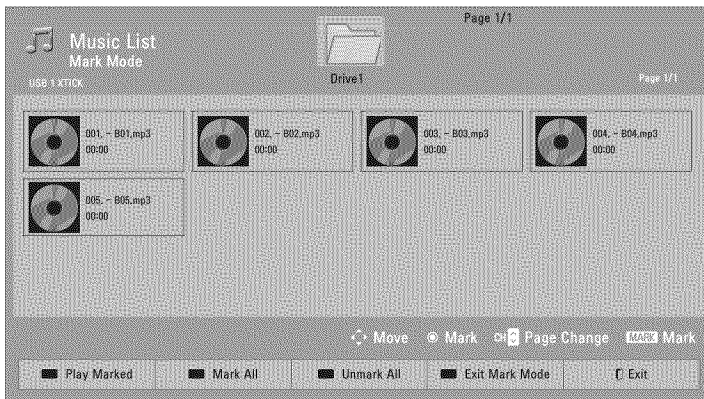

- 1 Select the target folder or drive.
- 2 Select the desired music file.
- 3 Mark your desired music file.
- 4 Play the marked music file.

RED

Play Marked: Play the selected songs. Once a song finishes playing, the next selected one will be played automatically.

GREEN

Mark All: Mark all songs in the folder.

YELLOW

Unmark All: Deselect all marked song.

BLUE

Exit the Mark Mode.

■ When one or more music files are marked, the marked music files will be played in sequence.

Using the Music List Function

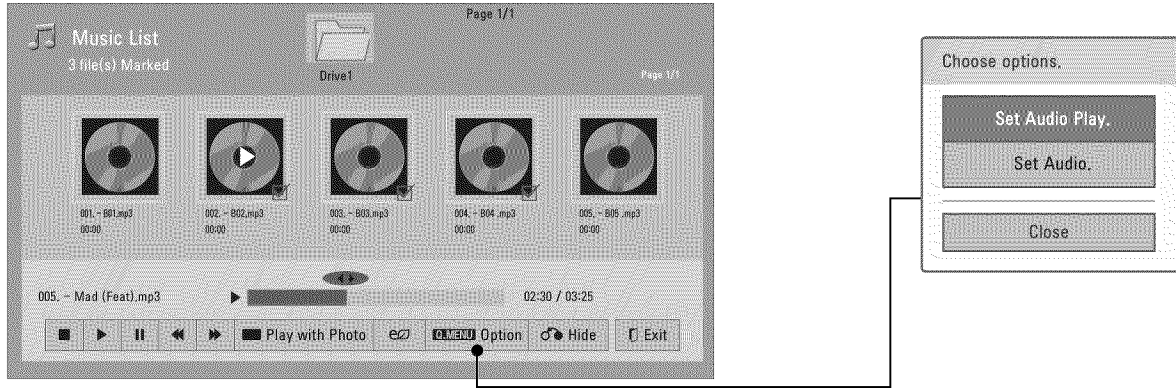

1 Show the **Option** menu.

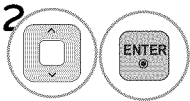

2 Select **Set Audio Play.** or **Set Audio.**

NOTE

- ▶ Option values changed in Movie List does not affect Photo List and Music List.
- ▶ Option value changed in Photo List and Music List are changed likewise in Photo List and Music List excluding Movie List.
- ▶ You can listen to the music only within the device currently played.

Using the remote control

	Stop playback.
	Return to normal playback.
	Paused playback.
	Select the previous or next song.
	Play with Photo: Start playing the selected songs and then move to the Photo List.
	Press the ENERGY SAVING button repeatedly to increase the brightness of your screen (Refer to p. 104). (It's available " ENERGY SAVING - Off, Screen Off " only.)
	A cursor indicating the position can be played on the screen.
	Move to the previous menu screen.

MY MEDIA

Set Audio Play Menu Options

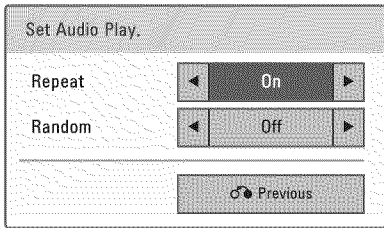

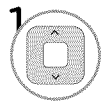
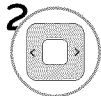
- 1  Select **Repeat** or **Random**.
- 2  Make appropriate adjustments.

Set Audio Menu Options

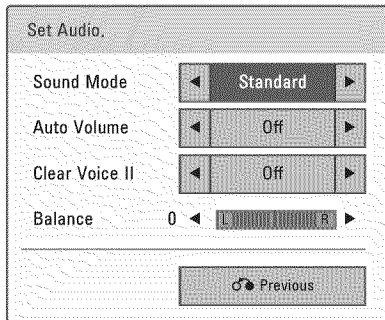

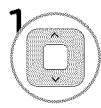
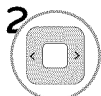
- 1  Select **Sound Mode**, **Auto Volume**, **Clear Voice II** or **Balance**.
- 2  Make appropriate adjustments.

- If you don't press any buttons for a while, the play information box will float across the screen. This prevents screen pixel damage due to a fixed image remaining on the screen for an extended period of time.



NOTE

- ▶ Music files with copy-protection will not play.
- ▶ Press ENTER or  button to stop the screen saver.

MY MEDIA

DIVX REGISTRATION CODE





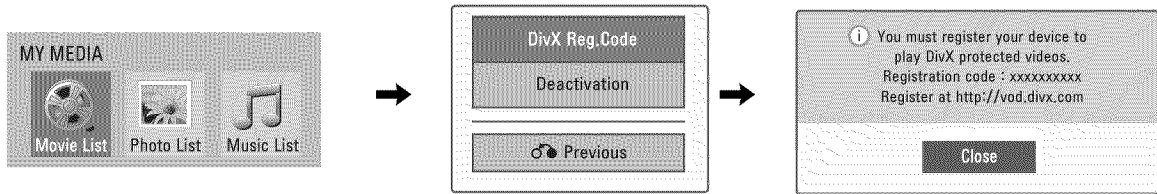

(Except 32/42/47LD420, 32/37/42/47LD450, 37/42/47LD450C, 32/42/47/55LD520)

Using the registration number, movies can be rented or purchased at www.divx.com/vod.

Only DivX files matched with the registration code of the purchased TV are playable.



MY MEDIA

- 1   Select **MY MEDIA**.
- 2   Select DivX Option.
- 3  Select **DivX Reg. Code**.
- 4  Display Divx Reg. Code.

NOTE

- ▶ When loading, some buttons may not work.
- ▶ If you use the DivX registration code of another device, the rented or purchased DivX file cannot be played. Therefore always use the DivX registration code assigned to this product.
- ▶ The video or audio of a file converted based on a standard other than the DivX codec standard may be corrupted or unable to be played.







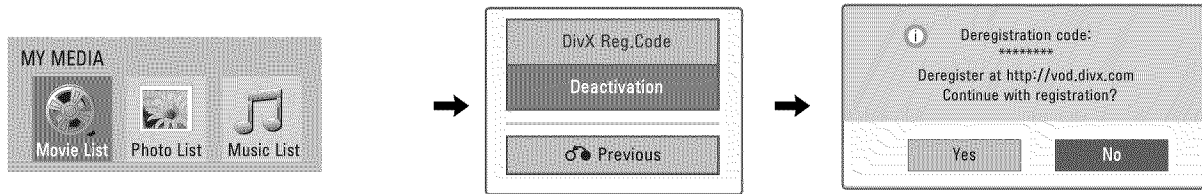

DEACTIVATION

(Except 32/42/47LD420, 32/37/42/47LD450, 37/42/47LD450C, 32/42/47/55LD520)

The purpose of deactivation is to allow deactivation of devices for users who have activated all the available devices through the web server and are blocked from activating more devices. DivX VOD allows the consumer to activate up to 6 devices under one account.

Delete the existing authentication information to receive a new DivX user authentication for TV. Once this function is executed, a DivX user authentication is required again to see DivX DRM files.



- 1   Select **MY MEDIA**.
- 2   Select DivX Option.
- 3  Select **Deactivation**.
- 4   Select **Yes**.
- 5  Display **Deactivation**.



The model and serial number of the TV is located on the back and one side of the TV.
Record it below should you ever need service.

MODEL _____

SERIAL _____