



# OWNER'S MANUAL

## LED TV\*

\*LG LED TV applies LCD screen with LED backlights.

Please read this manual carefully before operating your set and retain it for future reference.

32LB5800	32LB580B	47LB6100
39LB5800		50LB6100
42LB5800		55LB6100
47LB5800		60LB6100
50LB5800		65LB6190
55LB5800		



\* M F L 6 8 0 2 7 9 1 2 \*

[www.lg.com](http://www.lg.com)

P/NO : MFL68027912 (1405-REV02)

# IMPORTANT SAFETY INSTRUCTIONS

Always comply with the following precautions to avoid dangerous situations and ensure peak performance of your product.





**WARNING/CAUTION**

**RISK OF ELECTRIC SHOCK  
DO NOT OPEN**





TO REDUCE THE RISK OF ELECTRIC SHOCK DO NOT REMOVE COVER (OR BACK). NO USER SERVICEABLE PARTS INSIDE. REFER TO QUALIFIED SERVICE PERSONNEL.

 The lightning flash with arrowhead symbol, within an equilateral triangle, is intended to alert the user to the presence of uninsulated "dangerous voltage" within the product's enclosure that may be of sufficient magnitude to constitute a risk of electric shock to persons.

 The exclamation point within an equilateral triangle is intended to alert the user to the presence of important operating and maintenance (servicing) instructions in the literature accompanying the appliance.

**WARNING/CAUTION**  
- TO REDUCE THE RISK OF FIRE AND ELECTRIC SHOCK, DO NOT EXPOSE THIS PRODUCT TO RAIN OR MOISTURE.

 **WARNING**  
If you ignore the warning message, you may be seriously injured or there is a possibility of accident or death.

 **CAUTION**  
If you ignore the caution message, you may be slightly injured or the product may be damaged.

 **NOTE**  
The note helps you understand and use the product safely. Please read the note carefully before using the product.

ENGLISH

Read these instructions.  
Keep these instructions.  
Heed all warnings.  
Follow all instructions.



- Do not use this apparatus near water.



- Clean only with a dry cloth.



- Do not block any ventilation openings. Install in accordance with the manufacturer's instructions.



- Do not install near any heat sources such as radiators, heat registers, stoves, or other apparatus (including amplifiers) that produce heat.



- Do not defeat the safety purpose of the polarized or grounding-type plug. A polarized plug has two blades with one wider than the other. A grounding type plug has two blades and a third grounding prong. The wide blade or the third prong are provided for your safety. If the provided plug does not fit into your outlet, consult an electrician for replacement of the obsolete outlet (Can differ by country).



**WARNING:** This product contains chemicals known to the State of California to cause cancer and birth defects or other reproductive harm.  
*Wash hands after handling.*

- Do not press strongly upon the panel with a hand or a sharp object such as a nail, pencil or pen, or make a scratch on it.



- Protect the power cord from being walked on or pinched particularly at plugs, convenience receptacles, and the point where they exit from the apparatus.



- Only use attachments/accessories specified by the manufacturer.



- Use only with a cart, stand, tripod, bracket, or table specified by the manufacturer, or sold with the apparatus. When a cart is used, use caution when moving the cart/apparatus combination to avoid injury from tip-over.



- Unplug this apparatus during lightning storms or when unused for long periods of time.

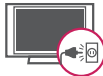

- Refer all servicing to qualified service personnel. Servicing is required when the apparatus has been damaged in any way, such as power-supply cord or plug is damaged, liquid has been spilled or objects have fallen into the apparatus, the apparatus has been exposed to rain or moisture, does not operate normally, or has been dropped.



- Do not stick metal objects or any other conductive material into the power cord. Do not touch the end of the power cord while it is plugged in.

- Keep the packing anti-moisture material or vinyl packing out of the reach of children. Anti-moisture material is harmful if swallowed. If swallowed by mistake, force the patient to vomit and visit the nearest hospital. Additionally, vinyl packing can cause suffocation. Keep it out of the reach of children.

- CAUTION** concerning the Power Cord (Can differ by country):

It is recommended that appliances be placed upon a dedicated circuit; that is, a single outlet circuit which powers only that appliance and has no additional outlets or branch circuits. Check the specification page of this owner's manual to be certain. Do not connect too many appliances to the same AC power outlet as this could result in fire or electric shock. Do not overload wall outlets. Overloaded wall outlets, loose or damaged wall outlets, extension cords, frayed power cords, or damaged or cracked wire insulation are dangerous. Any of these conditions could result in electric shock or fire. Periodically examine the cord of your appliance, and if its appearance indicates damage or deterioration, unplug it, discontinue use of the appliance, and have the cord replaced with an exact replacement part by an authorized service. Protect the power cord from physical or mechanical abuse, such as being twisted, kinked, pinched, closed in a door, or walked upon. Pay particular attention to plugs, wall outlets, and the point where the cord exits the appliance. Do not move the TV with the power cord plugged in. Do not use a damaged or loose power cord. Be sure do grasp the plug when unplugging the power cord. Do not pull on the power cord to unplug the TV.



- Warning** - To reduce the risk of fire or electrical shock, do not expose this product to rain, moisture or other liquids. Do not touch the TV with wet hands. Do not install this product near flammable objects such as gasoline or candles, or expose the TV to direct air conditioning.



## 4 IMPORTANT SAFETY INSTRUCTIONS

- Do not expose to dripping or splashing and do not place objects filled with liquids, such as vases, cups, etc. on or over the apparatus (e.g. on shelves above the unit).



### • Grounding

(Except for devices which are not grounded.) Ensure that you connect the earth ground wire to prevent possible electric shock (i.e. a TV with a three-prong grounded AC plug must be connected to a three-prong grounded AC outlet). If grounding methods are not possible, have a qualified electrician install a separate circuit breaker. Do not try to ground the unit by connecting it to telephone wires, lightning rods, or gas pipes.

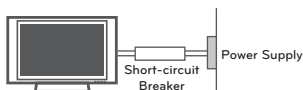

- As long as this unit is connected to the AC wall outlet, it is not disconnected from the AC power source even if the unit is turned off.
- Do not attempt to modify this product in any way without written authorization from LG Electronics. Unauthorized modification could void the user's authority to operate this product.
- **Outdoor Antenna Grounding**  
(Can differ by country):  
If an outdoor antenna is installed, follow the precautions below. An outdoor antenna system should not be located in the vicinity of overhead power lines or other electric light or power circuits, or where it can come in contact with such power lines or circuits as death or serious injury can occur. Be sure the antenna system is grounded to provide some protection against voltage surges and built-up static charges. Section 810 of the National Electrical Code (NEC) in the U.S.A. provides information with respect to proper grounding of the mast and supporting structure, grounding of the lead-in wire to an antenna discharge unit, size of grounding conductors, location of antenna discharge unit, connection to grounding electrodes and requirements for the grounding electrode.

### Antenna grounding according to the National Electrical Code, ANSI/NFPA 70

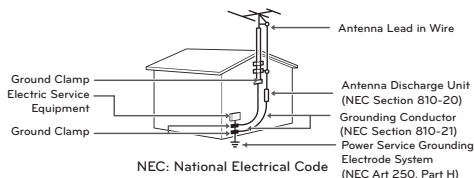

- **Cleaning**  
When cleaning, unplug the power cord and wipe gently with a soft cloth to prevent scratching. Do not spray water or other liquids directly on the TV as electric shock may occur. Do not clean with chemicals such as alcohol, thinners, or benzene.
- **Moving**  
Make sure the product is turned off, unplugged, and all cables have been removed. It may take 2 or more people to carry larger TVs. Do not press or put stress on the front panel of the TV.
- **Ventilation**  
Install your TV where there is proper ventilation. Do not install in a confined space such as a bookcase. Do not cover the product with cloth or other materials while plugged. Do not install in excessively dusty places.
- If you smell smoke or other odors coming from the TV, unplug the power cord and contact an authorized service center.
- Keep the product away from direct sunlight.
- Never touch this apparatus or antenna during a thunder or lightning storm.
- When mounting a TV on the wall, make sure not to install the TV by hanging the power and signal cables on the back of the TV.
- Do not allow an impact shock or any objects to fall into the product, and do not drop anything onto the screen.
- **Disconnecting the Main Power**  
The power outlet used with this device must remain easily accessible.
- Store the accessories (battery, etc.) in a safe location out of the reach of children.
- This apparatus use batteries. In your community there might be regulations that require you to dispose of these batteries properly due to environmental considerations. Please contact your local authorities for disposal or recycling information.
- Do not dispose of batteries in a fire.
- Do not short circuit, disassemble, or allow the batteries to overheat.

- **Dot Defect**

The Plasma or LCD panel is a high technology product with resolution of two million to six million pixels. In a very few cases, you could see fine dots on the screen while you're viewing the TV. Those dots are deactivated pixels and do not affect the performance and reliability of the TV.

- **Generated Sound**

**Cracking noise** A cracking noise that occurs when watching or turning off the TV is generated by plastic thermal contraction due to temperature and humidity. This noise is common for products where thermal deformation is required.

**Electrical circuit humming/panel buzzing** A low level noise is generated from a high-speed switching circuit, which supplies a large amount of current to operate a product. It varies depending upon the product. This generated sound does not affect the performance and reliability of the product.

- Take care not to touch the ventilation openings. When watching the TV for a long period, the ventilation openings may become hot. This does not affect the performance of the product or cause defects in the product.
- Do not install this product on a wall if it could be exposed to oil or oil mist. This may damage the product and cause it to fall.
- If the TV feels cold to the touch, there may be a small flicker when it is turned on. This is normal, there is nothing wrong with TV. Some minute dot defects may be visible on the screen, appearing as tiny red, green, or blue spots. However, they have no adverse effect on the TV's performance. Avoid touching the LCD screen or holding your finger(s) against it for long periods of time. Doing so may produce some temporary distortion effects on the screen.

**Preventing Image burn or Burn-in on your TV screen**

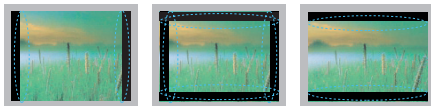

- If a fixed image displays on the TV screen for a long period of time, it will be imprinted and become a permanent disfigurement on the screen. This is image burn or burn-in and not covered by the warranty.
- If the aspect ratio of the TV is set to 4:3 for a long period of time, image burn may occur on the letterboxed area of the screen.
- Avoid displaying a fixed image on the TV screen for a long period of time (2 or more hours for LCD, 1 or more hours for the Plasma TV) to prevent image burn.

**For USA and Canada**

**FCC NOTICE**

This equipment has been tested and found to comply with the limits for a Class B digital device, pursuant to Part 15 of the FCC Rules. These limits are designed to provide reasonable protection against harmful interference in a residential installation. This equipment generates, uses and can radiate radio frequency energy and, if not installed and used in accordance with the instructions, may cause harmful interference to radio communications. However, there is no guarantee that interference will not occur in a particular installation. If this equipment does cause harmful interference to radio or television reception, which can be determined by turning the equipment off and on, the user is encouraged to try to correct the interference by one or more of the following measures:

- Reorient or relocate the receiving antenna.
- Increase the separation between the equipment and the receiver.
- Connect the equipment to an outlet on a circuit different from that to which the receiver is connected.
- Consult the dealer or an experienced radio/TV technician for help.

This device complies with part 15 of the FCC Rules. Operation is subject to the following two conditions: (1) this device may not cause harmful interference and (2) this device must accept any interference received, including interference that may cause undesired operation of the device. Any changes or modifications in construction of this device which are not expressly approved by the party responsible for compliance could void the user's authority to operate the equipment.

**NOTE TO CABLE/TV INSTALLER**

This reminder is provided to call the CATV system installer's attention to Article 820-40 of the National Electric Code (U.S.A.). The code provides guidelines for proper grounding and, in particular, specifies that the cable ground shall be connected to the grounding system of the building, as close to the point of the cable entry as practical.

ENGLISH

## LICENSES

Supported licenses may differ by model.  
For more information about licenses, visit [www.lg.com](http://www.lg.com).



## OPEN SOURCE SOFTWARE NOTICE

ENGLISH

To obtain the source code under GPL, LGPL, MPL and other open source licenses, that is contained in this product, please visit <http://opensource.lge.com>.

In addition to the source code, all referred license terms, warranty disclaimers and copyright notices are available for download.

LG Electronics will also provide open source code to you on CD-ROM for a charge covering the cost of performing such distribution (such as the cost of media, shipping and handling) upon email request to [opensource@lge.com](mailto:opensource@lge.com). This offer is valid for three (3) years from the date on which you purchased the product.

### ! NOTE

- Image shown may differ from your TV.
- Your TV's OSD (On Screen Display) may differ slightly from that shown in this manual.
- The available menus and options may differ from the input source or product model that you are using.
- New features may be added to this TV in the future.

# ASSEMBLING AND PREPARING

## Unpacking

Check your product box for the following items. If there are any missing accessories, contact the local dealer where you purchased your product. The illustrations in this manual may differ from the actual product and item.

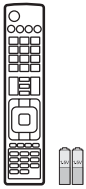

**Remote Control,  
Batteries (AAA)**



**Owner's Manual**



**Power Cord**



**Cable Holder**

(For 32LB580B,  
32LB5800)



**Stand Screws**  
4 EA, M4 x L20

(For 39/42/47/50/55LB5800,  
47/50/55/60LB6100,  
65LB6190)



**Stand Screws**  
4 EA, M4 x L14

(For 42LB5800)



**Wall Mount Spacer**  
2 EA

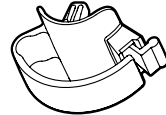

**Stand Holder**  
2 EA

(For 32LB580B,  
LB5800 series,  
47/50/55/60LB6100)

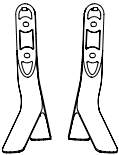

**Stand Base**

(For 65LB6190)

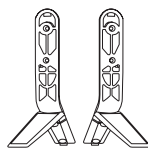

**Stand Base/Stand Body**

**CAUTION**

- Do not use any unapproved items to ensure the safety and product life span.
- Any damages or injuries by using unapproved items are not covered by the warranty.
- Some models appear to have a thin film on the screen. It is actually part of the screen; do not remove it.

**NOTE**

- The items supplied with your product may vary depending upon the model.
- Product specifications or contents of this manual may be changed without prior notice due to upgrade of product functions.
- For an optimal connection, HDMI cables and USB devices should have bezels less than 10 mm (0.39 inches) thick and 18 mm (0.7 inches) width.
- Use an extension cable that supports USB 2.0 if the USB cable or USB FLASH DRIVE does not fit into your TV's USB port.

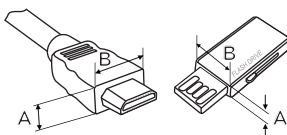

\*A ≤ 10 mm (0.39 inches)  
 \*B ≤ 18 mm (0.7 inches)

ENGLISH

## Optional Extras

Optional extras can be changed or modified for quality improvement without any notification. Contact your dealer for buying these items. These devices only work with certain models. The model name or design may be changed manufacturer's circumstances or policies.

**AN-MR500**  
 Magic Remote

**AN-VC5\*\***  
 Video Call Camera

**LG Audio Device**

**Tag On**

**AN-WF500**  
 Wi-Fi/Bluetooth DONGLE



## Parts and buttons

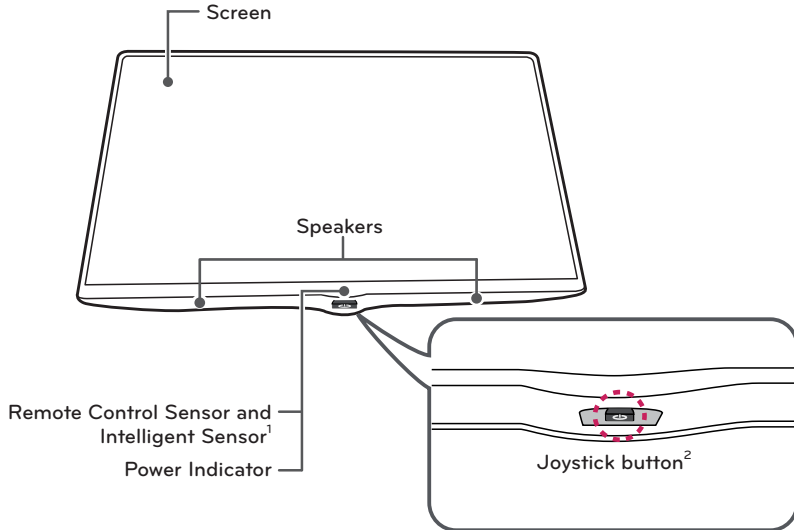

- 1 Intelligent sensor - Adjusts the image quality and brightness based on the surrounding environment.
- 2 Joystick button is located below the screen of TV.





### ! NOTE

- You can set the Power indicator Light to on or off by selecting **OPTION** in the main menus. (Depending upon model)

## Using the joystick button

You can operate the TV by pressing the button or moving the joystick left, right, up, or down.

### Basic functions

	<b>Power On</b>	When the TV is turned off, place your finger on the joystick button and press it once and release it.
	<b>Power Off</b>	When the TV is turned on, place your finger on the joystick button and press it once for a few seconds and release it. (However, if the Menu button is on the screen, pressing and holding the joystick button will let you exit the Menu.)
	<b>Volume Control</b>	If you place your finger over the joystick button and move it left or right, you can adjust the volume level you want.
	<b>Channels Control</b>	If you place your finger over the joystick button and move it up or down, you can scrolls through the saved channels you want.





### ! NOTE

- When your finger over the joystick button and push it to the up, down, left, or right, be careful not to press the joystick button. If you press the joystick button first, you can not adjust the volume level and saved channels.

### Adjusting the menu

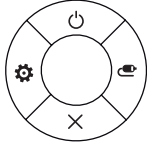
When the TV is turned on, press the joystick button one time.

You can adjust the Menu items (⏻, ⚙️, ✖️, 📺) moving the joystick button up, down, left or right.

		<b>TV Off</b>	Turns the power off.
		<b>Settings</b>	Accesses the main menu.
		<b>Close</b>	Clears on-screen displays and returns to TV viewing.
		<b>Input List</b>	Changes the input source.

## Lifting and moving the TV

When moving or lifting the TV, read the following to prevent the TV from being scratched or damaged and for safe transportation regardless of its type and size.

 **CAUTION**

- Avoid touching the screen at all times, as this may result in damage to the screen.
- Do not place the product on the floor with its front facing down without padding. Failure to do so may result in damage to the screen.
- It is recommended to move the TV in the box or packing material that the TV originally came in.
- Before moving or lifting the TV, disconnect the power cord and all cables.
- When holding the TV, the screen should face away from you to avoid damage.



- Hold the top and bottom of the TV frame firmly. Make sure not to hold the transparent part, speaker, or speaker grill area.

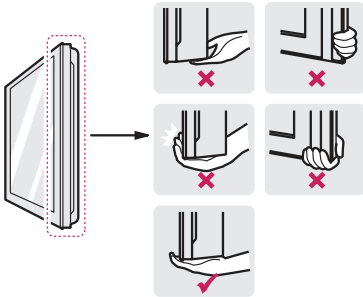

- Use at least two people to move a large TV.
- When transporting the TV by hand, hold the TV as shown in the following illustration.

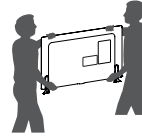

- When handling the TV, be careful not to damage the protruding joystick button.
- When transporting the TV, do not expose the TV to jolts or excessive vibration.
- When transporting the TV, keep the TV upright; never turn the TV on its side or tilt towards the left or right.

## Setting up the TV

You can mount your TV to a wall or attach the stand if you wish to place the TV on an entertainment center or other furniture.

### Attaching the stand

If you are not mounting the TV to a wall, use the following instructions to attach the stand.

#### CAUTION

- When attaching the stand to the TV set, place the screen facing down on a cushioned table or flat surface to protect the screen from scratches.

1

(For 65LB6190)

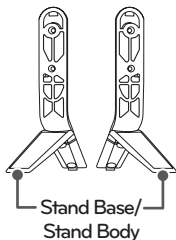

(For 32LB580B, LB5800 series, 47/50/55/60LB6100)

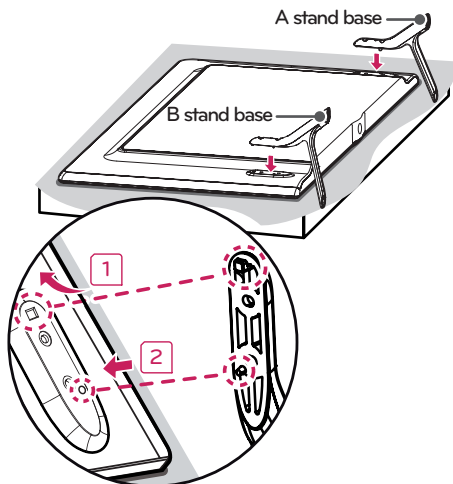
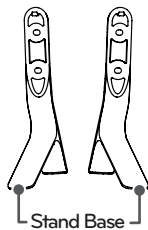

2

(For 32LB580B, 32LB5800)

 4 EA  
M4 x L20

(For 39/42/47/50/55LB5800, 47/50/55/60LB6100, 65LB6190)

 4 EA  
M4 x L14

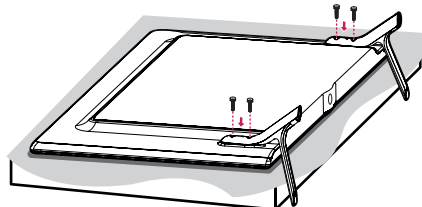
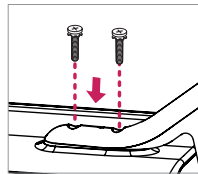

### Mounting on a table

- Lift and tilt the TV into its upright position on a table.
  - Leave a 10 cm (4 inch) (minimum) space from the wall for proper ventilation.

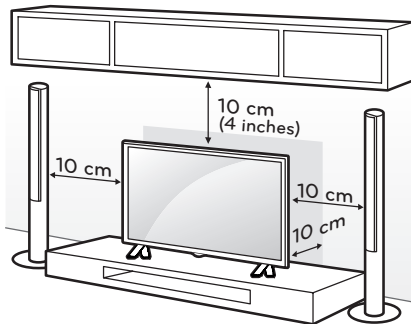

- Connect the power cord to a wall outlet.

#### CAUTION

- Do not place the TV near or on sources of heat, as this may result in fire or other damage.

**Securing the TV to a wall (optional)**

(Depending upon model)

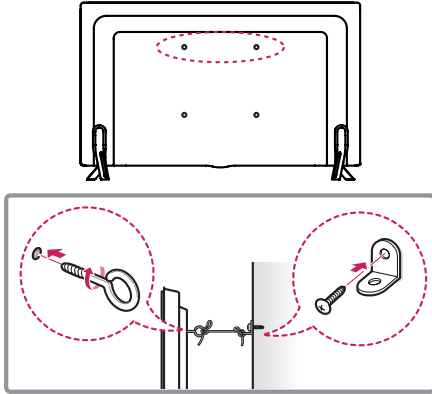

- 1 Insert and tighten the eye-bolts, or TV brackets and bolts on the back of the TV.  
- If there are bolts inserted at the eye-bolts position, remove the bolts first.
- 2 Mount the wall brackets with the bolts to the wall.  
Match the location of the wall bracket and the eye-bolts on the rear of the TV.
- 3 Connect the eye-bolts and wall brackets tightly with a sturdy rope or cable.  
Make sure to keep the rope parallel to the flat surface.

**CAUTION**

- Make sure that children do not climb on or hang on the TV.

**NOTE**

- Use a platform or cabinet that is strong and large enough to support the TV securely.
- Brackets, bolts and ropes are optional. You can obtain additional accessories from your local dealer.

**Mounting on a wall**

An optional wall mount can be used with your LG Television. Consult with your local dealer for a wall mount that supports the VESA standard used by your TV model. Carefully attach the wall mount bracket at the rear of the TV. Install the wall mount bracket on a solid wall perpendicular to the floor. If you are attaching the TV to other building materials, please contact qualified personnel to install the wall mount. Detailed instructions will be included with the wall mount. We recommend that you use an LG brand wall mount. When you do not use LG's wall mount bracket, please use a wall mount bracket where the device is adequately secured to the wall with enough space to allow connectivity to external devices.

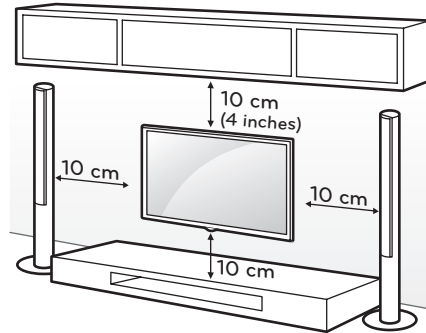

Make sure to use screws and wall mounts that meet the VESA standard. Standard dimensions for the wall mount kits are described in the following table.

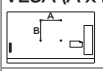
<b>Model</b>	32LB580B 32LB5800 39LB5800	42LB5800 47LB5800 50LB5800 55LB5800 47LB6100 50LB6100 55LB6100
<b>VESA (A x B)</b>	200 x 200	400 x 400
		
<b>Standard screw</b>	M6	M6
<b>Number of screws</b>	4	4
<b>Wall mount bracket (optional)</b>	LSW240B MSW240	LSW440B MSW240

<b>Model</b>	60LB6100, 65LB6190
<b>VESA (A x B)</b>	400 x 400
	
<b>Standard screw</b>	M6
<b>Number of screws</b>	4
<b>Wall mount bracket (optional)</b>	LSW440B

 **CAUTION**

- Disconnect the power first, and then move or install the TV. Otherwise electric shock may occur.
- If you install the TV on a ceiling or slanted wall, it may fall and result in severe injury. Use an authorized LG wall mount and contact the local dealer or qualified personnel.
- Do not over tighten the screws as this may cause damage to the TV and void your warranty.
- Use the screws and wall mounts that meet the VESA standard. Any damages or injuries by misuse or using an improper accessory are not covered by the warranty.

 **NOTE**

- Use the screws that are listed on the VESA standard screw specifications.
- The wall mount kit includes an installation manual and necessary parts.
- The wall mount bracket is optional. You can obtain additional accessories from your local dealer.
- The length of screws may differ depending upon the wall mount. Make sure to use the proper length.
- For more information, refer to the manual supplied with the wall mount.
- When attaching a wall mounting bracket to the TV, insert the wall mount inner spacers into the TV wall mount holes to adjust the vertical angle of the TV.  
(For 42LB5800)

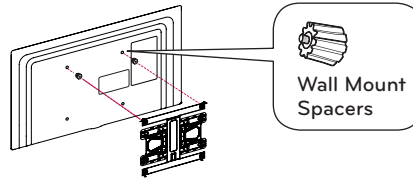

# MAKING CONNECTIONS

You can connect various external devices to the TV. Supported external devices are: HD receivers, DVD players, VCRs, audio systems, USB storage devices, PC, gaming devices, and other external devices. For more information on external device's connection, refer to the manual provided with each device.

**NOTE**

- If you record a TV program on a DVD recorder or VCR, make sure to connect the TV signal input cable to the TV through a DVD recorder or VCR. For more information of recording, refer to the manual provided with the connected device.
- The external device connections shown may differ slightly from illustrations in this manual.
- Connect external devices to the TV regardless of the order of the TV port.
- If you connect a gaming device to the TV, use the cable supplied with the gaming device.
- Refer to the external equipment's manual for operating instructions.

## Connecting to an antenna or cable

Connect an antenna, cable, or cable box to watch TV while referring to the following. The illustrations may differ from the actual items. And a RF cable is optional.

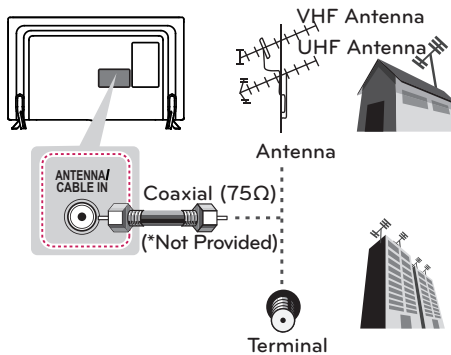

**CAUTION**

- Make sure not to bend the copper wire of the RF cable.



- Complete all connections between devices, and then connect the power cord to the power outlet to prevent damage to your TV.

**NOTE**

- Use a signal splitter to use 2 TVs or more.
- DTV Audio Supported Codec: MPEG, Dolby Digital.

## Other connections

- Image shown may differ from your TV.

Connect your TV to external devices. For the best picture and audio quality, connect the external device and the TV with the HDMI cable as shown. Depending upon the model, a cable may not be provided.

ENGLISH

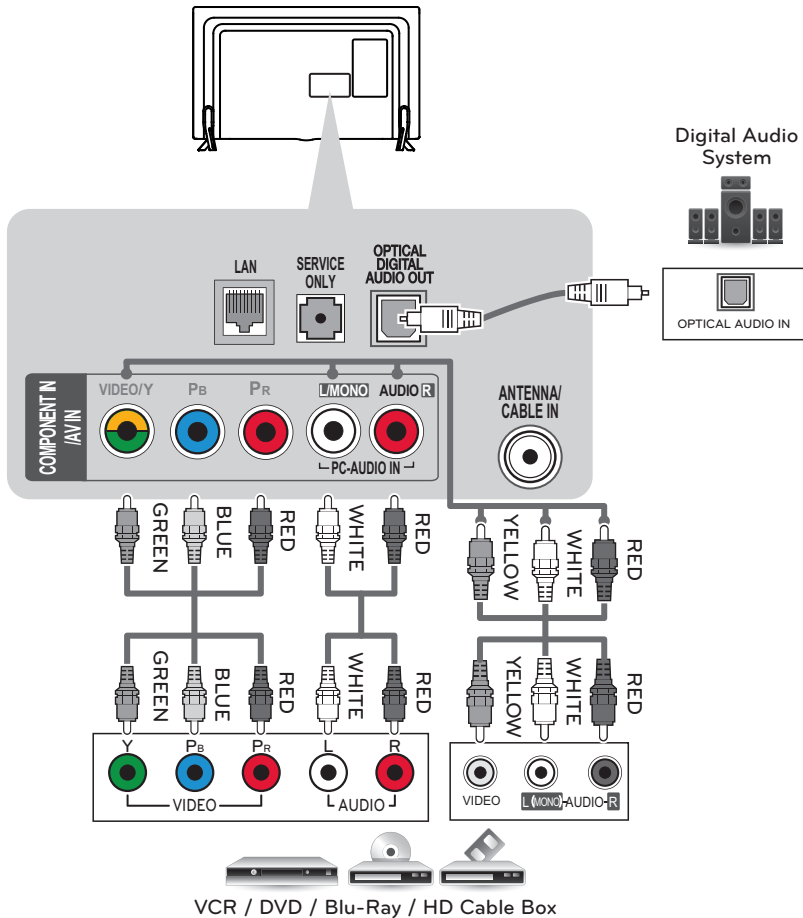



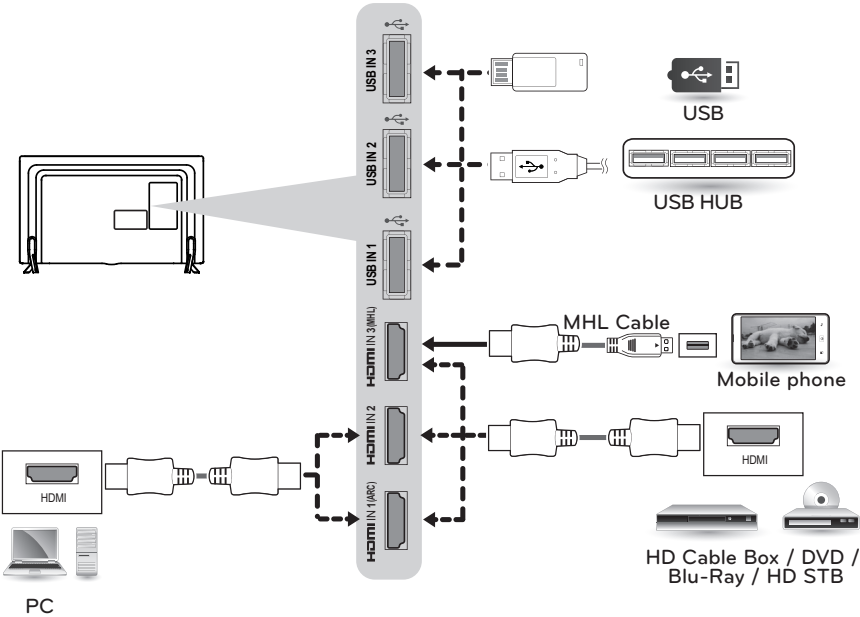

# REMOTE CONTROL

The descriptions in this manual are based on the buttons on the remote control. Please read this manual carefully and use the TV correctly. To install batteries, open the battery cover, replace batteries (1.5 V AAA) matching the ⊕ and ⊖ ends to the label inside the compartment, and close the battery cover. Failure to match the correct polarities of the battery may cause the battery to burst or leak, resulting in fire, personal injury, or ambient pollution. To remove the batteries, perform the installation actions in reverse.

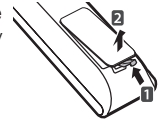

**CAUTION**

- Do not mix old and new batteries, as this may damage the remote control.



This remote uses infrared light. When in use, it should be pointed in the direction of the TV's remote sensor.

ENGLISH

	<p><b>(POWER)</b> Turns the TV on or off.</p>
	<p><b>CAPTION</b> Activates or deactivates the subtitles.</p>
	<p><b>AV MODE</b> Selects an AV mode.</p>
	<p><b>RATIO</b> Resizes an image.</p>
	<p><b>INPUT</b> Changes the input source. Turns the TV on if it is off.</p>
<p>1 2 3</p>	<p><b>Number button</b> Enters numbers.</p>
<p>4 5 6</p>	<p><b>- (Dash)</b> Inserts a dash between numbers such as 2-1 and 2-2.</p>
<p>7 8 9</p>	<p><b>LIST</b> Accesses the saved channel list.</p>
<p>LIST 0 FLASHBK</p>	<p><b>FLASHBK</b> Alternates between the two last channels selected (pressing repeatedly).</p>
<p>+ VOL -</p>	<p><b>+ VOL -</b> Adjusts the volume level.</p>
<p>FAV</p>	<p><b>FAV</b> Accesses your favorite channel list.</p>
<p>INFO</p>	<p><b>INFO</b> Shows information on the current program.</p>
<p>MUTE</p>	<p><b>MUTE</b> Mutes all sounds.</p>
<p>CH</p>	<p><b>CH</b> Scrolls through the saved channels.</p>
<p>PAGE</p>	<p><b>PAGE</b> Moves to the previous or next screen.</p>
<p>SETTINGS</p>	<p><b>SETTINGS</b> Accesses the main menu.</p>
<p>SMART</p>	<p><b>SMART</b> Accesses the Smart Home menu.</p>
<p>MY APPS</p>	<p><b>MY APPS</b> Shows the list of Apps.</p>
<p>Navigation buttons</p>	<p><b>Navigation buttons</b> Scrolls through menus or options. (up/down/left/right)</p>
<p>OK</p>	<p><b>OK</b> Selects menus or options and confirms your input.</p>
<p>BACK</p>	<p><b>BACK</b> Returns to the previous screen.</p>
<p>Q.MENU</p>	<p><b>Q.MENU</b> Accesses the quick menu.</p>
<p>EXIT</p>	<p><b>EXIT</b> Clears all on-screen displays and returns to TV viewing.</p>
<p>Color buttons</p>	<p><b>Color buttons</b> (Red, Green, Yellow, Blue) These access special functions in some menus.</p>
<p>Control buttons</p>	<p><b>Control buttons</b> Controls the SIMPLINK compatible devices (USB, SIMPLINK).</p>
<p>Simplink</p>	<p><b>Simplink</b> Accesses the AV devices connected to the TV; Opens the SIMPLINK menu.</p>
<p>SLEEP</p>	<p><b>SLEEP</b> Sets the length of time until the TV to turn off.</p>
<p>VD/*</p>	<p><b>VD /*</b> Enables VD function. SAP(Secondary Audio Program) Feature can also be enabled by pressing the VD key.</p>
<p>TV</p>	<p><b>TV</b> Returns to the last TV channel.</p>

## USING THE USER GUIDE

User Guide allows you to easily access detailed TV information.

- 1 Press **SMART**  button to access the Smart Home menu.
- 2 Select **SETTINGS**  **SUPPORT**.
- 3 Select **User Guide** and press the **OK**  button.

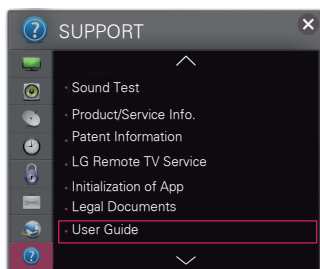

# SPECIFICATIONS

Product specifications may be changed without prior notice due to upgrade of product functions.

<b>Power requirement</b>		AC 100 - 240 V ~ 50 / 60 Hz
<b>Television System</b>		ATSC / NTSC-M, 64 & 256 QAM
<b>Program Coverage</b>		VHF 2-13, UHF 14-69, CATV 1-135, DTV 2-69, CADTV 1-135
<b>External Antenna Impedance</b>		75 Ω
<b>Environment condition</b>	Operating Temperature	0 - 40 °C (32 °F ~ 104 °F)
	Operating Humidity	Less than 80 %
	Storage Temperature	-20 - 60 °C (- 4 °F ~ 140 °F)
	Storage Humidity	Less than 85 %

MODELS		32LB580B (32LB580B-UG)	39LB5800 (39LB5800-UG)
		32LB5800 (32LB5800-UG)	
Dimensions (W x H x D)	With stand	732 x 481 x 207 (mm) 28.8 x 18.9 x 8.1 (inch)	885 x 567 x 218 (mm) 34.8 x 22.3 x 8.5 (inch)
	Without stand	732 x 431 x 55.5 (mm) 28.8 x 16.9 x 2.1 (inch)	885 x 524 x 55.5 (mm) 34.8 x 20.6 x 2.1 (inch)
Weight	With stand	6.2 kg (13.6 lbs)	8.3 kg (18.2 lbs)
	Without stand	6.0 kg (13.2 lbs)	8 kg (17.6 lbs)
Current Value / Power consumption		1.25 A / 75 W	1.0 A / 100 W

MODELS		42LB5800 (42LB5800-UG)	47LB5800 (47LB5800-UG)
			47LB6100 (47LB6100-UG)
Dimensions (W x H x D)	With stand	961 x 610 x 218 (mm) 37.8 x 24 x 8.5 (inch)	1,073 x 676 x 255 (mm) 42.2 x 26.6 x 10 (inch)
	Without stand	961 x 567 x 55.5 (mm) 37.8 x 22.3 x 2.1 (inch)	1,073 x 629 x 55.8 (mm) 42.2 x 24.7 x 2.1 (inch)
Weight	With stand	9.5 kg (20.9 lbs)	12.7 kg (27.9 lbs)
	Without stand	9.2 kg (20.2 lbs)	12.3 kg (27.1 lbs)
Current Value / Power consumption		1.1 A / 110 W	1.2 A / 120 W

MODELS		50LB5800 (50LB5800-UG)	55LB5800 (55LB5800-UG)
		50LB6100 (50LB6100-UG)	55LB6100 (55LB6100-UG)
Dimensions (W x H x D)	With stand	1,128 x 708 x 255 (mm)	1,243 x 772 x 255 (mm)
		44.4 x 27.8 x 10 (inch)	48.9 x 30.3 x 10 (inch)
	Without stand	1,128 x 660 x 55.8 (mm)	1,243 x 725 x 56.8 (mm)
		44.4 x 25.9 x 2.1 (inch)	48.9 x 28.5 x 2.2 (inch)
Weight	With stand	14.2 kg (31.3 lbs)	17.7 kg (39.0 lbs)
	Without stand	13.8 kg (30.4 lbs)	17.3 kg (38.1 lbs)
Current Value / Power consumption		1.3 A / 130 W	1.4 A / 140 W

MODELS		60LB6100 (60LB6100-UG)	65LB6190 (65LB6190-UD)
		Dimensions (W x H x D)	With stand
54 x 33.3 x 11 (inch)	57.5 x 35.3 x 12.3 (inch)		
Without stand	1,373 x 801 x 58.8 (mm)		1,462 x 850 x 59.2 (mm)
	54 x 31.5 x 2.3 (inch)		57.5 x 33.4 x 2.3 (inch)
Weight	With stand	23.5 kg (51.8 lbs)	30.5 kg (67.2 lbs)
	Without stand	23.0 kg (50.7 lbs)	29 kg (63.9 lbs)
Current Value / Power consumption		1.5 A / 150 W	1.9 A / 190 W

Wireless LAN module (WN8122E1) specification	
Standard	IEEE802.11a/b/g/n
Frequency Range	2400 to 2483.5 MHz 5150 to 5250 MHz 5725 to 5850 MHz
Output Power (Max.)	802.11a : 16.5 dBm 802.11b : 16 dBm 802.11g : 15.5 dBm 802.11n - 2.4GHz : 15.5 dBm 802.11n - 5GHz : 16.5 dBm
<ul style="list-style-type: none"> <li>Because band channel used by the country could be different, the user can not change or adjust the operating frequency and this product is set for the regional frequency table.</li> <li>This device should be installed and operated with minimum distance 20 cm (7.8 inch) between the device and your body. And this phrase is for the general statement for consideration of user environment.</li> <li>Contains FCC ID: BEJWN8122E1 / Contains IC: 2703H-WN8122E1</li> </ul>	

## EXTERNAL CONTROL DEVICE SETUP

To obtain the external control device setup information, please visit [www.lg.com](http://www.lg.com).

## MAINTENANCE

### Cleaning Your TV

Clean your TV regularly to keep it at peak performance and to extend the product lifespan.

#### CAUTION

- Make sure to turn the power off and disconnect the power cord and all other cables first.
- When the TV is left unattended or unused for a long time, disconnect the power cord from the wall outlet to prevent possible damage from lightning or power surges.

### Screen, frame, cabinet, and stand

To remove dust or light dirt, wipe the surface with a dry, clean, and soft cloth.

To remove major dirt, wipe the surface with a soft cloth dampened in clean water or a diluted mild detergent. Then wipe immediately with a dry cloth.

#### CAUTION

- Do not push, rub, or hit the surface with your fingernail or a sharp object, as this may result in scratches on the screen and image distortions.
- Do not use any chemicals, such as waxes, benzene, alcohol, thinners, insecticides, air fresheners, lubricants, as these may damage the screen's finish and cause discoloration.
- Do not spray liquid onto the surface. If water enters the TV, it may result in fire, electric shock, or malfunction.

ENGLISH

### Power cord

Remove the accumulated dust or dirt on the power cord regularly.

## TROUBLESHOOTING

Problem	Solution
Cannot control the TV with the remote control.	<ul style="list-style-type: none"> <li>• Check the remote control sensor on the product and try again.</li> <li>• Check if there is any obstacle between the product and the remote control.</li> <li>• Check if the batteries are still working and properly installed (⊕ to ⊕, ⊖ to ⊖).</li> </ul>
No image display and no sound is produced.	<ul style="list-style-type: none"> <li>• Check if the product is turned on.</li> <li>• Check if the power cord is connected to a wall outlet.</li> <li>• Check if there is a problem in the wall outlet by connecting other products.</li> </ul>
The TV turns off suddenly.	<ul style="list-style-type: none"> <li>• Check the power control settings. The power supply may be interrupted.</li> <li>• Check if the <b>Sleep Timer/Off Time</b> is activated in the <b>TIME</b> settings.</li> <li>• If there is no signal while the TV is on, the TV will turn off automatically after 15 minutes of inactivity.</li> </ul>

# CHILD SAFETY:

## PROPER TELEVISION PLACEMENT MATTERS



### THE CONSUMER ELECTRONICS INDUSTRY CARES

- Manufacturers, retailers and the rest of the consumer electronics industry are committed to making home entertainment safe and enjoyable.
- As you enjoy your television, please note that all televisions – new and old- must be supported on proper stands or installed according to the manufacturer’s recommendations. Televisions that are inappropriately situated on dressers, bookcases, shelves, desks, speakers, chests, carts, etc., may fall over, resulting in injury.



### TUNE IN TO SAFETY

- **ALWAYS** follow the manufacturer’s recommendations for the safe installation of your television.
- **ALWAYS** read and follow all instructions for proper use of your television.
- **NEVER** allow children to climb on or play on the television or the furniture on which the television is placed.
- **NEVER** place the television on furniture that can easily be used as steps, such as a chest of drawers.
- **ALWAYS** install the television where it cannot be pushed, pulled over or knocked down.
- **ALWAYS** route cords and cables connected to the television so that they cannot be tripped over, pulled or grabbed.



### WALL OR CEILING MOUNT YOUR TELEVISION

- **ALWAYS** contact your retailer about professional installation if you have any doubts about your ability to safely mount your television.
- **ALWAYS** use a mount that has been recommended by the television manufacturer and has a safety certification by an independent laboratory (such as UL, CSA, ETL).
- **ALWAYS** follow all instructions supplied by the television and mount manufacturers.
- **ALWAYS** make sure that the wall or ceiling where you are mounting the television is appropriate. Some mounts are not designed to be mounted to walls and ceilings with steel studs or cinder block construction. If you are unsure, contact a professional installer.
- Televisions can be heavy. A minimum of two people is required for a wall or ceiling mount installation.



### MOVING AN OLDER TELEVISION TO A NEW PLACE IN YOUR HOME

- Many new television buyers move their older CRT televisions into a secondary room after the purchase of a flat-panel television. Special care should be made in the placement of older CRT televisions.
- **ALWAYS** place your older CRT television on furniture that is sturdy and appropriate for its size and weight.
- **NEVER** place your older CRT television on a dresser where children may be tempted to use the drawers to climb.
- **ALWAYS** make sure your older CRT television does not hang over the edge of your furniture.

[CE.org/safety](http://CE.org/safety)





**Declaration of Conformity**

Trade Name	LG
Model	32LB580B-UG, 32LB5800-UG, 39LB5800-UG, 42LB5800-UG, 47LB5800-UG, 50LB5800-UG, 55LB5800-UG 47LB6100-UG, 50LB6100-UG, 55LB6100-UG, 60LB6100-UG, 65LB6190-UD
Responsible Party	LG Electronics Inc.
Address	1000 Sylvan Ave. Englewood Cliffs NJ 07632 U.S.A
TEL	201 - 266 - 2534

**LG Customer Information Center**

For inquires or comments, visit [www.lg.com](http://www.lg.com) or call;

<b>1-800-243-0000</b>	USA, Consumer User
<b>1-888-865-3026</b>	USA, Commercial User
<b>1-888-542-2623</b>	CANADA

**Register your product Online!**

[www.lg.com](http://www.lg.com)

The model and serial number of the TV are located on the back and one side of the TV.

Record them below should you ever need service.

MODEL \_\_\_\_\_

SERIAL \_\_\_\_\_



This product qualifies for ENERGY STAR in the "factory default (Home Use)" setting.

Changing the factory default settings or enabling other features may increase power consumption that could exceed the limits necessary to qualify for ENERGY STAR.

Refer to ENERGY STAR.gov for more information on the ENERGY STAR program.