

Installation

Hardware Installation

NOTES

- Please pay attention to handling Electrostatic Sensitive Devices, you may use anti-static products such as wrist straps, heel straps, mats to protect your body from electrostatic.
- Make sure you have a personal computer with one or two open USB ports before connecting the drive to your computer.
- Power for all other devices should be turn off before attaching the cables.

Connecting to computer

Connect the drive to the computer as shown in figure.

- ① Connect the USB 2.0 (Y type) cable to the drive.
- ② Connect the other end of the USB 2.0 cable to your computer.
- ③ The drive may get its power from the PC USB power. All systems may not meet USB power requirements and full performance may not be achieved. In this case, connect to the USB power cable.

When the computer is ready, confirm that the drive is detected. And then, insert the supplied software CD into the drive and install the software.

NOTES

- Please do not connect the USB cables by any means other than specified above. Using the wrong type of cable with this drive can cause it to malfunction.
- The appliance is not intended for use by young children or infirm persons without supervision. Young Children should be supervised to ensure that they do not play with appliance.
- If the appliance is supplied from a cord extension set or an electrical portable outlet device, the cord extension set on electrical portable outlet device must be positioned so that it is not subject to splashing or ingress of moisture.

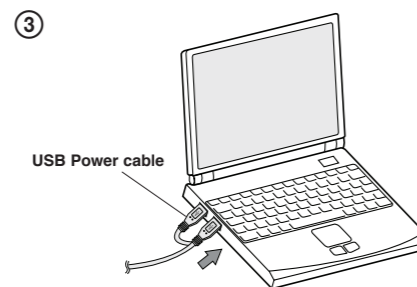
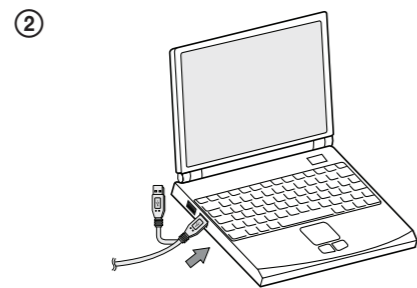
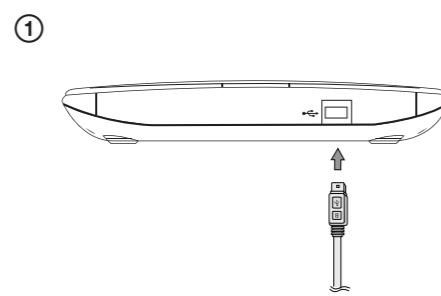

What is TV Connectivity?

TV Connectivity is a function that allows you to enjoy videos, pictures and music by connecting this product to a compatible A/V device (e.g. DIGITAL TV, DIGITAL PHOTO FRAME, PC) that supports USB connectivity.

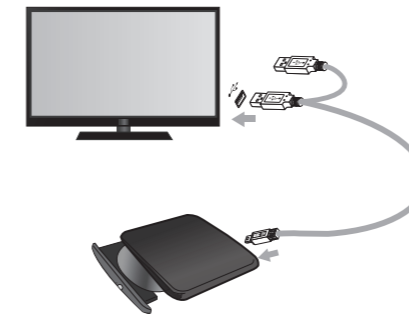

How to Use TV Connectivity

* This product is defaulted to ODD mode when it is powered on.

- ① **With the tray open, press and hold the 'Open/Close' button for 2 seconds.** (The LED indicator will turn on, switching to TV mode. Press and hold the button again for 2 seconds with the tray open to return to ODD mode).
- ② **Insert your supported media into the drive.** The disc file system will be converted to FAT32 and will be recognized as USB flash memory.
- ③ **Select and play the files from your A/V device to enjoy videos, pictures and music.** Refer to your owner's manual for more information.

TV Connectivity Specifications

# of files that can be used (Short Filenames)	About 500 files/13 Characters Standard.
Time for Converting to FAT32 on TV Mode(per 1G byte)	15 Sec/1GB
Supported File System	ISO, UDF(1.02/1.5/2.0/2.01/2.5)

Troubleshooting

- **I cannot find the files in my disc's directory.**
 1. In TV mode, this product supports only about 500 files with filenames fewer than 13 characters.
 2. Files larger than 4GB will not be recognized. The maximum numbers of files and directories that can be displayed may be limited by the file name's length, the numbers of files and directories.
- **It takes too long to recognize my files when I insert a disc in TV mode.**
 1. This function requires converting the ISO/UDF file system typical for disc media to FAT32 which is widely used in PCs. Therefore, it could take extra time to recognize your disc (it takes approximately 15 seconds per 1GB after inserting disc).
- **If I insert a disc while in TV mode, the disc is not recognized.**
 1. This product is powered via USB from an A/V device. If the power of the A/V device is not sufficient (less than 1.4A), it may not operate properly.
- **After connecting to a TV, my videos/pictures/music cannot be played on their own.**
 1. This product is not designed to play media files on its own. The TV Connectivity function simply allows you to connect an external Optical Disc Drive to a TV via a USB cable. Please refer to your television's owner's manual to check whether video/pictures/music can be played on your TV. You will also need to check whether your TV supports the files' codec.
 2. Televisions generally do not have a decoder to play DVD titles, so you cannot play DVD titles using the TV connectivity function. Please use your PC or DVD player to play DVD titles.
 3. Video/Audio CDs cannot be played through this function, as their media structure is different. Use your PC or other players to play video CD and audio CD.
 4. Damaged files may not be played, and there may be some restrictions in some functions during playback.
 5. Videos with a resolution higher than that of your TV may not be displayed properly. Refer to your owner's manual or the manufacturer's website for a list of supported resolutions.
- **Does this function allow me to write onto a writeable disc?**
 1. Our TV Connectivity function is Read-Only and therefore you cannot write.

NOTES

- Normal operation is not guaranteed if you use a USB hub or unspecified USB extension cables.
- Due to compatibility issue of some AV devices and disc, may not work.

To install of your product, please read this guide manual carefully and completely.

Features

- Universal Serial Bus (USB) 2.0 interface for high-speed data transfer.
- Buffer Under Run error protection technology
- Emergency eject support
- Combination of CD-R/RW, DVD-R/RW, DVD+R/RW, DVD+R DL, DVD-R DL, M-Disc (DVD+R SL) and DVD-RAM drive functions into one drive.
- Supports region playback control Phase II.
- PC USB powered, no AC adapter needed.

Package Items

Item	Quantity
- Slim Portable DVD Writer	1
- USB 2.0 cable (Y type)	1
- Software Installation disc	1
- Quick Guide for Drive	1

Cautions

System meeting the following requirements is needed in order to use USB 2.0 operation with this drive.

- Computer that is equipped with a USB 2.0 – compliant USB connector or PCI adapter card, and on which the USB 2.0 EHCI (Enhanced Host Controller Interface) driver software ¹⁾ has been installed.

¹⁾ The USB 2.0 EHCI driver software is supplied with currently available PCI adapter cards that conform to USB 2.0. Further, Microsoft has released the USB 2.0 EHCI driver software for Windows XP, therefore it is also possible to use this driver software with Windows XP SP2.

If you want to know in detail, please contact your USB 2.0 adapter dealer or consult your PC manufacturer, or consult the Microsoft Corporation Web site.

System Environment

Computer

This unit can be operated in the system environment explained here.

System requirements	CPU	Pentium IV 2.4 GHz or Higher(with USB 2.0) for basic performance (Recommended for optimal performance: Pentium IV 3.2 GHz or Higher).
	Memory	256 MB or larger (Recommended: 512 MB).
Hard disk		20 GB or more free space. (The free space needed for writing depends on the quantity of data.)
Video Memory		64 MB (Recommended: 128 MB).
Interface		USB 2.0 port
CD-ROM drive		For Software installation
Software Required OS		Windows 7/Windows Vista (32 bit, 64 bit)/ Windows XP SP2, Mac OS X v.10.5.4 or Higher, Direct X 9.0 or Higher
CD-R, CD-RW, DVD-R, DVD-RW, DVD+R, DVD+RW, DVD-RAM, DVD±R DL discs	CD-R	: LG, Mitsubishi Kagaku Media, Verbatim, That's, TDK, Ritek or HP discs are recommended.
	CD-RW	: LG, Mitsubishi Kagaku Media, Verbatim are recommended.
	DVD-R	: Mitsubishi Kagaku Media, Maxell, That's are recommended.
	DVD-RW	: Victor, JVC, Mitsubishi Kagaku Media, TDK are recommended.
	DVD+R	: Mitsubishi Kagaku Media, That's, Maxell are recommended.
	DVD+RW	: TDK, Mitsubishi Kagaku Media, Ricoh are recommended.
	DVD-RAM	: Maxell, Mitsubishi Kagaku Media are recommended.
	M-Disc (DVD+R SL)	: Millenniata
	DVD±R DL	: Mitsubishi Kagaku Media, Verbatim are recommended.

- For Windows 7/ Windows Vista, 1 GB of RAM or large is recommended.
- Compatibility problem in write/read function may occur with some media depending on the media manufacturing quality.
- To achieve maximum Record & Write speed your system may require data to be copied first to the computer's hard drive rather than directly from another source disc or drive.
- Please visit <http://www.m-disc.com> to learn more about the M-DISC™.

Location and function of controls

This following is the general figure of the design of the drive. The drive's appearance and specifications may change without prior notice.

Front

1. Disc Tray
2. Drive activity indicator
The LED is used to indicate the operation of drive.
3. Eject Button
4. Emergency Eject Hole

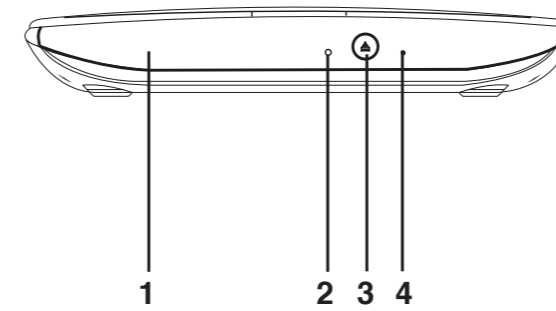

Rear

1. USB Connector (mini)
This connector is used to connect to the USB 2.0 cable.

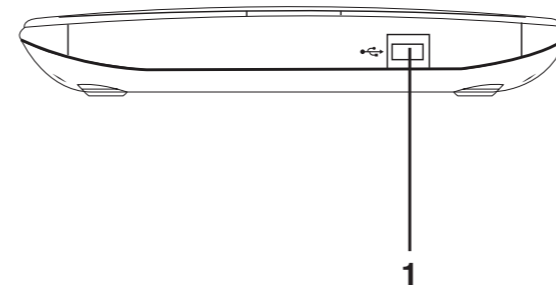

Removing the USB Converter cable (For Windows)

The drive supports the plug and play(not swap) function of Windows, and can be removed and inserted by performing the following operation.

1. Stop the application software being currently used.
2. Click the icon “ ” of the taskbar located on your screen's bottom right side.

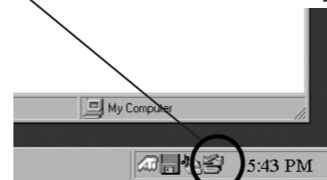

3. Click “Safely Remove USB Mass Storage Device-Drive[x:]”.
4. Click “Ok” and then remove the USB converter cable.

NOTE

Don't remove the USB 2.0 cable when the busy indicator on the drive blinks, or during computer startup. The removing procedure varies depending on your OS.

Safety Instructions

- CAUTION:** The laser used in the Writer can damage your eyes. Do not attempt to open the cover. To reduce the risk of electric shock, do not remove the cover (or back). There are no user-serviceable parts inside. Refer servicing to qualified service personnel. Use of controls or performance of procedures other than those specified herein may result in hazardous radiation exposure.
- WARNING:** To reduce the risk of fire or electric shock, do not expose this appliance to rain or moisture.

- VORSICHT:** Der in diesem Laufwerk benutzte Laser kann Ihre Augen schädigen. Versuchen Sie keinesfalls, die Abdeckung zu öffnen. Um die Gefahr eines elektrischen Schocks zu reduzieren, sollten Sie die Abdeckung (oder Rückseite) keinesfalls entfernen. Im Inneren des Geräts befinden sich keine Teile, die vom Benutzer selbst gewartet werden können. Überlassen Sie die Wartung qualifizierten Kundendiensttechnikern. Beachten Sie bei der Benutzung von Bedienelementen und der Durchführung von Prozeduren unbedingt die Anweisungen dieses Handbuchs, da andernfalls gefährliche Strahlung freigesetzt werden kann.
- WARNING:** Setzen Sie das Laufwerk keinesfalls Regen oder Feuchtigkeit aus, um die Gefahr eines Brandes oder elektrischen Schocks zu reduzieren.

- ATTENTION:** l'exposition au laser utilisé dans le graveur présente un danger pour les yeux. N'essayez pas d'ouvrir le capot. Afin de réduire les risques de chocs électriques, ne retirez pas le capot (ni l'arrière du dispositif). Aucune pièce interne ne peut être remplacée par l'utilisateur. Pour la maintenance de l'appareil, adressez-vous au personnel qualifié du service de maintenance. L'utilisation de commandes ou de procédures différentes de celles spécifiées ci-après peut entraîner une exposition à des rayons dangereux.

- AVERTISSEMENT:** Ne pas exposer ce matériel à la pluie ou à l'humidité (risques d'incendie et d'électrocution).

- PERICOLO:** Il dispositivo di lettura e scrittura utilizzato in questo masterizzatore utilizza un raggio laser che, se osservato da vicino, può danneggiare la vista. Evitare di smontare il coperchio dell'apparecchio. Al fine di prevenire eventuali folgorazioni, evitare di smontare l'apparecchio. All'interno dell'apparecchio non sono presenti parti che richiedono manutenzione da parte dell'utente. In caso di difetti o guasti, rivolgersi ad un Centro di Assistenza Tecnica. L'esecuzione di procedure diverse da quella espressamente indicate in questo manuale può provocare pericolose esposizioni alle radiazioni laser.
- ATTENZIONE:** Al fine di evitare cortocircuiti o principi di incendio, evitare di esporre questo apparecchio alla pioggia o ad una eccessiva umidità ambientale.

- PRECAUCION:** El láser utilizado en la unidad puede dañar sus ojos. No intente abrir la tapa. Para reducir el riesgo de descarga eléctrica, no quite la tapa (ni la parte posterior). No hay piezas internas que deba mantener el usuario. El servicio de mantenimiento debe efectuarse personal técnico cualificado. El uso de controles o la ejecución de procedimientos distintos de los especificados en este manual pueden ser causa de exposición a radiación peligrosa.
- ADVERTENCIA:** Para reducir el riesgo de fuego o descarga eléctrica, no exponga este aparato a la lluvia ni a la humedad.

- CUIDADO:** O laser utilizado na unidade pode causar lesões oculares. Não tente abrir a tampa. Para reduzir o risco de choques eléctricos, não retire a tampa (quer frontal quer superior). A unidade não contém peças que possam ser reparadas pelo utilizador. Deixe a manutenção para um técnico da assistência qualificada. A utilização de controlos ou a execução de procedimentos que não sejam os especificados neste manual podem causar a exposição a radiações perigosas.
- AVISO:** Para reducir o risco de incêndio ou choque elétrico não exponha este aparelho à chuva ou humidade.

Specifications

Supported Discs	DVD-ROM(Single/Dual), DVD-RW, DVD-R, DVD+RW, DVD+R, DVD+R Double layer, DVD-R Dual layer, DVD-RAM, M-Disc (DVD+R SL), CD-Digital Audio & CD-Extra, CD-Plus, CD-ROM, CD-ROM XA-Ready, CD-I FMV, CD-TEXT, CD-Bridge, CD-R, CD-RW, Photo-CD (Single & Multi-Session), Video CD, DVD-VIDEO
Dimensions (WxHxD)	157 x 25 x 146 (mm)
Weight	About 265 g
Interface	USB 2.0
Read/Write Speed	
Write :	(DVD-R): 2x, 4x, 8x (DVD-R DL): 2x, 4x, 6x (DVD-RW): 2x, 4x, 6x (DVD-RAM): 2x, 3x, 5x (Ver. 2.2 & higher) M-Disc (DVD+R SL): 4x (DVD+R): 2.4x, 4x, 8x (DVD+R DL): 2.4x, 4x, 6x (DVD+RW): 2.4x, 3.3x, 4x, 8x (CD-R): 10x, 16x, 24x (CD-RW): 4x, 10x, 16x, 24x
Read :	(DVD-R/RW/ROM): 8x/8x/8x max. (DVD-R DL): 8x max. (DVD-RAM) (Ver.2.2 & Higher): 5x max. M-Disc (DVD+R SL): 8x max. (DVD-Video) (CSS Compliant Disc): 4x max. (DVD+R/RW): 8x/8x max. (DVD+R DL): 8x max. (CD-R/RW/ROM): 24x/24x/24x max. (CD-DA (DAE)): 24x max.

- * The drive's appearance and specifications may change without prior notice.
- The maximum data transfer rate varies according to the performance capabilities of the PC.
- For the sake of periodic improvements, specifications and appearance are subject to change without notice.
- We have taken all possible measures to assure the quality of our products, but we cannot be responsible for the consequences if defect occurs.

Data transfer rate	
Sustained	CD-ROM : 3,600 kB/s (24x max) DVD-ROM : 11.08 MB/s (8x max)
Average Access Time (1/3 Stroke)	CD-ROM : 139 ms (Typical) DVD-ROM : 167 ms (Typical) DVD-RAM : 203 ms (Typical)
Buffer capacity	1.0 MB
MTBF	60,000 Power On Hours (Duty Cycle 10 %)
Power Requirement	5 V DC
Operating Environment	
Temperature	5 °C to 40 °C
Humidity	15 % to 85 %
Storage Environment	
Temperature	-30 °C to 60 °C
Humidity	10 % to 90 % RH

Software

Install the appropriate CD Recording Authoring Software before using this unit.

* Please uninstall any previous CD burning software you may have loaded on your PC in order to prevent possible compatibility issues. Once you have installed the application software, you may (if you wish) begin to reinstall previous software, taking note for errors. We recommend using the drive with the latest software as some problems encountered when using the drive can be solved by updating the software.

Please visit www.lgservice.com and install the program, "LG ODD Online F/W update." By using the program, you can automatically check the latest information about FirmWare and update the FirmWare.

Worldwide support ; <http://www.LGservice.com>
Worldwide corporate site : <http://www.LG.com>

