



# OWNER'S MANUAL MICROWAVE OVEN

PLEASE READ THIS OWNER'S MANUAL THOROUGHLY BEFORE OPERATING AND KEEP IT HANDY FOR REFERENCE AT ALL TIMES.

LMH2235\* \*



MFL56516421\_08

[www.lg.com](http://www.lg.com)

Copyright © 2014 - 2017 LG Electronics Inc. All Rights Reserved.

## ***Thank you for purchasing an LG microwave oven.***

Please record the model number and serial number of this unit for future reference. We also suggest you record the details of your contact with LG (LG Electronics U.S.A., Inc.) concerning this unit.

Model No: \_\_\_\_\_

Serial No: \_\_\_\_\_

Dealer: \_\_\_\_\_

\_\_\_\_\_

\_\_\_\_\_

Dealer Phone No: \_\_\_\_\_

Staple your receipt here as proof of purchase.

Customer Relations  
LG Electronics U.S.A., Inc.  
Service Division Bldg. #3  
201 James Record Rd.  
Huntsville, AL 35824-0126

## **PRECAUTIONS TO AVOID POSSIBLE EXPOSURE TO EXCESSIVE MICROWAVE ENERGY**

- (a) Do not attempt to operate this oven with the door open. Open door operation can result in harmful exposure to microwave energy. It is important not to defeat or tamper with the safety interlocks.
- (b) Do not place any object between the oven front face and the door or allow soil or cleaner residue to accumulate on sealing surfaces.
- (c) Do not operate the oven if it is damaged. It is particularly important that the oven door:
  - (1) closes properly,
  - (2) is not damaged or bent,
  - (3) has hinges and latches that are not broken or loosened,
  - (4) has undamaged door seals and sealing surfaces.
- (d) The oven should not be adjusted or repaired by anyone except properly qualified service personnel.

# TABLE OF CONTENTS

<b>PRECAUTIONS TO AVOID POSSIBLE EXPOSURE TO EXCESSIVE MICROWAVE ENERGY .....</b>	<b>2</b>	Cooking Guide for Sensor Cook .....	16
<b>IMPORTANT SAFETY INSTRUCTIONS .....</b>	<b>4~5</b>	Timer .....	17
<b>SPECIFICATIONS.....</b>	<b>6</b>	Soften.....	17
Location of Model Number .....	6	Melt .....	17
Oven Specifications .....	6	Kids Meal .....	17
Electrical Rating .....	6	Soften Table .....	18
Electrical Requirements .....	6	Melt Table.....	18
Grounding Instructions .....	6	Defrost .....	19
<b>FEATURES .....</b>	<b>7-9</b>	Defrost Table .....	19
Microwave Oven Features .....	7	Quick Defrost .....	19
Oven Control Panel.....	8~9	Time Defrost.....	20
<b>USING YOUR MICROWAVE OVEN .....</b>	<b>10-20</b>	Defrosting Tips .....	20
Learn About Your Microwave Oven.....	10	Metal Rack .....	20
Audible Signals .....	10	Slide-out Hood.....	20
Interrupting Cooking.....	10	<b>COOKING TIPS .....</b>	<b>21~25</b>
Glass Touch Controller.....	10	Getting the Best Cooking Results .....	21
Clock .....	10	Fish & Shellfish .....	21
Child Lock .....	10	Fish and Shellfish Cooking Table .....	21
Light Hi/Low/Off.....	11	Appetizers / Sauces / Soups .....	22
Energy Saving.....	11	Meat .....	22
Turntable On/Off.....	11	Meat Cooking Table .....	23
Vent On/Off .....	11	Poultry .....	24
Vent 4 Speed.....	11	Poultry Cooking Table .....	24
Add 30 Sec.....	11	Pasta and Rice.....	25
Microwave Power Levels .....	12	Pasta Cooking Table .....	25
Custom Set.....	12	Rice Cooking Table .....	25
Multi -Stage Cooking.....	12	<b>MAINTENANCE .....</b>	<b>26~27</b>
+ / - .....	12	Care and Cleaning .....	26
Custom Cook.....	12	Metal Rack .....	26
Cooking Guide for Lower Power Levels.....	13	Cleaning the Grease Filters .....	26
Sensor Operating Instructions.....	14	Charcoal Filter Replacement.....	26
Sensor Cooking Guide.....	14	Cooktop/Night Light Replacement .....	27
Sensor Popcorn .....	14	Oven Light Replacement.....	27
Sensor Reheat .....	15	<b>COOKING UTENSILS.....</b>	<b>28</b>
Sensor Cook .....	15	Microwave Utensil Guide .....	28
Cooking Guide for Sensor Reheat .....	15	<b>FAQS.....</b>	<b>29</b>
Cooking Guide for Sensor Popcorn .....	16	<b>TROUBLESHOOTING .....</b>	<b>30</b>
		<b>LIMITED WARRANTY-USA.....</b>	<b>31</b>

# IMPORTANT SAFETY INSTRUCTIONS

## IMPORTANT SAFETY INSTRUCTIONS

The safety instructions below will tell you how to use your oven and avoid harm to yourself or damage to your oven.

### **WARNING**

Hazards or unsafe practices that may result in severe personal injury or death.

### **CAUTION**

Hazards or unsafe practices that may result in minor personal injury or property damage.

### **WARNING**

- To reduce the risk of burns, electric shock, fire, injury to persons, or exposure to excessive microwave energy.

- **Read all the instructions before using your oven**
- **Do not allow children to use this oven without close supervision.**
- Read and follow the specific

## PRECAUTIONS TO AVOID POSSIBLE EXPOSURE TO EXCESSIVE MICROWAVE ENERGY

found on page 2.

- **Do not use** corrosive chemicals or vapors, such as sulfide and chloride, in this appliance. This type of oven is specifically designed to heat, cook, or dry food. It is not designed for industrial or laboratory use.
- **Do not store** this appliance outdoors. Do not use this product near water - for example, near a kitchen sink, in a wet basement, near a swimming pool, or in a similar location.
- **Do not use** the oven cavity for storage purposes. Do not leave paper products, cooking utensils, or food in the oven cavity when not in use.
- **Clean the ventilating hood frequently.** Do not allow grease to accumulate on the hood or the filters.
- Use care when cleaning the vent hood filters. Corrosive cleaning agents such as lye-based oven cleaners may damage the filters.
- **Do not tamper with the built-in safety switches on the oven door.** The oven has several built-in safety switches to make sure the power is off when the door is open.
- **Turn the fan on to disperse steam or smoke under the hood.** Keep the area under the hood properly ventilated at all times. Turn off cooking equipment if you see flames or a fire occurs.

- Suitable for use above both gas and electric cooking equipment up to 36 inches wide.
  - **Do not use this oven for commercial purposes** It is designed for household use only.
  - **When cleaning the door and the surfaces that touch the door, use only mild, non-abrasive soaps or detergents and a sponge or soft cloth.**
  - **If your oven is dropped or damaged** have it thoroughly checked by a qualified service technician before using it again.
  - **To avoid a fire hazard**
    - **Do not severely overcook food.** Severely overcooked foods can start a fire in the oven. Watch the oven carefully, especially if you have paper, plastic, or other combustibles in the oven.
    - **Do not store combustible items (bread, cookies, etc.) in the oven,** because if lightning strikes the power lines it may cause the oven to turn on.
    - **Do not use wire twist-ties in the oven.** Be sure to inspect purchased items for wire twist-ties and remove them before placing the item in the oven.
  - **If a fire should start in the oven:**
    - **Keep the oven door closed.**
    - **Turn the oven off.**
    - **Disconnect the power cord or shut off the power at the fuse or circuit breaker panel.**
  - **To avoid electric shock**
    - **This appliance must be grounded.** Connect it only to a properly grounded outlet. See the electrical **GROUNDING INSTRUCTIONS** on page 6.
    - **Do not operate this appliance if it has a damaged cord or plug,** if it is not working properly or if it has been damaged or dropped.
    - **Do not immerse the electrical cord or plug in water.**
    - **Keep the cord away from heated surfaces.**
- NOTE:** Turn the microwave's vent fan on whenever you use the oven range cooktop below it. The fan captures smoke, steam, and odors and also prevents the heat from the cooktop from damaging microwave components. If the microwave is cooking, the vent fan turns on automatically if the sensors detect too much heat from the cooktop. This is normal, and is designed to prevent microwave component damage.

# IMPORTANT SAFETY INSTRUCTIONS

- **To avoid improperly cooking some foods.**
  - **Do not heat any types of baby bottles or baby food.** Uneven heating may occur and possibly cause personal injury.
  - **Do not heat small-necked containers,** such as syrup bottles.
  - **Do not deep-fat fry in your microwave oven.**
  - **Do not attempt home canning in your microwave oven.**
  - **Do not heat the following items in the microwave oven:** whole eggs in the shell, water with oil or fat, sealed containers, or closed glass jars. These items may explode.
- Do not cover or block any openings in the oven.
- Use your oven only for the operations described in this manual.
- Do not run the oven empty, without food in it.
- Do not let the cord hang over the edge of the table or counter.
- **Preserve the oven floor:**
  - **Do not heat the oven floor excessively.**
  - **Do not** allow the gray film on special microwave-cooking packages to touch the oven floor. Put the package on a microwavable dish.
  - **Do not** cook anything directly on the oven floor or turntable. Use a microwavable dish.
  - Keep a browning dish at least 3/16 inch above floor. Carefully read and follow the instructions for the browning dish. If you use a browning dish incorrectly, you could damage the oven floor.
- Install or locate this appliance only in accordance with the provided installation instructions.
- This appliance should be serviced only by qualified service personnel. Contact the nearest authorized service facility for examination, repair, or adjustment.
- Liquids, such as water, coffee, or tea are able to be overheated beyond the boiling point without appearing to be boiling. Visible bubbling or boiling when the container is removed from the microwave oven is not always present.

THIS COULD RESULT IN VERY HOT LIQUIDS SUDDENLY BOILING OVER WHEN THE CONTAINER IS DISTURBED OR A SPOON OR OTHER UTENSIL IS INSERTED INTO THE LIQUID.

To reduce the risk of injury to persons;

- Do not overheat the liquid.
- Stir the liquid both before and halfway through heating it.
- Do not use straight-sided containers with narrow necks.
- After heating, allow the container to stand in the microwave oven for a short time before removing the container.
- Use extreme care when inserting a spoon or other utensil into the container.

## SAVE THESE INSTRUCTIONS

### FEDERAL COMMUNICATIONS COMMISSION RADIO FREQUENCY INTERFERENCE STATEMENT (U.S.A. ONLY)

#### **WARNING:**

This equipment generates and uses ISM frequency energy and if not installed and used properly, that is in strict accordance with the manufacturer's instructions, may cause interference to radio and television reception. It has been type tested and found to comply with limits for ISM Equipment pursuant to part 18 of FCC Rules, which are designed to provide reasonable protection against such interference in a residential installation. However, there is no guarantee that interference will not occur in a particular installation. If this equipment does cause interference to radio or television reception, which can be determined by turning the equipment off and on, the user is encouraged to try to correct the interference by one or more of the following:

- Reorient the receiving antenna of the radio or television.
- Relocate the Microwave Oven with respect to the receiver.
- Move the microwave oven away from the receiver.
- Plug the microwave oven into a different outlet so that the microwave oven and the receiver are on different branch circuits.

**The manufacturer** is not responsible for any radio or TV interference caused by **unauthorized modification** to this microwave oven. It is the responsibility of the user to correct such interference.

 **WARNING:** This product contains chemicals known to the State of California to cause cancer and birth defects or other reproductive harm.

***Wash hands after handling. (US only)***

# SPECIFICATIONS

## LOCATION OF MODEL NUMBER

To request service information or replacement parts, the service center will require the complete model number of your microwave oven. The number is on the inside of the door frame as shown in the illustration below.

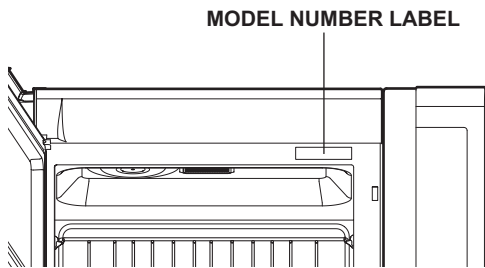

## OVEN SPECIFICATIONS

Output Power	1,000W (IEC 60705 Standard)
Outer Dimensions	29 7/8" X 17 13/18" X 15 13/16"
Cavity Volume	2.2 Cu.ft
Net Weight	60.9 lbs.

## ELECTRICAL RATING

- \* Electrical Rating of the Oven: 120V AC 60Hz
- \* 14 Amps / 1600 Watts ( MWO + Cooktop Lamp + Ventilation Fan)

## ELECTRICAL REQUIREMENTS

The oven is designed to operate on a Standard 120V/60Hz household outlet. Be sure the circuit is at least 15A or 20A and the microwave oven is the **only appliance on the circuit**. It is not designed for 50Hz or any circuit other than a 120V/60Hz circuit.

## GROUNDING INSTRUCTIONS

**This appliance must be grounded.** If an electrical short circuit occurs, grounding reduces the risk of electric shock by providing an escape wire for the electric current. The cord for this appliance has a grounding wire with a grounding plug. Put the plug into an outlet that is properly installed and grounded.

**⚠ WARNING** - If you use the grounding plug improperly, you risk electric shock.

Ask a qualified electrician if you do not understand the grounding instructions or if you do not know whether the appliance is properly grounded.

Because this appliance fits under the cabinet, it has a short power-supply cord. See the separate Installation Instructions for directions on properly placing the cord. Keep the electrical power cord dry and do not pinch or crush it in any way.

If it is necessary to use an extension cord, use only a 3-wire extension cord that has a 3-blade grounding plug, and a 3-slot receptacle that will accept the plug on the appliance. The marked rating of the extension cord should be equal to or greater than the electrical rating of the appliance.

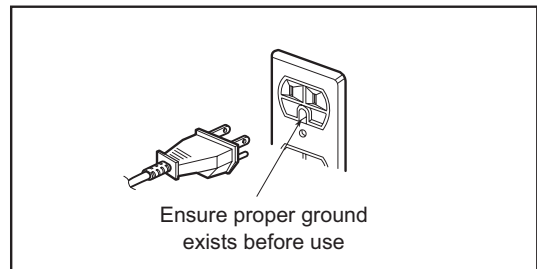

For a permanently connected appliance: This appliance must be connected to a grounded, metallic, permanent wiring system, or an equipment grounding conductor should be run with the circuit conductors and connected to the equipment grounding terminal or lead on the appliance.

# FEATURES

## MICROWAVE OVEN FEATURES

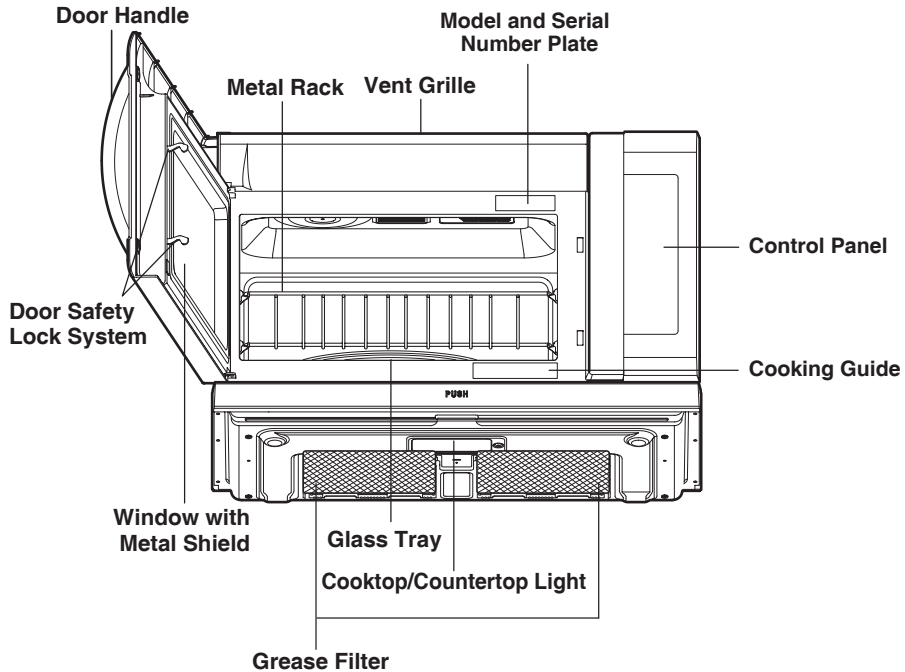

### **⚠ WARNING:**

Do not operate the oven when empty or without the glass tray. It is best to leave a glass of water in the oven when not in use. The water will safely absorb all microwave energy, if the oven is accidentally started.

Your microwave oven is designed to make your cooking experience as enjoyable and productive as possible. To get you up and running quickly, the following is a list of the oven's basic features:

- 1. Metal Shielded Window.** The shield prevents microwaves from escaping. It is designed as a screen to allow you to view food as it cooks.
- 2. Model and Serial Number Plate, Cooking Guide & Service call Label**
- 3. Charcoal Filter** (behind Vent Grille)
- 4. Vent Grille**
- 5. Glass Tray.** The glass tray moves food as it cooks for more even cooking. It must be in the oven during operation for best cooking results.
- 6. Cooktop/Countertop Light**
- 7. Control Panel.** Touch the buttons on this panel to perform all functions.
- 8. Metal Rack.** Use for extra space when cooking in more than one container at the same time. Remove cooking rack when you are not using it.
- 9. Grease Filter**
- 10. Slide-Out Hood.** Push the Slide-out hood to move the slide-out hood to the Front or Rear. This will allow you to remove the steam and other vapors more effectively from surface cooking.

# FEATURES

## OVEN CONTROL PANEL

Your microwave oven control panel lets you select the desired cooking function quickly and easily. All you have to do is touch the necessary Command pad. The following is a list of all the Command and Number pads located on the control panel. For more information on these features, see the **USING YOUR MICROWAVE OVEN** section.

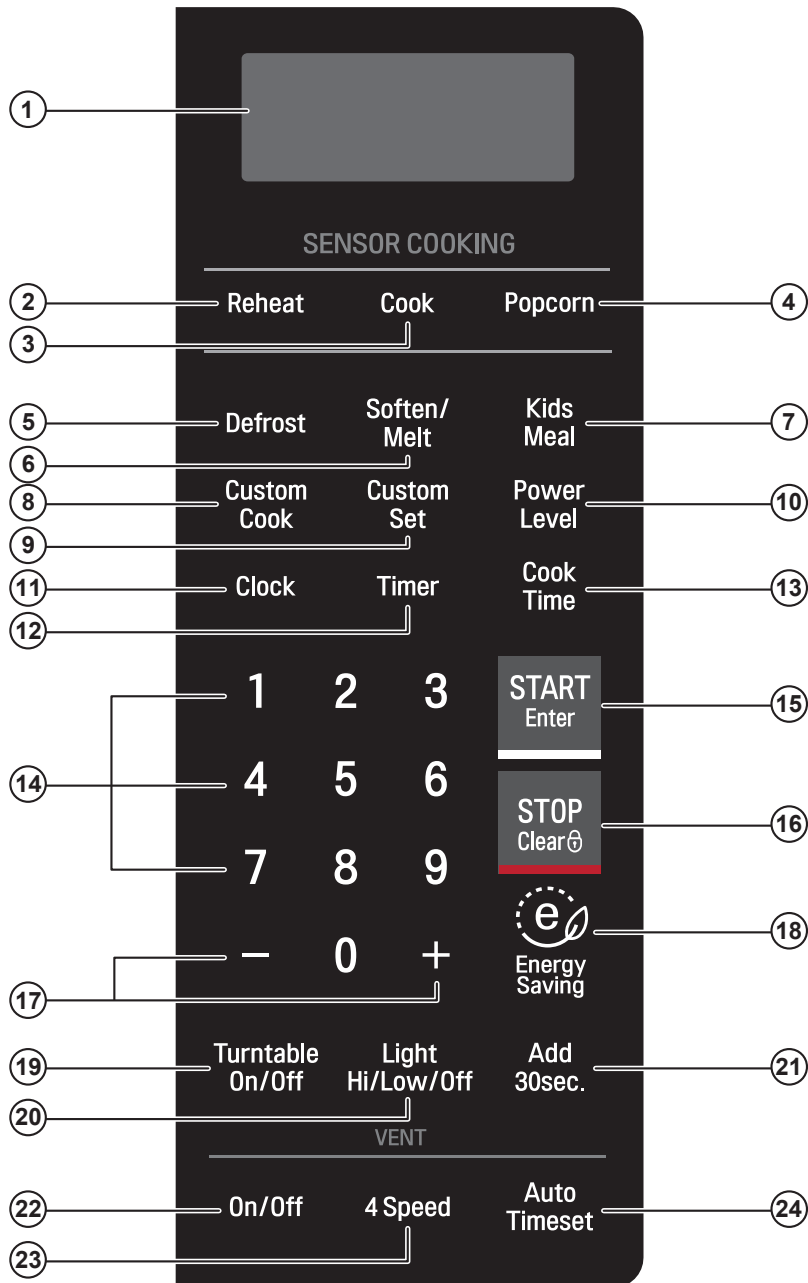

## USING GLASS TOUCH CONTROLLER

1. Touch the middle of letter or number to activate.
2. If you touch the button with a fingernail or fingertip, the controller may not sense it is being touched.
3. If the controller or your hands are wet it may not sense your touch.
4. Remove gloves prior to touching the controller.



# FEATURES

- 1. Display.** The Display includes a clock and indicators to tell you time of day, cooking time settings and cooking functions selected.
- 2. Reheat.** Reheat has preset Power Levels for 6 categories including a casserole, dinner plate, and soup/sauce. The oven's sensor will tell the oven how long to cook depending on the amount of humidity it detects from the food.
- 3. Cook.** Cook has preset Power Levels for 13 categories including frozen lasagna, casseroles, and rice. The oven's sensor will tell the oven how long to cook depending on the amount of humidity it detects from the food.
- 4. Popcorn.** Touch this button when popping popcorn in your microwave oven. The oven's sensor will tell the oven how long to cook depending on the amount of humidity it detects from the popcorn.
- 5. Defrost.** Touch this button to defrost frozen food.
- 6. Soften/Melt.**
  - **Soften:** Touch this button to soften butter, ice cream, cream cheese, frozen juice.
  - **Melt:** Touch this button to melt butter or margarine, chocolate, cheese, and marshmallows.
- 7. Kids Meal.** Select type of dish to reheat Mac & Cheese, Hot dog or Chicken nuggets.
- 8. Custom Cook.** Touch this button to make oven remember Cook time and Power level.
- 9. Custom Set.** Touch this pad to change the oven's default setting for sound, clock, display speed, and defrost weight.
- 10. Power Level.** Touch this button to select a cooking power level.
- 11. Clock.** Touch this button to enter the time of day.
- 12. Timer.** Touch this button to start the kitchen timer.
- 13. Cook Time.** Touch this button to set a cooking time.
- 14. Number.** Touch number buttons to enter cooking time, power level, quantities or weights.
- 15. START/Enter.** Touch this button to start a function. If you open the door after the oven begins to cook, touch START/Enter again.
- 16. STOP/Clear.** Touch this button to stop the oven or clear all entries.
- 17. +, -.** Touch this button to add or subtract ten seconds of cooking time each time you touch it.
- 18. Energy Saving.** Touch this button to save energy.
- 19. Turntable On/Off.** Touch this button to turn on/off the turntable. This option is not available in sensor cook, defrost, soften and melt modes.
- 20. Light High/Low/Off.** Touch this button to turn the cooktop/countertop light on high/low or off.
- 21. Add 30Sec.** Touch this button to add 30 seconds of cooking time each time you touch it.
- 22. Vent On/Off.** Touch button to turn the vent on slow or off.
- 23. Vent 4 Speed.** Touch button to change vent speed.
- 24. Vent Auto Timeset.** Touch this button to set ventilation time. (1, 3, 5, 10, and 30 minutes.)

# USING YOUR MICROWAVE OVEN

## LEARN ABOUT YOUR MICROWAVE OVEN

This section discusses the concepts behind microwave cooking and introduces you to the basics you need to know to operate your microwave oven. Please read this information before using your oven.

### CAUTION

To avoid risk of personal injury or property damage, do not run the oven empty.

To avoid risk of personal injury or property damage, do not use stoneware, large sheets of aluminum foil, metal utensils, or metal trimmed utensils in the oven. Keep aluminum foil at least 1 inch from the oven wall, metal rack and other pieces of foil.

## AUDIBLE SIGNALS

Audible signals are available to guide you when setting and using your oven:

- A beep will sound each time you touch a button.
- 4 beeps signals the end of a cooking cycle.

## INTERRUPTING COOKING

You can stop the oven during a cycle by opening the door. The oven stops heating and the fan stops, but the light stays on.

**To restart cooking, close the door and touch START/Enter.**

**If you do not want to continue cooking, open the door and touch STOP/Clear.**

## SLIDE OUT VENTILATION

Push bottom of unit to extend hood and back side down, Extended hood is more powerful to gather smoke and steam from cooktop.

## GLASS TOUCH CONTROLLER

- Touch the middle of letter or number to activate.
- If you touch the button with a fingernail or fingertip, the controller may not sense it is being touched.
- If the controller or your hands are wet it may not sense your touch.
- Remove gloves prior to touching the controller.
- Use the child lock feature when cleaning the controller to avoid unintended activation.

## CLOCK

When the oven is first plugged in or after a power failure, the display will show "PLEASE SET TIME OF DAY". If a time of day is not set, " : " will show on the display with beep.

Example: To set the clock for 8:00 am

- |                       |  |
|-----------------------|--|
| <b>Clock</b>          | 1. Touch <b>Clock</b> .                        |
| <b>8 0 0</b>          | 2. Enter the time by using the number buttons. |
| <b>START</b><br>Enter | 3. Touch <b>START/Enter (or Clock)</b>         |
| <b>1</b>              | 4. Enter <b>1</b> to set "am"                  |
| <b>START</b><br>Enter | 5. Touch <b>START/Enter</b> .                  |

## CHILD LOCK

Use this safety feature to lock the control panel when you are cleaning the oven, or so that children cannot use the oven unsupervised.

Example: To set the child lock.

- |                        |  |
|------------------------|--|
| <b>STOP</b><br>Clear Ⓞ | 1. Touch and hold <b>STOP/Clear</b> until you hear 2 beeps and "LOCKED" appears (approximately 4 seconds). |
|------------------------|--|

Example: To cancel the child lock.

- |                        |  |
|------------------------|--|
| <b>STOP</b><br>Clear Ⓞ | 1. Touch and hold <b>STOP/Clear</b> until "LOCKED" disappears (approximately 4 seconds). |
|------------------------|--|

# USING YOUR MICROWAVE OVEN

## LIGHT HI/LOW/OFF

This button on the controller controls the cooktop light.

Example: To set the Lamp for ON

**Light Hi/Low/Off** 1. Touch **Light Hi/Low/Off**.  
To turn on, touch once. "Light" will flash in display, then stay on.

**Light Hi/Low/Off** 2. Touch **Light Hi/Low/Off**.  
To turn off, touch button again. "Light" will disappear from the display.

## ENERGY SAVING

The **Energy Saving** feature saves energy by turning off the display by pressing the Energy Saving button.

The display will automatically turn off after 5 minutes of idleness.

À



Energy Saving

1. Touch **Energy Saving** to turn the display off.



Energy Saving

2. Touch **Energy Saving** to turn the display on.

## TURNTABLE ON/OFF

For best cooking results, leave the turntable on. It can be turned off for large dishes. Touch **Turntable On/Off** button to turn the turntable on or off.

### NOTES:

1. This option is not available in sensor cook, defrost, kids meal and soften/melt modes.
2. Sometimes the turntable can become hot to touch. Be careful when touching the turntable during and after cooking.
3. Do not run the oven when empty.

## VENT ON/OFF

The vent removes steam and other vapors from the surface cooking area.

**On/Off** 1. Touch **Vent On/Off**.  
Touch once. "FAN SLOW" will scroll in the display. Fan will work on slow speed.

**On/Off** 2. Touch **Vent On/Off**.  
Fan will turn off. "FAN OFF" will scroll in display.

**NOTE:** Turn the microwave's vent fan on whenever you use the oven range cooktop below it. The fan captures smoke, steam, and odors and also prevents the heat from the cooktop from damaging microwave components.

If the microwave is cooking, the vent fan turns on automatically if the sensors detect too much heat from the cooktop. This is normal, and is designed to prevent microwave component damage.

## VENT 4 SPEED

**4 Speed**

When the fan is on, touch this button to toggle the fan speed. Fan speed will change in sequence from slow, low, high, turbo and back to slow.

## ADD 30 SEC

A time-saving button, this simplified control lets you quickly set and start microwave cooking without the need to touch **START/Enter**.

Example: To set ADD 30 SEC for 2 minutes.

**Add 30sec.**

Touch **Add 30 Sec.** 4 times. The oven begins cooking and the display shows time counting down.

**NOTE:** If you continue to touch **Add 30 Sec.**, it will add 30 seconds up to 99 min 59 seconds.

# USING YOUR MICROWAVE OVEN

## COOKING AT HIGH COOK POWER

Example: To cook food for 8 minutes 30 seconds.

8 3 0

1. Enter the cook time.

START  
Enter

2. Touch **START/Enter**.  
When the cook time is over, you will hear four beeps and "COOK END" will scroll in display.

## MICROWAVE POWER LEVELS

This feature lets you program a specific cook time and power. For best results, there are 10 power level settings in addition to HIGH (100%) power. Refer to the "Cooking Guide for Lower Power Levels" on page 13 for more information.

**NOTE:** If you do not select a power level, the oven will automatically cook at HIGH (100%) power.

Example: To cook for 5 minutes, 30 seconds at 80% power.

5 3 0

1. Enter cook time.

Power  
Level

2. Touch **Power Level**.

8

3. Enter the power level.

START  
Enter

4. Touch **START/Enter**. When the cook time is over, four beeps will sound and "COOK END" will display.

## CUSTOM SET

You can change the default values for beep sound, clock, display speed, and defrost weight.

See following chart for more information.

No.	Function	No.	Result
1	Beep ON/ OFF control	1 2	Sound ON Sound OFF
2	Clock display control	1 2	Clock ON Clock OFF
3	Display	1 2 3	Slow speed Normal speed Fast speed
4	Defrost weight mode selected	1 2	Lbs. Kg.

Example: To change defrost weight mode (from Lbs. to Kg).

Custom  
Set

1. Touch **Custom Set**.

4

2. Touch **4**.

2

3. Touch **2**.

## MULTI-STAGE COOKING

For best results, some recipes call for different power levels during different stages of a cook cycle. You can program your oven to switch from one power to another for up to 2 stages. 3 stages can be programmed if the first stage is the defrost cycle.

Example: To cook food for 3 minutes at 100% power and then 70% power for 7 minutes 30 seconds.

3 0 0

1. Enter the first cook time.

Cook  
Time

2. Touch **Cook Time**.

7 3 0

3. Enter the second cook time.

Power  
Level

4. Touch **Power Level**.

7

5. Enter the power level.

START  
Enter

6. Touch **START/Enter**.

When the cook time is over, four beeps will sound and "COOK END" will display.

## + / -

By using the More or Less buttons, all of the pre-programmed features like Cook can be adjusted to cook food for a longer or shorter time.

Touching + will add 10 seconds to the cooking time each time you touch it. Touching - will subtract 10 seconds from the cooking time each time you touch it.

## CUSTOM COOK

CUSTOM COOK lets you to recall one cooking instruction previously placed in memory and begin cooking quickly.

Example: To memorize for 2 minutes.

Custom  
Cook

1. Touch **Custom Cook**.

2 0 0

2. Enter the cook time.

START  
Enter

3. Touch **START/Enter**.

Example: To recall the memory.

Custom  
Cook

1. Touch **Custom Cook**.

START  
Enter

2. Touch **START/Enter**.

When the cook time is over, you will hear four beeps and **END** will display.

# USING YOUR MICROWAVE OVEN

## COOKING GUIDE FOR LOWER POWER LEVELS

The 10 power levels in addition to HIGH allow you to choose the best power level for the food you are cooking. Below are listed all the power levels, examples of foods best cooked at each level, and the amount of microwave power you are using.

POWER LEVEL	MICROWAVE OUTPUT	USE
10 High	100%	<ul style="list-style-type: none"> <li>● Boil water</li> <li>● Cook ground beef</li> <li>● Make candy</li> <li>● Cook fresh fruits and vegetables</li> <li>● Cook fish and poultry</li> <li>● Preheat browning dish</li> <li>● Reheat beverages</li> <li>● Cook bacon slices</li> </ul>
9	90%	<ul style="list-style-type: none"> <li>● Reheat meat slices quickly</li> <li>● Saute onions, celery, and green pepper</li> </ul>
8	80%	<ul style="list-style-type: none"> <li>● All reheating</li> <li>● Cook scrambled eggs</li> </ul>
7	70%	<ul style="list-style-type: none"> <li>● Cook breads and cereal product</li> <li>● Cook cheese dishes, veal</li> <li>● Cook cakes, muffins, brownies, cupcakes</li> </ul>
6	60%	<ul style="list-style-type: none"> <li>● Cook pasta</li> </ul>
5	50%	<ul style="list-style-type: none"> <li>● Cook meats, whole poultry</li> <li>● Cook custard</li> <li>● Cook whole chicken, turkey, spare ribs, rib roast, sirloin roast</li> </ul>
4	40%	<ul style="list-style-type: none"> <li>● Cook less tender cuts of meat</li> <li>● Reheat frozen convenience foods</li> </ul>
3	30%	<ul style="list-style-type: none"> <li>● Thaw meat, poultry, and seafood</li> <li>● Cook small quantities of food</li> <li>● Finish cooking casseroles, stews, and some sauces</li> </ul>
2	20%	<ul style="list-style-type: none"> <li>● Soften butter and cream cheese</li> <li>● Heat small amounts of food</li> </ul>
1	10%	<ul style="list-style-type: none"> <li>● Soften ice cream</li> <li>● Raise yeast dough</li> </ul>
0	0	<ul style="list-style-type: none"> <li>● Standing time</li> </ul>

# USING YOUR MICROWAVE OVEN

## SENSOR OPERATING INSTRUCTIONS

Used to cook foods without selecting cooking times and power levels. The display will indicate the sensor category during the initial sensing period. The oven automatically determines the required cooking time for each food item.

When the internal sensor detects a certain amount of humidity coming from the food, it will tell the oven how much longer to heat. The display will show the remaining heating time. For best results when cooking by Sensor, follow these recommendations:

1. Food cooked with the Sensor system should be at normal storage temperature.
2. The glass tray and the outside of the container should be dry to assure best cooking results.
3. Foods should always be covered loosely with microwavable plastic wrap, waxed paper, or a lid.
4. Do not open the door or touch **STOP/Clear** during the sensing time. When sensing time is over, the oven beeps twice and the remaining cooking time will appear in the display window. At this time you can open the door to stir, turn, or rearrange the food.

## SENSOR COOKING GUIDE

Appropriate containers and coverings help to assure good Sensor cooking results.

1. Always use microwavable containers and cover them with lids or vented plastic wrap.
2. Never use tight-sealing plastic covers. They can prevent steam from escaping and cause food to overcook.
3. Match the amount to the size of the container. Fill containers at least half full for best results.
4. Be sure the outside of the cooking container and the inside of the microwave oven are dry before placing food in the oven. Beads of moisture turning into steam can mislead the sensor.
5. If the food is not as hot as you would like after using the sensor cook or reheat function, use Cook Time to continue heating. Do not repeat the sensor options in succession on the same food.

## SENSOR POPCORN

Sensor **Popcorn** lets you pop 2.0, 3.0 and 3.5 ounce bags of commercially packaged microwave popcorn. Pop only one package at a time. If you are using a microwave popcorn popper, follow manufacturer's instructions.

Example: To pop popcorn.	
<b>Popcorn</b>	1. Touch <b>Popcorn</b> .
<b>START</b> Enter	2. Touch <b>START/Enter</b> . When the cook time is over, four beeps will sound and " <b>COOK END</b> " will display.

- Recommended amounts: 2.0 - 3.5 oz.

## CAUTION

DO NOT leave the microwave oven unattended while popping corn.

When popping commercially packaged popcorn, remove the rack from the oven. Do not place the bag of microwave popcorn on the rack or under the rack.

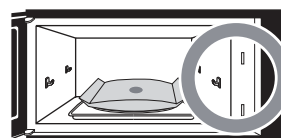
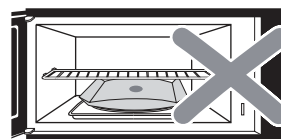
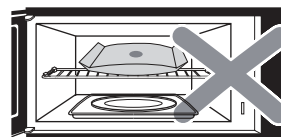

# USING YOUR MICROWAVE OVEN

## SENSOR REHEAT

**Reheat** lets you heat foods without needing to program times and Power Levels.

**Reheat** has preset Power Levels for 6 categories. See the details in the cooking guide table.

Example: To reheat a Casserole.	
<b>Reheat</b>	1. Touch <b>Reheat</b> .
<b>3</b>	2. Touch <b>3</b> to choose casserole and cooking will start 3~4 second later.
See Cooking Guide for Sensor Reheat table below for info. When the cook time is over, you will hear four beeps and " <b>COOK END</b> " will display.	

## SENSOR COOK

Using **Cook** lets you heat common microwave prepared foods without needing to program times and Cook Powers. Sensor **Cook** has preset Power Levels for 13 food categories. See the details in the cooking guide table.

Example: To cook Rice.	
<b>Cook</b>	1. Touch <b>Cook</b> .
<b>6</b>	2. Touch <b>6</b> to choose rice and cooking will start 3~4 second later.
See Cooking Guide for Sensor Cook on page 16. When the cook time is over, you will hear four beeps and " <b>COOK END</b> " will display.	

## COOKING GUIDE FOR SENSOR REHEAT

CODE	CATEGORY	RECOMMENDED AMOUNTS	DIRECTIONS
1	<b>DINNER PLATE</b>	1 ~ 2 servings	Place food on a plate. Cover with vented plastic wrap. Let stand 3 minutes after heating.
2	<b>SOUP/SAUCE</b>	1 ~ 4 cups	Place in shallow microwavable casserole. Cover with vented plastic wrap. Let stand 3 minutes after heating.
3	<b>CASSEROLE</b>	1 ~ 4 cups	Place in a microwaveable bowl or casserole. Cover with vented plastic wrap. Let stand 3 minutes.
4	<b>PIZZA</b>	1 ~ 3 slices	This is a reheat function for leftover pizza. Place on paper towel on a microwave safe plate.
5	<b>BAKED GOODS</b>	1 ~ 4 ea.	Place on a paper towel. Do not cover.
6	<b>TEA</b>	1 ~ 2 cups (240 ml per cup)	Use a mug or microwave-safe cup with no cover. Stir after reheating.

# USING YOUR MICROWAVE OVEN

## COOKING GUIDE FOR SENSOR POPCORN

CATEGORY	RECOMMENDED AMOUNTS	DIRECTIONS
POPCORN	2.0 - 3.5 oz.	Sensor Popcorn lets you pop commercially packaged microwave popcorn. Pop only one package at a time. For best results, use a fresh bag of popcorn. Place a bag of prepackaged microwave popcorn on the center of the glass tray.

## COOKING GUIDE FOR SENSOR COOK

CODE	CATEGORY	RECOMMENDED AMOUNTS	DIRECTIONS
1	FRESH VEGETABLE (Hard)	1 ~ 4 cups	Place in a microwaveable bowl or casserole. Add water according to the quantity. * 1-2 cups: add 2 tbsp water. * 3-4 cups: add 4 tbsp water.
2	FRESH VEGETABLE (Soft)	1 ~ 4 cups	Cover with vented plastic wrap. Let stand 3 minutes after cooking. Hard vegetables : Carrot, Beet etc. Soft vegetables : Cauliflower, Broccoli, Spinach etc.
3	FROZEN VEGETABLE	1 ~ 4 cups	Place in a microwaveable bowl or casserole. * 1-2 cups: add 2 tbsp water. * 3-4 cups: add 4 tbsp water. Cover with vented plastic wrap. Let stand 3 minutes.
4	CANNED VEGETABLE	1 ~ 4 cups	Transfer vegetables from the can to a microwaveable bowl or casserole . Cover with vented plastic wrap. Stir thoroughly after cooking.
5	BAKED POTATO	1 ~ 4 ea (approx.8 - 10 oz. each)	Pierce skin with a fork and place on paper towel. Do not cover. Let stand 5 minutes after cooking.
6	RICE	½ ~ 2 cups	Add twice as much water as you have rice (add 2 cups of water to 1 cup of rice). Place in a microwaveable bowl large enough to prevent the water boiling over. Cover with vented plastic wrap. Remove from microwave. After cooking uncover, stir, then recover and let stand 5 minutes.
7	FROZEN LASAGNA	10 ~ 21 oz.	Remove from outer display package. Slit cover. If not in microwave-safe container, place on a microwaveable plate and cover with vented plastic wrap. After cooking, let stand in microwave oven 3 minutes.
8	FISH FILLET	4 ~ 16 oz.	Place thawed chicken pieces in single layer and cover with vented plastic wrap. After cooking, let stand 5 minutes.
9	SHRIMP	4 ~ 16 oz.	Place thawed shrimp in single layer and cover with vented plastic wrap. After cooking, let stand 2 minutes.
10	CHICKEN PIECES	16 ~ 32 oz.	Place thawed chicken pieces in single layer and cover with vented plastic wrap. After cooking, let stand 5 minutes.
11	GROUND MEAT	4 ~ 16 oz.	Pack meat loosely into a bowl. Cover with plastic wrap. Stir thoroughly after cooking.
12	CASSEROLE	1 ~ 4 cups	Place in a microwaveable bowl or casserole. Cover with vented plastic wrap. Let stand 3 minutes after cooking.
13	BOILING WATER	1 ~ 2 cups (240 ml per cup)	Use a wide-mouth mug. Do not cover. (Be careful! The beverage will be very hot! Sometimes liquids heated in cylindrical containers will splash out unexpectedly when the cup is moved.)



# USING YOUR MICROWAVE OVEN

## TIMER

You can use your microwave oven as a timer. Use the Timer for timing up to 99 minutes, 99 seconds.

Example: To count 3 minutes.	
Timer	1. Touch <b>Timer</b> .
<b>3 0 0</b>	2. Enter the time by using the number buttons.
<b>START</b> Enter	3. Touch <b>START/Enter</b> . When the time is over, the oven will beep 7 times.

NOTE: To turn off the Timer while it is still running, touch the **Timer** button.

## SOFTEN

The oven uses low power to soften foods (butter, ice cream, cream cheese, and frozen juice.) See the following table.

Example: To soften quart of ice cream.	
Soften/ Melt	1. Touch <b>Soften/Melt</b> .
<b>2</b>	2. Choose menu. Touch <b>2</b> to ice cream.
<b>2</b>	3. Touch <b>2</b> to choose amount.
<b>START</b> Enter	4. Touch <b>START/Enter</b> .

## SOFTEN TABLE

Category	Code	Touch button number		
		1	2	3
Butter	1	1 stick	2 sticks	3 sticks
Ice Cream	2	Pint	Quart	Half gallon
Cream Cheese	3	3 oz.	8 oz.	–
Frozen Juice	4	6 oz.	12 oz.	16 oz.

## MELT

The oven uses low power to melt foods (butter or margarine, chocolate, marshmallows, or processed cheese food.) See the following table.

Example: To melt 8 oz. chocolate.	
Soften/ Melt	1. Touch <b>Soften/Melt</b> twice.
<b>2</b>	2. Choose menu. Touch <b>2</b> to chocolate.
<b>2</b>	3. Touch <b>2</b> to choose amount.
<b>START</b> Enter	4. Touch <b>START/Enter</b> .

## MELT TABLE

Category	Code	Touch button number		
		1	2	3
Butter/Margarine	1	1 stick	2 sticks	3 sticks
Chocolate	2	4 oz.	8 oz.	–
Cheese	3	8 oz.	16 oz.	–
Marshmallows	4	5 oz.	10 oz.	–

## KIDS MEAL

Using KIDS MEAL lets you heat common microwave-prepared foods without needing to program times and cook power. Mac & Cheese, Hot dog, Chicken Nuggets.

Example: To heat 4 ea Hot dogs.	
Kids Meal	1. Touch <b>Kids Meal</b> .
<b>2</b>	2. Touch <b>2</b> choose <b>Hot dog</b> .
<b>2</b>	3. Touch <b>2</b> .
<b>START</b> Enter	4. Touch <b>START/Enter</b> .

NOTE: When the cook time is over, you will hear four beeps and “COOK END” will display.

## KIDS MEAL TABLE

Category	Touch button number	
	1	2
Mac & Cheese	6 oz.	12 oz.
Hot dog	2 ea	4 ea
Chicken Nuggets	4 oz.	8 oz.

# USING YOUR MICROWAVE OVEN

## SOFTEN TABLE

CODE	CATEGORY	START TEMP.	DIRECTION	AMOUNT
1	Butter	Refrigerated	Unwrap and place in a microwave safe dish on the rack over the glass tray. Butter will be at room temperature and ready for use in a recipe.	1, 2 or 3 sticks (4 oz. / 1 stick)
2	Ice Cream	Frozen	Place in a microwave safe dish on the rack over the glass tray. Ice cream will be soft enough to make scooping easier.	Pint, Quart, Half gallon
3	Cream Cheese	Refrigerated	Unwrap and place in a microwave safe dish on the rack over the glass tray. Cream cheese will be at room temperature and ready for use in a recipe.	3 or 8 oz.
4	Frozen Juice	Frozen	Remove top. Place in oven. Frozen juice will be soft enough to mix easily with water.	6, 12 or 16 oz.

## MELT TABLE

CODE	CATEGORY	START TEMP.	DIRECTION	AMOUNT
1	Butter or Margarine	Refrigerated	Unwrap and place in a microwave safe dish on the rack over the glass tray. No need to cover butter. Stir at the end of cooking to complete melting.	1, 2 or 3 sticks (4 oz. / 1 stick)
2	Chocolate	Room Temp.	Chocolate chips or squares of baking chocolate may be used. Unwrap squares and place in a microwave safe dish on the rack over the glass tray. Stir at the end of cycle to complete melting.	4 or 8 oz.
3	Cheese	Refrigerated	Use processed cheese food only. Cut into cubes. Place in a single layer in a microwave safe dish on the rack over the glass tray. Stir at the end of cooking to complete melting.	8 or 16 oz.
4	Marshmallows	Room Temp.	Large or miniature marshmallows may be used. Place in a microwave safe dish on the rack over the glass tray. Stir at the end of cycle to complete melting.	5 or 10 oz.

# USING YOUR MICROWAVE OVEN

## DEFROST

Four defrost choices are preset in the oven. The Defrost feature provides you with the best defrosting method for frozen foods, because the oven automatically sets the defrosting times for each food item according to the weight you enter. For added convenience, the Defrost feature includes a built-in tone mechanism that reminds you to check, turn over, separate, or rearrange the food during the defrost cycle. Four different defrosting presets are provided.

1. **Meat**
2. **Poultry**
3. **Fish**
4. **Bread**

Touch **Defrost** and choose menu. Then enter weight. Available weight ranges for Meat, Poultry, and Fish are 0.1 to 6.0 lbs. The available weight range for Bread is 0.1 to 1.0 lb.

Example : To defrost 1.2 lbs. of meat.

- |                       |   |
|-----------------------|---|
| <b>Defrost</b>        | 1. Touch <b>Defrost</b> once to choose the Meat category. |
| <b>1</b>              | 2. Touch <b>1</b> to choose meat.                         |
| <b>1 2</b>            | 3. Enter the weight.                                      |
| <u>START</u><br>Enter | 4. Touch <b>START/Enter</b> .                             |

**NOTE:** After you touch **START/Enter**, the display counts down the defrost time. The oven will beep once during the defrost cycle. At this time, open the door and turn, separate, or rearrange the food as needed. Remove any portions that have thawed, then return the frozen portions to the oven and touch **START/Enter** to resume the defrost cycle.

### For best results:

- Remove fish, shellfish, meat, and poultry from its original closed paper or plastic package (wrapper). Otherwise, the wrap will hold steam and juice close to the foods, which can cause the outer surface of the foods to cook.
- Form the meat into the shape of a doughnut before freezing. When defrosting, scrape off thawed meat when the beep sounds and continue defrosting.
- Place foods in a shallow glass baking dish or a on a microwave roasting rack to catch drippings.
- Foods should still be somewhat icy in the center when removed from the oven.

## DEFROST TABLE

CATEGORY	FOOD
<b>1. Meat</b> 0.1 to 6.0 lbs.	<b>Beef</b> Ground beef, Round steak, Cubes for stew, Tenderloin steak, Pot roast, Rib roast, Rump roast, Chuck roast, Hamburger patty. <b>Lamb</b> Chops (1-inch thick), Rolled roast <b>Pork</b> Chops (1/2-inch thick), Hot dogs, Spareribs, Country-style ribs. Rolled roast, Sausage.
<b>2. Poultry</b> 0.1 to 6.0 lbs.	<b>Poultry</b> Whole (under 4 lbs.), Cut up, Breasts (boneless) <b>Cornish hens</b> Whole <b>Turkey</b> Breast (under 6 lbs.)
<b>3. Fish</b> 0.1 to 6.0 lbs.	<b>Fish</b> Fillets, Whole Steaks <b>Shellfish</b> Crab meat, Lobster tails, Shrimp, Scallops
<b>4. Bread</b> 0.1 to 1.0 lb.	<b>Muffins</b> <b>Roll cake</b>

## QUICK DEFROST

This is a quick defrost feature that allows you to choose a preset 1.0 lbs. defrost cycle.

Example: To defrost for 1.0 lbs.

- |                       |  |
|-----------------------|--|
| <b>Defrost</b>        | 1. Touch <b>Defrost</b> twice.   |
| <u>START</u><br>Enter | 2. Touch <b>START/Enter</b> .  |
|                       | 3. Halfway through the cycle, the oven will beep. Open the door, turn the meat over, Close the door, and touch <b>START/Enter</b> to resume defrosting until the cycle ends. |

When the defrost time is over, four beeps will sound and **"COOK END"** will display.

# USING YOUR MICROWAVE OVEN

## TIME DEFROST

Time defrost feature allows you to enter time to defrost.

Example: defrost 2 minutes	
<b>Defrost</b>	1. Touch <b>Defrost</b> 3 times.
<b>2 0 0</b>	2. Enter time to defrost.
<b>START</b> Enter	3. Touch <b>START/Enter</b> .

## DEFROSTING TIPS

- **When using** Defrost Weight/Time, the weight to be entered is the net weight in pounds and tenths of pounds (the weight of the food minus the container).
- **Before starting**, make sure you have removed any of the metal twist-ties which often come with frozen food bags, and replace them with strings or elastic bands.
- **Open containers** such as cartons before they are placed in the oven.
- **Always slit** or pierce plastic pouches or packaging.
- **If food is foil wrapped**, remove foil and place food in a suitable container.
- **Slit** the skins, if any, of frozen food such as sausage.
- **Bend** plastic pouches of food to ensure even defrosting.
- **Always underestimate** defrosting time. If defrosted food is still icy in the center, return it to the microwave oven for more defrosting.
- **The length** of defrosting time varies according to how solidly the food is frozen.
- **The shape of the package** affects how quickly food will defrost. Shallow packages will defrost more quickly than a deep block.
- **As food begins to defrost**, separate the pieces. Separated pieces defrost more easily.
- **Use small pieces of aluminum foil** to shield parts of food such as chicken wings, leg tips, fish tails, or areas that start to get warm. Make sure the foil does not touch the sides, top, or bottom of the oven. The foil can damage the oven lining.
- **For better results**, let food stand after defrosting. (For more information on standing time, see the "Microwave Cooking Tips" section.)
- Turn food over during defrosting or standing time. Break apart and remove food as required.

## METAL RACK

### CAUTION

To avoid risk of property damage:  
Do not use the rack to pop popcorn.  
The rack must be on the four plastic supports when used.  
Use the rack only when cooking food on the rack position.  
Do not cook with the rack on the floor of the oven.

The metal rack gives you extra space when cooking in more than one container at the same time.

### To use the rack:

1. Place the rack securely in the four plastic supports.
- The rack **MUST NOT** touch the metal walls or back of the microwave oven.
2. Place equal amounts of food both **ABOVE AND BELOW** the rack.
- The amount of food must be approximately the same to balance out the cooking energy.

## SLIDE-OUT HOOD

### CAUTION

- Do not place any objects on the slide-out hood as they could fall and be damaged.
- Do not pull on slide-out hood or damage may occur.
- Do not spill food or liquid on slide-out hood. Spillage of liquid or food may result in electric shock or oven malfunction.
- Make sure the slide-out hood has been moved back to rear before your microwave oven or range cooking start.
- Strictly install the microwave oven according to Installation Manual. Install at least 12 inches (30.5cm) above a cooktop.
- Don't leave the cooktop without cookware when cooking, the high temperature of the flame may cause the slide hood melted.
- Close slide hood after finish cooking on cooktop.

## SLIDE-OUT VENT HOOD

- Press the slide-out vent hood (marked with "PUSH") to extend it forward. To close it, push the vent hood back until it clicks into place.
- Extension of the slide-out vent hood allows more effective capture of smoke and vapor from range-top cooking.

# COOKING TIPS

## GETTING THE BEST COOKING RESULTS

To get the best results from your microwave oven, read and follow the guidelines below.

- **Storage Temperature:** Foods taken from the freezer or refrigerator take longer to cook than the same foods at room temperature. The time for recipes in this book is based on the normal storage temperature of the food.
- **Size:** Small pieces of food cook faster than large ones, pieces similar in size and shape cook more evenly. For even cooking, reduce the power when cooking large pieces of food.
- **Natural Moisture:** Very moist foods cook more evenly because microwave energy is attracted to water molecules.
- **Stir** foods such as casseroles and vegetables from the outside to the center to distribute the heat evenly and speed cooking. Constant stirring is not necessary.
- **Turn over** foods like pork chops, baking potatoes, roasts, or whole cauliflower halfway through the cooking time to expose all sides equally to microwave energy.
- **Place** delicate areas of foods, such as asparagus tips, toward the center of the dish.
- **Arrange** unevenly shaped foods, such as chicken pieces or salmon steaks, with the thicker, meatier parts toward the outside of the dish.
- **Shield**, with **small** pieces of aluminum foil, parts of food that may cook quickly, such as wing tips and leg ends of poultry.
- **Let It Stand:** After you remove the food from the microwave, cover the food with foil or a casserole lid and let it stand to finish cooking in the center and avoid overcooking the outer edges. The length of standing time depends on the density and surface area of the food.
- **Wrapping in waxed paper or paper towel:** Sandwiches and many other foods containing prebaked bread should be wrapped prior to microwaving to prevent them from drying out.

## FISH & SHELLFISH

### Cooking Fish and Shellfish: General Directions

- Prepare the fish for cooking.
  - Completely defrost the fish or shellfish.
  - Arrange unevenly shaped pieces with thicker parts toward the outside of the dish. Arrange shellfish in a single layer for even cooking.
  - The type of cover you use depends on how you cook. Poached fish needs a microwavable lid or **vented** plastic wrap.
  - Baked fish, coated fish, or fish in sauce needs to be covered lightly with waxed paper to keep the coating crisp and the sauce from getting watery.
- Always set the shortest cooking time. Fish is done when it turns opaque and the thickest part begins to flake. Shellfish is done when the shell turns from pink to red and the flesh is opaque and firm.
- The Fish and Shellfish Cooking Table below provides specific directions with Power Level and Cooking Time settings for most types of fish and shellfish.

### FISH AND SHELLFISH COOKING TABLE

FISH	POWER LEVEL	COOKING TIME	DIRECTIONS
Fish fillets	HI	3½-4½ minutes	Arrange fish in a single layer with thickest portion toward outside edge of 1½ quart microwavable baking dish. Brush with melted butter and season, if desired. Cook covered with vented plastic wrap. Let stand covered 2 minutes. If you are cooking more than 1 lb. of fish, turn the fish halfway through cooking.
Fish steaks	HI	4½-5½ minutes	
Whole fish	7	4½-6 minutes	
Scallops	HI	3½-5 minutes	Arrange in a single layer. Prepare as directed above, except stir instead of turning the shellfish.
Shrimp, shelled	HI	3½-5 minutes	

# COOKING TIPS

## APPETIZERS/SAUCES/SOUPS

### Cooking Appetizers: Tips and Techniques

#### Recommended

- Crisp crackers, such as melba toast, shredded wheat and crisp rye crackers are best for microwave use. Wait until party time to add the spreads. Place a paper towel under the crackers while they cook in the microwave oven to absorb extra moisture.
- Arrange individual appetizers in a circle for even cooking.
- Stir dips to distribute heat and shorten cooking time.

### Cooking Sauces: Tips and Techniques

- Use a microwavable casserole or glass measuring cup that is at least two or three times the volume of the sauce.
- Sauces made with cornstarch thicken more rapidly than those made with flour.
- Cook sauces made with cornstarch or flour uncovered so you may stir them two or three times during cooking for a smooth consistency.
- To adapt a conventional sauce or gravy recipe, reduce the amount of liquid slightly.

### Cooking Soups: Tips and Techniques

- Cook soups in a microwavable dish which holds double the volume of the recipe ingredients to prevent boil-over, especially if you use cream or milk in the soup.
- Generally, cover microwaved soups with VENTED plastic wrap or a microwavable lid.
- Cover foods to retain moisture. Uncover foods to retain crispness.
- Avoid overcooking by using the minimum suggested time. Add more time, if necessary, only after checking the food.
- Stirring occasionally will help blend flavors, distribute heat evenly, and may even shorten the cooking time.
- When converting a conventional soup recipe to cook in the microwave, reduce the liquid, salt, and strong seasonings.

#### Not Recommended

- Appetizers with a crisp coating or puff pastry are best done in a conventional oven with dry heat.
- Breaded products can be warmed in the microwave oven but will not come out crisp.

## MEAT

### Cooking Meat: General Directions

- Prepare the meat for cooking.
  - Defrost completely.
  - Trim off excess fat to avoid splattering.
  - Place the meat, fat side down, on a microwavable rack in a microwavable dish.
  - Use oven cooking bag for less tender cuts of meat.
  - Arrange the meat so that thicker portions are toward the outside of the dish.
  - Cover the meat with waxed paper to prevent splattering.
- Tend the meat as it cooks.
  - Drain juices as they accumulate to reduce splattering and keep from overcooking the bottom of the meat.
  - Shield thin or bony portions with strips of foil to prevent overcooking.

**NOTE:** Keep the foil **at least 1 inch** from the oven walls, and do not cover more than one-third of the meat with foil at any one time.

- Let the meat stand covered with foil 10-15 minutes after you remove it from the oven. The internal temperature of the meat may rise from 5-10°F during standing time.

The Meat Cooking Table on the next page provides detailed directions, Power Level, and Cooking Time settings for most cuts of meat.

# COOKING TIPS

## MEAT COOKING TABLE

MEAT	POWER LEVEL	COOKING TIME	DIRECTIONS
<b>BEEF</b> Hamburgers, Fresh or defrosted (4 oz. each) 1 patty 2 patties 4 patties	HI	1-1½ minutes 1½-2 minutes 2½-3½ minutes	Form patties with depression in center of each. Place on microwavable roast rack. Brush with browning agent, if desired. Cover with waxed paper. Turn over halfway through cooking. Let stand covered 1 minute after cooking.
Sirloin tip roast (3-4 lbs.)	5	8-10 minutes per pound <b>RARE(135°F)</b> 11-13 minutes per pound <b>MEDIUM(155°F)</b>	Place roast fat side down on microwavable roasting rack. Add desired seasonings and cover with waxed paper. Turn meat over halfway through cooking and shield if necessary. Remove roast from microwave oven when desired temperature is reached. Let stand covered with foil 15 minutes.(Temperature may rise about 10°F).
<b>LAMB</b> Lamb roast, rolled boneless (3-4 lbs.)	5	11-12 minutes per pound <b>RARE(135°F)</b> 12-13 minutes per pound <b>MEDIUM(145°F)</b> 13-14 minutes per pound <b>WELL(155°F)</b>	Place roast fat side down on microwavable roasting rack. Brush lamb with marinade or desired seasonings such as rosemary, thyme or marjoram. Cover with waxed paper. Turn roast over after 15 minutes, and again after 30 minutes. Shield if necessary. Remove roast from microwave when desired temperature is reached. Let stand covered with foil 15 minutes (Temperature may rise about 10°F).
<b>PORK</b> Bacon slices 2 slices 4 slices 6 slices 10 slices	HI	1½-2 minutes 2-3 minutes 4-5 minutes 7-8 minutes	Place bacon slices on microwavable roasting rack. Cover with paper towels. After cooking, let stand 1 minute.
Chops (5-7 oz. each) 2 chops 4 chops	3	18-20 minutes per pound 15-17 minutes per pound	Place chops in microwavable baking dish. Add desired seasonings and cover with vented plastic wrap. Cook until no longer pink or until internal temperature reaches 170°F. Turn chops over halfway through cooking. Let stand covered 5 minutes after cooking. (Temperature may rise about 10°F).
Loin Roast, rolled, boneless (3 ½- 4 ½ lbs.)	3	25-27 minutes per pound (165°F)	Place roast in cooking bag in microwavable dish. Add seasonings and browning agent if desired. Close bag loosely with microwavable closure or string. After cooking, let stand in bag 15 minutes. (Temperature may rise about 10°F.) Internal temperature of pork should reach 170°F before serving.
Sausage links, Fresh or frozen defrosted (1-2 oz. each)  2 links 4 links 6 links 10 links (8 oz. pkg.)	HI	45-60 seconds 1-1½ minutes 1½-2 minutes 1¾-2 minutes	Pierce links and place on microwavable roasting rack. Cover with waxed paper or paper towel. Turn over halfway through cooking. After cooking, let stand covered 1 minute.

# COOKING TIPS

## POULTRY

### Cooking Poultry: General Directions

- Prepare the poultry for cooking.
  - Defrost completely.
  - Arrange poultry pieces with thicker pieces at the outside edge of the baking dish. When cooking legs, arrange them like the spokes of a wheel.
  - Cover the baking dish with waxed paper to reduce splattering.
  - Use a browning agent or cook with a sauce to give a browned appearance.
- Tend the poultry as it cooks.
  - Drain and discard juices as they accumulate.
  - Shield thin or bony pieces with small strips of aluminum foil to prevent overcooking. Keep foil at **least 1 inch** from the oven walls and other pieces of foil.
- The poultry is done when it is no longer pink and the juices run clear. When done, the temperature in the thigh meat should be 180-185°F.
- Let the poultry stand covered with foil after cooking for 10 minutes.

The Poultry Cooking Table below provides detailed directions, Power Level, and Cooking Time settings for most cuts and types of poultry.

### POULTRY COOKING TABLE

POULTRY	POWER LEVEL	COOKING TIME	DIRECTIONS
Chicken pieces (2½-3 lbs.)	HI	4½-5½ minutes per lb.	Wash pieces, shake the water off, and prepare for cooking. Place pieces in a single layer in a microwavable baking dish with thicker pieces to the outside. Brush with butter or browning agent and seasonings if desired. Cover with waxed paper. Cook until no longer pink and juices run clear. Let stand covered 5 minutes after cooking.
Chicken whole (3-3½ lbs.)	HI	12-13 minutes per lb.	Wash, shake the water off, and prepare for cooking. Place breast side down on a microwavable roasting rack. Brush with butter, or browning agent and seasoning if desired. Cover with waxed paper. Cook 1/3 of estimated time. Turn breast side up, brush with butter, or browning agent. Replace waxed paper. Cook 1/3 of estimated time again. Shield if necessary. Cook remaining 1/3 of estimated time or until no longer pink and juices run clear. Let stand covered with foil 10 minutes. (The temperature may rise about 10°F.) The temperature in the thigh should be 180°F-185°F when the poultry is done.
Cornish hens whole (1-1½ lbs. each)	HI	6-7 minutes per lb.	Wash, shake the water off, and prepare for cooking. Tie wings to body of hen and the legs to tail. Place hens breast side down on microwavable rack. Cover with waxed paper. Turn breast side up halfway through cooking. Shield bone ends of drumsticks with foil. Remove and discard drippings. Brush with butter or browning agent and seasonings if desired. Cook until no longer pink and juices run clear. Remove hens from microwave when they reach desired temperature. Let stand covered with foil 5 minutes. (Temperature may rise about 10°F). Temperature in breast should be 170°F before serving.



# COOKING TIPS

## PASTA AND RICE

Microwave cooking and conventional cooking of pasta, rice, and cereal require about the same amount of time, but the microwave is a more convenient method because you can cook and serve in the same dish.

There is no stirring needed and leftover pasta tastes just like fresh cooked when reheated in the microwave oven.

### Cooking Pasta and Rice: Tips and Techniques

- If you are planning to use rice or pasta in a casserole, undercook it so it is still firm.
- Allow for standing time with rice, but not for pasta.
- The Pasta and Rice Cooking Tables below provide specific directions, with Power Level and Cooking Time settings for most common types of pasta and rice.

### PASTA COOKING TABLE

TYPE OF PASTA	POWER LEVEL	COOKING TIME	DIRECTIONS
Spaghetti 4 cups water. Add 8 oz. spaghetti.	HI 5	9 to 10 minutes 7½ to 8½ minutes	Begin with hot tap water, and salt if desired, in a 2-quart microwavable baking dish. If you are cooking spaghetti and lasagna noodles, cover the water with vented plastic wrap. For macaroni and egg noodles, use either vented plastic wrap or a microwavable lid.  1. Cook as directed in the chart or until the water boils.  2. Stir in the pasta; cook covered as directed in the chart or until tender. Drain in a colander.
Macaroni 3 cups water. Add 2 cups macaroni.	HI 5	6 to 7 minutes 5½ to 6½ minutes	
Lasagna noodles 4 cups water. Add 8 oz. lasagna noodles.	HI 5	7 to 8 minutes 11 to 12½ minutes	
Egg noodles 6 cups water. Add 4 cups noodles.	HI 5	8 to 10 minutes 5½ to 6½ minutes	

### RICE COOKING TABLE

TYPE OF RICE	POWER LEVEL	COOKING TIME	DIRECTIONS
Long grain 2 ¼ cups water. Add 1 cup rice.	HI 3	3½ to 4½ minutes 18 minutes	Combine hot tap water, and salt if desired, in a 2-quart microwavable casserole. Cover with a microwavable lid or vented plastic wrap.  1. Cook as directed in the chart or until the water boils.  2. Stir in the rice and any seasonings. Cook covered as directed in the chart or until the water is absorbed and the rice is tender. Let stand covered 5 to 10 minutes. Fluff with a fork.
Brown 2 ½ cups water. Add 1 cup rice.	HI 5	4½ to 5½ minutes 28 minutes	
Long grain and wild rice mix 2 ⅓ cups water. Add 6 oz. pkg.	HI 3	4 to 5 minutes 28 minutes	
Quick cooking 1 cup water. Add 1 cup rice.	HI	2 to 3 minutes	

# MAINTENANCE

## CARE AND CLEANING

For best performance and safety, keep the oven clean inside and outside. Take special care to keep the inner door panel and the oven front frame free of food or grease build-up.

**Never use abrasive powder or pads.** Wipe the microwave oven inside and out, including the hood bottom cover, with a soft cloth and a warm (not hot) mild detergent solution. Then rinse and wipe dry.

Use a chrome cleaner and polish on chrome, metal and aluminum surfaces. Wipe spatters immediately with a wet paper towel, especially after cooking chicken or bacon. Clean your oven weekly or more often, if needed.

## METAL RACK

Wash the metal rack with a mild soap and a soft or nylon scrub brush. Dry completely. Do not use abrasive scrubbers or cleaners to clean rack.

## CLEANING THE GREASE FILTERS

The grease filters should be removed and cleaned often, at least once a month.

### 1. Front filter

- 1) Extend slide out.
- 2) Remove two filter frame screw.
- 3) Tip the frame forward.
- 4) Remove filter from frame.

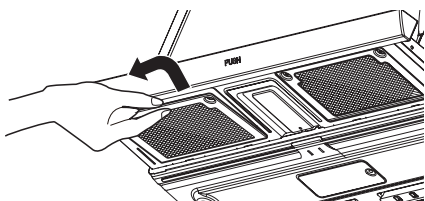
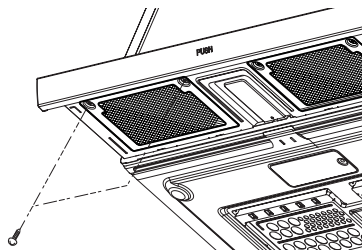

### 2. Back filter

Slide each filter to the side, then pull the filters downward. The filters will drop out.

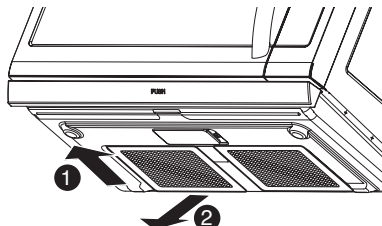

- ### 3. Soak grease filters in hot water and a mild detergent. Rinse well and shake to dry. **Do not use ammonia or place them in a dishwasher. The aluminum will darken.**

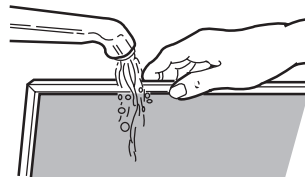

- ### 4. To reinstall the filters, reverse order of removing filter.

**NOTE: Do not operate the hood without the filters in place.**

## CHARCOAL FILTER REPLACEMENT

If your oven is vented inside, the charcoal filter should be replaced every 6 to 12 months, and more often if necessary. The charcoal filter cannot be cleaned. To order a new charcoal filter, call 1-800-243-0000 or go to [www.lg.com/us/support/parts-accessories](http://www.lg.com/us/support/parts-accessories).

1. Turn the power off at the main power supply and wear gloves
2. Remove the one vent grille mounting screw. (1 outside screw)
3. After open door. Slide vent grille to left and tip it forward.

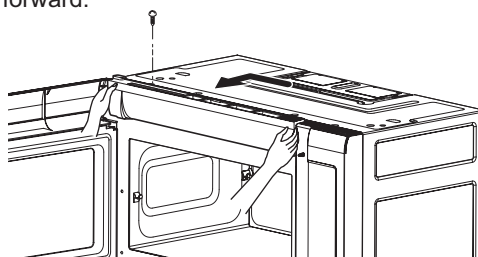

# MAINTENANCE

4. Remove the old filter.

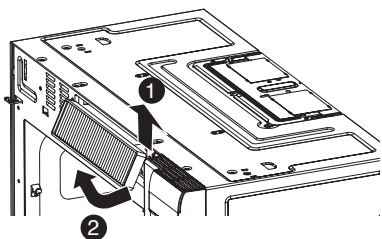

5. Slide a new charcoal filter into place.

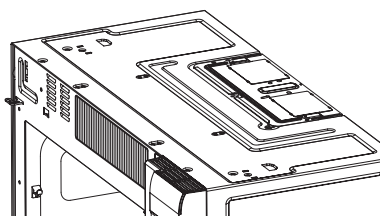

6. Slide in vent grille and replace the mounting screw.  
Turn the power back on at the main power supply and set the clock.

## COOKTOP/NIGHT LIGHT REPLACEMENT

1. Unplug the oven or turn off power at the main power supply.
2. Remove the LED lamp cover mounting screws.

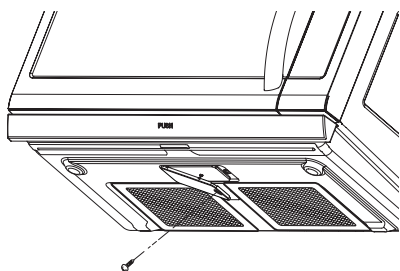

3. Replace the LED Lamp board.
4. Replace the LED Lamp cover and mounting screws.
5. Turn the power back on at the main power supply.

\*It is recommended that the cooktop lamp be replaced by a qualified service technician.

## OVEN LIGHT REPLACEMENT

1. Unplug the oven or turn off power at the main power supply and wear gloves.
2. Remove the vent cover mounting screw.  
(1 outside screws)
3. Slide vent grille left, then lift out to remove.

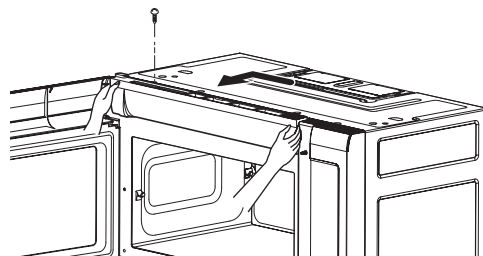

4. Remove the cover screw slide the cover to left and then lift up the bulb holder.

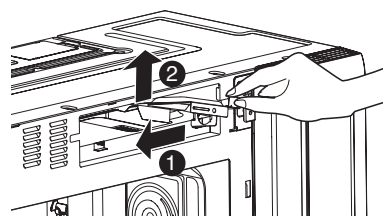
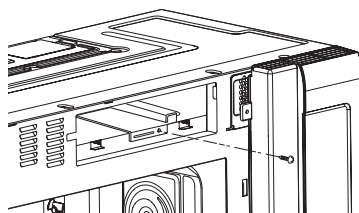

5. Replace the bulb with a 30 watt appliance bulb.
6. Replace the bulb holder and screw.
7. Slide in vent grille and replace the mounting screw.  
Replace the mounting screws. Turn the power back on at the main power supply.

# COOKING UTENSILS

## MICROWAVE UTENSIL GUIDE

USE	DO NOT USE
<p><b>OVENPROOF GLASS</b> (treated for high intensity heat): Utility dishes, loaf dishes, pie plates, cake plates, liquid measuring cups, casseroles and bowls without metallic trim.</p> <p><b>CHINA:</b> Bowls, cups, serving plates and platters without metallic trim.</p> <p><b>PLASTIC:</b> Plastic wrap (as a cover)-- lay the plastic wrap loosely over the dish and press it to the sides. Vent plastic wrap by turning back one edge slightly to allow excess steam to escape. The dish should be deep enough so that the plastic wrap will not touch the food. As the food heats it may melt the plastic wrap wherever the wrap touches the food. Use plastic dishes, cups, semirigid freezer containers and plastic bags <b>only for short cooking time. Use these with care because the plastic may soften from the heat of the food.</b></p> <p><b>PAPER:</b> Paper towels, waxed paper, paper napkins and paper plates with no metallic trim or design. Look for the manufacturer's label for use in the microwave oven.</p>	<p><b>METAL UTENSILS:</b> Metal shields the food from microwave energy and produces uneven cooking. Also avoid metal skewers, thermometers or foil trays. Metal utensils can cause arcing, which can damage your microwave oven.</p> <p><b>METAL DECORATION:</b> Metal-trimmed or metal-banded dinnerware, casserole dishes, etc. The metal trim interferes with normal cooking and may damage the oven.</p> <p><b>ALUMINUM FOIL:</b> Avoid large sheets of aluminum foil because they hinder cooking and may cause harmful arcing. Use small pieces of foil to shield poultry legs and wings. Keep ALL aluminum foil at least 1 inch from the side walls and door of the oven.</p> <p><b>WOOD:</b> Wooden bowls and boards will dry out and may split or crack when you use them in the microwave oven. Baskets react in the same way.</p> <p><b>TIGHTLY COVERED UTENSILS:</b> Be sure to leave openings for steam to escape from covered utensils. Pierce plastic pouches of vegetables or other food items before cooking. Tightly closed pouches could explode.</p> <p><b>BROWN PAPER:</b> Avoid using brown paper bags. They absorb too much heat and could burn.</p> <p><b>FLAWED OR CHIPPED UTENSILS:</b> Any utensil that is cracked, flawed or chipped may break in the oven.</p> <p><b>METAL TWIST TIES:</b> Remove metal twist ties from plastic or paper bags. They become hot and could cause a fire.</p>

Do not use recycled paper products in the microwave oven. They sometimes contain impurities that cause sparks to occur.

# FAQS

## FREQUENTLY ASKED QUESTIONS

**Q. Can I use a rack in my microwave oven so that I may reheat or cook on two levels at a time?**

A. Only use the rack that is supplied with your microwave oven. Use of any other rack can result in poor cooking performance and/or arcing and may damage your oven.

**Q. Can I use either metal or aluminum pans in my microwave oven?**

A. Usable metal includes aluminum foil for shielding (use small, flat pieces), and shallow foil trays (if tray is 3/4 inch deep and filled with food to absorb microwave energy). Never allow metal to touch walls or door.

**Q. Sometimes the door of my microwave oven appears wavy. Is this normal?**

A. This appearance is normal and does not affect the operation of your oven.

**Q. What are the humming noises that I hear when my microwave oven is operating?**

A. You hear the sound of the transformer when the magnetron tube cycles on and off.

**Q. Why does the dish become hot when I microwave food in it? I thought that this should not happen.**

A. As the food becomes hot it will conduct the heat to the dish. Use hot pads to remove food after cooking.

**Q. What does “standing time” mean?**

A. “Standing time” means that food should be taken out of the oven and covered for additional time after cooking. This process allows the cooking to finish, saves energy and frees the oven for other purposes.

**Q. Can I pop popcorn in my microwave oven? How do I get the best results?**

A. Yes. Pop packaged microwave popcorn following manufacturer’s guidelines or use the preprogrammed Popcorn button.

Do not use regular paper bags. Use the “listening test” by stopping the oven as soon as the popping slows to a “pop” every one or two seconds. Do not try to repop unpopped kernels. You can also use special microwave poppers. When using a popper, be sure to follow manufacturer’s directions. Do not pop popcorn in glass utensils.

**Q. Why does steam come out of the air exhaust vent?**

A. Steam is normally produced during cooking. The microwave oven has been designed to vent this steam out the top vent.

Steam exhaust here

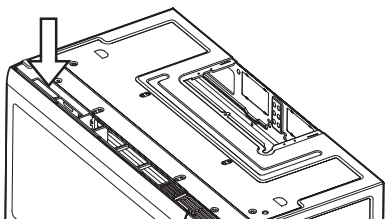

# TROUBLESHOOTING

## BEFORE CALLING FOR SERVICE

Check the following list to be sure a service call is really necessary. A quick review of this manual as well as the additional information in this checklist may prevent an unneeded service call.

### **If nothing on the oven operates:**

- check for a blown circuit fuse or a tripped main circuit breaker.
- check if oven is properly connected to electric circuit in house.
- check that controls are set properly.

### **If the oven interior light does not work:**

- the light bulb is loose or defective.

### **If the oven will not cook:**

- check that cooking program was entered correctly.
- check that door is firmly closed.
- check that Start button was touched.
- check that probe was inserted correctly into receptacle.
- check that timer wasn't started instead of a cook function.

### **If oven takes longer than normal to cook or cooks too rapidly:**

- be sure the Power Level is programmed properly.

### **If the time of day clock does not always keep correct time:**

- check that the power cord is fully inserted into the outlet receptacle.
- be sure the oven is the only appliance on the electrical circuit.

### **If food cooks unevenly:**

- be sure food is evenly shaped.
- be sure food is completely defrosted before cooking.
- check placement of aluminum foil strips used to prevent overcooking.

### **If food is undercooked:**

- check recipe to be sure all directions (amount, time, power levels) were correctly followed.
- be sure microwave oven is on a separate circuit.
- be sure food is completely defrosted before cooking.

### **If food is overcooked:**

- check recipe to be sure all directions (amount, power level, time, size of dish) were followed.

### **If arcing (sparks) occur:**

- be sure microwavable dishes were used.
- be sure wire twist ties weren't used.
- be sure oven wasn't operated when empty.
- make sure metal rack (if used) is properly installed on supports.

### **If the Display shows a time counting down but the oven is not cooking:**

- check that door is firmly closed.
- check that timer wasn't started instead of a cooking function.

# LIMITED WARRANTY – USA

LG Electronics Inc. will repair or replace your product, at LG's option, if it proves to be defective in material or workmanship under normal use, during the warranty period set forth below, effective from the date of original consumer purchase of the product. This limited warranty is good only to the original purchaser of the product and effective only when used in the United States, including U.S. Territories.

<p><b>WARRANTY PERIOD:</b></p> <p><b>Model: LMH2235 **</b></p> <p><b>Labor: 1 Year</b> from the Date of Purchase.</p> <p><b>Parts: 1 Year</b> from the Date of Purchase.</p> <p><b>Magnetron: 10 Years</b> from the Date of Purchase.</p>	<p><b>HOW SERVICE IS HANDLED:</b></p> <p>Call 1-800-243-0000 and choose the appropriate prompt. Please have product type (Microwave) and ZIP code ready.</p>
---	--

**THIS WARRANTY IS IN LIEU OF ANY OTHER WARRANTIES, EXPRESS OR IMPLIED, INCLUDING WITHOUT LIMITATION, ANY WARRANTY OF MERCHANTABILITY OR FITNESS FOR A PARTICULAR PURPOSE. TO THE EXTENT ANY IMPLIED WARRANTY IS REQUIRED BY LAW, IT IS LIMITED IN DURATION TO THE EXPRESS WARRANTY PERIOD ABOVE. LG WILL NOT BE LIABLE FOR ANY CONSEQUENTIAL, INDIRECT, OR INCIDENTAL DAMAGES OF ANY KIND, INCLUDING LOST REVENUES OR PROFITS, IN CONNECTION WITH THE PRODUCT. SOME STATES DO NOT ALLOW LIMITATION ON HOW LONG AN IMPLIED WARRANTY LASTS OR THE EXCLUSION OF INCIDENTAL OR CONSEQUENTIAL DAMAGES, SO THE ABOVE LIMITATIONS OR EXCLUSIONS MAY NOT APPLY TO YOU.**

**THIS LIMITED WARRANTY DOES NOT APPLY TO:**

1. Service trips to your home to deliver, pick up, and/or install the product, instruct, or replace house fuses or correct wiring, or correction of unauthorized repairs; and
2. Damages or operating problems that result from misuse, abuse, operation outside environmental specifications or contrary to the requirements or precautions in the Operating Guide, accident, vermin, fire, flood, improper installation, acts of God, unauthorized modification or alteration, incorrect electrical current or voltage, or commercial use, or use for other than intended purpose.
3. **Therefore, the cost of repair or replacement of such a defective product shall be borne by the consumer.**

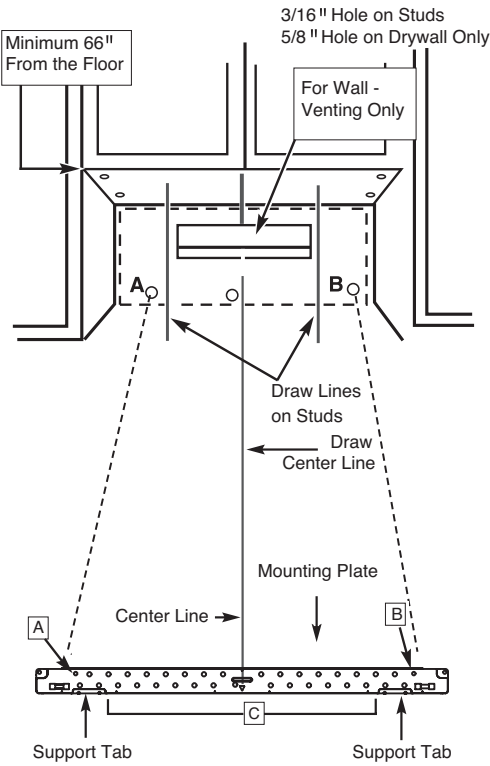
Problem	Cause	Solution
<p>Microwave oven Installation issue</p> <ul style="list-style-type: none"> <li>- Vibration noise</li> <li>- Unit is not level</li> <li>- Installation damage</li> </ul>	<p>1. Mounting bracket screw not fixed completely</p> <p>2. Mounting plate not aligned</p>  <p>3. Product carried/installed improperly</p>	<p>Check with installer first</p>
<p>Spark / Arcing</p>	<p>Aluminum foil or metal utensil used in microwave mode</p>	<p>DO NOT use aluminum foil or metal utensils in microwave mode</p> <ul style="list-style-type: none"> <li>- Check user instructions</li> </ul>

The cost of repair or replacement under these excluded circumstances shall be borne by the consumer.

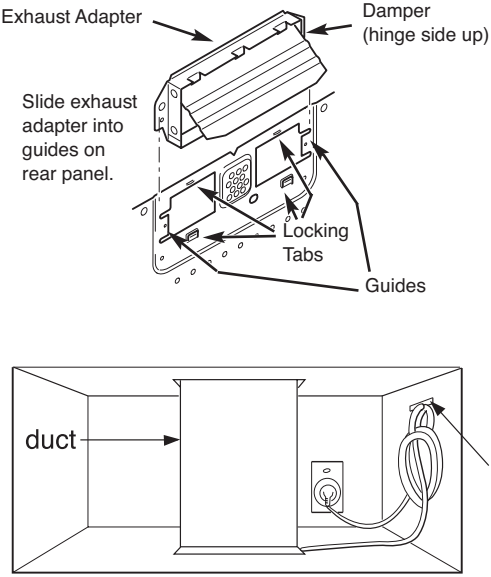

Problem	Cause	Solution
Unit has no power	1. House power turned off (power supply) 2. Tripped breaker  3. The power cord is not installed properly	1. Check house power supply 2. Check proper power cord connection 3. Check extension cord
Vent is not working - Weak or no ventilation - Abnormal noise during operation - Product overheating	1. Improper blower unit direction or installation  2. Improper ductwork or damper connection  	1. Check blower unit direction and reinstall if necessary.  2. Properly align the exhaust ports and blower plate opening.  3. Blower unit exhaust ports should be completely exposed to the outside  4. After installation, check the air ventilation path

The cost of repair or replacement under these excluded circumstances shall be borne by the consumer.

**CUSTOMER INTERACTIVE CENTER NUMBERS:**

<p><b>To Prove Warranty Coverage</b></p>	<p><b>Retain your Sales Receipt to prove date of purchase.</b> A copy of your Sales Receipt must be submitted at the time warranty service is provided.</p>
<p><b>To Obtain Nearest Authorized Service Center or Sales Dealer, or to Obtain Product, Customer, or Service Assistance</b></p>	<p><b>Call 1-800-243-0000</b> (Phone answered 24 hours, 365 days a year) and choose the appropriate prompt from the menu; <b>Or visit our website at: <a href="http://www.lg.com">www.lg.com</a></b></p>

