



USER GUIDE

LG Watch Style

LG-W270

About this user guide

Thank you for choosing this LG product. Please carefully read this user guide before using the device for the first time to ensure safe and proper use.

- Always use genuine LG accessories. The supplied items are designed only for this device and may not be compatible with other devices.
- This device is not suitable for people who have a visual impairment due to the touchscreen keyboard.
- Descriptions are based on the device default settings.
- Default apps on the device are subject to updates, and support for these apps may be withdrawn without prior notice. If you have any questions about an app provided with the device, please contact a LG Service Center. For user-installed apps, please contact the relevant service provider.
- Modifying the device's operating system or installing software from unofficial sources may damage the device and lead to data corruption or data loss. Such actions will violate your LG licence agreement and void your warranty.
- Some content and illustrations may differ from your device, depending on the area, service provider, software version, or OS version, and are subject to change without prior notice.
- Software, audio, wallpaper, images, and other media supplied with your device are licenced for limited use. If you extract and use these materials for commercial or other purposes, you may be infringing copyright laws. As a user, you are fully responsible for the illegal use of media.
- Additional charges may incur for data services, such as messaging, uploading, downloading, auto-syncing and location services. To void additional charges, select a data plan suitable to your needs. Contact your service provider to obtain additional details.

Instructional notices



WARNING: Situations that could cause injury to the user and third parties.



CAUTION: Situations that may cause minor injury or damage to the device.



NOTE: Notices or additional information.

Table of Contents

01

Basic Functions

- 6 Accessories
- 7 Watch Overview
- 9 Get ready for snap-and-swap
- 10 Charging Your Watch
- 12 Using the battery efficiently
- 13 If the Screen Freezes
- 13 Turning the Watch On and Off
- 14 Waking Your Watch Up
- 14 Dimming the Screen
- 14 Using the Touch Screen

02

Connecting the Watch to Your Companion Device

- 18 Setting Up Your Companion Device
- 19 Pairing Your Watch with Your Companion Device

- 20 Connecting to Another Companion Device

03

How to Use Your Watch

- 22 Watch Face Home Screen
- 22 Changing the Watch Face
- 24 Notification Cards
- 25 Managing the Quick Settings
- 26 Apps Screen
- 26 Call
- 28 Google Fit
- 31 Opening the Apps Installed On Your Watch
- 32 Downloading Other Apps

04

Meet your Google Assistant

- 34 Getting help from your Google Assistant on Your Watch
- 34 Setting a Reminder
- 35 Seeing Your Step Count
- 35 Sending a Text
- 36 Sending and Reading Email
- 37 Setting a Timer
- 38 Using the Stopwatch
- 38 Setting an Alarm
- 39 Managing Your Alarms

05

Settings

- 41 Opening the Settings Menu
- 41 Display
- 41 Notifications
- 42 Apps
- 42 Gestures
- 42 Connectivity
- 44 Accessibility

- 45 Personalization
- 45 System

06

More Information

- 47 Open Source Software Notice Information
- 47 Trademarks
- 48 Regulatory Information (FCC ID number, etc.)
- 48 How to Update Your Device

07

Safety Information

- 50 Safety tips
- 51 General safety & handling



01

Basic Functions

Accessories

The following accessories are provided with your device.

- Quick Start Guide
- Charging cradle
- Charger



- The items supplied with the device and any available accessories may vary depending on the region or service provider.
- Always use genuine LG Electronics accessories. Using accessories made by other manufacturers may affect your device's call performance or cause malfunctions. Any issues resulting from usage of accessories made by other manufacturers may not be covered by LG's repair service.
- The accessories are not water-resistant. Do not expose these items to water.



- If any of these basic items are missing, contact the dealer from which you purchased your device.
- To purchase additional basic items, contact the LG Customer Support Center.
- To purchase optional items, contact the LG Customer Support Center for available dealers, and then purchase online.
- Some items in the product box are subject to change without notice.
- The appearance and specifications of your device are subject to change without notice.

Watch Overview

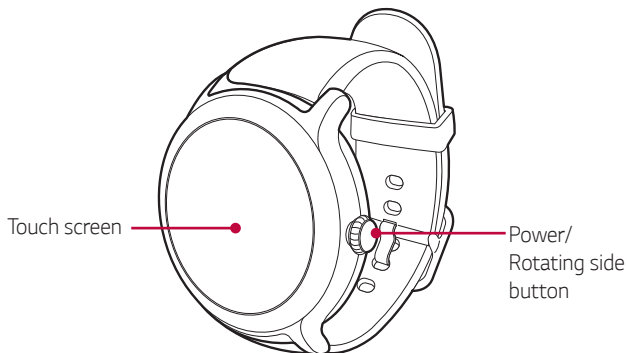

Power/Rotating side button

To turn the watch on:

- Press and hold for one second to turn the screen on. If it doesn't turn on, press and hold for a few seconds until the LG logo appears.

When the screen is dimmed:

- Press once to wake the screen.

When the screen is on:

- Press to open the Apps screen when you are on the watch face home screen.
- Press to return to the previous when you are on any other screen.
- Press and hold for one second to get help from your Google Assistant.

Power/Rotating side button

Rotating the Power/Rotating side button:

- Rotate to browse the apps list on the Apps screen.
- Rotate to show or hide notifications in the watch face home screen.

If the screen freezes:

- Press and hold for more than 10 seconds until the LG logo appears to restart the watch.

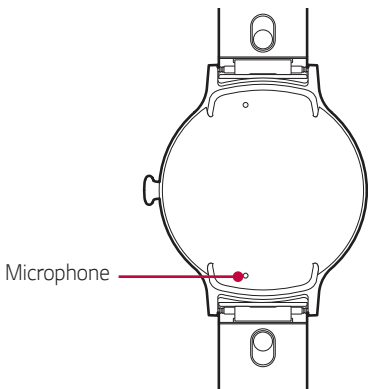

- Keep the microphone holes clear.
- Any damage to the microphone resulting from accidents, unreasonable use, tampering or other causes not arising from defects in material or workmanship may void the Limited Warranty.

Get ready for snap-and-swap

Switch styles anytime with MODE™ snap-and-swap watch bands.

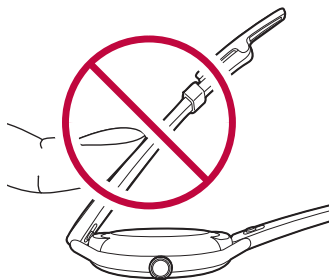
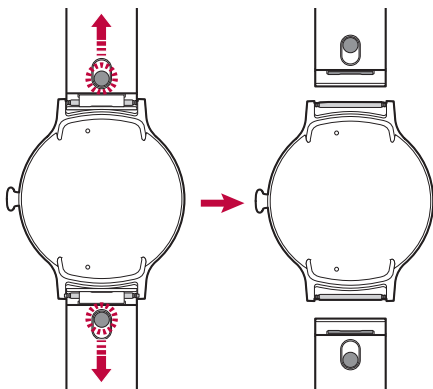

• Excess force on the watch band may lead to breakage.

Charging Your Watch

Before using your watch for the first time, you should charge the battery. Use the charging cradle provided with your watch to charge its battery.

The supplied charging cable will allow you to charge from a power outlet or from a computer.



- When the battery power is low, the battery icon may show as empty. If the battery charge is completely empty, the watch cannot be turned on immediately after connecting the charger. Leave an empty battery to charge for a few minutes before turning the device on. Some features are not available while the battery is charging.



- To charge your device, always use the power adapter and charging cradle that come with your device. Using third-party charging accessories can cause fire, electric shock, injury, or damage to your device or other property.
- Your device has an internal rechargeable battery. For your safety, do not remove the embedded battery.

- 1 Connect the USB plug on the charging cradle to the charger adapter.
- 2 Plug the charger adapter into a power outlet.

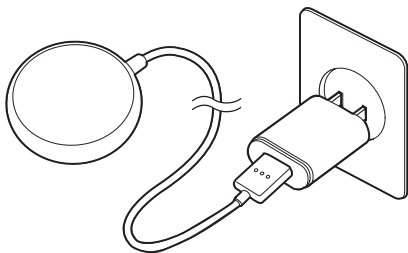

- To charge from a PC, insert the USB plug on the charging cradle into a USB port on the PC.
- A power source connected a PC may result in a slower charging speed due to a lower electric current than a power outlet.

3 Place your device on the charging cradle as shown below.

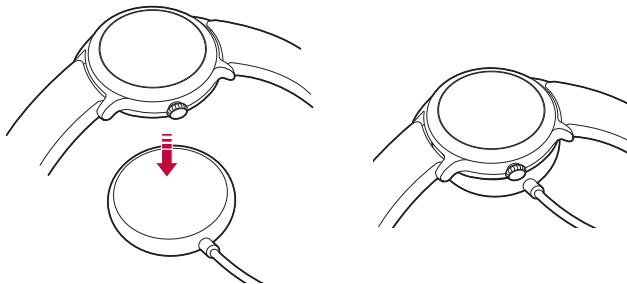

- The charging cradle is designed to only be used with the watch and is not compatible with other devices.
- To maximize battery life, make sure that the battery is fully charged before you use the device for the first time.
- Exposure to liquids or other foreign materials while using your device may affect the charging cradle, causing it to disconnect from the watch while charging.
- If the charging screen does not display after connecting to a power source, adjust your device's position on the charging cradle.

- 4 While your watch is charging, the screen will show the time, battery percentage and charging progress (indicated by the ring around the outside).

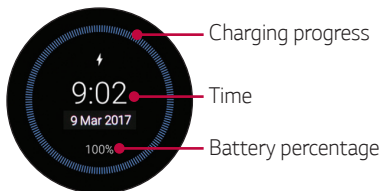

- 5 Once the battery is fully charged, remove it from the charging cradle.



- The watch may become warm while charging. If the device becomes hotter than usual, discontinue charging until it cools.

Using the battery efficiently

To minimize battery consumption, follow these tips.

- Turn off the Always-on screen option when not using your watch for a long time.
- Minimize the screen brightness.
- Turn off the Wi-Fi network function when not using Wi-Fi.
- Turn off the Gestures feature.
- If you get notifications on your companion device that you don't want to see on your watch, go to the Android Wear app Settings on your companion device and add those apps to the **Block app notifications**.
- If you feel the battery life is short after installing some specific app, try to uninstall it.



- Battery Saver is automatically enabled at the 15% battery capacity on your watch. In battery saver mode, the ambient display and Wi-Fi are set to off.

If the Screen Freezes

If the device freezes up and stops working, press and hold the **Power button** for more than 10 seconds until the device reboots and the LG logo is displayed.

Turning the Watch On and Off

Turning the Watch On

Press and hold the **Power button** for a few seconds.

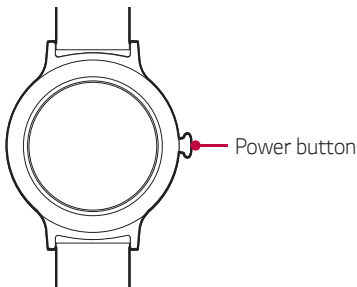

Turning the Watch Off

- 1 Press the **Power button** to open the Apps screen.
- 2 Tap **Settings > System > Power off**.
- 3 When prompted with the message **Power off: Are you sure?**, tap .

Waking Your Watch Up

If the screen is dimmed, you can wake up the watch by doing any of the following:

- Touch the screen.
- Raise your wrist such that the display of the watch is pointing towards your eyes.
- Press the **Power button** on the watch.

Dimming the Screen

Cover the screen with your palm until it vibrates.

Using the Touch Screen

You can familiarize yourself with how to control your device by using touch screen gestures.

Tapping

Lightly tap with your fingertip to select or run an app or option.

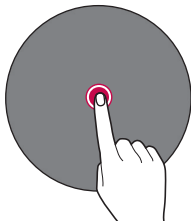

Touching and holding

Touch and hold for several seconds to display the available options.

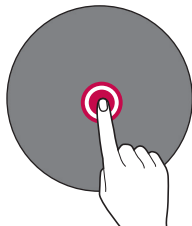

Swiping

Quickly move your finger across the surface of the screen, without pausing when you first touch it.

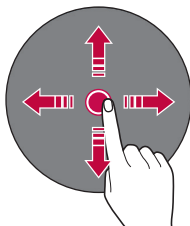

- Do not expose the touch screen to excessive physical shock. It might damage the touch sensor.



- A touch screen failure may occur if you use the device near a magnetic, metallic or conductive material.
- If you use the device under bright lights, such as direct sunlight, the screen may not be visible, depending on your position. Use the device in a shady location or a location with an ambient light that is not too bright and bright enough to read books.
- Do not press the screen with excessive force.
- Touch control may not work properly if you tap while wearing a glove on or by using the tip of your fingernail.
- The touch screen may not function properly if a screen-protective film or accessory is attached to the device.
- Do not display non-moving images for an extended period. This may cause image burn-in on the screen.
- Applications that show the same screen for more than 10 minutes are not recommended because they may cause screen damage that is not covered by the warranty.





02

Connecting the Watch to Your Companion Device

Setting Up Your Companion Device

Before pairing, follow these steps to set up your companion device that you want to pair with your watch.

- 1 Make sure the companion device is running Android™ 4.3 or iOS 9+ and supports Bluetooth®.
 - If your companion device is not Android 4.3 or iOS 9+, please check with your manufacturer for a possible software update.
- 2 Make sure your companion device supports Android Wear™.
 - To find out, visit <http://g.co/WearCheck> from your companion device.
- 3 Turn on Bluetooth on your companion device if it isn't already on.
- 4 Make sure your companion device is next to your watch.
- 5 On your companion device, download the **Android Wear**  app from the **Play Store** or **App Store** and install it. If **Android Wear**  is already on your companion device, make sure you have the most recent version.
- 6 Make sure your companion device is connected to mobile data or a Wi-Fi network. You need a data connection to set up your watch for the first time.



- Depending on the network connection, the setup process might take over 20 minutes.

Pairing Your Watch with Your Companion Device

Step 1. Follow these steps on your watch.

- 1 Turn on the watch and tap the screen to begin.
- 2 Tap a language.
- 3 Swipe up and follow the onscreen instructions until the watch name is displayed.

Step 2. Follow these steps on your companion device.

- 1 Open the **Android Wear**  app on your companion device.
- 2 On your companion device, you'll see a list of nearby devices. Tap your watch's name.
- 3 You'll see a passkey on your companion device and watch. Check that the codes match.
- 4 Tap **PAIR** on your companion device to start pairing.

Step 3. Follow these steps to pair your watch with your companion device.

- 1 You'll see a confirmation message on your watch once it is paired. This may take a few minutes.
- 2 Follow the onscreen instructions to complete the initial setup.
- 3 When your watch completes the connection with your companion device, you'll be asked to copy your Google accounts on your companion device to your watch.



- Copying a Google account to your watch allows you to download new apps using the Play Store.
- Once initial setup is complete, you will see a tutorial notification . Follow the tutorial notices before using your watch.

Connecting to Another Companion Device

Your watch connects to one mobile device at a time. If you want to connect your watch to a different device, you must reset your watch using the **Disconnect & reset** setting on your watch.

Unpairing and Resetting Your Watch

This setting unpairs the watch from your companion device and resets your watch's settings to their factory default values and deletes all of your data.

- 1 Press the **Power button** to open the Apps screen
- 2 Tap **Settings > System > Disconnect & reset**.
- 3 When prompted, tap  to confirm.
- 4 Connect your watch to another device.



- Performing a factory reset erases all data from your watch's memory and all watch data from your companion device. After resetting, your watch is ready to connect to another companion device.



03

How to Use Your Watch

Watch Face Home Screen

The watch face home screen is the starting point for the default screen. You see the current time and date. You can also show the battery level, your step count, and more.



• The displayed content depends on the watch face design you select.

Changing the Watch Face

You can add more watch faces and personalize your watch to your style.

- 1 From the watch face home screen, swipe left or right to the last screen and then tap **Add more watch faces** .
- 2 Tap the desired watch face to add it to your favorites and allow you to choose it.
- 3 After adding your favorites, swipe the screen right or left to browse designs, then tap the one you want to choose.

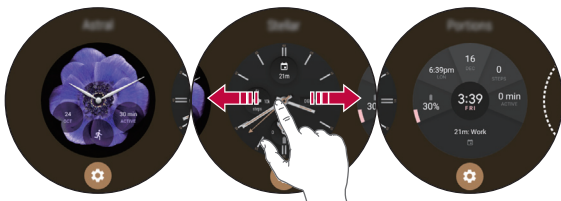



- You can also change and download watch faces through the **Android Wear** app on your companion device.

Customize the Watch Face Home Screen Menu

- 1 Touch and hold the watch face home screen for one second.
OR
Swipe left or right from the watch face home screen and then tap **Customize** .
- 2 Tap **Data** to customize the shortcuts and watch face layout displayed on the watch face home screen.



- To personalize the shortcuts, tap the shortcut you want to remove and select the desired item.

Notification Cards

Most notifications you see on your companion device will also show up on your watch. These include notifications for texts, event reminders, and more.

Notifications are displayed in the form of cards. Card previews appear at the bottom of the watch face home screen.

- To see a notification card, swipe the watch face upwards.
- To see more cards, keep swiping up from the bottom of the screen.
- To get more details, tap the notification card.



Notification cards

Swipe up on the watch face to view notification cards.

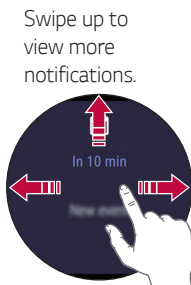



Swipe up to view more notifications.

To remove a notification, swipe it away.

Blocking Notifications

If you get notifications on your companion device that you don't want to see on your watch, you can stop specific apps from showing their notifications on your watch.

- 1 On your companion device, open the **Android Wear**  app.
- 2 Tap  > **Block app notifications** > .
- 3 Select the app you want to block.

Managing the Quick Settings

To open the Quick settings, swipe down on the watch face home screen. The Quick settings allow you to quickly and easily change commonly used settings.

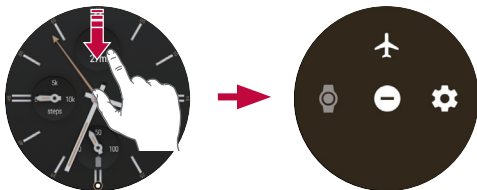

- **Airplane mode** ✈️ : Tap ✈️ to disconnect all networks and turn off your device's connectivity on your watch.
- **Theater mode** 🕒 : Tap 🕒 to turn off your watch's screen. When theater mode is turned on, your watch's display does not light up and notifications do not appear.
- **Do not disturb** 🚫 : Your watch will not show any notifications and alerts while this setting is turned on.
- **Settings** ⚙️ : Tap ⚙️ to open the Settings app.



- Some content may differ from your companion device depending on the OS version.

Apps Screen

The Apps screen displays icons for all apps.

- From the watch face home screen, press the **Power button** to open to the Apps screen.
- To open an app on the Apps screen, tap an app icon.

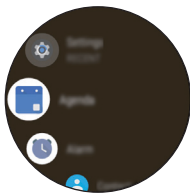

Call

Making a Call

You can make a call directly from your watch.

- 1 Open the Apps screen and then tap **Contacts**.

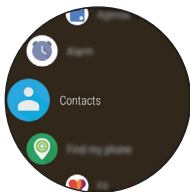

- 2 Tap a contact you want to call. Your companion device will make a call to the number you've called on your watch.

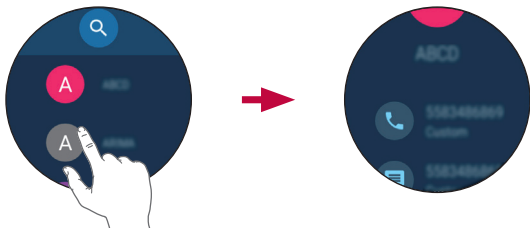

Rejecting a Call

You can get an instant alert when your companion device receives an incoming call. The notification shows the caller's number and/or contact information on your watch.

- To reject a call, simply tap .

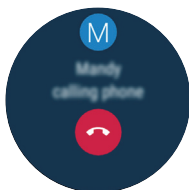

Google Fit

Google Fit helps to work out when you're walking, jogging or cycling. Set fitness goals and regularly record and check your progress.

To Open the Google Fit App

Open the Apps screen and then tap **Fit**.

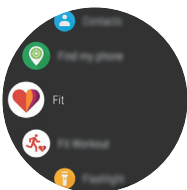

- If you feel discomfort while using the device, stop using it and remove it from your wrist.
- If your device becomes hot to the touch, please remove it until it cools.

Using the Google Fit App

Setting up your goal

- 1 Open the **Fit** app to personalize your goal.
- 2 Swipe up and tap **Add goal** (⊕) to set one of the following preset goals or create your own: **Take 10,000 steps a day**, **Active 30 min a day**, **Running 3 times a week**, **Steps**, **Distance**, **Active time**, **Calories**.

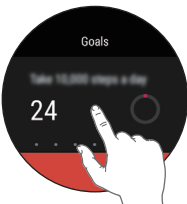

Viewing your workout report



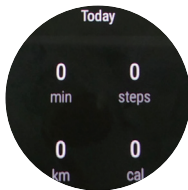

Your workout log displays your active time, steps, distance, and active calories.

- 1 Open the **Fit** app and swipe up until the workout report appears.
- 2 Tap each goal option to show workout information and a graph depicting weekly data.



Using the Fit Workout App

Open the Fit Workout app

- 1 Open the **Fit** app and tap **Fit Workout** .
OR
Open the **Fit Workout** app.
- 2 Tap the desired workout mode.
- 3 Tap **START** to start monitoring your workout.
 - Tap  to pause or  to resume the workout.
 - Tap  to complete your workout and view your workout report.



- 4 While on the workout screen, swipe up and then tap  to change the metrics displayed.
- To change the metric displayed on the workout screen, tap an option until the desired option appears.

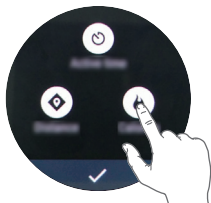

Opening the Apps Installed On Your Watch

The apps list shows you all of the applications installed on the watch. Swipe up and down to scroll through the list, and then tap one to use it. The most recently used app is displayed at the top of the list.



- Default apps on the device are subject to updates. Support for these apps may be withdrawn without prior notice. If you have any questions about an app provided with the device, please contact an LG Service Center. For user-installed apps, please contact the relevant service provider.
- Modifying the device's operating system or installing software from unofficial sources may damage the device and lead to data corruption or loss. Such actions will violate your LG license agreement and void your warranty.

Viewing the Apps List

- 1 If your screen is dimmed, tap the screen to wake up the watch.
- 2 Press the **Power button** to open the Apps screen.

Downloading Other Apps

After copying your companion device's Google accounts to your watch, you can download more apps on Google Play™ .

To use the same apps which are already installed on your companion device, download them again on your watch. You can download them easily via the 'Apps you've used' category on Google Play™ .



- The apps on your device, and their functions, may vary according to country, region or hardware specifications. LG will not be responsible for any performance issues which arise from using applications developed by providers other than LG.
- LG will not be responsible for performance or incompatibility issues which arise from edited registry settings or modified operating system software.
- Any attempt to customize your operating system may lead to the device or its apps not working correctly.
- Software, audio, wallpaper, images, and other media supplied with your device are licensed for limited use. If you extract and use these materials for commercial or other purposes, you may be infringing copyright laws. As a user, you are entirely responsible for the illegal use of media.
- Additional charges may apply for data services, such as messaging, uploading, downloading, auto-syncing and location services. To avoid additional charges, select a data plan suitable to your needs. Contact your service provider for details.
- This content is not supported in iOS version.



04

Meet your Google Assistant

Getting help from your Google Assistant on Your Watch

Your watch has the Google Assistant built in. Ask it questions. Tell it to do things. It's your own personal Google. Tap **Settings > Personalisation > "OK Google" detection** to activate it. Just say **"OK Google"** or press and hold the **Power button** until you see **Hi, how can I help?**



- To get help from your Google Assistant a data or Wi-Fi connection is required on your companion device, and the devices must be within Bluetooth range.
- This feature may vary or may not be supported, depending on the area, languages, or paired devices.

Setting a Reminder

You can ask your Google Assistant to set a reminder. When a reminder is set, a card will appear at the reminder time.

- 1 If your screen is dimmed, tap the screen to wake up the watch.
- 2 From the watch face home screen, say **"OK Google"** or press and hold the **Power button** until you see **Hi, how can I help?**
- 3 Say **"Remind me"**.
- 4 Complete your reminder when prompted. Your reminder will automatically save after a few seconds (tap the  before it finishes saving to cancel it.)

Seeing Your Step Count



You can view your step count goal, the number of steps you have taken today and each day over the last week, as measured by the Fit app.

- 1 If your screen is dimmed, tap the screen to wake up the watch.
- 2 From the watch face home screen, say **"OK Google"** or press and hold the **Power button** until you see **Hi, how can I help?**
- 3 Say **"Show me my steps"**. You will see your daily step count information.

Sending a Text

You can ask your Google Assistant to send text messages using your watch. You can also reply to any text message cards that you receive on your watch.

Sending a Message

- 1 If your screen is dimmed, tap the screen to wake up the watch.
- 2 From the watch face home screen, say **"OK Google"** or press and hold the **Power button** until you see **Hi, how can I help?**
- 3 Say **"Send a text"**.
- 4 **To whom?** will appear. Say the name of the contact you want to send a text message to. You can also say a mobile phone number for numbers not saved in your companion device's Contacts list.
- 5 You will be prompted to say the message you want to send. Say your message.
- 6 Tap  to send the text message (tap  to cancel it).

Replying to a Message

When you get message notifications on your companion device, cards will appear on your watch. Tap the notification and swipe up until **Reply** appears. Tap **Reply**, then say your message or insert emoticons or input message using the keyboard. To insert an emoticon, like a smiley, into the message, tap 😊.

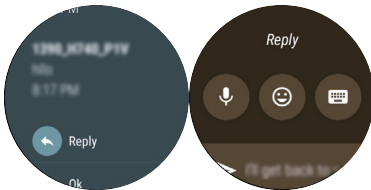



• This content is not supported in iOS version.

Sending and Reading Email

Your watch can be used to write and read emails from your companion device.

- 1 If your screen is dimmed, tap the screen to wake up the watch.
- 2 From the watch face home screen, say **"OK Google"** or press and hold the **Power button** until you see **Hi, how can I help?**
- 3 Say **"Send email"**.
- 4 **To whom?** will be displayed.
- 5 Say the name of the contact (from the companion device's Contacts list) you want to send an email to. If a list appears, select the contact you want.
- 6 You will be prompted to say the message you want to send.
- 7 Tap ⏩ to send the email (tap ✕ to cancel it).

Replying to an Email

When reading an email notification card on your watch, swipe the card up to access actions you can take. Tap , select **Reply** and say your message, insert emoticons or input your message using the keyboard. To insert an emoticon, like a smiley, into the message, tap one of the emoticons at the bottom of the screen. Tap  to send the email (tap  to cancel it).





• This content is not supported in iOS version.

Deleting Email Messages

When reading an email notification card on your watch, swipe the card up and tap **Delete**.

Setting a Timer

You can ask your Google Assistant to set a timer. Once a timer set, a card is displayed with the countdown.

- 1 If your screen is dimmed, tap the screen to wake up the watch.
- 2 From the watch face home screen, say "OK Google" or press and hold the **Power button** until you see **Hi, how can I help?**
- 3 Say "Set a timer".
- 4 **How long?** will be displayed and then you can say a duration you want.
 - Start or resume the countdown by tapping .
 - Pause the timer by tapping .

Using the Stopwatch

Measure how much time has passed by starting a stopwatch.

- 1 If your screen is dimmed, tap the screen to wake up the watch.
- 2 From the watch face home screen, say "OK Google" or press and hold the **Power button** until you see **Hi, how can I help?**
- 3 Say "**Start stopwatch**".
- 4 Tap ▶ to start.

Setting an Alarm

Multiple alarms can be set on your watch separately from alarms set on your companion device. Alarms set on your watch will not transfer to your companion device, but alarms activated on your companion device will display an alarm card (with vibration and sound, if set) on your watch.

- 1 If your screen is dimmed, tap the screen to wake up the watch.
- 2 From the watch face home screen, say "OK Google" or press and hold the **Power button** until you see **Hi, how can I help?**
- 3 Say "**Set an alarm**".
- 4 **What time?** will be displayed and then you can say the time you want.

When an alarm goes off, your watch will display a card (with vibration and sound, if set).

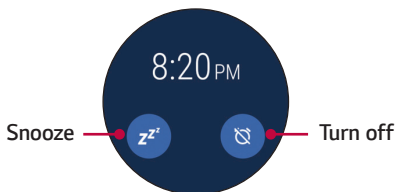



Managing Your Alarms

You can view, edit, and delete the alarms that you set on your watch.

- 1 If your screen is dimmed, tap the screen to wake up the watch.
- 2 From the watch face home screen, say "OK Google" or press and hold the **Power button** until you see **Hi, how can I help?**
- 3 Say "**Show alarms**".



- Tap  next to an alarm to edit or delete it.
- Tap  to manually set an alarm.





05

Settings

Opening the Settings Menu

If your screen is dimmed, tap the screen to wake up the watch.

- Press the **Power button** to open the Apps screen, then tap **Settings** .
- OR
- Swipe down on the watch face home screen, then tap **Settings** .



- Tap a setting to turn it on or off, open a list of choices, or view information.

Display

From the **Settings** , tap **Display**.

- **Adjust brightness:** You can set the level of brightness for your watch's display.
- **Font size:** You can set the size of the font displayed on your watch's screen.
- **Always-on screen:** When you're not using the watch, the screen can either turn off or show the current time, depending on your settings.

Notifications

From the **Settings** , tap **Notifications**.

- Set the following options: **Notification previews** and **Do not disturb unless...**

Apps

From the **Settings** , tap the **Apps > System Apps**.

- Allows you to view and manage the apps on your device. To stop the app from running, tap an entry to view more information, tap **Force stop**, then .
- You can set control permissions for individual applications.

Gestures

From the **Settings** , tap **Gestures**.

- **Tilt-to-wake**: You can set to tilt your watch to turn on the screen.
- **Wrist gestures**: You can set to flick your wrist to browse the screen.
- **Launch tutorial**: View a tutorial about using gestures on your watch.
- **More tips**: Opens a webpage on your companion device to help you with more tips for gestures.

Connectivity

From the **Settings** , tap **Connectivity**.

Bluetooth

- **Bluetooth**: Tap the switch to toggle it On or Off. On allows you to pair and connect with other Bluetooth devices. Tap **Bluetooth** (with Bluetooth on) to use and manage your Bluetooth devices.
- **Available devices**: Displays all of the Bluetooth devices that are within your companion device's range. Tap one to pair and connect.



- When using Bluetooth to connect to other mobile devices, the devices must be positioned close to each other. If not, it may cause abnormal operation or noise, depending on the use environment.
- In an open space, the Bluetooth communication range usually spans approximately 10m. This range may vary depending on the use environment.
- Do not place obstacles between your product and connected devices. Outgoing/incoming signals can weaken due to user's body, walls, corners or obstacles. Use where there is no obstacle.
- Only Bluetooth devices that support the A2DP and HFP profile are supported.

Wi-Fi

- **Wi-Fi:** Tap the switch to toggle it On or Off. On connects to a Wi-Fi network (from your list of available, detected networks).
- **Add network:** Allows you to manually add a Wi-Fi network by entering its name (SSID), security, and password.
- **Saved networks:** Displays your saved Wi-Fi networks allowing you to manage them.
- **About Wi-Fi:** Displays information about Wi-Fi networks.



- When using a Wi-Fi connection, your watch can get notifications from your device even if Bluetooth is unavailable.
- Your watch will search and connect to the nearest Wi-Fi network based on the Wi-Fi list registered on your device.

Airplane mode

Tap the switch to toggle it On or Off. When Airplane mode is on, you can use still many of the features on your watch when you are on an airplane or anywhere else where sending or receiving data is prohibited.



- Turning on Airplane mode on your watch does not activate it on the your companion device. If you want to activate airplane mode on your companion device, you'll need to turn it on separately.

Location

Tap the switch to toggle it On or Off. You can manage your location services for determining your approximate location. Some apps like Weather and Maps need your location to work.



- When paired with a companion device, the watch will use the location of the companion device. To improve location accuracy when paired with a device, turn on High accuracy in your companion device's location settings.

Accessibility

From the **Settings** , tap **Accessibility**.

- **Magnification gestures:** You can set to enable magnification to zoom in and out with triple tap.

Personalization

From the **Settings** , tap **Personalization**.

- **Input methods:** You can customize language and keyboard settings for your device.
- **Accounts:** You can add or remove a Google account to your watch.
- **Smart Reply:** Allows you to reply to text messages without manually entering text by using preset messages.
- **“OK Google” detection:** Allows your watch to detect “OK Google” voice to activate it.
- **Device administration:** Allows you to view and disable your device administrators.
- **Screen lock:** You can set a screen lock to prevent unauthorized access to your device.

System

From the **Settings** , tap **System**.

- **Date & time:** You can set how your watch syncs and displays the date, time, and time zone.
- **Disconnect & reset:** You can unpair the watch from your companion device and reset your watch's settings to their factory default values. Please note that this deletes all of your data on your watch.
- **Restart:** You can restart your device.
- **Power off:** You can turn off your device
- **About:** Displays the Model, Device name, Versions (for Google and Android software), Serial number, Build number, Connection, and Battery information. The following options are also available:
 - **System updates:** Check to see if the latest software is loaded on your watch.
 - **Regulatory information:** Displays regulatory information.
 - **Legal notices:** Instructs you to see your companion device for legal notices.



06

More Information

Open Source Software Notice Information

To obtain the source code under GPL, LGPL, MPL, and other open source licenses, that are contained in this product, please visit <http://opensource.lge.com>.

In addition to the source code, all referred license terms, warranty disclaimers and copyright notices are available for download.

LG Electronics will also provide open source code to you on CD-ROM for a charge covering the cost of performing such distribution (such as the cost of media, shipping, and handling) upon email request to opensource@lge.com. This offer is valid for three (3) years from the date on which you purchased the product.

Trademarks

- Copyright ©2017 LG Electronics, Inc. All rights reserved. LG and the LG logo are registered trademarks of LG Group and its related entities.
- App Store is a registered trademark of Apple Inc.
- Android, Android Wear, Google Play, Google™ and other marks are trademarks of Google Inc.
- MODE is a trademark owned by Google Inc.
- Bluetooth® is a registered trademark of Bluetooth SIG, Inc. worldwide.
- Wi-Fi® and the Wi-Fi logo are registered trademarks of the Wi-Fi Alliance.
- All other trademarks and copyrights are the property of their respective owners.

Regulatory Information (FCC ID number, etc.)

To view regulatory marks and related information on your device, press the **Power/Rotating side button** and tap **Settings > System > About > Regulatory information**.

How to Update Your Device

Check for the latest available firmware releases, as well as new software functions and improvements.

- 1 Press the **Power/Rotating side button** to open the Apps screen.
- 2 Tap **Settings > System > About > System updates**.



07

Safety Information

Safety tips



- This product contains chemicals known to the State of California to cause cancer and birth defects or reproductive harm.

Wash hands after handling.

The charging cradle contains strong magnets that may interfere with pacemakers, credit cards, watches, and other magnet-sensitive objects. To avoid damaging your product and reduce the risk of fire or electric shock, explosion, or other hazards, observe the following safety precautions:

- To charge your device, always use the included power adapter, and charging cradle that come with your device. Using third-party charging solutions can cause fire, electric shock, injury, or damage to your device or other property.
- Available accessories may vary depending on your region, country or service provider.
- Some content and illustrations may differ from your device depending on the region, service provider, software version, or OS version, and are subject to change without prior notice.
- Do not damage the power cord by bending, twisting, pulling, heating, or placing heavy items on it.
- This product is equipped with a charging cradle for connecting to a desktop or notebook computer or to the charger. Be sure your computer is properly grounded before connecting your product to the computer. The power supply cord of a desktop or notebook computer has an equipment-grounding conductor and a grounding plug. The plug must be plugged into an appropriate outlet that is properly installed and grounded in accordance with all local codes and ordinances.
- Do not attempt to repair or modify or remanufacture the product. It is equipped with an internal rechargeable battery, which should be replaced only by LG or an authorized LG repair center.
- Do not open, disassemble, crush, bend or deform, puncture, or shred the product.
- Do not insert foreign objects into the product.
- Do not place the product in a microwave oven.
- Do not expose the product to fire, explosion, or other hazards.

- Like many electronic devices, this product generates heat during normal operation. Extremely prolonged, direct skin contact in the absence of adequate ventilation may result in discomfort or minor burns. Use care when handling your product during or immediately after operation.
- If a problem arises using this product, stop using it and consult with an authorized LG Electronics customer service center

General safety & handling

While using your product, be aware of the following safety guidelines.

Your environment

- **Safe operating temperatures.** Use and store your product in temperatures between 0°C/32°F and 35°C/95°F. Exposing your product to extremely low or high temperatures may result in damage, malfunction, or even explosion.
- **While driving.** When driving a car, driving is your first responsibility. Using a companion device or accessory for a call or other application while driving may cause distraction. Keep your eyes on the road.
- **Around explosives.** Do not use in areas where sparks from the product might cause a fire or explosion.
- **On airplanes.** Observe all rules and instructions for use of electronic devices. Most airlines allow electronic use only between and not during takeoffs and landings. There are three main types of airport security devices: X-ray machines (used on items placed on conveyor belts), magnetic detectors (used on people walking through security checks), and magnetic wands (hand-held devices used on people or individual items). You can pass your product through airport X-ray machines. But do not send it through airport magnetic detectors or expose it to magnetic wands.
- Always follow any special regulations in a given area. Turn your device off in areas where use is forbidden or when it may cause interference or danger.

Battery warnings

- Do not disassemble, open, crush, bend or deform, puncture or shred the device.
- Do not modify or re-manufacture the device, attempt to insert foreign objects into the battery, immerse or expose to water or other liquids, or expose to fire, explosion or other hazard.
- Make sure that no sharp-edged items, such as animals' teeth or claws, come into contact with the battery. This could cause a fire.
- Only use the battery for the device for which it is specified.
- Only use the watch with an LG charging system that has been qualified with the system per CTIA Certification Requirements for Battery System Compliance to IEEE1725.
- Use of an unqualified battery or charger may present a risk of fire, explosion, leakage, or other hazard.
- Battery usage by children should be supervised.
- Avoid dropping the device. If the device is dropped, especially on a hard surface, and the user suspects damage, take it to a service center for inspection.
- Improper battery use may result in a fire, explosion or other hazard.
- Always unplug the charger from the wall socket after the device is fully charged to save unnecessary power consumption of the charger.
- There is risk of explosion if the battery is replaced with an incorrect type.
- To dispose of the battery properly, call 1-800-822-8837 or visit www.call2recycle.org

Notice for battery Replacement



- Do not remove the back cover.
- Your device has an internal battery. For your safety, do not remove the battery incorporated in the product. If you need to replace the battery, take it to the nearest authorized LG Electronics service point or dealer for assistance.
- The Li-Ion Battery is a hazardous component which can cause injury.
- Battery replacement by non-qualified professional can cause damage to your device.

Notes on water resistant properties

This product is water and dust resistant in compliance with the Ingress Protection rating IP67.

Your product has undergone testing in a controlled environment and is proven to be water and dust resistant in certain circumstances (meets the requirements of classification IP67 as described by the international standard IEC 60529 - Degrees of Protection provided by Enclosures [IP Code]; test conditions: 15-35°C, 86-106 kPa, 1 meter, for 30 minutes). Do not expose the device in conditions that are different from the test conditions. Results may vary in actual use.



- In conditions that are different from LGE's test conditions for IP67 (as specified in this manual), the liquid damage indicator located inside the product changes color. Please note that any damages that occur due to such causes makes you ineligible for any free-of-charge repair services provided under warranty.

Avoid exposing the product to environments with excessive dusts or moisture. Do not use the product in the following environments.



Do not immerse the product in any liquid chemicals (soap, etc.) other than water.



Do not immerse the product in salt water, such as sea water.



Do not immerse the product in hot spring.



Do not swim while wearing this product.



Do not immerse your product in water deeper than 3 feet (approximately 1 meter).

Do not immerse your product in water for longer than 30 minutes.



Do not place the product directly on sand (such as at a beach) or mud.

- Drain water if the voice activation does not work properly due to water remaining in the microphone.
- Should your product or your hands become wet, dry them before handling the device.
- Do not use the product in places where it may be sprayed with high-pressure water (e.g. near a faucet or shower head) or submerge it in water for extended periods of time, as the product is not designed to withstand high water pressure.
- This product is not resistant to shock. Do not drop the product or subject it to shock. Doing so might damage or deform the main unit causing water leak.
- The product's water and dust resistant features may be damaged by dropping or receiving an impact.
- If the product gets wet, use a clean, soft cloth to dry it thoroughly.
- The touch screen and other features may not work properly if the device is used while wet.

Pacemakers and other medical devices

Persons with pacemakers should:

- Always keep the product more than six (6) inches from their pacemaker when the product is turned ON.
- Not carry the product in a breast pocket.
- Use the wrist opposite the pacemaker to minimize the potential for RF interference.
- Turn the product OFF immediately if there is any indication that interference is taking place.

If you use any other personal medical device, consult your physician or the manufacturer of your device to determine if it is adequately shielded from external RF energy.

Tips for using Bluetooth and Wi-Fi on your watch

- When connecting your product to other mobile devices, the devices must be positioned close to each other. If not, it may cause abnormal operation or noise, depending on the use environment.
- In an open space, the Bluetooth communication range usually spans approximately 10m. This range may vary depending on the use environment.
- Do not place obstacles between your product and connected devices. Outgoing/incoming signal can weaken due to user's body, walls, corners or obstacles. Use where there is no obstacle.
- When using a Wi-Fi connection, your watch can get notifications from your device even if Bluetooth is unavailable.
- Your watch will search and connect to the nearest Wi-Fi network based on the Wi-Fi list registered on your device.

Tips for the display screen

- Do not display non-moving images for an extended period. This may cause image burn-in or stains on the screen.
- Applications that display the same screen for more than 10 minutes are not recommended because they may cause screen damage that is not covered by the warranty.

Exposure to radio frequency (RF) Energy

In August 1996, the U.S. Federal Communications Commission (FCC), with its action in Report and Order FCC 96-326, adopted an updated safety standard for human exposure to Radio Frequency (RF) electromagnetic energy emitted by FCC-regulated transmitters. The design of this product complies with the FCC guidelines and these international standards.

Body-Worn(Wrist) and Next-to-Mouth Operation

This device was tested for typical body-worn (wrist) operations with 0 inches (0cm) between the user's body (wrist) and the back of the device.

This device was also tested for typical next-to-mouth (face) operations with 0.39 inches (1cm) between the user's mouth (face) and the front of the device.

To comply with FCC RF exposure requirements, a minimum separation distance of 0.39 inches (1 cm) must be maintained between the user's mouth(face) and the front of the device.

Any accessories containing metallic components may not be used.

Specific Absorption Rate (SAR) values

Your product is a radio transmitter and receiver. It is designed and manufactured not to exceed the emission limits for exposure to Radio Frequency (RF) energy set by the Federal Communications Commission (FCC) of the U.S. Government. The standards include a substantial safety margin designed to assure the safety of all persons, regardless of age and health.

The exposure standard for wireless products employs a unit of measurement known as the Specific Absorption Rate, or SAR. In the United States and Canada, the SAR limit for wrist watch used by the public is 1.6 watts/kg (W/kg) averaged over one gram of tissue or 4.0 watts/kg (W/kg) averaged over ten gram of tissue. Tests for SAR are conducted using standard operating positions specified by the FCC with the product transmitting at its highest certified power level in all tested frequency bands.

Although SAR is determined at the highest certified power level, the actual SAR level of the product during operation can be well below the maximum value.

Because the product is designed to operate at multiple power levels and to use only the power required to reach the network, in general, the closer you are to a wireless base station antenna, the lower the power output.

The highest SAR value for this model product when tested for use at Next-to-Mouth(Face) is 0.32 W/kg(1g) and for body-worn(Wrist) is 0.29 W/kg(10g).

While there may be differences between SAR levels of various devices and at various positions, they all meet the government requirement for safe exposure.

The FCC has granted an Equipment Authorization for this model product with all reported SAR levels evaluated as in compliance with the FCC RF emission guidelines.

SAR information on this model product is on file with the FCC and can be found

under the Display Grant section of <http://fcc.gov/oet/ea/fccid> after searching on FCC ID ZNFW270.

Additional information on Specific Absorption Rates (SAR) can be found on the Cellular Telecommunications Industry Association (CTIA) website at <http://www.ctia.org/>.

* Product meets current FCC Radio Frequency Exposure Guidelines
FCC ID : ZNFW270

Part 15.19 statement General Requirement

This device complies with part 15 of FCC rules. Operation is subject to the following two conditions:

- (1) This device may not cause harmful interference.
- (2) This device must accept any interference received, including interference that may cause undesired operation.

Part 15.21 statement

Change or Modifications that are not expressly approved by the manufacturer could void the user's authority to operate the equipment.

U.S. declarations of conformity (Part 15.105 statement)

This equipment has been tested and found to comply with the limits for a class B digital device, pursuant to Part 15 of the FCC rules. These limits are designed to provide reasonable protection against harmful interference in a residential installation. This equipment generates, uses, and can radiate radio frequency energy and, if not installed and used in accordance with the instructions, may cause harmful interference with radio communications.

However, there is no guarantee that interference will not occur in a particular installation. If this equipment does cause harmful interference or television reception, which can be determined by turning the equipment off and on, you can try to correct the interference by one or more of the following measures:

- Reorient or relocate the receiving antenna.
- Increase the separation between the equipment and receiver.
- Connect the equipment into an outlet on a circuit different from that to which the receiver is connected.
- Consult the dealer or an experienced radio/TV technician for help.

Laser safety statement

CDRH Compliance

THIS PRODUCT COMPLIES WITH APPLICABLE REQUIREMENT OF THE DHHS PERFORMANCE STANDARD FOR LASER PRODUCT, 21 CFR SUBCHAPTER J.

Caution!

This product employs a Laser system. To ensure proper use of this product, please read this owner's manual carefully and retain for future reference. Should the unit require maintenance, contact an authorized service center.

Use of controls, adjustments, or the performance of procedures other than those specified herein may result in hazardous radiation exposure.

To prevent direct exposure to laser beam, do not try to open the enclosure or to make the direct contact with the laser.

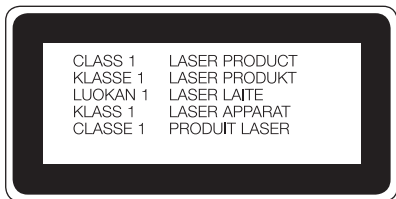

Limited Warranty Statement

ARBITRATION NOTICE: THIS LIMITED WARRANTY CONTAINS AN ARBITRATION PROVISION THAT REQUIRES YOU AND LG TO RESOLVE DISPUTES BY BINDING ARBITRATION INSTEAD OF IN COURT, UNLESS YOU CHOOSE TO OPT OUT. IN ARBITRATION, CLASS ACTIONS AND JURY TRIALS ARE NOT PERMITTED. PLEASE SEE THE SECTION TITLED "PROCEDURE FOR RESOLVING DISPUTES" BELOW.

WARRANTY LAWS

The following laws govern warranties that arise in retail sales of consumer goods:

- The California Song-Beverly Consumer Warranty Act [CC §§1790 et seq],
- The California Uniform Commercial Code, Division Two [Com C §§2101 et seq], and
- The federal Magnuson-Moss Warranty Federal Trade Commission Improvement Act [15 USC §§2301 et seq; 16 CFR Parts 701– 703]. A typical Magnuson-Moss Act warranty is a written promise that the product is free of defects or a written promise to refund, repair, or replace defective goods. [See 15 USC §2301(6).] Remedies include damages for failing to honor a written warranty or service contract or for violating disclosure provisions. [See 15 USC §2310(d).] Except for some labeling and disclosure requirements, the federal Act does not preempt state law. [See 15 USC §2311.]

1. WHAT THIS WARRANTY COVERS:

LG offers you a limited warranty that the enclosed subscriber unit and its enclosed accessories will be free from defects in material and workmanship, according to the following terms and conditions:

- 1 The limited warranty for the product extends for TWELVE (12) MONTHS beginning on the date of purchase of the product with valid proof of purchase.
- 2 The limited warranty extends only to the original purchaser of the product and is not assignable or transferable to any subsequent purchaser/end user.
- 3 This warranty is good only to the original purchaser of the product during the warranty period as long as it is in the U.S., including Alaska, Hawaii, U.S. Territories and Canada.
- 4 The external housing and cosmetic parts shall be free of defects at the time of shipment and, therefore, shall not be covered under these limited warranty terms.

- 5 Upon request from LG, the consumer must provide information to reasonably prove the date of purchase.
- 6 The customer shall bear the cost of shipping the product to the Customer Service Department of LG. LG shall bear the cost of shipping the product back to the consumer after the completion of service under this limited warranty.

2. WHAT THIS WARRANTY DOES NOT COVER:

- 1 Defects or damages resulting from use of the product in other than its normal and customary manner.
- 2 Defects or damages from abnormal use, abnormal conditions, improper storage, exposure of the internal components to moisture or dampness, unauthorized modifications, unauthorized connections, unauthorized repair, misuse, neglect, abuse, accident, alteration, improper installation, or other acts which are not the fault of LG, including damage caused by shipping, blown fuses, spills of food or liquid or physical abuse of the device.
- 3 Breakage or damage to antennas unless caused directly by defects in material or workmanship.
- 4 That the Customer Service Department at LG was not notified by consumer of the alleged defect or malfunction of the product during the applicable limited warranty period.
- 5 Products which have had the serial number removed or made illegible.
- 6 This limited warranty is in lieu of all other warranties, express or implied either in fact or by operations of law, statutory or otherwise, including, but not limited to any implied warranty of marketability or fitness for a particular use.
- 7 Damage resulting from the use of any third party accessories with your device.
- 8 All plastic surfaces and all other externally exposed parts that are scratched or damaged due to normal customer use.
- 9 Products operated outside published maximum ratings.
- 10 Products used or obtained in a rental program.
- 11 Consumables (such as fuses).

3. WHAT LG WILL DO:

LG will, at its sole option, either repair, replace or refund the purchase price of any unit that does not conform to this limited warranty. LG may choose at its option to use functionally equivalent re-conditioned, refurbished or new units or parts or any units. In addition, LG will not re-install or back-up any data, applications or software that you have added to your phone. It is therefore recommended that you back-up any such data or information prior to sending the unit to LG to avoid the permanent loss of such information.

4. STATE LAW RIGHTS:

No other express warranty is applicable to this product. THE DURATION OF ANY IMPLIED WARRANTIES, INCLUDING THE IMPLIED WARRANTY OF MARKETABILITY OR MERCHANTABILITY OR FITNESS FOR A PARTICULAR PURPOSE, IS LIMITED TO THE DURATION OF THE EXPRESS WARRANTY HEREIN. LG SHALL NOT BE LIABLE FOR THE LOSS OF THE USE OF THE PRODUCT, INCONVENIENCE, LOSS OR ANY OTHER DAMAGES, DIRECT OR CONSEQUENTIAL, ARISING OUT OF THE USE OF, OR INABILITY TO USE, THIS PRODUCT OR FOR ANY BREACH OF ANY EXPRESS OR IMPLIED WARRANTY, INCLUDING THE IMPLIED WARRANTY OF MARKETABILITY OR MERCHANTABILITY OR FITNESS FOR A PARTICULAR PURPOSE APPLICABLE TO THIS PRODUCT.

Some states do not allow the exclusive limitation of incidental or consequential damages or limitations on how long an implied warranty lasts; so these limitations or exclusions may not apply to you. This warranty gives you specific legal rights and you may also have other rights which vary from state to state.

5. HOW TO GET WARRANTY SERVICE:

If you experience any problems with either the Bluetooth headset or the mobile handset, in each case as may be covered by this limited warranty, you need only return the affected device. For example, if a problem exists with the Bluetooth headset, please DO NOT return your mobile handset with the headset. Likewise, if a problem exists with the mobile handset, please DO NOT return the Bluetooth Headset with the handset.

To obtain warranty service, please call or fax to the following telephone numbers from anywhere in the continental United States:

Tel. 1-800-793-8896 or Fax. 1-800-448-4026

Or visit <http://www.lg.com/us/support> Correspondence may also be mailed to:
LG Electronics Service- Mobile Handsets, P.O. Box 240007, Huntsville, AL 35824

DO NOT RETURN YOUR PRODUCT TO THE ABOVE ADDRESS.

Please call or write for the location of the LG authorized service center nearest you and for the procedures for obtaining warranty claims.

PROCEDURE FOR RESOLVING DISPUTES:

ALL DISPUTES BETWEEN YOU AND LG ARISING OUT OF OR RELATING IN ANY WAY TO THIS LIMITED WARRANTY OR THE PRODUCT SHALL BE RESOLVED EXCLUSIVELY THROUGH BINDING ARBITRATION, AND NOT IN A COURT OF GENERAL JURISDICTION. BINDING ARBITRATION MEANS THAT YOU AND LG ARE EACH WAIVING THE RIGHT TO A JURY TRIAL AND TO BRING OR PARTICIPATE IN A CLASS ACTION.

Definitions. For the purposes of this section, references to “LG” mean LG Electronics MobileComm U.S.A., Inc, its parents, subsidiaries and affiliates, and each of their officers, directors, employees, agents, beneficiaries, predecessors in interest, successors, assigns and suppliers; references to “dispute” or “claim” shall include any dispute, claim or controversy of any kind whatsoever (whether based in contract, tort, statute, regulation, ordinance, fraud, misrepresentation or any other legal or equitable theory) arising out of or relating in any way to the sale, condition or performance of the product or this Limited Warranty.

Agreement to Binding Arbitration and Class Action Waiver. You and LG agree to resolve any claims between us only by binding arbitration on an individual basis, unless you opt out as provided below. Any dispute between you and LG shall not be combined or consolidated with a dispute involving any other person’s or entity’s product or claim. More specifically, without limitation of the foregoing, any dispute between you and LG shall not under any circumstances proceed as part of a class or representative action. Instead of arbitration, either party may bring an individual action in small claims court, but that small claims court action may not be brought on a class or representative basis.

Arbitration Rules and Procedures. To begin arbitration of a claim, either you or LG must make a written demand for arbitration. The arbitration will be administered by the American Arbitration Association (AAA) and will be conducted before a single arbitrator under the AAA’s Consumer Arbitration Rules that are in effect at the time the arbitration is initiated (referred to as the “AAA Rules”) and under the procedures set forth in this section. The AAA Rules are available online at www.adr.org/consumer. Send a copy of your written demand for arbitration, as well as a copy of this provision, to the AAA in the manner described in the AAA Rules. You must also send a copy of your written demand to LG at LG Electronics, USA, Inc. Attn: Legal Department-Arbitration 1000 Sylvan Avenue Englewood Cliffs, NJ 07632. If there is a conflict between the AAA Rules and the rules set forth in this section, the rules set forth in this section will govern. This arbitration provision is governed by the Federal Arbitration Act. Judgment may be entered on

the arbitrator's award in any court of competent jurisdiction. All issues are for the arbitrator to decide, except that issues relating to the scope and enforceability of the arbitration provision and to the arbitrability of the dispute are for the court to decide. The arbitrator is bound by the terms of this provision.

Governing Law: The law of the state of your residence shall govern this Limited Warranty and any disputes between us except to the extent that such law is preempted by or inconsistent with applicable federal law. Fees/Costs: You do not need to pay any fee to begin an arbitration. Upon receipt of your written demand for arbitration, LG will promptly pay all arbitration filing fees to the AAA unless you seek more than \$25,000 in damages, in which case the payment of these fees will be governed by the AAA Rules. Except as otherwise provided for herein, LG will pay all AAA filing, administration and arbitrator fees for any arbitration initiated in accordance with the AAA Rules and this arbitration provision. If you prevail in the arbitration, LG will pay your reasonable attorneys' fees and expenses to the extent required by applicable law. If the arbitrator finds either the substance of your claim or the relief sought in the demand is frivolous or brought for an improper purpose (as measured by the standards set forth in Federal Rule of Civil Procedure 11(b)), then the payment of all arbitration fees will be governed by the AAA Rules. In such a situation, you agree to reimburse LG for all monies previously disbursed by it that are otherwise your obligation to pay under the AAA Rules. Except as otherwise provided for, LG waives any rights it may have to seek attorneys' fees and expenses from you if LG prevails in the arbitration.

Hearings and Location: If your claim is for \$25,000 or less, you may choose to have the arbitration conducted solely on the basis of (1) documents submitted to the arbitrator, (2) through a telephonic hearing, or (3) by an in-person hearing as established by the AAA Rules. If your claim exceeds \$25,000, the right to a hearing will be determined by the AAA Rules. Any in-person arbitration hearings will be held at a location within the federal judicial district in which you reside unless we both agree to another location or we agree to a telephonic arbitration.

Opt Out: You may opt out of this dispute resolution procedure. If you opt out, neither you nor LG can require the other to participate in an arbitration proceeding. To opt out, you must send notice to LG no later than 30 calendar days from the date of the first consumer purchaser's purchase of the product by either: (i) sending an e-mail to optout@lge.com, with the subject line: "Arbitration Opt Out" or (ii) calling 1-800-980-2973. You must include in the opt out e-mail or provide by telephone: (a) your name and address; (b) the date on which the product was purchased; (c) the product model name or model number, and (d) the IMEI or MEID or Serial Number, as applicable (the IMEI or MEID or Serial Number

can be found (i) on the product box; (ii) on a label on the back of the product beneath the battery, if the battery is removable; or (iii) from the settings menu via the following path: **Settings > System > About**). You may only opt out of the dispute resolution procedure in the manner described above (that is, by e-mail or telephone); no other form of notice will be effective to opt out of this dispute resolution procedure. Opting out of this dispute resolution procedure will not affect the coverage of the Limited Warranty in any way, and you will continue to enjoy the full benefits of the Limited Warranty. If you keep this product and do not opt out, then you accept all terms and conditions of the arbitration provision described above.

