

## Streaming 2.4GHz DX-4 HD VIDEO DRONE

## GETTING TO KNOW YOUR DRONE

PLEASE READ ALL WARNINGS AND INSTRUCTIONS PRIOR TO USE. KEEP THIS DOCUMENT AS IT CONTAINS IMPORTANT INFORMATION ABOUT YOUR DRONE.



## 1. CHARGING

- Drone must be charged before each use (USB Charge Cable included)
- Indicator light will turn off once fully charged
- Install batteries in remote

## 2. PAIRING

Before each flight pair the remote with the drone:

1. Turn your drone on and place on a flat, level surface
2. Turn on the remote on and move the left joystick up, then down
3. The beep will indicate successful pairing
4. Repeat steps 1 and 2 if necessary

## 3. DIRECTIONAL LIGHTS

- White lights indicate the front of the drone
- Red lights indicate the back of the drone
- Not applicable in auto-orientation mode

## 4. REMOTE CONTROL OVERVIEW

Practice flying your drone below 10 feet and at low speeds until comfortable with all controls to avoid unnecessary damage or injury

- **Left joystick:**
    - Up/Down controls elevation
    - Left/Right controls spin
  - **Right joystick:** controls flight direction
  - **Direction Trim:** use to eliminate drift
- To cut power to drone, move left joystick to down position

QUESTIONS OR CONCERNS?  
PLEASE GIVE US A CALL ... WE'RE HERE TO HELP

WARNING: ONLY USE PROVIDED USB  
CABLE FOR CHARGING

## CUSTOMER SERVICE

(800) 374-2744

Before calling please locate the 10-digit  
code printed on the back of your remote



CHOKING HAZARD –  
SMALL PARTS NOT FOR CHILDREN UNDER 3 YEARS.  
ADULT ASSEMBLY REQUIRED.

## Streaming 2.4GHz DX-4 HD VIDEO DRONE

## INTRODUCTION

Congratulations on your purchase of the Sharper Image Streaming 2.4 GHz DX-4 HD Video Drone. Get ready to soar to new heights. Master the art of drone flying and stunts with remote control maneuverability. This lightweight stunt drone will provide hours of fun.

## SPECIFICATIONS

Drone Battery: 800 mAh Li-po  
Remote Controller Battery: 6 x 1.5V AA  
Charging Time: Approximately 120 minutes  
Maximum Recommended Altitude 150 ft.

## TABLE OF CONTENTS

General Warnings	Page 1
Contents and Remote Battery Installation	Page 2
Charging Battery and Replacing Propellers	Page 3
Remote Overview	Page 4
Operating Drone	Page 5
Modes	Page 6
Tips and FCC Warning	Page 7

## Streaming 2.4GHz DX-4 HD VIDEO DRONE

## READ ALL WARNINGS AND PRECAUTIONS BEFORE USE.

## SAFETY WARNINGS:

- Not recommended for children under 14 years of age. As with all electrical products, precaution should be observed during handling and use to reduce the risk of electrical shock.
- Adult supervision is required at all times.
- Before each use, an adult should review the product and battery to determine that no damage or hazards exist.
- **DO NOT TOUCH SPINNING PROPELLERS.**
- Do not allow anything to intentionally make contact in any way with spinning propellers.
  - Prevent contact with spinning blades by turning off remote prior to handling drone.
- **Use caution and pay attention to your surroundings while operating drone.**
- **Do not fly drone into animals, people, or inanimate objects.**
- Keep drone away from power lines, buildings, trees, public areas, and any other potentially hazardous areas.
- Do not operate in rain, heavy wind, and or any type of severe weather.
- Do not land drone on wet surfaces.
- Never touch or allow others to touch drone while it is flying.
- Always turn drone off when it is not in use.
- Always fly drone in large open areas.
- Never fly drones above or near people, sudden changes in wind or other conditions could lead to unexpected crashes.
- Always use caution when flying drone vehicles, obey relevant laws, respect the privacy and property rights of others.
- The drone shall never be modified or used for anything except its intended purpose.



PLEASE RECYCLE OR  
DISPOSE OF ELECTRONICS  
PROPERLY RECYCLING  
INFORMATION IS AVAILABLE AT  
WWW.MERCHSOURCE.COM

## Invasion of Privacy Warning

Always be mindful of others privacy and do not record video or take images of others without their consent. Check and comply with your federal, state and local laws regarding privacy.

## Streaming 2.4GHz DX-4 HD VIDEO DRONE

## CONTENTS

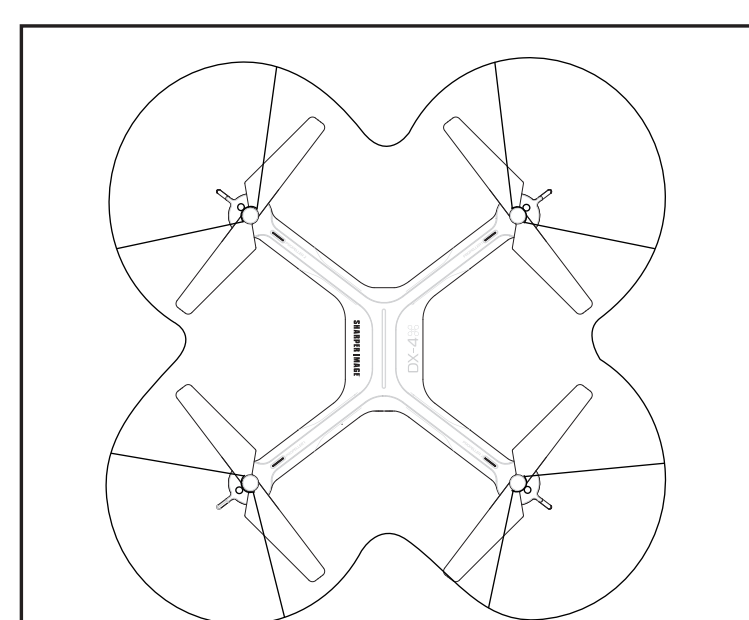

DX-4 HD Video Drone

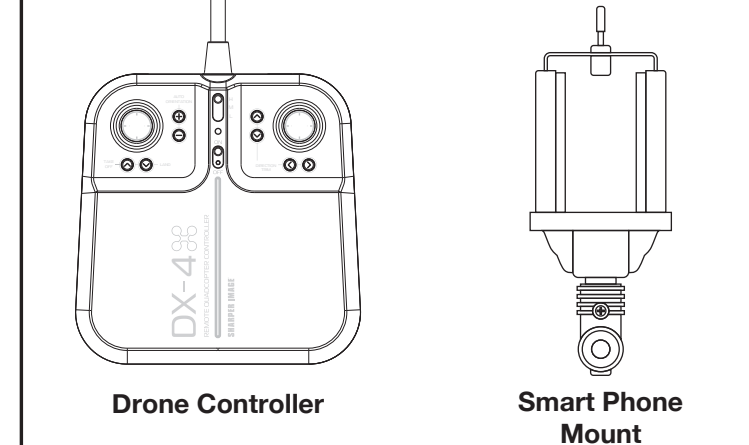

Drone Controller

Smart Phone Mount

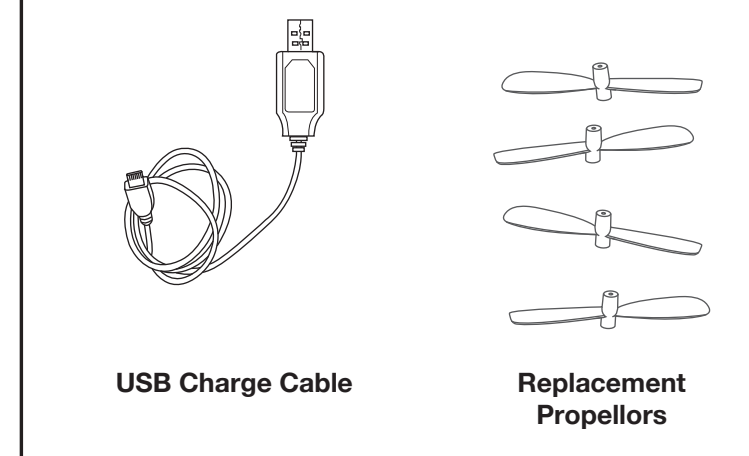

USB Charge Cable

Replacement Propellers

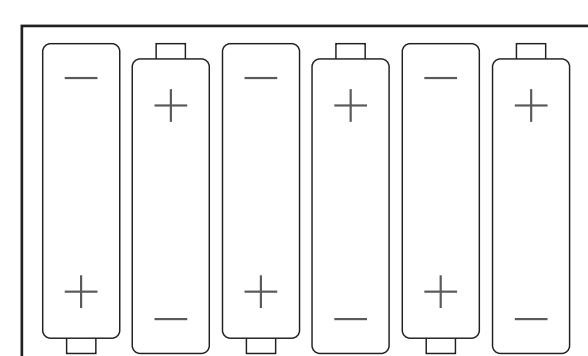

## REMOTE BATTERY INFORMATION

1. Slide open battery compartment
2. Install 6 "AA" batteries as shown in diagram shown above
3. Replace and close battery compartment

## LITHIUM-POLYMER BATTERY WARNING

There is a risk of fire and personal injury if Li-Po battery is punctured, damaged or misused.

- Never expose battery to extreme temperatures or moisture.
- Do not subject battery to strong impacts.
- Always keep battery away from flammable materials.
- Only use manufacturer specified battery(ies), charger(s), and/or adapters, if applicable, specified by the manufacturer.
- Battery is not serviceable.
- Let battery cool to room temperature before charging.
- While charging, never leave battery unattended.
- Recycle or dispose of battery according to federal, state and local laws.
- The battery is not replaceable.

KEEP THIS INSTRUCTION MANUAL FOR REFERENCE

## BATTERY WARNING

- Do not mix old and new batteries
- Do not mix alkaline, standard (carbon-zinc), or rechargeable batteries
- Insert batteries using the correct polarity. Do not short-circuit the battery terminal
- Only use manufacturer specified battery(ies), charger(s), and/or adapters, if applicable, specified by the manufacturer
- Always use, replace, and recharge (if applicable) batteries under adult supervision

KEEP THE PACKAGE FOR REFERENCE AS IT CONTAINS IMPORTANT INFORMATION

## Streaming 2.4GHz DX-4 HD VIDEO DRONE

## CHARGING BATTERY

Note: The Battery Charge Cable will light up when it is charging the battery and turn off when the battery is fully charged. Charge time is approximately 120 minutes.

Turn off the drone before charging.

Connect the Battery Charge Cable to the Micro USB port on the Drone.

Connect USB connector to power source.

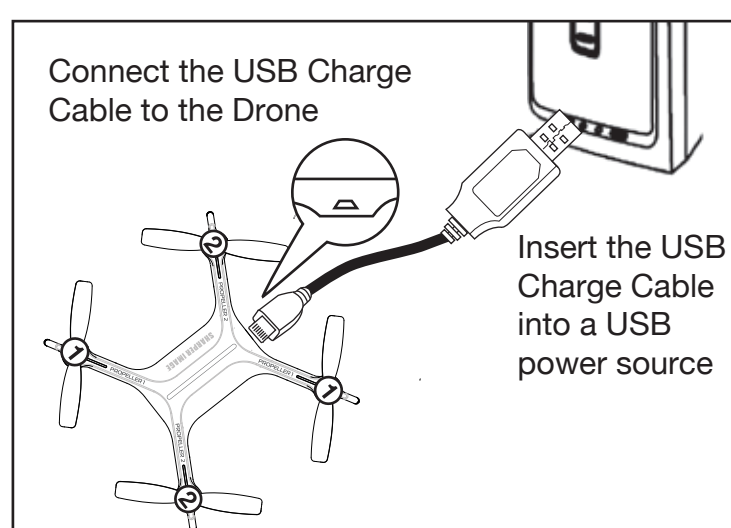

Connect the USB Charge Cable to the Drone

Insert the USB Charge Cable into a USB power source

## Replacing Propellers

1. Follow diagram
2. Remove screw from top of Propeller
3. Remove broken Propeller and replace with new Propeller
4. Make sure you installed the correct blade. Each blade has a number written on it. Match the blades with the corresponding number on the drone
5. Insert screw into top of Propeller

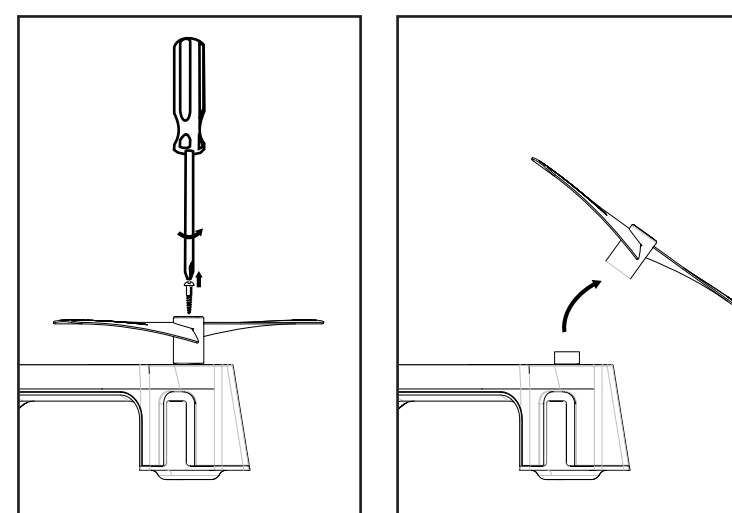

## DRONE APP

Go to your app store on your smart phone and download the "360 Flight" application.



**Pairing Drone - First Time**  
1. Press the connect to Wi-Fi button  
2. Follow the on screen instructions

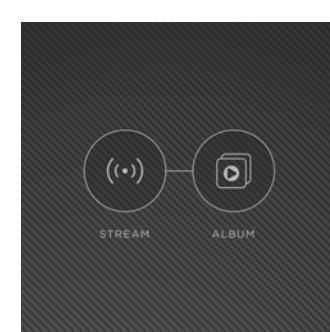

**After Connecting Drone**  
1. Press the Stream Button to begin streaming  
2. Press the Album Button to review pictures and videos

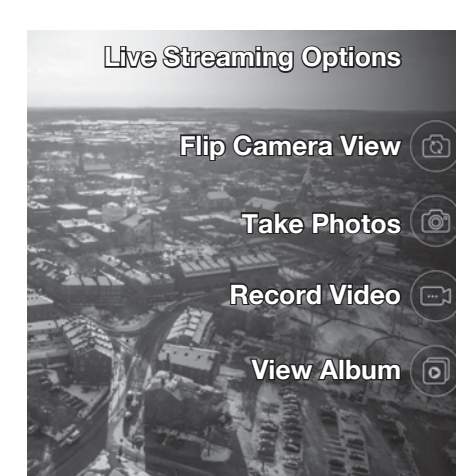

## Streaming 2.4GHz DX-4 HD VIDEO DRONE

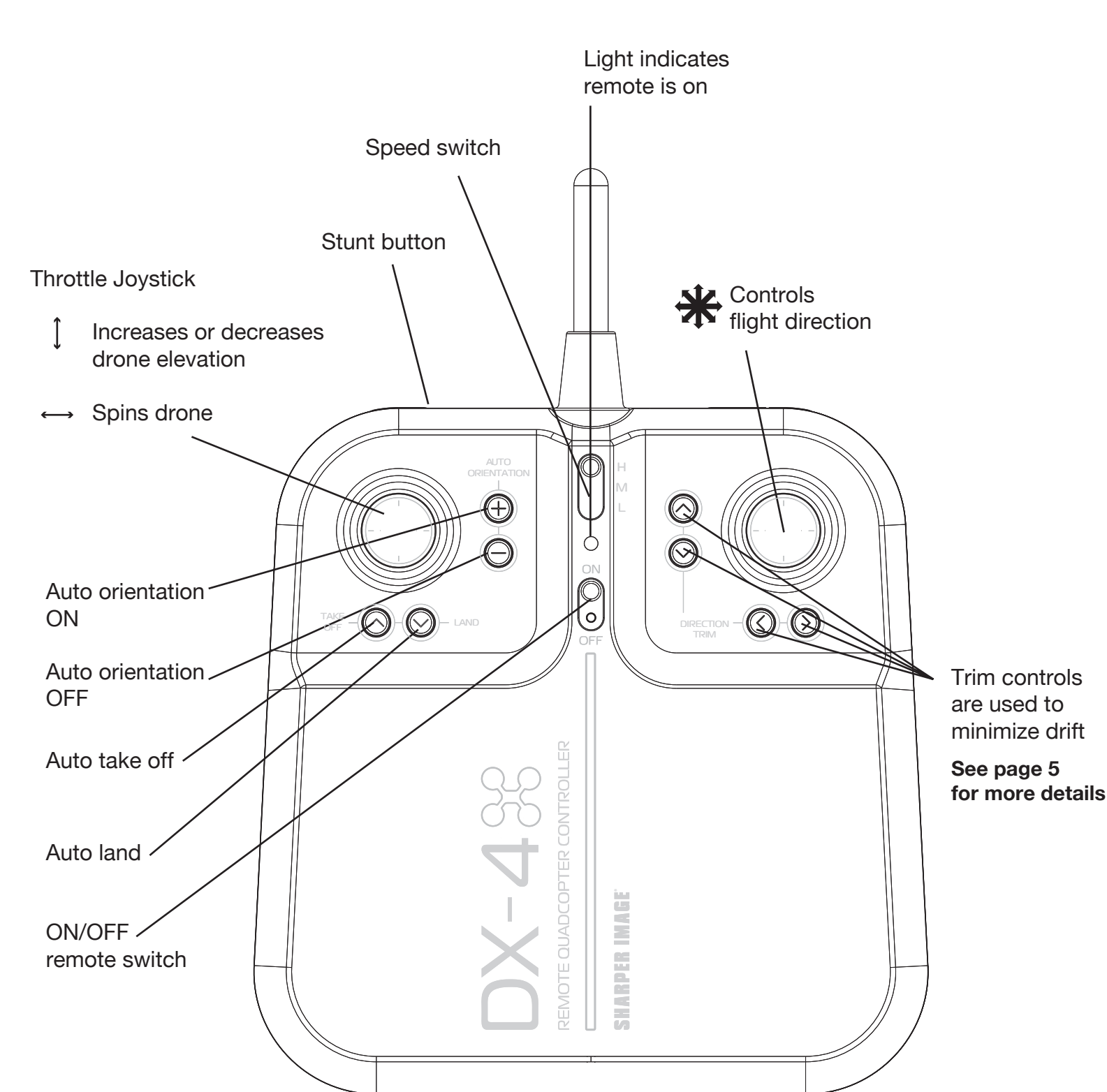

## Streaming 2.4GHz DX-4 HD VIDEO DRONE

## INSTALLING PHONE HOLDER

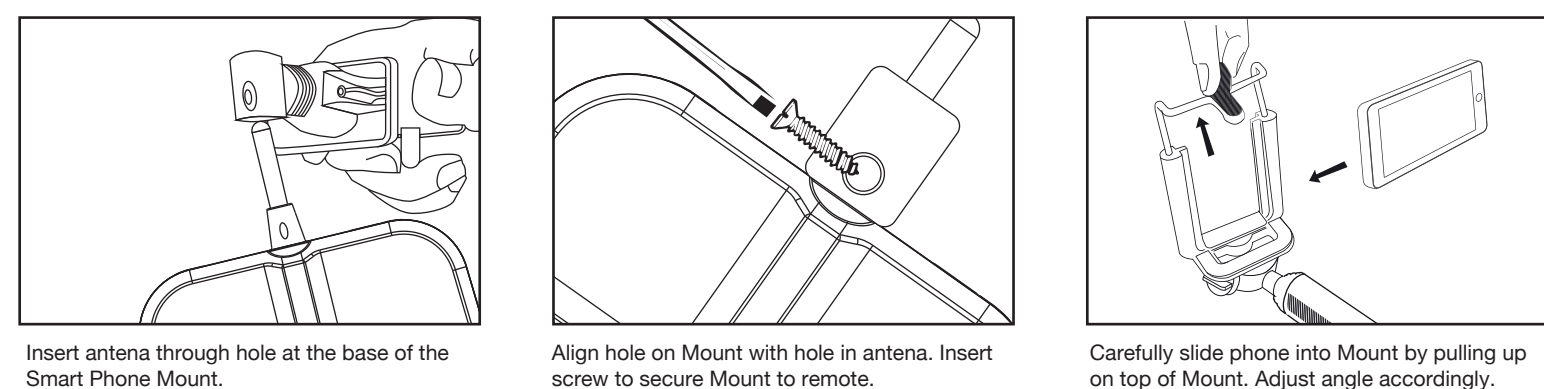

## OPERATING DRONE

## Step 1 - Pre Flight Checklist

1. Read all warnings and instructions.
2. Install remote batteries, page 2.
3. Make sure that drone and remote are powered off.
4. Install drone holder.
5. Charge batteries, page 3.

## Step 2 - Choosing a location

- Drone is designed to be flown indoors and outdoors.
- Always make sure you have enough space to fly drone.
- Always follow warnings, page 1.

## Step 3 - Starting Drone

1. Making sure your remote is off, slide drone switch to ON. Drone lights will begin to flicker.
2. Place drone on a flat even surface with clearance according to diagram (Fig. 1).
3. Turn remote on. Make sure the left stick (throttle) is in a neutral position (stick is centered).
4. Push the stick up and then down.
5. A single tone indicates that the drone is paired. Drone lights will flicker rapidly then turn on permanently once paired.
6. If pairing is unsuccessful, repeat steps 3-4.

## Step 4 - Lift Off

1. Slowly and carefully press the Throttle Joystick up. Drone will begin to elevate. You can compensate for some of the drones drifting by using the Multi Directional Button or by following Step 5. You may need to practice this step several times before successfully getting drone into the air.
2. You can let go of the throttle once you get to your desired elevation. The drone will engage its auto hover function.

## Step 5 - Drone Begins to Drift

Follow this step if your drone begins to drift while take off or during flight.

- Drone drifts backwards: Press the forward Direction Trim Button.
- Drone drifts forwards: Press the Backwards Direction Trim Button.
- Drone drifts left: Press the Right Direction Trim Button.
- Drone drifts right: Press the Left Direction Trim Button.

## Step 6 - Operating Drone in Flight

The drone range is approximately 400 feet or 150 feet of altitude:

- Read and be aware of all warnings found on Page 1.
- Maintain your desired elevation by using the Throttle.
- Push the Throttle joystick to right or left to spin the drone.
- Use the right joystick to move forward backwards, and side to side.
- Review step 5 if your drone begins to drift.
- Drone will begin to blink when drone is paired to remote and battery is low.

## Step 7 - Landing Drone

There are two ways to land the drone:

1. Press the Auto Land Button. The drone will slowly begin to land. If the drone begins to drift, you can still control the drone's direction using the Multi Directional Button.
2. Slowly and carefully press the Throttle Joystick down until drone lands. If the drone begins to drift, you can still control the drone's direction using the Multi Directional Button.

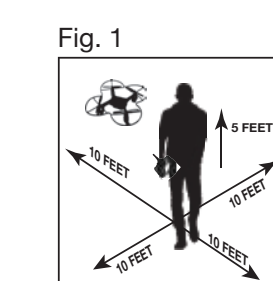

Always turn off remote prior to retrieving or picking up drone. This will help you avoid accidentally activating propellers.

## Streaming 2.4GHz DX-4 HD VIDEO DRONE

## MODES

## Stunt Button

Once you are comfortable flying the drone, use the Stunt Button to perform acrobatic stunts.

1. Hover the drone to at least above 10 feet.
2. Press the Stunt Button. You will hear beeping coming from the remote.
3. Move the Multi Directional Button to the desired direction that you would like the drone to fly.

## Auto Take Off Button

Once you are comfortable flying the drone, use the Auto Take Off Button for an easy take off.

1. Turn remote ON.
2. Pair remote to drone: Bring the Throttle all the way up then bring it all the way down, remote will beep once paired.
3. Press the Auto Take Off Button. Drone will begin to elevate. Drone will level out around 5 ft off the ground and automatically enter into auto hover.
4. Now the drone can be controlled using both the throttle and the multi-directional joystick.

## Auto Orientation Button

- Auto Orientation default setting is off. To enter this mode press Auto Orientation "+" button. Remote will beep twice.
- After drone is successfully paired, the 2 white LED lights toward orientation will be the original forward orientation, when drone is in auto orientation mode, the drone will orient to the user (remote), no matter what direction the drone is facing. Pushing the right stick up will send the drone away from the user, pushing it to the right will move the drone right, etc.
- Remote will beep every 6 seconds to indicate the drone is in Auto Orientation mode.
- To exit mode, press the "-" button. Remote will sound 1 long beep indicating that it has exited Auto Orientation mode.

NOTE: Auto Orientation mode is oriented to the user when pairing. If the remote is moved after pairing Auto Orientation, please follow directions above to reset Auto Orientation.

## Auto Landing Button

- Make sure you have achieved level, balanced flight, where the drone is neither climbing nor descending. This mode allows you to safely and slowly land your drone without having to control the speed. It is done for you automatically.
- The ideal auto landing height is 25-30 ft.
- Press the "v" button to trigger auto land. Remote will beep continuously until you exit the auto land mode.
- To steer the drone during landing, use the right control until drone has reached the ground.
- Press the "v" button again to exit auto landing mode.

NOTE: Please make sure the throttle joystick is in the down position before exiting auto landing mode

## Camera - taking pictures and creating videos

- Taking a picture- press camera icon on app once to take a picture.
- Creating video- press video icon on app once to take a video. Press the video icon on app again to stop recording.

## Streaming 2.4GHz DX-4 HD VIDEO DRONE

## CUSTOMER SERVICE

(800) 374-2744

## TIPS

- Do not crash drone into sand or dirt. Drone gears may become clogged.
- When first learning to fly, practice lifting off and hovering.
- Stay several feet from walls and buildings.
- Always press throttle all the way down after crashing or when something gets stuck in propellers.
- Never fly drones above or near people, sudden changes in wind or other conditions could lead to unexpected crashes.
- Always use caution when flying drone vehicles, obey relevant laws, respect the privacy and property rights of others.
- The drone shall never be modified or used for anything except its intended purpose.

WARNING: Changes or modifications to this unit not expressly approved by the party responsible for compliance could void the user's authority to operate the equipment.

## TROUBLESHOOTING:

When remote light is turned on, the remote light does not illuminate:

- 1) Check that batteries in the remote are installed correctly OR
- 2) Replace with new batteries.

During drone flight, the remote LED is flashing:

- 1) Remote batteries are low; replace them with new batteries.

Drone and remote properly pair, but the drone will not lift-off:

- 1) Drone battery needs charging. Use the USB Charge Cable to connect the drone to power source.

After trimming the drone, the drone flight is very unstable and cannot fly properly:

- 1) One or more blades are most likely damaged;
- 2) Turn off the drone and remote.
- 3) Replace with the proper number replacement blade and try flying again.

After impact, the drone is unstable:

- 1) Put the left remote control lever to the left bottom and put the right remote control lever to the right bottom at the same time which connected to the drone (diagram to right).
- 2) If the above does not resolve the issue, reboot the drone and controller and pair again.

If the drone blades will not stop spinning:

- 1) Put the left remote control lever to the right bottom and put the right remote control lever to the left bottom at the same time. Hold for 4 seconds (Fig. 2).

Remote Controller and Drone can not be paired:

- 1) Check Point: Remote Controller must be closed to Drone, not exceed 4 meters.

Note: If there are 2 sets of Drones within 4 meters for Pairing, you must pair one successfully before pairing the second set.

This device complies with Part 15 of the FCC Rules. Operation is subject to the following two conditions: (1) this device may not cause harmful interference, and (2) this device must accept any interference received, including interference that may cause undesired operation.

Note: This equipment has been tested and found to comply with the limits for a Class B digital device, pursuant to part 15 of the FCC Rules. These limits are designed to provide reasonable protection against harmful interference in a residential installation. This equipment generates, uses and can radiate radio frequency energy and, if not installed and used in accordance with the instructions, may cause harmful interference to radio communications.

However, there is no guarantee that interference will not occur in a particular installation. If this equipment does cause harmful interference to radio or television reception, which can be determined by turning the equipment off and on, the user is encouraged to try to correct the interference by one or more of the following measures:

- Reorient or relocate the receiving antenna.
- Increase the separation between the equipment and receiver.
- Connect the equipment into an outlet on a circuit different than that to which the receiver is connected.
- Consult the dealer or an experienced radio/TV technician for help.

FCC RF Radiation Exposure Statement Caution: To maintain compliance with the FCC's RF exposure guidelines, please do the drone at least 20cm from nearby persons.

©2017 Sharper Image. Sharper Image® name and logo are registered trademarks. All rights reserved. Distributed by MerchSource, LLC, Irvine, CA 92618. The artwork and design of this manual are protected by US copyright law and may not be reproduced, distributed, displaced, published or used for any purpose without prior written permission. Altering, removing or reproducing any of the trademark or copyright notices on this package is not permitted.

PATENT PENDING  
Printed in China